

JVC



ENGLISH

DVD/CD PLAYER

KV-DV7

ESPAÑOL

REPRODUCTOR DVD/CD

KV-DV7

FRANÇAIS

LECTEUR DVD/CD

KV-DV7



For installation and connections, refer to the separate manual.
Para la instalación y las conexiones, refiérase al manual separado.
Pour l'installation et les raccordements, se référer au manuel séparé.

INSTRUCTIONS

MANUAL DE INSTRUCCIONES
MANUEL D'INSTRUCTIONS

For customer Use:

Enter below the Model No. and Serial No. which are located on the top or bottom of the cabinet. Retain this information for future reference.

Model No. _____

Serial No. _____

LVT0590-001A
[J]

INFORMATION (For U.S.A.)

This equipment has been tested and found to comply with the limits for a Class B digital device, pursuant to Part 15 of the FCC Rules. These limits are designed to provide reasonable protection against harmful interference in a residential installation. This equipment generates, uses, and can radiate radio frequency energy and, if not installed and used in accordance with the instructions, may cause harmful interference to radio communications. However, there is no guarantee that interference will not occur in a particular installation. If this equipment does cause harmful interference to radio or television reception, which can be determined by turning the equipment off and on, the user is encouraged to try to correct the interference by one or more of the following measures:

- Reorient or relocate the receiving antenna.
- Increase the separation between the equipment and receiver.
- Connect the equipment into an outlet on a circuit different from that to which the receiver is connected.
- Consult the dealer or an experienced radio/TV technician for help.

IMPORTANT FOR LASER PRODUCTS

Precautions:

1. **CLASS 1 LASER PRODUCT**
2. **DANGER:** Invisible laser radiation when open and interlock failed or defeated. Avoid direct exposure to beam.
3. **CAUTION:** Do not open the top cover. There are no user-serviceable parts inside. Leave all servicing to qualified service personnel.
4. **CAUTION:** This DVD/CD player uses invisible laser radiation, however, is equipped with safety switches to prevent radiation emission when unloading discs. It is dangerous to defeat the safety switches.
5. **CAUTION:** Use of controls, adjustments or performance of procedures other than those specified herein may result in hazardous radiation exposure.

CAUTION: DO NOT insert a disc while the disc loading lamp is flashing or is not lit. (See page 6.)

WARNINGS

- **DO NOT install any unit in locations where;**
 - it may obstruct the steering wheel and gearshift lever operations, as this may result in a traffic accident.
 - it may obstruct the operation of safety devices such as air bags, as this may result in a fatal accident.
 - it may obstruct visibility.
- **DO NOT operate any unit while manipulating the steering wheel, as this may result in a traffic accident.**
- **The driver must not watch the monitor while driving.**
If the driver watches the monitor while driving, it may lead to carelessness and cause an accident.
- **DO NOT use the headphones while driving.** It is dangerous to shut off the outside sounds while driving.
- **If you need to operate the unit while driving, be sure to look ahead carefully or you may be involved in a traffic accident.**

How to reset your unit

Press the reset button on the front panel using a ball-point pen or a similar tool. This will reset the built-in microcomputer.

NOTE:

If you reset the unit during play, the playback mode selections (e.g. repeat play mode setting), you have selected for the current disc will be reset to the initial settings.

- During DVD playback, the disc menu selection will be also reset to the initial disc settings.

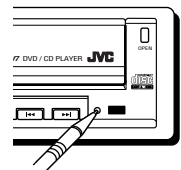

Thank you for purchasing a JVC product. Please read all instructions carefully before operation, to ensure your complete understanding and to obtain the best possible performance from the unit.

CONTENTS

How to reset your unit	2	SPECIAL EFFECTS PLAYBACK	18
INTRODUCTION	4	• Slow-Motion Playback	18
PREPARATION	5	• Frame-by-frame Playback	18
Installing the battery	5	• Zoom	19
BASIC PLAYBACK	6	DVD SETUP MENU	20
Starting playback	6	Setting initial audio language	20
• Listening with headphones	7	Setting initial subtitle language	21
Showing the on-screen bar	8	Setting initial disc menu language	22
• Checking the playing time	9	Setting digital audio output	22
DVD PLAYBACK	10	Setting compression	23
Selecting subtitles	10	Setting audio output during	
Selecting audio languages	11	Low Speed Search	24
Selecting multi-angle views	11	Setting monitor type	25
MENU-DRIVEN PLAYBACK	12	Setting closed caption	26
Menu operations	12	Changing the color of the on-screen bar ..	26
• While playing a DVD	12	Setting zoom preference	27
• While playing a VCD	13	MAINTENANCE	29
SEARCH FUNCTIONS	14	Handling discs	29
Searching for a particular point	14	LANGUAGE CODES	30
• Forward Search	14	GLOSSARY	31
• Reverse Search	14	LOCATION OF THE BUTTONS	32
Locating a particular point directly	15	• Remote controller	32
REPEAT PLAYBACK	16	• Control panel	33
Playing repeatedly	16	TROUBLESHOOTING	34
• Repeat Play	16	SPECIFICATIONS	35
• A-B Repeat	17		

CAUTION on Volume Setting

Discs produce very little noise compared with other sources. If the volume level is adjusted for the tuner, for example, the speakers may be damaged by the sudden increase in the output level. Therefore, lower the volume before playing a disc and adjust it as required during playback.

BEFORE USE

*** For safety...**

- Do not raise the volume level too much, as this will block outside sounds, making driving dangerous.
- Stop the car before performing any complicated operations.

*** Temperature inside the car...**

If you have parked the car for a long time in hot or cold weather, wait until the temperature in the car becomes normal before operating the unit.



INTRODUCTION

ENGLISH

About this manual

This manual mainly explains operations using the buttons on the remote control. You can also use the buttons on the control panel for the same operations if they have the similar or same marks.

Discs you can play:

Disc Type	Mark (Logo)	Video Format	Region Code Number*
DVD Video		NTSC	1 ALL
Video CD	 Video CD	_____	_____
Audio CD		_____	_____

- On some discs, their actual operations may be different from what is explained in this manual.
- The following discs cannot be played back;
 - DVD-Audio, DVD-ROM, DVD-RAM, DVD-R, DVD-RW, CD-ROM, CD-R, CD-RW, CD-I (CD-I Ready), Photo CD, etc.
 Playing back these discs will generate noise and damage the speakers.

* **Note on Region Code**

DVD players and DVD Video discs have their own Region Code numbers. This unit only can play back DVD discs whose Region Code numbers include "1."

Examples:

Disc structure – DVD, Video CD (VCD) and Audio CD (CD)

A DVD disc consists of **Titles**, and each title may be divided into some **Chapters**. (See Example 1.) For example, if a DVD disc contains some movies, each movie may have its own title number, and it may be further divided into some chapters.

On the other hand, a VCD or CD consists of **Tracks**. (See Example 2.)

In general, each song has its own track number. (On some discs, each track may also be divided by **Indexes**.)

When playing back a VCD with Playback Control (PBC) function, you can select what to view using the menu shown on the monitor. (While operating a Video CD using the menu, some of the functions such as Repeat and Track Search may not work.)

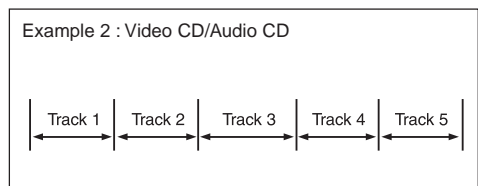
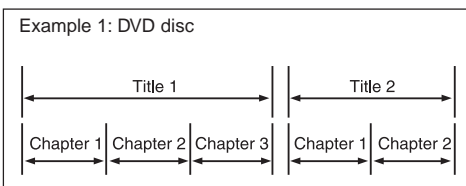



Before using the remote controller:

- Aim the remote controller directly at the remote sensor on the main unit. Make sure there is no obstacle in between.
- The remote signal reception lamp flashes when the unit receives a remote control signal from the remote controller.

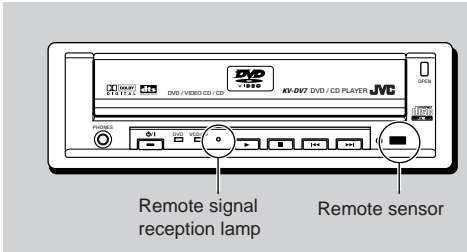

- Do not expose the remote sensor to strong light (direct sunlight or artificial lighting).

WARNING:

- Store the batteries in a place which children cannot reach.
If a child accidentally swallows the batteries, immediately consult a doctor.
- Do not recharge, short, disassemble or heat the batteries or dispose of in a fire.
Doing any of these things may cause the batteries to give off heat, crack or start a fire.
- Do not leave the batteries with other metallic materials.
Doing this may cause the batteries to give off heat, crack or start a fire.
- When throwing away or saving batteries, wrap in tape and insulate; otherwise, it may cause the batteries to give off heat, crack or start a fire.
- Do not poke the batteries with tweezers or similar tools.
Doing this may cause the batteries to give off heat, crack or start a fire.

Installing the battery

When the controllable range or effectiveness of the remote controller decreases, replace the battery.

1. Remove the battery holder.

- 1) Push out the battery holder in the direction indicated by the arrow using a ball-point pen or a similar tool.
- 2) Remove the battery holder.

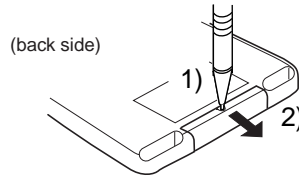

2. Place the battery.

Slide the battery into the holder with the + side facing upwards so that the battery is fixed in the holder.

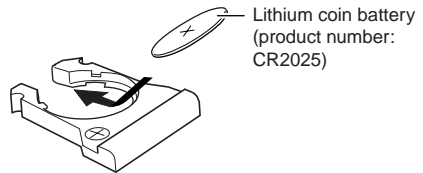

3. Return the battery holder.

Insert again the battery holder pushing it until you hear a clicking sound.

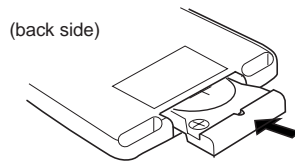



BASIC PLAYBACK

The following marks used in this manual indicate the discs to be used.



Starting playback



1 Press **POWER** to turn on the power.

POWER



The lamps on the buttons on the unit light up.

2 Press **OPEN** on the unit. The loading slot cover opens.

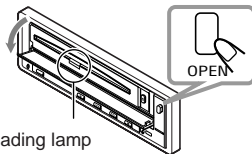

Disc loading lamp

DO NOT force the cover open by hand.

3 Insert a disc into the loading slot.

The unit draws in the disc automatically.

- When the power is off, you cannot insert a disc.

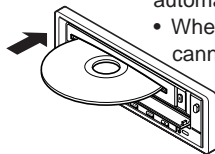

DO NOT insert a disc while the disc loading lamp is flashing* or is not lit**.

- * Flashing: while loading or ejecting a disc
- ** Not lit: when a disc has been loaded.

4 Close the slot cover by hand.

The disc type is automatically detected and the detected disc lamp (DVD, VCD/CD) lights up, and playback starts automatically.

- It takes a while to detect the disc type.

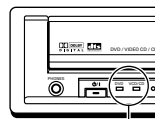
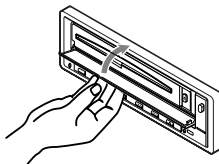

Disc lamps

If a menu appears while playing a DVD or VCD with PBC function, see "MENU-DRIVEN PLAYBACK" on page 12.

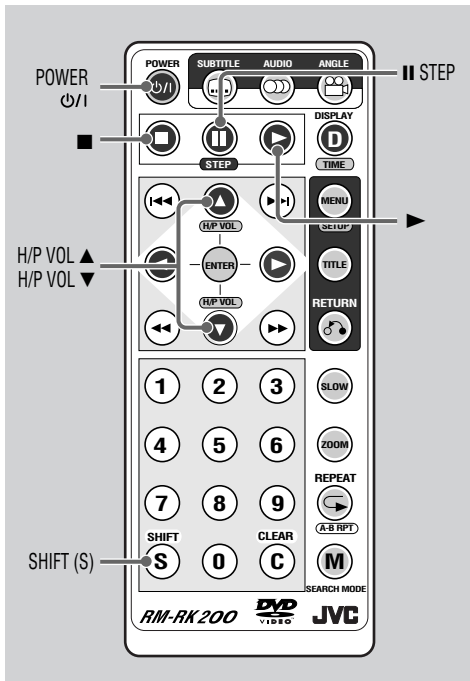

Before performing any operations, make sure the following....

- Check the connection with the TV and with the car receiver.
- Turn on the TV and the receiver.
- Select this unit (auxiliary or external input) as the playback source on the receiver.
- Select the correct input where this unit is connected.
- For DVD playback, you can change the Setup Menu setting to your preference. (See pages 20 – 28.)

If " " appears on the screen when pressing a button, the disc cannot accept an operation you have tried to do.



To stop playback temporarily

Press **II** (STEP). A still picture appears while playing a DVD or VCD.

- You can advance the still picture frame by frame by pressing the button repeatedly. (See page 18.)

To resume playback, press **▶**.

To stop playback

Press **■**.

If you are playing back a DVD or

VCD, this unit can memorize the end point ("■" appears for a while on the screen), and when you start playback again, playback begins from where it has been stopped. (Resume play)



To eject a disc

- 1 Press **OPEN** on the unit to open the slot cover.
- 2 Press **▲** on the unit (inside the slot cover). The disc automatically comes out of the loading slot.

To locate a particular chapter or track

You can move to another chapter or track while playing a disc.

- Press **▶▶** to go ahead to the beginning of the next track.
Each time you press the button consecutively, the beginning of the next tracks is located and played back.
- Press **◀◀** to go back to the beginning of the current track.
Each time you press the button consecutively, the beginning of the previous tracks is located and played back.

*If you press and hold the button, you can fast-forward (by holding **▶▶▶**) or fast-reverse the play (by holding **◀◀◀**).*

Listening with headphones

- 1 Connect the headphones to the PHONES jack on the unit.
- 2 While holding **SHIFT (S)**, then press **H/P VOL ▲** or **H/P VOL ▼** to adjust the headphones volume.

DO NOT use the headphones while driving. It is dangerous to shut off the outside sounds while driving.

About sounds reproduced through the rear terminals

• Through AUDIO (L/R):

Analog stereo signals are output.

When playing a source encoded with Dolby Digital* () , multichannel signals are mixed to the left and right front channel signals, then output.

– You cannot reproduce the sound encoded with DTS Digital Surround** (.

• Through DIGITAL OUT:

Digital signals (Linear PCM, Dolby Digital, DTS Digital Surround) are output through this terminal. (For more details, see page 35.)

To reproduce the multichannel sounds such as Dolby Digital and DTS Digital Surround, connect an amplifier or a decoder compatible with these multichannel sources to this terminal, and set "DIGITAL OUT" correctly. (See page 22.)

* Manufactured under license from Dolby Laboratories. "Dolby" and the double-D symbol are trademarks of Dolby Laboratories. Confidential unpublished works. © 1992–1997 Dolby Laboratories. All rights reserved.

** Manufactured under license from Digital Theater Systems, Inc. US Pat. No. 5,451,942, 5,956,674, 5,974,380, 5,978,762 and other world-wide patents issued and pending. "DTS" is a registered trademark of Digital Theater Systems, Inc. Copyright 1996, 2000 Digital Theater Systems, Inc. All Rights Reserved.

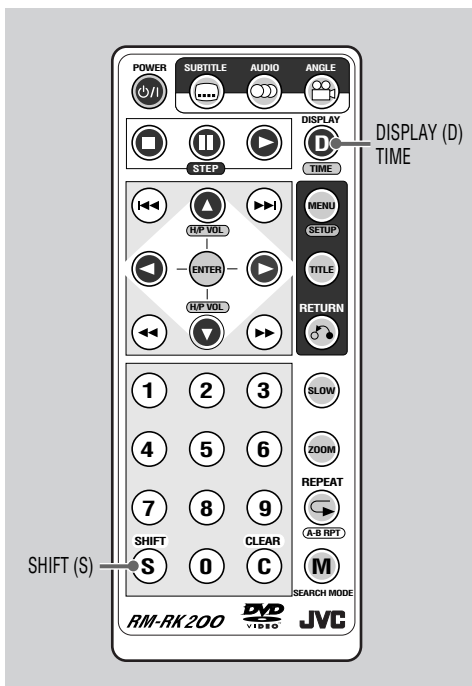

When a VCD or CD is loaded:

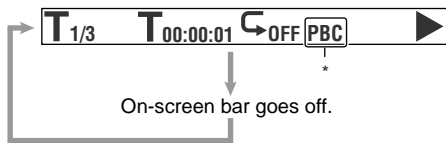

* This appears only while a VCD is loaded.

About the indications on the on-screen bar

Indications shown on the on-screen bar vary depending on the disc type and the signals recorded on the loaded disc.

When a DVD is loaded

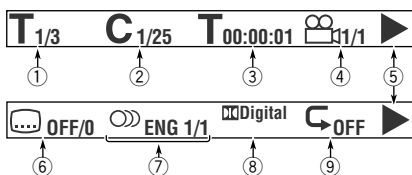

- ① : Current title and the total number of the titles on the disc.
(Ex.: 1st title is playing out of 3 titles recorded.)
- ② : Current chapter and the total number of the chapters recorded on the disc.
(Ex.: 1st chapter is playing out of 25 chapters recorded.)
- ③ : Playing time or the remaining time.
(Ex.: Playing time of the title. See page 9 for more details.)
- ④ : Indicates whether the disc contains multi-angle views.
(Ex.: When only main angle-view is recorded on the disc without any multi-angle views. See page 11 for more details.)
- ⑤ : Current operation mode.
(Ex.: This appears while playing a disc.)

Showing the on-screen bar



You can show the following information on the screen while a disc is loaded.

To show the disc information, press **DISPLAY (D)/TIME**.

DISPLAY



Each time you press the button, the following on-screen bar appears in sequence.

When a DVD is loaded:

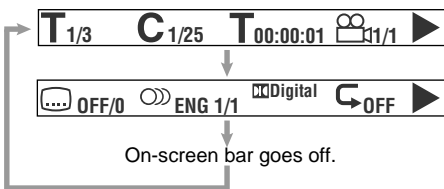



- ⑥ : Indicates whether the disc contains subtitles.
(Ex.: When no subtitle is recorded on the disc. See page 10 for more details.)
- ⑦ : Current selected audio language and the total number of the audio languages recorded on the disc.
(Ex.: "ENGLISH" is selected as the only recorded audio language on the disc. See page 11 for more details.)
- ⑧ : Sound mode — Linear PCM (stereo), Dolby Digital, and DTS Digital Surround.
(Ex.: When the disc is encoded with Dolby Digital.)
- ⑨ : Repeat play mode.
(Ex.: When Repeat play mode is set to "OFF." See page 16 for more details.)

When a VCD or CD is loaded

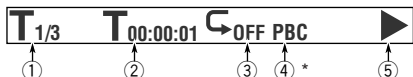

* This appears only while a VCD is loaded.

- ① : Current track and the total number of the tracks on the disc.
(Ex.: 1st track is playing out of 3 tracks recorded.)
- ② : Playing time or the remaining time.
(Ex.: Playing time of the track. See the right column for more details.)
- ③ : Repeat play mode.
(Ex.: When Repeat play mode is set to "OFF." See pages 16 and 17 for more details.)
- ④ : Appears only while loading a VCD. Indicates whether the VCD is recorded with the PBC function (PBC) or without (PBC).
(Ex.: When PBC function is recorded.)
- ⑤ : Current operation mode.
(Ex.: This appears while playing a disc.)

Checking the playing time

You can also show the elapsed playing time or the remaining time.

To show the on-screen bar and to change the playing time information, press **DISPLAY (D)/TIME** while holding **SHIFT (S)**.



Each time you press the button, the playing time information changes on the on-screen bar.

When a DVD is loaded

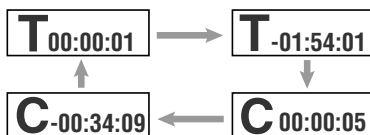

Elapsed playing time of the current **title** →
 Remaining time of the current **title** →
 Elapsed playing time of the current **chapter** →
 Remaining time of the current **chapter** →
 (Back to the beginning)

When a VCD or CD is loaded

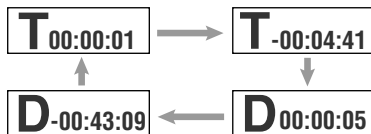



Elapsed playing time of the current **track** →
 Remaining time of the current **track** →
 Elapsed playing time of the current **disc** →
 Remaining time of the current **disc** →
 (Back to the beginning)

To erase the on-screen bar, press **DISPLAY (D)/TIME** twice while playing a DVD, or once while playing a VCD or CD.

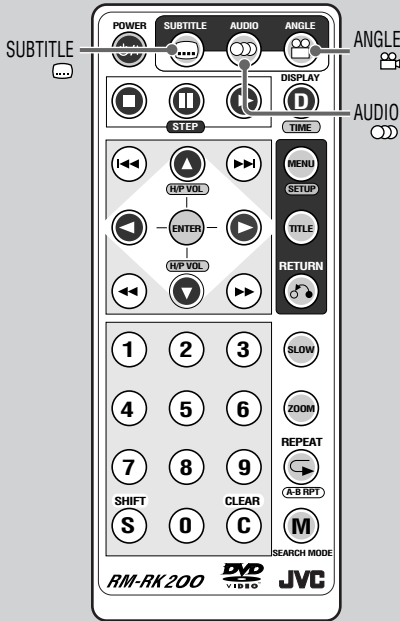
- It is not required to hold down **SHIFT (S)** to erase the on-screen bar.



Some DVDs contain several audio languages, subtitles, and multi-angle views. When you find the following marks on the DVD or its package, you can select these elements recorded on the DVD.

	<p>Subtitles are recorded on the disc. The number inside the mark indicates the total number of the recorded subtitles.</p>
	<p>Several audio languages are recorded on the disc. The number inside the mark indicates the total number of the recorded audio languages.</p>
	<p>Multi-angle views are recorded on the disc. The number inside the mark indicates the total number of the recorded multi-angle views.</p>

Selecting subtitles



While playing a disc containing subtitles in different languages, you can select the subtitle to be displayed on the screen.

- You can set your favorite subtitle language as the initial language shown on the screen. (See page 21.)

Select a desired subtitle language.



The on-screen menu bar appears on the screen. Each time you press the button, the subtitle language changes.

Ex.: When the disc has 3 selections — English, French, Spanish and no subtitle (OFF)

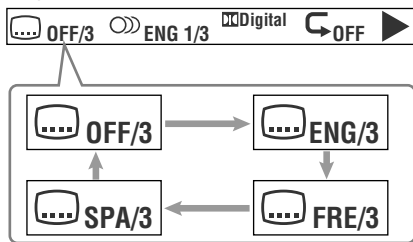

To erase the on-screen bar, press **DISPLAY (D)/TIME**.

Selecting audio languages



While playing a disc containing audio languages (sound tracks), you can select the language (sound) to listen to.

- You can set your favorite audio language as the initial audio language shown on the screen. (See page 20.)

Select a desired audio language (sound).



The on-screen menu bar appears on the screen. Each time you press the button, the audio language changes.

Ex.: When the disc has 3 selections — English, French, and Spanish

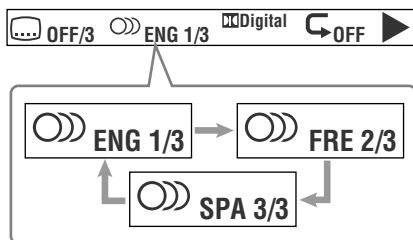

To erase the on-screen bar, press **DISPLAY (D)/TIME**.

Selecting multi-angle views



While playing a disc containing multi-angle views, you can view the same scene at different angles.

Select a desired view angle.

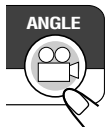

The on-screen menu bar appears on the screen. Each time you press the button, the view angle changes.

Ex.: When the disc has 3 multi-angle views

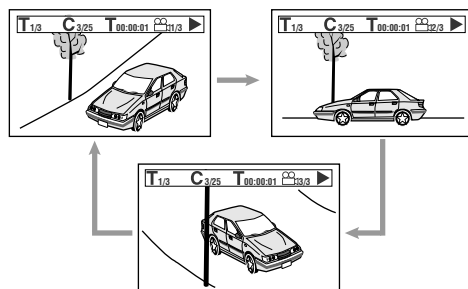
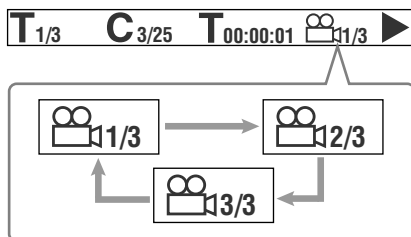

To erase the on-screen bar, press **DISPLAY (D)/TIME** twice.



MENU-DRIVEN PLAYBACK

Menu operations



Menu-driven playback is possible while playing back a DVD with menu-driven features or a VCD with the PBC function.

While playing a DVD:

DVD discs generally have their own menus or title lists. A Menu usually contains various information about the disc and playback selections. On the other hand, a title list usually contains titles of movies and songs recorded.

1 Press MENU/SETUP or TITLE.

A menu or title list will appear on the screen.

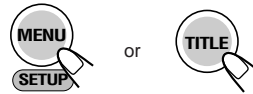

2 Select a desired item on the menu or on the title list, using Cursor buttons (▲/▼/▶/◀) and ENTER.

The unit starts playback of the selected item.

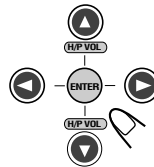

- On some discs, you can also select items by pressing the **Number** buttons corresponding to the item numbers listed.

To erase the menu or title list

Press **RETURN** until it goes off from the screen.

- If “” appears on the screen when pressing **MENU** in step 1, the disc does not have a menu.
- If “” appears on the screen when pressing **TITLE** in step 1, the disc does not have a title list.

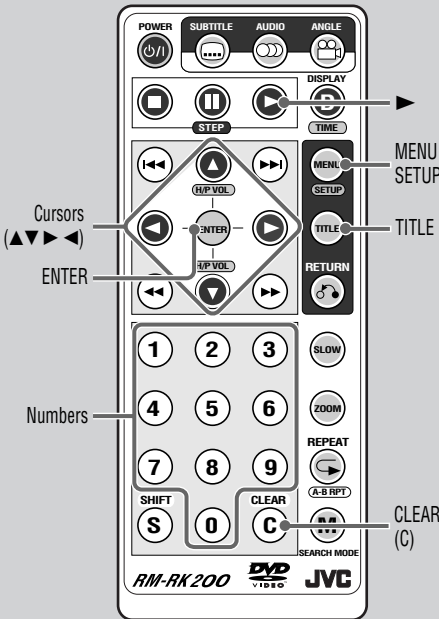



While playing a VCD:

The Playback Control function (PBC) allows you to operate the VCD using menus.

When you start playback, a menu will automatically appear on the screen.

- A menu may be a list of items, divided screens, or some moving pictures. (See “PBC operation concept” to the right.)

Select a desired item on the menu.

- When a list of items is displayed on the screen, press the **Number** buttons to select an item.
- When “▶” or “SELECT” is displayed on the screen, press ▶ (or **ENTER** if pressing ▶ does not work) to start playback.

How to select items using the Number buttons

- To select number 5, press **5**, then **ENTER**.
- To select number 10, press **1**, **0**, then **ENTER**.
- To select number 23, press **2**, **3**, then **ENTER**.

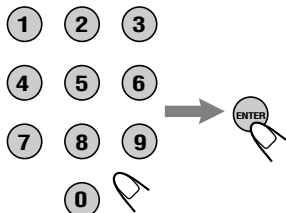

- To cancel a mis-entry, press **CLEAR (C)**. Each time you press the button, the last entry will be erased.

PBC operation concept

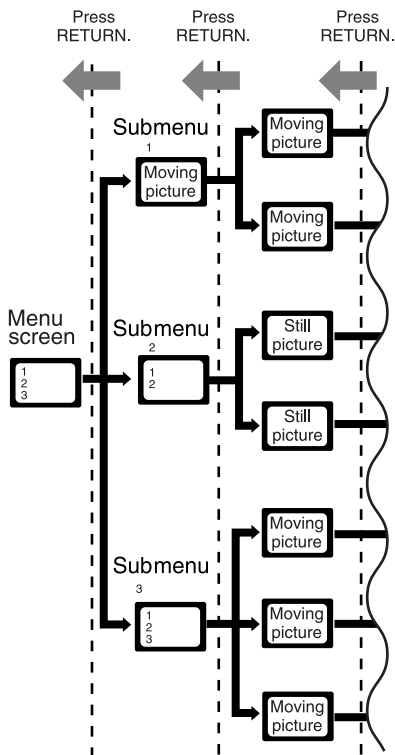

To return to the previous menu

Press **RETURN** ⏪.

To cancel the PBC playback

You can cancel the menu-driven operations (PBC function):

- 1 Press **■** to stop playback.
- 2 Press the **Number** buttons to select a track, then press **ENTER**.

Normal playback starts from the selected track.

- You can also turn on and off the PBC playback by pressing **MENU/SETUP** repeatedly.



SEARCH FUNCTIONS

Searching for a particular point



You can search for a particular portion while playing a disc — Forward/Reverse Search.

Forward Search

To fast-forward the chapter or track, press **▶▶** while playing a disc.



Each time you press the button, the search speed changes as follows:

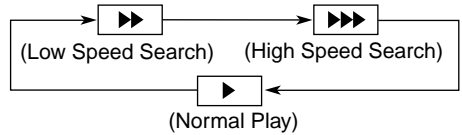

When playing a DVD or VCD

- No sound comes out during High Speed Search.
- When Low Speed Search sound setting is "ON," sounds come out during Low Speed Search. (See page 24.)

Reverse Search

To reverse the chapter or track, press **◀◀** while playing a disc.



Each time you press the button, the search speed changes as follows:

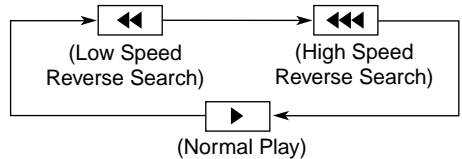

When playing a DVD or VCD

No sound comes out during Reverse Search.

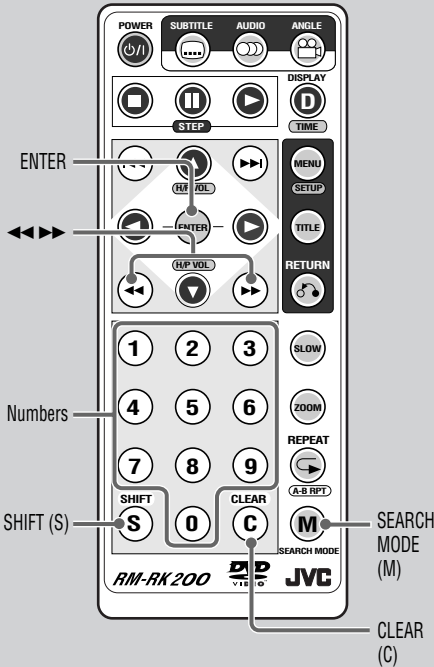



Locating a particular point directly



You can use the following Search Modes to locate a particular portion directly while playing a disc.

- For DVD: Title Search, Chapter Search, and Time Search
- For VCD and CD: Track Search and Time Search

1 Press SEARCH MODE (M) to select Search Mode.

The on-screen bar appears on the screen.



SEARCH MODE

When a DVD is playing:

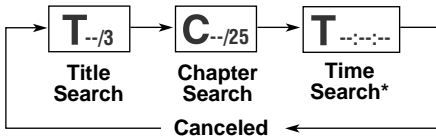

When a VCD or CD is playing:

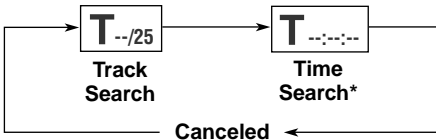

* Time Search can be performed only within the current title (for DVD) and the current track (for VCD and CD).

When Search Mode is canceled

You can use the number buttons to directly select the title number (for DVD) and track number (for VCD and CD).

2 Press the Number buttons then ENTER to select a desired title, chapter, track or playing time.

The unit starts playback of the selected item.

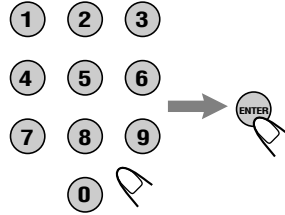

How to input the title, chapter, and track number

Press the **Number** buttons corresponding to the number, then press **ENTER** to start its playback.

- To select number 5, press **5**, then **ENTER**.
- To select number 10, press **1**, **0**, then **ENTER**.
- To select number 23, press **2**, **3**, then **ENTER**.

How to input the playing time

Press the **Number** buttons to input the playing time, then press **ENTER** to start playback at the selected elapsed playing time.

- To input time "00:45:23," press **4**, **5**, **2**, **3**, then **ENTER**.
- To input time "01:23:45," press **1**, **2**, **3**, **4**, **5**, then **ENTER**.
- To cancel a mis-entry, press **CLEAR (C)**. Each time you press the button, the last entry will be erased.

To erase the on-screen bar, press **DISPLAY (D)/TIME**.



REPEAT PLAYBACK

ENGLISH

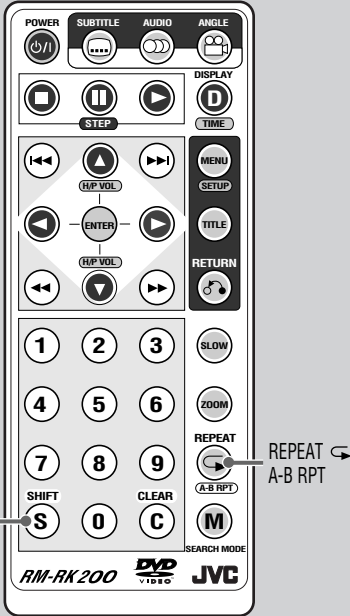

Playing Repeatedly



Repeat Play

You can repeat a chapter, track, or disc.

To repeat playback, press **REPEAT (↻)/A-B RPT** while playing or pausing.

REPEAT



The on-screen bar appears. Each time you press the button, the repeat mode indication on the on-screen bar changes as follows:

When a DVD is playing:

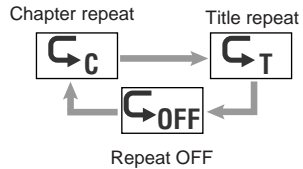

- Chapter repeat: Current chapter will be repeated.
- Title repeat: Current title will be repeated.
- Repeat OFF: Repeat play is canceled.

* On some DVDs, repeat play may be canceled by the disc itself.

When a VCD is playing:

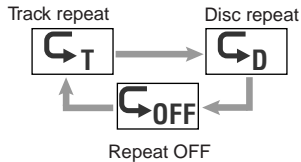

- Track repeat: Current track will be repeated.
- Disc repeat: All the tracks in the disc will be repeated.
- Repeat OFF: Repeat play is canceled.

* While playing back a VCD using the PBC function, Repeat play cannot be used.

**When a CD is playing*:**

- Disc repeat: All the tracks in the disc will be repeated.
- Track repeat: Current track will be repeated.

* When you start playing back a CD, Disc repeat is always activated first.

To erase the on-screen bar, press **DISPLAY (D)/TIME**.

A-B Repeat

While playing, you can also select a portion you want to repeat.

- When playing a DVD, A-B Repeat is not performed between different chapters or different titles.

- 1 While holding **SHIFT (S)**, press **REPEAT (↶)/A-B RPT** to select the start point.

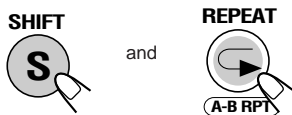

The on-screen bar appears, and the repeat mode indication changes as follows:



- 2 While holding **SHIFT (S)**, press **REPEAT (↶)/A-B RPT** again to select the end point.

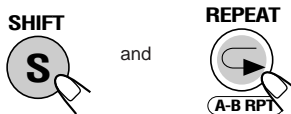

The repeat mode indication changes as follows, and A-B Repeat begins.

The unit automatically locates point A and starts repeated playback of the portion between points A and B.



Ex.: When viewing a picture

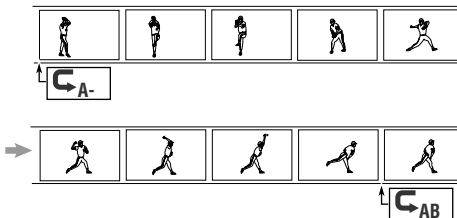

To cancel A-B Repeat, press **REPEAT (↶)/A-B RPT** once while holding **SHIFT (S)**.

To erase the on-screen bar, press **DISPLAY (D)/TIME**.

If "⊘" appears on the screen when pressing **REPEAT (↶)/A-B RPT** in step 1, A-B Repeat cannot be used on the selected portion.

- On some DVDs, A-B Repeat may not be used even within the same chapter. This is due to their disc structures, and not a malfunction of the unit.



SPECIAL EFFECTS PLAYBACK

ENGLISH

Slow-Motion Playback



You can enjoy slow-motion playback while playing a DVD or VCD.

To start Slow-motion Playback, press **SLOW** while playing a DVD or VCD.

Each time you press the button, the slow motion speed changes as follows:

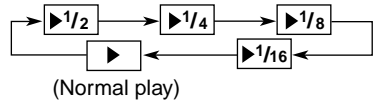

To resume normal play

Press **SLOW** repeatedly until normal play resumes.

Frame-by-frame Playback



You can advance the picture frame by frame.

1 Press **STEP** once during play.



A still picture appears on the screen.

2 Press **STEP** repeatedly to advance the picture frame by frame.



Each time you press the button, the picture advances frame by frame.

To resume normal play

Press **▶**.

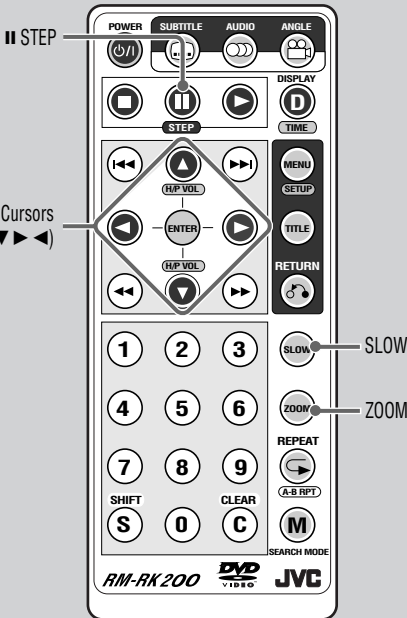



Zoom



2 Move the enlarged portion on the screen, using Cursor buttons (▲/▼/▶/◀).

You can zoom up a particular portion of the picture while playing a DVD and VCD.

- You can select the start point of zoom and adjust how precisely the zoomed-up portion is moved. (See page 27.)

1 Press ZOOM to zoom in to the picture.

Each time you press the button, the picture is enlarged as follows:

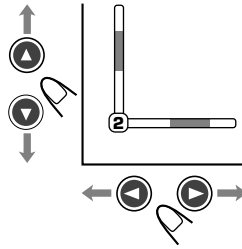
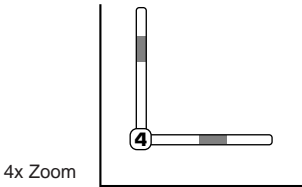
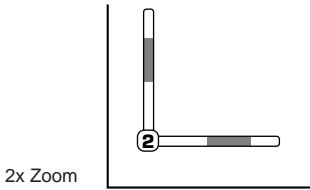
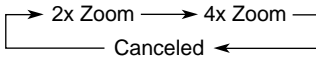

To cancel Zoom, press ZOOM repeatedly until normal size screen appears.

Ex.: When 2x Zoom is selected

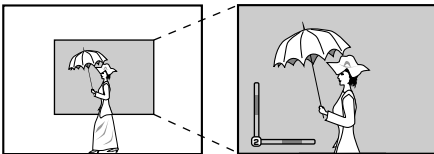

When playing a VCD

You can only select 2x Zoom.



DVD SETUP MENU

ENGLISH

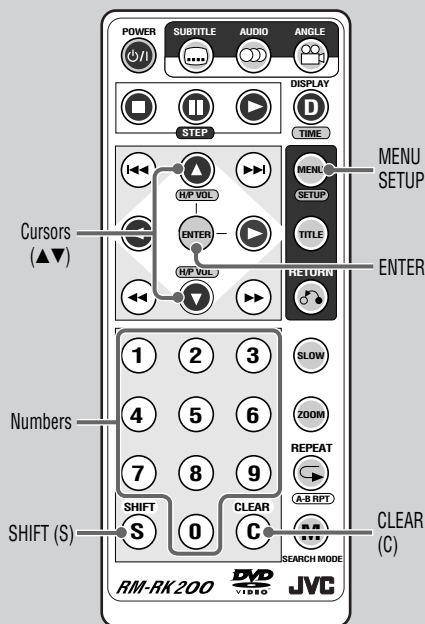

You can store the initial selection for subtitle languages, audio languages (sound), and other settings using the Setup Menu.

- DVD Setup menu can only be displayed while a disc is not playing.

Setting initial audio language

You can select the initial language for audio sound.

However, in the following cases, the original language will be selected as the initial language regardless of your setting.

- If the language you have selected is not recorded on the disc.
- If the disc is programmed to be played back in the original language.

To go back to the previous screen during the procedure, press **RETURN** ↵.

1 While holding **SHIFT (S)**, press **MENU/SETUP**.

Setup Menu appears on the screen. (“LANGUAGES” must be selected – highlighted.)

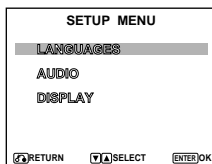
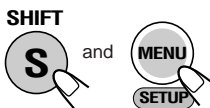

2 Press **ENTER**.

Language menu appears. (“AUDIO” must be selected – highlighted.)

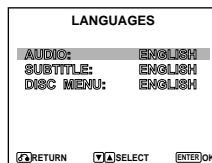

3 Press **ENTER** again.

Audio Language selecting screen appears.

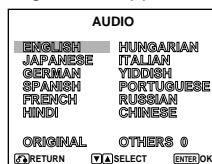



4 Press Cursor ▼ (or ▲) to select a desired language, then press ENTER.

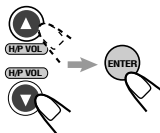

- To use the original language on the disc, select “ORIGINAL.”

If a language you want is not listed on the screen, follow the procedure below;

- 1 Press ▲ or ▼ to select “OTHERS.”
- 2 Press ENTER.
- 3 Press the **Number** buttons to enter the language code number you want.
 - See “LANGUAGE CODES” on page 30.

Ex.: To select Finnish as the initial language, press **7, 0, 7, 3**, then **ENTER**.

- To cancel a mis-entry, press **CLEAR (C)**. Each time you press the button, the last entry will be erased.

To erase the Setup Menu screen, press **MENU/SETUP** while holding **SHIFT (S)**.

Setting initial subtitle language

You can select the initial language for subtitles. However, in the following cases, the original language will be selected as the initial language regardless of your setting.

- If the language you have selected is not recorded on the disc.
- If the disc is programmed to be played back in the original language.

To go back to the previous screen during the procedure, press **RETURN** .

1 While holding SHIFT (S), press MENU/SETUP.

Setup Menu appears on the screen. (“LANGUAGES” must be selected – highlighted.)

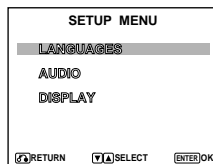
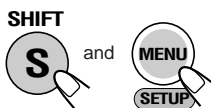

2 Press ENTER.

Language menu appears.

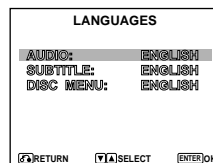

3 Press Cursor ▼ (or ▲) to select “SUBTITLE,” then press ENTER.

Subtitle Language selection screen appears.

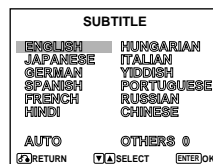
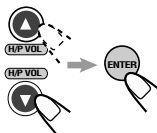

4 Press Cursor ▼ (or ▲) to select a desired language, then press ENTER.

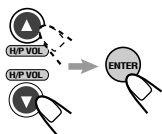

- To use the same language as the initial audio language, select “AUTO.”

If a language you want is not listed on the screen, see the left column.

To erase the Setup Menu screen, press **MENU/SETUP** while holding **SHIFT (S)**.



Setting initial disc menu language

You can select the initial language for the disc menu.

However, in the following cases, the disc menu will be displayed in the original language on the disc regardless of your setting.

- If the language you have selected is not recorded on the disc.
- If the disc is programmed to be played back in the original language.

To go back to the previous screen during the procedure, press **RETURN** ↵.

1 While holding **SHIFT (S)**, press **MENU/SETUP**.

Setup Menu appears on the screen. ("LANGUAGES" must be selected – highlighted.)

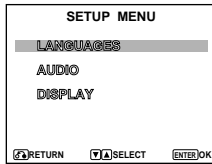
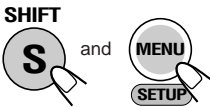

2 Press **ENTER**.

Language menu appears.

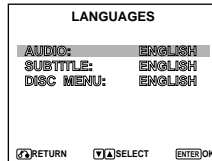

3 Press **Cursor** ▼ (or ▲) to select "DISC MENU," then press **ENTER**.

Disc Menu Language selecting screen appears.

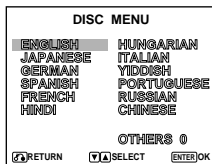
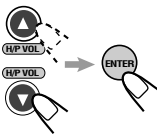

4 Press **Cursor** ▼ (or ▲) to select a desired language, then press **ENTER**.

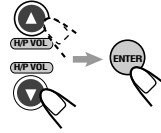

If a language you want is not listed on the screen, see page 21.

To erase the Setup Menu screen, press **MENU/SETUP** while holding **SHIFT (S)**.

Setting digital audio output

When connecting an amplifier or a decoder to the DIGITAL OUT terminal, set it as recommended – STREAM, LPCM, or OFF (see step 3).

To go back to the previous screen during the procedure, press **RETURN** ↵.

1 While holding **SHIFT (S)**, press **MENU/SETUP**.

Setup Menu appears on the screen.

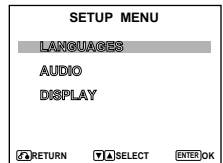
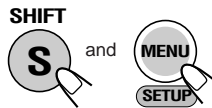

2 Press **Cursor** ▼ (or ▲) to select "AUDIO," then press **ENTER**.

Audio menu appears. ("DIGITAL OUT" must be selected – highlighted.)

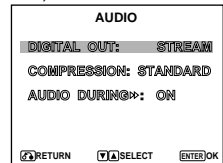
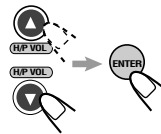



3 Press ENTER.

Digital Out selecting screen appears.

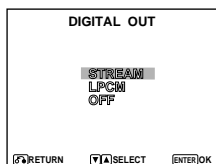

4 Press Cursor ▼ (or ▲) to select an appropriate output, then press ENTER.

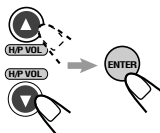

- **STREAM:** Select this when connecting an amplifier or a decoder compatible with Dolby Digital and with DTS Digital Surround.
- **LPCM:** Select this when connecting an amplifier or a decoder incompatible with Dolby Digital.
- **OFF:** Select this when you use the AUDIO L/R (analog) jacks on the rear.

Only with this setting, you can enjoy original high-quality sound of disc whose sampling frequency is 96 kHz through the AUDIO L/R jacks. (No signal will be output from the DIGITAL OUT terminal.)

For more detailed information about the output signals, see page 35.

To erase the Setup Menu screen, press MENU/SETUP while holding SHIFT (S).

Setting compression

You can compress the dynamic range (difference between the maximum and minimum sound levels) while playing a source encoded with Dolby Digital. This is useful when listening at a low volume level.

To go back to the previous screen during the procedure, press RETURN ↵.

1 While holding SHIFT (S), press MENU/SETUP.

Setup Menu appears on the screen.

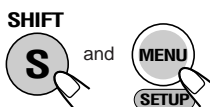

2 Press Cursor ▼ (or ▲) to select "AUDIO," then press ENTER.

Audio menu appears.

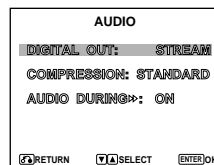
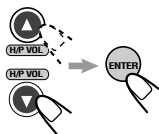

3 Press Cursor ▼ (or ▲) to select "COMPRESSION," then press ENTER.

Compression Rate selecting screen appears.

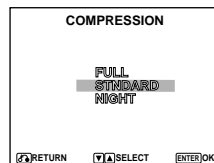
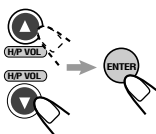

TO BE CONTINUED



4 Press Cursor \blacktriangledown (or \blacktriangle) to select a desired setting, then press ENTER.

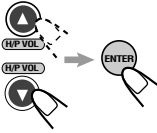

- **FULL:** Select this not to apply compression (full dynamic range as recorded on the original disc).
- **STANDARD:** Select this to reduce the dynamic range a little.
- **NIGHT:** Select this to apply compression fully (useful at a low volume).

To erase the Setup Menu screen, press MENU/SETUP while holding SHIFT (S).

Setting audio output during Low Speed Search

You can turn on or off the sound during Low Speed Search on a DVD and VCD.

- Regardless of this setting, sound always comes out during Low Speed Search on a CD.

To go back to the previous screen during the procedure, press RETURN \curvearrowright .

1 While holding SHIFT (S), press MENU/SETUP.

Setup Menu appears on the screen.

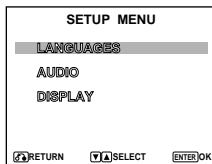
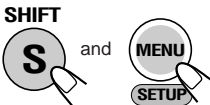

2 Press Cursor \blacktriangledown (or \blacktriangle) to select "AUDIO," then press ENTER.

Audio menu appears.

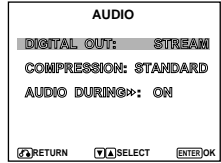
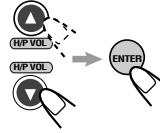

3 Press Cursor \blacktriangledown (or \blacktriangle) to select "AUDIO DURING \blacktriangleright ," then press ENTER.

Sound on/off selecting screen appears.

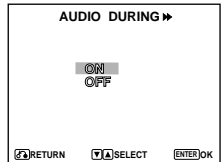
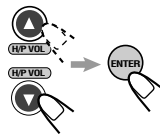

4 Press Cursor \blacktriangledown (or \blacktriangle) to select a desired setting, then press ENTER.

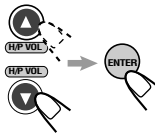

- **ON:** Sounds come out during Low Speed Search*.
- **OFF:** No sounds come out during Low Speed Search.

* Some sounds will be skipped during Low Speed Search.

To erase the Setup Menu screen, press MENU/SETUP while holding SHIFT (S).



Setting monitor type

Set the monitor type when you watch a wide screen picture.

- This setting takes effect only when playing back a DVD recorded with 16:9 wide screen video signal.

To go back to the previous screen during the procedure, press **RETURN** .

1 While holding **SHIFT (S)**, press **MENU/SETUP**.

Setup Menu appears on the screen.

SHIFT

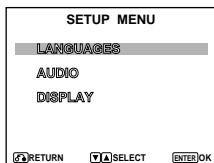

2 Press **Cursor ▼ (or ▲)** to select “**DISPLAY**,” then press **ENTER**.

Display menu appears. (“**MONITOR TYPE**” must be selected – highlighted.)

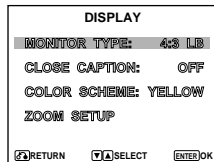
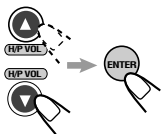

3 Press **ENTER**.

Monitor type selecting screen appears.

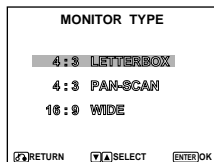

4 Press **Cursor ▼ (or ▲)** to select a desired setting, then press **ENTER**.

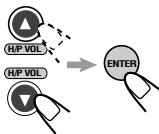

- **4:3 LETTERBOX:** Select this when viewing on TV whose aspect ratio is 4:3. While viewing a wide screen picture, the black bars appear on the top and the bottom of the screen.

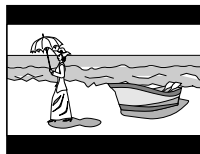

- **4:3 PAN-SCAN:** Select this when viewing on TV whose aspect ratio is 4:3. While viewing a wide screen picture, the black bars do not appear, however, the left and right edge sides of the pictures will not be shown on the screen.

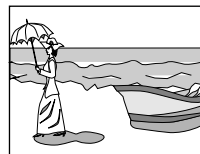

- **16:9 WIDE:** Select this when viewing on TV whose aspect ratio is 16:9.

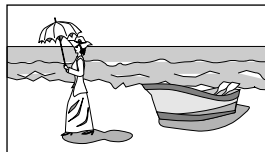

- **Even if “4:3 PAN-SCAN” is selected,** the screen size may become “4:3 LETTERBOX” while playing some DVDs. This depends on how the DVD is programmed and recorded.
- **If a disc (or some portions of the disc) is recorded with the video signals of 4:3 aspect ratio,** this setting does not take effect. The pictures are displayed with full 4:3 aspect ratio or with 4:3 Letter box.

To erase the Setup Menu screen, press **MENU/SETUP** while holding **SHIFT (S)**.



Setting closed caption

Some discs have closed captions. You can set whether you will display the close captions or not.

- To show the closed captions on the TV, you have to use a TV with a built-in closed-caption decoder, or to connect a closed-caption decoder in between this unit and a TV.

To go back to the previous screen during the procedure, press **RETURN** .

1 While holding **SHIFT (S)**, press **MENU/SETUP**.

Setup Menu appears on the screen.

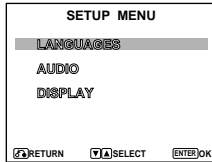
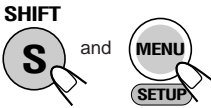

2 Press **Cursor ▼ (or ▲)** to select “**DISPLAY**,” then press **ENTER**.

Display menu appears.

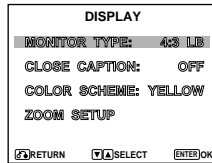
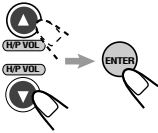

3 Press **Cursor ▼ (or ▲)** to select “**CLOSE CAPTION**,” then press **ENTER**.

Closed-caption on/off selecting screen appears.

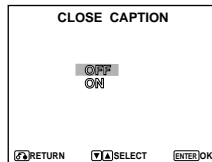
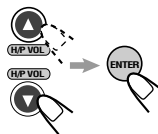

4 Press **Cursor ▼ (or ▲)** to select a desired setting, then press **ENTER**.

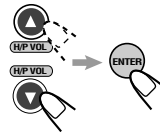

- **ON:** Select this to display the close captions when you start playback.
- **OFF:** Select this not to display the close captions when you start playback.

To erase the Setup Menu screen, press **MENU/SETUP** while holding **SHIFT (S)**.

Changing the color of the on-screen bar

You can change the color of the on-screen bar displayed on the top of the screen, by selecting the color – yellow, green, blue, or red.

To go back to the previous screen during the procedure, press **RETURN** .

1 While holding **SHIFT (S)**, press **MENU/SETUP**.

Setup Menu appears on the screen.

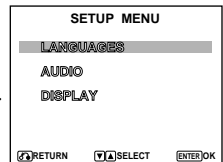
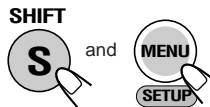

2 Press **Cursor ▼ (or ▲)** to select “**DISPLAY**,” then press **ENTER**.

Display menu appears.

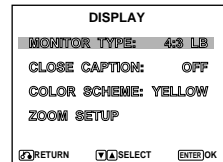
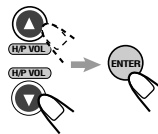



- 3** Press Cursor ▼ (or ▲) to select “COLOR SCHEME,” then press ENTER.

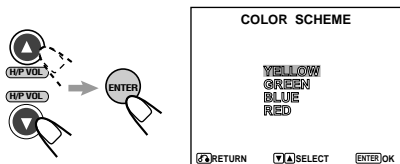

- 4** Press Cursor ▼ (or ▲) to select a desired color, then press ENTER.

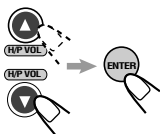

To erase the Setup Menu screen, press MENU/SETUP while holding SHIFT (S).

Setting zoom preference

You can change the zoom setting to your preference – where to start the zoom and how to move the zoomed-up portion.

To go back to the previous screen during the procedure, press RETURN ↵.

- 1** While holding SHIFT (S), press MENU/SETUP.

Setup Menu appears on the screen.

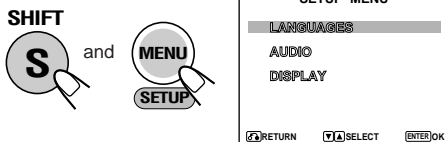

- 2** Press Cursor ▼ (or ▲) to select “DISPLAY,” then press ENTER.

Display menu appears.

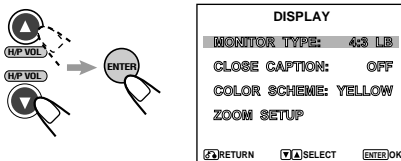

- 3** Press Cursor ▼ (or ▲) to select “ZOOM SETUP,” then press ENTER.

Zoom Setup screen appears. (“START POINT” must be selected – highlighted.)

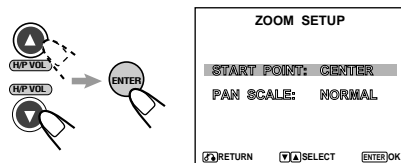

TO BE CONTINUED



4 Press ENTER again.

Start Point selecting screen appears.

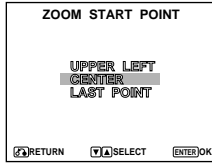

5 Press Cursor ▼ (or ▲) to select a desired setting, then press ENTER.

You can select the start point of zoom.

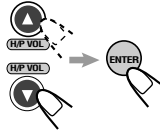

- **UPPER LEFT:** When you press ZOOM, the upper left portion of the picture is zoomed up first.
- **CENTER:** When you press ZOOM, the center portion of the picture is zoomed up first.
- **LAST POINT:** When you press ZOOM, the last zoomed-up portion of the picture is zoomed up.

7 Press Cursor ▼ (or ▲) to select a desired setting, then press ENTER.

You can select the movement amount (speed) of the zoomed-up portion.

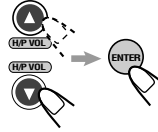

- **NORMAL:** Select this to move at normal speed to another portion of the picture.
- **ROUGH:** Select this to move faster to another portion of the picture. (Rough movement)
- **FINE:** Select this to move slower to another portion of the picture. (Fine movement)

To erase the Setup Menu screen, press MENU/SETUP while holding SHIFT (S).

6 Press Cursor ▼ (or ▲) to select "PAN SCALE," then press ENTER.

Pan Scale selecting screen appears.

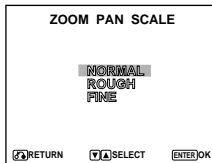
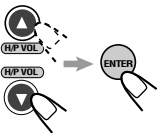



Handling discs

How to handle discs

When removing a disc from its case, press down the center holder of the case and lift the disc out, holding it by the edges.

- Always hold the disc by the edges. Do not touch its recording surface.

When storing a disc into its case, gently insert the disc around the center holder (with the printed surface facing up).

- Make sure to store discs into the cases after use.

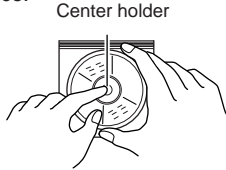

To keep discs clean

A dirty disc may not play correctly. If a disc does become dirty, wipe it with a soft cloth in a straight line from center to edge.

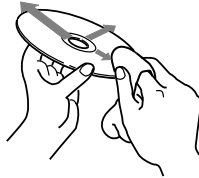

To play new discs

New discs may have some rough spots around the inner and outer edges. If such a disc is used, this unit may reject the disc. To remove these rough spots, rub the edges with a pencil or ball-point pen, etc.

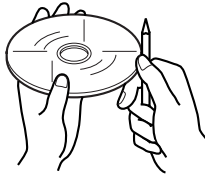

Moisture condensation

Moisture may condense on the lens inside the unit in the following cases:

- After starting the heater in the car.
- If it becomes very humid inside the car.

Should this occur, the unit may malfunction. In this case, eject the disc and leave the unit turned on for a few hours until the moisture evaporates.

CAUTIONS:

- Do not insert 8 cm discs (single discs) into the loading slot. (Such discs cannot be ejected.)
- Do not insert any disc of unusual shape — like a heart or flower; otherwise, it will cause a malfunction.
- Do not expose discs to direct sunlight or any heat source or place them in a place subject to high temperature and humidity. Do not leave them in a car.
- Do not use any solvent (for example, conventional record cleaner, spray, thinner, benzene, etc.) to clean discs.

About mistracking:

Mistracking may result from driving on extremely rough roads. This does not damage the unit and the disc, but will be annoying.

We recommend that you stop disc play while driving on such rough roads.



LANGUAGE CODES

ENGLISH

6565	Afar	7465	Japanese	8378	Shona
6566	Abkhazian	7473	Yiddish	8379	Somali
6570	Afrikaans	7487	Javanese	8381	Albanian
6577	Amharic	7565	Georgian	8382	Serbian
6582	Arabic	7575	Kazakh	8383	Siswati
6583	Assamese	7576	Greaenlandic	8384	Sesotho
6589	Aymara	7577	Cambodian	8385	Sundanese
6590	Azerbaijani	7578	Kannada	8386	Swedish
6665	Bashkir	7579	Korean	8387	Swahili
6669	Byelorussian	7583	Kashmiri	8465	Tamil
6671	Bulgarian	7585	Kurdish	8469	Telugu
6672	Bihari	7589	Kirghiz	8471	Tajik
6673	Bislama	7665	Latin	8472	Thai
6678	Bengali; Bangla	7678	Lingala	8473	Tigrinya
6679	Tibetan	7679	Laothian	8475	Turkmen
6682	Breton	7684	Lithuainnian	8476	Tagalog
6765	Catalan	7686	Latvian, Lettish	8478	Setswana
6779	Corsican	7771	Malagasy	8479	Tonga
6783	Czech	7773	Maori	8482	Turkish
6789	Welsh	7775	Macedonian	8483	Tsonga
6865	Danish	7776	Malayalam	8484	Tatar
6869	German	7778	Mongolian	8487	Twi
6890	Bhutani	7779	Moldavian	8571	Uigur
6976	Greek	7782	Marathi	8575	Ukrainian
6978	English	7783	Malay	8582	Urdu
6979	Esperanto	7784	Maltese	8590	Uzbek
6983	Spanish	7789	Burmese	8673	Vietnamese
6984	Estonian	7865	Nauru	8679	Volapuk
6985	Basque	7869	Nepali	8779	Wolof
7065	Persian	7876	Dutch	8872	Xhosa
7073	Finnish	7879	Norwegian	8979	Yoruba
7074	Fiji	7967	Occitan	9065	Zhuang
7079	Faeroese	7977	Afan Oromo	9072	Chinese
7082	French	7982	Oriya	9085	Zulu
7089	Frisian	8065	Punjabi		
7165	Irish	8076	Polish		
7168	Scots Gaelic	8083	Pashto, Pushto		
7176	Galician	8084	Portuguese		
7178	Guarani	8185	Ouechua		
7185	Gujarati	8277	Rhaeto-Romance		
7265	Hausa	8278	Kirundi		
7273	Hindi	8279	Romanian		
7282	Croatian	8285	Russian		
7285	Hungarian	8287	Kinya, Rwanda		
7289	Armenian	8365	Sanskrit		
7365	Interlingua	8368	Sindhi		
7375	Knupiak	8371	Sangro		
7378	Indonesian	8372	Serbo-Croatian		
7383	Icelandic	8373	Singhalese		
7384	Italian	8375	Slovak		
7385	Inuktitut (Eskimo)	8376	Slovenian		
7387	Hebrew	8377	Samoan		

4:3 Letterbox Screen

This is one method for displaying a wide screen picture on a conventional sized (4:3) TV. While viewing a wide screen picture, the black bars appear on the top and the bottom of the screen.



4:3 Pan-Scan Screen

This is one method for displaying a wide screen picture on a conventional sized (4:3) TV. While viewing a wide screen picture, the left and right edges of the pictures will not be shown on the screen.

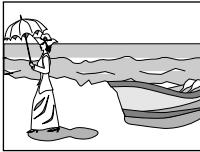

Dolby Digital

This is a digital audio compression technology that was developed by Dolby Laboratories. Dolby Digital encoding method (so-called discrete 5.1 channel digital audio format) records and compresses the left front channel, right front channel, center channel, left rear channel, right rear channel, and LFE channel (total 6 channels, but LFE channel is counted as 0.1 channel, therefore called 5.1 channels) signals digitally. Each channel is completely independent from other channel signals to avoid interference, therefore, you can obtain much better sound quality with stereo and surround effects. To reproduce these original surround signals, you need to connect an amplifier or a decoder compatible with Dolby Digital.

DTS Digital Surround

Another discrete 5.1 channel digital audio format, available on CD, LD, and DVD software, developed by Digital Theater Systems, Inc. Compared to Dolby Digital, audio compression rate is relatively low. This fact allows DTS Digital Surround format to add breadth and depth to the reproduced sounds. As a result, DTS Digital Surround features natural, solid and clear sound. To reproduce these surround signals, you need to connect an amplifier or a decoder compatible with DTS Digital Surround.

Linear PCM

This is a digital recording format that is used for audio CDs.

Playback Control (VCD)

When a VCD has the PBC (Playback Control) function, you can enjoy menu-driven operations and high-resolution still pictures.

Sampling Frequency, Quantization Bits

When analog signals are converted into digital signals, they are divided into many points and digitized. This dividing method is called "sampling." The sampling frequency indicates how many points one second is divided into – for example, for CD sound, one second is divided into 44100 points since its sampling frequency is 44.1 kHz. On the other hand, the number of quantization bits indicates the volume size used to memorize each divided point. The larger this number is, the clearer the sound can be reproduced.

Titles and Chapters (DVD)

A DVD is divided into several titles (large divisions), and each title is divided into chapters (smaller divisions). These divisions are assigned their particular numbers, so that they are easily accessed.

Tracks (VCD, CD)

VCDs and CDs are divided into tracks. Each track has its own number so that it is easily accessed.



LOCATION OF THE BUTTONS

ENGLISH

Remote controller

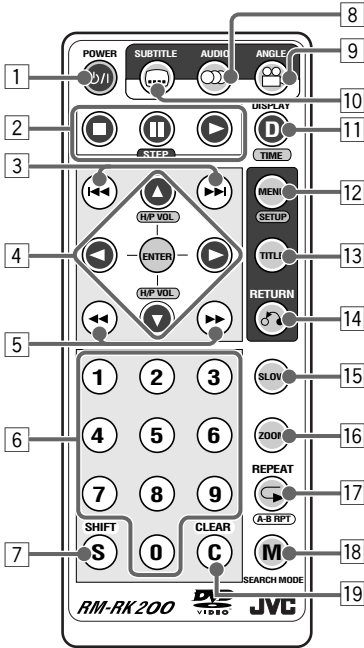

- 1 **POWER** (standby/on) button
- 2 **Disc operation buttons**
■ (stop), II (pause) STEP, ► (play)
- 3 **◀◀ / ▶▶** (reverse search/forward search) buttons
- 4 **Menu operation buttons**
▲ / ▼ / ◀ / ▶ (cursors), ENTER
• ▲ / ▼ also function as **H/P VOL** (headphones volume) buttons while pressed with **SHIFT (S)** button.
- 5 **◀◀ / ▶▶** (reverse/fast forward) buttons
- 6 **Number buttons**
- 7 **SHIFT (S)** button
- 8 **AUDIO** button
- 9 **ANGLE** button
- 10 **SUBTITLE** button
- 11 **DISPLAY (D)/TIME** button
• Also functions as **TIME** button while pressed with **SHIFT (S)** button.
- 12 **MENU/SETUP** button
• Also functions as **SETUP** button while pressed with **SHIFT (S)** button.
- 13 **TITLE** button
- 14 **RETURN** button
- 15 **SLOW** button
- 16 **ZOOM** button
- 17 **REPEAT** /A-B RPT button
• Also functions as **A-B RPT** button while pressed with **SHIFT (S)** button.
- 18 **SEARCH MODE (M)** button
- 19 **CLEAR (C)** button

Control panel

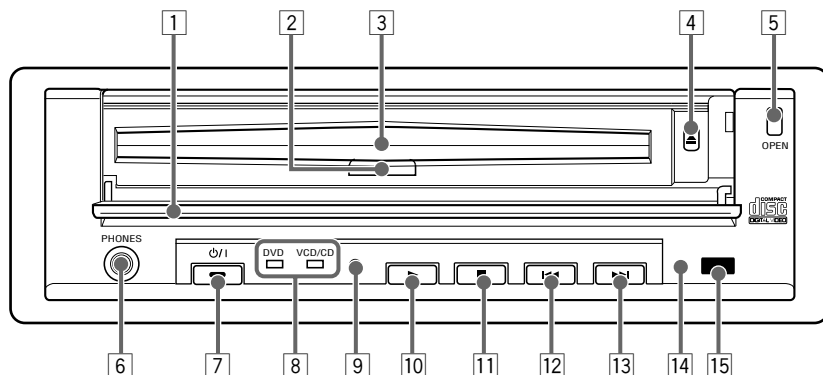

- | | |
|--|--|
| <p>1 Slot cover</p> <p>2 Disc loading lamp
This lamp goes off when the disc type is detected.</p> <p>3 Loading slot</p> <p>4 ▲ (eject) button</p> <p>5 OPEN button</p> <p>6 PHONES jack</p> <p>7 ϕ/I (standby/on) button and lamp
The lamp always lights up when the ignition key is on.</p> <p>8 Disc lamps (DVD, VCD/CD)
These lamps indicate the type of the disc loaded.</p> | <p>9 Remote signal reception lamp
This lamp flashes when receiving the remote control signals.</p> <p>10 ► (play) button and lamp
The lamp lights up when the power is on.</p> <p>11 ■ (stop) button and lamp
The lamp lights up when the power is on.</p> <p>12 ◀◀ (reverse search) button and lamp
The lamp lights up when the power is on.</p> <p>13 ▶▶ (forward search) button and lamp
The lamp lights up when the power is on.</p> <p>14 Reset button</p> <p>15 Remote sensor</p> |
|--|--|



TROUBLESHOOTING

What appears to be trouble is not always serious. Check the following points before calling a service center.

Symptoms	Causes	Remedies
• Playback cannot start after inserting a disc.	The disc is inserted upside down.	Insert the disc correctly.
• Sound and picture are sometimes interrupted or distorted.	You are driving on rough roads.	Stop playing a disc while driving on rough roads.
	The disc is scratched.	Change the disc.
	Connections are incorrect.	Check the cords and connections.
• Sound cannot be heard from the speakers.	The volume is turned to the minimum level.	Adjust it to the optimum level.
	Connections are incorrect.	Check the cords and connections.
	You are playing a disc with DTS Digital Surround.	This unit cannot output DTS sound without connecting a decoder compatible with DTS Digital Surround.
• No picture appears on the screen.	The video cord is not connected correctly.	Connect the video cord correctly.
	An incorrect input has been selected on the TV or monitor.	Select a correct input on the TV or monitor.
• The left and right edges of the picture are missing on the screen.	“4:3 PAN-SCAN (PS)” is selected when viewing on a conventional TV (aspect ratio 4:3).	Select “4:3 LETTERBOX (LB)” (See page 25.)
• No subtitle appears on the display though you have selected the initial subtitle language.	_____	Some DVDs are programmed to always display no subtitle initially. If this happens, press SUBTITLE after starting play.
• Audio language is different from the one you have selected as the initial audio language.	_____	Some DVDs are programmed to always use the original language initially. If this happens, press AUDIO after starting play.
• Disc can be neither played back nor ejected.	The built-in microcomputer may function incorrectly due to noise, etc.	Turn off the power, then turn it again.
• This unit does not work at all.	The built-in microcomputer may function incorrectly due to noise, etc.	Press the reset button to reset the unit. (See page 2.)

SPECIFICATIONS

AUDIO SECTION

Frequency Response:
 DVD, fs=48 kHz: 16 Hz to 22 000 Hz
 DVD, fs=96 kHz: 16 Hz to 44 000 Hz
 VCD, CD: 16 Hz to 20 000 Hz
 Dynamic Range: 93 dB
 Signal-to-Noise Ratio: 95 dB
 Pickup wave length: 650 nm
 Wow and Flutter: Less than measurable limit
 Audio output level:
 Analog (AUDIO L/R): 1.5 Vrms
 Digital (DIGITAL OUT):
 Signal wave length: 660 nm
 Output level: -21 dBm to -15 dBm

VIDEO SECTION

Color system: NTSC
 Video output (composite): 1 Vp-p/75 Ω

GENERAL

Power Requirement:
 Operating Voltage: DC 14.4 V
 (11 V to 16 V allowance)
 Grounding System: Negative ground
 Allowable Operating Temperature:
 0°C to +40°C
 (32°F to 104°F)
 Dimensions (W x H x D):
 Unit Size:
 178 mm x 50.5 mm x 167 mm
 (7-1/16" x 2" x 6-5/8")
 Installation Size:
 182 mm x 52 mm x 150 mm
 (7-3/16" x 2-1/16" x 5-15/16")
 Panel Size: 188 mm x 58 mm x 13.4 mm
 (7-7/16" x 2-5/16" x 9/16")
 Mass: 1.4 kg (3.1 lbs) (excluding accessories)

Design and specifications subject to change without notice.

If a kit is necessary for your car, consult a telephone directory for the nearest car audio speciality shop.

Output signals through the DIGITAL OUT terminal

They differ depending on the "DIGITAL OUT" setting on the Setup Menu.

DIGITAL OUT Playback Disc	Output Signals		
	STREAM	LPCM	OFF
DVD 48 kHz, Linear PCM	48 kHz, Linear PCM	48 kHz, Linear PCM	None
96 kHz, Linear PCM	48 kHz, Linear PCM	48 kHz, Linear PCM	None
with Dolby Digital	Dolby Digital bitstream	Down mix (2 channels)	None
with DTS Digital Surround	DTS bitstream	None	None
Video CD, Audio CD	44.1 kHz, 16 bit Linear PCM	44.1 kHz, 16 bit Linear PCM	None
Auido CD with DTS	DTS bitstream	DTS bitstream	None



JVC

**MOBILE
ENTERTAINMENT**

<http://www.jvcmobile.com>

Visit us on-line for

Technical Support & Customer Satisfaction Survey.

US RESIDENTS ONLY

**Having TROUBLE with operation?
Please reset your unit**

**Refer to page of How to Reset
Still having trouble??**

USA ONLY

Call 1-800-252-5722

<http://www.jvcservice.com>

We can help you!

JVC

VICTOR COMPANY OF JAPAN, LIMITED



EN, SP, FR



Printed in Japan
0201MNMMDWOZK