

JVC

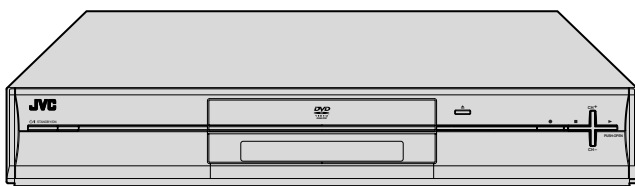

DVD VIDEO RECORDER

DR-M100S



INSTRUCTIONS

For Customer Use:

Enter below the Model No. and Serial No. which are located on the rear of cabinet. Retain this information for future reference.

Model No. _____

Serial No. _____

LPT1013-001B

EN

Dear Customer,

Thank you for purchasing the JVC DVD video recorder. Before use, please read the safety information and precautions to ensure safe use of your new unit.

Cautions

CAUTION

RISK OF ELECTRIC SHOCK
DO NOT OPEN

CAUTION: TO REDUCE THE RISK OF ELECTRIC SHOCK. DO NOT REMOVE COVER (OR BACK). NO USER-SERVICEABLE PARTS INSIDE. REFER SERVICING TO QUALIFIED SERVICE PERSONNEL.



The lightning flash with arrowhead symbol, within an equilateral triangle, is intended to alert the user to the presence of uninsulated "dangerous voltage" within the product's enclosure that may be of sufficient magnitude to constitute a risk of electric shock to persons.



The exclamation point within an equilateral triangle is intended to alert the user to the presence of important operating and maintenance (servicing) instructions in the literature accompanying the appliance.

CAUTION:

A UNIT IS A CLASS 1 LASER PRODUCT. HOWEVER THIS UNIT USES A VISIBLE LASER BEAM WHICH COULD CAUSE HAZARDOUS RADIATION EXPOSURE IF DIRECTED. BE SURE TO OPERATE THE UNIT CORRECTLY AS INSTRUCTED.

WHEN THIS UNIT IS PLUGGED INTO THE WALL OUTLET, DO NOT PLACE YOUR EYES CLOSE TO THE OPENING OF THE DISC TRAY AND OTHER OPENINGS TO LOOK INTO THE INSIDE OF THIS UNIT.

USE OF CONTROLS OR ADJUSTMENTS OR PERFORMANCE OF PROCEDURES OTHER THAN THOSE SPECIFIED HEREIN MAY RESULT IN HAZARDOUS RADIATION EXPOSURE.

DO NOT OPEN COVERS AND DO NOT REPAIR YOURSELF. REFER SERVICING TO QUALIFIED PERSONNEL.

CLASS 1 LASER PRODUCT

REPRODUCTION OF LABELS

WARNING LABEL INSIDE OF THE UNIT

<p>CAUTION VISIBLE AND INVISIBLE LASER RADIATION WHEN OPEN. AVOID EXPOSURE TO BEAM. DO NOT STARE INTO BEAM OR VIEW DIRECTLY WITH OPTICAL INSTRUMENTS.</p>	<p>ATTENTION RAYONNEMENTS LASER VISIBLES ET INVISIBLES LORS DE L'OUVERTURE. ÉVITER TOUTE EXPOSITION AU FAISCEAU. NE PAS FIXER DU REGARD LE FAISCEAU OU LE REGARDER DIRECTEMENT VIA DES INSTRUMENTS OPTIQUES.</p>	<p>ADVARSEL SYNLIG OG USYNLIG LASERSTRÅLING VED ÅBNING. UNDGÅ UDSÆTTELSE FOR STRÅLING. SE IKKE IND I STRÅLEN. HELLER IKKE MED OPTISKE INSTRUMENTER.</p>	<p>ADVARSEL SYNLIG OG USYNLIG LASERSTRÅLING NÅR DEKSEL ÅPNES. UNNGÅ UTSÆTTELSE FOR STRÅLEN. STIRR IKKE INN I STRÅLEN ELLER SE DIREKTE MED OPTISKE OPTISKEN LAITTEEN LAPL.</p>	<p>VARO! AVATTAESSA OLET ALLTTIINA NÄKYVÄLLE JA NÄKYMÄTTÄMÄLLE LASERSÄTELVILLE. ÄLÄ TUUJOTA SÄTEESEEN ALAKKA KATSO SITA OPTISEN LAITTEEN LAPL.</p>	<p>VARNING SYNLIG OCH OSYNLIG LASERSTRÅLNING NÄR DENNA DEL ÄR ÖPPNAD. STRÅLEN ÄR FARLIG STIRRA EJ IN I STRÅLEN OCH BETRÄKTA EJ STRÅLEN MED OPTISKA INSTRUMENT. LP41159-001A</p>
--	---	--	--	---	--

WARNING:

TO PREVENT FIRE OR SHOCK HAZARD, DO NOT EXPOSE THIS UNIT TO RAIN OR MOISTURE.

CAUTION:

This unit should be used with AC 120V~, 60Hz only. To prevent electric shocks and fire hazards, DO NOT use any other power source.

CAUTION:

TO PREVENT ELECTRIC SHOCK, MATCH WIDE BLADE OF PLUG TO WIDE SLOT, FULLY INSERT.

ATTENTION:

POUR ÉVITER LES CHOCS ÉLECTRIQUES, INTRODUIRE LA LAME LA PLUS LARGE DE LA FICHE DANS LA BORNE CORRESPONDANTE DE LA PRISE ET POUSSER JUSQU'AU FOND.

Note to CATV system installer:

This reminder is provided to call the CATV system installer's attention to Article 820-40 of the NEC that provides guidelines for proper grounding and, in particular, specifies that the cable ground shall be connected to the grounding system of the building, as close to the point of cable entry as practical.

CAUTION:

Changes or modifications not approved by JVC could void user's authority to operate the equipment.

IMPORTANT PRODUCT SAFETY INSTRUCTIONS

Electrical energy can perform many useful functions. But improper use can result in potential electrical shock or fire hazards. This product has been engineered and manufactured to assure your personal safety. In order not to defeat the built-in safeguards, observe the following basic rules for its installation, use and servicing.

ATTENTION:

Follow and obey all warnings and instructions marked on your product and its operating instructions. For your safety, please read all the safety and operating instructions before you operate this product and keep this booklet for future reference.

INSTALLATION

1. Grounding or Polarization

(A) Your product may be equipped with a polarized alternating-current line plug (a plug having one blade wider than the other). This plug will fit into the power outlet only one way. This is a safety feature.

If you are unable to insert the plug fully into the outlet, try reversing the plug. If the plug should still fail to fit, contact your electrician to replace your obsolete outlet. Do not defeat the safety purpose of the polarized plug.

(B) Your product may be equipped with a 3-wire grounding-type plug, a plug having a third (grounding) pin. This plug will only fit into a grounding-type power outlet. This is a safety feature. If you are unable to insert the plug into the outlet, contact your electrician to replace your obsolete outlet. Do not defeat the safety purpose of the grounding-type plug.

2. Power Sources

Operate your product only from the type of power source indicated on the marking label. If you are not sure of the type of power supply to your home, consult your product dealer or local power company. If your product is intended to operate from battery power, or other sources, refer to the operating instructions.

3. Overloading

Do not overload wall outlets, extension cords, or integral convenience receptacles as this can result in a risk of fire or electric shock.

4. Power Cord Protection

Power supply cords should be routed so that they are not likely to be walked on or pinched by items placed upon or against them, paying particular attention to cords at plugs, convenience receptacles, and the point where they exit from the product.

5. Ventilation

Slots and openings in the cabinet are provided for ventilation. To ensure reliable operation of the product and to protect it from overheating, these openings must not be blocked or covered.

- Do not block the openings by placing the product on a bed, sofa, rug or other similar surface.
- Do not place the product in a built-in installation such as a bookcase or rack unless proper ventilation is provided or the manufacturer's instructions have been adhered to.

6. Wall or Ceiling Mounting

The product should be mounted to a wall or ceiling only as recommended by the manufacturer.

ANTENNA INSTALLATION INSTRUCTIONS

1. Outdoor Antenna Grounding

If an outside antenna or cable system is connected to the product, be sure the antenna or cable system is grounded so as to provide some protection against voltage surges and built-up static charges. Article 810 of the National Electrical Code, ANSI/NFPA 70, provides information with regard to proper grounding of the mast and supporting structure, grounding of the lead-in wire to an antenna discharge unit, size of grounding connectors, location of antenna discharge unit, connection to grounding electrodes, and requirements for the grounding electrode.

2. Lightning

For added protection for this product during a lightning storm, or when it is left unattended and unused for long periods of time, unplug it from the wall outlet and disconnect the antenna or cable system. This will prevent damage to the product due to lightning and power-line surges.

3. Power Lines

An outside antenna system should not be located in the vicinity of overhead power lines or other electric light or power circuits, or where it can fall into such power lines or circuits. When installing an outside antenna system, extreme care should be taken to keep from touching such power lines or circuits as contact with them might be fatal.

EXAMPLE OF ANTENNA GROUNDING AS PER NATIONAL ELECTRICAL CODE, ANSI/NFPA 70

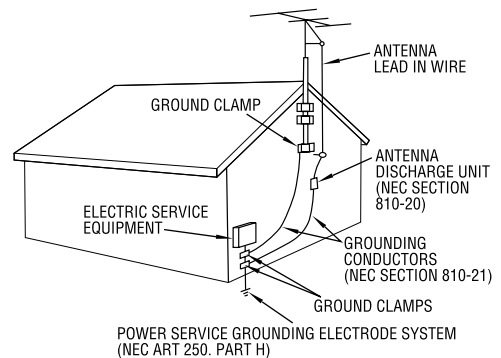

NEC – NATIONAL ELECTRICAL CODE

USE**1. Accessories**

To avoid personal injury:

- Do not place this product on an unstable cart, stand, tripod, bracket, or table. It may fall, causing serious injury to a child or adult, and serious damage to the product.
- Use only with a cart, stand, tripod, bracket, or table recommended by the manufacturer or sold with the product.
- Use a mounting accessory recommended by the manufacturer and follow the manufacturer's instructions for any mounting of the product.
- Do not try to roll a cart with small casters across thresholds or deep-pile carpets.

2. Product and Cart Combination

A product and cart combination should be moved with care. Quick stops, excessive force, and uneven surfaces may cause the product and cart combination to overturn.

PORTABLE CART WARNING
(Symbol provided by RETAC)

**3. Water and Moisture**

Do not use this product near water—for example, near a bath tub, wash bowl, kitchen sink or laundry tub, in a wet basement, or near a swimming pool and the like.

4. Object and Liquid Entry

Never push objects of any kind into this product through openings as they may touch dangerous voltage points or short-out parts that could result in a fire or electric shock. Never spill liquid of any kind on the product.

5. Attachments

Do not use attachments not recommended by the manufacturer of this product as they may cause hazards.

6. Cleaning

Unplug this product from the wall outlet before cleaning. Do not use liquid cleaners or aerosol cleaners. Use a damp cloth for cleaning.

7. Heat

The product should be situated away from heat sources such as radiators, heat registers, stoves, or other products (including amplifiers) that produce heat.

SERVICING**1. Servicing**

If your product is not operating correctly or exhibits a marked change in performance and you are unable to restore normal operation by following the detailed procedure in its operating instructions, do not attempt to service it yourself as opening or removing covers may expose you to dangerous voltage or other hazards. Refer all servicing to qualified service personnel.

2. Damage Requiring Service

Unplug this product from the wall outlet and refer servicing to qualified service personnel under the following conditions:

- When the power supply cord or plug is damaged.
- If liquid has been spilled, or objects have fallen into the product.
- If the product has been exposed to rain or water.
- If the product does not operate normally by following the operating instructions. Adjust only those controls that are covered by the operating instructions as an improper adjustment of other controls may result in damage and will often require extensive work by a qualified technician to restore the product to its normal operation.
- If the product has been dropped or damaged in any way.
- When the product exhibits a distinct change in performance—this indicates a need for service.

3. Replacement Parts

When replacement parts are required, be sure the service technician has used replacement parts specified by the manufacturer or which have the same characteristics as the original part. Unauthorized substitutions may result in fire, electric shock or other hazards.

4. Safety Check

Upon completion of any service or repairs to this product, ask the service technician to perform safety checks to determine that the product is in safe operating condition.

HOW TO USE THIS INSTRUCTION MANUAL

- All major sections and subsections are listed in the Table Of Contents on page 6. Use this when searching for information on a specific procedure or feature.
- The Index on pages 12 – 14 illustrates the controls and connections on the front and rear panel, the front display panel and the remote control.
- The list of terms on page 70 lists frequently-used terms, and the number of the page on which they are used or explained in the manual.
- The mark signals a reference to another page for instructions or related information.
- Operation buttons necessary for the various procedures are clearly indicated through the use of illustrations at the beginning of each major section.

BEFORE YOU INSTALL YOUR NEW UNIT . . .

. . . please read the sections/literature listed below.

- “SAFETY FIRST” (pg. 2)
- “IMPORTANT PRODUCT SAFETY INSTRUCTIONS” (pg. 3 – 5)

Declaration of Conformity

Model Number:DR-M100SU

Trade Name:JVC

Responsible Party:JVC Americas Corp.

Address:1700 Valley Road Wayne, N.J. 07470

Telephone Number:973-317-5000

This device complies with Part 15 of FCC Rules.

Operation is subject to the following two conditions:

- (1) This device may not cause harmful interference, and (2) this device must accept any interference received, including interference that may cause undesired operation.

This equipment has been tested and found to comply with the limits for a Class B digital device, pursuant to Part 15 of the FCC Rules. These limits are designed to provide reasonable protection against harmful interference in a residential installation. This equipment generates, uses, and can radiate radio frequency energy and, if not installed and used in accordance with the instructions, may cause harmful interference to radio communications. However, there is no guarantee that interference will not occur in a particular installation. If this equipment does cause harmful interference to radio or television reception, which can be determined by turning the equipment off and on, the user is encouraged to try to correct the interference by one or more of the following measures:

Reorient or relocate the receiving antenna.

Increase the separation between the equipment and receiver.

Connect the equipment into an outlet on a circuit different from that to which the receiver is connected.

Consult the dealer or an experienced radio/TV technician for help.



- Manufactured under licence from Dolby Laboratories. "Dolby" and double-D symbol are trademarks of Dolby Laboratories.
- "DTS" and "DTS DIGITAL OUT" are trademarks of Digital Theater Systems, Inc.
- VCR Plus+ and PlusCode are registered trademarks of Gemstar Development Corporation.
The VCR Plus+ system is manufactured under license from Gemstar Development Corporation.
- DSS™ is an official trademark of DIRECTV, Inc., a unit of GM Hughes Electronics. DISH Network™ is a trademark of Echostar Communications Corporation.
- This product incorporates copyright protection technology that is protected by method claims of certain U.S. patents and other intellectual property rights owned by Macrovision Corporation and other rights owners. Use of this copyright protection technology must be authorized by Macrovision Corporation, and is intended for home and other limited viewing users only unless otherwise authorized by Macrovision Corporation. Reverse engineering or disassembly is prohibited.

When the equipment is installed in a cabinet or a shelf, make sure that it has sufficient space on all sides to allow for ventilation (10 cm or more on both sides, on top and at the rear). When discarding batteries, environmental problems must be considered and the local rules or laws governing the disposal of these batteries must be followed strictly.

Failure to heed the following precautions may result in damage to the unit, remote control or disc.

- DO NOT place the unit** —
 - in an environment prone to extreme temperatures or humidity.
 - in direct sunlight.
 - in a dusty environment.
 - in an environment where strong magnetic fields are generated.
 - on a surface that is unstable or subject to vibration.
- DO NOT block the unit's ventilation openings or holes.** (If the ventilation openings or holes are blocked by a newspaper or cloth, etc., the heat may not be able to get out.)
- DO NOT place heavy objects on the unit or remote control.**
- DO NOT place anything which might spill on top of the unit or remote control.** (If water or liquid is allowed to enter this equipment, fire or electric shock may be caused.)
- DO NOT expose the apparatus to dripping or splashing.**
- DO NOT use this equipment in a bathroom or places with water.** Also **DO NOT** place any containers filled with water or liquids (such as cosmetics or medicines, flower vases, potted plants, cups, etc.) on top of this unit.
- DO NOT place any naked flame sources, such as lighted candles, on the apparatus.**
- AVOID violent shocks to the unit during transport.**

MOISTURE CONDENSATION

Moisture in the air will condense on the unit when you move it from a cold place to a warm place, or under extremely humid conditions—just as water droplets form on the surface of a glass filled with cold liquid. In conditions where condensation may occur, disconnect the unit's power plug from the wall and keep it disconnected for a few hours to let the moisture dry, then turn on the unit.

DISCLAIMER OF LIABILITY:

JVC shall not be liable for any loss relating to the unit's failure to properly record, store or playback any content (video, audio or otherwise) for any reason whatsoever. Any applicable warranties shall only cover replacement or repair of the effected unit, and shall not apply to recovery or replacement of lost content.

ATTENTION:



- Using a mobile phone in the vicinity of the unit may cause picture vibration on the TV screen or change the screen to a blue back display.
- Some TVs or other appliances generate strong magnetic fields. Do not place such appliances on top of the unit as it may cause picture disturbance.
- If there is a power outage when using the unit, the recorded data may be erased.
- Recorded programmes and data cannot be restored once the disc is damaged.

SAFETY FIRST	2	EDITING	53
DISC INFORMATION	7	DV Dubbing	53
About Discs	7	Edit From A Camcorder	54
INDEX	12	Edit To Or From Another Recorder	55
INSTALLING YOUR NEW UNIT	16	Digital Audio Dubbing	56
Basic Connection	16	REMOTE CONTROL/SYSTEM CONNECTIONS	57
INITIAL SETTINGS	17	Remote Control Functions	57
Plug & Play Set	17	Connecting To A Dolby Digital Decoder Or An Amplifier With Built-in DTS.....	57
Language	18	SUBSIDIARY SETTINGS	58
Clock Set.....	19	Mode Set	58
Tuner Set	20	Scan Mode Set.....	60
Monitor Set.....	21	Tray Lock.....	61
BASIC OPERATIONS ON DVD DECK	22	Child Lock.....	61
Basic Playback.....	22	Changing VCR Plus+ Setting	62
Playback Features	23	Format A Disc.....	63
Live Memory Playback.....	27	Finalize A Disc.....	64
Using The On-screen Bar	30	TROUBLESHOOTING	65
Basic Recording	34	APPENDIX	68
Recording Features.....	35	SPECIFICATIONS	69
TIMER RECORDING	37	LIST OF TERMS	70
VCR Plus+ Timer Programming.....	37	WARRANTY (Only in U.S.A.)	71
Manual Timer Programming.....	38	FOR SERVICING (Only in U.S.A.)	72
On-Disc Timer Programming	39		
Check, Cancel And Change Programs	41		
Automatic Satellite Program Recording	42		
NAVIGATION	43		
Library Database Navigation.....	43		
Basic Operation Of Original Information	44		
Edit Original Information.....	46		
Basic Operation Of Play List Information	47		
Edit Play List Information	48		
Edit Library Information	51		
Playback With MP3/JPEG Navigation.....	52		

About Discs

Recordable/Playable Discs

You can use discs with the following logos for recording and playback.

 <p>DVD-RAM 12 cm: 4.7 GB/9.4 GB 8 cm: 1.4 GB/2.8 GB Ver. 2.0/2x speed Ver. 2.1/1x – 3x speed Ver. 2.2/5x speed</p>	 <p>DVD-RW 12 cm: 4.7 GB 8 cm: 1.4 GB Ver. 1.1/1x – 2x speed (Video mode/VR mode) Ver. 1.2/4x/6x speed (Video mode/VR mode)</p>
 <p>DVD-R 12 cm: 4.7 GB 8 cm: 1.4 GB Ver. 2.0/1x - 4x/8x speed (Video mode) Ver. 2.1/16x speed (Video mode)</p>	

- The above table is based on the information as of January 2005.
- Recording and playback may not be performed depending on the characteristics and condition of the disc used, leading to unsatisfactory results. Using discs manufactured by JVC is recommended since they have been tested to be compatible with this unit.

DVD-RAM Discs

It is only possible to use discs which conform with DVD-RAM standard Version 2.0, 2.1 or 2.2.

- If you use a disc formatted under a different standard version, format it on this unit before use.
- It may not be possible to record, play back, edit or dub a DVD-RAM disc even if it conforms to the standard if it was recorded or edited on the devices from other manufacturers or on a PC, or if it has far too many titles, or if there is very little available capacity remaining on the disc.
- DVD-RAM discs recorded on this unit cannot be played back on an incompatible DVD player.
- It is possible to record copy-once programs of digital broadcasts only onto 4.7/9.4 GB DVD-RAM discs. (2.8 GB DVD-RAM discs are not compatible)
- This unit does not support discs contained in cartridges. Use the disc after removing it from the cartridge. For details on discs in TYPE2 and TYPE4 (disc removable) cartridge, refer to its instruction manual.
- While recording, it is possible not only to start playback of a program currently being recorded, but also to watch another program previously recorded.

DVD-R/RW Discs

It is only possible to use DVD-R discs which conform with DVD-R standard Version 2.0 or 2.1.

It is only possible to use discs which conform with DVD-RW standard Version 1.1 or 1.2. Available in VR mode and Video mode.

When a DVD-R/RW disc (Video mode) is finalized (pg. 64), it can be played back on a standard DVD player as a DVD VIDEO disc.

When a DVD-RW disc (VR mode) is finalized (pg. 64), it can be played back on DVD player compatible with the VR mode of DVD-RW discs.

Before finalizing —

— it is possible to record on unrecorded areas of the disc, edit the disc title and program titles, and delete programs.

- It is impossible to record or edit DVD-R/RW discs recorded on other devices even if they have not been finalized.
- It is impossible to overwrite recorded areas of DVD-R discs.
- Available recording capacity does not increase even if a recorded program is deleted from a DVD-R disc.

After finalizing —

After a DVD-R/RW disc (Video mode) has been finalized, it is possible to play back the recorded programs (video and/or audio) on a standard DVD video player as a DVD VIDEO disc.

- Edited titles are displayed as the “DVD menu” in video mode.
- It is impossible to record, edit or delete the data either in video mode or in VR mode.
- Either in video mode or in VR mode, although the disc can be played back on DVD players from other manufacturers, sometimes it may not be possible to play back depending on the disc and recording conditions.
- It is impossible to record on CD-R/RW or DVD-R discs used for authoring.
- When recording copy-once programs of digital broadcasts, record in VR mode using CPRM compatible DVD-RW discs.

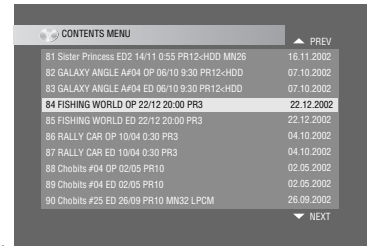







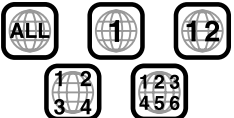

NOTE:

The following may result if you play back a DVD-R disc recorded on another unit.

- The disc does not play.
- A mosaic pattern (block noise) appears on the screen.
- Video or audio may be dropped out.
- The unit stops during playback.

Discs For Playback Only

You can use discs with the following logos for playback only.

 <p>DVD VIDEO</p> <p>(example of region code indications)</p> 	<p>Video CD/Super Video CD</p>    
 <p>Audio CD CD-DA files</p>	 <p>CD-R CD-DA/JPEG/ MP3 files</p>
 <p>CD-RW CD-DA/JPEG/ MP3 files</p>	 <p>CD-ROM JPEG/MP3 files</p>

- Playback may not be performed depending on the characteristics and condition of the disc used.
- DTS Audio CDs can also be played back. (An optional DTS decoder is required)
- MP3 and JPEG discs can be played back on this unit only when they have been recorded in the ISO9660 or Joliet format and finalized.
- JPEG files that can be played back on this unit must conform to JFIF/Baseline process, and the maximum resolution of a JPEG file is 2,812 pixels in width and 2,112 pixels in height.
- CD-R/RW discs recorded in music CD format need to be finalized to play back on this unit.
- Operation and audio quality of this unit are not guaranteed for discs that do not conform to the Compact Disc specification (CD-DA).

Before you play back a CD, check for the CD logo and read the notes on the package to confirm that it conforms to the Compact Disc specification.

- Depending on the intentions of the author of the software, recording conditions of DVD discs and Video CD/SVCD discs may be restricted. Since this unit plays back discs according to the intentions of the author of the software as indicated on the disc, some functions may not operate as commanded.
- When switching from the first layer to the second layer of double-layered DVD VIDEO discs, the image and sound may be momentarily distorted. This is not a malfunction.
- DVD-AUDIO discs compatible with DVD video players can be played.
- Super Audio CDs (SACD) compatible with conventional CD players can be played.

Unplayable Discs

The unit may not be able to play back or it may take some time to read a disc depending on the recording status or condition of the disc, or if the disc is scratched, dirty or warped.

In addition, do not attempt to play back discs in unusual shapes (heart-shaped, octagonal, or other forms). If such discs are accidentally played back, it may cause noise that can lead to speaker damage.

- CD-ROM discs (including PHOTO-CD and CD-G)
- Discs recorded in Packet Write (UDF) format
- 1.3 GB double density CDs (DDCD)
- High density CDs (HDCD)

The following discs also cannot be played back.

- Discs of a region number other than "1"
- DVD-RAM (2.6 GB/5.2 GB)
- DVD-RAM (TYPE1)

Caution for DualDisc playback

The Non-DVD side of a "DualDisc" does not comply with the "Compact Disc Digital Audio" standard. Therefore, the use of Non-DVD side of a DualDisc on this product may not be recommended.

Region Number

The world is divided into 6 regions for DVD VIDEO discs.

DVD VIDEO discs are assigned a region number to indicate which region they may be played back in. A disc cannot be played back on this unit unless the region number of the disc matches that of the unit. The region number for this unit is "1". Only discs whose region number includes "1" or "ALL" can be played back such as shown below.

Examples of DVD VIDEO labels which can be played back using this unit.



Marks of discs in this instruction manual

	Allows operation with a DVD-RAM disc.		Allows operation with a Video CD/Super Video CD (SVCD) disc.
	Allows operation with a DVD-R disc.		Allows operation with an Audio CD disc.
	Allows operation with a DVD-RW disc.		Allows operation with a disc including MP3 files.
	Allows operation with a DVD VIDEO disc.		Allows operation with a disc including JPEG files.

Recording Medium And Format

DVD-RAM

- Recording and erasing can be performed as many times as possible on a disc.
- Editing can be performed after recording, such as deleting unwanted parts.
- While recording, it is possible not only to start playback of a program currently being recorded, but also to watch another program previously recorded.

DVD-RW (VR mode)

- Recording and erasing can be performed as many times as possible on a disc.
- Editing can be performed after recording, such as deleting unwanted parts.

DVD-RW (Video mode)

- Can be played back on other DVD players after finalizing.
- New recording can be performed by erasing all the data on a disc once played back.

DVD-R

- Can be played back on other DVD players after finalizing.
- Suitable when keeping a recorded disc for a long time.

File Structure Of Discs

DVD VIDEO

Typically, DVD VIDEO discs are made up of larger units called "titles". Each title has a number (title number) that can be used to select desired titles. Titles are further divided into units called "chapters". Each chapter has a number (chapter number) that can also be used to select desired chapters. Note that some discs are not divided into titles and chapters.

When you record a program on a DVD-RAM/RW (VR mode) disc

A single recording session results in a single title. In addition, chapter marks are automatically inserted when recording is paused, or audio changes from monaural to stereo due to commercial breaks, etc. It is also possible to insert chapter marks at desired locations during playback. (pg. 25)

When you record a program on a DVD-R/RW (Video mode) disc

A single recording session results in a single title. Marks are assigned automatically approximately every 5 minutes during recording. In addition, chapter marks are automatically inserted when recording is paused, or audio changes from monaural to stereo due to commercial breaks, etc. It is possible to insert chapter marks at desired locations during playback. Once the disc has been finalized, these chapter marks are deleted and new chapter marks are assigned automatically approximately every 5 minutes.

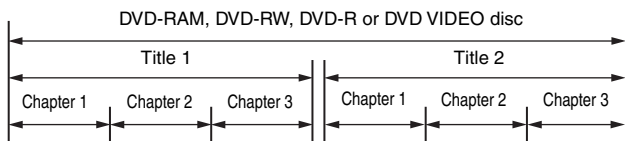

- In Video mode, even before finalizing, it is impossible to perform editing operations other than changing the disc name and/or title names and deleting programs and/or titles.
- After finalizing, it is impossible to perform editing operations.

Audio CD/Video CD/SVCD

Typically, Audio CD discs are divided into separate tracks each containing one song. Each track is assigned a number. For example, the third track is Track 3. The same is true for Video CD/SVCD discs.

However, some discs are not divided into tracks.

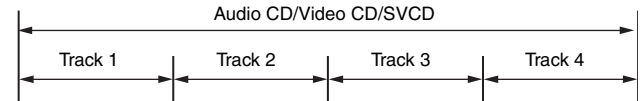

JPEG/MP3 Disc (CD-R/RW/ROM)

MP3/JPEG files put in directories nested in several levels on a disc will be organized as if they were put in single level directories (groups) by the MP3/JPEG Navigation of this unit. (pg. 52)

File structure of a disc before starting the MP3/JPEG Navigation

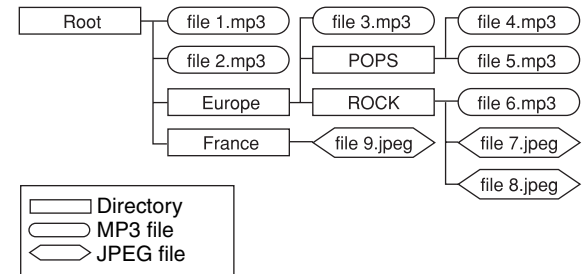

File structure of the disc after starting the MP3/JPEG Navigation

Files are automatically grouped as follows and displayed on the MP3/JPEG Navigation screen. Data is displayed in the alphabetical order of file name. Files are grouped based on roots.

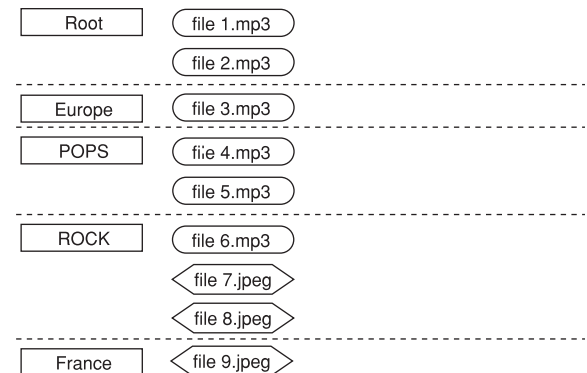

- This unit can recognize up to 9 hierarchies including directories and files.

Also, it can recognize up to 250 files in each group, and up to 99 groups on a disc.

NOTES:

- Video CD/SVCD discs that support Playback Control (PBC)**
The contents of a disc are recorded into several hierarchies, and played back according to the instructions on the screen while navigating through the hierarchies. It is also possible to playback recorded tracks consecutively without activating the PBC function even when playing a PBC-compatible disc. (pg. 26)
- Regarding the contents recorded on discs**
Some files may not be played back depending on the file types and other factors.

DVD VIDEO Marks

Sometimes marks are printed on a DVD disc and/or on its packaging to indicate information regarding the contents and functions of the disc. Check the marks indicating the contents and functions of the disc. Note, however, that in some cases a disc may not include a mark even for a function it supports.

Marks related to video

	Number of subtitles		Number of angles
	Recorded under the standard 4:3 aspect ratio		Screen includes black bands at the top and the bottom of image which has a standard 4:3 aspect ratio (letter box)
	Video playback is in Wide video mode (16:9) on wide televisions, but in letter box on televisions with standard 4:3 aspect ratio.		
	Video playback is in Wide video mode (16:9) on wide televisions, but pan and scan is used on televisions with standard 4:3 aspect ratio (either the left or right side of the image is cut-out).		

Marks related to audio

	Number of audio tracks
	Dolby Digital mark It has been developed by Dolby Laboratories as a digital surround system.
	DTS (Digital Theater Systems) You can enjoy DTS audio if you connect an amplifier with a built-in DTS decoder to the DIGITAL OUT connector of the unit.

Placing A Disc

Opening the disc tray

Press to open the disc tray.

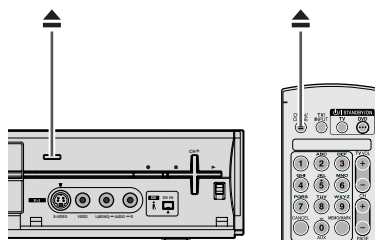

- Pressing the button again closes the disc tray.
- Use the button to open and close the disc tray.
- Do not block the disc tray with your hand while it is opening or closing as this may result in hardware failure.
- Do not place unplayable discs or any object other than a disc on the disc tray.
- Do not press down strongly on the disc tray or place any heavy objects on it.

Discs without cartridges

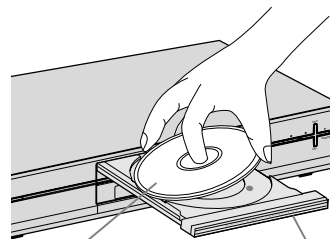

Label side facing up

Disc tray

Place the disc on the disc tray with the label side facing up. Since disc size changes depending on the disc to be played back, be sure to correctly align the disc with the grooves for its size. If the disc is not in its groove, it may be scratched or otherwise damaged. To insert an 8 cm disc, place it according to the inner groove.

DVD-RAM discs contained in cartridges

Double-sided discs:

Remove the disc from the cartridge. Align the disc with the grooves on the disc tray as shown in the illustration and insert with the side you wish to play back or record facing down. If you insert the disc with "Side A" facing down, programs are recorded on side A.

Single-sided discs:

Remove the disc from the cartridge. Align the disc with the grooves on the disc tray as shown in the illustration and insert with the label side facing up.

Care And Handling Of Discs

How to handle discs

When handling a disc, do not touch the surface of the disc. Since discs are made of plastic, they are easily damaged. If a disc gets dirty, dusty, scratched or warped, the images and sound will not be picked up correctly, and such a disc may cause the unit to malfunction.

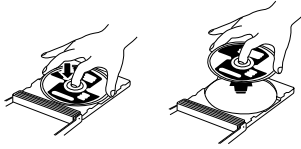

Label side

Do not damage the label side, stick paper to or use any adhesives on its surface.

Recording side

Make sure that discs are not scratched and dirty on the recording side before use. Scratches and dirt on the recording side of a disc may hinder proper playback and recording. Also be careful that a DVD-RAM disc may get scratched or dirty when removed from cartridge then put back in after use.

Storage

Make sure that discs are kept in their cases. If discs are piled on top of one another without their protective cases, they can be damaged. Do not put discs in a location where they may be exposed to direct sunlight, or in a place where the humidity or temperature is high. Avoid leaving discs in your car!

Maintenance of discs

If there are fingerprints or other dirt adhering to a disc, wipe with a soft dry cloth, moving from the centre outwards.

If a disc is difficult to clean, wipe with a cloth moistened with water. Never use record cleaners, petrol, alcohol or any anti-static agents.



CAUTION:

Sometimes during playback, noise may appear or images may be garbled. This is sometimes due to the disc. (It may not be up to industry standards.)

These symptoms are caused by the discs, not by the malfunction of the unit.

Front View

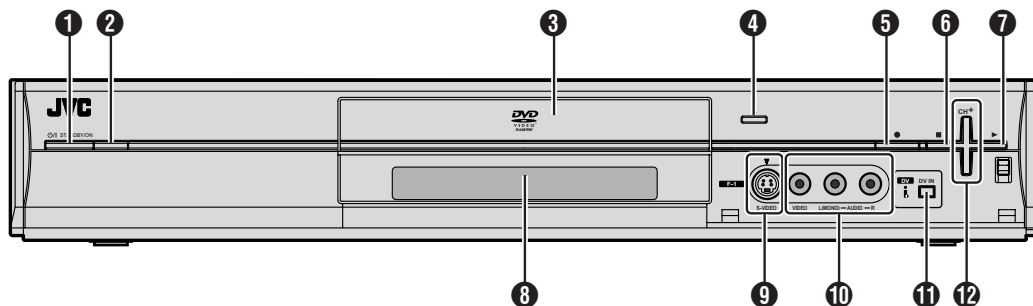

- 1 Standby/On Button (STANDBY/ON ϕ /I)
- 2 Infrared Beam Receiving Window
- 3 Disc tray
- 4 Eject Button (\blacktriangle)
- 5 Record Button (\bullet)
- 6 Stop Button (\blacksquare)
- 7 Play Button (\blacktriangleright)

- 8 Front Display Panel
- 9 S-video Input Connector [S-VIDEO]
- 10 Video/Audio Input Connectors [VIDEO/AUDIO (L(MONO)/R)]
- 11 DV Input connector [DV IN (i.Link*)]
- * i.Link refers to the IEEE1394-1995 industry specification and extensions thereof. The i.Link logo is used for products compliant with the i.Link standard.
- 12 Channel Buttons (CH +/-)

To access covered connectors, press PUSH-OPEN to open the cover.

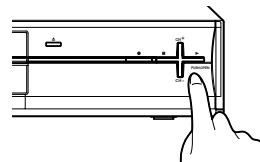

Rear View

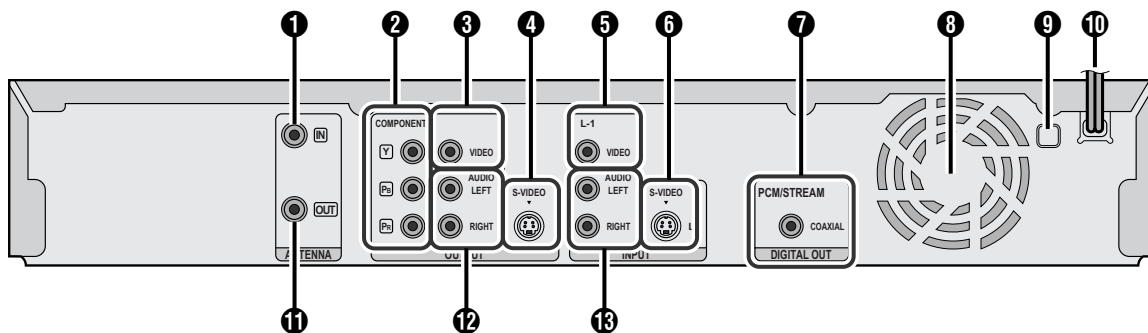

- 1 Antenna Input Connector [ANTENNA IN]
- 2 Component Video Output Connectors [COMPONENT VIDEO OUT (Y/P_B/P_R)]
- 3 Video Output Connector [VIDEO OUTPUT]
- 4 S-video Output Connector [S-VIDEO OUTPUT]
- 5 Video Input Connector [VIDEO INPUT L-1]
- 6 S-video Input Connector [S-VIDEO INPUT L-1]
- 7 Digital Audio Output Connector [DIGITAL OUT (COAXIAL)]
- 8 Cooling Fan

- This prevents the temperature from rising inside the unit. Do not remove it.
- Install the unit so as not to block the area around the fan.
- The unit may become hot when it is turned off, as the cooling fan on the rear of the unit is not activated. However, the cooling fan may be activated in the following cases;
 - In the Automatic Satellite Program Recording standby mode (pg. 42).
 - When "AUTO CLOCK" is set to "ON" (pg. 19). (Set "AUTO CLOCK" to "OFF" if you mind the noise of the fan.)

- 9 Region Number
- 10 AC Power Cord
- 11 Antenna Output Connector [ANTENNA OUT]
- 12 Audio Output Connector [AUDIO OUTPUT]
- 13 Audio Input Connector [AUDIO INPUT L-1]

Front Display Panel

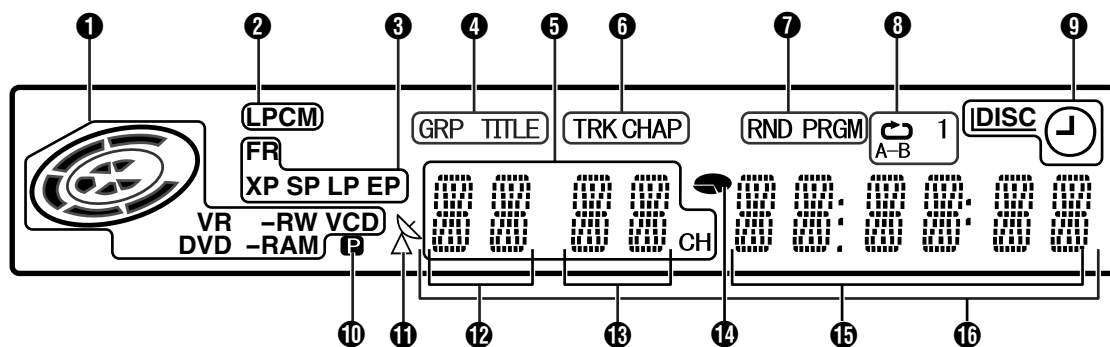
**1 Disc Type Indicator**

When a disc is loaded, the type of the disc is indicated.

Disc Status Indicator

When a disc is running, the disc marks rotate.

During High-Speed Search:

Rotate faster than normal playback.

During Slow Motion:

Rotate slower than normal playback.

While recording:

Inner red ring lights in the same way as normal playback.

During Instant Timer Recording (ITR), inner red ring slowly blinks.

While paused:

Disc marks blink when either recording or playing back.

While stopped:

Disc marks all light.

While resume stopped:

Disc marks all blink.

While the disc tray opened:

Disc marks all light out.

No disc on the disc tray:

Disc marks all light out.

VR Mode Indicator (VR) **pg. 63**

Lights when a DVD-RW disc is formatted in VR mode.

2 Linear PCM Indicator (LPCM)

Lights when "XP MODE REC AUDIO" is set to "LINEAR PCM" (pg. 59) for recording with DVD-RAM, DVD-R and DVD-RW discs, and when Linear PCM audio is played.

3 Recording Mode Indicator (XP/SP/LP/EP/FR) **pg. 34**

Blinks when recording mode is being set.

While "FR" is blinking, the left 3 digits of the Multi Display (**12**) indicate setting values ranging from "60" to "480". After the value has been set, only "FR" lights.

4 Group/Title Indicator (GRP/TITLE)

"GRP" or "TITLE" lights depending on a disc loaded while the left 2 digits of the Multi Display (**12**) indicate the numbers explained below.

"GRP": Total number of groups or group number being played back are displayed on the Multi Display.

"TITLE": Total number of titles or title number being played back are displayed on the Multi Display.

5 Channel Indicator

Indicates the channel received.

6 Track/Chapter Indicator (TRK/CHAP)

"TRK" or "CHAP" lights depending on a disc loaded while the 3rd and 4th digits from the left of the Multi Display (**13**) indicate the numbers explained below.

"TRK": Total number of tracks or track number being played back are displayed on the Multi Display.

"CHAP": Chapter number being played back are displayed on the Multi Display.

7 Random/Program Playback Mode Indicator (RND/PRGM) **pg. 33**

"RND": Lights when Random Playback mode is set.

"PROG": Lights when Program Playback mode is set.

8 Repeat Mode Indicator (A-B/1) **pg. 30, 31**

Select Repeat Playback mode on the on-screen bar.

"A-B": Whole disc is played back repeatedly.

"1": A single title/chapter/track is played back repeatedly.

"A-B": The selected part (A-B) is played back repeatedly.

No display: Repeat Playback mode is off.

9 DISC Timer Indicator **pg. 39**

DISC: Lights when a disc set up for On-Disc Timer Programming is loaded.

: Lights when timer recording other than On-Disc Timer Programming is on stand-by or being executed.

DISC : Lights when On-Disc Timer Programming is on stand-by or being executed.

: Blinks quickly if you press **TIMER** in the following cases;

- Disc is not loaded.
- Clock has not been set.
- There is no program setting.

10 Video Output Indicator (P) **pg. 60**

No display: Indicates that interlace mode is engaged.

P: Indicates that progressive mode is engaged.

(Example) **P** lights when video output mode is in progressive mode.

11 Automatic Satellite Program Recording Indicator **pg. 42**

Lights when the unit is in the Auto Satellite Program Recording standby mode.

12 Group/Title Number Display**13 Track/Chapter Number Display****14 Remaining Time/Elapsed Time Display** **pg. 25, 35**

Lights when remaining time of DVD-RAM, DVD-R and DVD-RW discs is displayed, and lights out when elapsed time is displayed.

The right 6 digits of the Multi Display (**15**) indicate elapsed or remaining time of each track.

No display: Indicates elapsed time of the disc.

Displayed: Indicates remaining time of the disc.

15 Remaining Time/Elapsed Time Display **pg. 25, 35****16 Multi Display**

Displays clock, received channel, elapsed time, and remaining time.

Also displays status of the unit.

Remote Control

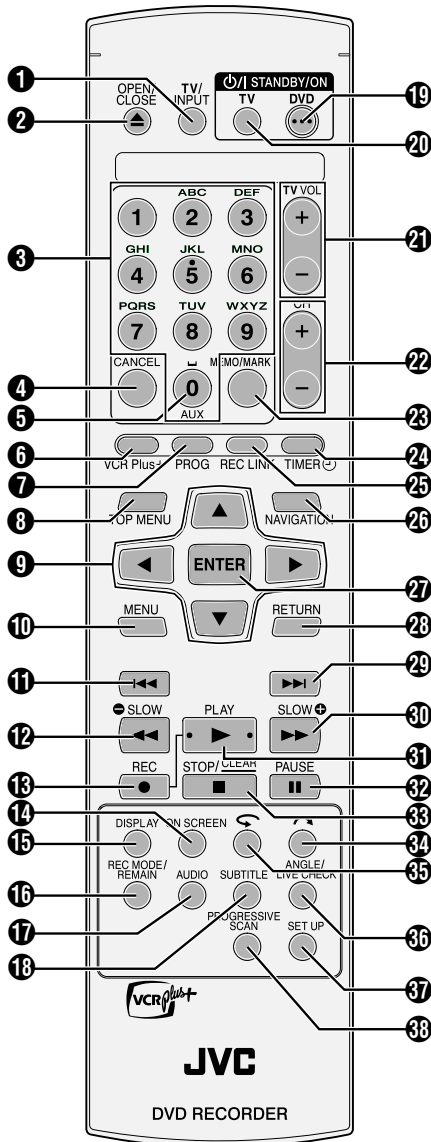

- 17 Audio Button (AUDIO) ☞ pg. 26
- 18 Subtitle Button (SUBTITLE) ☞ pg. 25
- 19 DVD STANDBY/ON Button (DVD ϕ /I) ☞ pg. 40
- 20 TV STANDBY/ON Button (TV ϕ /I)
For turning on/off the power of a JVC TV.
- 21 TV Volume Buttons (TV VOL)
For adjusting the volume of a JVC TV.
- 22 Channel Buttons (CH +/-) ☞ pg. 34
- 23 Memo Button (MEMO) ☞ pg. 44
Mark Button (MARK) ☞ pg. 25
- 24 Timer Button (TIMER) ☞ pg. 37, 38
- 25 Satellite Auto Recording Button (REC LINK) ☞ pg. 42
- 26 Navigation Button (NAVIGATION) ☞ pg. 43
- 27 Enter Button (ENTER)
- 28 Return Button (RETURN) ☞ pg. 26
- 29 Forward Skip Button (\blacktriangleright) ☞ pg. 23, 26, 29, 33
- 30 Forward Search Button (\blacktriangleright) ☞ pg. 23, 29
Forward Slow Button (SLOW +) ☞ pg. 24
- 31 Play Button (\blacktriangleright) ☞ pg. 22, 23, 28
- 32 Pause Button (\parallel) ☞ pg. 22, 29
- 33 Stop Button (\blacksquare) ☞ pg. 22
Clear Button (CLEAR) ☞ pg. 32
- 34 Skip Search Button (\curvearrowright) ☞ pg. 24, 29
- 35 One Touch Replay Button (\curvearrowleft) ☞ pg. 24, 29
- 36 Angle Button (ANGLE) ☞ pg. 25
Live Check Button (LIVE CHECK) ☞ pg. 27, 29
- 37 Set Up Button (SET UP) ☞ pg. 18, 58
- 38 Progressive Scan Button (PROGRESSIVE SCAN) ☞ pg. 32, 60

How To Use

Before use, insert two AA size batteries into the remote control with the polarity (+) and (-) matched correctly as indicated on the battery compartment or on the lid.

- Point the remote control toward the receiving window.
- The maximum operating distance of the remote control is about 8 m.

NOTE:

If the remote control doesn't work properly, remove its batteries, wait a short time, replace the batteries and then try again.

- 1 TV/INPUT Button
For switching the input of a JVC TV.
- 2 Open/Close Button (\blacktriangle)
- 3 Number Keys ☞ pg. 23, 32, 33
Character Keys ☞ pg. 46
- 4 Cancel Button (CANCEL) ☞ pg. 33
- 5 Auxiliary Button (AUX)
- 6 VCR Plus+ Button ☞ pg. 37
- 7 Program Buttons (PROG) ☞ pg. 38
- 8 Top Menu Button (TOP MENU) ☞ pg. 23
- 9 Selection Keys (\blacktriangle \blacktriangledown \blacktriangleleft \blacktriangleright)
- 10 Menu Button (MENU) ☞ pg. 23
- 11 Reverse Skip Button (\blacktriangleleft) ☞ pg. 23, 26, 29, 33
- 12 Reverse Search Button (\blacktriangleleft) ☞ pg. 23, 29
Reverse Slow Button (SLOW -) ☞ pg. 23
- 13 Record Button (\bullet) ☞ pg. 34, 35
- 14 On-Screen Button (ON SCREEN) ☞ pg. 15, 30
- 15 Display Button (DISPLAY) ☞ pg. 25, 35
- 16 Recording Mode Button (REC MODE) ☞ pg. 34, 42
Remain Button (REMAIN) ☞ pg. 25, 35

On-Screen Display

When **ON SCREEN** on the remote control is pressed, various operational indicators appear on the TV screen. To clear the operational indicators, press **ON SCREEN** twice.

When playing back a recorded title

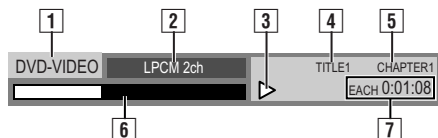

- 1 Disc type
- 2 Audio mode
- 3 Current status (playback)
- 4 Playback title number
- 5 Playback chapter number
- 6 Current playback point
- 7 Elapsed playing time

When recording

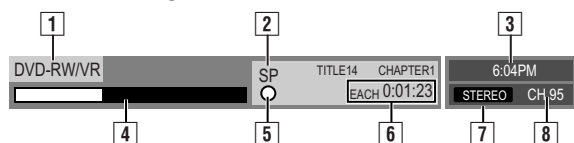

- 1 Disc type
- 2 Recording mode
- 3 Current time
- 4 Recording point
- 5 Current status (recording)
- 6 Elapsed recording time
- 7 Audio mode
- 8 Recording channel number

When pressing REC MODE:

(Appears for eight seconds.)

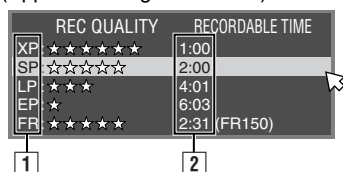

- 1 Recording mode
- 2 Remaining disc time for each recording speed

During Instant Timer Recording (ITR)

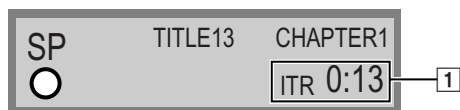

- 1 Record remaining time

When using Live Memory playback

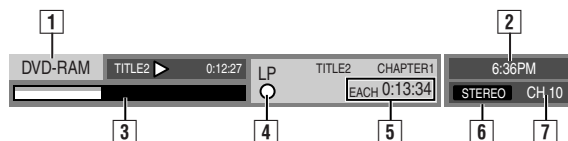

- 1 Disc type
- 2 Current time
- 3 Bar meter for recording/playback
- 4 Recording mode
- 5 Current playback time/Elapsed recording time
- 6 Audio mode
- 7 Recording channel number

DV Dubbing

When capturing images from the external DV equipment

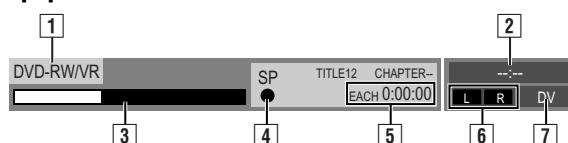

- 1 Disc type
- 2 Current time
- 3 Current recording point
- 4 Current status (recording)
- 5 Elapsed recording time
- 6 Sound mode
- 7 Recording channel (DV input)

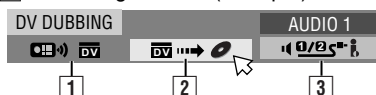

- 1 Displays when remote control is set to DV control mode.
- 2 Auto capture button
- 3 Sound monitor switch

Basic Connection

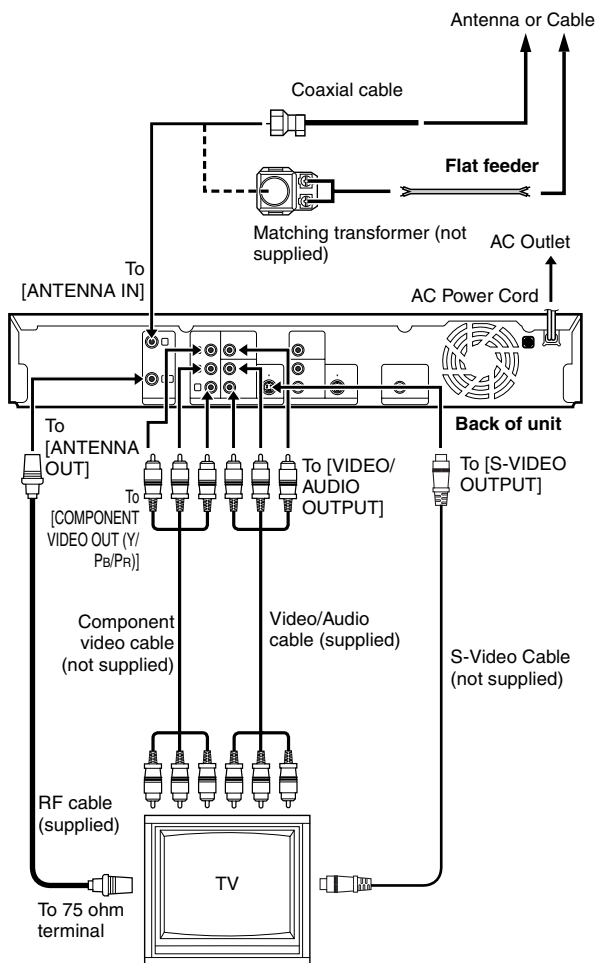

It's essential that your unit be properly connected.

ATTENTION:

Connect the AC plug only after all connections to the TV has been completed.

THESE STEPS MUST BE COMPLETED BEFORE ANY VIDEO OPERATION CAN BE PERFORMED.

- 1** Make sure the package contains all of the accessories listed in "SPECIFICATIONS" (pg. 69).
- 2** Place the unit on a stable, horizontal surface.
- 3** Connect the unit to a TV depending on the TV and cables you use.

Simple Connections

To connect to TV's VIDEO input and AUDIO input connectors —

- 1** Disconnect the TV aerial cable from the TV.
- 2** Connect the TV antenna cable to the [ANTENNA IN] connector on the rear panel of the unit.
- 3** Connect the [ANTENNA OUT] connector on the rear panel of the unit and the TV's antenna connector with the supplied RF cable.
- 4** Connect the supplied video/audio cable between the [VIDEO/AUDIO OUTPUT] connectors on the rear panel of the unit and the TV's VIDEO/AUDIO input connectors.
 - Set your TV to VIDEO mode (or an input mode such as EXT1).

S-Video Connection

To connect to TV's S-VIDEO input and AUDIO input connectors —

- 1** Perform steps **1** – **3** of "Simple Connections".
- 2** Connect the unit's [S-VIDEO OUTPUT] connector to the TV's S-VIDEO input connector.
- 3** Connect the unit's [AUDIO OUTPUT] connectors to the TV's AUDIO input connectors.
 - You can obtain a high-quality S-VHS picture.
 - If your TV is not stereo-capable, use the unit's [AUDIO OUTPUT] connectors to connect to an audio amplifier for Hi-Fi stereo sound reproduction.

Component Video Connection

To connect to TV's component video input connectors —

- 1** Perform steps **1** – **3** of "Simple Connections".
- 2** Connect the unit's [COMPONENT VIDEO OUT (Y/Pb/Pr)] connectors to the TV's component video input connectors.
- 3** Connect the unit's [AUDIO OUTPUT] connectors to the TV's AUDIO input connectors.
 - You can obtain high-quality component video pictures.
 - If your TV is not stereo-capable, use the unit's [AUDIO OUTPUT] connectors to connect to an audio amplifier for Hi-Fi stereo sound reproduction.
 - By using the component video connection, you can view the images in the progressive mode. For switching to the progressive mode, refer to "Scan Mode Set" (pg. 60).

- 4** Plug the end of the AC power cord into an AC outlet. This unit performs Plug & Play Set automatically.
 - "LOADING" blinks on the front display panel when the AC plug of the power cord is connected into an AC outlet. And it takes approximately 30 seconds for the unit to be turned on. This is not a malfunction.

NOTE:

It is necessary to connect any of above audio/video connections in addition to antenna connection with RF cable in order to view DVD playback on the TV.

Plug & Play Set

Auto Clock Set/Auto Tuner Set

This unit sets the clock and tuner channels automatically when AC power cord is first connected to an AC outlet. The antenna cable must be connected for the Plug & Play setting.

The time and date are set automatically by the clock setting data transmitted from one of the regular TV broadcast channels. We call this TV channel the "host channel" and it is a PBS channel in your area.

ATTENTION:

Depending on areas or reception conditions, the unit may not receive the Auto clock setting data from the PBS channel. If this function is taking a considerable amount of time, it may be necessary to perform the Semiauto or Manual Clock Set procedure.

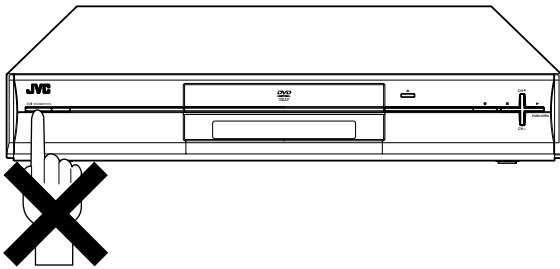

INFORMATION

- If "AUTO CLOCK" is set to "ON" (pg. 19) the clock will be adjusted automatically by the host channel using the incoming PBS channel clock setting data. (This automatic clock adjustment can only be performed when the unit is turned off.)
- If the memory backup fails, because a power outage occurs or because the AC power cord is unplugged, Plug & Play will be performed when power is restored to the unit.

What to do if Plug & Play setting failed

- If an incorrect time is displayed on the front display panel, you may be receiving the clock setting data of a PBS channel from an adjacent time zone, or an incorrect PBS channel from a cable TV system. In this case, perform "Semiauto Clock Set" (pg. 19) or "Manual Clock Set" (pg. 19).
- If " - - : - - " appears on the front display panel, your antenna cable may not be connected to the unit or there may not be a Host PBS signal available in your area. Ensure that the antenna cable is connected correctly. Then turn on and off the unit; the Plug & Play setting will be automatically reactivated. If Plug & Play setting is not performed though the antenna cable is connected correctly, perform "Manual Clock Set" (pg. 19) and "Auto Channel Set" (pg. 20) or "Manual Channel Set" (pg. 20).

- 1 Connect the antenna cable to the unit. (pg. 16) Then connect the AC power cord to an AC outlet. Do not turn on the unit. The clock and tuner channels will be set automatically.
 - "LOADING" blinks on the front display panel when the AC plug of the power cord is connected into an AC outlet and it takes approximately 30 seconds for the unit to be turned on. This is not a malfunction.

NOTES:

- Auto Clock Set is performed first. "AUTO" blinks on the front display panel during Auto Clock Set.
- Auto Channel Set is performed next. Auto Channel Set scans all the channels that are receivable by your unit. During Auto Channel Set, the channel numbers are displayed as they are scanned and set.
- When Plug & Play setting has been completed successfully, the correct clock time is displayed. If you perform Plug & Play setting successfully, there is no need to perform "CLOCK SET" (pg. 19) and "TUNER SET" (pg. 20). If, however, you want to add or delete channels, refer to "MANUAL CH SET" (pg. 20).

During Auto Clock Set

"AUTO" blinks.

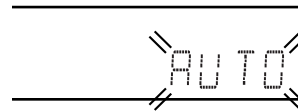

During Auto Channel Set

The channel numbers are displayed and "AUTO" blinks as they are scanned and set.

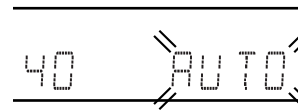

Plug & Play Completed

The current time is displayed.

- If an incorrect clock time or " - - : - - " appears on the front display panel, see "What to do if Plug & Play setting failed" on the left column.

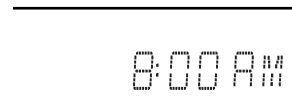

Language

- Turn on the unit.
- Turn on the TV and select an input mode such as EXT1.

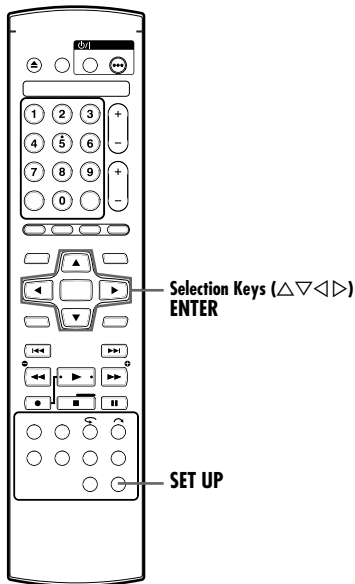

On-screen Language Set

This unit offers you the choice to view on-screen messages in 3 different languages.

- 1 Press **SET UP** to access the Main Menu screen.
- 2 Press **selection keys** to select "FUNCTION SET UP", then press **ENTER**.
- 3 Press **selection keys** to select "DISPLAY SET", then press **ENTER**.
- 4 Press **selection keys** to select "ON SCREEN LANGUAGE", then press **ENTER**.
- 5 Press **selection keys** to select your desired language, then press **ENTER**.
- 6 Press **SET UP** to complete the setting.

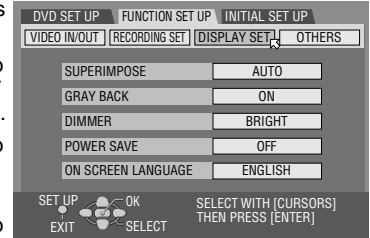

Menu/Audio/Subtitle Language Set

Some DVD discs contain the DVD menu display, audio and subtitles in multiple languages. With these discs, you can set the default language as you like.

- The procedure shows how to set "MENU LANGUAGE" as an example.

- 1 Press **SET UP** to access the Main Menu screen.
- 2 Press **selection keys** to select "DVD SET UP", then press **ENTER**.
- 3 Press **selection keys** to select "LANGUAGE SET", then press **ENTER**.

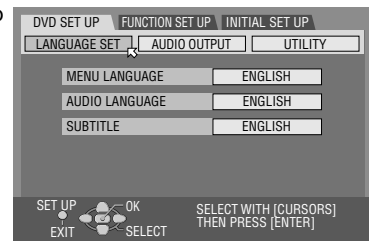

- 4 Press **selection keys** to select "MENU LANGUAGE", then press **ENTER**.
- 5 Press **selection keys** to select your desired language, then press **ENTER**.

- See "Language Code List". (pg. 68)

- 6 Press **SET UP** to complete the setting.

NOTE:

When the selected language is not available on the disc, the disc's default menu language is played back.

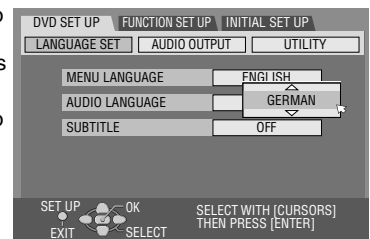

Clock Set

Perform clock setting only if the clock has not been set correctly by the Plug & Play setting.

- Turn on the unit.
- Turn on the TV and select an input mode such as EXT1.

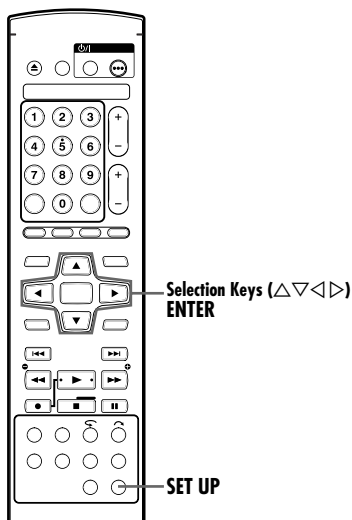

Semiauto Clock Set

You can change the host channel/D.S.T. (Daylight Saving Time)/time zone setting manually.

NOTE:

The time set previously will be erased when "AUTO CLOCK", "HOST CH [CATV]", "D.S.T." or "TIME ZONE" setting is changed.

1 Press **SET UP** to access the Main Menu screen.

2 Press **selection keys** to select "INITIAL SET UP", then press **ENTER**.

3 Press **selection keys** to select "CLOCK SET", then press **ENTER**.

4 Press **selection keys** to select "AUTO CLOCK", then press **ENTER**. Press **selection keys** to select "ON", then press **ENTER**.

5 Press **selection keys** to select "HOST CH [CATV]", then press **ENTER**.

Press **selection keys** to select "AUTO" or the desired PBS channel number, then press **ENTER**.

NOTE:

Some PBS channels do not transmit clock setting data.

6 Press **selection keys** to select "D.S.T.", then press **ENTER**. Press **selection keys** to select the desired setting, then press **ENTER**.

AUTO: Select if you want to adjust your unit's clock automatically by the incoming signal from the host channel. Be sure to select the correct time zone manually in step 7.

ON: Adjustment will be made by the built-in clock itself.

OFF: Select when Daylight Saving Time does not apply to you.

7 Press **selection keys** to select "TIME ZONE", then press **ENTER**. Press **selection keys** to select "AUTO" or the desired time zone, then press **ENTER**.

Each time you press **selection keys**, the time zone changes as follows:

→AUTO→ATLANTIC→EASTERN→CENTRAL→MOUNTAIN
→PACIFIC→ALASKA→HAWAII→(back to the beginning)

NOTE:

If an incorrect time is displayed by the Plug & Play function, you may be receiving the clock setting data of a PBS channel from an adjacent time zone or from an incorrect PBS channel from a cable TV system. If you selected "AUTO" for the host channel in step 5, be sure to select the correct time zone manually.

8 Press **SET UP** to end.

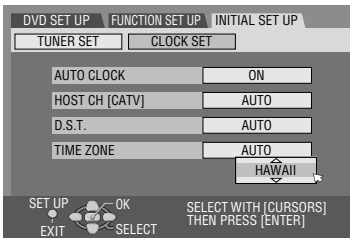

IMPORTANT:

Turn off the unit after performing Semiauto Clock. "AUTO" will appear on the front display panel while the clock is being set. The current clock time will appear automatically when the clock setting is completed.

AUTO DAYLIGHT SAVING TIME

This function enables automatic adjustment of the unit's clock at the start and end of Daylight Saving Time.

With DST set to "ON"—

— on the first Sunday of April at 2:00 AM, the clock is adjusted to 3:00 AM.

— on the last Sunday of October at 2:00 AM, the clock is adjusted to 1:00 AM.

NOTE:

Timer recording may not function correctly at the time Daylight Saving Time is adjusted.

Manual Clock Set

1 Press **SET UP** to access the Main Menu screen.

2 Press **selection keys** to select "INITIAL SET UP", then press **ENTER**.

3 Press **selection keys** to select "CLOCK SET", then press **ENTER**.

4 Press **selection keys** to select "AUTO CLOCK", then press **ENTER**. Press **selection keys** to select "OFF", then press **ENTER**.

5 Press **selection keys** to select "TIME", then press **ENTER**. Press **selection keys** until the desired time appears, then press **ENTER**.

- The confirmation screen appears.

6 Press **selection keys** to select "OK", then press **ENTER** for confirmation.

7 Set "DATE" and "YEAR" in the same way as in step 5.

- Holding Δ▽ changes the time in 30-minutes interval, or changes the date in 15-days interval.

8 Press **selection keys** to select "D.S.T.", then press **ENTER**. Press **selection keys** to select the desired setting, then press **ENTER**.

ON: Adjustment will be made by the built-in clock itself.

OFF: Select when Daylight Saving Time does not apply to you.

9 Press **SET UP** to complete the setting.

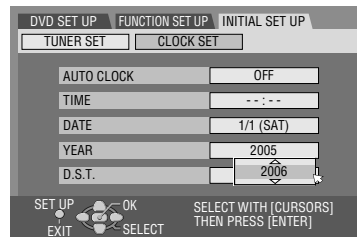

Tuner Set

- Turn on the unit.
- Turn on the TV and select an input mode such as EXT1.

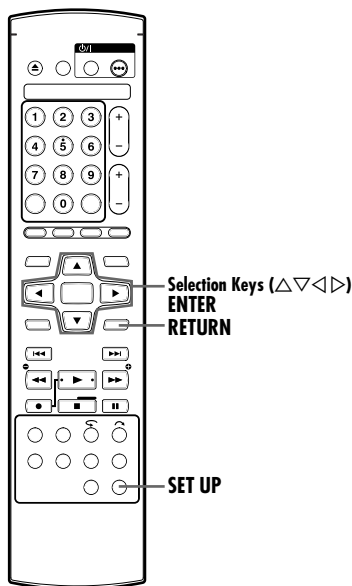

NOTE:

The unit selects the correct band (TV or CATV) automatically during Auto Channel Set. The selected band will be displayed on the right side of "BAND" on the Tuner Set screen.

Auto Channel Set

Perform Auto Channel Set only if channels have not been set correctly by the Plug & Play setting.

- 1 Press **SET UP** to access the Main Menu screen.
- 2 Press **selection keys** to select "INITIAL SET UP", then press **ENTER**.
- 3 Press **selection keys** to select "TUNER SET", then press **ENTER**.
- 4 Press **selection keys** to select "AUTO CH SET", then press **ENTER**.
 - You can automatically set the receivable channels in your area in the order of their frequencies.
 - When Auto Channel Set is completed, "SCAN COMPLETED" appears on screen.
 - If the scan was unsuccessful, "SCAN COMPLETED-NO SIGNAL-" appears on screen. Check the connections and start again.

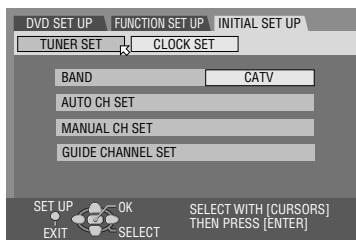

Manual Channel Set

You can add the channels you want or delete the channels you do not want manually.

- 1 Press **SET UP** to access the Main Menu screen.
- 2 Press **selection keys** to select "INITIAL SET UP", then press **ENTER**.
- 3 Press **selection keys** to select "TUNER SET", then press **ENTER**.
- 4 Press **selection keys** to select "MANUAL CH SET", then press **ENTER**.
- 5 Add or skip the desired channels.

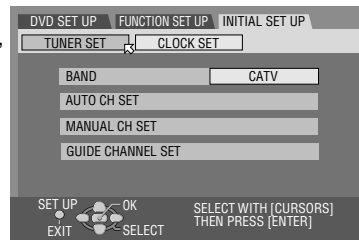

To add channels

- 1 Press **selection keys** to select "CH [CATV]", then press **ENTER**.
- 2 Press **selection keys** to select a channel number you want to add, then press **ENTER**.
- 3 Press **selection keys** to select "ADD/SKIP", then press **ENTER**.
- 4 Press **selection keys** to select "ADD", then press **ENTER**.
- 5 Repeat **1** — **4** to add other channels.

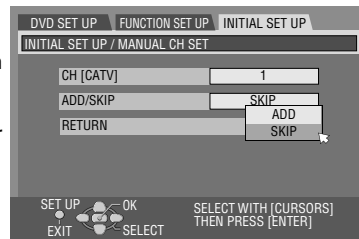

To skip channels

- 1 Press **selection keys** to select "CH [CATV]", then press **ENTER**.
- 2 Press **selection keys** to select a channel number you want to skip, then press **ENTER**.
- 3 Press **selection keys** to select "ADD/SKIP", then press **ENTER**.
- 4 Press **selection keys** to select "SKIP", then press **ENTER**.
- 5 Repeat **1** — **4** to skip other channels.
- 6 Press **SET UP** or **RETURN** twice to complete the setting.

Monitor Set

You can select the monitor type depending on the TV used when you play back DVD VIDEO discs recorded for wide-screen TVs.

- Turn on the unit.
- Turn on the TV and select an input mode such as EXT1.

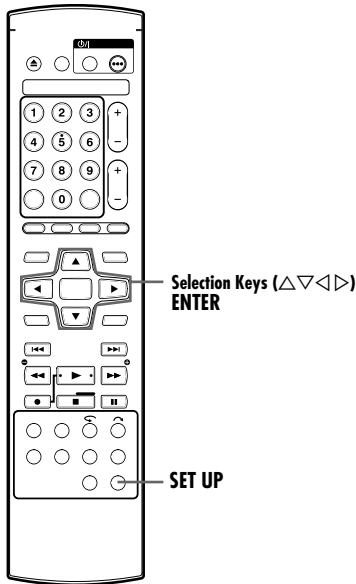

1 Press **SET UP** to access the Main Menu screen.

2 Press **selection keys** to select “FUNCTION SET UP”, then press **ENTER**.

3 Press **selection keys** to select “VIDEO IN/OUT”, then press **ENTER**.

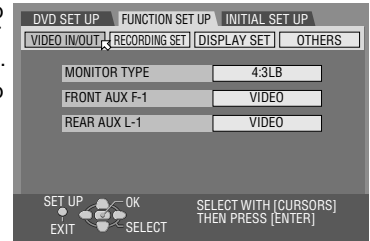

4 Press **selection keys** to select “MONITOR TYPE”, then press **ENTER**.

5 Press **selection keys** to select the desired setting, then press **ENTER**.

6 Press **SET UP** to complete the setting.

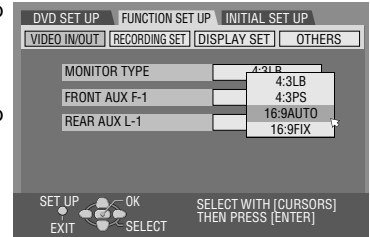

* The **boldface** settings in the table below indicate the settings at your purchase.

■ MONITOR TYPE — **4:3LB** / 4:3PS / 16:9AUTO / 16:9FIX

4:3LB (Letter Box conversion):

Select this when the aspect ratio of your TV is 4:3 (conventional TV). While viewing a wide screen picture, the black bars appear on the top and the bottom of the screen.

4:3PS (Pan&Scan):

Select this when the aspect ratio of your TV is 4:3 (conventional TV). While viewing a wide screen picture, the black bars do not appear; however, the left and right edges of the pictures will not be shown on the screen.

16:9AUTO (Wide television conversion):

Select this when the aspect ratio of your TV is 16:9 (wide TV).

16:9FIX (Wide television conversion):

Select this when the aspect ratio of your TV is fixed to 16:9 (wide TV). The unit automatically adjusts the screen width of the output signal correctly when playing back a picture whose aspect ratio is 4:3.

Pan&Scan/Letter Box

In general, DVD VIDEO disc are produced for a wide-screen TV with 16:9 aspect ratio.

Material with this ratio will not fit to a TV with 4:3 aspect ratio. There are two styles to display the image, “Pan&Scan” (PS) and “Letter Box” (LB).

Pan&Scan

The right and left side of the image are cut off. The image fills the screen.

- The picture will be shown in the “4:3LB” mode depending on the disc even if the “4:3PS” is selected.



Letter Box

Black bands appear at the top and bottom of the image. The image itself appears in 16:9 aspect ratio.



Basic Playback



- Turn on the unit.
- Turn on the TV and select an input mode such as EXT1.

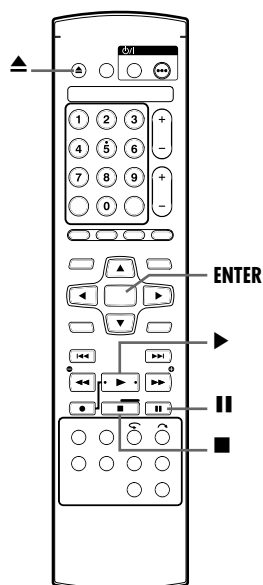
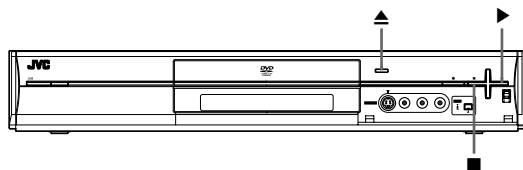

ATTENTION:

- It takes approximately 30 seconds to read a disc depending on the type and condition of the disc since this unit is multi-disc compatible (DVD-RAM, DVD-RW, DVD-R). It may even take several minutes when a disc is dirty, scratched or warped.
- It may take a few seconds to start playback. This is not a malfunction.
- Forward/reverse high-speed search and other operations cannot be performed while playback is stopped.

To play back an MP3/JPEG disc, see “Playback With MP3/JPEG Navigation” (pg. 52).

- 1 Load a disc.
 - For details, refer to “Placing A Disc” (pg. 10).
 - Pressing ▲ also closes the disc tray.
 - Playback begins automatically if an auto-playback DVD disc is loaded.
- 2 Press ► to start playback.
 - If you load a DVD disc whose region code does not match the unit, “REGION CODE ERROR CHECK DISC” appears on the TV screen. For details, refer to “Region Number” (pg. 8).
 - With Video CD/SVCD discs with PBC control or some DVD discs, the menu display may appear on the TV screen after starting playback. In this case, select an item which you want to play back from the menu. For details, refer to “Playback Control (PBC) Function” (pg. 26) or “Locating A Desired Scene Using The DVD Menu” (pg. 23).
 - The Library Database Navigation also enables you to search and scan the beginning of the desired titles. (pg. 44)
- 3 Press || to pause playback.
 - To resume normal playback, press ►.
- 4 Press ■ to stop playback.
 - When a recordable disc is played, playback stops and a program received with the unit’s tuner resumes on the TV screen.
 - When a playback-only disc is played, playback stops and the TV screen becomes all blue when you press ■. Pressing ■ again resumes a program received with the unit’s tuner.
 - If ▲ is pressed during playback, playback stops, then the disc tray opens.

NOTE:

When the Library Database Navigation screen appears, choose a thumbnail image of the desired title on the TV screen, then press ENTER. (pg. 44)

Playback Features

- Turn on the unit.
- Turn on the TV and select an input mode such as EXT1.

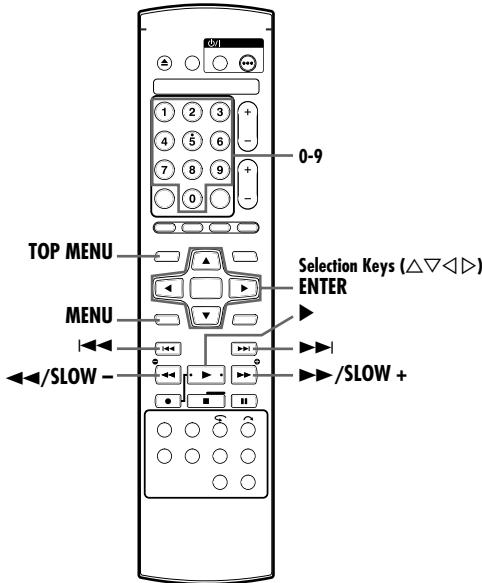

Locating A Desired Scene Using The DVD Menu



DVD VIDEO discs may have top menu and disc menu.

Top menu

DVD discs generally have their own menus which show the disc contents. These menus contain various items such as titles of a movie, names of songs, or artist information. You can locate a desired scene by using the top menu displayed on the TV screen. Press **TOP MENU** to access the top menu.

Disc menu

Disc menus include playback data (angle menu, subtitle menu, etc.) specific to each title. Press **MENU** to access the disc menu.

1 Press **TOP MENU** or **MENU** to access the DVD menu.

2 Press **selection keys** to select the desired title, then press **ENTER**. The playback starts.

- It may be possible to select the desired item using the number keys depending on the menu display.

Example:

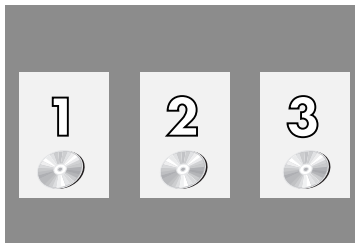

NOTE:

When "⊖" appears on the TV screen in step 1, the disc does not have a top menu or disc menu.

Locating The Start Point Of The Item Or Skip The Item



Press **◀◀** or **▶▶** during playback.

- Pressing **▶▶** locates the start point of the title (or track) or skips to the marked point in the forward direction, then resumes playback.
- Pressing **◀◀** locates the start point of the title (or track) or skips to the marked point in the reverse direction, then resumes playback.

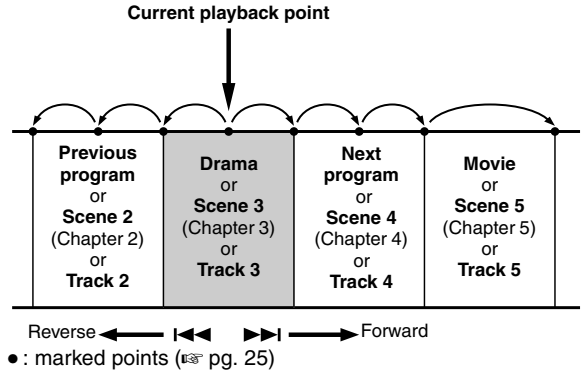

Variable Speed Search



During playback, press **▶▶** for forward variable speed search, or **◀◀** for reverse variable speed search.

- Each press of the button increases the search speed for each direction.
- To resume normal playback, press **▶**.

OR

During playback, press and hold **▶▶** for 2 or more seconds for forward variable speed search, or press and hold **◀◀** for 2 or more seconds for reverse variable speed search.

- Releasing the button resumes normal playback.

Still Picture/Frame-By-Frame Playback



1 Press **⏸** to pause during playback.

2 Press **⏸** to activate frame-by-frame playback.

- Each press of the button advances the still picture frame by frame.

OR

Press **<** or **>** to activate frame-by-frame playback.

- Each press of **<** or **>** advances/reverses the still picture frame by frame.
- Frame-by-frame playback for reverse direction cannot be performed with Video CD/SVCD discs.
- To resume normal playback, press **▶**.

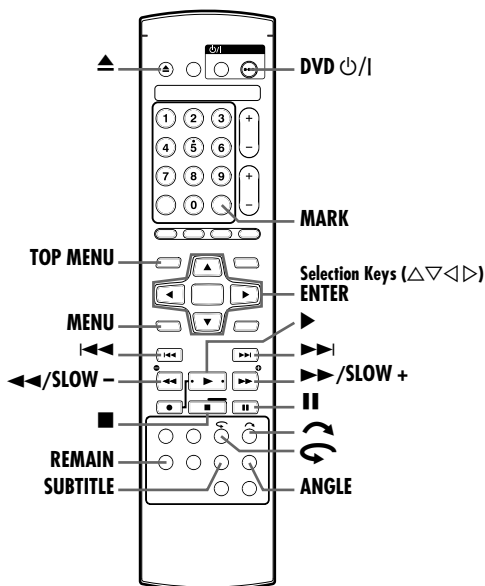

Slow Motion



1 Press **II** to pause during playback.

2 Press **SLOW -** (\triangleleft), then press **SLOW +** (\triangleright).

- Each press of **SLOW -** (\triangleleft) or **SLOW +** (\triangleright) increases the slow motion speed for each direction.
- Slow motion for reverse direction cannot be performed with Video CD/SVCD discs.

OR

Press and hold \triangleleft or \triangleright for 2 or more seconds.

- Releasing the button resumes normal playback.

Skip Search



Press \curvearrowright during playback.

- Each press initiates an approximately 30 second period of fast-motion playback. Normal playback resumes automatically.
- This function is not possible when playing back a Video CD using the PBC function.

One Touch Replay



You can move back the playback position slightly.

Press \curvearrowleft .

- Each press skips back for approximately 7 seconds and resumes playback.
- Pressing while paused skips back for approximately 7 seconds and resumes pause.
- This function is not possible when playing back a Video CD using the PBC function.

Resume Function



It is possible to memorize the position where you stop playback and resume playback from that position.

- Be sure to set "RESUME" to "ON" or "DISC RESUME". (see pg. 60)

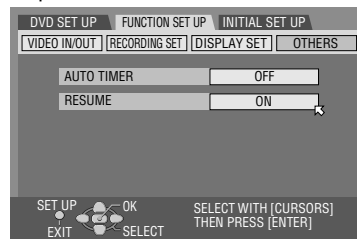

ATTENTION:

When a playback-only disc is played, pressing \blacksquare once results in a blue screen. To perform Resume Function with these discs, follow the procedures as described below under the blue screen condition.

- 1 Press \blacksquare during playback to memorize a resume point.
 - The unit enters Resume Stop mode and memorizes the position where you have stopped playback as a resume point. (The inside of the disc status indicator on the front display panel blinks while memorizing.)
 - The unit retains a memory of the resume points of the last 30 discs played back, even though they have been ejected if "RESUME" is set to "DISC RESUME". (see pg. 60)
 - To clear the resume points: (The inside of the disc status indicator stops blinking and lights.)
 - When "RESUME" is set to "ON":**
 - Press **DVD \odot /I** to turn off the unit.
 - Press \blacktriangle to take out the disc.
 - Press \blacksquare in stop mode.
 - Press **TOP MENU** to display the top menu, then start playback by selecting an item, etc.
 - Press **MENU** to display the disc menu, then start playback by selecting an item, etc.
 - When "RESUME" is set to "DISC RESUME":**
 - "RESUME" must be set to "OFF". (see pg. 60)
 - Press \blacksquare in stop mode.
 - Press **TOP MENU** to display the top menu, then start playback by selecting an item, etc.
 - Press **MENU** to display the disc menu, then start playback by selecting an item, etc.
- 2 Press \blacktriangleright in stop mode to resume playback. The unit starts playback from the resume point.

NOTES:

- "DISC RESUME" setting works on DVD VIDEO, VCD, SVCD and finalized DVD-R/DVD-RW (Video mode) discs. For other types of discs, the function under "ON" setting will be applied even if "RESUME" is set to "DISC RESUME". (see pg. 60)
- If you stop the playback of a disc for which a resume point has already been memorized, the memory will be updated with the new resume point.
- After the unit has memorized the resume points for 30 discs, remembering a new resume point will cause the unit to delete the oldest memorized point. Stopping playback of a disc for which a resume point is already stored may change the order in which the points are stored. This may potentially change the order in which points are deleted.
- When the unit memorizes a resume point for a disc, it also remembers audio language, subtitle and angle settings.
- This function may not work for some Video CD/SVCDs.
- When "RESUME" is changed to "ON" or "OFF" (see pg. 60), resume points of the discs memorized with "RESUME" set to "DISC RESUME" will be cleared.
- Resume points are memorized for each side of a double-sided disc.

Marking Positions To Play Back Again Later



It is possible to mark positions (up to 999 points) where you want to play back once again later, and start playback from a marked position.

To mark positions:

During playback, press **MARK** at positions you want to mark.

- “MARK” is displayed on the TV screen. You can easily locate the marked positions using ◀◀ or ▶▶ when you play back the disc.

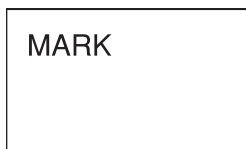

To delete the marked positions:

While paused, press ◀◀ or ▶▶ to locate a marked position you want to delete, then press **MARK**.

- Crossed “MARK” appears on the TV screen, and the marked position is deleted.



NOTES:

- When a monaural program changes to a stereo program while recording, a mark signal is automatically recorded.
- When a DVD-R/RW (Video mode) disc is finalized, marked points that are marked at the desired locations during playback are deleted and new marks are assigned automatically approximately every 5 minutes. (pg. 64)
- If **MARK** is pressed when playing back a disc that does not allow marks to be inserted, “⊘” appears on the TV screen.

Checking The Time Information



You can check time information of a disc on the front display panel and the TV screen.

Each press of **DISPLAY** changes the display as follows:

■ DVD-RAM/DVD-R/DVD-RW

During recording/playback or in stop mode

Clock time → Current title elapsed time → Disc remaining time → (back to the beginning)

- The clock time is displayed on the front display panel only.
- The clock time and disc remaining time will not be displayed when playing back finalized DVD-R/RW discs.

In stop mode or during playback

- It is possible to check disc remaining time according to recording modes also by pressing **REMAIN**.
- In FR mode, it is possible to set recording time in detail. While the recording mode and the disc remaining time are displayed by pressing **REMAIN**, press **selection keys** to select “FR”, then select the desired recording time. (pg. 36)
- It is not possible to switch the recording mode during playback or while recording.

■ Video CD/SVCD/Audio CD

During Playback or in stop mode

Current track elapsed time → Current track remaining time → Total elapsed time → Total remaining time → (back to the beginning)

NOTE:

When a PBC-compatible Video CD/SVCD disc is loaded, deactivate the PBC function. (pg. 26)

Angle Selection



You can enjoy a variety of scene angles if a DVD VIDEO disc contains “multi-angle” parts, where the same scene was shot from different angles.

If the disc contains “multi-angle” parts, “⊞” appears on the TV screen at the beginning of the “multi-angle” part.

- 1 Press **ANGLE** during playback. The angle selection display appears on the TV screen.



When 3 scene angles are contained.

- 2 Press **ANGLE** or **selection keys** to select your desired angle.

- Each time you press **ANGLE** or the **selection keys**, the angle changes.
- When “⊘” appears on the TV screen, the current scene is not recorded from multiple angles. In addition, some discs prohibit angle selection.
- To clear the angle selection display, press **ENTER**. In addition, the angle selection display disappears automatically if no operation is done for 5 seconds.

Subtitle Selection



Some DVD VIDEO discs contain more than one subtitle language, from among which you can choose the desired subtitle language. “⊞” appears on the TV screen at the beginning of the part where more than one subtitle language are recorded.

- 1 Press **SUBTITLE** during playback. The subtitle selection display appears on the TV screen.



When 3 subtitle languages are contained.

- Each time you press **SUBTITLE**, the subtitle display is switched on and off.

- 2 Press **selection keys** to select your desired language.

- To clear the subtitle selection display, press **ENTER**.

NOTES:

- For disc that does not contain subtitle language, the number of selectable languages will not be displayed. “-/-” appears on the TV screen.
- When the subtitle language won't be changed with the procedure above, change the subtitle on a disc menu displayed by pressing **MENU**.

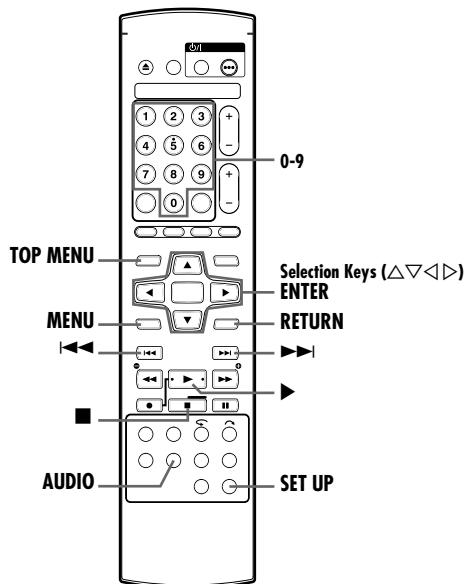

Audio Channel Selection



When watching bilingual programs or playing discs on which you recorded bilingual or stereo programs, you can choose the desired audio channel.

- When “SUPERIMPOSE” is set to “AUTO”, you can confirm on the TV screen the audio channel you have chosen. (pg. 59)
- Each time you press **AUDIO**, the audio channel changes.



TRACK	USE
On-Screen Display	
	For stereo discs
	For audio of left channel
	For audio of right channel

When you can't switch the audio channel of a bilingual program

When the unit is connected with a digital audio device using an optional coaxial cable and “DIGITAL AUDIO OUT” is set to “DOLBY DIGITAL/PCM”, it is not possible to switch the audio channel of a bilingual program recorded on a DVD-RAM or DVD-RW (VR mode) disc. (pg. 58). In this case, perform the following steps using the remote control to switch “DIGITAL AUDIO OUT” from “DOLBY DIGITAL/PCM” to “PCM ONLY”.

- 1 Press **SET UP** to access the Main Menu screen.
- 2 Press **selection keys** to select “DVD SET UP”, then press **ENTER**.
- 3 Press **selection keys** to select “AUDIO OUTPUT”, then press **ENTER**.
- 4 Press **selection keys** to select “DIGITAL AUDIO OUT”, then press **ENTER**.
- 5 Press **selection keys** to select “PCM ONLY”, then press **ENTER**.
- 6 Press **SET UP** to complete the setting.
- 7 Press **AUDIO** to select the desired audio channel.

Audio Language/Sound Selection



Some DVD VIDEO discs contain the multiple audio language or sound. You can select the desired audio language or sound. For some Video CD/SVCD discs, you can switch the audio channel to choose Karaoke either with or without the vocal.

- 1 Press **AUDIO** during playback.

The Audio Language/Sound selection display appears on the TV screen.

For Example: DVD VIDEO



- 2 Press **AUDIO** or **selection keys** to select your desired audio language/sound.

- Each time you press **AUDIO** or the **selection keys**, the audio language/sound changes.
- To clear the Audio Language/Sound selection display, press **ENTER**.

When 3 audio languages are contained.

NOTES:

- When “” appears on the TV screen, no audio language is recorded.
- When the audio language won't be changed with the procedure above, change the audio on a disc menu displayed by pressing **MENU**.
- Pressing **AUDIO** to select the audio language/sound is only possible during playback. It is not possible to select by pressing **AUDIO** in stop mode. However, you can select the desired audio language/sound from the setup menu while in stop mode.

Playback Control (PBC) Function



Some Video CD/SVCD discs support the PBC function. PBC is an abbreviation of “Play Back Control”. A Video CD/SVCD disc recorded with PBC has its own menus, such as a list of the songs on the disc. You can locate a specific scene by using the menu.

- 1 Press **▶** in stop mode. The PBC menu appears.

- 2 Press the **number keys** to enter the number of the desired scene, then press **ENTER**. The unit starts playback of the selected item.

- “PBC” is displayed on the front display panel.
- When “NEXT” or “PREVIOUS” appears on the TV screen: Pressing **▶▶** advances to the next page. Pressing **◀◀** returns to the previous page.
- You can return to the menu by pressing **RETURN**.
- The method of the operation is different depending on the disc.

NOTES:

- If you want to play back a PBC-compatible Video CD/SVCD disc without activating the PBC function, start playback in stop mode by using the **number keys**, instead of the **▶** button, to choose the track, then press **ENTER**.
- To activate the PBC function when a PBC-compatible Video CD/SVCD disc is being played back without the PBC function, press **■** then press **▶**.

Live Memory Playback



You can watch a recorded portion of a program even before recording ends (Live Memory Playback), or watch other programs (Simultaneous Recording and Playback) while continuing to record onto the DVD-RAM disc.

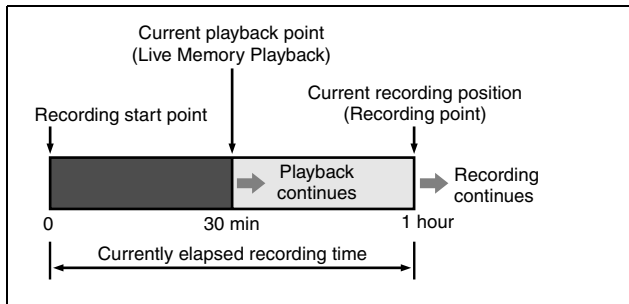
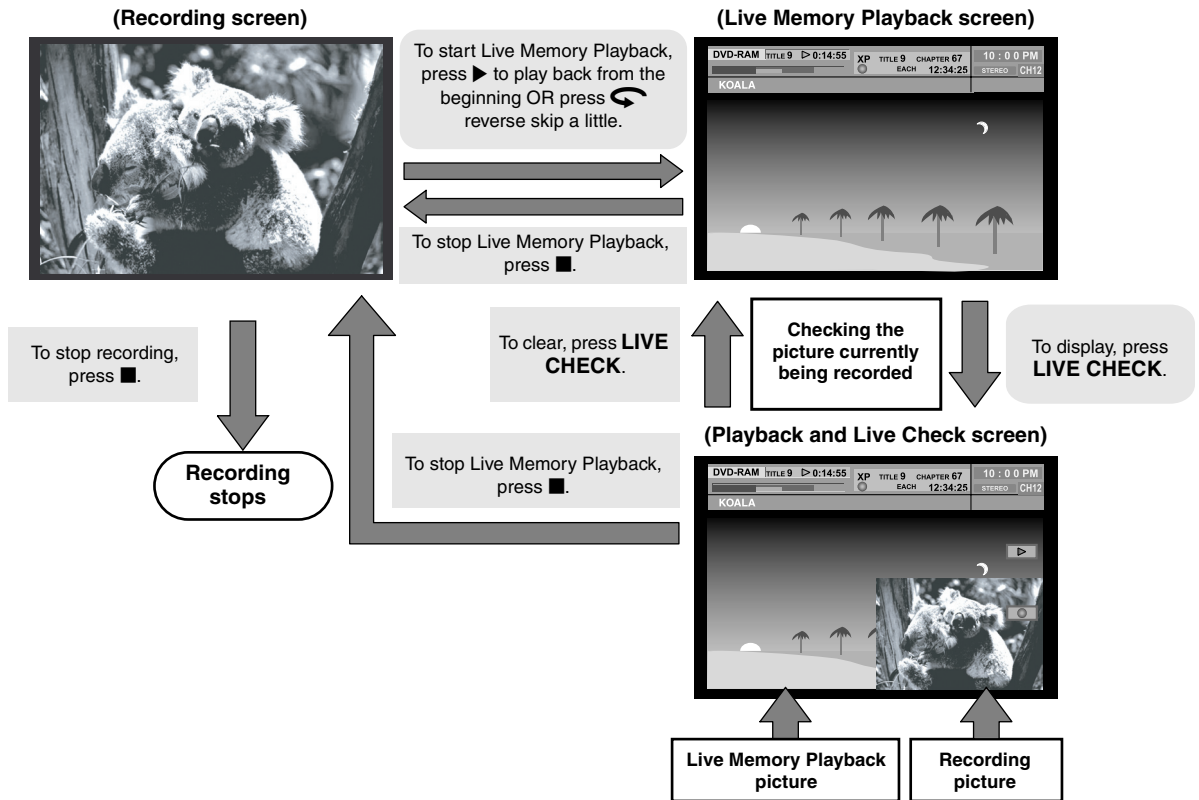

NOTES:

- Live Memory Playback could be performed approximately 30 seconds after recording has started.
- Although high-speed search up to approximately 30 seconds before the current recording point is possible during Live Memory Playback, once the current recording point is reached, the unit resumes normal playback and maintains a delay of approximately 30 seconds so that recording and playback can continue.
- When using Live Memory Playback during timer recording, the unit remains turned on and playback continues even after the end of the recording.
- When using Live Memory Playback during timer recording, playback is automatically stopped just before recording starts, and then recording starts when the time arrives for the next timer-program.
- It is impossible to perform ITR even if you press ● during Live Memory Playback. Press ■ to display the program being recorded, then perform ITR settings.
- Playback may be paused for a moment during Live Memory Playback, which does not interfere with recording.
- When **LIVE CHECK** is pressed to display the picture currently being recorded, the picture size may not be correct.
- Live Memory Playback cannot be performed while recording the source from DV input.

- Turn on the unit.
- Turn on the TV and select an input mode such as EXT1.

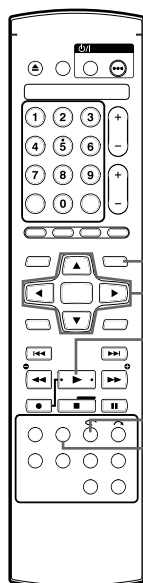
**NAVIGATION**

Selection Keys (Δ▽◀▶)
ENTER

ON SCREEN

Live Memory Playback status can be checked by pressing **ON SCREEN** to display the bar meter on the superimpose display. The current status is superimposed on the TV screen.

Bar meter display

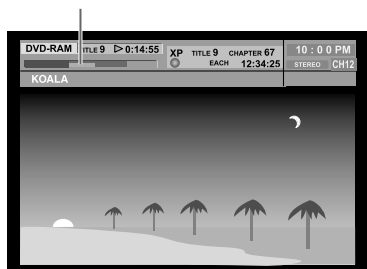

Live Memory Playback

You can playback the previous part of the channel you are recording.

To watch from the recording start point

- 1 Press **▶** during recording.

To watch from the point after reverse skipping a little during recording

- 1 Press **↶** during recording.
 - Live Memory Playback could be performed approximately 30 seconds after recording has started.
 - Pressing once skips back for approximately 7 seconds and resumes playback.

Simultaneous Recording and Playback

You can playback other programs available in the Library Database Navigation on the disc.

To watch other previously recorded programs during recording

- 1 Press **NAVIGATION** to display the Library Database Navigation screen.
- 2 Press **selection keys** to select "ORIGINAL", then press **ENTER**.
- 3 Press **selection keys** to select a desired program, then press **ENTER**.

Buttons To Be Used During Live Memory Playback

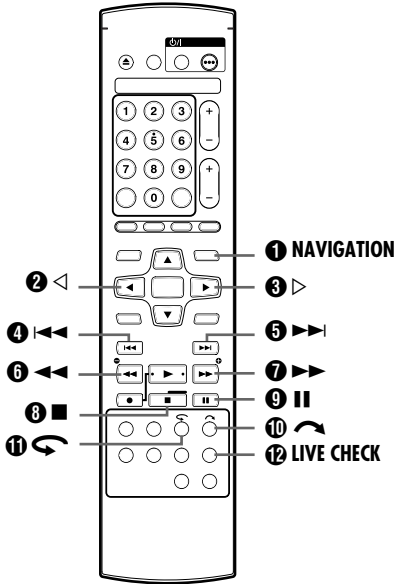

1 NAVIGATION

Displays Library Database Navigation menu. You can choose a title to play back.

2 ◀

Pressing during pause mode reverses the still picture frame by frame.

3 ▶

Pressing during pause mode advances the still picture frame by frame.

4 ◀◀

- Pressing once skips back to the beginning of the program or chapter being played back.
- Pressing down for 2 or more seconds during playback reverses playback at a faster speed. Releasing the button resumes normal playback.

Available only when paused

- Pressing down for 2 or more seconds reverses playback at a slower speed.

5 ▶▶

- Pressing once skips forward to the next program or chapter being played back.
- Pressing down for 2 or more seconds during playback advances playback at a faster speed. Releasing the button resumes normal playback.

Available only when paused

- Pressing down for 2 or more seconds advances playback at a slower speed.

6 ◀◀◀

- Each press of the button during playback advances the playback speed in 5 steps in the reverse direction.
- Pressing during pause mode reverses playback at a slower speed.

7 ▶▶▶

- Each press of the button during playback advances the playback speed in 4 steps in the forward direction.
- Pressing during pause mode advances playback at a slower speed.

8 ■

- Pressing once stops Live Memory Playback and returns to the screen on air.
- Pressing again stops the recording and returns to the screen on air.

9 ||

- Pressing once pauses playback (still picture playback).
- Pressing repeatedly advances the still picture frame by frame.

10 ↶

- It is useful when skipping over unwanted sections.
- Pressing once skips forward for approximately 30 seconds and resumes playback.
- Pressing repeatedly skips forward continuously as many times as pressed.

11 ↷

- It is useful when watching sports programs, etc.
- Pressing once skips back for approximately 7 seconds and resumes playback.
- Pressing repeatedly skips back continuously as many times as pressed.

12 LIVE CHECK

You can check, for example, if the program you are recording has already finished.

- Pressing once displays the picture currently being recorded and the one being played back simultaneously.
- Pressing successively clears the Live Check window and displays only the picture currently being played back.

Using The On-screen Bar



The on-screen bar allows you to control various playback functions. Some of the functions operated on Navigation Menu can be controlled on the On-screen bar.

Be sure to clear Library Database Navigation screen by pressing **NAVIGATION**.

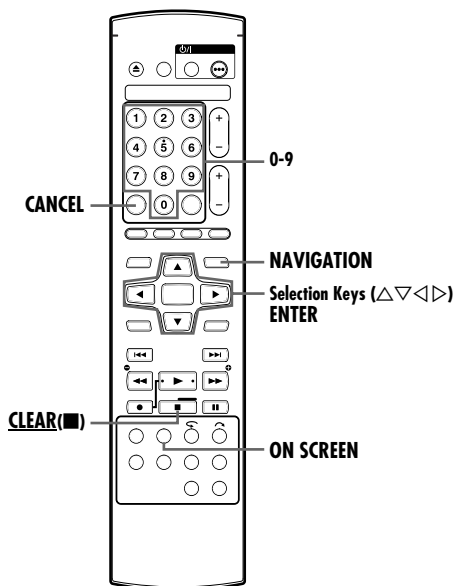

How To Access The On-screen Bar

- 1 Press **ON SCREEN** twice whenever a disc is loaded.

Contents of the on-screen bar during playback

DVD VIDEO

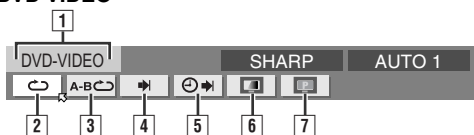

Video CD/Super Video CD

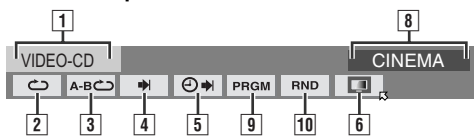

JPEG disc



- 1 Disc type.
- 2 Select this for Repeat Playback. (pg. 30)
- 3 Select this for A-B Repeat Playback. (pg. 31)
- 4 Select this for search function. (pg. 31)
- 5 Select this for time search function. (pg. 32)
- 6 Select this for Picture Control function. (pg. 32)
- 7 Select this to switch picture source type. (pg. 32)
- 8 Current status area for the selected item.
- 9 Select this for Program Playback. (pg. 33)
- 10 Select this for Random Playback. (pg. 33)
- 11 Select this to control the switching interval of the slide show. (pg. 33)

NOTE:

Although examples of the on-screen bar are provided here only for 3 types of discs, the on-screen bar will be displayed for whichever disc indicated in the left column.

Basic Operation On The On-screen Bar

Example: When selecting Picture Control function of DVD

During playback or while stopped

- 1 Press **ON SCREEN** twice to access the on-screen bar. The item currently selected is highlighted and pointed by .



- 2 Press **selection keys** to select "", then press **ENTER**. The pop-up window appears under the selected item.



- 3 Press **selection keys** to select the desired option, then press **ENTER**.

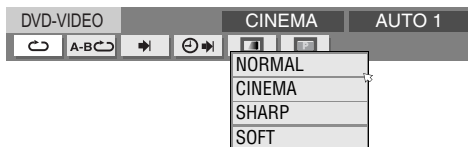

To clear the on-screen bar

Press **ON SCREEN**.

NOTE:

See the corresponding pages for details on each menu item.

Repeat Playback



You can repeat playback as you like according to the type of disc.

- 1 Press **ON SCREEN** twice to access the on-screen bar.
- 2 Press **selection keys** to select "", then press **ENTER**. The pop-up window appears under the selected item.



- 3 Press **selection keys** repeatedly to select the desired Repeat mode, then press **ENTER**.

DVD-RAM/RW/R

OFF:
Repeat playback is not performed.

ALL REPEAT:
The whole disc is played back repeatedly.

TITLE REPEAT:
The current title is played back repeatedly.

DVD VIDEO

OFF:
Repeat playback is not performed.

TITLE REPEAT:
The current title is played back repeatedly.

CHAPTER REPEAT:
The current chapter is played back repeatedly.

Audio CD/Video CD/SVCD/JPEG/MP3

OFF:
Repeat playback is not performed.

ALL REPEAT:
The whole disc is played back repeatedly.

TRACK REPEAT*:
The current track is played back repeatedly.
** "TRACK REPEAT" cannot be selected for JPEG discs.*

To clear the on-screen bar

Press **ON SCREEN**.

To cancel Repeat Playback

Repeat the above procedure from step 1, select "OFF" in step 3, then press **ENTER**.

NOTES:

- Repeat Playback is not possible for a Video CD/SVCD with PBC function.
- Repeat Playback may not work properly depending on the type of the disc being used.

A-B Repeat Playback



You can repeat the desired part.

During Playback

- 1 Press **ON SCREEN** twice to access the on-screen bar.
- 2 Press **selection keys** to select "A-B ".
- 3 Press **ENTER** at the beginning of the desired part you want to repeat (point A). The elapsed playing time of the point A appears.



- 4 Press **ENTER** at the end of the desired part you want to repeat (point B). The elapsed playing time of the point B appears.
 - The selected part of the disc (between point A and B) is played repeatedly.



To clear the on-screen bar

Press **ON SCREEN**.

To cancel A-B Repeat Playback

Press **selection keys** to select "A-B ", then press **ENTER**.

NOTES:

- A-B Repeat Playback may not work properly depending on the type of disc being used.
- The subtitles recorded around the A-B point may not appear.
- When the end of the item is reached before the end point is set, the on-screen bar disappears from the TV screen. In such a case, repeat the procedure from step 1.

- The point B must be set at least 3 seconds after the point A.
- When playing back a DVD, A-B Repeat Playback is possible only within the same title.
- "A-B " cannot be selected during Program and Random Playback.
- "A-B " cannot be selected while stopped.

Locating The Beginning Of A Desired Selection



You can locate the beginning of a title, chapter, group or track.

During playback or while stopped

- 1 Press **ON SCREEN** twice to access the on-screen bar.
- 2 Press **selection keys** to select "**▶**", then press **ENTER**.

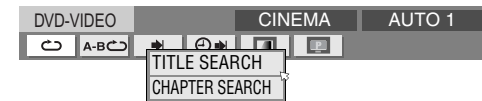

- 3 Press **selection keys** to select the desired option, then press **ENTER**.
 - Skip this step for Video CD/SVCD and Audio CD.

NOTE:

Settings that are selectable during playback and stop mode differ depending on the type of disc and search used.

- 4 Press the **number keys** to enter the desired title or chapter number, then press **ENTER**.
 - Playback starts from the selected section.



Examples:

- 1 To select track 5, press the **number key "5"**.
- 2 To select track 15, press the **number keys "1" and "5"**.
- 3 To select track 25, press the **number keys "2" and "5"**.

If you have specified a wrong number

Press **CLEAR** (■) or **CANCEL** on the remote control and re-enter again.

To clear the on-screen bar

Press **ON SCREEN**.

NOTES:

- When "" is displayed on the TV screen in step 4, the chapter you have selected is not contained in the disc, or chapter search does not work on the disc.
- Before you press **ENTER**, playback may start automatically when you enter the section's number depending on the disc.
- This function is not possible for a Video CD/SVCD with PBC function.

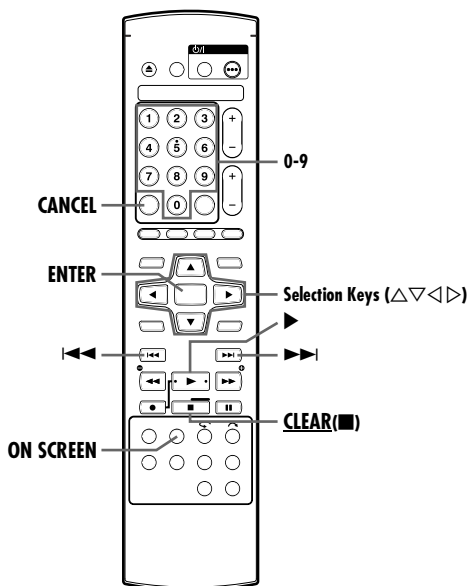

Time Search



You can play back a disc from the desired point by specifying the elapsed playing time from the beginning of a program (DVD-RAM, DVD-R, DVD-RW and DVD VIDEO) or a disc (Video CD/SVCD and Audio CD).

- 1 Press **ON SCREEN** twice to access the on-screen bar.
- 2 Press **selection keys** to select “⏪▶”, then press **ENTER**. The pop-up window appears under the selected item.



- 3 Press the **number keys** to enter the desired title or chapter number, then press **ENTER**. Playback starts from the specified time.

Example:

To play back from a point 12 (minutes): 50 (seconds) elapsed.

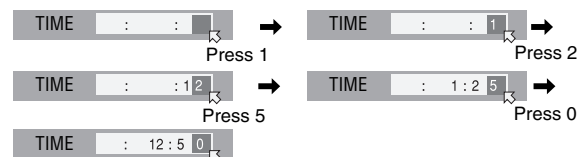

If you have specified a wrong number

Press **CLEAR (■)** or **CANCEL** on the remote control and re-enter again.

To clear the on-screen bar

Press **ON SCREEN**.

NOTES:

- When “⊙” is displayed on the TV screen in step 3, you have selected a point that exceeds the recording time of the disc.
- Some DVD VIDEO discs do not contain time information, and it is not possible to use the Time Search function. In such cases, “⊙” is displayed on the TV screen as well.
- This function is not possible for a Video CD/SVCD with PBC function.

Adjusting The Picture Quality



You can obtain optimal picture quality by selecting an appropriate picture mode.

- 1 Press **ON SCREEN** twice to access the on-screen bar.
- 2 Press **selection keys** to select “🖥️”, then press **ENTER**. The pop-up window appears under the selected item.

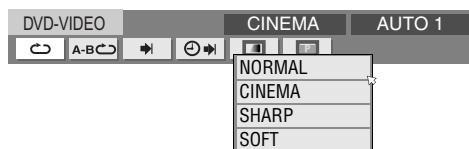

- 3 Press **selection keys** to select the desired option, then press **ENTER**.

NORMAL:

Normally select this.

CINEMA:

Suitable for a movie disc, etc.

SHARP:

Clearer, sharper-edged picture when viewing images with lots of flat, same-colored surfaces such as cartoons.

SOFT:

Select this option when too much noise appears.

To clear the on-screen bar

Press **ON SCREEN**.

Setting The Progressive Mode



You can obtain optimal picture quality by selecting whether the content on the disc is processed by field (video source) or by frame (film source).

- 1 Set the unit to the progressive scan mode. (pg. 60)
- 2 Press **ON SCREEN** twice to access the on-screen bar.
- 3 Press **selection keys** to select “🖥️”, then press **ENTER**. The pop-up window appears under the selected item.

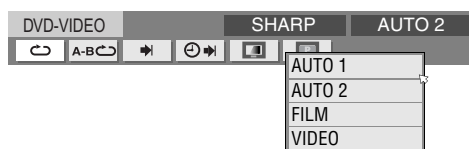

- 4 Press **selection keys** to select the desired option, then press **ENTER**.

AUTO 1:

This mode automatically detects film and video content for progressive playback. When film content is found, flag detection is used to invoke playback of film data in full screen. When video content is found, pictures from multiple fields are used to detect sections with movement, and then this movement undergoes advanced image processing for output of sharp, detailed progressive images without any reduction in image quality where movement occurs. Normally, operation in this mode is recommended.

AUTO 2:

Only the processing of sections with movement differs from “AUTO 1”.

For video contents, the sections with movement are detected and the pictures are corrected by the filtering process for motion pictures.

FILM:

Suitable for playing back a progressive scanned film source disc.

VIDEO:

Suitable for playing back a video source disc. The outlines on the played back pictures will be soft.

To clear the on-screen bar

Press **ON SCREEN**.

Program Playback



You can program up to 30 tracks (Video CD/SVCD or Audio CD) to play back in the desired order.

While stopped

- 1 Press **ON SCREEN** twice to access the on-screen bar.
- 2 Press **selection keys** to select "PRGM", then press **ENTER**. The program table appears under on-screen bar.
- 3 Press the **number keys** to enter the track numbers in the desired order.

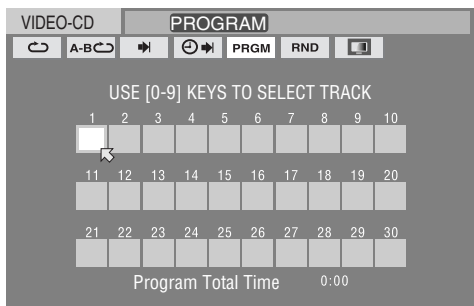

Examples:

- 1 To select track 5, press the **number key "5"** and **ENTER**.
- 2 To select track 15, press the **number keys "1"** and **"5"**.
- 3 To select track 25, press the **number keys "2"** and **"5"**.

If you have specified a wrong selection

Press **CANCEL**. The last selection is erased.

Or press **CLEAR** (■). The whole selection is erased.

- 4 Press **▶**. Playback starts in the programmed order.
 - When all of the programmed tracks have been played back, Program Playback stops, but the programmed information remains.
 - To add tracks to the end of the program, perform steps 1 to 3.
 - During Program Playback, pressing **▶▶** skips to the next track of the program. Pressing **◀◀** returns to the beginning of the current track.

To clear the on-screen bar and the contents of the program

Press **ON SCREEN**.

To cancel Program Playback

Press **selection keys** to select "PRGM", then press **ENTER**.

NOTE:

Program Playback is not possible depending on the type of disc.

Random Playback



You can play back all the tracks on the disc in random order.

While stopped

- 1 Press **ON SCREEN** twice to access the on-screen bar.
- 2 Press **selection keys** to select "RND", then press **ENTER**. Playback starts in random order.



To clear the on-screen bar

Press **ON SCREEN**.

To cancel Random Playback

Perform steps 1 and 2.

NOTE:

The same track will not be played back more than once during Random Playback.

Select The Switching Interval Of The Slide Show



You can control the switching interval of the slide show.

- 1 Press **ON SCREEN** twice to access the on-screen bar.
- 2 Press **selection keys** to select "Interval", then press **ENTER**. The pop-up window appears under the selected item.

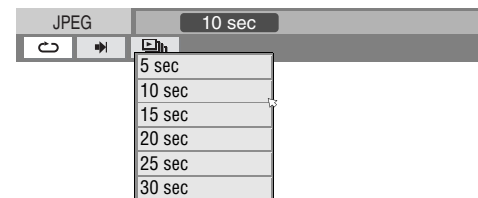

- 3 Press **selection keys** to select the desired option, then press **ENTER**.

- Each time you press selection keys, the interval changes as follows:
5 sec ↔ 10 sec ↔ 15 sec ↔ 20 sec ↔ 25 sec ↔ 30 sec ↔ (Back to the beginning)

To clear the on-screen bar

Press **ON SCREEN**.

NOTE:

JPEG files are played back as a slide show. It may take more time to display an image with larger file size.

Basic Recording



- Turn on the unit.
- Turn on the TV and select an input mode such as EXT1.

ATTENTION:

It is not possible to record programs on a DVD-R/RW disc which has already been finalized.

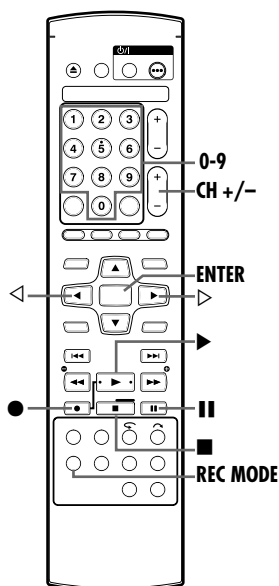
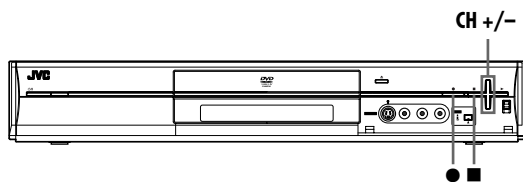

- Load a recordable disc.
 - For details, refer to "Placing A Disc" (pg. 10).
- Press **CH +/-** or the **number keys** to select the channel you wish to record.
- Press **REC MODE** repeatedly to select the recording mode, then press **ENTER**.
 - Each time you press **REC MODE**, the recording mode changes as follows:
 XP → SP → LP → EP → FR (60-360*, 420, 480) → (Back to the beginning)
 - * The value is selectable from 1 to 6 hours in 5 minutes interval by pressing <|> repeatedly after selecting "FR60-FR360". To change the value in 30 minutes interval, press and hold <|>.
 - For details on the recording mode, see the right column.
- Press ● on the unit to start recording. Or while holding ●, press ► on the remote control.
- Press || to pause recording.
 - To resume recording, press ►.
- Press ■ to stop recording.
 - It takes about 10 seconds to end the writing session when you stop recording.

NOTES:

- It is recommended to format a DVD-RAM disc before use if you use the disc on this unit for the first time. (pg. 63)
- When using a brand-new DVD-RW disc, format the disc either in VR mode or in Video mode. (pg. 63)
- Recordings made on DVD-R/RW disc must be finalized to play back on other DVD players. Perform "Finalize A Disc" (pg. 64).
- You can record up to 99 programs and 99 play lists on each disc.
- Some programs can only be recorded one time.
- When recording is started, an index of the first part of recording is automatically recorded. (pg. 43) To delete the index, refer to page 48.
- Recording sometimes may stop or cannot be performed even if there is enough available capacity remaining on the disc.

Recording Mode

MPEG 2 format is used as recording format. As a guide for picture quality, the "bps" unit is used to represent how much data can be recorded per second. The larger this value is, the better the picture quality becomes but more capacity is required for the recording. Select XP or SP for programs where quick movement occurs, such as sports programs, and LP or EP for talk shows, etc. with relatively less movement.

The recording modes for a 4.7 GB disc are set as follows:

Recording mode	Recording amount (approx.)	Maximum recording time (approx.)
XP	10 Mbps	1 hour
SP	5 Mbps	2 hours
LP	2.5 Mbps	4 hours
EP	1.6 Mbps	6 hours
FR	60-360 (pg. 36)	1 – 6 hours
	420	7 hours
	480	8 hours

- For details on FR mode, refer to "Free Rate Function" (pg. 36).

Recording Features

- Turn on the unit.
- Turn on the TV and select an input mode such as EXT1.

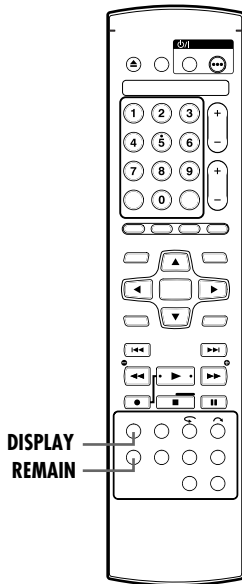
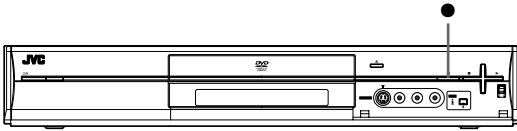

Instant Timer Recording (ITR)

It is possible to set the recording time during recording. Upon completing recording, the unit stops and shut off automatically.

- 1 Press ● on the unit to start RetroActive Recording.
- 2 Press ● again to engage the ITR mode.
 - "0:30" is displayed on the front display panel.
- 3 If you want to record for more than 30 minutes, press ● to extend the time. Each press extends recording time by 30 minutes.

Normal recording → 0:30 → 1:00 ... → Maximum disc remaining time → (Back to the beginning)

NOTES:

- Perform ITR using the ● button on the unit.
- The maximum recording time changes depending on the disc remaining time.

Watch Another Program While Recording On The Unit

While recording is going on, you can watch another program on the TV. It does not interfere with recording.

- 1 Turn on the TV.
- 2 Select the desired channel to watch on TV using your TV's remote control.

Elapsed Recording Time And Disc Remaining Time Indication

During recording, press **DISPLAY** repeatedly until the desired indication appears on the front display panel.

- Each time you press **DISPLAY**, the time indication changes as follows:
Elapsed recording time → Disc remaining time → Clock → (Back to the beginning)
- You can also check the disc remaining time by pressing **REMAIN** while the unit is stopped or recording is in progress. The list of disc remaining times for all recording modes appears on the TV screen.

Free Rate Function

To record the entire program, the unit automatically sets the appropriate recording mode depending on the combination of the total time of the program to be recorded and either the remaining disc space or the specified recording time (from 60 minutes to 480 minutes when using 4.7 GB blank media disc).

■ To record the entire program within the actual remaining disc space

Select "FR (JUST)" in a recording mode selection procedure.

- Note that this function is available only for timer programming recording (pg. 37, 38).

■ To record the entire program by specifying the desired recording time

Select "FR60-FR360", "FR420" or "FR480" in a recording mode selection procedure. (pg. 34)

■ To record a 25 min. long daily program five times just on the same DVD disc for example

Perform "VCR Plus+ Timer Programming" (pg. 37) procedure. Be sure to set the recording mode to "FR125" and set Weekly/Daily Rec Function to "MON-FRI" in step 6 to fit the total recording time to the whole disc space.

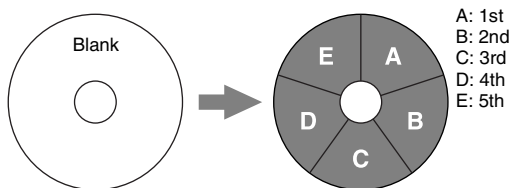

When the same program is recorded in SP mode instead of in "FR125", the 5th program cannot be recorded.

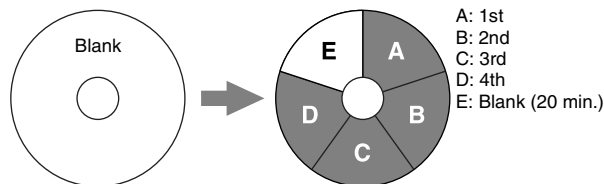

NOTES:

- You can program this unit to timer record, regardless of the disc remaining time. If the disc remaining time is not enough, it is not possible to record until the end of the timer program. To avoid this, confirm the disc remaining time before setting timer programming.

(Example) If you programmed to timer record for 60 minutes in SP mode on a 120 minutes disc, the disc remaining time would be 30 minutes in XP mode, 60 minutes in SP mode, 120 minutes in LP mode, 180 minutes in EP mode, and 240 minutes in FR480 mode. Timer recording will not complete beyond these remaining times.

- The maximum recording time of FR (JUST) mode is the same as the recording time of FR480 mode. When timer programming a long program in FR (JUST) mode on a disc whose remaining time is short, it is recommended to check the disc remaining time in FR480 mode to see if the remaining time is enough for the program.
- Even if more than one program are timer programmed in FR (JUST) mode, only the first one is recorded.
- In order to ensure that the recording fits on the disc, this feature may leave a slight non-recorded section at the end of the disc.
- There may be some noise and sound disturbance at the point on the disc where the unit switches the mode.

Second Audio Recording

This unit's built-in MTS decoder enables reception of Multichannel TV Sound broadcast. To record a SAP program received, set "2ND AUDIO RECORD" to "ON". (pg. 59)

NOTE:

When the channel is changed on the unit;

- The "MONO" indicator appears on the screen for about 5 seconds if the program is a monaural broadcast.
- The "STEREO" indicator appears on the screen for about 5 seconds if the program is a stereo broadcast.
- Both "STEREO" and "SAP" indicators appear when a stereo program is accompanied by SAP sound.
- Both "MONO" and "SAP" indicators appear when the main audio on the monaural broadcast is accompanied by SAP sound.

VCR Plus+ Timer Programming



You can program this unit to timer record as many as 8 programs. With the VCR Plus+ system, timer programming is greatly simplified because each TV program has a corresponding code number which your unit is able to recognize. You can use the remote control to enter the PlusCode number.

- Turn on the unit.
- Turn on the TV and select an input mode such as EXT1.
- Make sure that the unit's built-in clock is set properly.

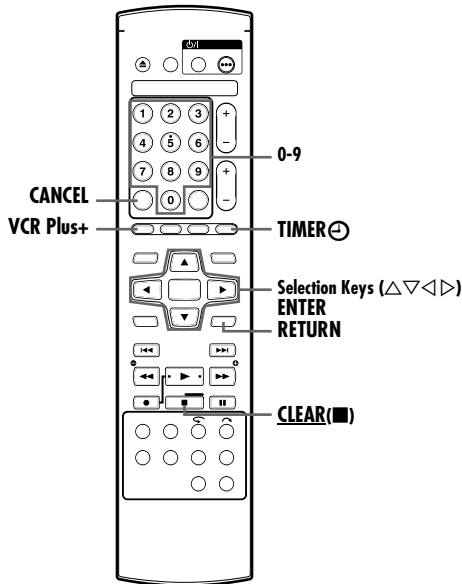

1 Load a recordable disc.
 • For details, refer to "Placing A Disc" (pg. 10).

2 Press **VCR Plus+** to display the "VCR Plus+ PRGM" screen.

3 Press the **number keys** to enter the "PLUSCODE NO." of a program you wish to record, then press **ENTER**.

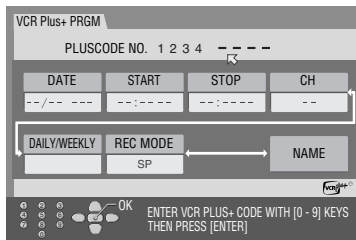

- If you have made a mistake, press **CANCEL** and input the correct number before you press **ENTER**.
- To clear all entered numbers at a time, press **CLEAR**.
- If the number you entered is invalid, "PLUSCODE NO. ERROR CONFIRM PLUSCODE NO. THEN RETRY" appears on the TV screen. Input a valid "PLUSCODE NO."
- If "GUIDE PROGRAM IS NOT SET SELECT CHANNEL YOU WANT TO RECORD" appears on the TV screen, set Guide Channel numbers manually.
- When "PROGRAM FULL DELETE UNWANTED TIMER PROGRAM" appears on the TV screen, you need to cancel some of the reserved programs.

4 The "PLUSCODE NO." you entered and the matching timer recording information are displayed on the TV screen. Check the program data.

- To cancel this setting, press **RETURN**.

IMPORTANT:

Make sure the channel position number you wish to record is displayed. If not, see "Changing VCR Plus+ Setting" (pg. 62) and set the Guide Channel number correctly.

5 Press **selection keys** to select desired recording option as required.

6 Press **selection keys** to select the desired setting, then press **ENTER**.

- "Daily/Weekly Recording Function" (pg. 37)
- "Recording Mode" (pg. 34)
- "Modify Title Name" (pg. 46)

7 Press **ENTER** to access the Program Confirmation screen.

8 Press **ENTER** to complete the timer programming.
 • To program another timer, repeat steps 2 – 8.
 • If "PROGRAM OVERLAPPED" appears on the TV screen, see "When Programs Overlap Each Other" (pg. 41).

9 Press **TIMER** to engage the unit's timer mode.

- The unit turns off automatically and **TIMER** appears on the front display panel.
- To disengage the timer mode, press **TIMER** again.

IMPORTANT:

If you have moved to a different area or if a broadcasting station's channel number has been changed, the wrong channel number will be displayed on the VCR Plus+ program screen in step 4. When this happens, set the correct Guide Channel number for that station.

- There may be cases that the "VCR Plus+ Timer Programming" function prolongs the stop time of the programming.
- When two successive programs are recorded with the "VCR Plus+ Timer Programming" function, the ending of the first program or the beginning of the second program may not be recorded.
- If the copy limited program is received during timer recording, the unit enters Record Pause mode. Recording starts again if it is switched to a recordable broadcast during the time you programmed.

Daily/Weekly Recording Function

You can record programs with one of the following weekly/daily timer settings.

WEEKLY	Select to record a weekly program.
MON-FRI	Select to record a daily program from Monday through Friday.
MON-SAT	Select to record a daily program from Monday through Saturday.
SUN-SAT	Select to record a daily program from Sunday through Saturday.

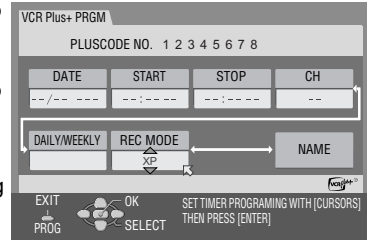

Manual Timer Programming



You can program this unit to timer record as many as 8 programs up to 30 days in advance. If you do not know the PlusCode number for the program you wish to record, use the following procedure to set your unit to timer record the program.

- Turn on the unit.
- Turn on the TV and select an input mode such as EXT1.
- Make sure that the unit's built-in clock is set properly.

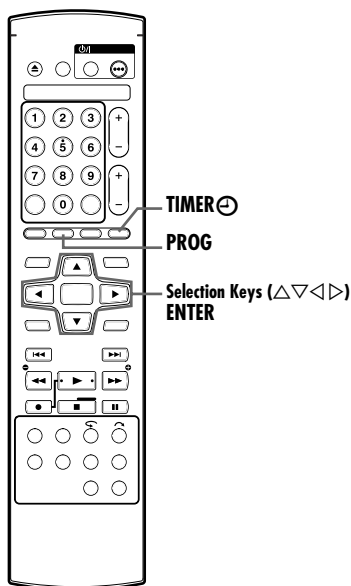

- 1 Load a recordable disc.
 - For details, refer to "Placing A Disc" (pg. 10).

- 2 Press **PROG** to display the "PROGRAM CHECK" screen.
 - When "PROGRAM FULL DELETE UNWANTED TIMER PROGRAM" appears on the TV screen, you need to cancel some of the reserved programs.

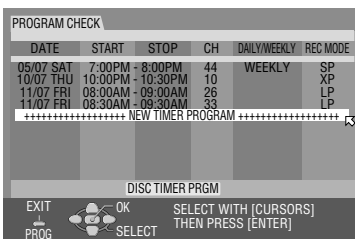

- 3 Press **selection keys** repeatedly to select "NEW TIMER PROGRAM", then press **ENTER**.

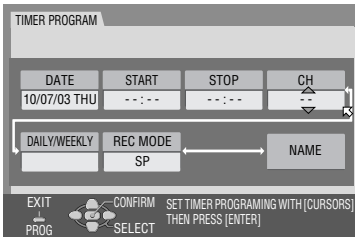

- 5 Press **selection keys** to set the desired start time ("START"), then press \triangleright .
 - Each press of \triangle ∇ increases/decreases the start time in 1 minute interval.
 - To increase/decrease the start time in 30 minutes interval, press and hold \triangle ∇ .

- 6 Press **selection keys** to set the desired stop time ("STOP"), then press \triangleright .
 - Each press of \triangle ∇ increases/decreases the stop time in 1 minute interval.
 - To increase/decrease the stop time in 30 minutes interval, press and hold \triangle ∇ .
- 7 Press **selection keys** to set the desired channel ("CH"), then press \triangleright .
- 8 Set the other recording options as required.
 - Refer to step 6 in "VCR Plus+ Timer Programming" (pg. 37).
- 9 Press **ENTER** to access the Program Confirmation screen.
- 10 Press **ENTER** to complete the timer programming.
 - To program another timer, repeat steps 2 – 10.
- 11 Press **TIMER** to engage the unit's timer mode.
 - The unit turns off automatically and \odot appears on the front display panel.
 - To disengage the timer mode, press **TIMER** again.

NOTES:

- When two successive programs are recorded with the "Manual Timer Programming" function, the ending of the first program or the beginning of the second program may not be recorded.
- If the copy limited program is received during timer recording, the unit enters Record Pause mode. Recording starts again if it is switched to a recordable broadcast during the time you programmed.

Cable Box or DBS Receiver Users

To record a satellite broadcast using Manual Timer Programming:

- 1 Perform Manual Timer Programming.
 - Set the channel to the external input ("L-1" or "F-1") connected to the cable box or DBS receiver.
- 2 Set the cable box or DBS receiver to the appropriate channel for recording.
 - Leave the cable box or DBS receiver's power on.

On-Disc Timer Programming



On-Disc Timer Programming is a function used with discs that are especially intended for a specific program. The disc is then programmed for a program you always watch every day or every week. Since older programs are automatically overwritten, a single disc can be used without worrying about how much recording capacity remains. You can program each disc to timer record as many as 8 programs up to 30 days in advance.

- Make sure that the unit's built-in clock is set properly.
- Turn on the TV and select an input mode such as EXT1.
- Load a DVD-RAM or DVD-RW (VR mode) disc for programming.

ATTENTION:

- On-Disc Timer Programming is possible only with the disc for On-Disc Timer Programming.
- If data is recorded on a disc for On-Disc Timer Programming using a unit from another manufacturer, On-Disc Timer Programming may not function properly.

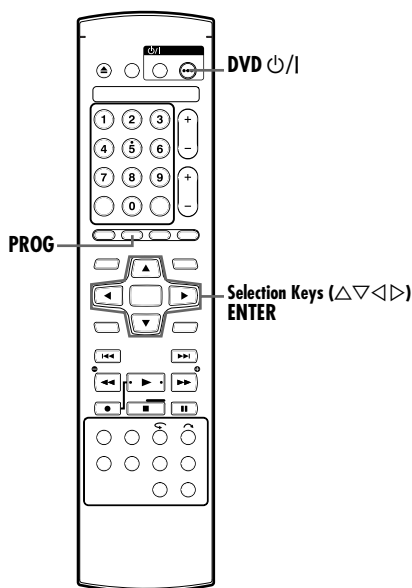

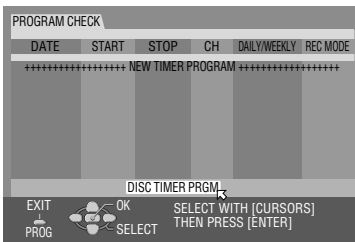
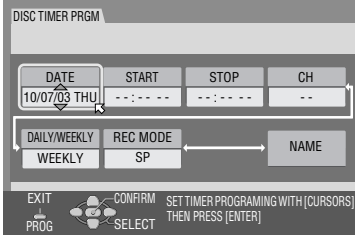
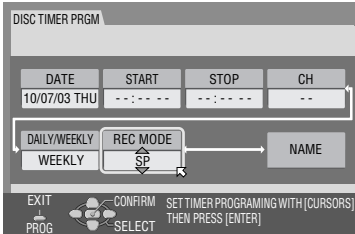

To Make The Disc For On-Disc Timer Programming

- 1 Press **PROG** to access the Program Check screen.
 
- 2 Press **selection keys** to select "DISC TIMER PRGM", then press **ENTER**.
 - When some programs are recorded on the disc, a caution message appears. To backup the recorded programs, press **ENTER**, and perform dubbing to other devices.
 - When On-Disc Timer Programming has already been made on the disc, press **selection keys** to select "NEW TIMER PROGRAM", then press **ENTER**.
- 3 Press **selection keys** to set the desired date ("DATE"), then press **▷**.
 
- 4 Press **selection keys** to set the desired start time ("START"), then press **▷**.
 - Each press of **Δ ∇** increases/decreases the start time in 1-minute interval.
 - To increase/decrease the start time in 30-minutes interval, press and hold **Δ ∇**.
- 5 Press **selection keys** to set the desired stop time ("STOP"), then press **▷**.
 - Each press of **Δ ∇** increases/decreases the stop time in 1-minute interval.
 - To increase/decrease the stop time in 30-minutes interval, press and hold **Δ ∇**.
- 6 Press **selection keys** to set the desired channel ("CH"), then press **▷**.
- 7 Press **selection keys** to set "DAILY/WEEKLY", then press **▷**.
 - For details on "DAILY/WEEKLY" setting, refer to "Daily/Weekly Recording Function" (pg. 37).
- 8 Set the other recording options as required.
 - "Recording Mode" (pg. 34)
 - "Modify Title Name" (pg. 46)
- 9 Press **ENTER** to access the Program Confirmation screen.
 
- 10 Press **ENTER** to complete the timer programming.
 - To program another timer using "To Make The Disc For On-Disc Timer Programming", repeat steps 1 – 10.
- 11 Press **DVD ⏻/⏪** to turn off the power.
 - **DISC** (⏻) is displayed on the front display panel.
 - To disengage the timer mode, press **DVD ⏻/⏪** again.

Cable Box or DBS Receiver Users
 To timer record a satellite broadcast using On-Disc Timer Programming:

- 1 Perform On-Disc Timer Programming.
 - Set the channel to the external input ("L-1" or "F-1") connected to the cable box or DBS receiver.
- 2 Set the cable box or DBS receiver to the appropriate channel for recording.
 - Leave the cable box or DBS receiver's power on.

To Timer Record The Program With The Programmed Disc

- 1 Load a programmed disc.
- 2 Press **DVD**  to turn off the power.
 -  appears on the front display panel, and the unit enters into timer standby mode.
 - To disengage the timer mode, press **DVD**  again.

NOTES:

- On-Disc Timer Programming is not possible on a DVD-R or DVD-RW (Video mode) disc.
- The information of a program recorded with On-Disc Timer Programming is not stored in the library.
- The play list is not created for the programs recorded with On-Disc Timer Programming.
- Programs recorded with On-Disc Timer Programming cannot be edited or protected.
- On-Disc Timer Programmed discs cannot be used for other recordings other than On-Disc Timer Programming.
- On-Disc Timer Programmed discs cannot be used on units from other manufacturers.
- The beginning of a program may not be recorded. In addition, if the 1st program's recording stop time and the 2nd program's recording start time is the same, the ending of the 1st program may not be recorded.
- If there is a power outage while recording, the recordings when the power outage occurs are not guaranteed.

How Discs Are Overwritten

(Example 1)

To record a 1 hour serial drama every Friday in SP mode

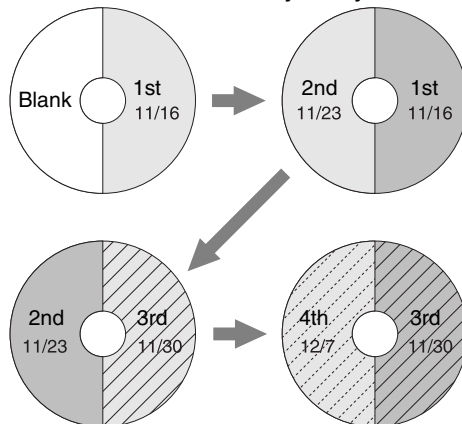

The first program is overwritten by the third.

The second program is overwritten by the fourth.

(Example 2)

To record a 15 minutes serial drama every morning in XP mode

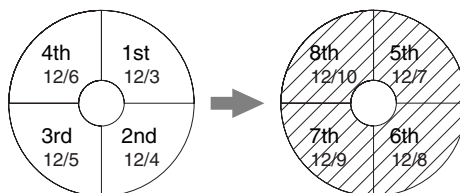

(Example 3)

To record a 90 minutes serial drama every Sunday in SP mode

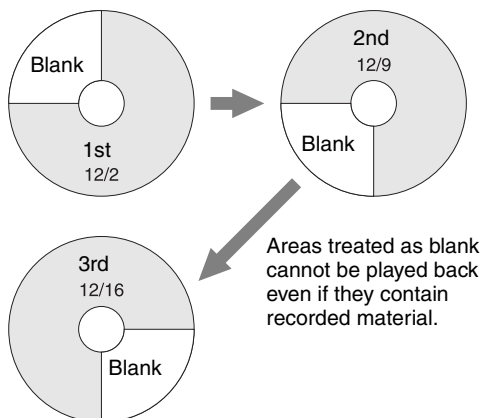

NOTE:

On-Disc Timer Programming may not always work as these examples.

Check, Cancel And Change Programs

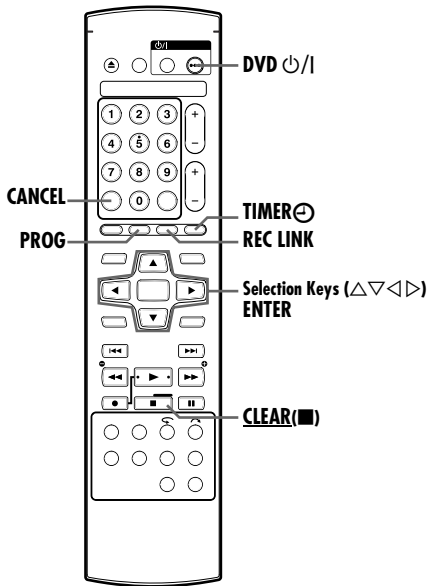

- 1** Disengage the timer mode.
 - When **DISC** (⏻) lights up on the front display panel, press **DVD** ⏻/⏮.
 - When **⏻** lights up on the front display panel, press **TIMER** ⏻, and press **DVD** ⏻/⏮ after **⏻** lights off.
 - When “R-LK” lights up on the front display panel, press **REC LINK**.

- 2** Press **PROG** to access the Program Check screen.
 - To return to the previous screen after you check the program, press **PROG** again.

To cancel the program

- Press **selection keys** to select a program to be canceled, then press **CANCEL**.
- 3** Press **selection keys** to select a program to be changed, then press **ENTER**.

- 4** Change the settings of the desired recording options as required.
 - Refer to steps 4 – 10 in “Manual Timer Programming” (pg. 38).

- 5** Press **PROG** to exit the program screen.

- 6** Set the unit to timer standby mode.

For VCR Plus+ or Manual Timer Programming

- Press **TIMER** ⏻ so that **⏻** lights up on the front display panel.

For On-Disc Timer Programming

- Press **DVD** ⏻/⏮ so that **DISC** (⏻) lights up on the front display panel.

For Automatic Satellite Program Recording

- Press **REC LINK** for 2 or more seconds.

When Programs Overlap Each Other

If “PROGRAM OVERLAPPED” appears, you have another program overlapping the program you have just made. Press **PROG**. Program Check screen appears and conflicting programs will be highlighted in pink.

Example: Program 3 (you have just made) and Program 4 overlap each other.

- 1** Confirm the overlapping programs.

NOTES:

- If you do not mind this overlap, press **PROG** to finish the timer program setting.
- Recording is performed according to the order as displayed on the Program Check screen. The timer program that follows will not be performed correctly.
- If no changes are made for approximately 1 minute, the unit will automatically return to the normal screen.

To cancel the program

Press **selection keys** to select a program to be canceled, then press **CLEAR** (■).

- “THE TIMER PROGRAMMING SETTING WAS CANCELLED” appears on the TV screen for about 5 seconds, then the normal screen resumes.

To change the program

Press **selection keys** to select a program to be changed, then press **ENTER**.

- Change each setting as required.
- 2** Press **ENTER** to exit the Program screen.
- 3** Press **TIMER** ⏻ to enter into timer standby mode.

NOTE:

When any overlaps remain after deletion and modification of programs, Program Overlap list remains showing the conflicting programs. In such a case, repeat the procedure above until the conflict is solved.

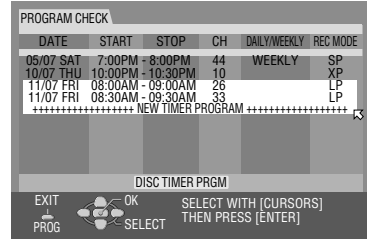

Automatic Satellite Program Recording

This function allows you to automatically record a satellite program which is timer programmed on your external DBS receiver. Connect a DBS receiver to the unit's [S-VIDEO/VIDEO/AUDIO INPUT L-1] connectors and program the timer on the DBS receiver. The unit starts or stops recording by the signals input from the DBS receiver. After recording, the unit's power shuts off automatically.

ATTENTION:

- Be sure not to turn on the DBS receiver before the program is executed. Otherwise, the unit will start recording when the DBS receiver's power is turned on.
- If you have connected another appliance other than a DBS receiver to the [S-VIDEO/VIDEO/AUDIO INPUT L-1] connectors, be sure not to engage the Automatic Satellite Program Recording mode. Otherwise, the unit will start recording when the connected appliance's power is turned on.
- Automatic Satellite Program Recording and timer recording cannot be done at the same time.

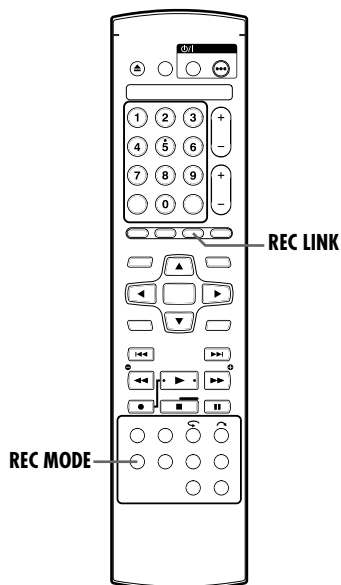

- Make sure the DBS receiver is connected to the unit's [S-VIDEO/VIDEO/AUDIO INPUT L-1] connectors.
- Program the timer on the DBS receiver.

- 1 Press **REC MODE** repeatedly to set the recording mode.
- 2 Press and hold **REC LINK** for about 2 seconds to engage the Automatic Satellite Program Recording mode. "⏸" and "R-LK" light up on the front display panel.

NOTES:

- To disengage the Automatic Satellite Program Recording mode, press **REC LINK**.
- If the unit's power is off, it is not possible to engage the Automatic Satellite Program Recording mode.
- In step 2, if "⏸" blinks quickly on the front display panel even though your DBS receiver's power is off, Automatic Satellite Program Recording will not work properly with that DBS receiver*. If this is the case, perform "Manual Timer Programming" (pg. 38) to timer record a satellite program.
 - * Some DBS receivers output signals even if the power is off. Automatic Satellite Program Recording is not possible with those DBS receivers.
- "⏸" blinks on the front display panel while Automatic Satellite Program Recording is in progress.
- For timer programming of the DBS receiver, refer to the instruction manual of the DBS receiver.
- Automatic Satellite Program Recording is not possible if your DBS receiver does not have a timer.
- Pressing the unit's **⏻/I** button while Automatic Satellite Program Recording is in progress turns off the unit's power and disengages the Automatic Satellite Program Recording mode.
- If there are more than one satellite programs you wish to record with Automatic Satellite Program Recording, it is not possible to set different recording modes for each program.
- Depending on the type of DBS receiver, the unit may not record a slight portion of the beginning of the program or may record slightly longer than the actual length of the program.
- If you engage the Automatic Satellite Program Recording mode when the DBS receiver's power is on, the unit will not start Automatic Satellite Program Recording even though "⏸" blinks on the front display panel. When the DBS receiver shuts off once and is turned back on again, the unit starts recording.
- You can also record a program from your cable system in the same way if the system has a timer.
- When the Automatic Satellite Program Recording mode is engaged, or the unit's power is turned off after Automatic Satellite Program Recording is finished, the unit will not enter the timer mode even though "AUTO TIMER" is set to "ON" (pg. 60).

Library Database Navigation



The Library Database Navigation enables you to search and select the desired titles recorded very easily. You can record up to 99 titles on a disc.

Each time a title is recorded, the information of the title is registered for the Library Database Navigation automatically. So, you can confirm the information of the titles recorded with the Library Database Navigation screen. And, you can also select one of the titles recorded using the Library Database Navigation.

The following screen appears as the Library Database Navigation screen when you press **NAVIGATION**. You can move the arrow to select the desired position on the screen by pressing the **selection keys** on the remote control.

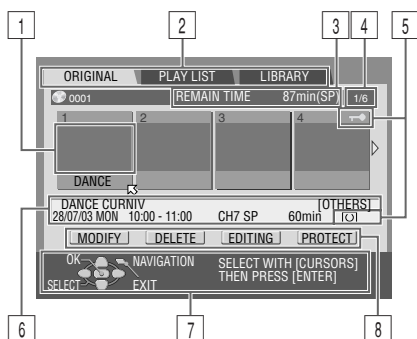

- 1 INDEX (Thumbnail of each program)
- 2 Menu index ORIGINAL (pg. 44) PLAY LIST (pg. 47) LIBRARY (pg. 51)
- 3 Remaining time (Based on the recording speed currently selected)
- 4 Current/Total number of program(s)
- 5 Icons
- 6 Recording information for the program indicated by the arrow
- 7 Guidance for operations
- 8 Operational commands

The Icons and their meanings

	This program is write-protected.
	This program has stereo sounds.
	This program was recorded with timer recording.

Using Library Database Navigation system, you can easily modify registered information, edit the title or play list, as well as search for the beginning of each title.

About registration of information

The following information is automatically registered for each title when ordinary recording or timer recording is performed, then stored in an area specified on the unit.

- index* (reduced pictures to show program titles)
- program title*
- category*
- date and time
- channel
- recording mode
- length of recording time

The items marked with an asterisk (*) can be easily modified and registered again after recording by using Library Database Navigation system.

The limitations of registration

You can register information up to 99 programs in a single DVD. When the amount of information is at the limits of registration, you cannot record new titles any more. In this case, you need to delete old titles to register new ones. (pg. 44)

NOTES:

- Once a DVD-R/RW (Video mode) disc has been finalized, the displays for original and play list do not appear. As only display for library appears, press **TOP MENU** to display the following screen to select the desired title.

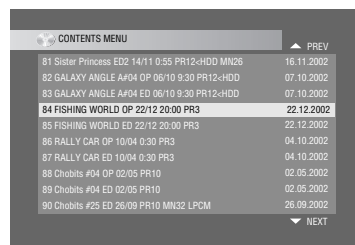

- Sound of received channel may be interrupted while the Library Database Navigation screen is displayed.
- You cannot perform timer recording during editing of thumbnail images or play lists by pressing **NAVIGATION**. Press **NAVIGATION** to clear the editing screen before performing timer recording.

Basic Operation Of Original Information

You can scan the beginning of the title easily and play back with the Library Database Navigation.

- Turn on the TV and select an input mode such as EXT1.
- Load a DVD disc to play back.

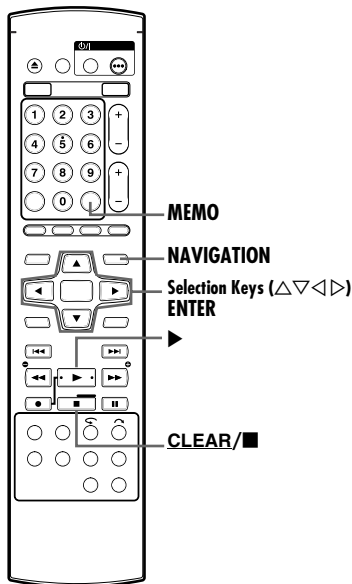

Play Back Title

- 1 Press **NAVIGATION** to display the Library Database Navigation screen.
- 2 Press **selection keys** to select "ORIGINAL", then press **ENTER**.
- 3 Press **selection keys** to select the index (small pictures) of the desired title, then press **ENTER** or **▶**.
 - With the arrow on "ORIGINAL", all titles will be played back according to the index order when **▶** is pressed.
 - All subsequent titles after the selected index will be played back in order.
 - The unit stops when playback ends, and resumes to a broadcast receiving screen.
 - Press **■** to stop playback. If "RESUME" is set to "ON" or "DISC RESUME" (pg. 60), playback starts from the point where playback was previously stopped when **▶** is pressed.
 - When you want multiple titles to be played back in a determined order, press **selection keys** to select the desired title, then press **MEMO**. The numbers of the playback order appear on the index. (Up to 30 titles.)
 - When you want to correct the order, move the arrow to the desired index and press **MEMO**. The number disappears and the unit re-numbers the other titles automatically.
 - When you want to cancel the order, press **CLEAR(■)**.



Protect Title (DVD-RAM & DVD-RW (VR mode) only)

You can protect titles to prevent accidental erasure of the important titles.

- 1 Press **NAVIGATION** to display the Library Database Navigation screen.
- 2 Press **selection keys** to select "ORIGINAL", then press **ENTER**.
- 3 Press **selection keys** to select a title you want to protect, then press **▽**.
- 4 Press **selection keys** to select "PROTECT", then press **ENTER**.
 - "PROTECT" appears on the TV screen.
 - To cancel the protection, select "PROTECT" again, then press **ENTER**.
- 5 Press **NAVIGATION** to return to the normal screen.

NOTE:

All the titles on a disc will be deleted once the disc is formatted even if they are protected titles. (pg. 63)

Delete Title

You cannot record any more with Library Database Navigation once the registered titles on the disc reach 99 titles. Deleting unnecessary titles after dubbing or other operations can increase remaining time and available recording capacity. (For DVD-R discs, although it is possible to delete recorded titles, available recording capacity does not increase.) The deleted title cannot be retrieved. Play lists and title information in the unit's library are also deleted.

- 1 Press **NAVIGATION** to display the Library Database Navigation screen.
- 2 Press **selection keys** to select "ORIGINAL", then press **ENTER**.
- 3 Press **selection keys** to select a title you want to delete, then press **▽**.
- 4 Press **selection keys** to select "DELETE", then press **ENTER**.
 - The confirmation screen appears.
- 5 Press **selection keys** to select "YES", then press **ENTER**.
 - To cancel the deletion, select "NO", then press **ENTER**.
- 6 Press **NAVIGATION** to return to the normal screen.

Delete Unwanted Part Of The Title (DVD-RAM & DVD-RW (VR mode) only)

You can delete unwanted part of a title.

- 1 Press **NAVIGATION** to display the Library Database Navigation screen.
- 2 Press **selection keys** to select "ORIGINAL", then press **ENTER**.
- 3 Press **selection keys** to select a title whose unwanted part you want to delete, then press **▽**.
- 4 Press **selection keys** to select "EDITING", then press **ENTER**.
- 5 Press **▶** to start playback.
 - Press **◀◀** or **▶▶** to find the point where you want the deletion to begin, then press **II**.
- 6 Confirm the arrow is on "IN", then press **ENTER**.
 - The edit-in time is displayed on the left of the "IN" window.
- 7 Press **▶** to resume playback.
 - Press **II** to pause at the point where you want the deletion to end.
- 8 Confirm the arrow is on "OUT", then press **ENTER**.
 - The edit-out time is displayed on the left of the "OUT" window.
- 9 Press **selection keys** to select "PREVIEW", then press **ENTER** to preview the edited title.

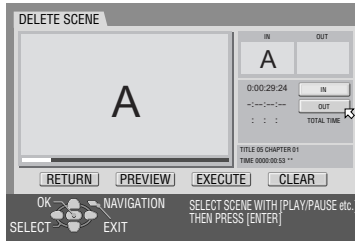
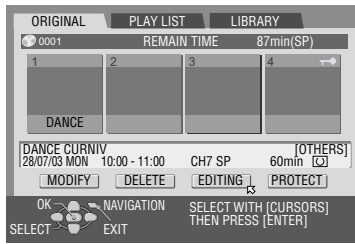

To modify the points

- 1 Press **selection keys** to select "CLEAR", then press **ENTER**.
 - Press **selection keys** to select "RETURN", then press **ENTER** to return to the screen in step 4.
- 2 Press **selection keys** to select "IN".
- 3 Perform steps 5 – 9.
- 10 Press **selection keys** to select "EXECUTE", then press **ENTER**.
 - The confirmation screen appears.
- 11 Press **selection keys** to select "YES", then press **ENTER**.
 - When you cancel the deletion, select "NO", then press **ENTER**.
- 12 Press **NAVIGATION** to return to the normal screen.

NOTES:

- There may be a discrepancy of several seconds between the scene you intend to edit, and the scene which is actually edited.
- Available recording capacity may not match the deleted part after deletion.

Edit Original Information



- Turn on the TV and select an input mode such as EXT1.
- Load a DVD disc to modify.

ATTENTION:

- It is not possible to modify discs recorded on DVD units from other manufacturers.
- You cannot perform timer recording during editing of index by pressing **NAVIGATION**. Press **NAVIGATION** to clear the editing screen before performing timer recording.

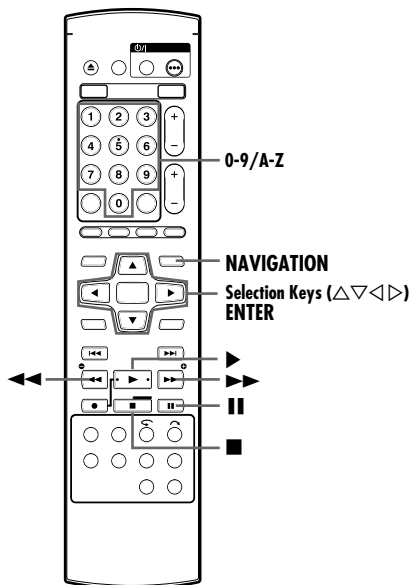

Modify Index

- 1 Press **NAVIGATION** to display the Library Database Navigation screen.
- 2 Press **selection keys** to select "ORIGINAL", then press **ENTER**.
- 3 Press **selection keys** to select a title you want to modify, then press **▽**.
- 4 Press **selection keys** to select "MODIFY", then press **ENTER**.
- 5 Press **selection keys** to select "MODIFY INDEX", then press **ENTER**.
- 6 Press **▶** to start playback. Press **◀◀** or **▶▶** to search for the picture from the title, then press **II**.
- 7 Confirm the arrow is on "REPLACE", then press **ENTER**.
 - The new index appears on the right window.
- 8 Confirm the arrow is on "RETURN", then press **ENTER**.
 - You can confirm the new index.
- 9 Press **NAVIGATION** to return to the normal screen.

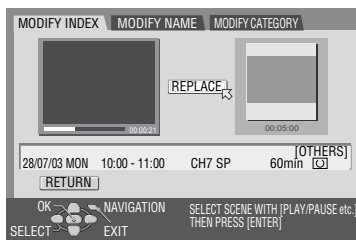

Modify Title Name

- 1 Perform steps 1 – 4 of "Modify Index" (pg. 46) before continuing.
- 2 Press **selection keys** to select "MODIFY NAME", then press **ENTER**.
- 3 Input a new title name.
 - Press **selection keys** to select the desired letter or symbol, then press **ENTER**.
 - To erase the letter, press **selection keys** to select "DELETE" or "DELETE ALL", then press **ENTER**.
 - You can enter up to 64 letters.
 - You can also use the **number keys** on the remote control to input the letters. For example, pressing **number key "2"** repeatedly changes the letter in the order of "A", "B", "C", "a", "b", "c" and "2". The following buttons can also be used.

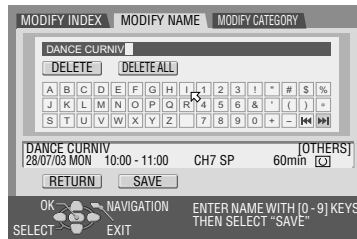

Number keys: To input alphabet, numbers and space.
 <|> buttons: To move the input position and insertion point.
 ■ button: To correct the letters.
 ◀▶ buttons: To switch the character table.

- 4 Press **selection keys** to select "SAVE", then press **ENTER**.
 - The new title name is registered.
- 5 Press **selection keys** to select "RETURN", then press **ENTER**.
 - Return to the Library Database Navigation screen to confirm the modified name.
- 6 Press **NAVIGATION** to return to the normal screen.

Modify Category

- 1 Perform steps 1 – 4 of "Modify Index" (pg. 46) before continuing.
- 2 Press **selection keys** to select "MODIFY CATEGORY", then press **ENTER**.
- 3 Press **selection keys** to select the desired category, then press **ENTER**.
- 4 Press **selection keys** to select "RETURN", then press **ENTER**.
 - Return to the Library Database Navigation screen to confirm the modified category.
- 5 Press **NAVIGATION** to return to the normal screen.

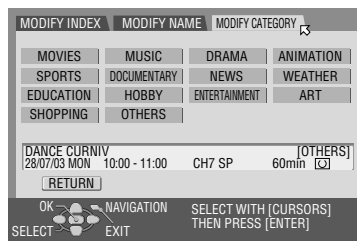

Basic Operation Of Play List Information



Play List

It is a collection of the scenes. A play list can be freely edited and played back without ever changing any original recording data. Using the random access of a disc (which allows video data to be instantly read no matter where it is on the disc), a play list includes information such as the timer counter for the playback start point and end point, indexes for checking the contents of recorded data, category information, and more. Playback according to a play list you have created allows you to enjoy various combinations of video images from a single title.

- Turn on the TV and select an input mode such as EXT1.
- Load a DVD disc to modify.

ATTENTION:
It is not possible to modify discs recorded on DVD units from other manufacturers.

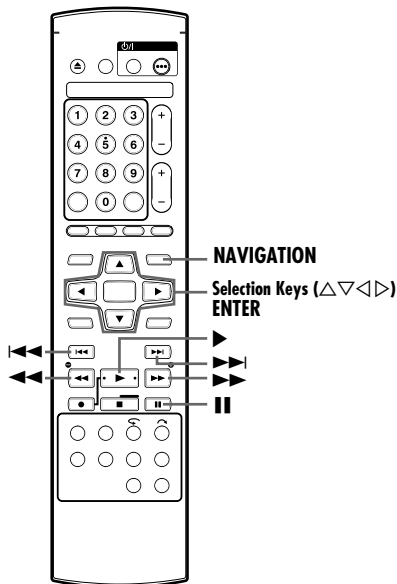

Create Play List

- 1 Press **NAVIGATION** to display the Library Database Navigation screen.
- 2 Press **selection keys** to select "PLAY LIST", then press **ENTER**.
- 3 Press **selection keys** to select "CREATE", then press **ENTER**.
- 4 Press **▶** to start playback.
 - To move to other titles, press **◀◀** or **▶▶**.
 - Press **◀◀** or **▶▶** to find the point where you want the created play list to begin, then press **||**.



- 5 Confirm the arrow is on "IN", then press **ENTER**.
 - The edit-in time is displayed on the left of the "IN" window.
- 6 Press **▶** to resume playback.
 - Press **||** to pause at the point where you want the created play list to end.
- 7 Confirm the arrow is on "OUT", then press **ENTER**.
 - The edit-out time is displayed on the left of the "OUT" window.
 - The edit-out point must come after the edit-in point.
- 8 Press **selection keys** to select "PREVIEW", then press **ENTER** to preview the play list.
 - To cancel play list creation, press **selection keys** to select "RETURN", then press **ENTER**.

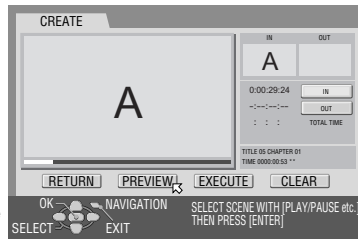

To modify the points

- 1 Press **selection keys** to select "CLEAR", then press **ENTER**.
- 2 Press **selection keys** to select "IN".
- 3 Repeat steps 3 – 8.
- 9 Press **selection keys** to select "EXECUTE", then press **ENTER**. The play list is created.
- 10 Press **NAVIGATION** to return to the normal screen.

NOTES:

- There may be a discrepancy of several seconds between the scene you intend to edit, and the scene which is actually edited.
- The title, index and category of the play list can be modified in the same way as "ORIGINAL". (pg. 46)
- You can modify the play list that has just been created here by adding, moving, or deleting unwanted parts to create a digest edition, etc.

Play Back Play List

- 1 Press **NAVIGATION** to display the Library Database Navigation screen.
- 2 Press **selection keys** to select "PLAY LIST", then press **ENTER**.
- 3 Press **selection keys** to select a play list to be played back, then press **ENTER**.
 - The unit stops when playback ends, and resumes to a broadcast receiving screen.
 - When you want the multiple play lists to be played back continuously, press **MEMO** after selecting the desired play lists. The numbers of the playback order appear on the index. (Up to 30 titles)

Delete Play List

- 1 Press **NAVIGATION** to display the Library Database Navigation screen.
- 2 Press **selection keys** to select "PLAY LIST", then press **ENTER**.
- 3 Press **selection keys** to select a play list you want to delete, then press **▽**.
- 4 Press **selection keys** to select "DELETE", then press **ENTER**.
 - The confirmation screen appears.
- 5 Press **selection keys** to select "YES", then press **ENTER**.
 - To cancel the deletion, select "NO", then press **ENTER**.
- 6 Press **NAVIGATION** to return to the normal screen.



Edit Play List Information



- Turn on the TV and select an input mode such as EXT1.
- Load a DVD disc to modify.

ATTENTION:

It is not possible to modify discs recorded on DVD units from other manufacturers.

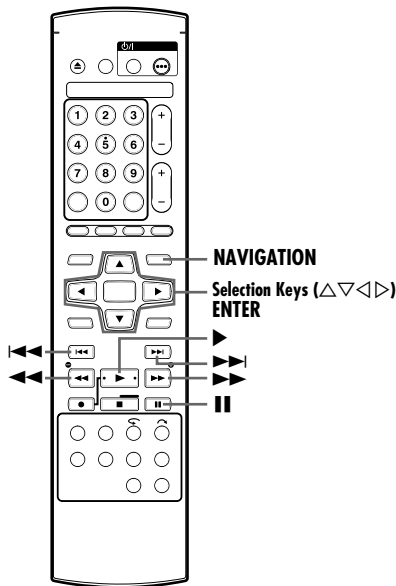

Modify Index

- 1 Press **NAVIGATION** to display the Library Database Navigation screen.
- 2 Press **selection keys** to select "PLAY LIST", then press **ENTER**.
- 3 Press **selection keys** to select a play list you want to modify, then press **▽**.
- 4 Press **selection keys** to select "MODIFY", then press **ENTER**.
- 5 Press **selection keys** to select "MODIFY INDEX", then press **ENTER**.
- 6 Press **▶** to start playback. Press **◀◀** or **▶▶** to search for the picture from the title, then press **||**.
- 7 Confirm the arrow is on "REPLACE", then press **ENTER**.
 - The new index appears on the right window.
- 8 Confirm the arrow is on "RETURN", then press **ENTER**.
 - You can confirm the new index.
- 9 Press **NAVIGATION** to return to the normal screen.

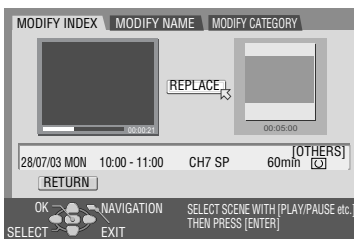
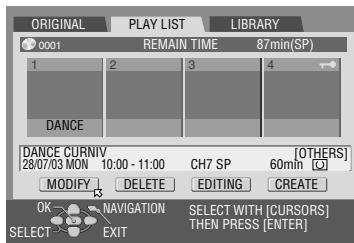

Modify Play List Name

- 1 Perform steps 1 – 4 of "Modify Index" (pg. 48) before continuing.
- 2 Press **selection keys** to select "MODIFY NAME", then press **ENTER**.
- 3 Input a new title name. See "Modify Title Name" (pg. 46).
- 4 Press **selection keys** to select "SAVE", then press **ENTER**.
- 5 Press **selection keys** to select "RETURN", then press **ENTER**.
 - Return to the Library Database Navigation screen to confirm the modified name.
- 6 Press **NAVIGATION** to return to the normal screen.

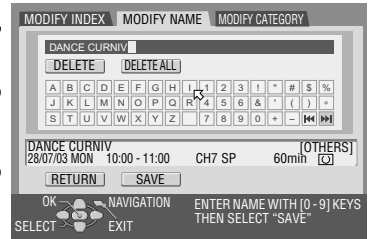

Modify Category

- 1 Perform steps 1 – 4 of "Modify Index" (pg. 48) before continuing.
- 2 Press **selection keys** to select "MODIFY CATEGORY", then press **ENTER**.
- 3 Press **selection keys** to select the desired category, then press **ENTER**.
- 4 Press **selection keys** to select "RETURN", then press **ENTER**.
 - Return to the Library Database Navigation screen to confirm the modified category.
- 5 Press **NAVIGATION** to return to the normal screen.

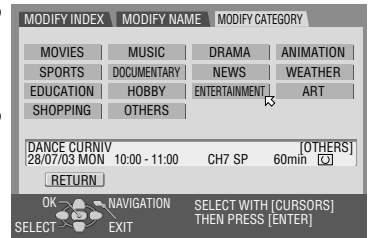

Delete Scenes

- 1 Press **NAVIGATION** to display the Library Database Navigation screen.
 - 2 Press **selection keys** to select "PLAY LIST", then press **ENTER**.
 - 3 Press **selection keys** to select a play list from which you wish to delete unwanted scenes, then press ∇ .
 - 4 Press **selection keys** to select "EDITING", then press **ENTER**.
 - 5 Press **selection keys** to select "DELETE SCENE", then press **ENTER**.
 - 6 Press \blacktriangleright to start playback.
 - Press \blacktriangleleft or \blacktriangleright to find the point where you want the deletion to begin, then press **II**.
 - 7 Confirm the arrow is on "IN", then press **ENTER**.
 - The edit-in time is displayed on the left of the "IN" window.
 - 8 Press \blacktriangleright to resume playback.
 - Press **II** to pause at the point where you want the deletion to end.
 - 9 Confirm the arrow is on "OUT", then press **ENTER**.
 - The edit-out time is displayed on the left of the "OUT" window.
 - 10 Press **selection keys** to select "PREVIEW", then press **ENTER**. A preview of the scene approximately 5 seconds before and after the deleted part is played back.
 - To cancel the deletion, press **selection keys** to select "RETURN", then press **ENTER**.
- To modify the points**
- 1 Press **selection keys** to select "CLEAR", then press **ENTER**.
 - 2 Press **selection keys** to select "IN".
 - 3 Perform steps 6 – 10.
 - 11 Press **selection keys** to select "EXECUTE", then press **ENTER**.
 - 12 Press **NAVIGATION** to return to the normal screen.

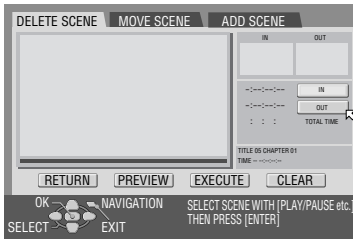
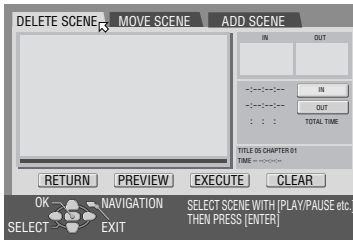
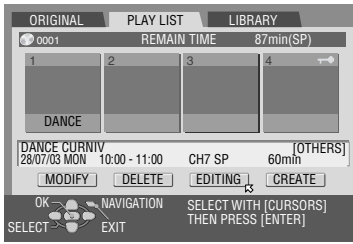

Move Scenes

- 1 Press **NAVIGATION** to display the Library Database Navigation screen.
 - 2 Press **selection keys** to select "PLAY LIST", then press **ENTER**.
 - 3 Press **selection keys** to select a play list which you wish to move a scene, then press ∇ .
 - 4 Press **selection keys** to select "EDITING", then press **ENTER**.
 - 5 Press **selection keys** to select "MOVE SCENE", then press **ENTER**.
 - 6 Press \blacktriangleright to start playback.
 - Press \blacktriangleleft or \blacktriangleright to find the point where you want the moved scene to begin, then press **II**.
 - 7 Confirm the arrow is on "IN", then press **ENTER**.
 - The edit-in time is displayed on the left of the "IN" window.
 - 8 Press \blacktriangleright to resume playback.
 - Press **II** to pause at the point where you want the moved scene to end.
 - 9 Confirm the arrow is on "OUT", then press **ENTER**.
 - The edit-out time is displayed on the left of the "OUT" window.
 - 10 Press \blacktriangleright to start playback.
 - Find the point where you want the moved scene to be moved, then press **II**.
 - 11 Confirm the arrow is on "MOVE TO", then press **ENTER**.
 - 12 Press **selection keys** to select "PREVIEW", then press **ENTER**. A preview of approximately 5 seconds before and after the point to which the scene has been moved is played back.
 - To cancel the moving, press **selection keys** to select "RETURN", then press **ENTER**.
- To modify the points**
- 1 Press **selection keys** to select "CLEAR", then press **ENTER**.
 - 2 Press **selection keys** to select "IN".
 - 3 Perform steps 6 – 12.
 - 13 Press **selection keys** to select "EXECUTE", then press **ENTER**.
 - 14 Press **NAVIGATION** to return to the normal screen.

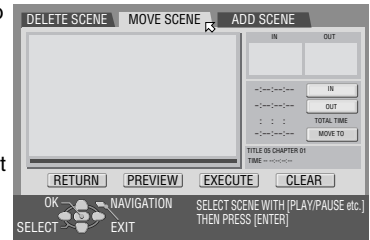
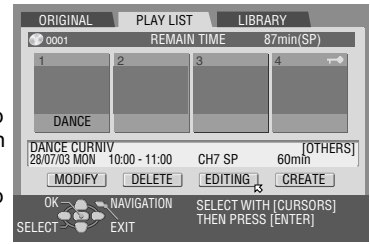

Add scenes

- 1 Press **NAVIGATION** to display the Library Database Navigation screen.
- 2 Press **selection keys** to select "PLAY LIST", then press **ENTER**.
- 3 Press **selection keys** to select a play list to which you wish to add a scene, then press **▽**.
- 4 Press **selection keys** to select "EDITING", then press **ENTER**.
- 5 Press **selection keys** to select "ADD SCENE", then press **ENTER**.
- 6 Press **▶** to start playback.
 - To move to other titles, press **◀◀** or **▶▶**
 - Press **◀◀** or **▶▶** to find the point where you want the created play list to begin, then press **II**.
- 7 Perform steps 5 – 10 of "Create Play List" (pg. 47).

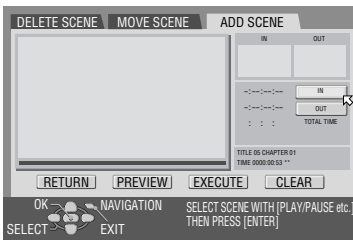

Edit Library Information



Each disc recorded on this unit is automatically numbered. If this number is retained, it is possible to find out the titles recorded in a disc quickly. Title information can be registered in the unit's memory for up to 1300 titles.

NOTE:

If you do not want the information to be registered in the library automatically, set "SAVE AS LIBRARY" to "OFF". (pg. 59)

- Turn on the TV and select an input mode such as EXT1.

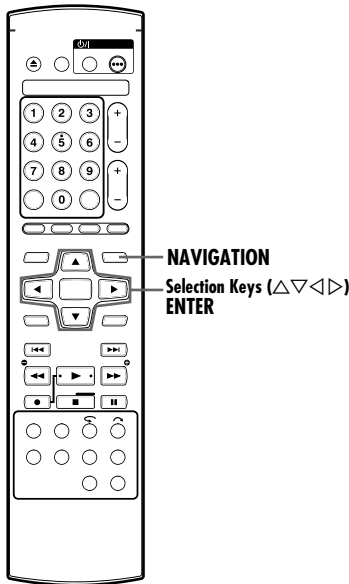

Scan For Title From Library

- 1 Press **NAVIGATION** to display the Library Database Navigation screen.
- 2 Press **selection keys** to select "LIBRARY", then press **ENTER**.
- 3 Select the appropriate sort button to sort the information, then press **ENTER**.
 - "DISC No.": Sort by disc number.
 - "CATEGORY": Sort by category.
 - "DATE": Sort by date.
 - "NAME": Sort by name.
- 4 Press **selection keys** to select the desired title, then press **ENTER**.
 - If the disc loaded on this unit contains the selected title, the selected title and all subsequent titles will be played back.



When the disc that contains the selected title is not loaded
A prompt screen appears. Load the disc after pressing **ENTER** to close the prompt screen. Then perform steps 1 – 4.

NOTE:

If a disc registered in the library is recorded or modified on DVD units from other manufacturers, it may become impossible to operate properly.

Register Disc

When a disc that is not recorded on this unit or not registered in the library is loaded, a message appears confirming if the disc should be registered. If registering, perform the following procedure.

- 1 Press **NAVIGATION** to display the Library Database Navigation screen.
- 2 Press **selection keys** to select "LIBRARY".
 - The registration confirmation screen appears.
- 3 Press **selection keys** to select "REGISTER", then press **ENTER**.
 - To quit registration, select "CANCEL", then press **ENTER**.
- 4 Press **NAVIGATION** to return to the normal screen.

NOTES:

- It is not possible to register discs used for On-Disc Timer Programming. (pg. 39)
- It is not possible to register discs formatted on devices other than JVC's DVD recorders.
- It is not possible to register discs recorded on devices other than JVC's DVD recorders.

Delete Information

- 1 Perform steps 1 – 3 of "Scan For Title From Library" (pg. 51) before continuing.
- 2 Press **selection keys** to select a title whose information you want to delete, then press **▽**.
- 3 Press **selection keys** to select "DELETE", then press **ENTER**.
 - The confirmation screen appears.
- 4 Press **selection keys** to select "DELETE", then press **ENTER**.
 - To cancel the information deletion, select "CANCEL", then press **ENTER**.
- 5 Press **NAVIGATION** to return to the normal screen.

Playback With MP3/JPEG Navigation



This unit can play back discs that MP3 sound files and JPEG image files taken with digital still cameras or other devices are recorded.

The MP3/JPEG Navigation enables you to search and select the desired files recorded on CD-R/RW or CD-ROM discs very easily.

- Turn on the TV and select an input mode such as EXT1.

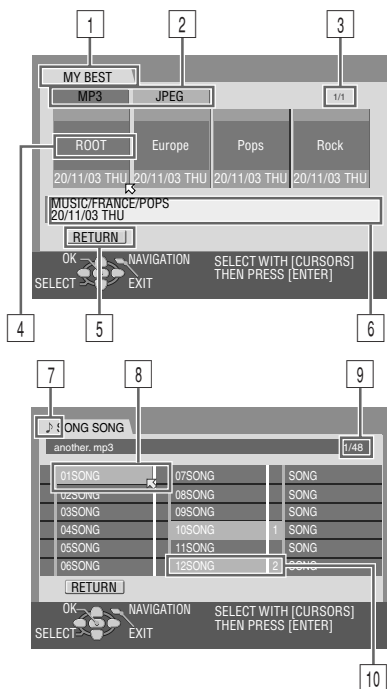

- 1 Name of the inserted disc
- 2 Sort buttons ("MP3" / "JPEG")
- 3 Selected group number/total number of groups on the disc
- 4 Group name
- 5 Return button
- 6 Group name/Created date
- 7 File type indicator
♪ : MP3
📷 : JPEG
- 8 Selected file
- 9 Selected file number/total number of files in the group that contains the selected file
- 10 Program number/file name

Locating The Desired Group And Tracks

- 1 Load a disc.
- 2 Press **NAVIGATION**.
- 3 Press **selection keys** to select "MP3" or "JPEG", then press **ENTER**.
- 4 Press **selection keys** to select the desired group, then press **ENTER**.
 - A list of files in the selected group appears.
- 5 Press **selection keys** to select a file you want to play back, then press **ENTER**. The unit starts playback from the selected file.
 - Playback stops when all the files in the selected group are played back.

NOTES:

- If you press ► instead of **ENTER** in step 4, the unit starts playback from the first file of the group.
- JPEG files are played back as a slide show at the set intervals. (pg. 33)
- If a file name includes any 2 byte character, the unit may not show the file name correctly.
- The order of the groups and items shown in steps 4 and 5 may differ from the order shown on your PC.
- When you want the multiple files to be played back continuously, press **MEMO** instead of **ENTER** in step 5. Playbacks in the specified order when ► is pressed. (Up to 30 titles)
- If you have specified a wrong selection, press **CANCEL**. Or press **CLEAR**(■), all the title numbers are erased.

After all the files are played back

- 1 Perform steps 1 – 4.
- 2 Press **CLEAR**(■).
 - The title numbers are reset and erased.
- 3 Press **NAVIGATION** to return to the normal screen.

DV Dubbing

You can dub programs from a camcorder or DV equipment connected to the unit with a DV cable. The unit's remote control allows you the limited control of the connected camcorder or DV equipment functions during dubbing.

NOTES:

- Use the DV cable VC-VDV 204U for connection.
- When you connect a PC to the [DV IN] connector, we do not assure the normal operation of this unit.

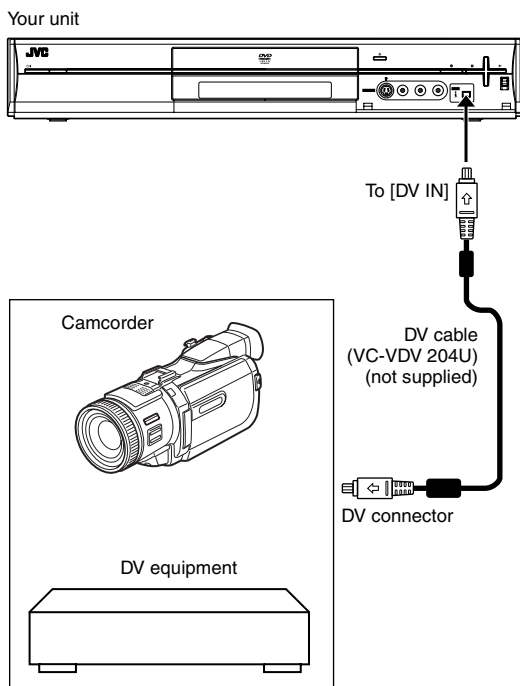

The following on-screen display for DV dubbing appears when **ON SCREEN** is pressed while the channel has been set to "DV".

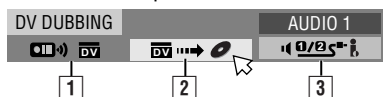

1 DV dubbing controller

If this mark is not displayed, check whether the DV equipment has been connected to the unit.

2 Auto capture button

Select to start or pause the dubbing. If **ENTER** is pressed when the DV device is in the pause condition, preroll editing* where it is possible to dub with a start time that is highly accurate will be activated. When the DV device cannot be operated from the unit (such as in camera mode), proceed with normal recording (see pg. 34).

* Preroll editing refers to the playback after the DV tape is slightly rewind. (For DV devices that do not support the -1x speed, the rewinding time may be longer.)

3 Sound monitor switch

For selecting the desired sound format for dubbing.

- 1 Connect a camcorder or DV equipment to the [DV IN] connector on the unit's front panel.
- 2 Press **CH +/-** to set the channel to "DV".
 - The on-screen display for DV dubbing appears.
- 3 Press **REC MODE** repeatedly to set the recording mode.
- 4 Locate the point from where you want to start dubbing, then stop or pause playback by pressing the following buttons on the remote control: **>**, **>>**, **<<**, **■**, **||**.
 - To play back in slow speed (1/10 of the normal speed), press **||** to pause playback, then press **<<** or **>>**.
 - To play back frame-by-frame, press **||** to pause playback, then press **||** repeatedly. Each press of **||** advances a frame.
 - To change the playback direction, press **<<** or **>>**.
- 5 Press **selection keys** to select **1/2/5+1**, then press **ENTER** repeatedly until the desired sound track appears on the TV screen.

AUDIO 1:

Select this to record the original stereo sound played back on the connected DV equipment.

AUDIO 2:

Select this to record the dubbed stereo sound played back on the connected DV equipment.

MIX:

Select this to record the sound of both "AUDIO 1" and "AUDIO 2".

- Note that this selection is not available when the source program is recorded in 16BIT (48 kHz) mode.

- 6 Press **selection keys** to select **DV →**, then press **ENTER**. The dubbing starts.
 - Playback on the external DV equipment and recording on the unit should start simultaneously.
 - To pause dubbing, press **selection keys** to select **DV →**, then press **ENTER**. Both the unit and the external DV equipment pause dubbing.
 - To resume dubbing, press **selection keys** to select **DV →**, then press **ENTER** to start dubbing.
- 7 Press **■** to stop dubbing.
 - Both the unit and the external DV equipment stop dubbing.

NOTES:

- Dubbing copyrighted programs is not possible.
- Original DV information such as the recording date and time are not recorded.
- The superimposed indication during the operation or dubbing is not recorded.
- If the dubbing is paused while the channel is set to "DV", you cannot switch channels.
- Only DV format video can be dubbed. It is not possible to dub MPEG2 format video.

When you dub from DV equipment other than a camcorder

- 1 Perform steps 1 – 3.
- 2 Locate the point from where you want to start dubbing, then stop on the DV equipment.
 - If you pause the DV equipment in this step, a few second's still picture will be recorded at the beginning of the recorded program.
- 3 Set the input mode to "DV INPUT" on the DV equipment.
 - If input mode is set to other than "DV INPUT", unwanted pictures may be recorded at the beginning of the recorded program.
- 4 Perform steps 6 and 7.

To skip unwanted part of the source picture

Press **ENTER** to stop both equipment, press **>**, **>>** or **<<** to locate the point where you want to resume dubbing, then press **■**. Press **selection keys** to select **DV →**, then press **ENTER** to start dubbing.

Edit From A Camcorder

You can use a camcorder as the source player and your unit as the recording deck.

1 If the camcorder has no S-VIDEO output connector:

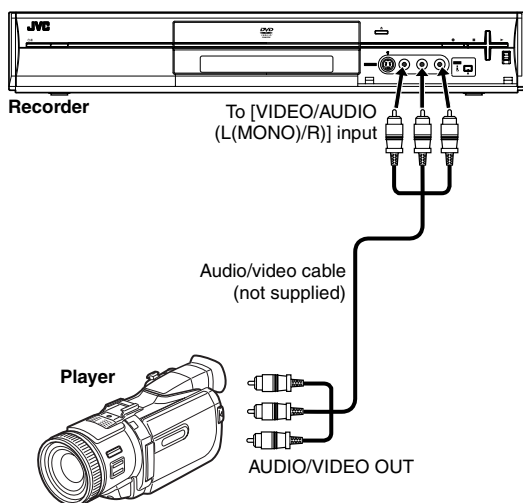

2 If the camcorder has an S-VIDEO output connector:

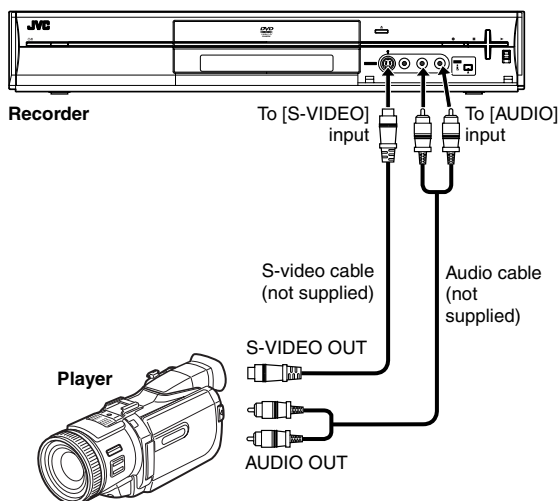

1 Make connections.

- 1 If the camcorder has no S-VIDEO output connector:
 - connect the camcorder's AUDIO/VIDEO OUT connectors to the unit's [VIDEO/AUDIO (L(MONO)/R)] input connectors on the front panel.
 - When using a monaural camcorder, connect its AUDIO OUT connector to the [AUDIO(L(MONO))] input connector on your unit.
- 2 If the camcorder has an S-VIDEO output connector:
 - connect the camcorder's AUDIO and S-VIDEO OUT connectors to the unit's [AUDIO] and [S-VIDEO] input connectors on the front panel.

2 Press CH +/- to select "F-1".

- Set "FRONT AUX F-1" to "VIDEO" for the [VIDEO] input connector, or "S-VIDEO" for the [S-VIDEO] input connector, depending on the connector being used. (pg. 59)

3 Press REC MODE repeatedly to set the recording mode.

4 Start playback on the camcorder slightly before the actual point from where you wish to start dubbing.

5 Press ● on the unit to start recording. Or while holding ●, press ► on the remote control. The dubbing starts.

6 Upon completing dubbing, stop the unit and the camcorder.

- Stop recording on the recording deck (your unit), then stop playback on the source player (camcorder).

NOTES:

- All necessary cables can be obtained from your dealer.
- Refer to the camcorder's instruction manual for operating procedure.
- The quality of dubbed picture are poorer than that of the original.

Edit To Or From Another Recorder

You can use your unit as the source player or as the recording deck.

NOTE:

When using another recorder as the recording deck, refer to its instruction manual.

1 When using your unit as the source player

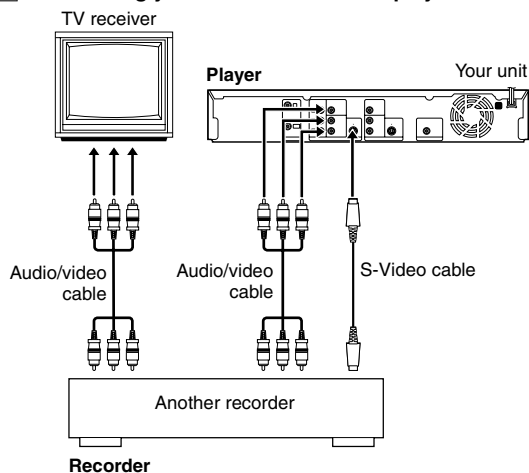

2 When using your unit as the recording deck

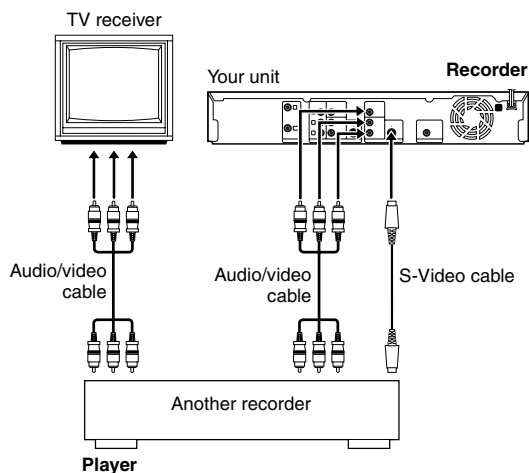

1 Make connections.

- 1 When using your unit as the source player
 - connect its [S-VIDEO/VIDEO/AUDIO OUTPUT] connectors to the input connectors on another recorder.
- 2 When using your unit as the recording deck
 - connect its [L-1/F-1] connectors on the front or rear panel to the output connectors on another recorder.
 - When connecting to another recorder with S-Video connector, set “REAR AUX L-1” or “FRONT AUX F-1” to “S-VIDEO”.

2 Press **CH +/-** to select the external input.

- Select “F-1” when the source player is connected to the unit’s [VIDEO/AUDIO] or [S-VIDEO/AUDIO] input connectors on the front panel, and select “L-1” when it is connected to the unit’s [VIDEO/AUDIO] or [S-VIDEO/AUDIO] input connectors on the rear panel.

3 Press **REC MODE** repeatedly to set the recording mode.

4 Engage play mode on the source player.

5 Engage record mode on the recording deck.

6 Stop recording on the recording deck, then stop playback on the source player.

NOTES:

- All necessary cables can be obtained from your dealer.
- When you use this unit as the source player for editing, be sure to set “SUPERIMPOSE” or “OFF” before starting. (pg. 59)

Digital Audio Dubbing

You can dub selected audio from a DVD or Audio CD disc to a digital audio device.

However, it is not possible to dub copy-protected discs.

- Turn on the TV and select an input mode such as EXT1.

Example: Dubbing to an MD

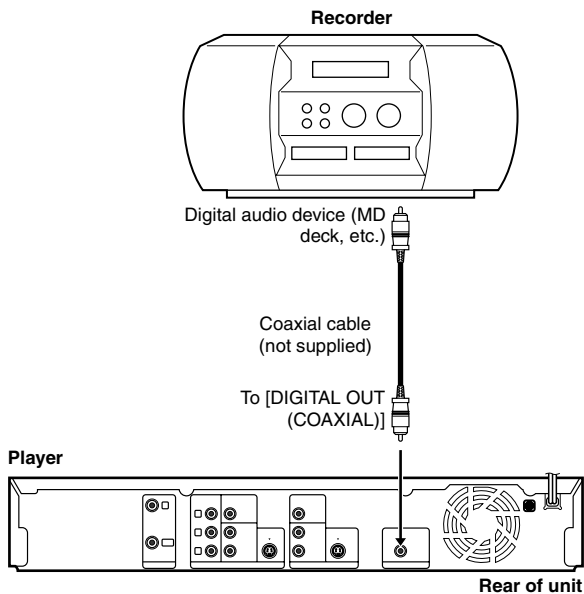

- 1 Connect the unit and a digital audio device using an optional coaxial cable.
- 2 Place a disc on the unit and load an MD on the connected digital audio device.
- 3 Select the audio to be dubbed.
- 4 Start playback slightly before the actual point from where you wish to start dubbing.
- 5 Press **II** to pause playback.
- 6 Select the input mode on the connected digital audio device.
- 7 Press **▶** to start playback on the unit.
- 8 Start recording on the digital audio device.
- 9 Stop recording on the digital audio device. Then press **■** to stop playback on the unit.

NOTE:

There may be a discrepancy of several seconds between where you intend editing to start, and where it actually starts.

Remote Control Functions

Remote Control 1/2/3/4 Code Switching

The remote control is capable of controlling four JVC video units independently. Each of the units can respond to one of the four codes (1, 2, 3 or 4). The remote control is preset to send code 3 signals because your unit is initially set to respond to code 3 signals. You can easily modify your unit to respond to code 1, 2 or 4 signals.

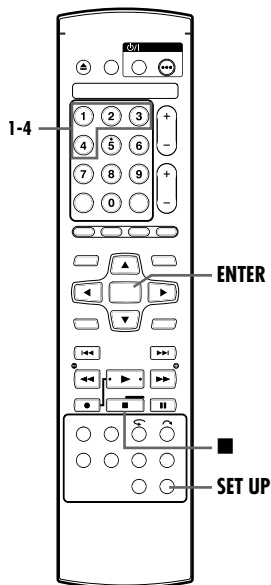
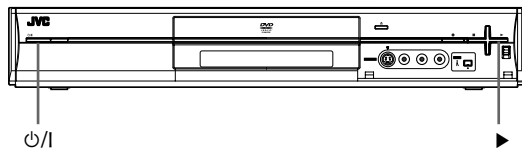

- Keep pressing **SET UP** down during step 1.

- 1 Press the number key "1" for 1, "2" for 2, "3" for 3 or "4" for 4 to change the remote control code, then press **ENTER**.
- 2 Press O/I on the unit to turn off the unit.
- 3 Press \blacktriangleright on the unit for over 5 seconds while the unit is turned off. The code currently set appears on the front display panel.
- 4 Press \blacksquare on the remote control to change the unit's code. The code currently set on the remote control blinks on the front display panel for approximately 5 seconds, and is applied to the unit.

Connecting To A Dolby Digital Decoder Or An Amplifier With Built-in DTS

These instructions enable you to connect your unit to a Dolby Digital Decoder or an amplifier with built-in DTS.

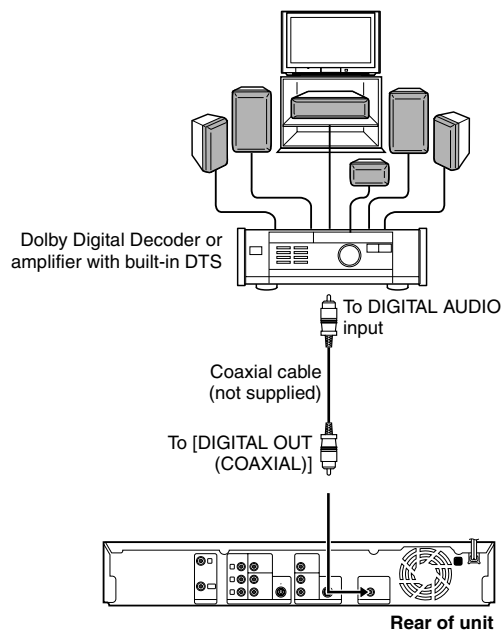

- 1 Connect the unit and a Dolby Digital Decoder or an amplifier with built-in DTS using an optional coaxial cable.

NOTE:

For details on [DIGITAL OUT] connector setting, refer to "DIGITAL AUDIO OUT". (pg. 58)

Mode Set

- Turn on the unit.
- Turn on the TV and select an input mode such as EXT1.

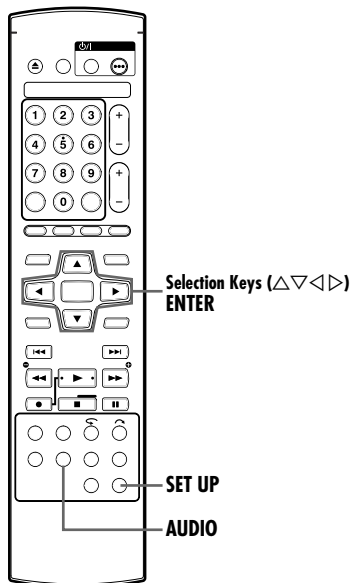

Various modes of this unit are categorized into menus nested in 2 levels shown in the following table. To change the settings of these modes, find the desired mode in the menu, then follow the procedure below. (For details on each menu, see pages 58 through 59)

DVD SET UP	LANGUAGE SET (pg. 18) AUDIO OUTPUT (pg. 58) UTILITY (pg. 62, 63)
FUNCTION SET UP	VIDEO IN/OUT (pg. 21, 59) RECORDING SET (pg. 59) DISPLAY SET (pg. 59) OTHERS (pg. 60)
INITIAL SET UP	TUNER SET (pg. 20) CLOCK SET (pg. 19)

- The procedure below shows how to set the desired option of the "2ND AUDIO RECORD" mode as an example.

1 Press **SET UP** to access the Main Menu screen.

2 Press **selection keys** to select "FUNCTION SET UP", then press **ENTER**.

3 Press **selection keys** to select "RECORDING SET", then press **ENTER**.

4 Press **selection keys** to select "2ND AUDIO RECORD", then press **ENTER**.

5 Press **selection keys** to select the desired setting, then press **ENTER**.

6 Press **SET UP** to complete the setting.

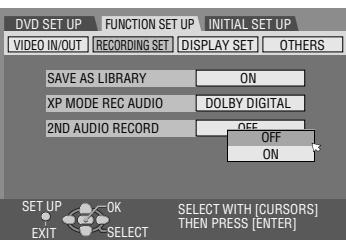

* The **boldface** settings below indicate the settings at your purchase.

AUDIO OUTPUT

■ DIGITAL AUDIO OUT — DOLBY DIGITAL/PCM / STREAM/PCM / PCM ONLY

Set to the appropriate mode according to the type of the device connected to [DIGITAL OUT] connector.

DOLBY DIGITAL/PCM:

Select this when you connect the digital input connector of a Dolby Digital Decoder or an amplifier with a built-in Dolby Digital Decoder.

STREAM/PCM:

Select this when you connect the digital input connector of an amplifier with a built-in DTS, Dolby Digital, or MPEG multichannel decoder.

PCM ONLY:

Select this when you connect the linear PCM digital input of other audio equipment (amplifier, MD or DAT deck, etc.).

NOTE:

If you watch or play back a program recorded on a DVD-RAM or DVD-RW (VR mode only) disc which contains multiple audio languages, select "PCM ONLY" in advance and choose main or sub audio with **AUDIO**.

■ ANALOG AUDIO OUT — STEREO / DOLBY SURROUND

Select the appropriate setting to accommodate the unit to the connected A/V equipment. This function takes effect when a DVD VIDEO disc is played back.

STEREO:

Select this when listening to conventional two-channel stereo audio with the unit's [AUDIO OUTPUT] connectors connected to a stereo amplifier/receiver or TV set, or in case you want to record the audio from a DVD VIDEO disc to a Mini Disc, etc.

DOLBY SURROUND:

Select this when listening to audio with the unit's [AUDIO OUTPUT] connectors connected to an amplifier/receiver with a built-in surround decoder or a surround decoder.

■ D. RANGE CONTROL — NORMAL / WIDE RANGE / TV MODE

The dynamic range (the difference between the loudest sound and the quietest one) can be compressed during playback of a program encoded in Dolby Digital format.

This function takes effect when a DVD VIDEO disc recorded in Dolby Digital format is played back at low or middle volume.

NORMAL:

Normally select this setting to activate this function.

WIDE RANGE:

Select this to deactivate this function when you enjoy wide dynamic range program.

TV MODE:

Select this when connecting to a TV. Even soft sound can be well heard.

NOTES:

- This function has no effect on programs other than those recorded in Dolby Digital format.
- The effect of "NORMAL" and "WIDE RANGE" may not be different depending on discs.

■ OUTPUT LEVEL — STANDARD / LOW

You can lower the output level of analogue audio to accommodate the unit to the connected A/V equipment.

STANDARD:

Normally select this setting.

LOW:

The output level of analogue audio is lowered.

VIDEO IN/OUT

■ MONITOR TYPE — 4:3LB / 4:3PS / 16:9AUTO / 16:9FIX

For details, refer to "Monitor Set" (pg. 21).

■ FRONT AUX F-1 — VIDEO / S-VIDEO

Select the appropriate mode depending on the F-1 connector ([VIDEO] or [S-VIDEO]) being used on the front panel.

VIDEO:

To use the [VIDEO] input connector.

S-VIDEO:

To use the [S-VIDEO] input connector.

■ REAR AUX L-1 — VIDEO / S-VIDEO

Select the appropriate mode depending on the L-1 connector ([VIDEO INPUT] or [S-VIDEO INPUT]) being used on the rear panel.

VIDEO:

To use the [VIDEO INPUT] connector.

S-VIDEO:

To use the [S-VIDEO INPUT] input connector.

RECORDING SET

■ SAVE AS LIBRARY — OFF / ON

When this function is set to "ON", the recording information is automatically stored in the library. For details, refer to "Edit Library Information" (pg. 51).

■ XP MODE REC AUDIO — DOLBY DIGITAL / LINEAR PCM

You can select the audio format when you record a title in XP mode. When this function is set to "LINEAR PCM", you can obtain a high-quality audio sound.

DOLBY DIGITAL:

To record in Dolby Digital format.

LINEAR PCM:

To record in Linear PCM format.

■ 2ND AUDIO RECORD — OFF / ON

When this function is set to "ON", if a SAP program is received, the SAP audio is recorded on L/R tracks. The main audio is not recorded. If a non-SAP program is received, the main audio is recorded on L/R tracks.

When this function is set to "OFF", the SAP audio cannot be recorded.

NOTE:

When the channel is changed on the unit;

- The "MONO" indicator appears on the screen for about 5 seconds if the program is a monaural broadcast.
- The "STEREO" indicator appears on the screen for about 5 seconds if the program is a stereo broadcast.
- Both "STEREO" and "SAP" indicators appear when a stereo program is accompanied by SAP sound.
- Both "MONO" and "SAP" indicators appear when the main audio on the monaural broadcast is accompanied by SAP sound.

DISPLAY SET

■ SUPERIMPOSE — OFF / AUTO

When this function is set to "AUTO", various operational indicators appear on the TV screen.

OFF:

To turn off superimposed indications.

AUTO:

To superimpose operational indications for approximately five seconds just after the corresponding operation.

NOTES:

- Even when "SUPERIMPOSE" is set to "OFF", you can display the various operational indicators by pressing **ON SCREEN** on the remote control. To clear the operational indicators, press **ON SCREEN** again.
- When you use this unit as the source player for editing, be sure to set "SUPERIMPOSE" to "OFF" before starting. (pg. 55)
- When you select "AUTO", during playback, the operation mode indicators may be disturbed depending on the type of disc being used.

■ GRAY BACK — OFF / ON

OFF:

Select this when you want to receive an unstable channel with poor signals.

ON:

When this function is set to "ON", the TV screen becomes all gray when receiving a channel not in use.

■ DIMMER — BRIGHT / DIMMED1 / DIMMED2 / OFF

You can change the brightness of the front display panel.

BRIGHT:

Normally select this. To turn on the display and blue lamp of the front display panel.

DIMMED1/DIMMED2:

To change the brightness level, and turn off the blue lamp of the front display panel.

OFF:

To turn off the display and blue lamp of the front display panel.

■ POWER SAVE — OFF / ON

When this function is set to "ON", you can reduce the power consumption while the unit is turned off.

NOTES:

- During Power Save mode —
— the front display panel will be turned off.
- Power Save does not work when —
— the Automatic Satellite Program Recording mode is engaged.

■ ON SCREEN LANGUAGE — ENGLISH / FRANCAIS / ESPAÑOL

This unit offers you the choice to view on-screen messages in 3 different languages.

- For details, refer to "On-screen Language Set" (pg. 18).

OTHERS**■ AUTO TIMER — OFF / ON**

This is the setting for engaging timer recording standby mode.

OFF:

Press  to engage timer recording standby mode.

ON:

Timer recording standby mode is automatically engaged when the unit is turned off.

■ RESUME — OFF / ON / DISC RESUME

When this function is set to “ON” or “DISC RESUME”, you can use the resume function. (pg. 24)

OFF:

You cannot use the resume function.

ON:

The resume function works on the disc loaded on the unit.

DISC RESUME:

The unit retains a memory of the resume points of the last 30 discs played back, even though they have been ejected.

NOTE:

“DISC RESUME” setting works on DVD-VIDEO, VCD, SVCD and finalized DVD-R/DVD-RW (Video mode) discs. For other types of discs, the function under “ON” setting will be applied even if “RESUME” is set to “DISC RESUME”.

Scan Mode Set

If you connect the unit and TV with Component Video Connection (pg. 12), you can select the scan mode from two modes: Interlaced scan mode which is used in the conventional TV system, and Progressive scan mode which enables reproduction of higher-quality images.

■ Interlaced scan

In the conventional video system, a picture is shown on the display monitor in two halves. The Interlaced scan system places lines of the second half of the picture in-between lines of the first half of the picture.

■ Progressive scan

Progressive scan displays all the horizontal lines of a picture at one time, as a single frame. This system can convert the interlaced video from DVD into progressive format for connection to a progressive display. It dramatically increases the vertical resolution.

ATTENTION:

- Your TV needs to be compatible with Progressive.
- Connect the unit and the TV using a component video cable.

- Turn on the unit.
- Turn on the TV and select an input mode such as EXT1.

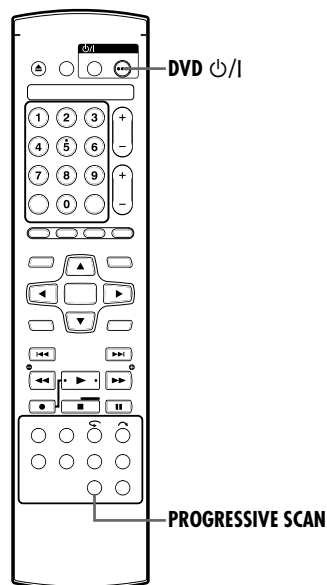

- 1 Press **PROGRESSIVE SCAN** for 3 or more seconds.
 - Video output indicator () lights on the front display panel if Progressive scan mode has been established. (pg. 13)
 - Each press of **PROGRESSIVE SCAN** for 3 or more seconds switches the scan mode.

NOTES:

- Progressive scan video signal is output from the [COMPONENT VIDEO OUT (Y/Pb/Pr)] connectors. It will not be output from the [VIDEO OUTPUT] and [S-VIDEO OUTPUT] connectors.
- Interlaced scan mode is the setting at your purchase.
- Interlaced scan mode might be suitable depending on video material.
- Scan mode cannot be set while menu screen is displayed.

Tray Lock

You can lock the disc tray to prohibit the unwanted disc ejection by children.

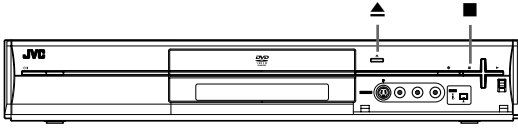

To lock tray

When the unit is turned off, while holding ■, press ▲ on the unit. "LOCK" appears on the front display panel and the disc tray is locked.

To unlock tray

When the unit is turned off, while holding ■, press ▲ on the unit. "UNLOCK" lights up on the front display panel.

Child Lock

You can disable the operations of this unit using the Child Lock function.

- Turn on the unit.

- 1 When the unit is turned on, press and hold **DVD** ⏪/I on the remote control for more than 10 seconds.
 - The unit turns off and enters into Child Lock mode.
 - When in Child Lock mode, "CL" will appear on the front display panel indicating that Child Lock mode is engaged when an attempt was made to operate buttons on the unit or remote control.
- 2 Press and hold **DVD** ⏪/I on the remote control for more than 10 seconds.
 - Child Lock is released and the unit turns on.

NOTE:

When in Child Lock mode, pressing **TIMER** ⊖ during timer recording releases Child Lock and recording is continued.

Changing VCR Plus+ Setting

The VCR Plus+ programming system assigns a VCR Plus+ guide channel number to the TV channels and the cable channels. These guide channel numbers are also called the VCR Plus+ channel codes.

Most TV listings have a section, usually a chart, indicating the guide channel numbers assigned to each station. To ensure that VCR Plus+ timer recording operates correctly, it is necessary to set the VCR Plus+ Guide Channel for each station.

If you have moved to a different area or if a broadcasting station's channel number has been changed, perform the steps on the right column to set the correct guide channel number.

NOTES:

- In many instances, the VCR Plus+ guide channel numbers for cable and broadcast TV stations DO NOT match the channel number on which it is received by your unit. Check your TV listing, or contact your cable supplier for details.
- Many TV stations can be viewed on cable. Check your TV listing, or contact your cable supplier for details.

- Turn on the unit.
- Turn on the TV and select an input mode such as EXT1.

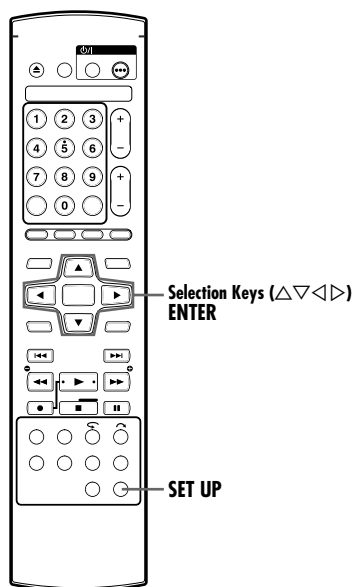

Guide Channel Number Set

- 1 Press **SET UP** to access the Main Menu screen.
- 2 Press **selection keys** to select "INITIAL SET UP", then press **ENTER**.
- 3 Press **selection keys** to select "TUNER SET", then press **ENTER**.
- 4 Press **selection keys** to select "GUIDE CHANNEL SET", then press **ENTER**.
- 5 Press **selection keys** to select "GUIDE CH", then press **ENTER**.
- 6 Press **selection keys** to select the Guide Channel number for the desired station as shown in the TV listings, then press **ENTER**.
 - To change the Guide Channel number in 10 channel increments, press and hold Δ ▽.
- 7 Press **selection keys** to select "DVD CH", then press **ENTER**.
- 8 Press **selection keys** to select the channel number of the unit on which desired broadcast is received, then press **ENTER**.
 - Repeat steps 4 – 8 as necessary.
- 9 Press **SET UP** to complete the setting.

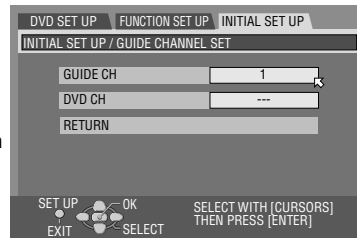
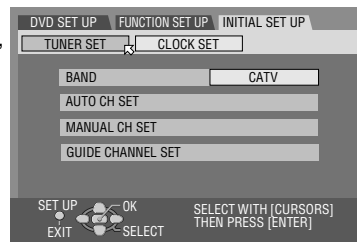

Guide Channel Number

"Guide Channel (GUIDE CH) Number" refers to the assigned TV station numbers, according to broadcast area, for the VCR Plus+ timer recording. The Guide Channel Numbers can be found in most TV listings.

Format A Disc



Some DVD-RAM/RW discs are unformatted. Format the disc when you use an unformatted disc or you want to delete all recordings and data on the disc.

ATTENTION:

- When a disc is formatted, all recordings and data are erased. It is impossible to restore them.
- Never turn off the unit or disconnect the AC power cord while "NOW FORMATTING..." is displayed on the TV screen.

- Turn on the unit.
- Turn on the TV and select an input mode such as EXT1.
- Load a DVD-RAM/RW disc to format.

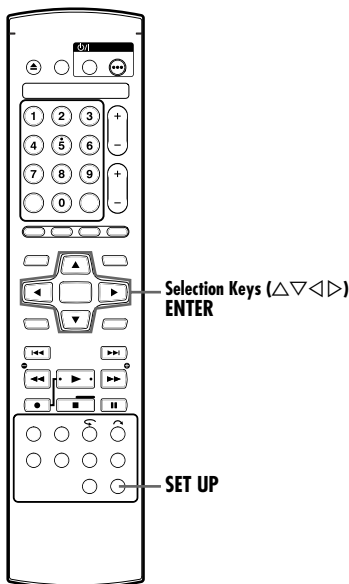

Format A DVD-RAM Disc

- 1 Press **SET UP** to access the Main Menu screen.
- 2 Press **selection keys** to select "DVD SET UP", then press **ENTER**.
- 3 Press **selection keys** to select "UTILITY", then press **ENTER**.
- 4 Press **selection keys** to select "FORMAT", then press **ENTER**.
 - The confirmation screen appears.
- 5 Press **selection keys** to select "YES", then press **ENTER**.
 - The confirmation screen appears.
- 6 Press **selection keys** to select "OK", then press **ENTER**.
- 7 Upon completing formatting, "COMPLETED" appears on the TV screen. Press **ENTER** to complete formatting.
- 8 Press **SET UP** to return to the normal screen.

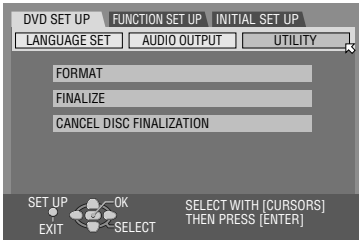

Format A DVD-RW Disc

- 1 Perform steps 1 – 3 of "Format A DVD-RAM Disc" as above before continuing.
- 2 Press **selection keys** to select "FORMAT", then press **ENTER**. Press **selection keys** to choose "VR MODE" or "VIDEO MODE", then press **ENTER** when "DISC WILL BE FORMATTED" appears on the TV screen.

"VR MODE":
To be chosen when you want to record, erase, or edit data on the disc repeatedly.

"VIDEO MODE":
To be chosen when you want to erase all the data on the disc once played back to record new data, or play back the disc on other DVD players.
- 3 Press **selection keys** to select "YES", then press **ENTER**.
- 4 Upon completing formatting, "COMPLETED" appears on the TV screen. Press **ENTER** to complete formatting.
- 5 Press **SET UP** to return to the normal screen.

NOTES:

- It is impossible to format Version 1.0 DVD-RW discs in Video mode.
- It is impossible to format DVD-R discs.
- All the titles on a disc will be deleted once the disc is formatted even if they are protected titles.

Finalize A Disc



Finalizing DVD-R/RW discs recorded on this unit makes it possible for the discs to be played back on other DVD players. DVD-RW discs are finalized in the mode that the discs were formatted, enabling playback on compatible DVD players. Title names input in the Library Database Navigation are registered as title names in the DVD menu. (pg. 51)

ATTENTION:

- Never turn off the unit or disconnect the AC power cord while finalization or cancellation of finalization is in progress.

- Turn on the unit.
- Turn on the TV and select an input mode such as EXT1.
- Load a DVD-R/RW disc to finalize.

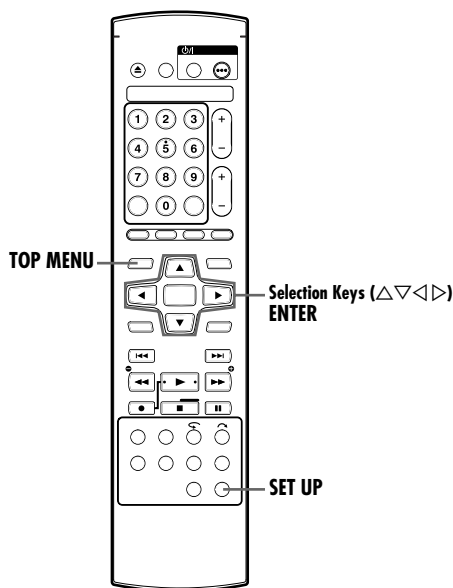

Before finalizing

- It is possible to record on a blank space.
- It is possible to enter title names. (pg. 46)
- It is possible to delete titles. (pg. 44)
- It is impossible to overwrite recorded areas of DVD-R discs.
- Available recording capacity does not increase even if a recorded program is deleted from a DVD-R disc.
- It is impossible to record or edit DVD-R/RW discs recorded on other devices even if they have not been finalized.

After finalizing (For DVD-R/RW (Video mode) discs)

- Video and audio that are recorded in conformity to the DVD Video standard before finalizing enables you to play back the discs as DVD VIDEO discs.
- Although DVD-R/RW discs finalized on this unit become playable on DVD players compatible with DVD-R/RW discs, some discs still may not play, for which JVC cannot take responsibility.
- Marked points marked before finalizing will be deleted, and titles will be divided automatically into "chapters" approximately every 5 minutes. (pg. 9, 25)
- Depending on the DVD players and DVD-R/RW discs used, and on the conditions of recording, it may not be possible to play back the discs. In this case, play back the discs on this unit.
- Additional recordings become impossible.

Finalize A DVD-R/RW Disc

- 1 Perform steps 1 – 3 of "Format A DVD-RAM Disc" (pg. 63) before continuing.
- 2 Press **selection keys** to select "FINALIZE", then press **ENTER**.
- 3 The confirmation screen appears. Press **selection keys** to select "YES", then press **ENTER**.
- 4 The confirmation screen appears again. Press **selection keys** to select "OK", then press **ENTER**.
 - To cancel finalization, press "CANCEL".
- 5 Upon completing finalization, "COMPLETED" appears on the TV screen. Press **ENTER** to return to the previous screen.
- 6 Press **SET UP** to return to the normal screen.
 - Menu screen is cleared.
 - Once a DVD-R/RW (Video mode) disc has been finalized, the displays for original and play list do not appear. As only the display for library appears, press **TOP MENU** to select the desired title.
 - Once a DVD-RW (VR mode) disc has been finalized, it can be played on DVD players compatible with VR mode.

Cancel The Finalization Of A DVD-RW Disc

- 1 Load a DVD-RW disc to cancel the disc finalization, and perform steps 1 – 3 of "Format A DVD-RAM Disc" (pg. 63) before continuing.
- 2 Press **selection keys** to select "CANCEL DISC FINALIZATION", then press **ENTER**.
- 3 Press **selection keys** to select "OK", then press **ENTER**.
- 4 Upon completing cancellation of finalization, "COMPLETED" appears on the TV screen. Press **ENTER** to return to the previous screen.
- 5 Press **SET UP** to return to the normal screen.
 - When the disc finalization is canceled, the mode in which the disc was formatted is restored, making the disc recordable.
 - It is not possible to cancel the finalization of a DVD-R disc.

Before requesting service for a problem, use this chart and see if you can solve the trouble yourself. Small problems are often easily solved, and this can save you the trouble of sending your unit off for repair.

Initializing

Malfunction occurs on the unit.

- Press \odot /I to turn off the unit, press and hold \odot /I, then press ■ for 3 seconds or more.

General

No power is supplied to the unit.

- The AC power plug is disconnected from the AC outlet.
- Connect the AC power plug to the AC outlet securely. (☞ pg. 16)

The remote control does not work properly.

- Remove the batteries, wait for 5 minutes or more, then load the batteries again.
- The setting of the remote control code is inappropriate.
- Set the same remote control code (1, 2, 3, or 4) on both the unit and the remote control. (☞ pg. 57)
- The batteries are discharged.
- Replace the dead batteries with new ones.

Dubbing from the external equipment is not possible.

- The source (another video recorder, camcorder) has not been properly connected.
- Confirm that the source is properly connected.
- All necessary power switches have not been turned on.
- Confirm that all units' power switches are turned on.
- The setting of the input channel position is inappropriate.
- Select the input channel position ("F-1" or "L-1") that corresponds to the input terminal connected to the external equipment. (☞ pg. 54)

The on-screen display superimposed on the program played back/received on this unit is recorded when you dub the program to an external recording equipment.

- Set "SUPERIMPOSE" to "OFF". (☞ pg. 59)

The unit does not operate.

- There are cases when the operation is prohibited on the disc.
- Lightning or static electricity may cause malfunction of the unit.
- Disconnect the AC power plug from the AC outlet and connect again. Then turn on the unit.

The remote control of a JVC TV will not operate the unit.

- The setting of the remote control code is inappropriate.
- To operate the unit using a JVC TV remote control, set the remote control code of the unit to "1" (Default: "3"). (☞ pg. 57)

Playback

Images do not appear on the TV screen.

- The TV receiver's channel selector is not set to an input mode such as EXT1.
- Set the TV to an input mode such as EXT1.
- When interlace scanned program is played back, progressive scan mode is selected.
- Press and hold **PROGRESSIVE SCAN** until **P** disappears from the front display panel. (☞ pg. 60)

Playback does not start or stop immediately after playback is started by pressing ►. On the front display panel, "NO DISC" appears.

- The disc is loaded upside down.
- Place the disc on the disc tray with the playback surface facing down. (☞ pg. 10)
- A disc not being compatible with the unit is loaded.
- Load a playable disc on the unit. (☞ pg. 8)
- A dirty disc is loaded.
- Clean the disc. (☞ pg. 11)
- Defective disc is loaded.
- Replace the warped or scratched disc with a normal one.

Images are blurred or distorted when you start High-Speed Search.

- Images are blurred or distorted at the point where the playback speed changes and this is not a malfunction of the unit.

Playback does not start.

- Playback does not start for approximately 30 seconds after recording is stopped and this is not a malfunction of the unit.

Recording

The desired program cannot be recorded.

- The channel position does not correspond to that in the receiving area.
- Set the correct channel position for the receiving broadcast. (☞ pg. 20)

Recording cannot be made.

- No disc or a disc not being compatible with the unit is loaded.
- Load a recordable disc on the unit. (☞ pg. 7)
- The disc loaded is not formatted.
- Format the disc. (☞ pg. 63)
- A finalized disc is loaded.
- Recording cannot be made on finalized discs. Load a recordable disc on the unit.
- The disc is full or does not have enough space for the title to be recorded.
- Clear unnecessary titles on the disc or load a blank disc. (☞ pg. 44)

Timer Recording

Timer programming cannot be made.

- Date and time is not correct.
- Set date and time correctly. (☞ pg. 17, 19)
- Timer recording is in progress.
- Timer programming can't be performed while a timer recording is in progress. Wait until it finishes.

Timer programming recording does not start.

- Date and time is not correct.
- Set date and time correctly. (☞ pg. 17, 19)

VCR Plus+ Timer Programming cannot be made.

- Date and time is not correct.
- Set date and time correctly. (☞ pg. 17, 19)
- The channel position does not correspond to that in the receiving area.
- Set the correct channel position for the receiving broadcast. (☞ pg. 20)

The VCR Plus+ system does not timer record properly.

- The unit's channel positions have been set incorrectly.
- Refer to "Guide Channel Number Set" (☞ pg. 62) and re-perform the procedure.

Automatic Satellite Programme Recording does not start.

- The DBS receiver is not connected properly to this unit.
- Connect the DBS receiver correctly to the unit's [L-1 INPUT] connectors. (☞ pg. 42)

On the front display panel, "- : - -" appears.

- Power failure occurred.
- Set date and time correctly. (☞ pg. 19)

The disc space does not increase when recorded titles are cleared.

- The PC's data recorded on a DVD-RAM drive cannot be cleared on this unit.
- Format the disc. (When the disc is soiled, wipe the disc with a soft dry cloth before formatting.) (☞ pg. 11, 63)

Other Problems

The image of the TV broadcast appears distorted on the TV screen.

- Press **PROGRESSIVE SCAN** for 3 or more seconds so that the Video output indicator (P) lights off on the front display panel.

Whistling or howling is heard from the TV during camcorder recording.

- The camcorder's microphone is too close to the TV.
- Position the camcorder so its microphone is away from the TV.
- The TV's volume is too high.
- Turn the TV's volume down.

When scanning channels, some of them are skipped over.

- Those channels have been designated to be skipped.
- If you need the skipped channels, restore them using "Manual Channel Set" (☞ pg. 20).

Channel settings that were made manually seem to have changed or disappeared.

- After the manual settings were made, Auto Channel Set was performed.
- Do not perform Auto Channel Set after making manual settings, proceed to perform "Clock Set" (☞ pg. 19).

Malfunction occurs and the unit cannot be power off.

- Reset the unit by disconnecting the AC power plug from the AC outlet and connect again.

On-screen Message

DISC NOT REGISTERED IN THE LIBRARY REGISTER DISC?

- A disc that is not registered in the library has been inserted. Register the disc as necessary. (☞ pg. 51)

INSERT DISC #XXXX

- Appears when a title that has been selected in the library is not contained in the loaded disc.

CAN NOT RECORD OR MAKE PLAY LIST DELETE UNWANTED TITLES

- Recording and/or editing cannot be performed.
- The number of titles exceeds 99.
- The number of play lists exceeds 99.

SET CLOCK BEFORE TIMER PROGRAMMING

- To set the timer program, the clock must be set in advance. (☞ pg. 19)

PROGRAM FULL DELETE UNWANTED TIMER PROGRAMS

- You can program this unit to timer record as many as 8 programs. To program more, you need to cancel a timer program already set. (☞ pg. 41)

DISC NOT RECORDABLE INSERT RECORDABLE DISC

- When a playback-only disc or a finalized disc is loaded, ● has been pressed. (☞ pg. 8)

REGION CODE ERROR CHECK DISC

- A disc loaded cannot be played back on this unit since the region number of the disc does not match that of the unit. (☞ pg. 8)

UNREADABLE DISC CHECK DISC

- When an incompatible disc is loaded, ► has been pressed. (☞ pg. 8)

COULD NOT FORMAT THE DISC CHECK THE DISC

- Formatting is not complete since the disc may be dirty or damaged. Take out the disc, clean it and retry. (☞ pg. 11, 63)

PRESS [STOP] AGAIN TO STOP RECORDING

- During Live Memory playback, ■ has been pressed. (☞ pg. 27)

TIMER RECORDING COMPLETED

- Timer recording has finished during Live Memory playback.

PLAYBACK WILL STOP THEN TIMER RECORDING WILL START

- Timer recording finished during Live Memory playback, then the next timer recording is about to begin while playback continues.

COPY PROHIBITED CAN NOT RECORD

- An attempt has been made to record copy-protected contents.
- An attempt has been made to record copy-once contents on a disc that is not CPRM compatible.

COPY PROHIBITED CAN NOT PLAY

- The unit has detected invalid contents at the start or in the middle of playback.

THE i.LINK DEVICE THAT YOU HAVE CONNECTED IS NOT RECOGNIZED MAKE SURE THAT THE DEVICE IS CONNECTED PROPERLY AND POWERED ON

- An attempt has been made to start DV dubbing when a digital video camera is not properly connected to the unit.
- Check the connection. (☞ pg. 53)

MEMORY IS FULL NOTHING MORE CAN BE REGISTERED IN THE LIBRARY IF YOU DELETE UNNECESSARY TITLE INFORMATION, YOU CAN THEN REGISTER ADDITIONAL INFORMATION

- The memory for registration for the Navigation system is full. The recording cannot be started even though the capacity for the recording is enough.

AVAILABLE MEMORY IS LOW SOON YOU WILL NO LONGER BE ABLE TO REGISTER INFORMATION IN THE LIBRARY IF YOU DELETE UNNECESSARY TITLE INFORMATION, YOU CAN THEN REGISTER ADDITIONAL INFORMATION

- The remaining capacity of the memory is not enough for registration for the Navigation system. The recording cannot be started even though the capacity for the recording is enough.

CAN NOT SET DISC TIMER PROGRAMING WITH THIS DISC PREPARE A FORMATTED DISC AS DESCRIBED BELOW DVD-RAM DVD-RW (VR MODE)

- On-Disc Timer Programming has been attempted when a disc that is not compatible with the function is loaded.

NO DISC INSERTED

- On-Disc Timer Programming has been attempted when a disc is not loaded, or loaded upside down.

PLUSCODE NO. ERROR CONFIRM PLUSCODE NO. THEN RETRY

- An invalid PlusCode number has been input.

GUIDE PROGRAM IS NOT SET SELECT CHANNEL YOU WANT TO RECORD

- To set the timer program using the VCR Plus+ system, the Guide Channel Number must be set in advance.

CAN NOT SET VCR PLUS+ TIMER PROGRAMING DURING TIMER RECORDING OR INSTANT TIMER RECORDING CANCEL TIMER RECORDING OR INSTANT TIMER RECORDING, THEN ENTER THE PLUSCODE AGAIN

- Appears when you tried to input a PlusCode number during timer recording or instant timer recording.

COULD NOT FINALIZE THE DISC CHECK THE DISC

- Finalizing is not complete since the disc may be dirty or damaged. Take out the disc, clean it and retry.

COULD NOT CANCEL DISC FINALIZATION CHECK THE DISC

- Canceling disc finalization is not complete since the disc may be dirty or damaged. Take out the disc, clean it and retry.

Language Code List

AA	Afar	IN	Indonesian	RU	Russian
AB	Abkhazian	IS	Icelandic	RW	Kinyarwanda
AF	Afrikaans	IW	Hebrew	SA	Sanskrit
AM	Ameharic	JI	Yiddish	SD	Sindhi
AR	Arabic	JW	Javanese	SG	Sangho
AS	Assamese	KA	Georgian	SH	Serbo-Croatian
AY	Aymara	KK	Kazakh	SI	Singhalese
AZ	Azerbaijani	KL	Greenlandic	SK	Slovak
BA	Bashkir	KM	Cambodian	SL	Slovenian
BE	Byelorussian	KN	Kannada	SM	Samoan
BG	Bulgarian	KO	Korean (KOR)	SN	Shona
BH	Bihari	KS	Kashmiri	SO	Somali
BI	Bislama	KU	Kurdish	SQ	Albanian
BN	Bengali, Bangla	KY	Kirghiz	SR	Serbian
BO	Tibetan	LA	Latin	SS	Siswati
BR	Breton	LN	Lingala	ST	Sesotho
CA	Catalan	LO	Laothian	SU	Sundanese
CO	Corsican	LT	Lithuanian	SW	Swahili
CS	Czech	LV	Latvian, Lettish	TA	Tamil
CY	Welsh	MG	Malagasy	TE	Telugu
DZ	Bhutani	MI	Maori	TG	Tajik
EL	Greek	MK	Macedonian	TH	Thai
EO	Esperanto	ML	Malayalam	TI	Tigrinya
ET	Estonian	MN	Mongolian	TK	Turkmen
EU	Basque	MO	Moldavian	TL	Tagalog
FA	Persian	MR	Marathi	TN	Setswana
FJ	Fiji	MS	Malay (MAY)	TO	Tonga
FO	Faroese	MT	Maltese	TR	Turkish
FY	Frisian	MY	Burmese	TS	Tsonga
GA	Irish	NA	Nauru	TT	Tatar
GD	Scots Gaelic	NE	Nepali	TW	Twi
GL	Galician	OC	Occitan	UK	Ukrainian
GN	Guarani	OM	(Afan) Oromo	UR	Urdu
GU	Gujarati	OR	Oriya	UZ	Uzbek
HA	Hausa	PA	Panjabi	VI	Vietnamese
HI	Hindi	PL	Polish	VO	Volapuk
HR	Croatian	PS	Pashto, Pushto	WO	Wolof
HU	Hungarian	PT	Portuguese	XH	Xhosa
HY	Armenian	QU	Quechua	YO	Yoruba
IA	Interlingua	RM	Rhaeto-Romance	ZH	Chinese
IE	Interlingue	RN	Kirundi	ZU	Zulu
IK	Inupiak	RO	Rumanian		

GENERAL**Power requirement**AC 120 V \sim , 60 Hz**Power consumption**

Power on: 30 W

Power off: 2.7 W

Temperature

Operating: 5°C to 35°C (41°F to 95°F)

Storage: -20°C to 60°C (-4°F to 140°F)

Operating position

Horizontal only

Dimensions (WxHxD)

435 mm x 70 mm x 300 mm (17-3/16" x 2-11/16" x 11-13/16")

Weight

3.4 kg (7.5 lbs)

VIDEO/AUDIO**Recordable disc:** DVD-RAM 12 cm (4.7 GB/9.4 GB)
DVD-RAM 8 cm (1.4 GB/2.8 GB)

DVD-R 12 cm (4.7 GB)

DVD-R 8 cm (1.4 GB)

DVD-RW 12 cm (4.7 GB)

DVD-RW 8 cm (1.4 GB)

Recording format

DVD-RAM : DVD Video Recording format

DVD-R : DVD Video format

DVD-RW : DVD Video format, DVD Video Recording format

Recording time

Maximum 8 hours (with 4.7 GB disc)

(XP) : Approx. 1 hour

(SP) : Approx. 2 hours

(LP) : Approx. 4 hours

(EP) : Approx. 6 hours

(FR) : Approx. 1 hour - 8 hours

Audio recording system

: Dolby Digital (2 ch)

Linear PCM (XP mode only)

Video recording compression system

: MPEG2 (CBR/VBR)

Input/Output**S-video input**Y : 1.0 Vp-p, 75 Ω C : 0.286 Vp-p, 75 Ω **S-video output**Y : 1.0 Vp-p, 75 Ω C : 0.3 Vp-p, 75 Ω Video input : 1.0 Vp-p, 75 Ω (pin jack)Video output : 1.0 Vp-p, 75 Ω (pin jack)

Audio input : 2 Vrms (pin jack)

Audio output : 2 Vrms (pin jack)

i.Link : 4-pin for DV input

Component video outputY : 1.0 Vp-p, 75 Ω Pb/Pr : 0.7 Vp-p, 75 Ω

Corresponding to copy protection

Digital audio output

: Coaxial

Corresponding to Dolby Digital and DTS Digital

Surround

Bit stream

Selectable in digital audio output setting menu

TUNER/TIMER**Tuning system** : Frequency synthesizer tuner**Channel coverage**

VHF : Channels 2 - 13

UHF : Channels 14 - 69

CATV : 113 Channels

Clock reference : Quartz**Program capacity**

: 30 days programmable timer/8 programs

Memory backup time

: Approx. 5 sec.

ACCESSORIES**Provided accessories**

: RF cable,

Audio/video cable,

Infrared remote control unit,

"AA" battery x 2

Specifications shown are for SP mode unless otherwise specified.
E. & O.E. Design and specifications subject to change without notice.

A	
A-B Repeat Playback	31
Adjusting The Picture Quality	32
Angle Selection	25
Audio Language/Sound Selection	26
Auto Channel Set	20
Auto Clock	17
Auto Tuner Set	17
Automatic Satellite Program Recording	42
C	
Check, Cancel And Change Programs	41
Child Lock	61
D	
Disc menu	23
Disc Remaining Time	35
Disc Resume	60
Discs For Playback Only	8
DV Dubbing	53
DVD menu	23
E	
Elapsed Recording Time Indication	35
F	
File Structure Of Discs	9
Finalize	64
Format disc	63
Frame-By-Frame Playback	23
Free Rate Function	36
G	
Guide Channel Number Set	62
I	
Instant Timer Recording (ITR)	35
Interlaced scan	60
L	
Language Code List	68
Letter Box	21
Library Database Navigation	43
Live Memory Playback	27
M	
Manual Channel Set	20
Manual Clock Set	19
Manual Timer Programming	38
Marking Positions To Play Back Again Later	25
Menu/Audio/Subtitle Language Set	18
Monitor Set	21

O	
On-Disc Timer Programming	39, 40
One Touch Replay	24
On-screen Bar	30
On-Screen Display	15
On-screen Language Set	18
P	
Pan&Scan	21
Play List	47
Playback Control (PBC) Function	26
Program Playback	33
Programs overlap	41
Progressive scan	60
R	
Random Playback	33
Recordable/Playable Discs	7
Recording Medium And Format	9
Recording mode	34
Region Number	8
Register Disc	51
Repeat Playback	30
Resume Function	24
S	
Second Audio Recording	36
Select The Switching Interval Of The Slide Show	33
Semiauto Clock Set	19
Setting the Progressive Mode	32
Simultaneous Recording and Playback	28
Skip Search	24
Slow Motion	24
Soundtrack Selection	26
Still Picture	23
Subtitle Selection	25
T	
Time Search	32
Top menu	23
Tray Lock	61
U	
Unplayable Discs	8
V	
VCR Plus+ Setting	62
VCR Plus+ Timer Programming	37



LIMITED WARRANTY

USA ONLY

ONLY FOR PRODUCT PURCHASED IN U.S.A.

CONSUMER VIDEO 1-90

JVC COMPANY OF AMERICA (JVC) warrants this product and all parts thereof, except as set forth below ONLY TO THE ORIGINAL RETAIL PURCHASER to be FREE FROM DEFECTIVE MATERIALS AND WORKMANSHIP from the date of original purchase for the period shown below. ("The Warranty Period")

PARTS	1 YR	LABOR	90 DAYS
-------	------	-------	---------

THIS LIMITED WARRANTY IS VALID ONLY IN THE FIFTY (50) UNITED STATES, THE DISTRICT OF COLUMBIA AND IN THE COMMONWEALTH OF PUERTO RICO.

WHAT WE WILL DO:

If this product is found to be defective within the warranty period, JVC will repair or replace defective parts with new or rebuilt equivalents at no charge to the original owner. Such repair and replacement services shall be rendered by JVC during normal business hours at JVC authorized service centers. Parts used for replacement are warranted only for the remainder of the Warranty Period. All products may be brought to a JVC authorized service center on a carry-in basis. Color televisions with a screen size of 27" or greater qualify for in-home service. In such cases, a technician will come to your home and either repair the TV there or remove and return it if it cannot be repaired in your home.

WHAT YOU MUST DO FOR WARRANTY SERVICE:

Please do not return your product to the retailer

Instead, return your product to the JVC authorized service center nearest you. If shipping the product to the service center, please be sure to package it carefully, preferably in the original packaging, and include a brief description of the problem(s). Please call 1-800-252-5722 to locate the nearest JVC authorized service center. Service locations can also be obtained from our website <http://www.jvc.com>. If your product qualifies for in-home service, the service representative will require clear access to the product.

If you have any questions concerning your JVC Product, please contact our Customer Relations Department at 800-252-5722

WHAT IS NOT COVERED:

This limited warranty provided by JVC does not cover:

1. Products which have been subject to abuse, accident, alteration, modification, tampering, negligence, misuse, faulty installation, lack of reasonable care, or if repaired or serviced by anyone other than a service facility authorized by JVC to render such service, or if affixed to any attachment not provided with the products, or if the model or serial number has been altered, tampered with, defaced or removed;
2. Initial installation, installation and removal from cabinets or mounting systems.
3. Operational adjustments covered in the Owner's Manual, normal maintenance, video and audio head cleaning;
4. Damage that occurs in shipment, due to act of God, and cosmetic damage;
5. Signal reception problems and failures due to line power surge;
6. User Removal Memory Devices/Video Pick-up Tubes/CCD Image Sensors are covered for 90days from the date of purchase;
7. Accessories;
8. Batteries (except that Rechargeable Batteries are covered for 90 days from the date of purchase);
9. Products used for commercial purposes, including, but not limited to rental.
10. Loss of data resultant from malfunction of hard drive or other data storage device.

There are no express warranties except as listed above.

THE DURATION OF ANY IMPLIED WARRANTIES, INCLUDING THE IMPLIED WARRANTY OF MERCHANTABILITY, IS LIMITED TO THE DURATION OF THE EXPRESS WARRANTY HEREIN.

JVC SHALL NOT BE LIABLE FOR ANY LOSS OF USE OF THE PRODUCT, INCONVIENCE, OR ANY OTHER DAMAGES, WHETHER DIRECT, INCIDENTAL OR CONSEQUENTIAL (INCLUDING, WITHOUT LIMITATION, DAMAGE TO TAPES, RECORDS OR DISCS) RESULTING FROM THE USE OF THIS PRODUCT, OR ARISING OUT OF ANY BREACH OF THIS WARRANTY. ALL EXPRESS AND IMPLIED WARRANTIES, INCLUDING THE WARRANTIES OF MERCHANTABILITY AND FITNESS FOR PARTICULAR PURPOSE, ARE LIMITED TO THE WARRANTY PERIOD SET FORTH ABOVE.

Some states do not allow the exclusion of incidental or consequential damages or limitations on how long an implied warranty lasts, so these limitations or exclusions may not apply to you. This warranty gives you specific legal rights and you may also have other rights which vary from state to state.

JVC COMPANY OF AMERICA
DIVISION OF JVC AMERICAS CORP.

1700 Valley Road
Wayne, NJ 07470

<http://www.jvc.com>

REFURBISHED PRODUCTS CARRY A SEPARATE WARRANTY, THIS WARRANTY DOES NOT APPLY. FOR DETAIL OF REFURBISHED PRODUCT WARRANTY, PLEASE REFER TO THE REFURBISHED PRODUCT WARRANTY INFORMATION PACKAGED WITH EACH REFURBISHED PRODUCT.

For customer use:

Enter below the Model No. and Serial No. which is located either on the rear, bottom or side of the cabinet. Retain this information for future reference.

Model No. : _____

Serial No. : _____

Purchase date : _____

Name of dealer : _____

TO OUR VALUED CUSTOMER

THANK YOU FOR PURCHASING THIS JVC PRODUCT.
WE WANT TO HELP YOU ACHIEVE A PERFECT EXPERIENCE.

**NEED HELP ON HOW TO HOOK UP?
NEED ASSISTANCE ON HOW TO OPERATE?
NEED TO LOCATE A JVC SERVICE CENTER?
LIKE TO PURCHASE ACCESSORIES?**

DR-M100S

JVC[®] IS HERE TO HELP!
TOLL FREE: 1(800)252-5722
<http://www.jvc.com>

Remember to retain your Bill of Sale for Warranty Service.

Do not attempt to service the product yourself

Caution

To prevent electrical shock, do not open the cabinet.
There are no user serviceable parts inside.
Please refer to qualified service personnel for repairs.

BT-51005-9
(0904)

JVC