

LG20R

Laney
POWER TO THE MUSIC

USER MANUAL

IMPORTANT SAFETY INSTRUCTIONS

WARNING: When using electric products, basic cautions should always be followed, including the following.

1. Read all safety and operating instructions before using this product
2. The product should be powered by a three pin grounded (or earthed) plug connected to a power socket with a grounded earth outlet.
3. All safety and operating instructions should be retained for future reference
4. Obey all cautions in the Operating instructions and on the back of the unit
5. All operating instructions should be followed
6. This product should not be used near water, i.e. a bathtub, sink, swimming pool, wet basement, etc.
7. This product should be located so that its position does not interfere with its proper ventilation. It should not be placed flat against a wall or placed in a built up enclosure that will impede the flow of cooling air.
8. This product should not be placed near a source of heat such as stove, radiator, or another heat producing amplifier.
9. Connect only to a power supply of the type marker on the unit adjacent to the power supply cord.
10. Never break off the ground pin on a power supply cord.
11. Power supply cords should always be handled carefully. Never walk or place equipment on power supply cords. Periodically check cords for cuts or signs of stress, especially at the plug and the point where the chord exits the unit.
12. The power supply cord should be unplugged when the unit is to be unused for long periods of time.
13. If this product is to be mounted in an equipment rack, rear support should be provided.
14. The user should allow easy access to any mains plug, mains coupler and mains switch used in conjunction with this unit thus making it readily operable.
15. Metal parts can be cleaned with a damp cloth. The vinyl covering used on some units can be cleaned with a damp cloth or ammonia based household cleaner if necessary. Disconnect the unit from the power supply before cleaning.
16. Care should be taken so that objects do not fall and liquids are not spilled into the unit through any ventilation holes or openings. On no account place drinks on the unit.
17. A qualified service technician should check the unit if:
 - The power cord has been damaged
 - Anything has fallen or spilled into the unit
 - The unit does not appear to operate correctly
 - The unit has been dropped or the enclosure damaged.
18. The user should not attempt to service the equipment. All service work is done by a qualified service technician.
19. Exposure to extremely high noise levels may cause a permanent hearing loss. Individuals vary considerably in susceptibility to noise induced hearing loss, but nearly everyone will lose some hearing if exposed to sufficiently intense noise for a sufficient time. The U.S. Government's Occupational Safety and Health Administration (OSHA) has specified the following permissible noise level exposure.

Duration Per Day In Hours	Sound Level dBA, slow response
8	90
6	92
4	95
3	97
2	100
1 ½	102
1	105
½	110
¼ or less	115

According to OSHA, any exposure in excess of the above permissible limits could result in some hearing loss. Ear plugs or protectors in the ear canals or over the ears must be worn when operating this amplification system in order to prevent a permanent hearing loss if exposure exceeds the limits set forth above. To ensure against potentially dangerous exposure to high sound pressure levels it is recommended that all persons exposed to equipment capable of producing high sound pressure levels such as this amplification system be protected by hearing protectors while this unit is in operation.

SAVE THESE INSTRUCTIONS



Intended to alert the user to the presence of uninsulated "dangerous voltage" within the product's enclosure that may be of sufficient to constitute a risk of electrical shock to persons



Intended to alert the user of the presence of important operating and maintenance (servicing) instructions in the literature accompanying the product

CAUTION: Risk of electrical shock - DO NOT OPEN

CAUTION: To reduce the risk of electrical shock, do not remove the cover. No user serviceable parts inside. Refer servicing to qualified service personnel.

WARNING: To prevent electrical shock or fire hazard, do not expose this appliance to rain or moisture. Before using this appliance please read the operating instructions for further warnings



Este simbolo tiene el proposito de alertar al usuario de la presencia de "voltaje peligroso" que no tiene aislamiento dentro de la caja del producto que puede tener una magnitud suficiente como para constituir riesgo de corrientazo



Este simbolo tiene el proposito de alertar al usuario de la presencia de instrucciones importantes sobre la operacion y mantenimiento en la literatura que viene con el producto

PRECAUCION: Riesgo de corrientazo - no abra

PRECAUCION: Para disminuir el riesgo de corrientazo, no abra la cubierta. No hay piezas adentro que el pueda reparar. Deje todo mantenimiento a los tecnicos calificados

ADVERTENCIA: Para evitar corrientazos o peligro de incendio, no deja expuesto a la lluvia o humedad este aparato. Antes de usar este aparato, lea las advertencias en la guía de operacion



Ce symbole est utilise pur indiquer a l'utilisateur de ce produit de tension non-isolee dangereuse pouvant etre d'intensite suffisante pour constituer un risque de choc electrique.



Ce symbole est utilise pour indiquer a l'utilisateur qu'il ou qu'elle trouvera d'importantes instructions sur l'utilisation et l'entretien (service) de l'appareil dans la litterature accompagnant le produit

ATTENTION: Risques de choc electrique - NE PAS OUVIRIR

ATTENTION: Afin de reduire le risque de choc electrique, ne pas enlever le couvercle. Il ne se trouve a l'interieur aucune piece pouvant etre reparee par l'utilisateur. Confier l'entretien a un personnel qualifie.

AVERTISSEMENT: Afin de prevenir les risques de decharge electrique ou de feu, n'exposez pas cet appareil a la pluie ou a l'humidite. Avant d'utiliser cet appareil, lisez les avertissements supplementaires situes dans le guide.



Dieses Symbol soll den Anwender vor unisolierten gefahrlichen Spannungen innerhalb des Gehauses warnen, die von Ausreichender Starke sind, um einen elektrischen Schlag verursachen zu kommen.



Dieses Symbol soll den Benutzer auf wichtige Instruktionen in der Bedienungsanleitung aufmerksam machen, die Handhabung und Wartung des Produkts betreffen.

VORSICHT: Risiko - Elektrischer Schlag! Nicht offen!

VORSICHT: Um das Risiko eines elektrischen Schläges zu vermeiden, nicht die Abdeckung entfernen. Es befinden sich keine Teile darin, die vom Anwender repariert werden könnten. Reparaturen nur von qualifiziertem Fachpersonal durchführen lassen

ACHTUNG Um einen elektrischen Schlag oder Feuergefahr zu vermeiden, sollte dieses Gerat nicht dem Regen oder Feuchtigkeit ausgesetzt werden. Vor Inbetriebnahme unbedingt die Bedienungsanleitung lesen.

BEFORE SWITCHING ON

After unpacking your amplifier check that it is factory fitted with a three pin 'grounded' (or earthed) plug. Before plugging into the power supply ensure you are connecting to a grounded earth outlet.

If you should wish to change the factory fitted plug yourself, ensure that the wiring convention applicable to the country where the amplifier is to be used is strictly conformed to. As an example in the United Kingdom the cable colour code for connections are as follows.

EARTH OR GROUND - GREEN/YELLOW
NEUTRAL - BLUE
LIVE - BROWN



NOTE

This manual has been written for easy access of information. The front and rear panels are graphically illustrated, with each control and feature numbered. For a description of the function of each control feature, simply check the number with the explanations adjacent to each panel.

Your Laney amplifier has undergone a thorough two stage, pre-delivery inspection, involving actual play testing.

When you first receive your Laney guitar amplifier, follow these simple procedures:

- (i) Ensure that the amplifier is the correct voltage for the country it is to be used in.
- ii) Connect your instrument with a high quality shielded instrument cable. You have probably spent considerable money on your amplifier and guitar - don't use poor quality cable it won't do your gear justice.

Please retain your original carton and packaging so in the unlikely event that some time in the future your amplifier should require servicing you will be able to return it to your dealer securely packed.

Care of your Laney amplifier will prolong it's life.....and yours!

Dear Player,

Thank you very much for purchasing your new Laney product and becoming part of the worldwide Laney family. Each and every Laney unit is designed and built with the utmost attention to care and detail, so I trust yours will give you many years of enjoyment.

Laney products have a heritage which stretches back to 1967 when I first began building valve amplifiers in my parent's garage. Since then we have moved on from strength to strength developing an extensive range of guitar, bass, public address and keyboard amplification products along with a list of Laney endorsees that includes some of the world's most famous and respected musicians. At the same time we believe we have not lost sight of the reason Laney was founded in the first place - a dedication to building great sounding amplification for working musicians.

Warm Regards,



Lyndon Laney CEO



INTRODUCTION

The LG20R is an open back guitar combo loaded with an 8 inch loudspeaker. It is a retro styled cabinet with the controls on the top face for ease of use. It has a split channel preamp layout, which gives you separate clean and drive level controls through a shared master EQ with bass, mid and treble. It features a headphone socket for private listening; CD/Line in socket should you need to play along to a CD/MP3 and a headphone socket for some private time without waking the neighbours. Finally it features a built in spring line reverb with level control.

An explanation of these features follows on pages 6-8.

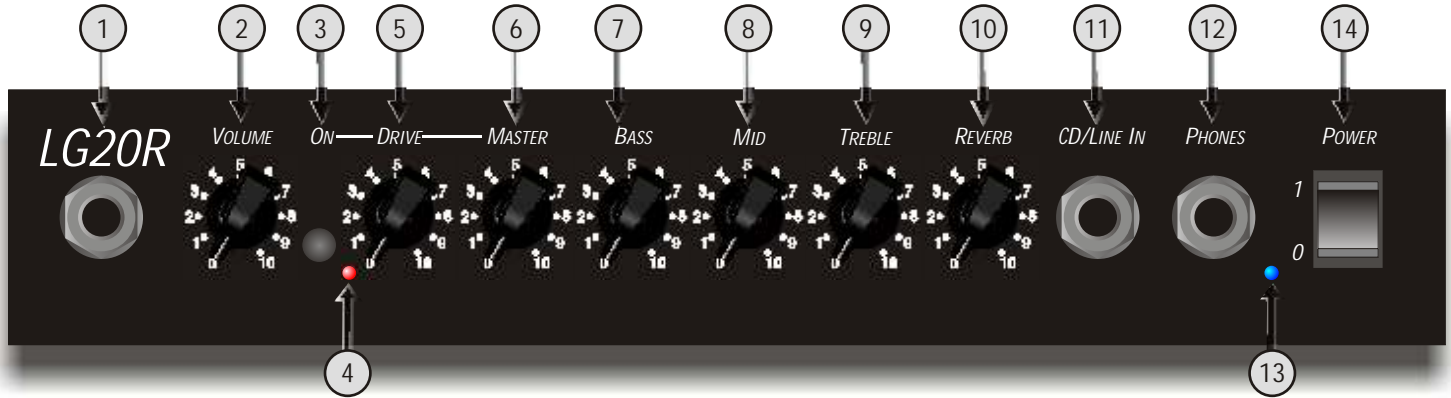

FRONT PANEL CONTROLS

- 1 This socket should be used for connecting your instrument to the amplifier. Only use a good quality screened cable.
- 2 Controls the volume level of the clean channel.
- 3 Switch in to activate the overdrive 'Crunch' channel. When active, control the amount of distortion with 5 and the overall volume with 2.
- 4 Indicates that the drive channel is active.
- 5 Controls the Drive channel gain, low down for classic rock and blues, higher up for hard rock and metal. Use in conjunction with 2 to get the overall level balanced how you want it.
- 6 Controls the overall level from the drive channel, use in conjunction with 2.
- 7 Controls the amount of bass or bottom end present on the clean channel.
- 8 Controls the amount of mid present on the clean channel.

- 9 Controls the amount of treble present on the clean channel.
- 10 Controls the amount of reverb applied to the signal.
- 11 Fancy playing along with a backing track? Connect your CD/MP3 player here.
- 12 Don't want to wake your neighbours? Connect your headphones here. The internal loudspeaker is automatically switched off.
- 13 When 'on' indicates that power is connected to the unit and it is ready to go.
(Always switch off and disconnect the power cord when not in use)
- 14 Main power switch for the unit.

POWER SOURCE ~100VAC 50/60Hz ~230V AC 50/60Hz
 ~120VAC 50/60Hz ~240V AC 50/60Hz

POWER CONSUMPTION - 30 WATTS ~50/60Hz

MODEL **LG20R**

SERIAL NUMBER

DESIGNED IN THE UK BY LANEY

CE 

N15039

MADE IN CHINA FABRIQUE EN CHINE
WARNING - TO REDUCE THE RISK OF FIRE OR ELECTRIC SHOCK DO NOT EXPOSE THIS APPLIANCE TO RAIN OR MOISTURE.
CAUTION - FOR CONTINUED PROTECTION AGAINST RISK OF FIRE REPLACE ONLY WITH SAME TYPE AND RATED FUSE.
CAUTION - TO REDUCE THE RISK OF ELECTRIC SHOCK DO NOT REMOVE COVERS. NO USER SERVICEABLE PARTS INSIDE. REFER SERVICING TO QUALIFIED PERSONNEL ONLY.
WARNING - THIS EQUIPMENT MUST BE EARTHED.
ATTENTION - REMPLACER LE FUSIBLE SEULEMENT PAR LE MEME TYPE ET LE MEME CALIBRE.
AVIS - RISQUE DE CHOC ELECTRIQUE - NE PAS OUVRIR.
ATTENTION - DEBRANCHER LE CORDON D'ALIMENTATION AVANT TOUTE INTERVENTION.

Laney
POWER TO THE MUSIC
www.laney.co.uk

 **CAUTION**
RISK OF ELECTRIC SHOCK DO NOT OPEN 

15

- 15 Displays the model number, power requirements and serial number of the unit.

POWER CONNECTION

- 15 Displays the model number, power requirements and serial number of the unit. Make sure the specified voltage is correct for your country! The correct mains voltage is indicated on the rear panel
- 16 The mains lead protudes from the underside of the chassis for connection to your power source.
(Always switch off and unplug the power cord from the wall socket when not in use)



QUICK START SETTINGS - Suggestions only, experiment!

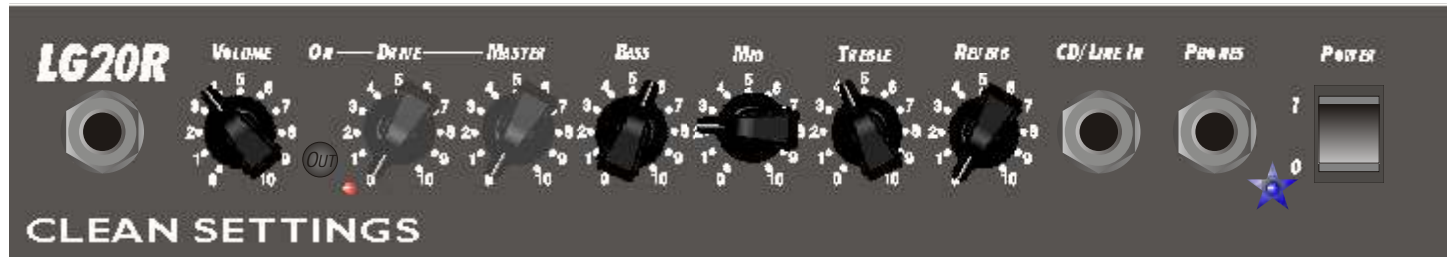

QUICK START SETTINGS - CONTINUED

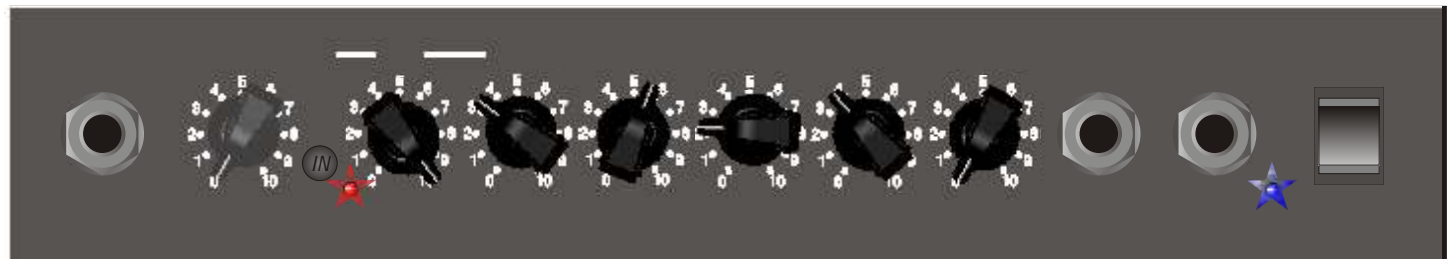
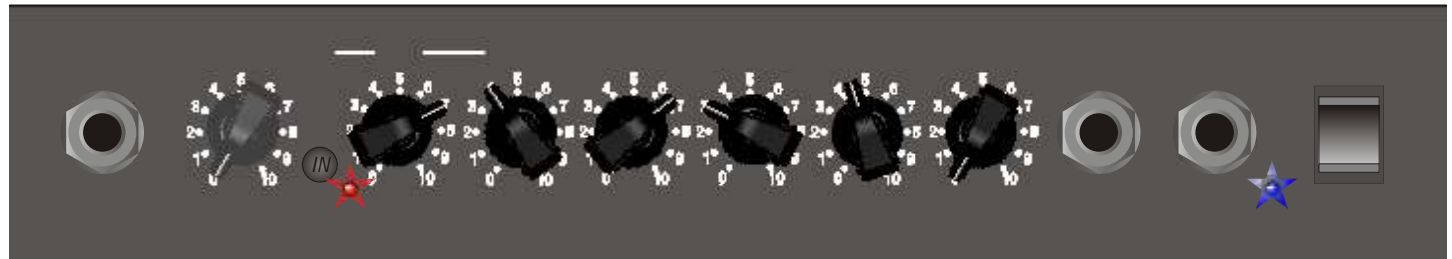
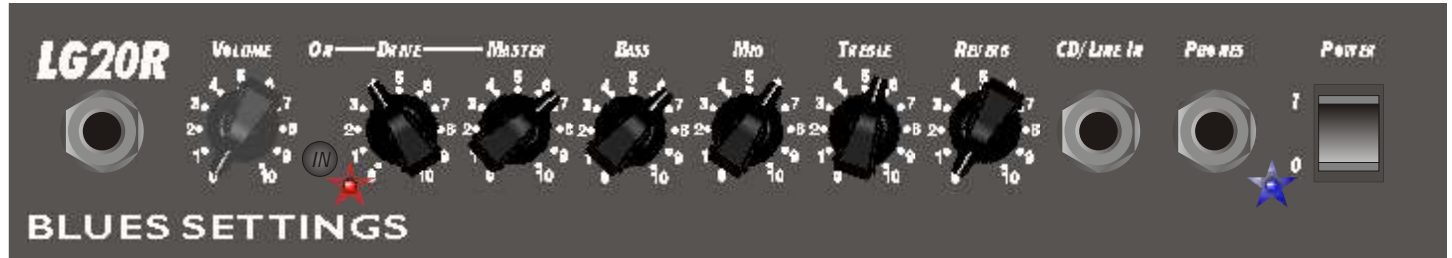

SAMPLE SYSTEM

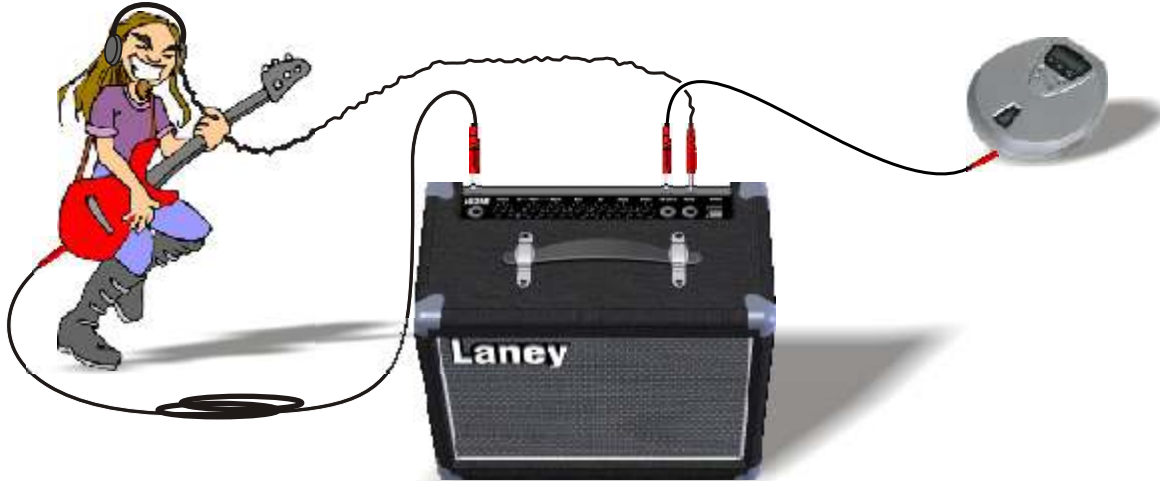

General Notes

Amplifier connection: In order to avoid damage, it is advisable to establish and follow a pattern for turning on and off your equipment. With all system parts connected, turn on source equipment, tape decks, cd players, mixers, effects processors etc. BEFORE turning on your guitar amplifier. Many products have large transient surges at turn on and off which can cause damage to your speakers. By turning on your guitar amplifier LAST and making sure its Volume controls are set to minimum any transients from other equipment will not reach your loudspeakers. Wait until all system parts have stabilised; usually a couple of seconds. Similarly when turning off your system always turn down the Volume controls on your guitar amplifier and then turn off its power before turning off other equipment.

Cables: never use shielded or microphone cable for any speaker connections as this will not be substantial enough to handle the amplifier load and could cause damage to your amplifier system.

Caution: These professional loudspeaker systems are capable of generating very high sound pressure levels. Use care with placement and operation to avoid exposure to excessive levels that can cause permanent hearing damage. (Refer to guidelines on page 2)

Servicing: The user should not attempt to service these products. Refer all servicing to qualified service personnel.

SPECIFICATIONS

Supply Voltage	~100V, ~120V, ~220V, ~230V, ~240V 50/60Hz Factory Option	
Power Consumption	30W	
Output Power Rating	15W	
Loudspeaker	8" Custom Designed Driver TEC - Tube Emulating Circuitry	
Features	Headphone socket, CD In (10K Input impedance) (Nominal 300mV Input level)	
EQ	Passive Bass, Middle and Treble	
Input Impedance	1M Ω /47pF	
Size	350*400*212 (H*W*D)	
Unit Weight	8.25 Kg	
Packing Weight	9.00 Kg	

This product conforms to:
European EMC directive(2004/108/EC), Low Voltage Directive (72/23/EEC) and CE mark Directive (93/68/EEC)

BLOCK DIAGRAM

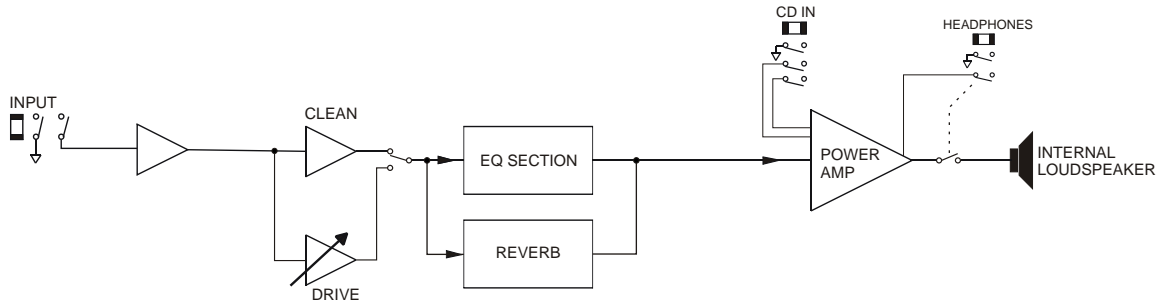

Laney

POWER TO THE MUSIC.



www.laney.co.uk

In the interest of continued product development, Laney Reserves the right to amend product specification without prior notification.