

L5T-112

OPERATING INSTRUCTIONS - I.I

L I O N H E A R T



ALL TUBE 'CLASS A'
HERITAGE AMPLIFIER



LANEY AMPLIFICATION
www.laney.co.uk



The Dark Art



IMPORTANT SAFETY INSTRUCTIONS

WARNING: When using electric products, basic cautions should always be followed, including the following.

1. Read all safety and operating instructions before using this product
2. The product should be powered by a three pin grounded (or earthed) plug connected to a power socket with a grounded earth outlet.
3. All safety and operating instructions should be retained for future reference
4. Obey all cautions in the Operating instructions and on the back of the unit
5. All operating instructions should be followed
6. This product should not be used near water, i.e. a bathtub, sink, swimming pool, wet basement, etc.
7. This product should be located so that its position does not interfere with its proper ventilation. It should not be placed flat against a wall or placed in a built up enclosure that will impede the flow of cooling air.
8. This product should not be placed near a source of heat such as stove, radiator, or another heat producing amplifier.
9. Connect only to a power supply of the type marker on the unit adjacent to the power supply cord.
10. Never break off the ground pin on a power supply cord.
11. Power supply cords should always be handled carefully. Never walk or place equipment on power supply cords. Periodically check cords for cuts or signs of stress, especially at the plug and the point where the chord exits the unit.
12. The power supply cord should be unplugged when the unit is to be unused for long periods of time.
13. If this product is to be mounted in an equipment rack, rear support should be provided.
14. The user should allow easy access to any mains plug, mains coupler and mains switch used in conjunction with this unit thus making it readily operable.
15. Metal parts can be cleaned with a damp cloth. The vinyl covering used on some units can be cleaned with a damp cloth or ammonia based household cleaner if necessary.
Disconnect the unit from the power supply before cleaning.
16. Care should be taken so that objects do not fall and liquids are not spilled into the unit through any ventilation holes or openings. On no account place drinks on the unit.
17. A qualified service technician should check the unit if:
 - The power cord has been damaged
 - Anything has fallen or spilled into the unit
 - The unit does not appear to operate correctly
 - The unit has been dropped or the enclosure damaged.
18. The user should not attempt to service the equipment. All service work is done by a qualified service technician.
19. Exposure to extremely high noise levels may cause a permanent hearing loss. Individuals vary considerably in susceptibility to noise induced hearing loss, but nearly everyone will lose some hearing if exposed to sufficiently intense noise for a sufficient time. The U.S. Government's Occupational Safety and Health Administration (OSHA) has specified the following permissible noise level exposure.

Duration Per Day In Hours	Sound Level dBA, slow response
8	90
6	92
4	95
3	97
2	100
1 ½	102
1	105
½	110
¼ or less	115

According to OSHA, any exposure in excess of the above permissible limits could result in some hearing loss. Ear plugs or protectors in the ear canals or over the ears must be worn when operating this amplification system in order to prevent a permanent hearing loss if exposure exceeds the limits set forth above. To ensure against potentially dangerous exposure to high sound pressure levels it is recommended that all persons exposed to equipment capable of producing high sound pressure levels such as this amplification system be protected by hearing protectors while this unit is in operation.

SAVE THESE INSTRUCTIONS



Intended to alert the user to the presence of uninsulated 'Dangerous Voltage' within the products enclosure that may be sufficient to constitute a risk of electrical shock to persons.



Intended to alert the user of the presence of important operating and maintenance (Servicing) instructions in the literature accompanying the product.

CAUTION: Risk of electrical shock - DO NOT OPEN.

CAUTION: To reduce the risk of electrical shock, do NOT remove the cover. No user serviceable parts inside. Refer servicing to qualified personnel.

WARNING: To prevent electrical shock or fire hazard, do not expose this appliance to rain or moisture. Before using this appliance please read the operating instructions for further warnings.



Este simbolo tiene el proposito de alertar al usuario de la presencia de '(voltaje) peligroso' que no tiene aislamiento dentro de la caja del producto que puede tener una magnitud suficiente como para constituir riesgo de corrientazo.



Este simbolo tiene el proposito de la alertar al usuario de la presencia de instrucciones importantes sobre la operacion y mantenimiento en la literatura que viene con el producto.

PRECAUCION: Riesgo de corrientazo - no abra

PRECAUCION: Para disminuir el riesgo de corrientazo, no abra la cubierta. No hay piezas adentro que el pueda reparar. Deje todo mantenimiento a los tecnicos calificados.

ADVERTENCIA: Para evitar corrientazos o peligro de incendio, no deja expuesto a la lluvia o humedad este aparato. Antes de usar este aparato, lea las advertencias en la guia de operacion.



Ce symbole est utilise pur indiquer a l'utilisateur de ce produit de tension non-isolee dangereuse pouvant etre d'intensite suffisante pour constituer un risque de choc electrique



Ce symbole est utilise pour indiquer a l'utilisateur qu'il ou qu'elle trouvera d'importantes instructions sur l'utilisation et l'entretien (service) de l'appareil dans la litterature accompagnant le produit.

ATTENTION: Risques de choc electrique - NE PAS OUVIRIR

ATTENTION: Afin de reduire le risque de choc electrique, ne pas enlever le couvercle. Il ne se trouve a l'interieur aucune piece pouvant etre reparee par l'utilisateur. Confier l'entretien a un personnel qualifie.

ADVERTISSEMENT: Afin de prevenir les risques de decharge electrique ou de feu, n'exposez pas cet appareil a la pluie ou a l'humidite. Avant d'utiliser cet appareil, lisez les advertissements supplementaires situes dans le guide.



Dieses Symbol soll den Anwender vor unisolierten gefahrlichen Spannungen innerhalb des Gehauses warnen, die von Ausreichender Starke sind, um einen elektrischen Schlag verursachen zu konnen.



Dieses Symbol soll den Benutzer auf wichtige Instruktionen in der Bedienungsanleitung aufmerksam machen, die Handhabung und Wartung des Produkts betreffen.

VORSICHT: Risiko - Elektrischer Schlag! Nicht offen!

VORSICHT: Um das Risiko eines elektrischen Schlages zu vermeiden, nicht die Abdeckung entfernen. Es befinden sich keine Teile darin, die vom Anwender repariert werden Konnten. Reparaturen nur von qualifiziertem Fachpersonal durchfuhren lassen.

ACHTUNG: Um einen elektrischen Schlag oder Feuergefahr zu vermeiden, sollte dieses Gerat nicht dem Regen oder Feuchtigkeit ausgesetzt werden. Vor Inbetriebnahme unbedingt die Bedienungsanleitung lesen.

BEFORE SWITCHING ON

After unpacking your amplifier check that it is factory fitted with a three pin 'grounded' (or earthed) plug. Before plugging into the power supply ensure you are connecting to a grounded earth outlet.

If you should wish to change the factory fitted plug yourself, ensure that the wiring convention applicable to the country where the amplifier is to be used is strictly conformed to. As an example in the United Kingdom the cable colour code for connections are as follows.

EARTH OR GROUND - GREEN/YELLOW
NEUTRAL - BLUE
LIVE - BROWN



NOTE

This manual has been written for easy access of information. The front and rear panels are graphically illustrated, with each control and feature numbered. For a description of the function of each control feature, simply check the number with the explanations adjacent to each panel.

Your Laney amplifier has undergone a thorough two stage, pre-delivery inspection, involving actual play testing.

When you first receive your Laney guitar amplifier, follow these simple procedures:

- (i) Ensure that the amplifier is the correct voltage for the country it is to be used in.
- ii) Connect your instrument with a high quality shielded instrument cable. You have probably spent considerable money on your amplifier and guitar - don't use poor quality cable it won't do your gear justice.

Please retain your original carton and packaging so in the unlikely event that some time in the future your amplifier should require servicing you will be able to return it to your dealer securely packed.

Care of your Laney amplifier will prolong it's life.....and yours!

Laney

OPERATING INSTRUCTIONS

Dear Player,

Thank you very much for purchasing your new Laney product and becoming part of the worldwide Laney family. Each and every Laney unit is designed and built with the utmost attention to care and detail, so I trust yours will give you many years of enjoyment.

Laney products have a heritage which stretches back to 1967 when I first began building valve amplifiers in my parent's garage. Since then we have moved on from strength to strength developing an extensive range of guitar, bass, public address and keyboard amplification products along with a list of Laney endorsees that includes some of the world's most famous and respected musicians. At the same time we believe we have not lost sight of the reason Laney was founded in the first place - a dedication to building great sounding amplification for working musicians.

Warm Regards,



Lyndon Laney CEO



INTRODUCTION

The Dark Art: In an age where guitar players have developed an unhealthy fascination with pre-amp distortion, the fabled sound of a tube power amp being pushed hard has almost passed into history. Until now that is!

The L5T-112's hand wired 5W Class A Single Ended output stage oozes classic, warm tube tones: The harder you drive it, the better it sounds. Plus with enough gain for contemporary tones, it also has a mean, spiteful side to it as well – making it ideal for any style of playing. Perfect for studio and practice use, but also equally at home or on stage plugged into a Laney LT-212 cabinet, the sound will blow you away.

Every Lionheart product is extensively play tested by experienced guitarists before being shipped to our customers. Only when the unit is finished to our complete satisfaction is it assigned its own unique build number which is then hand stamped onto the rear mounted plaque.

Your L5T-112 should give you years of trouble-free amplification, however please take time to read this manual and familiarise yourself with the controls as it will allow you to get the best from your amplifier. We hope you enjoy using your L5T-112 as much as we enjoyed designing and making it.

Best wishes from all at Laney

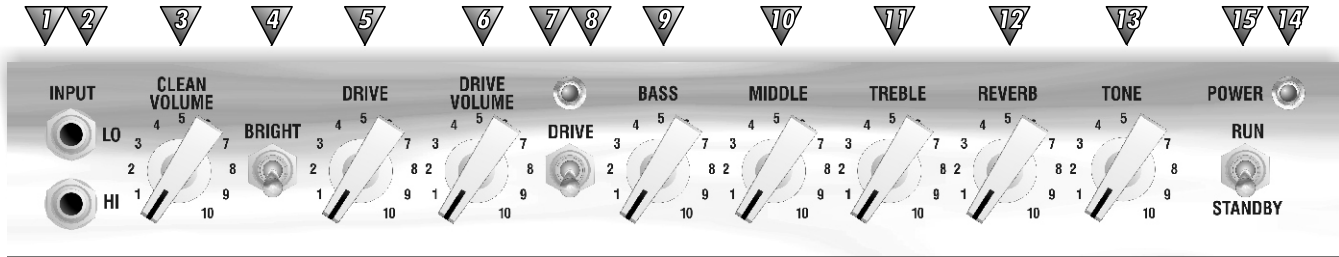

FRONT PANEL CONTROLS

1 HI INPUT: 'Hi' stands for high gain. This input is designed for the connection of low output level guitars making it well suited for guitars with single coiled or low gain humbucker type pickups. Use of high gain pickups in this input may drive the preamp too hard causing a "mushy" sound. Only use good quality guitar cable.

2 LO INPUT: 'Lo' stands for low gain. This input is attenuated down approximately 50% from the Hi input and is designed for high output level guitars. It is useful in obtaining output that is "tight" not "mushy" from high gain humbucker type pickups. Also use this input for the cleanest full range sound with extended low end response. Only use good quality guitar cable.

3 CLEAN VOL: Sets how loud the clean channel is. Try cranking it up a little to drive the power tubes harder for that real retro sound and feel that only a quality tube amplifier can deliver. Now use your guitar volume to control the amount of distortion. (Wind it up for distortion back it off a little for clean)

4 BRIGHT: Adds brightness and life to the treble frequencies of your guitar when on the clean channel. Adds edge and picking emphasis when on the drive channel. The switch has more effect at low Clean Volume/Drive control settings. Use in conjunction with the Treble and Tone controls for optimum performance. Switch up to enable.

5 DRIVE: Sets the level of tube preamplifier drive or how dirty your sound is. This control should be used in conjunction with the Drive Volume (6) Setting low levels of gain with high levels of volume will give a clean preamplifier sound with tube output stage overdrive. Setting a medium drive level and medium Drive Volume will give a nice crisp bluesy lead tone, again with the

ability to drive the output stage at higher Drive Volume settings. Setting a high level on the Drive control and a low setting on the Drive Volume will give you a punchy hard rock lead tone, with the ability to again drive the output tubes at higher Drive volume settings. Having set the Drive and Drive Volume controls to your desired sound try backing off your guitar volume and tone controls for lots of other cool sounds. Good tube amplifiers have the unique ability to produce a wide range of sounds by using only your guitar controls, playing weight and style.

6

DRIVE VOL: Sets how loud the 'Drive' channel is. It is useful to experiment with drive levels and drive volumes. If you want a very open, warm and semi overdriven sound try reducing the amount of drive and increasing the drive volume. This reduces pre-amp gain but pushes the power amp section and makes it work harder giving you a very desirable level of power amp distortion which is a very pleasing "retro" style sound.

7

DRIVE LED: This led will illuminate when the Drive channel is activated with the Drive switch (8) or the included Laney FS2 remote footswitch.

8

DRIVE SWITCH: Switch up to enable the 'Drive' channel. (This switch must be in the engaged position in order for the drive to be switched remotely via a foot switch.)

9-11

BASS, MIDDLE, TREBLE: These are a traditional set of passive tone controls. Passive controls have the advantage of always sounding musical at any of their settings mainly due to their unique interactive nature. This gives players a more natural set of tools to create their ideal sound. (Try them all set at midway (5) as a good starting point)

12

REVERB: Controls how loud the built in reverb sounds. The reverb in the L5T-112 is a legendary Sound Enhancements aka 'Accutronics reverb' - the only choice for that authentic reverb sound.

13

STONE: The tone control works in a similar fashion to the Tone control you probably have on your guitar except that it uniquely works at the other end of the amplification chain. This has the ability to not only control the overall top end response but also reduce upper end harmonics on the output stage and preamplifier overdrive sounds. This will give you bright cutting sounds at high settings and smooth rounded sounds at lower settings. (Midway (5) is a good starting point)

14

POWER LED: This led will be lit when the amplifier is switched on.
(Always switch off and disconnect the power cord when not in use)

15

STANDBY SWITCH: Disconnects the main HT voltage from the tubes but keeps the tubes warm so that they are ready to go instantly. Switch to standby for short breaks when you don't want to wait for the tubes to warm up again.

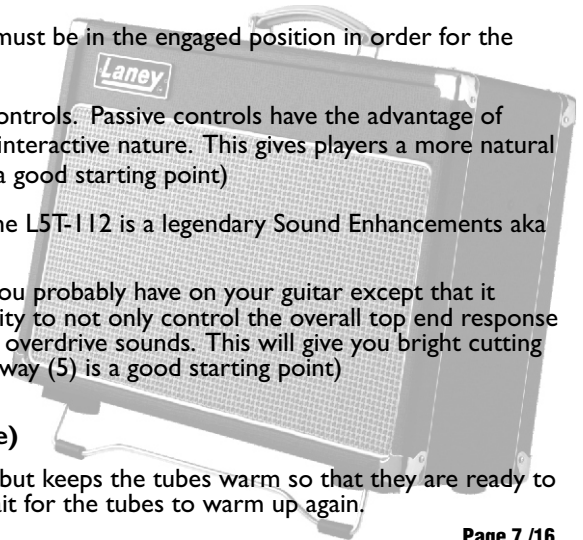

L5T - 112 REAR



1 POWER: Main power switch for unit.

2 POWER INLET SOCKET. Connect to your power source. Make sure the specified voltage is correct for your country!

3 POWER FUSE: This drawer contains the main safety fuse for the unit. The fuse protects the AC power to the amplifier. **USE ONLY THE CORRECT SIZE AND RATING OF FUSE AS SPECIFIED ON THE PANEL.** If a fuse blows or fails and a replacement of the same size and rating is installed and it in turn blows, the amplifier has suffered a malfunction internally and needs immediate service from a qualified technician. **DO NOT TRY USING A FUSE OF HIGHER RATING.** Using a fuse that is too large in current rating may cause serious, irreparable damage to the amplifier and presents a serious fire hazard. The mains fuse ratings are detailed in the specs section at the rear of this manual

4 HT FUSE: This fuse protects the DC power to the tubes within the amplifier. **USE ONLY THE CORRECT SIZE AND RATING FUSE AS SPECIFIED ON THE PANEL.** If a fuse blows or fails and a replacement of the same size and rating is installed and it in turn blows, the amplifier has suffered a malfunction, at this point check the output tubes and replace faulty ones if required. Should tubes not be the problem the amplifier should be checked out by a qualified technician. Do not try using a fuse of greater value. Using a fuse that is too large in current rating may cause serious, irreparable damage to the amplifier. Fuses are designed to protect, do not take chances.

5 EXTENSION CABINET: Use to connect an 8-16 ohm extension cabinet. Please note mismatched impedance will reduce the amplifiers performance and in some cases may cause damage to your amplifier. Set the switch to the 8 ohm when using only the internal loudspeaker; switch to the 4 ohm setting when connecting to an additional 8 ohm cabinet. Try the L5T-112 into a Laney Lionheart LT-212 cabinet - you will be amazed what this little baby cranks out. Note: If the onboard loudspeaker jack is removed, an 8 ohm cabinet can be connected directly to the 8 ohm socket.

6

SERIAL NO: Displays the model and serial number of the unit.

7

EFFECTS LOOP RETURN: Connect the output from your external effects to this socket. The effects loop allows you to connect external effects such as tremolos, chorus and delays to your amplifier. A portion of the signal leaves the amplifier via the 'Send' socket and comes back from the effects via the 'Return' socket. Use the output level control on your FX to control how loud the FX return signal sounds.

8

EFFECTS LOOP SEND: Connect the input of your external effect to this socket. A 'side chain' effects loop allows you to connect external effects such as tremolos, chorus and delays to your amplifier. Signal leaves the amplifier via the 'Send' socket and comes back from the effects via the 'Return' socket. Some Effects are better suited to being between the guitar and amplifier input - these are foot pedal types / distortion / wah wah pedals etc. Rack mount effects will work better in the FX loop on the amplifier rear. Stomp boxes are normally designed for small signals such as a guitar output whereas rack mount FX are designed for the higher signal level obtained from an FX send.

9

FOOTSWITCH SOCKET: Provided for the connection of the included Laney FS2 footswitch. This allows you to remotely switch between the clean/drive channel and switch the built in reverb On/Off.

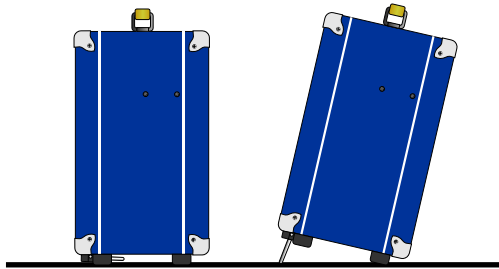

The L5T-112 is factory fitted with a unique Tilting Mechanism, allowing the cabinet to be used either in the upright or tilted back position. Please ensure the amp is on a stable level surface before using in the tilted position.

Lionheart products use only the best available build techniques and components to produce that perfect sound. This includes the loudspeakers which are selected for their tonal quality. Because these speakers are hand made, using vintage style materials which are acknowledged to give the best guitar sounds, they will take several hours of playing to settle down to their optimum sound.

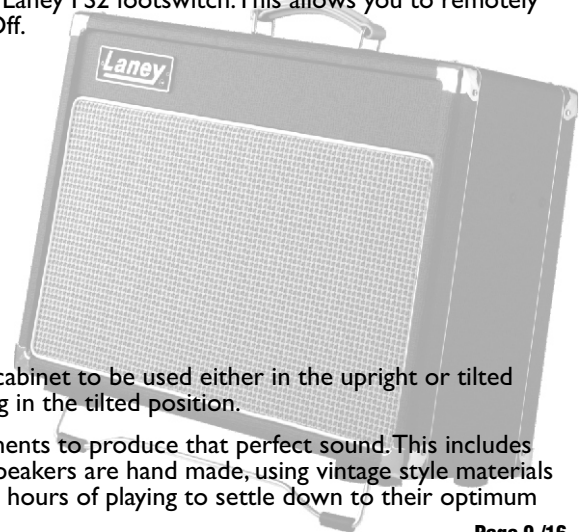

Laney

QUICK START SETTINGS - suggestions only, experiment!

CLEAN

Diagram showing the control panel for the 'CLEAN' tone. The settings are as follows: INPUT (LO), CLEAN VOLUME (position 5), BRIGHT (On), DRIVE (position 3), DRIVE VOLUME (position 5), BASS DRIVE (Off), BASS (position 3), MIDDLE (position 5), TREBLE (position 5), REVERB (position 5), TONE (position 5), and POWER (RUN).

BLUES

Diagram showing the control panel for the 'BLUES' tone. The settings are: INPUT (LO), CLEAN VOLUME (position 5), BRIGHT (On), DRIVE (position 3), DRIVE VOLUME (position 5), BASS DRIVE (On), BASS (position 3), MIDDLE (position 5), TREBLE (position 5), REVERB (position 5), TONE (position 5), and POWER (RUN).

BLUES LEAD

Diagram showing the control panel for the 'BLUES LEAD' tone. The settings are: INPUT (LO), CLEAN VOLUME (position 7), BRIGHT (On), DRIVE (position 7), DRIVE VOLUME (position 7), BASS DRIVE (On), BASS (position 7), MIDDLE (position 5), TREBLE (position 5), REVERB (position 5), TONE (position 5), and POWER (RUN).

ROCK

Diagram showing the control panel for the 'ROCK' tone. The settings are: INPUT (LO), CLEAN VOLUME (position 7), BRIGHT (Off), DRIVE (position 7), DRIVE VOLUME (position 7), BASS DRIVE (On), BASS (position 7), MIDDLE (position 5), TREBLE (position 5), REVERB (position 5), TONE (position 5), and POWER (RUN).



Laney

OPERATING INSTRUCTIONS

USER SETTINGS - Store your own cool sounds

INPUT: LO, HI
 CLEAN VOLUME: 3, 4, 5, 6, 7
 BRIGHT: 2, 8
 DRIVE: 3, 4, 5, 6, 7, 3, 7, 3
 DRIVE VOLUME: 4, 5, 6, 7, 8
 BASS: 3, 4, 5, 6, 7, 3
 MIDDLE: 4, 5, 6, 7, 3
 TREBLE: 4, 5, 6, 7, 3
 REVERB: 4, 5, 6, 7, 3
 TONE: 4, 5, 6, 7, 3
 POWER: RUN, STANDBY

INPUT: LO, HI
 CLEAN VOLUME: 3, 4, 5, 6, 7
 BRIGHT: 2, 8
 DRIVE: 3, 4, 5, 6, 7, 3, 7, 3
 DRIVE VOLUME: 4, 5, 6, 7, 8
 BASS: 3, 4, 5, 6, 7, 3
 MIDDLE: 4, 5, 6, 7, 3
 TREBLE: 4, 5, 6, 7, 3
 REVERB: 4, 5, 6, 7, 3
 TONE: 4, 5, 6, 7, 3
 POWER: RUN, STANDBY

INPUT: LO, HI
 CLEAN VOLUME: 3, 4, 5, 6, 7
 BRIGHT: 2, 8
 DRIVE: 3, 4, 5, 6, 7, 3, 7, 3
 DRIVE VOLUME: 4, 5, 6, 7, 8
 BASS: 3, 4, 5, 6, 7, 3
 MIDDLE: 4, 5, 6, 7, 3
 TREBLE: 4, 5, 6, 7, 3
 REVERB: 4, 5, 6, 7, 3
 TONE: 4, 5, 6, 7, 3
 POWER: RUN, STANDBY

INPUT: LO, HI
 CLEAN VOLUME: 3, 4, 5, 6, 7
 BRIGHT: 2, 8
 DRIVE: 3, 4, 5, 6, 7, 3, 7, 3
 DRIVE VOLUME: 4, 5, 6, 7, 8
 BASS: 3, 4, 5, 6, 7, 3
 MIDDLE: 4, 5, 6, 7, 3
 TREBLE: 4, 5, 6, 7, 3
 REVERB: 4, 5, 6, 7, 3
 TONE: 4, 5, 6, 7, 3
 POWER: RUN, STANDBY



TUBE AMPLIFIER SURVIVAL TIPS

Tube amplifiers generally sound much warmer/sweeter than solid state transistor amplifiers but they also need a little more respect due to the fragile glass tubes themselves. The L5T-112 uses top quality tubes, three 12AX7 preamp tubes, and an EL84 output tube which should give you years of trouble free service, however like all tube amps; it is important to treat it with a certain amount of care.

- Take care when moving the amplifier. Tubes are fragile glass components, they can easily be damaged if thrown in and out of transit vans,
- Make sure the impedance of your cabinets matches the setting on your amplifier. Improper impedance matching will result in reduced output power output and compromised sound at best and amplifier failure/premature tube failure at worst.
- Allow the amplifier to warm up to room temperature before switching it on, The sudden thermal shock generated can crack the cold glass tube housing plus any moisture is bad news around high voltage electronics.
- Allow the amplifier to cool down after playing before moving. Hot tubes are more susceptible to damage than cool ones.
Use good quality loudspeaker leads, cheap leads are often not up to the job of handling the large requirements for loudspeakers and can often short out.

A tubes life expectancy is based upon a number of factors which include operating temperature, how hard and how often it is played, vibration due to travel etc. Tubes should be changed in your amplifier if you notice any change in your amplifiers performance etc. They need not be changed at any regular interval.

Typical problems with preamp tubes can be a crackley noise, hiss, hum and microphony. The preamp tubes can safely be changed with no action required if they fail or reduce in performance.

Typical output tube problems can be blown HT fuse, sound lacking in punch, sound lacks extreme highs or lows and low level hum. Exact replacement preamp tubes and output tubes are available from Laney via your dealer.

To change a tube, switch off the unit and unplug from the mains supply. Wait for the tubes to cool down. Lay amplifier down on its front face and remove the protective grille held in place with four screws. You should now be able to access the underside of the amplifier chassis. Preamp tubes are protected with a screen can, to remove; gently twist the screen can anti clockwise and then pull up. The tube can then be gently pulled out. Take care when pushing the new tube in to make sure the pins are all aligned properly. Output tubes have a spring retainer which must be pulled away before the tube will come out.



V1 - ECC83/12AX7 HIGRADE
V2 + V3 ECC83/12AX7
V4 EL84 POWER TUBE

L5T-112 CONNECTIONS

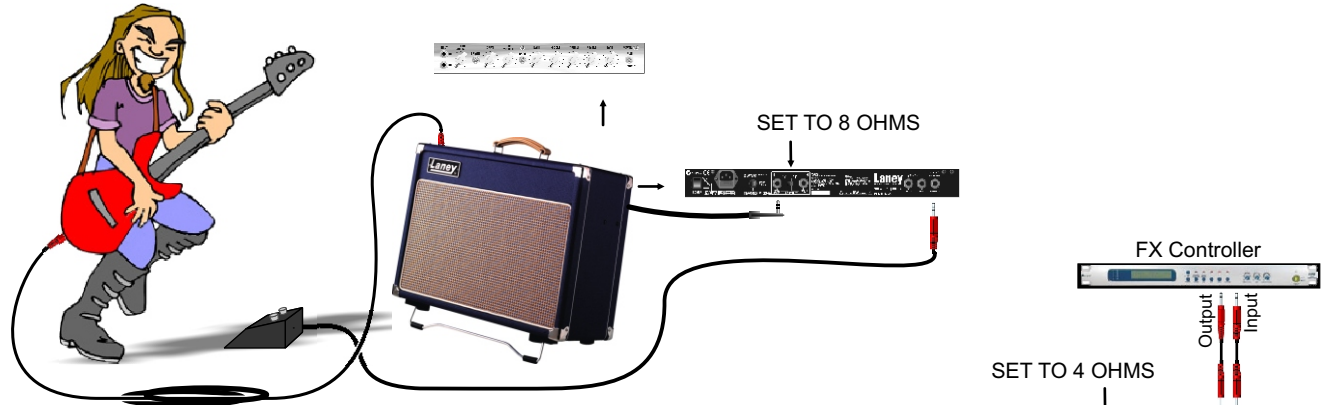

L5T-112 WITH EXTENTION CABINET & FX

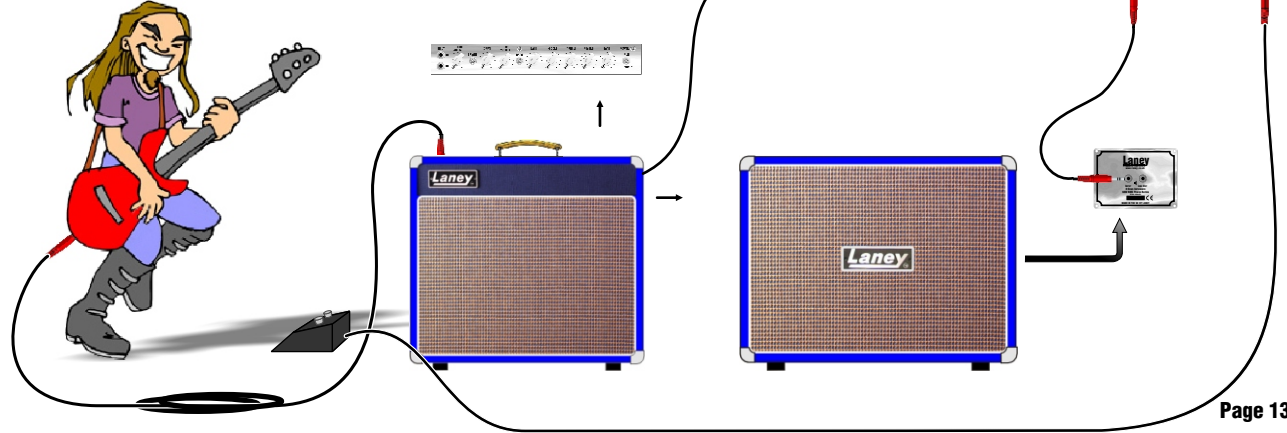

BLOCK DIAGRAM

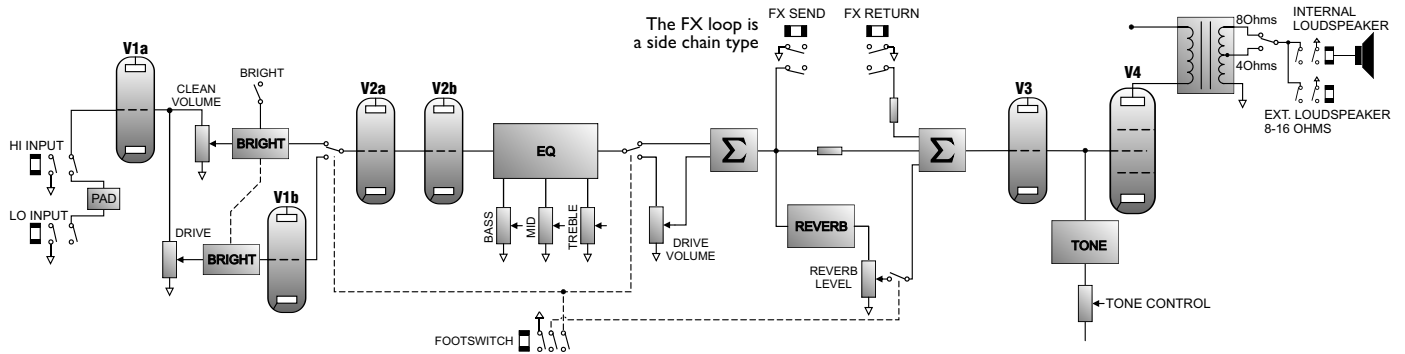

General Notes

Amplifier connection: In order to avoid damage, it is advisable to establish and follow a pattern for turning on and off your equipment. With all system parts connected, turn on source equipment, tape decks, cd players, mixers, effects processors etc. BEFORE turning on your guitar amplifier. Many products have large transient surges at turn on and off which can cause damage to your speakers. By turning on your guitar amplifier LAST and making sure its Volume controls are set to minimum any transients from other equipment will not reach your loudspeakers. Wait until all system parts have stabilised; usually a couple of seconds. Similarly when turning off your system always turn down the Volume controls on your guitar amplifier and then turn off its power before turning off other equipment.

Cables: never use shielded or microphone cable for any speaker connections as this will not be substantial enough to handle the amplifier load and could cause damage to your amplifier system.

Caution: These professional loudspeaker systems are capable of generating very high sound pressure levels. Use care with placement and operation to avoid exposure to excessive levels that can cause permanent hearing damage. (Refer to guidelines on page 2)

Servicing: The user should not attempt to service these products. Refer all servicing to qualified service personnel.

SPECIFICATIONS

Supply Voltage:

~100V, ~120V, ~220V, ~230V, ~240V 50/60Hz Factory Option

Mains Fuse:

(~220V>240V = T250mA L 250V)

(~100V>120V = T500mA L 250V)

HT Fuse:

T100mA L

Power Consumption:

50W

Output Power Rating:

5W

FX Loop:

Side Chain type, nominal 750mV level.

Loudspeaker:

12" Celestion G12H Heritage 8 Ohms

Loudspeaker outputs:

Switchable 8/4 Ohms

EQ:

Passive Bass, Middle and Treble

Tone Boost & cut (Active on top end of signal)

Bright Switch

Input Impedance:

1MOhm

Size:

420*559*250 (H*W*D)

Unit Weight:

19.0 Kg (Shipping Weight 20.0 Kg)

SPECIAL FEATURES

Pure Single Ended Class A Valve tone.

Gold plated PCB's and Jacks, Hi and Low Gain Inputs.

Sealed gold contact relays used in all signal switching for minimum effect to your sound.

Oversized power supplies and output transformers for that big powerful sound and long term reliability.

The best available specially selected tubes throughout, (1*EL84 Power Tube, 3*ECC83/12AX7 Preamp Tubes TAD Selected).

The renowned "type 4" large spring line for that classic guitar reverb sound.

Birch plywood cabinet construction for optimum sound quality and road worthiness.

Unique Tilt Mechanism.

This product conforms to the requirements of the following European Regulations, Directives & Rules:-

CE Mark (93/68/EEC), Low Voltage (72/23/EEC), EMC (93/68/EEC),

RoHS (EU2002/95/EC), WEEE (EU2002/96/EC)



In order to reduce environmental damage, at the end of its useful life, this product must not be disposed of along with normal household waste to landfill sites. It must be taken to an approved recycling centre according to the recommendations of the WEEE (Waste Electrical and Electronic Equipment) directive applicable in your country.

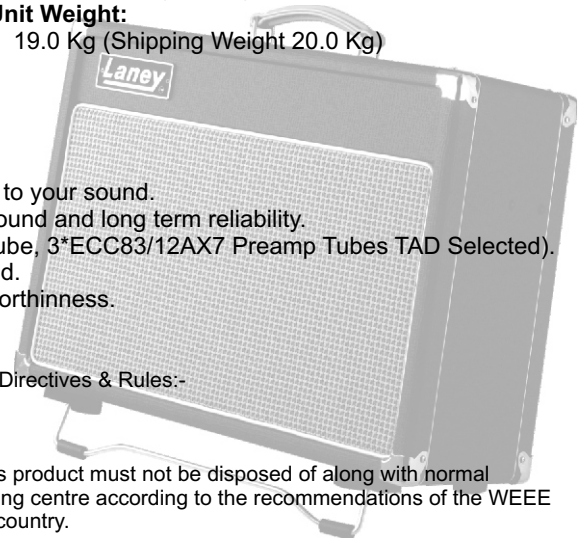

Laney
POWER TO THE MUSIC

LANEY AMPLIFICATION
www.laney.co.uk

In the interest of continued product development, Laney reserves the right to amend product specification without prior notification.

L I O N H E A R T



The Dark Art

