

# OWNER'S MANUAL

## CONDITIONED POWER DISTRIBUTION SEQUENTIAL POWER UP / POWER DOWN



PD11 SP



PD11 SS



PD11 P  
PD11 VP  
PD11 LP  
PD11 LVP  
PD11 LVSP



1450 Lakeside Drive • Waukegan, Illinois 60085 USA  
330-677-4424 • 800-321-6699 • Fax: 330-677-4471  
<http://www.etasys.com> E-mail [eta@etasys.com](mailto:eta@etasys.com)

All designs and specifications are subject to change without notice. Copyright © 2006 ETA Systems. 6MAN-021

ETA's line of *Conditioned Power Distribution* units are designed to reduce damage to sensitive electronic equipment from sudden voltage spikes, damaging power surges, and EMI/RFI noise, which is inherent in utility power lines.

The PD11SP is a sequential four step/stage power up/down conditioned power distribution unit. It is designed to protect electronic equipment that requires a time-delayed start-up, particularly when high in-rush current can potentially damage audio, video, or computer equipment at power up.

PD11SP units are shipped with the ability to be linked or daisy chained. All linked units function as slaves; however, slaves can be set to specific time delays. Any number of units can be linked together with a distance of up to 1000 feet between each location (see Fig. 4).

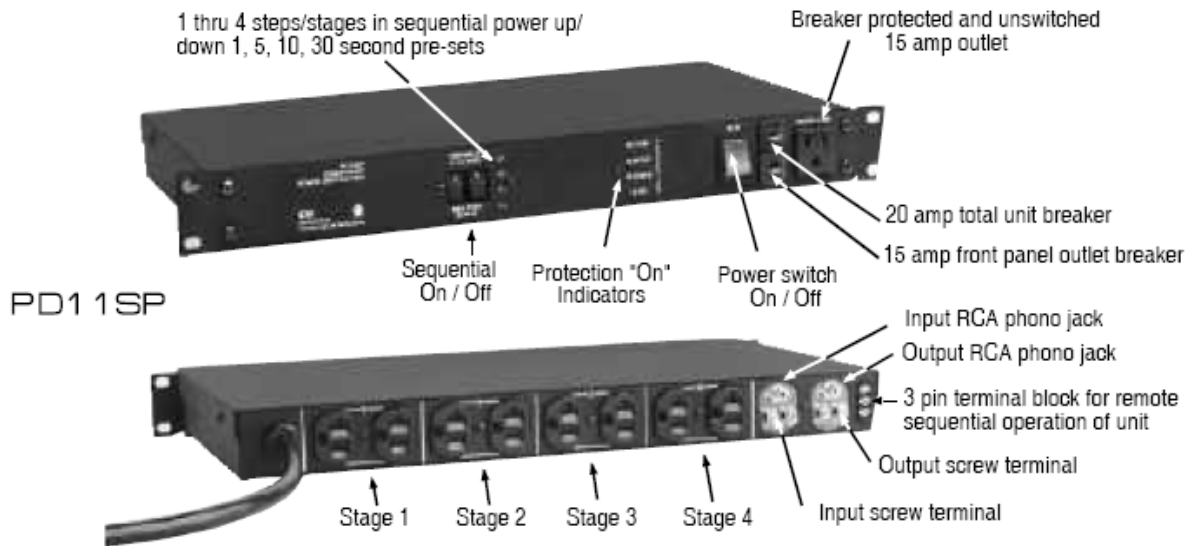

**PD11SP Features:**

- Microprocessor monitored sequential power distribution system
- Four power up/down steps or stages of distributed and conditioned power
- Four pre-set power up/down intervals of 1, 5, 10 or 30 seconds
- Optional manual settings for up to 240 seconds between intervals
- One dual 20 amp U-grounded outlet per stage
- Full 20 amps, 2400 watts capacity per unit
- 12-gauge, 3-prong, 10-foot, 20-amp power cord. Requires 20 amp circuit and receptacle outlet
- Protected "always on" 15 amp AC power outlet on the front panel
- Total unit 20 amp and 15 amp outlet circuit breakers located on front panel
- Three-stage spike and surge protection
- Two-stage EMI/RFI filtration
- Ground and AC line fault check
- One rack space high
- One year limited warranty

**Other Features:**

- Remote control operation
- Standard rear panel RCA connectors and 2 screw terminals

**Specifications:**

Dimensions	19" L x 10" D x 1 3/4" H	Clamping level	200V peak
Weight	10 lbs.	Response time	1 nanosecond
Quality	Black powder coated chassis, anodized aluminum front panel	Max. surge voltage	6000V
Electrical	120V, 50/60 Hz, single phase	Max. surge current	26,000 amps
Max. amps	20/unit	Max. spike energy	630 joules total
Max. watts	2400/unit	Noise attenuation	Transverse greater > 20dB, 1.5kHz to 200 MHz
Max. front outlet	15 amps		
Spike/surge protection	Line to neutral, neutral to ground, line to ground	Certification ETL listed	

The PD11SS is a sequential four step/stage power up/down conditioned power distribution unit. It is designed to protect electronic equipment that requires a time-delayed start-up, particularly when high in-rush current can potentially damage audio, video, or computer equipment at power up.

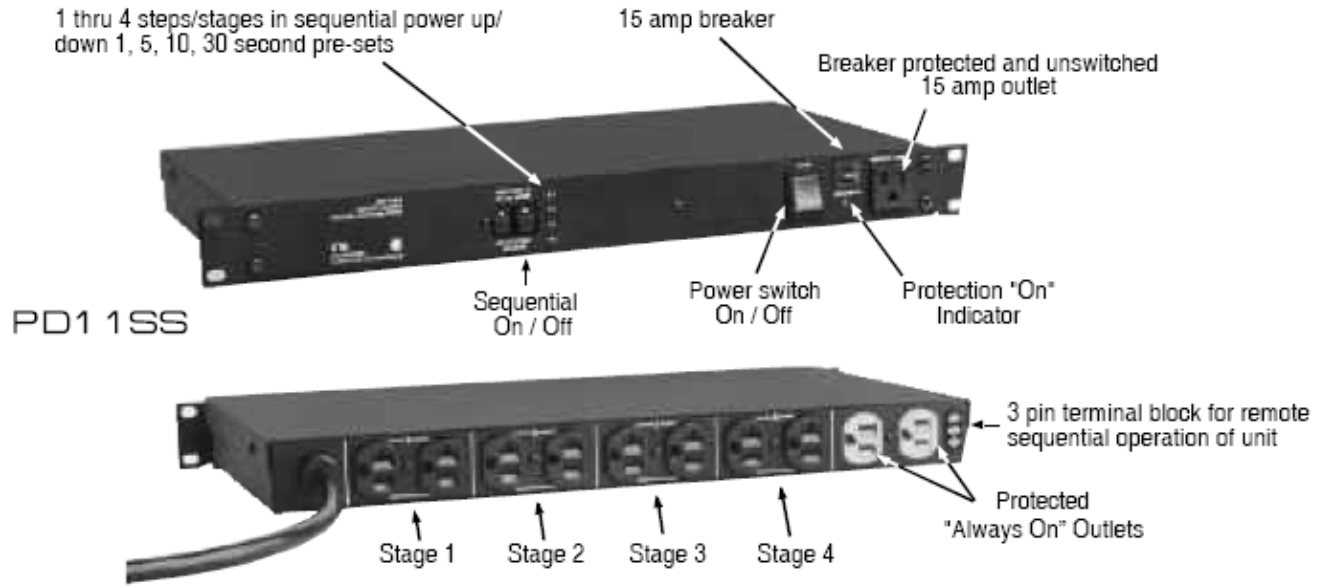

**PD11SS Features:**

- Microprocessor monitored sequential power distribution system
- Four power up/down steps or stages of distributed and conditioned power
- Four pre-set power up/down intervals of 1, 5, 10 or 30 seconds
- Optional manual settings for up to 240 seconds between intervals
- One dual 15 amp U-grounded outlet per stage
- One dual 15 amp "always on" U-grounded outlet
- Full 15 amps, 1800 watts capacity per unit
- 12-gauge, 3-prong, 6-foot, 15-amp power cord
- Protected "always on" 15 amp AC power outlet on the front panel
- Total unit 15 amp outlet circuit breakers located on front panel
- Three-stage spike and surge protection
- EMI/RFI filtration
- Watch dog circuitry with "Go/No Go" L.E.D. display
- One rack space high
- One year limited warranty

**Other Features:**

- Remote control operation

Access to remote feature is internal to three PC board mounted screw terminals for 3-wire hook-up.

**Specifications:**

Dimensions	19" L x 10" D x 1 3/4" H	Clamping level	200V peak
Weight	10 lbs.	Response time	1 nanosecond
Quality	Finish Black powder coated chassis, black anodized aluminum front panel	Max. surge voltage	6000V
	120V, 50/60 Hz, single phase	Max. surge current	12,000 amps
Electrical		Max. spike energy	450 joules total
Max. amps	15/unit	Noise attenuation	Transverse > 35 dB, 1.5 kHz to 200 MHz
Max. watts	1800/unit	Certification	ETL listed
Max. front outlet	15 amps		
Spike/surge protection	Line to neutral, neutral to ground, line to ground		

PD1 1P  
 PD1 1VP  
 PD1 1LP  
 PD1 1LVP  
 PD1 1LVSP

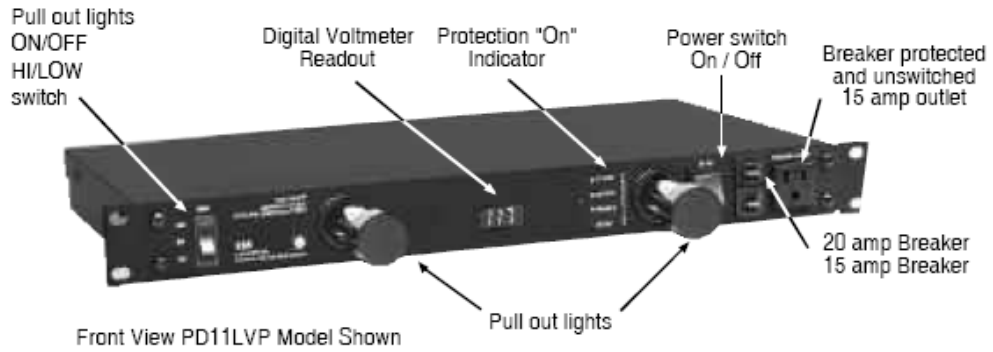

Back View PD11P, 11VP, 11LP, 11LVP



Back View PD11LVSP

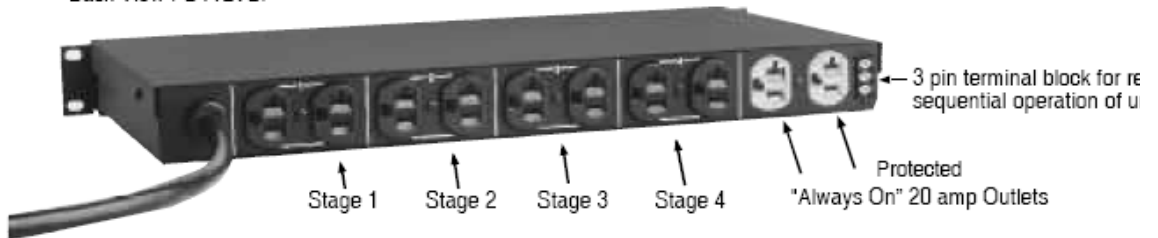

Easy 4-step bulb replacement. Use 120 volt 4 watt bulb (Christmas tree bulb). PD11LP, 11LVP, 11LVSP

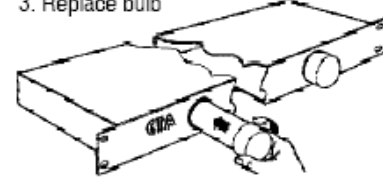
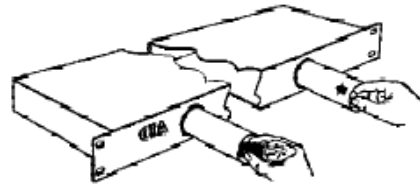
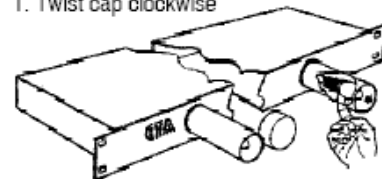
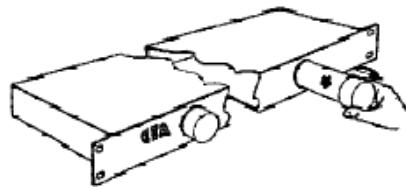

**PD11P, PD11VP, PD11LP, PD11LVP Features:**

- Light Switch (PD11LP/LVP/LVSP) activates rack illumination; choice of HI or LOW intensity
- Light Tubes (PD11LP/LVP/LVSP) illuminates up to 25 rack spaces
- 4 dual 20 amp U-grounded switched outlets per unit
- 1 dual 15 amp U-grounded "always on" and protected outlet
- Digital Voltmeter Readout (PD11VP/LVP/LVSP) displays incoming line voltage
- Resettable 20 amp thermal circuit breaker; 15 amp for front panel outlet
- Lighted Outlet Power Switch activates protection and filtration to all switch outlets and front panel outlet
- 12-gauge, 3-prong, 10-foot, 20-amp power cord. Requires 20 amp circuit and receptacle outlet
- Protected "always on" 15 amp AC power outlet on the front panel
- Total unit 20 amp and 15 amp outlet circuit breakers located on front panel
- Three-stage spike and surge protection
- Two-stage EMI/RFI filtration
- Ground and AC line fault check
- One rack space high
- One year limited warranty

**PD11LVSP Features:**

- Microprocessor monitored sequential power distribution system
- Four power up/down steps or stages of distributed and conditioned power
- Four pre-set power up/down intervals of 1, 5, 10 or 30 seconds
- Optional manual settings for up to 240 seconds between intervals
- One dual 120 amp U-grounded outlet per stage
- One dual 20 amp "always on" U-grounded outlet
- Full 20 amps, 2400 watts capacity per unit
- 12-gauge, 3-prong, 10-foot, 20-amp power cord. Requires 20 amp circuit and receptacle outlet
- Protected "always on" 15 amp AC power outlet on the front panel
- Total unit 20 amp and 15 amp outlet circuit breakers located on front panel
- Three-stage spike and surge protection
- Two-stage EMI/RFI filtration

**Other Features:**

- Remote control operation
- The remote feature is accessed externally through a 3-wire remote block

**PD11LVSP/LVP/LP/VP/P Specifications:**

Dimensions	19" L x 10" D x 1 3/4" H
Weight	10 lbs.
Quality Finish	Black powder coat chassis, black anodized aluminum front panel
Electrical	120V, 50/60 Hz, single phase
Max. amps	20/unit
Max. watts	2400/unit
Max. front outlet	15 amps
Spike/surge protection	Line to neutral, neutral to ground, line to ground
Clamping level	200V peak
Response time	1 nanosecond
Max. surge voltage	6000V
Max. surge current	23,000 amps (PD11LVSP/LVP/VP/LP/P)
Max. spike energy	630 joules total
Noise attenuation	Transverse > 20 dB, 1.5 kHz to 200 MHz
Certification	ETL listed

## Installation Requirements

### PD11P, PD11VP, PD11LP, PD11SP, PD11LVP, PD11LVSP

Plug unit into power source and observe status of four "Protection" light emitting diodes. The (green) "1st Stage", "2nd Stage", and "GROUND OK" L.E.D.'s should normally be illuminated and the (red) "FAULT" L.E.D. should be off. When these indications are present, test the power "On/Off" switch which will illuminate to indicate that power is being supplied to the switched outlets on the rear of the unit.

- A. The "1st Stage" and "2nd Stage" L.E.D.'s indicate that both the input (1st) and output (2nd) stages of circuit protection are active.
- B. The "GROUND OK" L.E.D. indicates that the chassis is connected to the ground wire of the supply outlet.
- C. Fault conditions are represented by the following indications:

**NOTE: On the PD11SS Model** a green L.E.D. located on the front panel is illuminated (indicating "Protection On" status) when unit is plugged into a power source ensuring input and output stages of circuit protection are active.

NOTE: (X) = "ON" ( ) = "OFF"

1 <sup>st</sup> Stage	2 <sup>nd</sup> Stage	Ground OK	Fault	
(X)	(X)	(X)	( )	Supply circuit outlet wiring OK
( )	( )	( )	( )	Open hot
( )	( )	(X)	(X)	Open Neutral or Hot & Ground Reversed
(X)	(X)	( )	( )	Open Ground
(X)	(X)	( )	(X)	Hot & Neutral Reversed

## Operating Instructions

1. Install in a standard 19" rack or free-standing position.
2. Connect Power Distribution power cord into a 20 amp, 120 volt wall outlet (15 amp for Model PD11SS).
3. Plug sensitive electrical equipment into conditioned outlets. All models have an additional protected outlet on the front panel.
4. Move power outlet switch to "ON" position to provide power to electrical equipment.
5. For illumination, pull out light tubes (PD11LP/LVP/LVSP) and move light switch to "HI" or "LOW" position.  
**IMPORTANT! Be sure light switch is in "OFF" position when light tubes are recessed.**
6. Digital voltmeter readout (PD11VP/LVP/LVSP) is calibrated to nominal 117V at the factory. No adjustment necessary.
7. Digital voltmeter readout automatically displays incoming voltage when power cord is connected.

Audio Conditioned Power Distribution is also designed to protect electronic equipment from potentially damaging highvoltage spikes and surges.

Sequencing Audio Conditioned Power Distribution is designed to initiate a turn-on cycle, energizing one circuit immediately with remaining circuits energizing in a delayed fashion. This allows circuits to stabilize when powering up and down eliminating that on-rush of power and potential damage to equipment at output receptacle.

## Programming Time Delays

The PD11SP, PD11SS and PD11LVSP come from the factory set to a 1-second delay for each of the four outlets to turn on. The following instruction will enable you to change the amount of time between each outlet turn on.

- The main power switch must be on
- The sequenced outlets must not be active
- The switches to change the delay time are to left of the unit and they have green L.E.D.s in the switch.
- The switches are labeled POWER DOWN/UP and OFF/ON PRESETS
- The POWER DOWN/OFF is the left switch
- The POWER UP/DOWN is the switch to the right

## Programming Preset Time Delays

- Step 1: Depress and hold the DOWN/OFF switch
- Step 2: Depress and hold the UP/ON switch
- Step 3: Red L.E.D. to the right of the switches will start to flash
- Step 4: When flashing red L.E.D. goes out, release both switches
- Step 5: Both green L.E.D.s on the switches will start to flash rapidly
- Step 6: You are in program mode at this time
- Step 7: The red L.E.D.s to the right indicate what the time delay is set for:  
L.E.D. 1 = 1 second delay  
L.E.D. 2 = 5 second delay  
L.E.D. 3 = 10 second delay  
L.E.D. 4 = 30 second delay
- Step 8: Depress the UP/ON switch to the right to increase the time delay
- Step 9: Depress the OFF/DOWN switch to the left to decrease the time delay
- Step 10: Depress both OFF and ON switches to finish the delay programming

## Programming Manual Time Delays

- Step 1: Follow above instruction to activate L.E.D. 4
- Step 2: Depress the UP/ON switch one more time to activate manual programming time delay mode
- Step 3: All 4 red L.E.D.s to the right will be lit to indicate manual mode
- Step 4: The UP/ON switch green L.E.D. will be lit
- Step 5: Depress the UP/ON switch to start manual delay programming—can program from 5 sec. to 240 sec. delay
- Step 6: Depress the OFF/DOWN to stop the manual Delay timing
- Step 7: Depress both the OFF and ON switches to finish programming mode

### Three-Wire Remote Control Interface

A three-wire remote control interface is added to the main PC board for the PD11SS, PD11SP AND PD11LVSP units. This remote control interface is accessible through an external terminal block on the back of the unit (see Figure 6). This interface requires an external user provided switch, L.E.D., and a three-wire cable to implement. The interface has been tested reliably over 1000 feet with 22-gauge speaker wire (see Figures 1 and 5).

Connect the short minus (-) lead of the L.E.D. and one side of the switch to the COMMON terminal, the long plus (+) lead of the L.E.D. to the L.E.D. terminal, and finally the other side of the switch to the ON/OFF terminal. When you close the switch, the L.E.D. will begin flashing until all channels have sequenced ON, and then the L.E.D. will remain ON. When you open the switch the L.E.D. will begin flashing until all channels have sequenced OFF and then the L.E.D. will remain OFF.

#### Remote Relay Function Operation (optional)

Using a set of relay contacts that are normally open instead of a switch you can control the PD11SS, PD11SP AND PD11LVSP units with a relay. When you apply power to the relay the channels will sequence ON, and when you disconnect power from the relay the channels will sequence OFF. This allows you to interface a PD11SS, PD11SP AND PD11LVSP unit with other equipment that has dry (normally open) relay contacts (see Figure 2).

**Larger Installations** In a larger installation, you can control different equipment racks from a remote location by running three-wire cable from each rack back to the remote location. Then attach an L.E.D. and switch as before, these would be mounted in the user's control panel, and you now have remote control of each rack in a single location (see Figure 3).

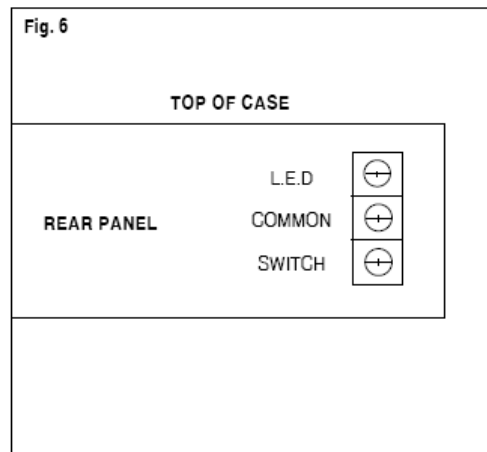
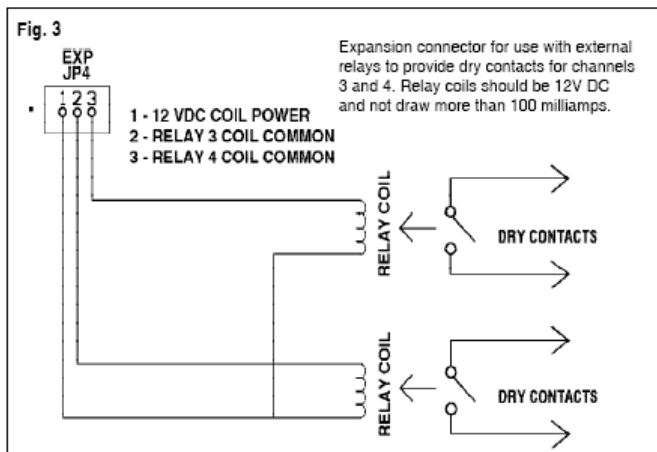
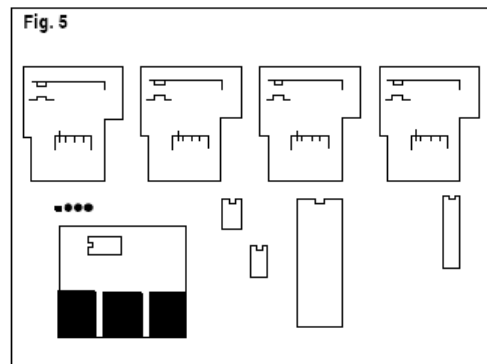
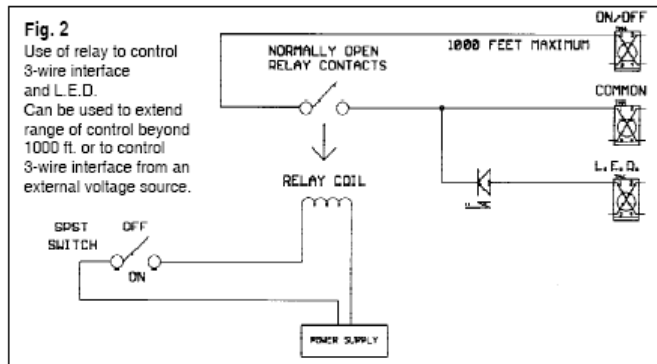
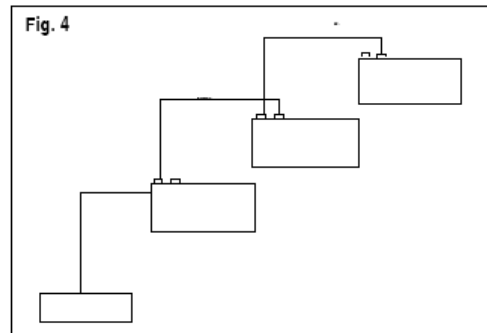
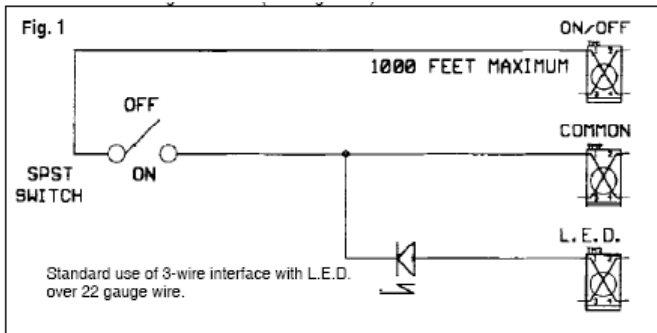

## ***ETA Conditioned Power Distribution... The Benchmark By Which Professionals Compare.***

For over 20 years ETA has developed, manufactured, and sold high amperage theatrical lighting systems from which have evolved an extensive line of rack mounted conditioned power distribution products designed to protect today's sensitive electronic digital equipment.

The "PD" Conditioned Power Distribution Series easily deals with normal AC line power fluctuations, as well as the more drastic abnormalities of the spike and surge variety. Also, filtering of interferences caused by electromagnetic (EMI) and radio frequency (RFI) transmissions is routinely accomplished. More sophisticated ETA models utilize microprocessor technology to regulate AC power and sequence power turn-on— reducing high in-rushes of power.

ETA's sophisticated electronic protection technology is the favorite of professionals who demand flawless operation of digital mixers, processors, amplifiers and PCs—whether in the studio, in the boardroom, on tour, or in a home entertainment environment.



**Thank you for choosing ETA Systems  
Power Distribution**

Your business is appreciated.

Call 1-800-321-6699 for an ETA Full Line  
Brochure.



### **Power Conditioning Firsts from ETA**

- "Always-On" Protected Outlets
- 10 Rear Panel Outlets
- Front Panel Convenience Outlets
- Digital Voltmeter Display Readouts
- Microprocessor Managed Voltage Regulators
- Programmable and Linkable Sequential Turn-on Models
- Models Adaptable for Multiple AC Adapters
- High Amp Conditioned Models
- Easy Bulb Change Feature

### **Standard on Every ETA Power Conditioning Model**

- Spike and Surge Protection and EMI/RFI Filtration on All Three Legs of the Incoming AC Power— A Must to Ensure Protection of Electronic Components and Equipment.

### **Typical Uses**

All Professional Permanent Installations, Recording Studios, Theatres, Schools, Clubs, Churches, any entertainment venue, business board rooms, and audio/ visual multi-use presentation rooms.

**Portable Applications :** On-The-Road Concert Tours, Bands, and D.J. services.

**Other Important Applications:** A/V racks, computer networks, and home entertainment centers.

1450 Lakeside Drive • Waukegan, Illinois 60085 USA  
330-677-4424 • 800-321-6699 • Fax: 330-677-4471  
<http://www.etasys.com> E-mail [eta@etasys.com](mailto:eta@etasys.com)



## Addendum

**NOTE:** The following pages are added as an addendum to the ETA manual. For most reliable performance of ETA Systems sequencing products, it is recommended that you use one of the cable types illustrated in the following pages. When installing any cabling in a plenum or return air space, it is the responsibility of the installer to ensure that Teflon jacketed cable is used where required by fire codes. ETA Systems assumes no responsibility for code violations or hazards that result from improper selection or installation of signaling cable.

**8489 Non-Paired - Audio, Control and Instrumentation Cable**

	<p>For more information please call <b>1-800-Belden1</b></p> <p><u>See Put-ups and Colors</u></p> <p>Related Documents : No. 1.pdf</p>
--	--

**Description:**

18 AWG stranded (19x30) tinned copper conductors, conductors cabled, PVC insulation, PVC jacket.

**PHYSICAL CHARACTERISTICS:**

**CONDUCTOR:**

Number of Conductors	4
Total Number of Conductors	4
AWG	18
Stranding	19x30
Conductor Material	TC - Tinned Copper

**INSULATION:**

Insulation Material	PVC - Polyvinyl Chloride
Nom. Insulation Wall Thickness	.017 in.

**OVERALL CABLING:**

Overall Cabling Lay Length	3 in.
Overall Cabling Twists/ft.	4

Overall Cabling Color Code Chart :

Number	Color	Number	Color
1	Black	3	Red
2	White	4	Green

**OUTER SHIELD:**

Outer Shield Material	Unshielded
-----------------------	------------

**OUTER JACKET:**

Outer Jacket Material	PVC - Polyvinyl Chloride
Outer Jacket Nominal Wall Thickness	.032 in.

**OVERALL NOMINAL DIAMETER:**

Overall Nominal Diameter	.257 in.
--------------------------	----------

**MECHANICAL CHARACTERISTICS:**

## 8489 Non-Paired - Audio, Control and Instrumentation Cable

Operating Temperature Range	-20°C To +60°C
UL Temperature Rating	60°C (UL AWM Style 2598)
Bulk Cable Weight	44.1 lbs/1000 ft.
Max. Recommended Pulling Tension	83 lbs.
Min. Bend Radius (Install)	2.6 in.

### APPLICABLE SPECIFICATIONS AND AGENCY COMPLIANCE:

#### APPLICABLE STANDARDS:

NEC/(UL) Specification	CMG
CEC/C(UL) Specification	CMG
AWM Specification	UL Style 2598 (300 V 60°C)
EU CE Mark (Y/N)	Yes
EU RoHS Compliant (Y/N)	Yes
EU RoHS Compliance Date (mm/dd/yyyy):	04/01/2005

#### FLAME TEST:

C(UL) Flame Test	FT4
------------------	-----

#### PLENUM/NON-PLENUM:

Plenum (Y/N)	N
Plenum Number	88489, 82489

#### ELECTRICAL CHARACTERISTICS:

Nom. Capacitance Conductor to Conductor @ 1 KHz	26 pF/ft
Nom. Conductor DC Resistance @ 20 Deg. C	6.3 Ohms/1000 ft
Max. Operating Voltage - UL	300 V RMS (UL AWM Style 2598)
Max. Recommended Current	4 Amps per conductor @ 25°C

#### PUT-UPS AND COLORS:

Item	Description	Put-Up (ft.)	Ship Weight (lbs.)	Jacket Color	Notes
8489 060100	4 #18 PVC PVC	100	5.1	CHROME	
8489 0601000	4 #18 PVC PVC	1000	48	CHROME	C
8489 060250	4 #18 PVC PVC	250	12	CHROME	
8489 060500	4 #18 PVC PVC	500	24	CHROME	C
8489 060U1000	4 #18 PVC PVC	U1000	46	CHROME	
8489 060U500	4 #18 PVC PVC	U500	23.5	CHROME	

C = CRATE REEL PUT-UP.

Revision Number: 2      Revision Date: 05-16-2005

---

## **8489 Non-Paired - Audio, Control and Instrumentation Cable**

---

© Copyright 2006 Belden, Inc  
All Rights Reserved.

Although Belden ("Belden") makes every reasonable effort to ensure their accuracy at the time of this publication, information and specifications described herein are subject to error or omission and to change without notice, and the listing of such information and specifications does not ensure product availability.

Belden provides the information and specifications herein on an "AS IS" basis, with no representations or warranties, whether express, statutory or implied. In no event will Belden be liable for any damages (including consequential, indirect, incidental, special, punitive, or exemplary damages) whatsoever, even if Belden has been advised of the possibility of such damages, whether in an action under contract, negligence or any other theory, arising out of or in connection with the use, or inability to use, the information or specifications described herein.

All sales of Belden products are subject to Belden's standard terms and conditions of sale.

Belden believes this product to be in compliance with the following environmental regulations: California Proposition 65 Consent Judgment For Wire & Cable Mfgs. (San Francisco Superior Court Nos. 312962 And 320342); EU RoHS (Directive 2002/95/EC, 27-Jan-2003); Material manufactured prior to the compliance date may still be in stock at Belden facilities and in our Distributor's inventory. EU ELV (Directive 2000/53/EC, 18-Sept-2000); EU WEEE (Directive 2002/96/EC, 27-Jan-2003); And EU BFR (Directive 2003/11/EC, 6-Feb-2003). The information provided in this Product Disclosure, and the identification of materials listed as reportable or restricted within the Product Disclosure, is correct to the best of Belden's knowledge, information and belief at the date of its publication. The information provided in the Product Disclosure is designed only as a general guide for the safe handling, storage, and any other operation of the product itself or the one that it becomes a part of. This Product Disclosure is not to be considered a warranty or quality specification. Regulatory information is for guidance purposes only. Product users are responsible for determining the applicability of legislation and regulations based on their individual usage of the product.

Belden declares this product to be in compliance with EU LVD (Low Voltage Directive 73/23/EEC), as amended by directive 93/68/EEC.

# COMMUNICATION & CONTROL

MULTICONDUCTOR, UNSHIELDED  
PVC/PVC

UL TYPE CM  
UL AWM 2509, CSA CMG FT 4  
RoHS COMPLIANT, 300 VOLT

## CHARACTERISTICS

### OPERATING TEMPERATURE:

- -20°C to 80°C – AWM
- 75°C – CM

### VOLTAGE RATING:

- 300 Volt – CM
- 150 Volt – CL2

### COLOR DESCRIPTION:

- Color Code: Chart D Page 375
- Jacket Color: Gray

### PRODUCT DESCRIPTION:

- Conductor: Stranded Tinned Copper
- Insulation: Color-Coded PVC
- Jacket: PVC

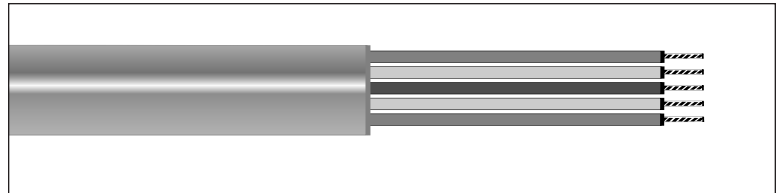

### 80°C 300V - UL 2509 - NEC TYPE CM

18 AWG (0,81mm<sup>2</sup>), 16/30 (16x0,25mm), Insulation Thickness: **0.016"** (0,41mm)

Alpha Part No.	No. of Cond.	Jacket Thickness		Diameter	
		Inches	mm	Inches	mm
1897C	2	0.020	0,50	0.20	5,0
1898C	3	0.020	0,50	0.21	5,3
1898/4C	4	0.020	0,50	0.24	6,1
1898/5C	5	0.020	0,50	0.26	6,6
1898/6C	6	0.020	0,50	0.29	7,4
1898/7C	7	0.020	0,50	0.29	7,4
1898/8C	8	0.025	0,63	0.31	8,0
1898/9C	9	0.025	0,63	0.34	8,8
1898/10C	10	0.025	0,63	0.37	9,4
1898/12C	12	0.025	0,63	0.38	9,8
1898/15C	15	0.030	0,76	0.44	11,3
1898/19C	19	0.030	0,76	0.47	11,9
1898/25C	25	0.035	0,88	0.56	14,1

### 80°C 300V - UL 2509 - TYPE CM

16 AWG (1,31mm<sup>2</sup>), 19/0.0117 (19x0,29mm), Insulation Thickness: **0.016"** (0,41mm)

Alpha Part No.	No. of Cond.	Jacket Thickness		Diameter	
		Inches	mm	Inches	mm
1899C	2	0.020	0,50	0.22	5,7
1899/3C	3	0.020	0,50	0.24	6,3
1899/4C	4	0.020	0,50	0.27	6,9

### 80°C 300V - UL TYPE CL2

14 AWG (2,08mm<sup>2</sup>), 41/30 (41x0,25mm), Insulation Thickness: **0.020"** (0,50mm)

Alpha Part No.	No. of Cond.	Jacket Thickness		Diameter	
		Inches	mm	Inches	mm
1891C	2	0.020	0,50	0.26	6,6
1891/3C	3	0.020	0,50	0.28	7,1

### 80°C 300V - UL TYPE CL2

12 AWG (3,31mm<sup>2</sup>), 65/30 (65x0,25mm), Insulation Thickness: **0.020"** (0,50mm)

Alpha Part No.	No. of Cond.	Jacket Thickness		Diameter	
		Inches	mm	Inches	mm
1892C	2	0.020	0,50	0.30	7,6
1892/3C	3	0.020	0,50	0.32	8,1

## SPECIFICATIONS

- UL Type CM, AWM 2509 (18 & 16 AWG)
- UL Type CL2, (14 & 12 AWG)
- CSA CMG FT4 (18 & 16 AWG)
- CSA AWM I A/B, II A/B FT4 (14 & 12 AWG)
- Passes UL Vertical Tray Flame Test
- "C" Suffix Indicates CM or CL2 Rating as Applicable
- RoHS Compliant

UL LISTED Passes UL VW-1 Flame Test Underwriters Laboratories Inc. Certified Canadian Standards Association



## AVAILABILITY

- 100 ft (30,5m), 500 ft (152m), 1000 ft (305m) put-ups



Toll Free: 1-800-52 ALPHA • Telephone: 908-925-8000 • Fax: 908-925-6923  
Europe/UK Telephone: +44 (0) 1932 772422 • Europe/UK Fax: +44 (0) 1932 772433

Web Site: [www.alphawire.com](http://www.alphawire.com)  
Email: [info@alphawire.com](mailto:info@alphawire.com)