



G2500 Super Hybrid

*Installation and
Operations Manual*

G2500 SUPER HYBRID INSTALLATION AND OPERATIONS MANUAL

Copyright© 1993 by Gentner Communications Corporation. All rights reserved. No part of this manual may be reproduced in any form or by any means without written permission from Gentner Communications Corporation.

Printed in the United States of America. Gentner Communications Corporation reserves specification privileges.

Information in this manual is subject to change without notice.

This manual was written and designed by Renee Gibson.

*Gentner Part No. 800-115-001 (Rev. A1)
September 1993*

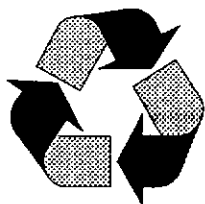

Gentner Communications Corporation is committed to protecting the environment and preserving our natural resources.

This manual has been printed entirely on recycled paper.

Table of Contents

Introduction	1
About this Manual	1
Features	2
Benefits	2
Applications	3
Single Hybrid Use	3
Multiple Hybrid Interconnection (Caller Mix Used)	3
Multiple Hybrid Interconnection (Individual Caller Outputs Used)	3
VIP Talk Shows	3
Meet-Me Teleconference Bridge	4
Detailed Product Description	5
Front Panel Description	5
Back Panel Connectors	7
Loop In/Out	8
Accessories	8
Installation	9
Unpack and Check Components	9
Inspect Your Shipment	9
Tools Required	9
Environmental Requirements	9
Jumper and DIP Switch Changes	9
Jumpers	10
DIP Switches	11
Mounting	11
Make Back Panel Connections	13
RS-232	13
Remote	13
Send	14
Caller	14
Mix	14
Line	15
Set	15
Power Module	15
Making Loop Connections	16
Single Hybrid Operation	16
Stand Alone Auto Mix-Minus	16

Multiple Hybrid Interconnection (four methods)	17
Loop/Mix	17
Loop/Separate	18
VIP Mode	19
Meet-Me Bridge	21
Calibration and Setup	22
Check Default Settings	22
Set Levels	23
Begin Calibration	23
Setup Routine	24
Adapting	24
Electronic	24
After a Power Failure	24
Footnote	24
Operation	25
Front Panel Controls	25
Answering a Call	25
Making a Call	25
Disconnecting a Call	26
Auto-Answer/Disconnect Mode	26
Terminate Auto-Answer/Disconnect Mode	26
Mute Caller Audio	26
Remote Control	26
Recording Calls	27
When Not in Use	27
Emergency Restoration	27
Performing an Analog Null	27
Specifications	29
Warranty	31
Schematics	32
RS-232 Supplement	Supplement-1

Introduction

Thank you for purchasing Gentner's G2500 Super Hybrid. Gentner has been the established leader in the broadcast telephone interface market, providing solutions to the broadcaster's telephone needs for many years. This unique technology has recently been applied to Gentner's superior teleconferencing products. As the teleconferencing products were engineered, additional technology was developed with the use of Digital Signal Processing-based Telephone Echo Canceling; Echo Suppression (ES) and Echo Canceling (EC). This latest digital technology has now been incorporated into the G2500 Super Hybrid for use by broadcasters.

If you need more information about echo suppression and cancellation, or want to know more about Gentner's other broadcast or teleconferencing products, call Gentner Professional Audio Products Division at the number shown below.

About this Manual

This manual is designed to walk you through simple installation, setup and operation of your Super Hybrid equipment.

To receive the full benefit of the Gentner G2500 Super Hybrid, we recommend that you take a few minutes to review the "Applications" and "Installation" sections of this manual before proceeding. You may discover other applications for your new hybrid that will continue to enhance the operation of your telephone interface equipment. We are confident you will be very pleased with the ease of use, its quick installation, versatility, and of course, high quality.

We welcome and encourage your comments on this product so that we can continue to improve our broadcast products. Please call, fax or write us at the location noted below.

Gentner Communications Corporation
Professional Audio Products Division
1825 Research Way
Salt Lake City, Utah 84119
Telephone: (801) 975-7200
Facsimile: (801) 977-0087

Features

- Internally generated auto mix-minus
- Superior Telephone Echo Cancellation and AGC (Automatic Gain Control) routines for crisp, clear separation of send and receive audio
- 100% Digital Audio Processing
- Nulling and renull on new line selection
- Easy to manage LED level setting indicators
- Simple conference hook-up with built-in loop conference bus
- Jumper selection separates callers when multiple hybrids are conferenced through the loop bus
- Auto Answer/Disconnect or manual control
- Mute button mutes caller audio
- Rack mountable in standard 19" equipment rack
- Simple to install—Simple to use

Benefits

- Digital Echo Cancellation—The G2500 Super Hybrid digitally subtracts the caller's voice (echo) from the audio being returned to the caller. The G2500 digitally eliminates both direct and indirect echoes, making the telephone audio much more intelligible
- No mix-minus required from your console—The G2500 generates its own mix-minus using echo cancellation and echo suppression routines to separate the caller audio out of the program feed (EC on/off switch is selectable from the front panel)
- RS-232 Serial Port available for remote control of the G2500 from a computer
- Conferencing flexibility—callers combined or separate; your choice with a simple jumper change
- Highly reliable operation and setup integrity

Applications

Several application methods are available, as described below. Determine the operating method required for your application, then follow detailed instructions starting on page 9 in the "Installation" section of this manual to set up your hybrid(s) properly.

NOTE: *Gentner manufactures two Super Hybrid models; the G2500 for radio station and professional audio applications, and the G3200, primarily used when open microphones and speakers are connected to the hybrid.*

G2500s and G3200s can be looped together with good results when configured properly. Consult the G3200 Installation and Operations Manual for complete information, or contact Gentner for technical assistance.

Single Hybrid Use

A single G2500 Super Hybrid is perfect for a production room or studio. Unlike other hybrids, the G2500's auto mix-minus permits you to feed program output down the telephone line, even when the output contains caller audio. The G2500 *automatically* removes the caller audio from its feed path. The hybrid's auto mix-minus can be disabled if your console provides its own. You will be able to install and set up the G2500 in minutes and still maintain the superior results desired from a Super Hybrid.

Multiple Hybrid Interconnection (Caller Mix Used)

Up to eight Super Hybrids can be used in sequence and looped together, while still maintaining high quality results for noise reduction and echo cancellation.

In this application, all callers are mixed together and only one input is used on the console. This conference mode is used when limited connections are available on the console. Internal AGC routines keep all the callers at a consistent level. The Super Hybrids are connected together by the Loop In/Out XLR connector ports.

Multiple Hybrid Interconnection (Individual Caller Outputs Used)

In this mode, up to eight Super Hybrids can be linked in sequence; however, each hybrid is connected directly to its own pot on the console. The volume for each individual call can be adjusted from the console. The Super Hybrids are connected together by the Loop In/Out XLR connector ports.

VIP Talk Shows

Depending on the type of show format you use, your Super Hybrids can be set up so caller audio can be either mixed or separated. Your VIP and your audience will hear the cleanest telephone audio available.

**Meet-Me
Teleconference
Bridge**

Up to eight people can be conferenced together with good results when each Super Hybrid is connected to an incoming telephone line and set up in auto-answer mode. Each line's number is assigned to a participant. When the call is auto-answered on the first ring, the caller is automatically linked to the others who have called in. The hybrids are interconnected through the Loop In/Out feature. The Super Hybrids sense loop drop and automatically disconnect each line when the caller hangs up.

Detailed Product Description

The G2500 Super Hybrid operates with a 3.4 kHz bandwidth and at least a 32 msec echo cancellation span. It is designed for use in a radio station environment, as well as sound contracting applications where high quality, reliable, professional audio equipment is needed.

Front Panel Description

Easy-to-access and read front panel controls and LED indicators make operation of the G2500 simple to control and adjust. The front panel drawing below shows each front panel LED, switch and button.

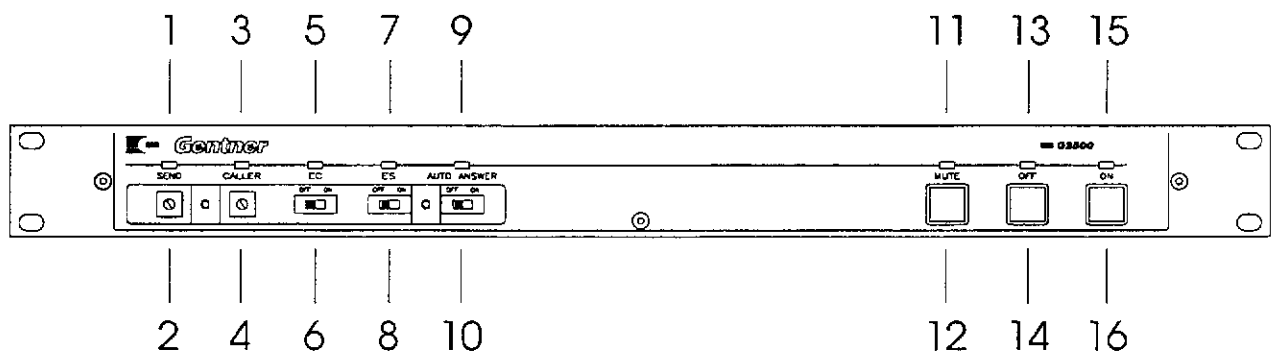

Figure 1

Front Panel Description

1. SEND indicator. Red/green LED indicating send audio into the hybrid. Green is normal level. Red is peak level.
2. SEND trim pot. Nominal level is +4 dBm (at 12:00 indicator notch). The trim pot controls send audio into the hybrid. Gain adjustment range from nominal is ∞ to +12 dB.
3. CALLER indicator. Red/green LED indicating caller audio into the hybrid. Green is normal level. Red is peak level.
4. CALLER trim pot. Nominal level is +4 dBm (at 12:00 indicator notch). The trim pot controls caller audio into the hybrid. Gain adjustment range from nominal is ∞ to +12 dB.
5. EC indicator (Echo Cancellation). Red/green LED. Green is on and operating normally. Lights red when EC is in overload. ES should be activated. When switch is off, LED will be off.
6. EC latching switch (Echo Cancellation). Switch should be on for normal operation (LED will be lit). When on, hybrid will be in Auto Mix-Minus mode and EC routines will be operational.

7. ES indicator (Echo Suppression). Green LED is lit when on and operating normally. When ES switch is off, LED is off.
8. ES latching switch (Echo Suppression). When EC is in overload, Echo Suppression should be turned off. When Switch is on, ES routine will be active and LED will be lit green.
9. AUTO-ANSWER/DISCONNECT indicator. Green LED will be lit when the switch is on. No light will be lit when the switch is off.
10. AUTO-ANSWER/DISCONNECT latching switch. On activates the auto-answer/disconnect mode. Off requires manual answering of the hybrid.
11. MUTE indicator. Red LED. When lit, mute is active. No light indicates mute mode is off.
12. MUTE on/off button. This momentary latching button turns mute mode on/off. When on, only caller audio is muted.
13. ON indicator. The green indicator LED will glow only when the system is on.
14. ON button. This momentary button turns the hybrid on, allowing caller audio to be processed and sent to the console.
15. OFF indicator. Red LED. When the hybrid is off, this LED will be lit.
16. OFF button. This momentary button turns the hybrid off, terminating all processing and audio signals.

Back Panel Connectors

Figure 2 below shows back panel connections.

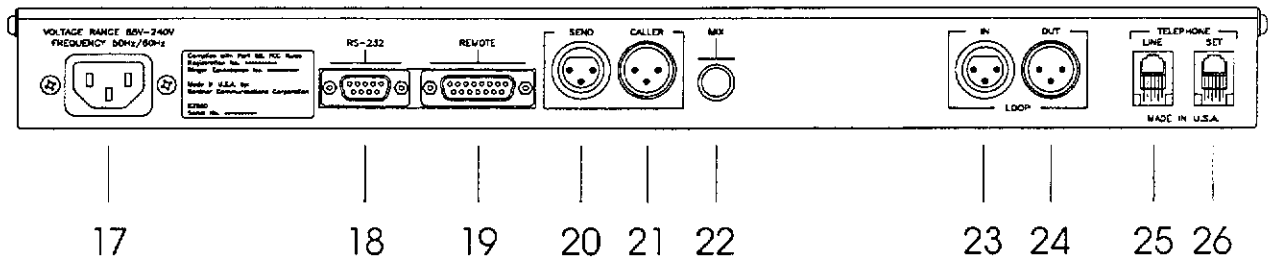

Figure 2

G2500 Back Panel Connections

17. **POWER** module. This is auto-adjusting to accommodate voltage requirements between 85 to 240 VAC 50/60 Hz.
18. **RS-232**. This DB-9 female connector is a serial port used to control the G2500 front panel functions from a computer.
19. **REMOTE DB-15**. This female connector is used with a customer supplied remote control to access front panel functions such as On, Off, Mute, and their corresponding LED indicators.
20. **SEND**. This female XLR connector is used to input balanced program audio from the console into the hybrid.
21. **CALLER**. The male XLR connector provides balanced caller output audio to the console.
22. **MIX**. This connector is an RCA jack containing both program and caller audio. This jack is used to connect to your recording device.
23. **LOOP IN**. This female XLR connector provides conferencing input interconnection between multiple hybrids. (Compatible only with Loop Out conference bus.)
24. **LOOP OUT**. This male XLR connector provides conferencing output interconnection between multiple hybrids. (Compatible only with Loop In conference bus.)
25. **LINE**. This standard RJ-11C telephone line in jack connects your telephone line to the hybrid.
26. **SET**. This telephone set jack connects your telephone set to the hybrid via the RJ-11C connector.

Loop In/Out The loop feature allows you to connect multiple G2500 Super Hybrids together to enable quick setup in a variety of operating modes, while still maintaining superb audio quality. See “Applications”, starting on page 3, for more information about the loop feature.

- Accessories**
- The G2500 is shipped with a power cord, a 12 foot telephone line cord, and one 12 inch loop cable, a Gentner screwdriver, rack mount screws, Product Warranty card, and this Installation and Operational Manual.
 - A single line telephone set is not required for normal use; however, the set jack is provided should you need to connect a telephone set to your G2500.
 - A user-supplied remote control or contact closure controller can be connected to the REMOTE DB-15 connector to activate front panel functions (not required).
 - A user-supplied computer can be linked to the G2500 through the RS-232 Serial Port to operate front panel functions (not required).

Installation

This section details the installation procedures for your new G2500 unit. General information is included to help you understand each procedure, where required. Refer to "Make Back Panel Connections" beginning on page 12 for a description and placement of each of the connections you will be making, as described in this section. Each connection is numbered for easy identification, and is referred to by number in the description.

Unpack and Check Components

Gentner is not responsible for product damage incurred during shipment. You must make claims directly with the carrier. Inspect your shipment carefully for obvious signs of damage. If the shipment appears damaged, retain the original boxes and packing material for inspection by the carrier. Contact your carrier immediately.

Inspect Your Shipment

Your G2500 unit comes in one main box containing a power cable, a 12 foot telephone line cord, rack mount screws and washers, a Warranty Card and this Installation and Operations Manual. You will also receive one loop cable with each Super Hybrid ordered. Check off each item indicated on the Master Packing List to ensure that all listed items were received.

Tools Required

- Gentner's small flat-blade screwdriver (for fine-tuning adjustment pots).
- Medium Phillips screwdriver (for rack mounting and opening chassis, if required).

Environmental Requirements

The G2500 can be safely operated in a room with varying temperatures between 32° and 100° Fahrenheit (0° to 38° Centigrade) and between 0% and 80% relative humidity.

Jumper and DIP Switch Changes

Your G2500 Super Hybrid is factory set to operate in the most common modes without internal jumper changes. Jumpers are factory set at J1-2 and 6. However, when multiple hybrids are linked and callers must be separated, a jumper change is required. A different jumper change is required when setting up the units for a Meet-Me Bridge. (Refer to the table on page 10.)

Under normal operating conditions, DIP switch changes are not required. The table on page 11 will show what options are available, should you want to make changes for non-typical applications. If you elect to make a DIP switch change, it should be completed at the time the chassis is opened while making jumper changes.

Jumpers

WARNING! Before opening the chassis, you MUST disconnect all power to the unit! An exposed power supply is accessible immediately when removing the chassis cover. Severe shock could result if the power is connected and the power supply unit is touched.

- Disconnect all power! Loosen the four screws on the side panels of the G2500 and G3200 units. Lift the top cover and place to the side.
- Locate the jumpers. Looking at the PC boards from the front panel point of view, the jumpers will be exposed on the bottom board toward the front and on the left side. The labeling on the PC board will show J1 through J6.

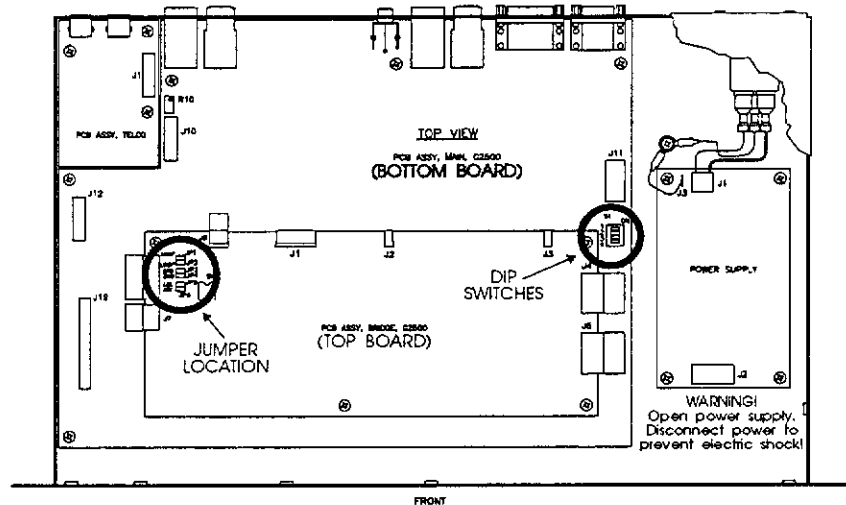

Figure 3

Locating the Jumpers and Making the Changes

- Change the jumper(s) as follows:

IF YOUR APPLICATION IS:	CHANGE REQUIRED:
Single Hybrid Use.	No change required. Jumpers remain on 1-2, 6.
Callers Mixed when multiple Super Hybrids are looped together. (Includes VIP setup.)	No change required. Jumpers remain on 1-2, 6.
Callers Separated when multiple Super Hybrids are looped together. (Includes VIP setup.)	Change jumpers to 1-2, 5 on all looped hybrids.
Multiple Hybrids looped for Meet Me Bridge.	Change jumpers to 3-4, 6 on all looped hybrids.

- Do not apply power yet.

DIP Switches

Before proceeding, make certain that the power is disconnected from the hybrid!

- If no DIP Switch change is required, replace the top cover and tighten the screws to close the chassis.
- If a DIP Switch change is necessary for your application, locate the DIP Switches on the PC board as shown in Figure 3. DIP switches are located on the top PC board, near the right edge about midway. The power supply is located nearby.
- Make the change as indicated in the table below.

Dip Switch Number	Default Position	Function/Alternate Operation
1	Off	Not used.
2	Off	Switch to ON to enable test tone for analog nulling. (See Performing an Analog Null on page 27.)
4	Off	Momentary or Latching control for the ON button. When ON, the ON button must be held to keep the unit connected to the line. When the ON button is released, the unit turns off. Can be used with a toggle switch to remotely control the unit.
3	Off	Not used.

- Replace the top cover and tighten the screws to close the chassis.
- Do not apply power yet.

Mounting

- Mount the unit in a standard 19" equipment rack using the screws and washers provided. Do not block any ventilation holes.

Make Back Panel Connections

The back panel of the G2500 has been designed with ease of installation in mind. Whichever configuration you use, installation will be quick and easy. The first drawing below shows the basic connections. The back panel drawing shows each back panel connector by number. The connection will be referred to by the labeled name and referenced by number in the installation steps below. The procedure for making loop connections begins on page 16.

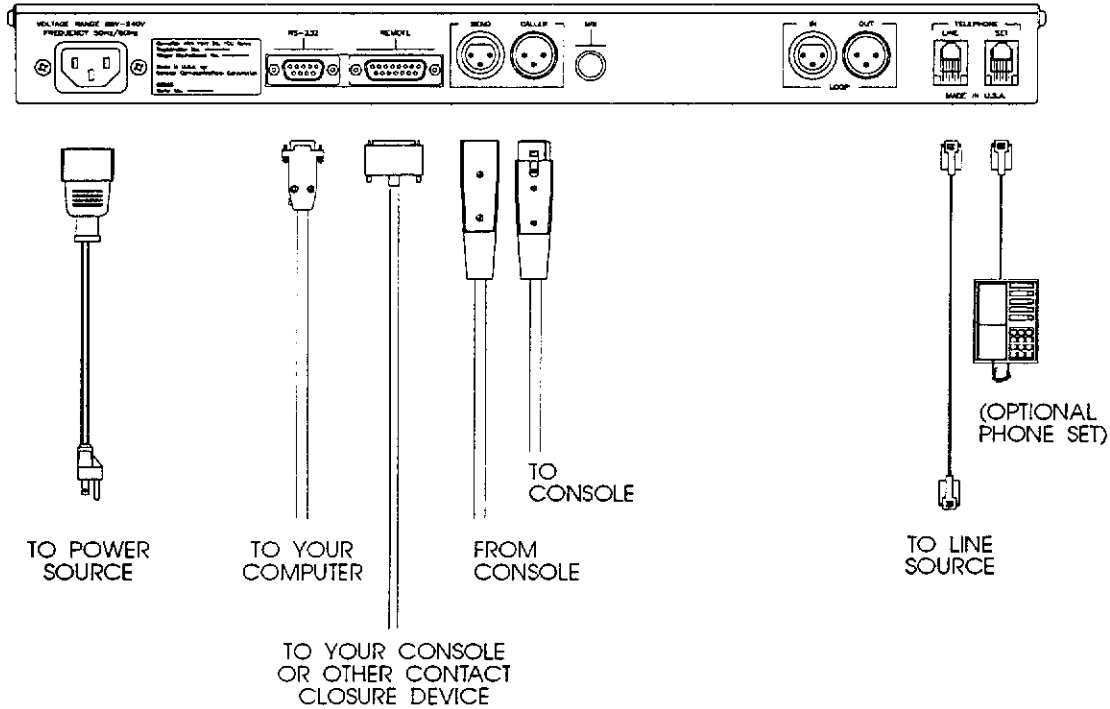

Figure 4

Basic Installation Layout

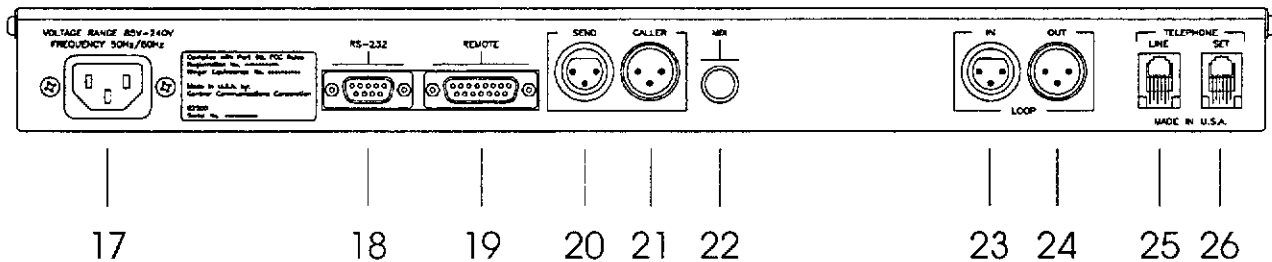

Figure 5

Back Panel Connections

RS-232

The RS-232 serial port (18) is available when you want to control G2500 functions through a computer. This serial port operates at 9600 Baud, no parity, 8 data bits, 1 stop bit. Pin out information is shown below. If your application requires a computer connection, make this connection now.

- Plug a user-supplied DB-9 connector with correct pin out mapping into the RS-232 connector (5) on the G2500 then into an available serial port on your computer.

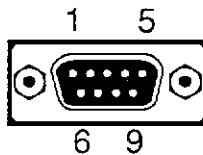

RS-232 DB-9 Pin Outs			
Pin No.	Control	Pin No.	Control
1	DCD	6	DSR
2*	Transmit	7	No connection
3*	Receive	8	CTS
4	DTR	9	No connections
5*	Ground		
*Required Connections			

Complete control details are located as a supplement at the back of this manual following the Schematics.

Remote

A DB-15 socket connector labeled REMOTE (19) is provided on the back panel. Using a contact closure device to ground, you can control MUTE, ON and OFF and their LEDs, from your console.

- A user-supplied remote control should be configured with the following pin outs:

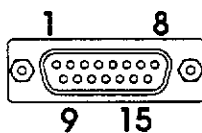

REMOTE DB-15 Pin Outs			
Pin No.	Control	Pin No.	Control
1	Ground	9	Ground
2	On	10	On Lamp
3	Off	11	Off Lamp
4	Mute On/Off	12	Mute Lamp
5	No connection	13	No connection
6	No connection	14	No connection
7	No connection	15	No connection
8	No connection		

- Connect your controller to the DB-15 REMOTE connector (6).

Send

Send (program) audio from your console is fed to the caller through the hybrid. If multiple units are looped together, apply send audio only to the first unit in the chain.

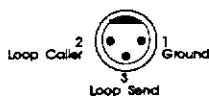

- Refer to “Making Loop Connections” starting on page 16 if you require more detailed connection information. Make connections between the XLR program out connector on your console and the XLR SEND socket connector (20) on the back panel of the G2500.

Caller

This is processed caller audio that will be sent to your console. While the caller can hear program audio through the hybrid Send connection, only Caller audio is returned to the console. The hybrid filters out unwanted noise and echo from the telephone line and sends only crisp, clean audio to the console. If multiple hybrids are used, make the CALLER connection to the last unit in the chain.



- Make connections between the XLR input connector on your console and the XLR CALLER connector (21) on the back panel of the G2500.

Mix

- If your application requires recording calls, insert the plug from your recording device into the MIX jack (22) on the back panel of the G2500.

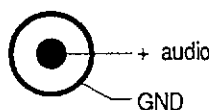

Line

Your G2500 works on standard analog telephone lines and connects to the telephone system with a standard RJ-11C modular jack. If you do not have an RJ-11C jack where you want to install your G2500, call your telephone company for installation.

If you are connecting your Super Hybrid to a private branch exchange (PBX) system, contact your telephone equipment manufacturer or service representative. Some PBX systems will not work with your G2500.

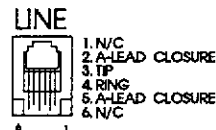

- Connect the telephone line from your source to the RJ-11C LINE jack (25). This must be an analog line.

Set

A single-line telephone set is not required for operation, but can be connected to the RJ-11C SET jack (26), if needed to place outgoing calls.

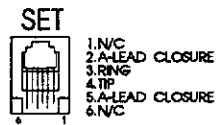

- Connect the telephone set cord to the SET jack.

Power Module

The power receptacle (17) will adapt to any other compatible plug and accommodate any power source in the range between 85 and 240 VAC, 50/60 Hz power.

VOLTAGE RANGE 85V - 240V
FREQUENCY 50Hz / 60Hz

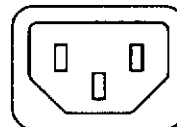

- Connect the supplied power cord between the power module (17) and your power supply.
- If the unit is ON, the front panel ON LED (15) will be lit. Press the OFF button (14) before proceeding.

Making Loop Connections

Internal jumpers or DIP switch change, if required, should have been completed before mounting, making any back panel connections, plugging in power or making loop connections.

There are four methods of operation available when connecting multiple hybrids together. Each requires a slightly different loop connection.

Single Hybrid Operation

Stand Alone Auto Mix-Minus

If you are using only one G2500 Super Hybrid, the hybrid will operate correctly with factory default settings. Proceed directly to "Calibration and Setup" on page 22.

(Jumpers and DIP switches will remain in the factory default setting.)

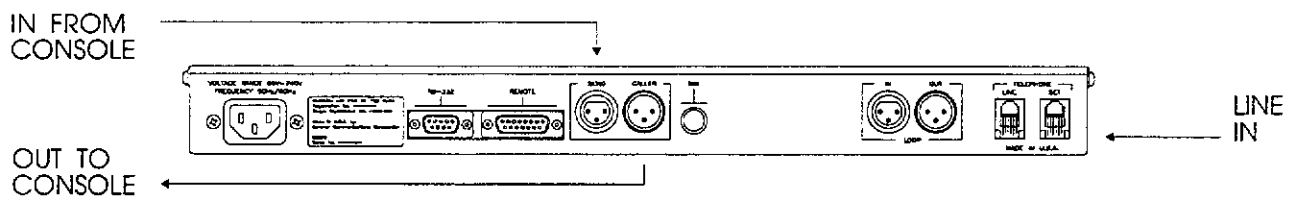

Figure 6

Connections for Single Hybrid Use with Auto Mix-Minus

Multiple Hybrid Interconnection (Four Methods)

Loop/Mix

A Loop In/Out conference bus has been built into each hybrid to allow several callers to be connected together, each using a dedicated Super Hybrid. The hybrids are connected with loop cables (one supplied with each hybrid). All active callers are *automatically* mixed together and presented at the last CALLER output connector of the hybrid that is connected to the console.

The advantage with this mode is that only one SEND connection is made to the first hybrid from the console, and only one CALLER connection is made to the console.

All internal jumpers will remain in the factory default setting. Make loop connections as shown in Figure 7. Proceed directly Calibration and Setup on page 22.

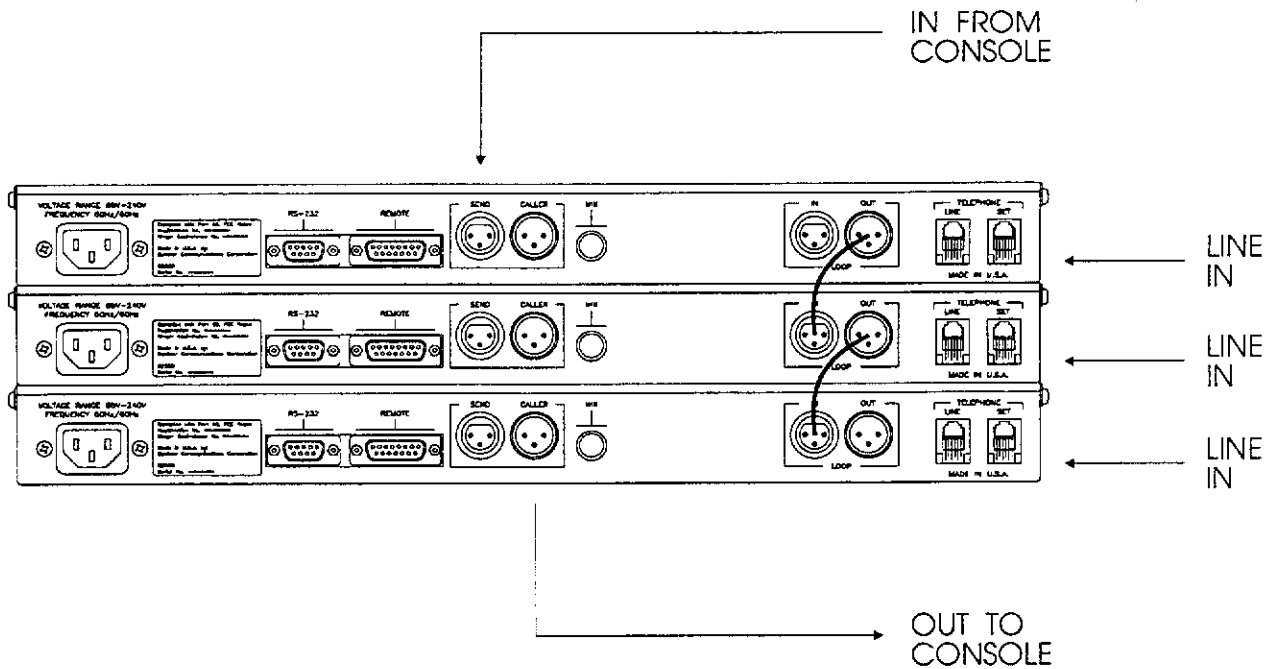

Figure 7

Connections for Multiple Hybrid Interconnection with Caller Audio Mixed

Loop/Separate

All hybrids will be interconnected through the Loop In/Out cable connections, yet callers will be separated. This is accomplished by connecting each CALLER output to a separate pot on the console. Individual level control for each caller will be available in this mode through the console.

The advantage with this mode is that only one SEND connection is made from the console to the first hybrid, then each hybrid CALLER output connects to an individual input pot on the console. Each caller's volume can then be controlled individually from the console.

This application requires a jumper change on all hybrids to be looped together. Jumpers should have been changed to 1-2 and 5. Loop hybrids as shown in Figure 8 below. Proceed to Calibration and Setup on page 22.

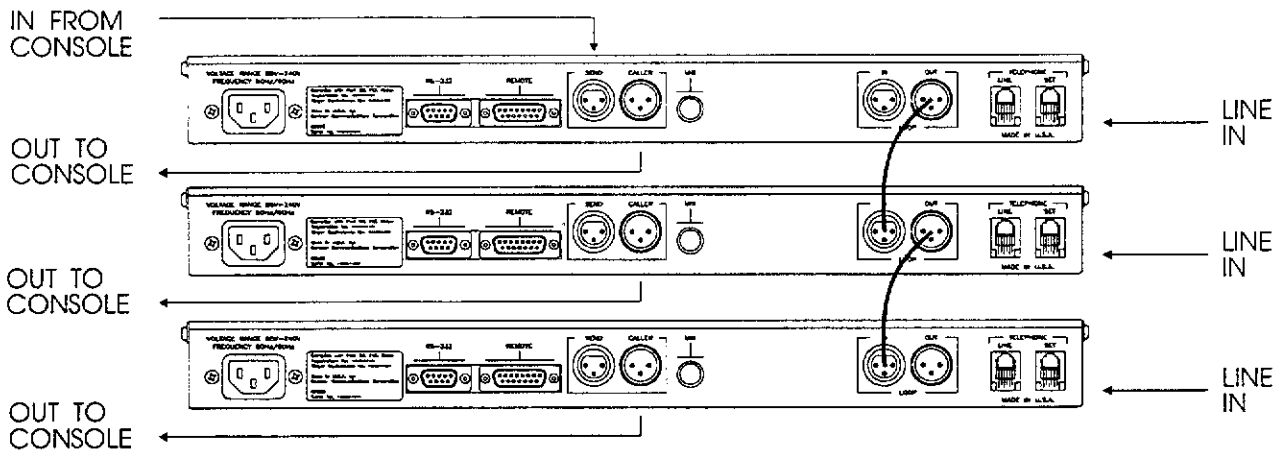

Figure 8

Connections for Multiple Hybrid Interconnection when Separating Caller Audio

VIP Modes

The best way to protect your VIP caller is to place the VIP on a separate hybrid, and configure all other hybrids in either the Loop/Mix or Loop/Separate, mode. If callers are to be mixed, no internal jumper is needed on the looped hybrids. If separating callers is needed, an internal jumper change is required on the hybrids that will be looped together.

The advantage with this mode is that the level adjustment for your VIP can be monitored and adjusted from the console.

VIP Mode #1: Separate VIP hybrid; callers looped together with caller audio mixed. No internal jumpers need to be changed on Caller's hybrids. Change VIP hybrid jumpers to 1-2 and 5 in this mode. Set up hybrids as shown in Figure 9 below. Proceed directly to Calibration and Setup on page 22.

- Loop the caller's hybrids as shown with last hybrid connecting to the console.
- The VIP hybrid must be the last hybrid in the connected chain. Connect the VIP hybrid directly to the console.

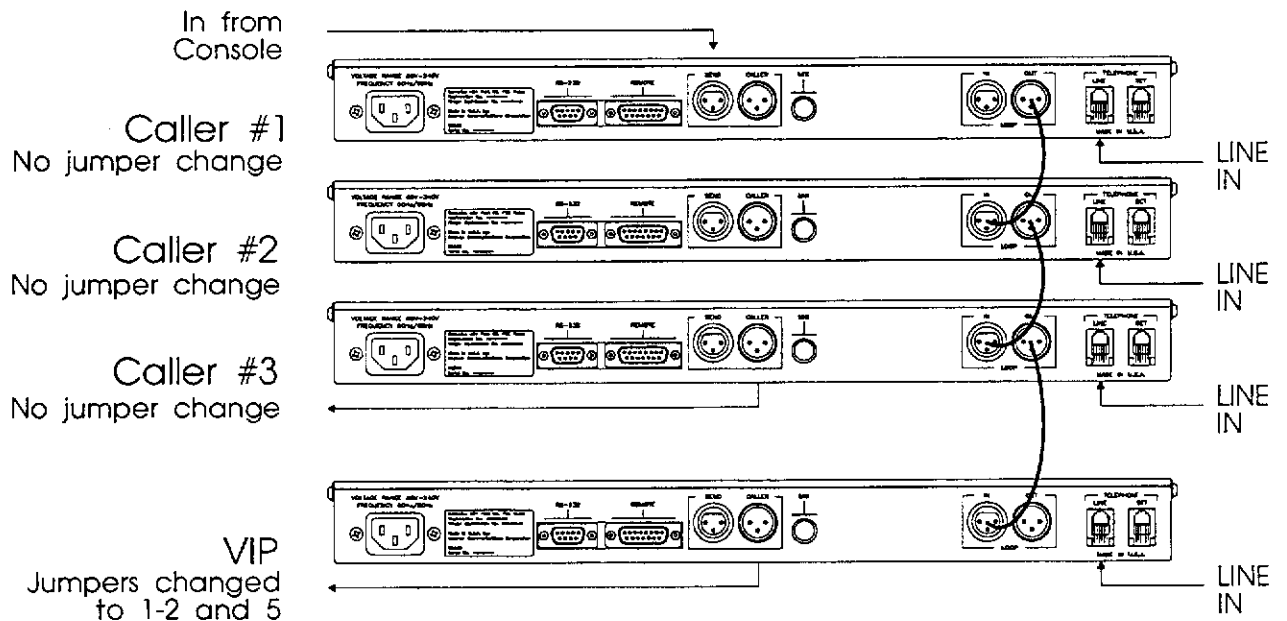

Figure 9

Loop Connections when Operating in LOOP/MIX Mode

VIP mode 2#: Separate VIP hybrid; caller's hybrids looped together with caller audio separated.

Internal jumpers must be set to 1-2 and 5 on all units. Loop the caller's hybrids as shown in Figure 10 below.

- Connect the VIP hybrid directly to the console.
- Loop the callers' hybrids as shown and connect each Caller output to the console.
- Proceed directly to Calibration and Setup on page 22.

This mode requires a jumper change on all units to 1-2 and 5

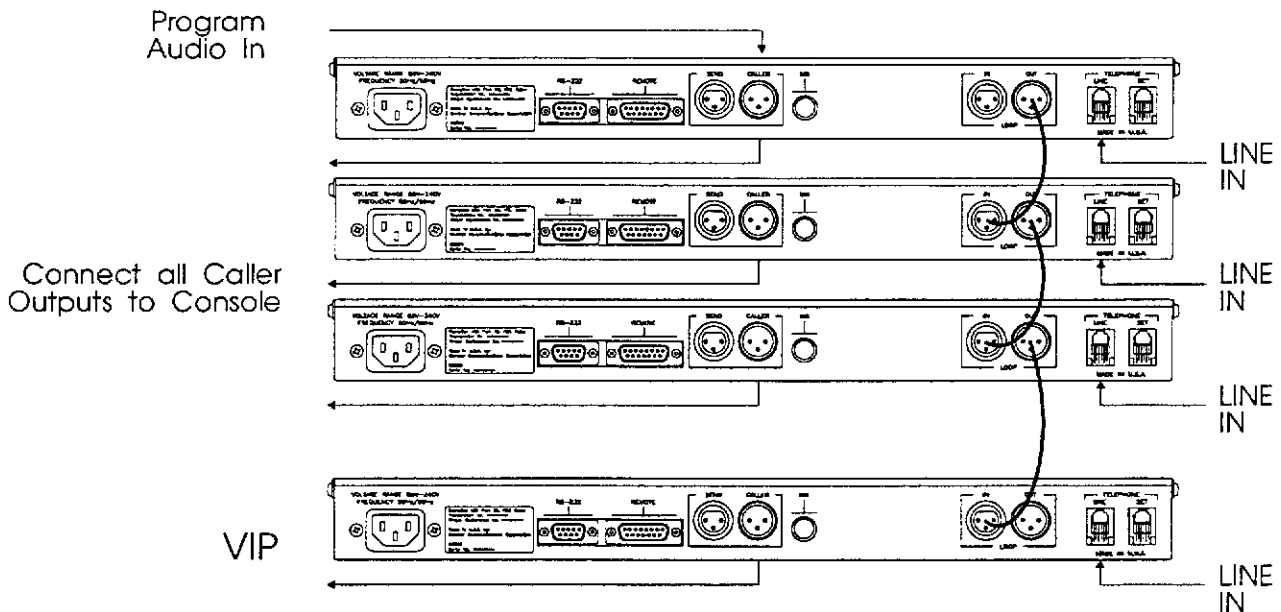

Figure 10

Configuration when operating in VIP Mode #2

Meet-Me Bridge

For Meet-Me Bridge operation with up to eight callers' audio mixed, you must have mix-minus from your console.

The advantage with this mode is that callers can each dial in from separate locations at an assigned time, and hang up independently when needed, while still maintaining excellent audio quality for all participants during the conference.

An internal jumper change must be set on 3-4 and 6 on each hybrid to enable this mode. Hybrids will be interconnected through loop cable connections as shown in Figure 11 below.

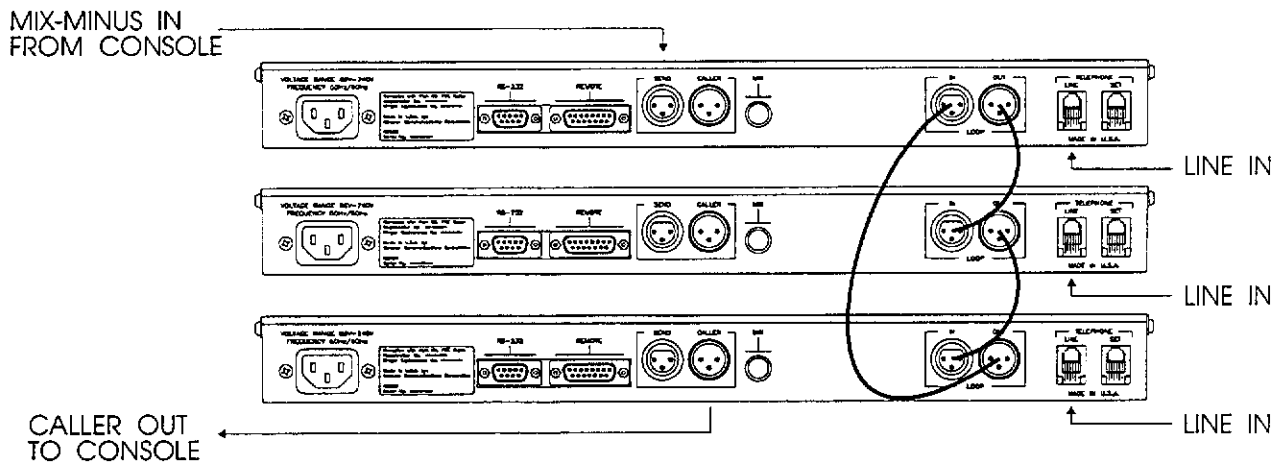

Figure 11

Configuration when operating a Meet-Me Bridge

Calibration and Setup

The following information will help you decide what settings to make in order to optimize your system performance. The Front Panel drawing below shows each LED, level adjustment pot, switch and button by number, for easy identification, as needed.

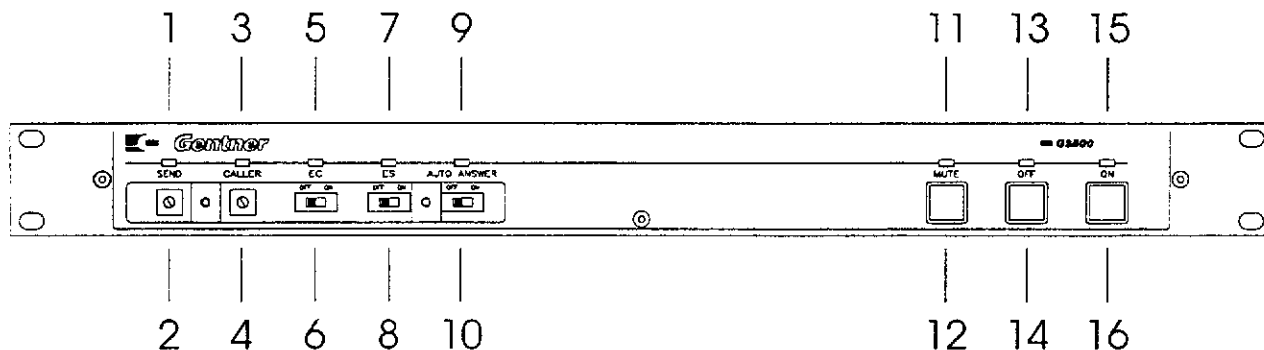

Figure 12

Front Panel Controls

- Verify that installation steps are complete and that connections for your operation are made as shown in the connection diagrams on pages 12 through 21.
- Make certain proper power is supplied to the G2500 and that the unit is OFF. The red OFF LED will be lit. (If the green ON LED [15] is lit, press the OFF button [14].)

NOTE: Some echo and ringing may be heard while calibrating the G2500. Disregard it and continue with calibration until the end of the procedure. The echo and ringing will disappear.

Check Default Settings

- The SEND (2) and CALLER (4) adjustment pots should be in the 12:00 position.

If using the hybrid's auto mix-minus:

- The EC slide switch (6) should be ON. Its LED (5) will be lit green.
- The ES slide switch (8) should be ON. Its LED (7) will be ON.

If *not* using the hybrid's auto mix-minus, EC and ES switches (6 and 8) must both be off.

- The AUTO-ANSWER/DISCONNECT switch (10) can be either on or off. If on, the LED (9) will glow green. If off, the LED will glow red.
- MUTE (12) should be off. Its LED (11) will not be lit.

Set Levels

Due to the various operating modes (single hybrid, multiple hybrids with callers mixed, multiple hybrids with callers separated, and meet me bridge) level settings will need to be preset as follows:

Single hybrid use: Set both the SEND and CALLER levels (2 and 3) at the 12:00 position.

Multiple hybrids with callers mixed: Set the *first* hybrid's SEND (2) level at 12:00, and all other SEND pots full off (counter-clockwise). Set the *last* CALLER (3) level at 12:00 and all other CALLER pots full off (counter-clockwise).

Multiple hybrids with callers separate: Set the *first* hybrid's SEND (2) level at 12:00, and all other SEND pots full off (counter-clockwise). Set *all* CALLER (3) pots to 12:00. (Each CALLER output is connected directly to the console.)

Meet Me Bridge: All SEND and CALLER (2 and 3) levels should be set at 12:00.

Begin Calibration

- From another location, have someone call the hybrid (*first* hybrid if interconnecting multiple hybrid units). Answer the line by pressing the ON button. (If Auto-Answer/Disconnect is ON, the unit will answer the call after one ring.)
- The caller will hear a short white noise burst and a short beep. This adapts the hybrid to the telephone line.
- As the caller talks, adjust only the active CALLER pot(s) (3) identified above, and/or your mixing board for a correct level going into your board.

NOTE: The caller pot comes after the caller LED and thus has no effect on activity of the CALLER LED (3). The CALLER LED indicates actual level on the phone line.

- Send program audio. Adjust your console or active SEND pot(s) (2) so that the SEND LED (1) is green. Occasional red peaks are OK. (If you are *not* using auto mix-minus, skip the next two steps.)
- Continue with this step only if you *are* using auto mix-minus: Watch the SEND LED (1) as the caller speaks. If the LED is peaking red frequently or peaks red before the CALLER LED (3), turn the SEND pot (2) down. The SEND LED comes after the SEND pot and should seldom turn red when the caller speaks.

- Continue with this step only if you *are* using auto mix-minus: After several calls have been made and the AMM has had a chance to adapt to the console environment, the ES switch (8) may be turned off.

Setup Routine

A setup routine, either adapting or electronic, is required.

Adapting

Continue making or taking calls while the system adapts over time. This setup routine takes up to 20 minutes for the system to adapt to its optimum level while the caller speaks. You will notice that the EC LED (5) rarely flashes red once the system has adapted properly. Then, turn the ES switch (6) off. The ES switch will then remain off under normal operating conditions.

Electronic

The electronic method takes only a few seconds, while a white noise burst is transmitted. This method may be objectionable if the hybrids are being used on air during setup.

- Make sure the audio paths and levels from the G2500 are set to normal on air operation.
- Call the hybrid and answer the phone.
- Press and continue to hold the MUTE button (12) and press the OFF button (14) momentarily then release both buttons. A white noise burst will be transmitted for 20 seconds or less through the Caller Output.
- During the white noise burst, if the SEND LED (1) is red, turn down the SEND trim pot (2).

This forces the AMM to quickly adapt to the console environment. Once complete, the G2500 Super Hybrid will be fully calibrated and ready for use.

- Conclude your conversation and press the OFF button (13). (If Auto-Answer/Disconnect is ON, the hybrid will disconnect the call upon sensing loop drop.)

After a Power Failure

Switches will remain in the position prior to the outage. A complete setup routine must be completed.

Footnote

The ES switch (8) should be in the OFF position for normal operation. If you turn it on, the echo suppression on program audio will be activated resulting in an 18 dB ducking of the program to the caller when the caller speaks.

Operation

Front Panel Controls

Easy-to-access and read front panel controls make operation of the G2500 simple to control and adjust. The front panel drawing below shows each front panel LED, switch and button by number. Each is described in detail by number, below.

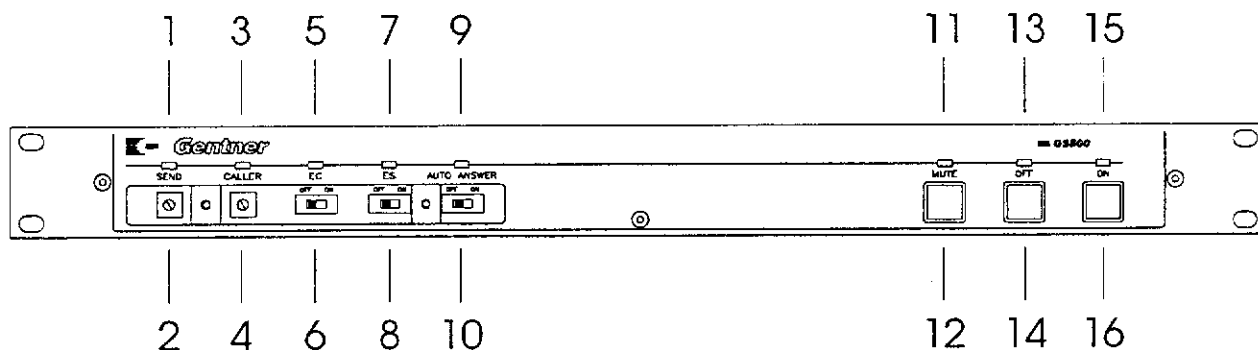

Figure 13

G2500 Front Panel Controls and Indicators

Answering a Call

Auto-Answer mode off: An incoming call will ring on the telephone set. The Auto-Answer LED (9) will flash rapidly during each ring. Answer the call by pressing the ON button (16) on either the front panel or from your remote controller to place the call into the hybrid. The green ON LED (15) will light. The red OFF LED (17) will turn off. Upon connection, the hybrid automatically renulls.

Or, if you want to talk off air, you can answer the call by picking up the telephone handset and talking to your party over the telephone. You should not turn the hybrid on. Your call will not be handled by the hybrid.

Auto-Answer mode on: If the hybrid is on and the Auto-Answer/Disconnect switch (10) is on, the call will be automatically answered after one complete ring. The call will be handled by the hybrid. Caller audio to the console can be muted by pressing the MUTE button (12).

Making a Call

Off air: The hybrid should be off. Using your telephone set, dial the phone number of the party you wish to call. Conduct your call as you normally would and hang up the handset when finished.

On air: After the other party has answered, to put the call on air, press the ON button (29). The ON indicator (28) will light. The G2500 takes control of the call and disables the telephone set. You may hang up the handset without disconnecting your call. When the conversation is complete, press the OFF button (14) to disconnect the call.

Disconnecting a Call

If the call is routed through the hybrid, press the OFF button (16). The OFF LED (15) will turn on, and the ON indicator will extinguish.

If your call is through the handset only, hang up when the conversation is complete.

Auto-Answer/ Disconnect Mode

To put the G2500 in Auto-Answer mode, move the AUTO-ANSWER slide switch (10) to the ON position. (Its green LED (9) will light.)

In the Auto-Answer mode, the G2500 will automatically answer telephone calls after one complete ring. Upon answering, the red OFF LED (13) will extinguish and the green ON LED (15) will light. Your call will be routed through the hybrid and its connection to the console.

When the call is terminated, the hybrid will sense loop drop and automatically turn the hybrid off, extinguishing the green ON LED (15), and lighting the red OFF LED (13).

NOTE: This mode may not work, as described, with some PBX systems. The difficulty with the auto-answer mode may be caused by ring timing. Problems with auto-disconnect may be caused by lack of loop drop or loop reversal. Contact your telephone company for information on providing the proper signaling.

Terminate Auto- Answer/Disconnect Mode

Move the slide switch to OFF (10). The green indicator light (9) will extinguish and the red OFF LED (13) will light.

Mute Caller Audio

While on an active call, press the the MUTE button (11). This mutes only the caller audio to the console, and does not disconnect the call. Program audio will still be sent to the caller.

When the hybrid is turned off, the Mute function defaults to off.

Remote Control

A user-supplied remote control or contact closure switch can be used to perform three functions; mute on/off, system on, system off, and their associated indicator LEDs.

If using a remote control device, an internal DIP switch #3 will select a momentary or latching ON closure. See the DIP Switch chart on page 11.

Recording Calls Your tape recording device must be connected to the MIX connector (22) on the back panel. While on a connected call, the mix of both SEND and RECEIVE audio will be routed to the mix connector. Turn on your recording device and set to the Record mode. Turn the tape recorder off when the call is finished.

NOTE: This mix is not broadcast audio quality, and is to be used for reference only. To record broadcast audio quality, you must supply a mix from your console to your recording device.

When Not in Use The G2500 will be off with the OFF red LED (13) lit.

If the Auto-Answer/Disconnect switch (10) is off, the red OFF LED (13) will be lit.

If the Auto-Answer/Disconnect switch (10) is on, its LED (9) will be lit green.

Emergency Restoration Following a power failure or disconnection of power, a setup routine will need to be activated on each hybrid to achieve optimum performance of your hybrid. (See "Setup Routine" on page 24.)

The telephone call will need to be redialed.

As long as power is maintained to the hybrid, all settings will remain as described above

Performing an Analog Null Perform an analog null if you notice the digital null is not performing well (i.e., the announcer has a hollow sound when speaking with someone over the telephone line). Performing an analog null will more closely match the hybrid circuit to your telephone line.

WARNING! Only a qualified technician should perform this procedure. An exposed power supply is accessible immediately when removing the chassis cover. This procedure requires maintaining power to the system while making the null adjustment. Take all precautions necessary to prevent touching the power supply. Severe shock could result if the power supply is touched.

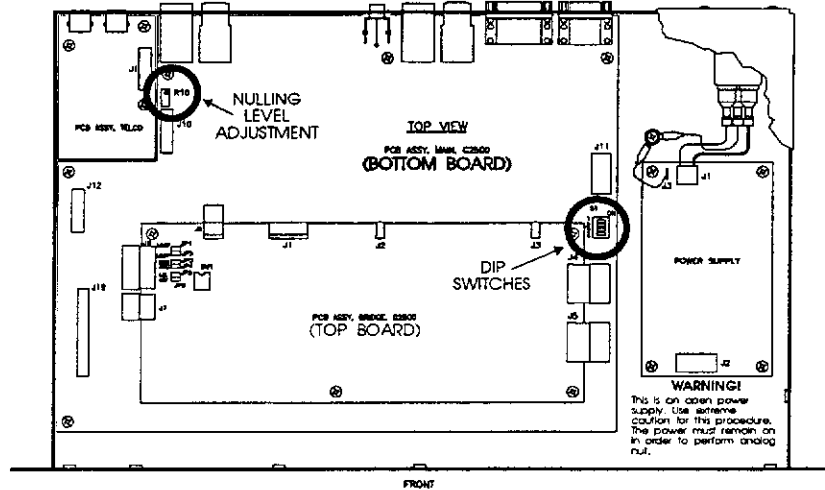

Figure 14

Locating Null Adjustment

- Remove the lid.
- Put DIP switch #2 in the On position. This turns on the internally generated null tone.
- Call the hybrid. When the hybrid connects to the telephone line, the null tone is sent down the phone line.
- Using the meter on your console, monitor the CALLER output. If you are not connected to a console containing a meter, a voltmeter will work.
- Adjust trim pot R10 (locate on the drawing in Figure 14) for a minimum level from the CALLER output.
- Return DIP switch #2 to the OFF position and replace the lid.

Specifications

Physical

Dimensions	19" W x 1.75" H x 10" D (48.3 W x 4.45 H x 25.4 D cm)
Weight	10 lbs. (4.5 kg) dry weight 13 lbs. (5.9 kg) shipping weight

Environment

Operating Temperature	32° to 100° F
Humidity	0 to 80%

Electrical

	Power module auto-adjusting from 85 to 240 VAC 50/60 Hz
Fuse	2 amp Slo Blo type for 250 VAC

Connectors

Power	Auto-adjusting power module
RS-232	DB-9 female serial port 9600 Baud, no parity, 8 data bits, 1 stop bit
Remote	DB-15 female. Inputs active on closure to ground at 20 mA sink current.
Send Input	3-pin female XLR. Balanced bridging audio input. > 20K ohms input impedance at +4 dBu nominal level adjustable
Caller Output	3-pin male XLR. Balanced audio output. 600 ohm output impedance adjustable from 0 dBu to maximum of +20 dBu into 600 ohm termination +4 dBu nominal level.
Conference Loop In	3-pin Female XLR Conference Bus Unbalanced Transmit and Receive audio at 0 dBu operation level
Conference Loop Out	3-pin Male XLR Conference Bus Unbalanced Transmit and Receive audio at 0 dBu operation level
Telco Line/Set	RJ-11C
Record	Phono; 300 Hz to 3300 Hz (not broadcast quality audio)

Electrical/Performance

Power	85 to 240 VAC; 50/60 Hz
Frequency Response	300 Hz to 3.4 Hz; +/- 1 dB with 6 dB pre-emphasis on send
Distortion	>0.1% THD at 1 kHz Telco Line In to Caller Out

Headroom	1% THD at +20 dBu at Caller Output using 1 kHz tone
Noise	>60 dBu at Caller Output
Accessories (provided)	6 ft. power cord 12 ft. telephone cord with RJ-11C jacks on both end 12 in. loop cable containing one male and one female XLR connector Gentner Screwdriver

Specifications are subject to change without notice.

Warranty

GENTNER COMMUNICATIONS CORPORATION (Manufacturer) warrants that this product is free of defects in both materials and workmanship. Should any part of this equipment be defective, Manufacturer agrees, at its option, to:

A. Repair or replace any defective part free of charge (except transportation charges) for a period of one year from the date of the original purchase, provided the owner returns the equipment to the Manufacturer at the address set forth below. No charge will be made for parts or labor during this period;

B. Furnish replacement for any defective parts in the equipment for a period of one year from the date of original purchase. Replacement parts shall be furnished without charge, except labor and transportation.

This Warranty excludes assembled products not manufactured by Manufacturer whether or not they are incorporated in a Manufacturer product or sold under a Manufacturer part or model number.

THIS WARRANTY IS VOID IF:

A. The equipment has been damaged by negligence, accident, act-of-God or mishandling, or has not been operated in accordance with the procedures described in the operating and technical instructions; or,

B. The equipment has been altered or repaired by other than Manufacturer or an authorized service representative of Manufacturer; or,

C. Adaptations or accessories other than those manufactured or provided by Manufacturer have been made or attached to the equipment which, in the determination of Manufacturer, shall have affected the performance, safety or reliability of the equipment; or,

D. The equipment's original serial number has been modified or removed.

NO OTHER WARRANTY, EXPRESS OR IMPLIED, INCLUDING WARRANTY OF MERCHANTABILITY OR FITNESS FOR ANY PARTICULAR USE, APPLIES TO THE EQUIPMENT, nor is any person or company authorized to assume any warranty for Manufacturer or any other liability in connection with the sale of Manufacturer's products.

Manufacturer does not assume any responsibility for consequential damages, expenses or loss of revenue or property, inconvenience or interruption in operation experienced by the customer due to a malfunction in the purchased equipment. No warranty service performed on any product shall extend the applicable warranty period.

In case of unsatisfactory operation, the purchaser shall promptly notify Manufacturer at the address set forth below in writing, giving full particulars as to the defects or unsatisfactory operation. Upon receipt of such notice, Manufacturer will give instructions respecting the shipment of the equipment, or such other matters as it elects to honor this warranty as above provided. This warranty does not cover damage to the equipment during shipping and Manufacturer assumes no responsibility for such damage. All shipping costs shall be paid by customer.

This warranty extends only to the original purchaser and is not assignable or transferable.

Gentner Communications Corporation, 1825 Research Way, Salt Lake City, Utah 84119-2348

Schematics

A complete set of operating schematics is included for reference immediately following this page.

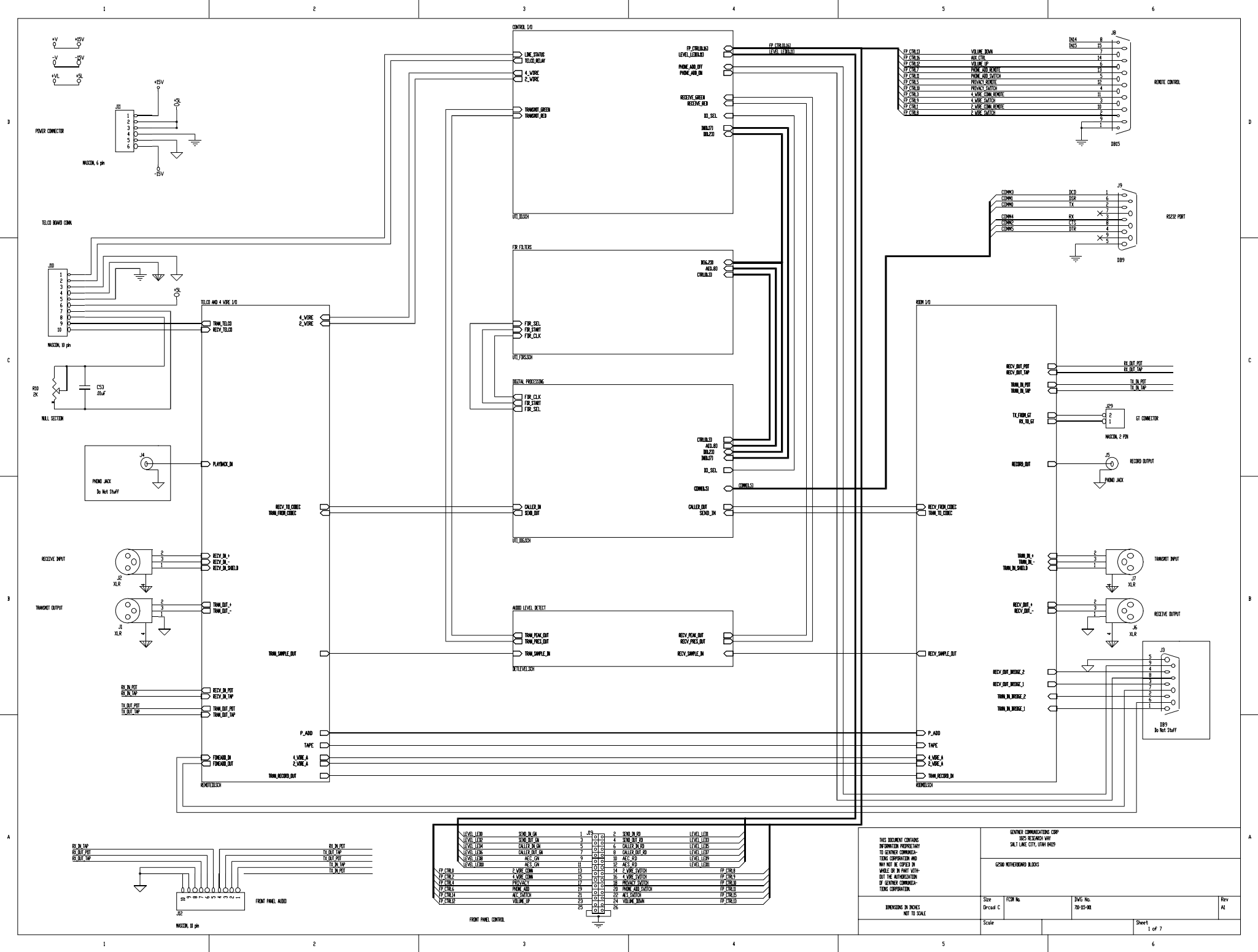

LEVEL LEV1	SEND IN	1	2	SEND IN 2	LEVEL LEV1
LEVEL LEV2	SEND IN 2	3	4	SEND OUT 2	LEVEL LEV2
LEVEL LEV3	CALLER IN	5	6	CALLER IN 2	LEVEL LEV3
LEVEL LEV4	CALLER OUT IN	7	8	CALLER OUT 2	LEVEL LEV4
LEVEL LEV5	REC_ON	9	10	REC_ON 2	LEVEL LEV5
LEVEL LEV6	REC_ON	11	12	REC_ON 2	LEVEL LEV6
FP CTRL1	2 WIRE COMM	13	14	2 WIRE COMM	FP CTRL1
FP CTRL2	4 WIRE COMM	15	16	4 WIRE COMM	FP CTRL2
FP CTRL3	PROVISE	17	18	PROVISE SWITCH	FP CTRL3
FP CTRL4	PRM_ABD	19	20	PRM_ABD SWITCH	FP CTRL4
FP CTRL5	REC_SWITCH	21	22	REC_SWITCH	FP CTRL5
FP CTRL6	VOLUME UP	23	24	VOLUME DOWN	FP CTRL6

THIS DOCUMENT CONTAINS INFORMATION PROPRIETARY TO GEMTER COMMUNICATIONS CORPORATION AND MAY NOT BE COPIED OR WHOLE OR IN PART WITHOUT THE AUTHORIZATION OF GEMTER COMMUNICATIONS CORPORATION.

GEMTER COMMUNICATIONS CORP
1025 S. BROADWAY SW
SALT LAKE CITY, UTAH 84119

CS20 NETWORKING BLOCKS

INCHES IN DIMENSIONS NOT TO SCALE	Size: Dread C	FCM No:	TRM No: 70-15-00	Rev: A1
	Scale:			Sheet: 1 of 7

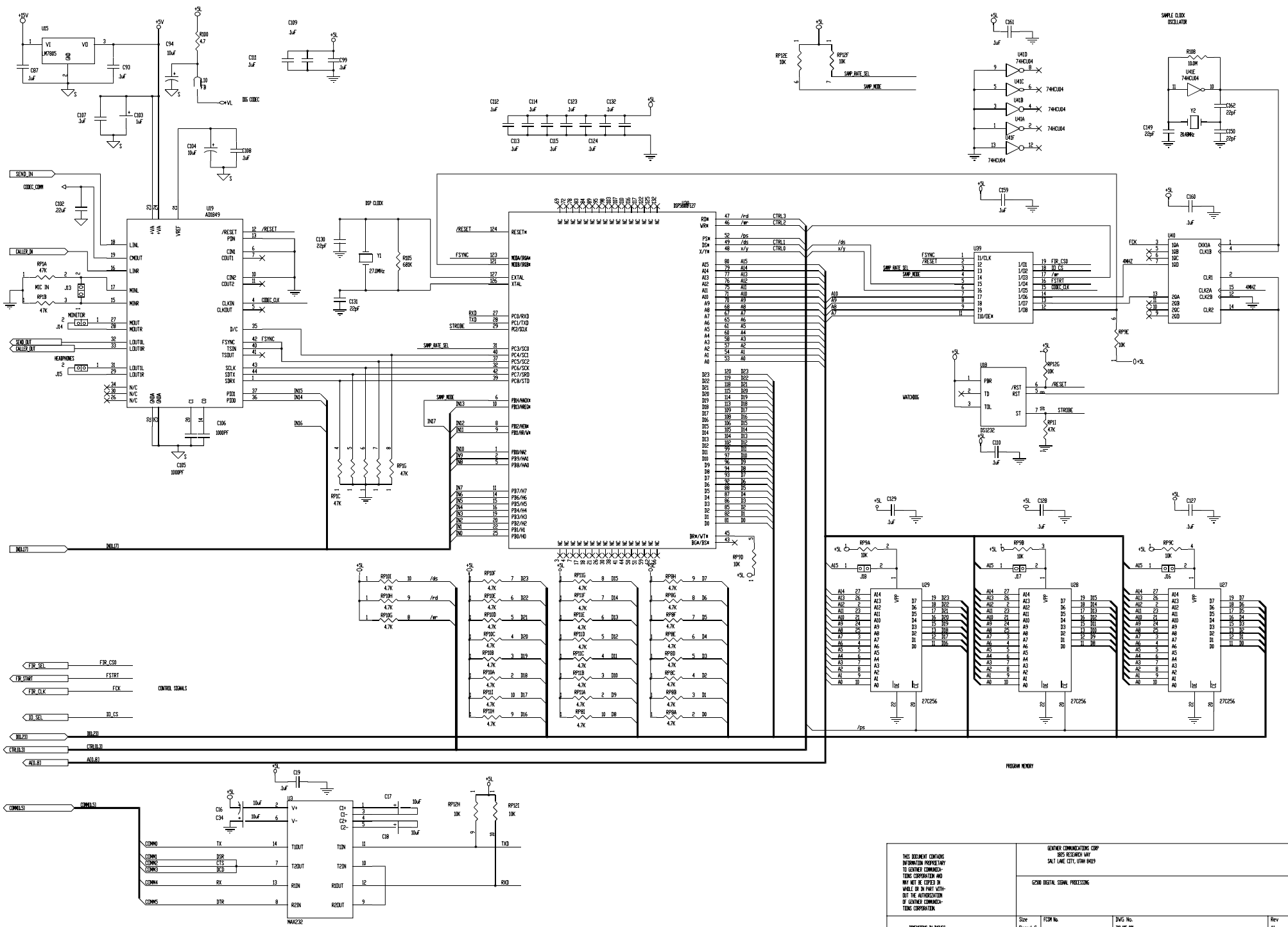

THIS DOCUMENT CONTAINS INFORMATION PROPRIETARY TO GENIEER COMMACH-TENC CORPORATION AND MAY NOT BE COPIED OR MADE UP IN PART WITH-OUT THE AUTHORIZATION OF GENIEER COMMACH-TENC CORPORATION.

GENIEER COMMACH-TENC CORPORATION
825 RESEARCH WAY
SALT LAKE CITY, UTAH 84143

GENIEER COMMACH-TENC CORPORATION

Size: 8 1/2" x 11" (A)
FORM No.: 710-05-001
DWG No.: 710-05-001
Rev: A1

Scale: _____
Sheet: 8 of 7

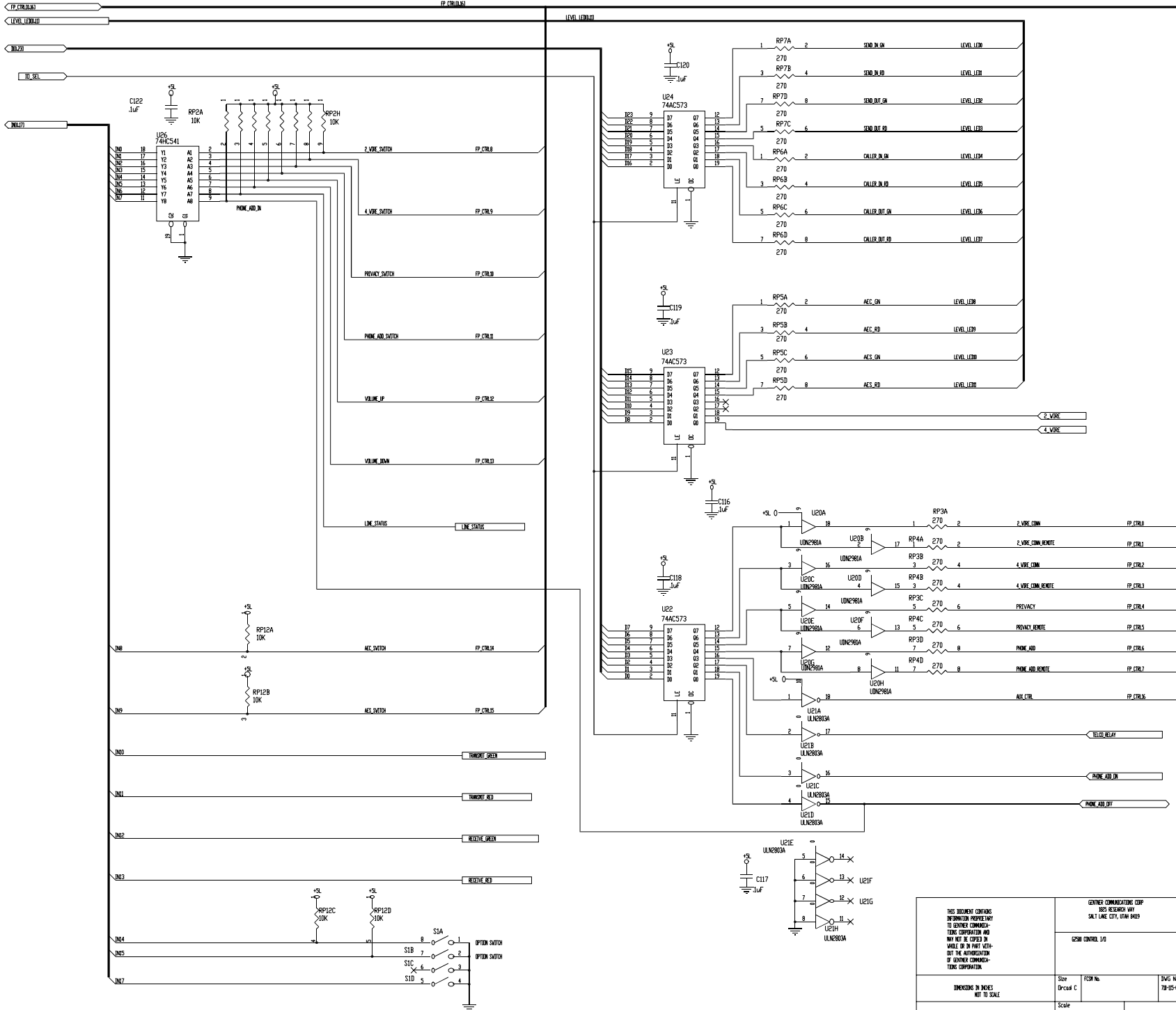

THIS DOCUMENT CONTAINS INFORMATION PROPRIETARY TO GENETEC COMMUNICATIONS CORPORATION AND MAY NOT BE COPIED OR REPRODUCED IN ANY MANNER WITHOUT THE PERMISSION OF GENETEC COMMUNICATIONS CORPORATION.	GENETEC COMMUNICATIONS CORP 1055 BEECHER BLVD SALT LAKE CITY, UTAH 84119			
	SCRM CONTROL I/O			
DIMENSIONS IN INCHES NOT TO SCALE	Size	FORM No.	SPEC. No.	Rev.
	Dread C		78-115-01	AL
Scale			Sheet	6 of 7

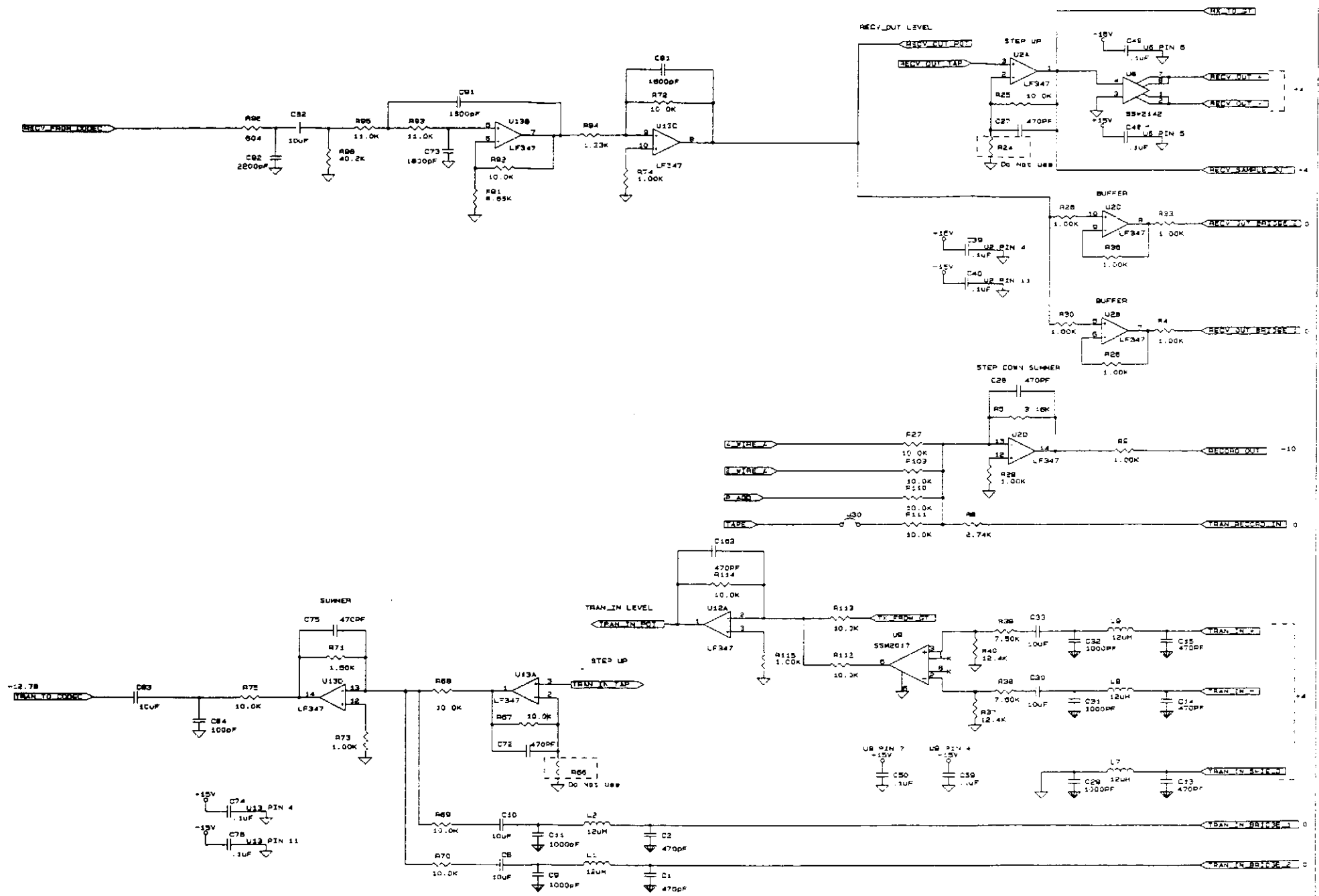

THIS DOCUMENT CONTAINS INFORMATION PROPRIETARY TO GENTHER COMMUNICATIONS CORPORATION AND MAY NOT BE COPIED IN WHOLE OR IN PART WITHOUT THE AUTHORIZATION OF GENTHER COMMUNICATIONS CORPORATION.

GENTHER COMMUNICATIONS CORP
1824 RESEARCH WAY
SALT LAKE CITY, UTAH 84119

62800 ROGN (1)

DIMENSIONS IN INCHES NOT TO SCALE	SIZE PCHY NO C	QWG NO 710-110-001	REV A1
September 28 1992	SCALE	SHEET	4 OF 7

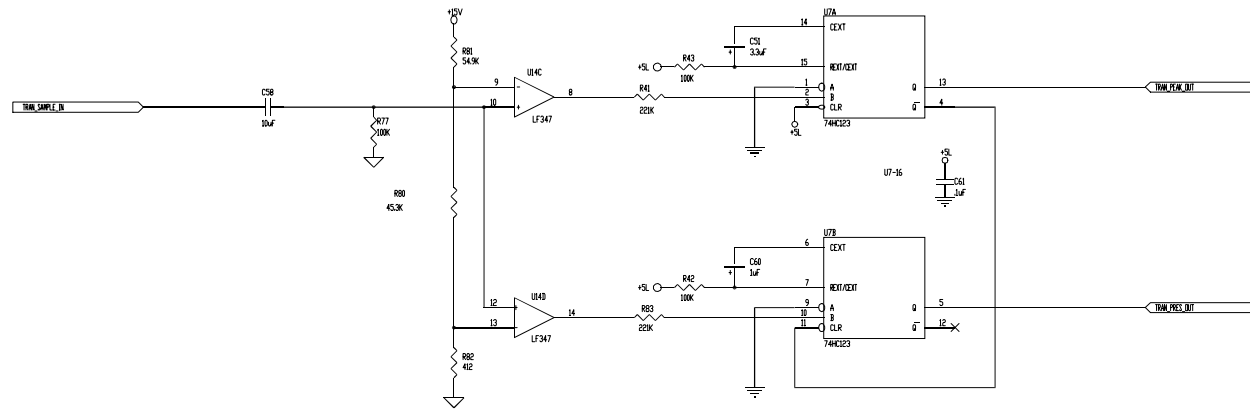
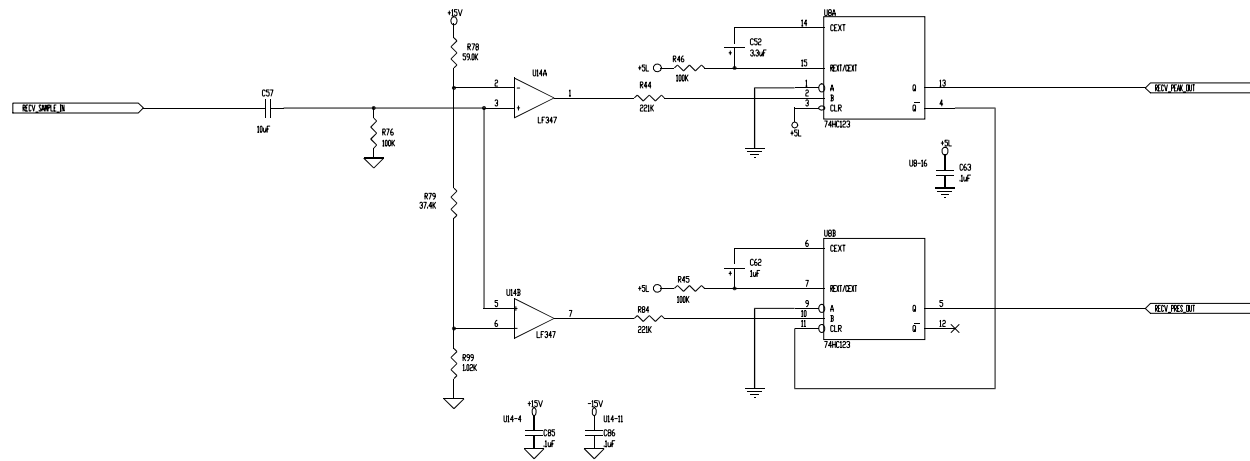

THIS DOCUMENT CONTAINS INFORMATION PROPRIETARY TO GENTHER COMMUNICA- TIONS CORPORATION AND MAY NOT BE COPIED IN WHOLE OR IN PART WITH- OUT THE APPROVATION OF GENTHER COMMUNICA- TIONS CORPORATION	GENTHER COMMUNICATIONS CORP 8165 RESEARCH WAY SALT LAKE CITY, UTAH 84143			
	8200 AUDIO OUTPUT LEVEL SELECTOR			
DIMENSIONS IN INCHES NOT TO SCALE	Size	FORM No.	DWG No.	Rev
	Dr-csd C		78-105-00	A1
Scale			Sheet	5 of 7

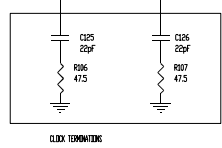
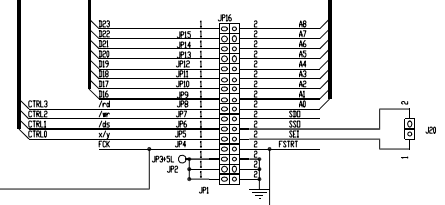
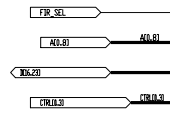
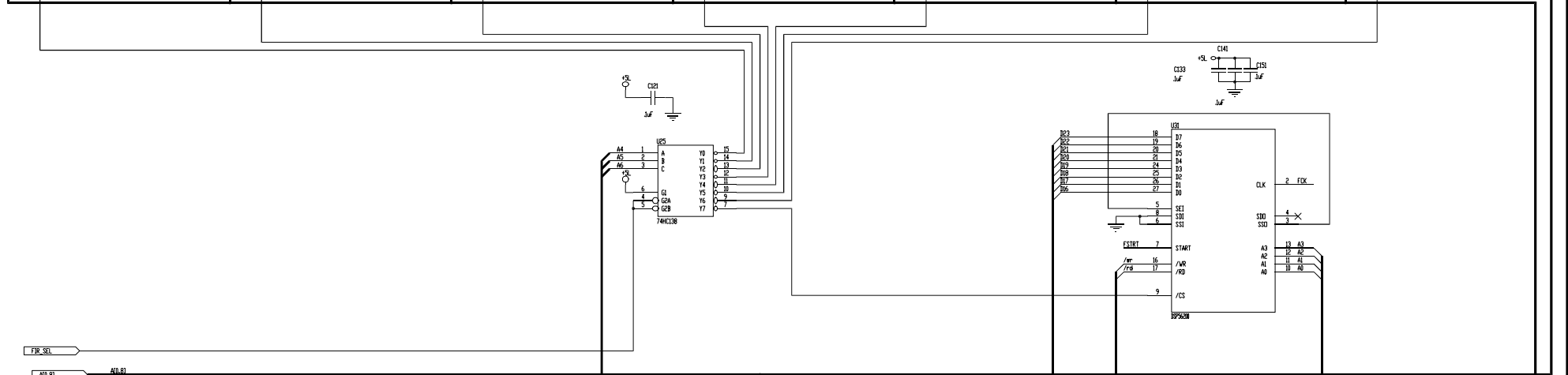
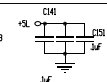
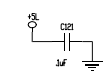
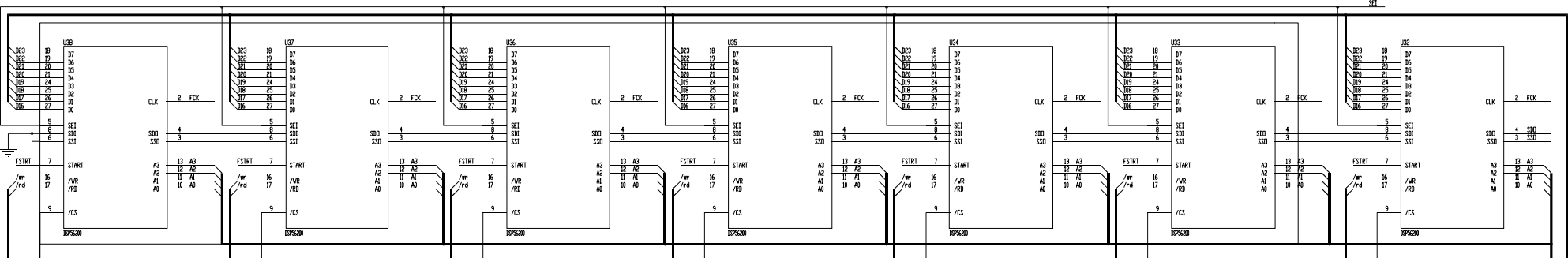
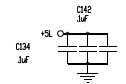
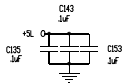
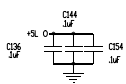
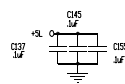
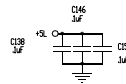
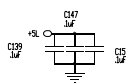
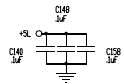

THIS DOCUMENT CONTAINS INFORMATION PROPRIETARY TO EXHIBIT COMMUNICATIONS CORPORATION AND MAY NOT BE COPIED, REPRODUCED, OR TRANSMITTED IN ANY FORM OR BY ANY MEANS WITHOUT THE WRITTEN PERMISSION OF EXHIBIT COMMUNICATIONS CORPORATION.		EXHIBIT COMMUNICATIONS CORPORATION 1600 RESEARCH WAY SALT LAKE CITY, UTAH 84143	
©2000 EXHIBIT COMMUNICATIONS CORPORATION		Size: D-cad C	Sheet: 7 of 7
DIMENSIONS IN INCHES NET TO SCALE		FIG. No.	Rev: A1
		Scale	
		DWG. No.: 78-05-01	

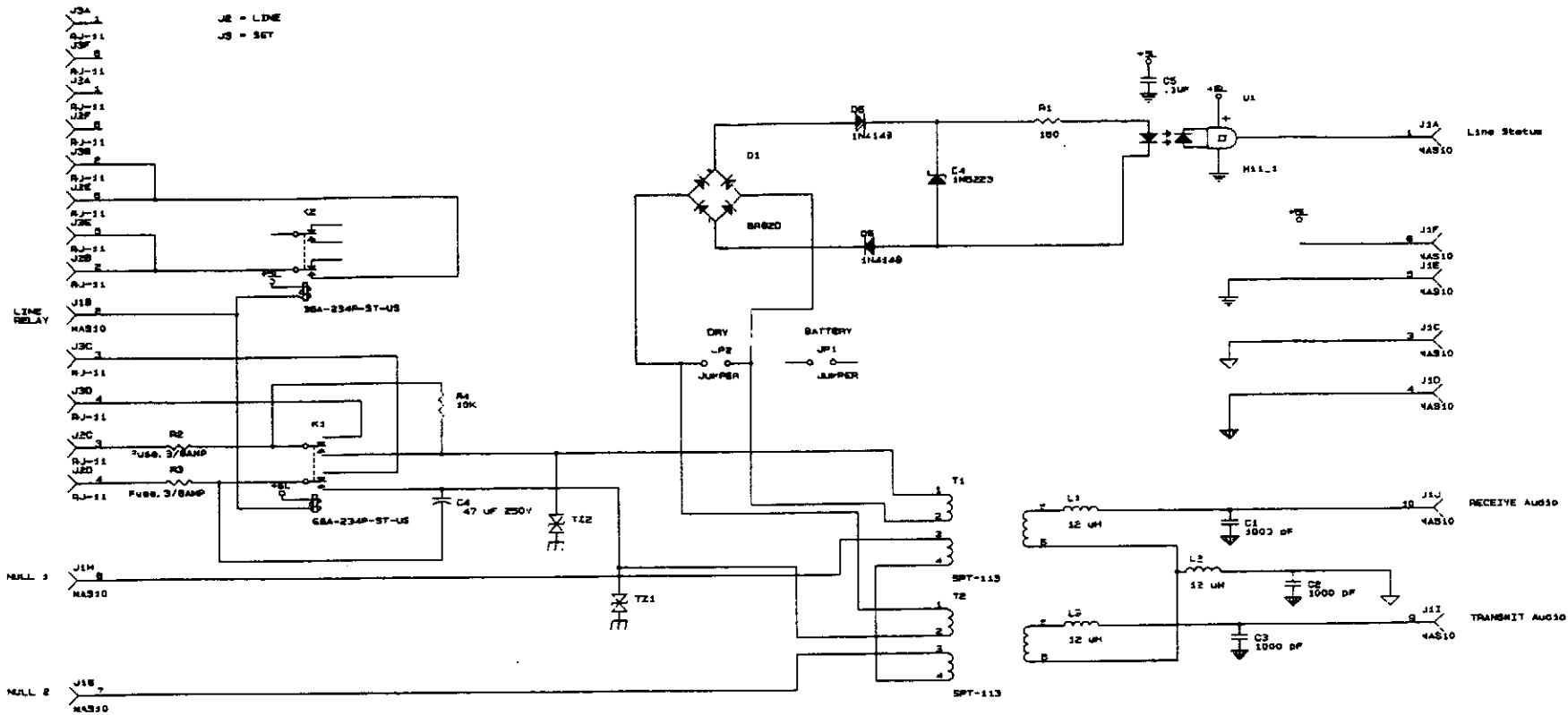

THIS DOCUMENT CONTAINS INFORMATION PROPRIETARY TO GENTHER COMMUNICA- TIONS CORPORATION AND MAY NOT BE COPIED IN WHOLE OR IN PART WITH- OUT THE AUTHORIZATION OF GENTHER COMMUNICA- TIONS CORPORATION.		GENTHER COMMUNICATIONS CORP 1825 RESEARCH WAY SALT LAKE CITY, UTAH 84119 (801) 978-7200		
DIMENSIONS IN INCHES NOT TO SCALE		SIZE FCBN NO C	DWG NO 710-100-002	REV A3
APR 11 24, 1983		SCALE	SHEET	6 OF 7

B 7 6 5 4 3 2 1

REV	LTN.	DESCRIPTION	DATE	APP'D
ALL	A1	PRODUCTION RELEASE	8/88	

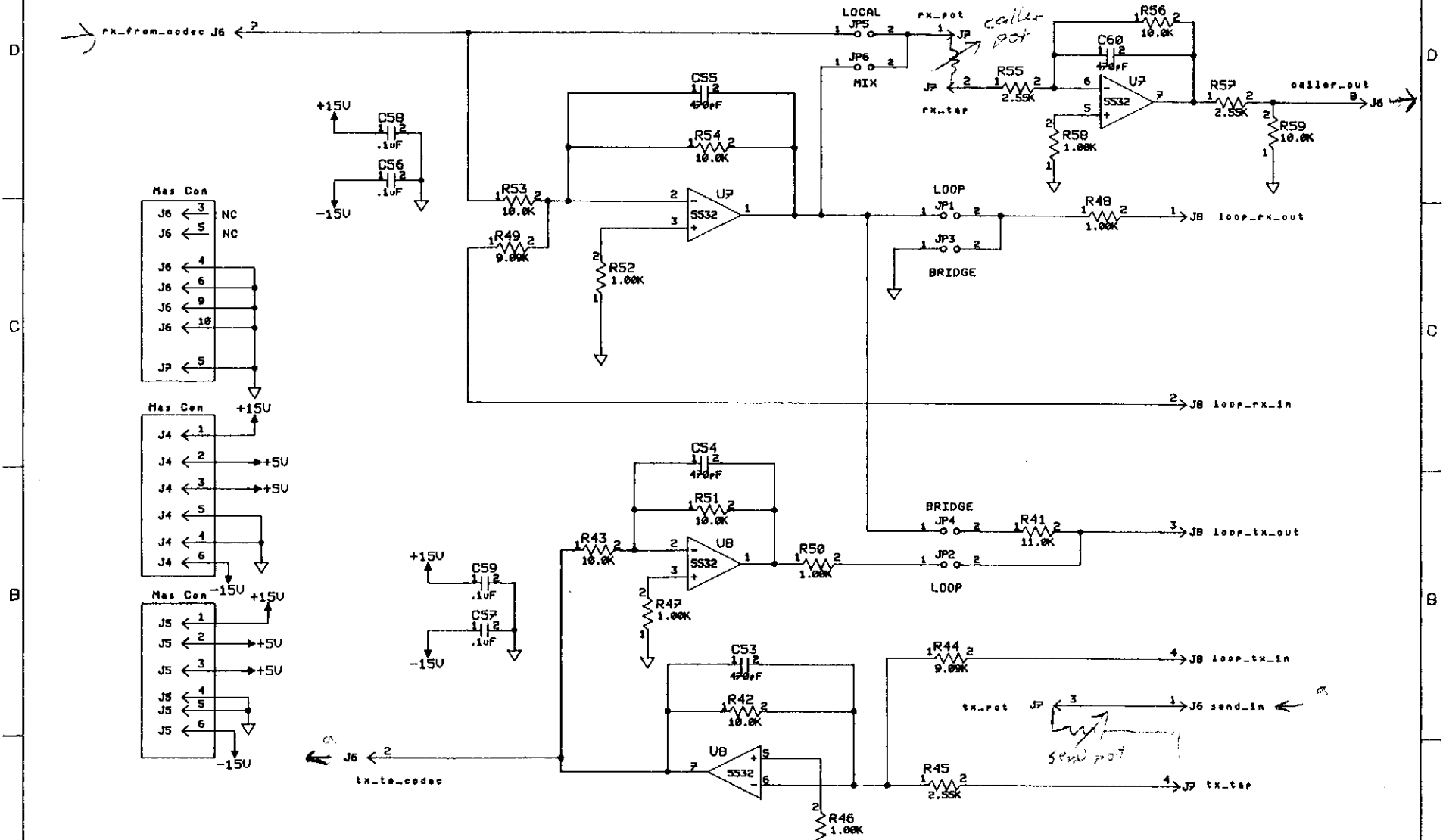

NOTES: UNLESS OTHERWISE SPECIFIED:
 1. RESISTANCE VALUES ARE EXPRESSED IN OHMS, "K" DENOTES 1000 OHMS.
 CAPACITANCE VALUES ARE EXPRESSED IN MICRO FARADS, (UF).
 INDUCTOR VALUES ARE EXPRESSED IN MICRO HENRIES, (UH).

2. STANDARD GROUND SYMBOLS:

- ⏏ DIGITAL GND
- ▽ ANALOG GND
- ⏏ R.F.I. GND
- ⏏ SPECIAL GND

THIS DOCUMENT CONTAINS INFORMATION RELATIVE TO UNITED STATES PATENT APPLICATIONS AND MAY NOT BE COPIED OR RELEASED IN ANY MANNER WITHOUT THE WRITTEN PERMISSION OF THE GOVERNMENT.	DESIGN	S.P.M.	DATE	8/88	GENTNER 1825 Research Way, SLC, UT. 84119	
	DESIGNED		DATE			TITLE
	APPROVED		DATE	06/22/81		G2500 BRIDGE
DIMENSIONS IN INCHES DO NOT SCALE		PROJECTION			ELECTRICAL SCHEMATIC	
TOLERANCES .10 - .008 .008 - .010 $\angle^{\circ} = 25^{\circ}$		SHEET 1 OF 1		DOC. NO.	710-115-003	
					REV.	A1

B 7 6 5 4 3 2 1

8 7 6 5 4 3 2 1

REV	DATE	DESCRIPTION	APPROVED
ALL	8/21/88	PRODUCTION RELEASE	

J2	
SEND_IN_GN	1
VOLUME+_GN	3
VOLUME-_GN	5
CALLER_OUT_GN	7
AEC_GN	9
AES_GN	11
DN_LED	13
OFF_LED	15
MUTE_LED	17
SEND_IN_RD	2
VOLUME+_RD	4
VOLUME-_RD	6
CALLER_OUT_RD	8
AEC_RD	10
AES_RD	12
	14
	16
	18
	20
	22
	24
	26

SEND INPUT LED

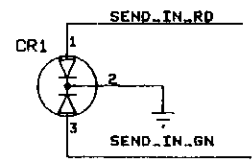

CALLER OUTPUT LED

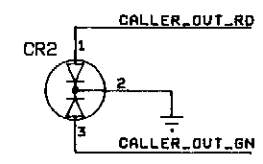

ECHO CANCELLER LED

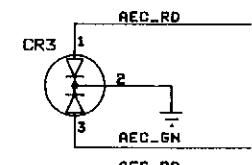

ECHO SUPPRESSOR LED

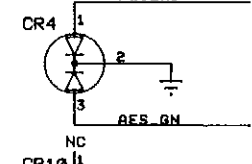

ON

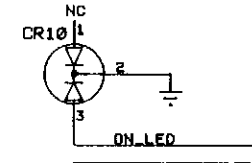

OFF

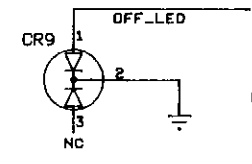

AUTO ANSWER LED

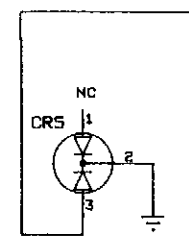

ECHO CANCELLER SWITCH

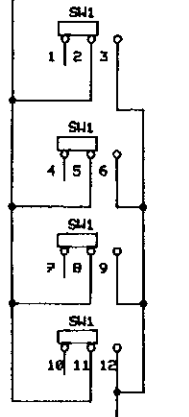

MUTE

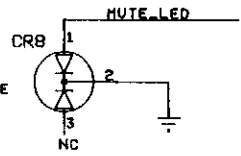

ECHO SUPPRESSOR SWITCH

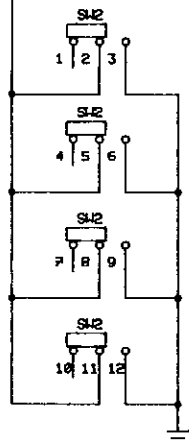

AUTO ANSWER SWITCH

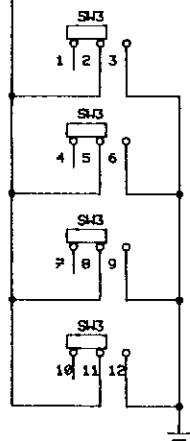

VOLUME DOWN

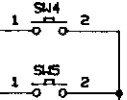

VOLUME UP

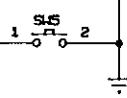

SEND LEVEL

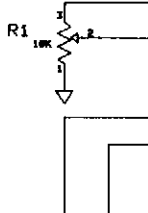

CALLER LEVEL

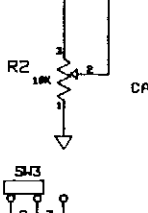

SPIN MASCON

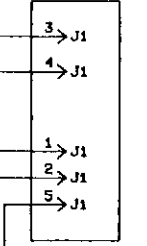

NOTES: UNLESS OTHERWISE SPECIFIED:
 1. RESISTANCE VALUES ARE EXPRESSED IN OHMS, "K" DENOTES 1000 OHMS.
 CAPACITANCE VALUES ARE EXPRESSED IN MICRO FARADS, (UF).
 INDUCTOR VALUES ARE EXPRESSED IN MICRO HENRIES, (UH).

2. STANDARD GROUND SYMBOLS:
 DIGITAL GND
 ANALOG GND
 R.F.I. GND
 SPECIAL GND

THIS DOCUMENT CONTAINS INFORMATION PROPRIETARY TO GENTNER COMMUNICATIONS CORPORATION AND MAY NOT BE COPIED IN WHOLE OR IN PART WITHOUT THE AUTHORIZATION OF GENTNER COMMUNICATIONS CORPORATION.	DESIGN	DATE	GENTNER 1825 Research Way, SLC, UT. 84119
	S.P.M.	08/18/88	
	CHECKED	DATE	
DIMENSIONS IN INCHES DO NOT SCALE	APPROVED	DATE	TITLE
TOLERANCES .XX = ±.05 .XXX = ±.010 ∠° = 25°	PROJECTION		G2500 FRONT PANEL ELECTRICAL SCHEMATIC
SHEET 1 OF 1		DOC. NO.	REV.
		710-115-002	A1

8 7 6 5 4 3 2 1

RS-232 SUPPLEMENT

Serial Port Commands

The RS-232 Serial port will accept serial commands. The commands provide the same control as the front panel buttons: ON, OFF, MUTE; and will activate their respective LEDs.

When the serial port is connected to a computer, the following information will be displayed on the screen on power-up.

```
G2500 Super Hybrid
Gentner Communications Corporation© 1993

Ports Initialized

G2500 POC v1.0
RAM .....OK
CODEC .....OK
G2500

INTERRUPTS $Revision: 1.0
INTERRUPT SETUP $Revision: x.xx $
BACKGROUND $Revision: x.xx $
G2500 MONITOR $Revision: x.xx $
```

The G2500 is now in the serial command mode. The commands that the G2500 will take in this mode are shown below. These commands are designed to allow users to control the G2500 through the serial port.

The basic structure of the serial commands are one or two letters with a digit following the letters. The two letters identify the command type. The digit or lack of a digit tells the G2500 what to do with the current command.

The following table contains the commands that the G2500 accepts through its serial port:

Telephone	TE
Mute	P
Setup	S

NOTE: The <cr> means a "carriage return". Do not include the "less than" and "greater than" characters. The string <cr> means the single character for a carriage return.

Telephone

The TE command has the same function as the ON button. It connects or disconnects the G2500.

TE1<cr>

connects the G2500.

The G2500 responds with TE0<cr>

if not connected or TE1<cr>

if it is connected

TE0<cr>

disconnects the G2500.

The G2500 responds with TE0<cr>

TE<cr>

returns the on/off connect state.

The G2500 responds with TE0<cr>

if not connected or TE1<cr>

if connected

Mute

The mute mode of the G2500 will only work if the G2500 is connected to the telephone lines (ON mode). To enable mute through the serial port send the following characters:

P1<cr>

enable mute mode.

The G2500 will respond with P1<cr>

P0<cr>

disable mute mode.

The G2500 will respond with P1<cr>

if mute is enabled or P0<cr>

if mute is disabled.

P<cr>

returns the current status of mute.
The G2500 will respond with P1<cr>
if mute is enabled or P0<cr>
if mute is disabled.

Setup

To put the G2500 into setup mode send:

S1<cr>

To put the G2500 into setup mode.
The G2500 responds with S1<cr>
NOTE: The G2500 must be connected (on).

S0<cr>

To take the G2500 out of setup mode.
The G2500 responds with S0<cr>

S<cr>

returns the current status of the setup mode.
The G2500 responds with S1<cr>
if the G2500 is in setup mode or S0<cr>
if it isn't in setup mode.

Status

There is a special command that returns the entire status of the G2500 in one command. The character string for this command is:

ST<cr>

The G2500 responds with all the current status of the G2500.
The status is returned in the following order:
Sx<cr>
Lxx<cr>
Px<cr>
TEx<cr>

Quick Reference

TE<cr>return on/off connect status

TE1<cr>connect

TE0<cr>disconnect

P<cr>return mute status

P1<cr>enable mute

P0<cr>disable mute

S<cr>return current setup status

S1<cr>enable setup

S0<cr>disable setup

ST<cr>return all above status

Pin Out Information

The RS-232 connector is a 9-pin female connector on the rear panel of the G2500. This connector is labeled RS-232 and conforms to the DCE pin out. The pin out of the connector is as follows:

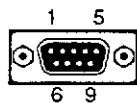

RS-232 DB-9 Pin Outs			
Pin No.	Control	Pin No..	Control
1	DCD	6	DSR
2*	Transmit	7	No connection
3*	Receive	8	CTS
4	DTR	9	No connections
5*	Ground		
*Required Connections			

The G2500 receives data on pin 3 (Transmit Data) and transmits data on pin 2 (Receive Data). Note that all the names of the pins are from the point of view of the DTE (Data Terminal Equipment). If you are trying to send commands to the G2500 from a 9-pin PC serial port, a straight-through cable is needed.