



---

*TeleHybrid*

---

*Installation and  
Operations Manual*

## Copyright Information

© Copyright 1996 Gentner Communications Corporation. All rights reserved. No part of this manual may be reproduced in any form or by any means without written permission from Gentner Communications Corporation. Printed in the United States of America. Original version, 12/95. Gentner Communications Corporation reserves specification privileges. Information in this manual is subject to change without notice.

### **TeleHybrid Installation and Operations Manual**

*Gentner Part No. 800-006-010 (Rev. 2.10)*

*December 1996*

**Manual Development:** Bill Kilpack

**Artwork and Illustrations:** Mike Greenhalgh

This equipment complies with the requirements of the EU guidelines:



89/336/EEC “Electromagnetic Compatibility”

73/23/EEC “Electrical operating material for use within specific voltage limits”

Conformity of the equipment with the above guidelines is attested by the CE mark.



Gentner Communications Corporation is committed to protecting the environment and preserving our natural resources.

This manual has been printed entirely on recycled paper.

Introduction	1
Warranty Registration	1
Unpacking	2
Features and Benefits	3
Before You Install	4
Power Requirements	4
Telephone Line Requirements	4
Telephone Set Requirements	4
Equipment Placement	4
Installation	5
Completed Installation	5
Step 1	5
Step 2	6
Step 3	6
Step 4	7
Step 5 (Record Option)	7
One-Time Setup	7
Step 1 — Slide Control Setup	7
Step 2 — Switch Location	8
Step 3 — Compatibility/Sensitivity Setup	8
Step 4 — Handset Operational Check	9
Step 5 — Receive Audio Check	9
Step 6 — Send Audio Adjustment	9
SoundCheck Setup	10
Step 1 — Studio Preparation	10
Step 2 — Power Down the TeleHybrid	10
Step 3 — Call Quiet Line	11
Step 4 — Adjust Send Audio	11
Step 5 — Exit SoundCheck Mode	12
Step 6 — Verify SoundCheck Settings	12
Operation	13
Making calls with the TeleHybrid	13
Answering calls with the TeleHybrid	13
Using existing telephone features	13
Hanging up a call	13
Troubleshooting	14
Specifications	15
Warranty	17
FCC Part 15 Compliance	18
FCC Part 68 Compliance	18
IC Compliance	19
Safety Information	20
Appendix A	21

## List of Figures

Figure 1. Equipment diagram	2
Figure 2. Properly installed TeleHybrid system	5
Figure 3. Telephone cable installation	5
Figure 4. Handset modular line installation	6
Figure 5. RJ45/XLR cable connection/pinout	6
Figure 6. Power module hook up	7
Figure 7. Optional tape recorder hook up	7
Figure 8. TeleHybrid slide control	7
Figure 9. Compatability and sensitivity switches	8
Figure 10. Compatability and sensitivity set up	8
Figure 11. Handset placement with TeleHybrid	9
Figure 12. Sensitivity switch adjustment	9
Figure 13. Power disconnection	10
Figure 14. Sensitivity switch adjustment	11
Figure 15. TeleHybrid without mix-minus	21
Figure 16. TeleHybrid-to-video CODEC	21
Figure 15. News-edit configuration	22
Figure 16. TeleHybrid with teleconferencer	22

## *Introduction*

Congratulations on purchasing the TeleHybrid. The TeleHybrid allows you to hold a completely interactive talkshow, radio or television contest, or teleconference meeting, no matter what type of telephone you have. With the TeleHybrid, you can directly connect external audio equipment to your existing telephone and maintain all normal telephone functions.

This manual explains how to install, set up and operate the TeleHybrid. It also provides instructions on how to resolve minor technical problems, should any arise. An appendix is provided to illustrate different TeleHybrid applications.

If you need additional information on how to install, set up or operate your TeleHybrid, please contact us at Gentner Communications at the location noted below. We welcome and encourage your comments so we can continue to improve our products and better serve your communication needs.

### **Gentner Communications Corporation**

Sales and Technical Assistance

1825 Research Way

Salt Lake City, Utah 84119

TEL: Worldwide (801) 975-7200 In U.S.A. (800) 945-7730

FAX: Worldwide (801) 977-0087 In U.S.A. (800) 933-5107

FAX-On-Demand 24-Hour Information Service (800) 695-8110

Worldwide Web Page @ <http://www.gentner.com>

## *Warranty Registration*

Please register your TeleHybrid by completing the self-addressed, postage prepaid warranty registration card and return it to Gentner Communications by mail. You may also FAX it to the above listed fax number or call Gentner Communications. When your product is properly registered, Gentner Communications will be able to serve you better should you require technical assistance or desire to receive upgrades, new product information, etc.



## Unpacking

Ensure that the following equipment was received with your shipment:

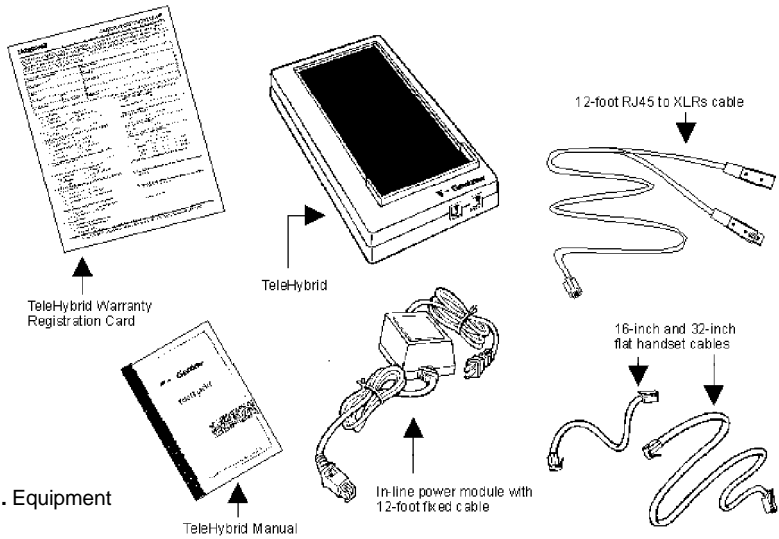

**Figure 1.** Equipment diagram

### **SHIPPING NOTE:**

*Gentner Communications is not responsible for product damage incurred during shipment. You must make claims directly with the carrier. Inspect your shipment carefully for obvious signs of damage. If the shipment appears to be damaged, retain the original boxes and packing material for inspection by the carrier. Contact your carrier immediately.*

*Features and Benefits* 

- Simple, easy professional telephone interface between your phone and external audio equipment
- Telephone compatibility that allows you to use your current telephone capabilities (i.e. hold, transfer, conference, speed-dial, last dial, redial, etc.)
- Compatibility with digital and analog telephones
- Does not require the installation of a dedicated telephone line
- Full-duplex operation allows participants to talk and listen simultaneously
- Digital technology for unsurpassed audio quality
- Tape recorder connectivity to record your call
- Easy to install and operate
- Professional technical support for reliable assistance with setup and operation
- Distribution support near your location for sales and assistance

## **Before You Install**

The TeleHybrid is designed to work with digital and analog telephones. This unique design is a first in the industry. To maximize your audio quality, we recommend that you prepare your site by taking the following factors into consideration:

### ***Power Requirements***

The TeleHybrid will accommodate voltage requirements of 120Vac, 60Hz, 23W with the supplied power module. It will also accommodate other voltage requirements with an optional power transformer.

### ***Telephone Line Requirements***

Unlike other telephone hybrids, the TeleHybrid connects directly to existing digital and analog telephone sets. A dedicated analog telephone line is *not* needed to operate your TeleHybrid.

### ***Telephone Set Requirements***

The TeleHybrid will operate with multiline and single line telephone sets that have a detachable handset cord at the telephone base. The TeleHybrid will *not* work with “Princess” or “Trimline” style telephones that have the dialing pad built into the handset. The dialing pad must be located on the telephone base, not on the telephone handset.

### ***Equipment Placement***

The TeleHybrid should be placed next to the telephone set and virtually anywhere within 12 feet of the equipment you will be connecting to.



## Installation

The TeleHybrid connects directly to your existing telephone set so that you can maintain all normal telephone functions. Follow these step-by-step instructions to install your TeleHybrid:

### Completed Installation

The following drawing shows a properly set up TeleHybrid system. For a complete system diagram, refer to Appendix A (Pages 19-20).



**Figure 2.** Properly installed TeleHybrid system set up with a telephone

### Step 1

Unplug the handset cord from the base of your telephone set. Plug the handset cord into the TeleHybrid jack labeled **HANDSET**.

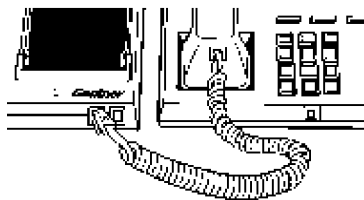
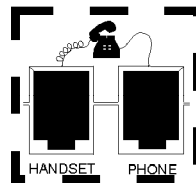

**Figure 3.** Telephone cable installation key pullout (top); handset cable installation (bottom)

**Installation**  
Continued 

**Step 2**

Plug one end of the supplied 16-inch or optional 32-inch flat handset cable into the telephone handset jack. Plug the other end of cable into the TeleHybrid jack labeled PHONE.



**Figure 4.** Handset modular line installation

**Step 3**

Plug the RJ45/XLR cable from the supplied 12-foot connection cable into the TeleHybrid jack labeled CONSOLE ONLY. The two XLRs are for connecting to your external equipment. The Male XLR contains caller audio. The Female XLR contains the audio you will send to the caller. Refer to the appendix for various application setups using the TeleHybrid.

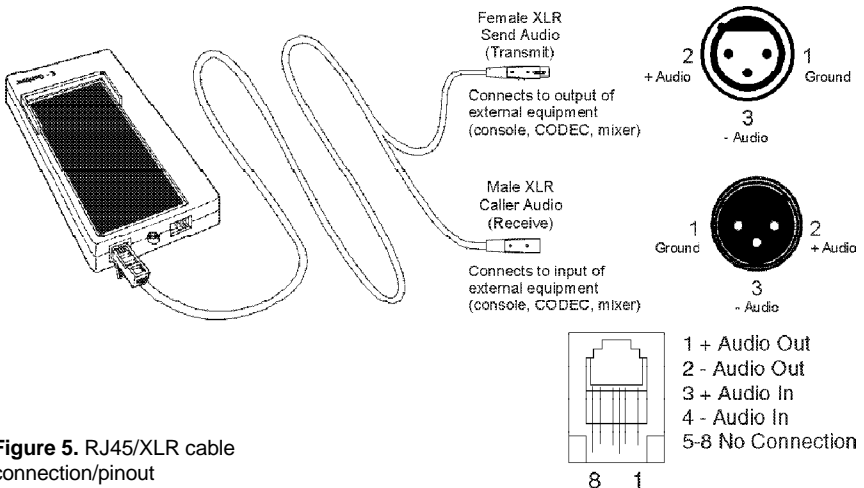

**Figure 5.** RJ45/XLR cable connection/pinout

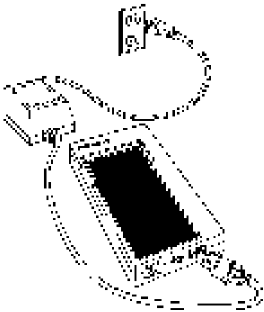
**Step 4**

**Figure 6.** Power module hook up

Plug the white end of the power module with the NOTCH SIDE labeled UP into the TeleHybrid jack labeled 19 VDC IN. Plug the other end of the power module into an electrical power outlet. A power-up message, designed to assist in the adjustment of the receive/caller levels of the TeleHybrid, is played when power is applied.

**Step 5 (Record Option)**

To record your audioconference, connect a tape recorder (not provided) to the TeleHybrid jack labeled REC. A standard phono cable is typically supplied with most tape recorders.

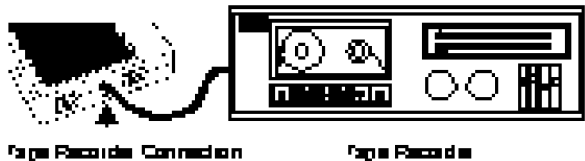

**Figure 7.** Optional tape recorder hook up

### One-Time Setup

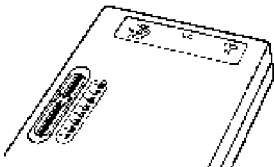
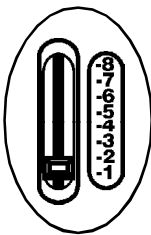

**Figure 8.** TeleHybrid slide control

Because telephones are different, you will need to make a one-time setup to accommodate your particular type of telephone. Follow these step-by-step procedures:

**TELEPHONE VOLUME NOTE:**

*For telephones that have handset volume control, set the telephone handset volume at a normal listening level prior to adjusting the TeleHybrid.*

**Step 1 — Slide Control Setup**

Locate the slide control on the bottom of the TeleHybrid. Set the slide control to position 1.

One-Time Setup  
Continued 

**Step 2 — Switch Location**

Locate the slide cover on the right side of the TeleHybrid. Slide open the cover to reveal the telephone compatibility and sensitivity switches.

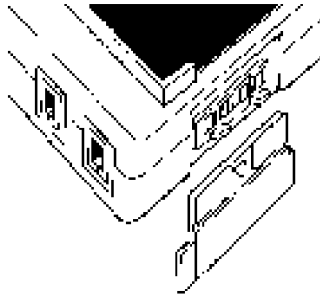

**Figure 9.** Compatibility and sensitivity switches

**Step 3 - Compatibility and Sensitivity Setup**

Determine the appropriate settings for your particular telephone using the following diagram. Set the compatibility and sensitivity switches according to your telephone type.

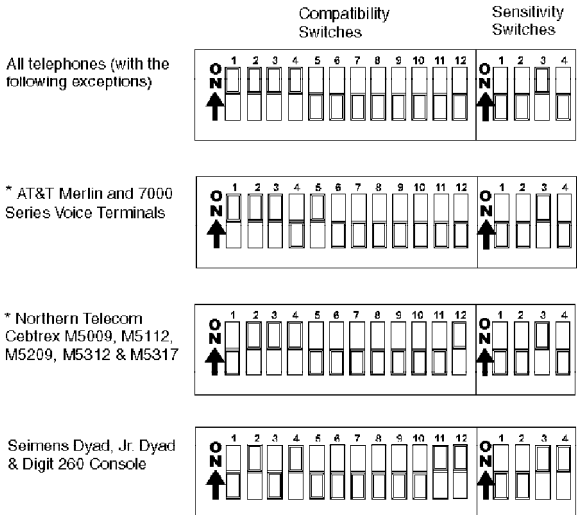
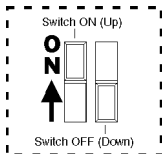

**Figure 10.** Compatibility and sensitivity set up

\* Applies only to telephone models listed. All other models use the "All telephones" settings.

### Step 4 - Handset Operational Check

Pick up the handset and listen for a dial tone. If you hear a dial tone, go to step 5; if you do not hear a dial tone, verify Installation Steps 1-4 (See Pages 5-7.) and check your phone for proper connections.

### Step 5 - Receive Audio Check

Make certain the XLRs are connected to your external equipment properly. Also verify that your external equipment is in the proper operating mode to receive audio from and to send audio to the TeleHybrid.

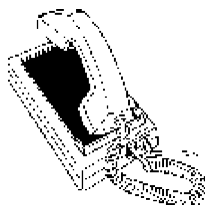

**Figure 11.** Handset placement to activate TeleHybrid

To communicate with the distant location through the TeleHybrid and your external equipment, place the handset on the TeleHybrid pad.

With the TeleHybrid activated, listen for dial tone. If you hear a dial tone, go to Step 6, Send Audio Adjustment (See below.); if you do not hear a dial tone, verify One-Time Setup Steps 1-3 (Pages 8-9).

### Step 6 - Send Audio Adjustment

Place a call and activate your TeleHybrid to verify the send level.

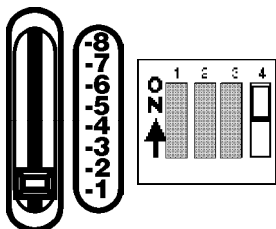

**Figure 12.** (R) Sensitivity switch adjustment; (L) Fine tuning the send level with the slide control

If your level is too high (distorted), change sensitivity switch 4 located behind the side access panel to the ON position.

To fine adjust the send level use the slide control located on the bottom of the TeleHybrid. If your level is too low, adjust the slide control toward position 8 until you reach the proper send level. If your level is too high, move the slide toward position 1.

## One-Time Setup Continued

In order to maximize the performance of the TeleHybrid, keep the slide control as low as possible while still maintaining a comfortable audio level at the distant location.

### **CUSTOMER SERVICE NOTE:**

*Gentner Communication Corporation is dedicated to providing the best customer service. If you have any problems or questions, please call us at: (800) 945-7730 or (801) 975-7200.*

## SoundCheck Setup

In some situations, the send-audio level (from you to the caller) will need adjustment for optimum TeleHybrid performance. This is caused by factors such as the proximity of your facility to the telephone central office and/or the type of telephone system you have installed in your building. To assist in sound-level adjustments, the TeleHybrid is now equipped with SoundCheck.

SoundCheck operates based on the idea that when a telephone line is driven too hard, it will start to distort the returned audio. SoundCheck provides a built-in distortion analyzer to detect this, enabling you to set up for the maximum level possible without compromising your audio quality.

To perform a SoundCheck setup, follow these step-by-step instructions:

### **Step 1 — Studio Preparation**

Ensure that the male XLR (J2) is connected to your studio audio monitoring system, and turn down the volume on the audio amplifier connected to your monitor speakers.

### **Step 2 — Power Down the TeleHybrid**

Remove the DC POWER connector from the rear of the TeleHybrid to power it down.

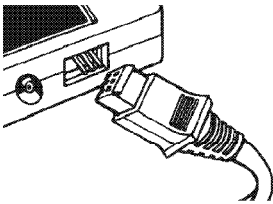
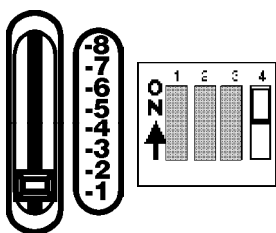

**Figure 13.** Power disconnection

### Step 3 — Call Quiet Line

Pick up your telephone handset and call 1-800-283-5330 (a quiet line used for setup), or a quiet line at your site. When you hear silence at the other end, set the handset down on the TeleHybrid, and plug back in the DC POWER connector, restoring power to the TeleHybrid. SoundCheck should now be enabled.

### Step 4 — Adjust Send Audio



**Figure 12.** (R) Sensitivity switch adjustment; (L) Fine tuning the send level with the slide control

Listening to your studio's audio monitoring system, interpret the tone that is being emitted on your monitor speakers, and adjust the TeleHybrid's SEND AUDIO adjustment.

*Beeping:* signal level too low, increase SEND AUDIO

*Constant:* signal level too high, decrease SEND AUDIO

The desired level should be at the *transition point* between the beeping and constant tone.

If you cannot adjust to this transition point, change sensitivity dip switch 4 (on the right side of the TeleHybrid) UP (ON) for all telephone types being used, *except* for the Seimens Dyad, Junior Dyad and Digit 260 Console. If using one of these three telephone types, change sensitivity dip switch 4 DOWN (OFF).

#### **DIGITAL/ANALOG SYSTEM NOTE:**

*The transition point should be easy to find if using a digital telephone system (distortion for an overdriven digital line is dramatic). However, if connected to an analog telephone system, the transition point may take a little longer to locate (the distortion generated on an overdriven analog line is much gentler).*

**SoundCheck Setup Step 5 — Exit SoundCheck Mode**  
**Continued** 

Once the transition point has been located, exit SoundCheck set-up mode by removing handset from the TeleHybrid, disconnecting the DC POWER connector, waiting a few seconds, then plugging the DC POWER connector back in. Powering down the TeleHybrid *will not* reset settings made with SoundCheck. Disconnect from the quiet line.

**Step 6 — Verify SoundCheck Settings**

Make several test calls to different locations to evaluate the TeleHybrid's performance. If connected on an exceptionally clean line, the audio level may actually need to be adjusted down slightly from the settings indicated by SoundCheck.



## Operation

Operating the TeleHybrid is practically identical to operating your telephone because it uses your existing telephone functions.

### ***Making calls with the TeleHybrid***

Pick up your handset from the telephone cradle and dial out as normal. Place the handset on the TeleHybrid pad. The TeleHybrid will function automatically.

### ***Answering calls with the TeleHybrid***

Pick up your handset from the telephone cradle and answer the call as normal. After the telephone call has been established, place the telephone handset on the TeleHybrid pad or immediately place the handset on the TeleHybrid pad after answering the call. The TeleHybrid will function automatically.

### ***Using existing telephone features***

To use your normal telephone functions (i.e. put a call on hold, transfer a call, access additional lines, conference additional lines, hold a private conversation) the handset can be *either* placed on the TeleHybrid or picked up and used as normal.

### ***Hanging up a call***

Place the handset on the telephone handset cradle.

#### ***POWER FAILURE NOTE:***

*If you experience a power failure or power bump, you will not lose your call. The caller will be back on the handset. Once power is restored, simply pick up the handset and replace it on the on the TeleHybrid to restore your call.*

## Troubleshooting

<i>Symptom</i>	<i>Probable Cause</i>	<i>Probable Remedy</i>
■ There is no dial tone through the system	The One-Time Setup configuration is improperly set	See the One-Time Setup section (Step 4, Page 9) in this manual
■ The audio level received at the distant location is too low or too high	The send audio volume is set too low or too high	See the One-Time Setup section (Step 6, Page 10) in this manual
■ The system sounds “scratchy” or is producing excessive noise	There is a bad telephone-line connection	Redial the number or have the distant location call again to get a better connection
	The distant location has noisy equipment or is in a noisy environment	Have the people at the distant location eliminate the noise source or, if possible, move to another room
■ The system squeals or produces feedback	The One-Time Setup configuration is improperly set	See the One-Time Setup section (Step 3, Page 9) in this manual
	If the telephone had a handset volume control, it has been set too high	Adjust the telephone handset volume to the normal listening level
	The send audio volume is set too high	See the One-Time Setup section (Step 6, Page 10) in this manual

If you cannot resolve your difficulty by following the suggested remedies in this troubleshooting section, please call Gentner Communications Corporation for assistance at **800-945-7730** or **801-975-7200**.

**Specifications**  **TeleHybrid****Dimensions**

9.80" L x 4.70" W x 1.25" H  
 (24.89 L x 11.94 W x 3.18 H cm)

**Weight**

4 lbs. (1.81kg) dry  
 6 lbs. (2.72kg) shipping

**Connectors**

PHONE:	4 conductor, handset style
HANDSET:	4 conductor, handset style
CONSOLE ONLY:	8 conductor, RJ45
REC:	Phono
19 VDC IN:	3 Pin, Molex style

**Power Requirements**

120Vac, 60Hz, 23W (or optional power supply)

**Echo Cancellation**

Digital echo cancellation used to eliminate telephone-line echo

**Audio Performance****Frequency Response**

300–3,300Hz, 1.5dB

**Signal to Noise Ratio**

50dB

**Total Harmonic Distortion**

≤.3 percent

**Record Output**

-10dBu, 60 ohms, unbalanced

**Operating Temperature**

32–100° F

**Storage Temperature**

0–150° F

*Specifications*  
*Continued* ≡

***In-line Power Supply Module***

***Dimensions***

3.5" L x 2.50" W x 2.75" H  
(8.90 L x 6.35 W x 7.0 H cm)

***Cable Length***

12-foot fixed cable

***Weight***

2 lbs. 1 oz. (.94 kg) dry

***Electrical***

Output: 19Vdc unregulated, 23W

Input: 120Vac, 60Hz

Supplied Cables

***Handset Cables***

16-inch flat and 32-inch flat (optional use)

***Connection Cable***

12-foot w/male and female XLRs. Input >20K;  
0dBu. Output 100ohms; designed to drive  
600ohms; 0dBm.

*Installed*  
*Systems* ≡

Gentner Communications Corporation has a variety of systems to fit your particular communications needs. If you have a large group of people, or need an installed system to accommodate a custom boardroom, Gentner products are designed to provide exceptional audio performance while offering the most advanced features available.

For a demonstration and more information on other Gentner telecommunications products, call your local representative or a member of our sales team.

## Warranty

Gentner Communications Corporation (Manufacturer) warrants that this product is free of defects in both materials and workmanship. Should any part of this equipment be defective, the Manufacturer agrees, at its option, to:

A. Repair or replace any defective part free of charge (except transportation charges) for a period of one year from the date of the original purchase, provided the owner returns the equipment to the Manufacturer at the address set forth below. No charge will be made for parts of labor during this period;

B. Furnish replacement for any defective parts in the equipment for a period of one year from the date of original purchase. Replacement parts shall be furnished without charge, except labor and transportation.

This Warranty excludes assembled products not manufactured by the Manufacturer whether or not they are incorporated in a Manufacturer product or sold under a Manufacturer part or model number.

### **THIS WARRANTY IS VOID IF:**

A. The equipment has been damaged by negligence, accident, act of God, or mishandling, or has not been operated in accordance with the procedures described in the operating and technical instructions; or,

B. The equipment has been altered or repaired by other than the Manufacturer or an authorized service representative of the Manufacturer; or,

C. Adaptations or accessories other than those manufactured or provided by the Manufacturer have been made or attached to the equipment which, in the determination of the Manufacturer, shall have affected the performance, safety or reliability of the equipment; or,

D. The equipments original serial number has been modified or removed.

**NO OTHER WARRANTY, EXPRESS OR IMPLIED, INCLUDING WARRANTY OF MERCHANTABILITY OR FITNESS FOR ANY PARTICULAR USE, APPLIES TO THE EQUIPMENT**, nor is any person or company authorized to assume any warranty for the Manufacturer or any other liability in connection with the sale of the Manufacturer's products.

Manufacturer does not assume any responsibility for consequential damages, expenses, or loss of revenue or property, inconvenience, or interruption in operation experienced by the customer due to a malfunction in the purchased equipment. No warranty service performed on any product shall extend the applicable warranty period.

In case of unsatisfactory operation, the purchaser shall promptly notify the Manufacturer at the address set forth below in writing, giving full particulars as

*Warranty*  
*Continued* 

to the defects or unsatisfactory operation. Upon receipt of such notice, the Manufacturer will give instructions respecting the shipment of the equipment, or such other matters as it elects to honor this warranty as above provided. This warranty does not cover damage to the equipment during shipping and the Manufacturer assumes no responsibility for such damage. All shipping costs shall be paid by the customer.

This warranty extends only to the original purchaser and is not assignable or transferable.

**Gentner Communications Corporation**  
**1825 Research Way, Salt Lake City, Utah 84119**

*FCC Part 15*  
*Compliance* 

This equipment has been tested and found to comply with the limits for a Class A digital device, pursuant to Part 15 of the FCC rules. These limits are designed to provide reasonable protection against harmful interference when the equipment is operated in a commercial environment. This equipment generates, uses, and can radiate radio frequency energy and, if not installed and used in accordance with the instruction manual, may cause harmful interference to radio communications. Operation of this equipment in a residential area is likely to cause harmful interference, in which case the user will be required to correct the interference at his/her own expense.

Changes or modifications not expressly approved by Gentner Communications Corporation could void the user's authority to operate the equipment.

*FCC Part 68*  
*Compliance* 

This equipment complies with Part 68 of the FCC rules. On the bottom of the TeleHybrid is a label that contains, among other information, the FCC registration number. If requested, this information must be provided to the telephone company.

If this equipment causes harm to the telephone network, the telephone company will notify you in advance that temporary discontinuance of service may be

required. If advance notice is not practical, the telephone company will notify the customer as soon as possible. Also, you will be advised of your right to file a complaint with the FCC if you believe it is necessary.

The telephone company may make changes in its facilities, equipment, operations, or procedures that could affect the operation of the equipment. If this happens, the telephone company will provide advance notice for you to make the necessary modifications in order to maintain uninterrupted service.

If trouble is experienced with this equipment, please contact Gentner Communications Corporation at (800) 945-7730 or (801) 975-7200 for repair and warranty information. If the trouble is causing harm to the telephone network, the telephone company may request you remove the equipment from the network until the problem is resolved.

This equipment cannot be used on telephone company provided coin service. Connection to Party Line Service is subject to state tariffs.

When the TeleHybrid is used with a leased telephone system, permission to connect to the telephone system should be obtained from the owner of the system. Customer instructions for Kx-type telephones with message waiting lights and/or line status indicators must contain statements that they can only be connected to host equipment and never to the network. This device must be connected through the telephone handset.

**FCC Registration Number:** FBIUSA-21446-KX-N

### *IC Compliance*

**NOTICE:** The Industry of Canada label identifies certified equipment. This certification means that the equipment meets certain telecommunications network protective operational and safety requirements. The Department does not guarantee the equipment will operate to the user's satisfaction.

Before installing this equipment, users should ensure that it is permissible to be connected to the facilities of the local telecommunications company. The equipment must also be installed using an acceptable method of connection. In some cases, the company's inside wiring associated with a single line individual service may be extended by means of a certified connector assembly (telephone extension cord). The customer should be aware that compliance with the above

## *IC Compliance*

### *Continued*

conditions may not prevent degradation of service in some situations.

Repairs to certified equipment should be made by an authorized Canadian maintenance facility designated by Gentner Communications. Any repairs or alterations made by the user to this equipment, or equipment malfunctions, may give the telecommunications company cause to request the user to disconnect the equipment.

Users should ensure for their own protection that the electrical ground connections of the power utility, telephone lines and internal metallic water pipe system, if present, are connected together. This precaution may be particularly important in rural areas.

**CAUTION:** Users should not attempt to make such connections themselves, but should contact the appropriate electrical inspection authority, or electrician, as appropriate.

## *Safety*

### *Information*

**CAUTION:** For use only with certified telecommunication equipment.

**ATTENTION:** Pour utilisation seulement avec du matériel de telecommunications certifié de marque.



## Appendix A **TeleHybrid without built-in Mix-Minus**

This model of the TeleHybrid was designed specifically for a broadcast environment where mix-minus capability is already available through existing studio equipment. All broadcast versions of the TeleHybrid contain Automatic Gain Control (AGC) on the Receive Audio signal.

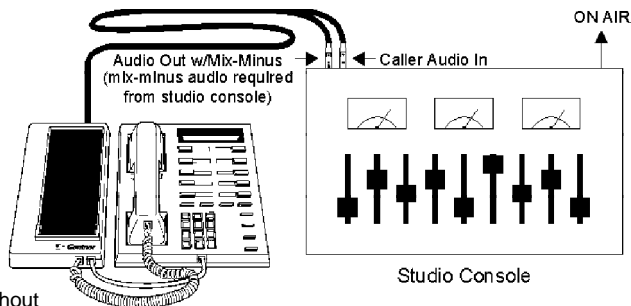

**Figure 15.** TeleHybrid without mix-minus

### **TeleHybrid to Video CODEC**

TeleHybrid can be set up for conferencing, with your Video CODEC.

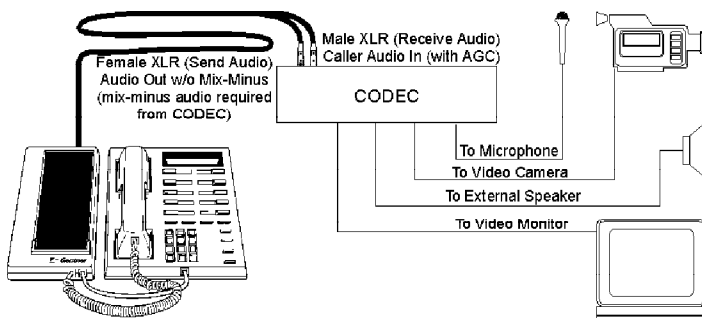
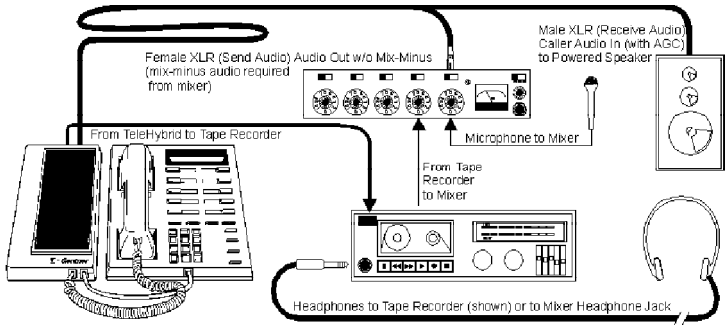

**Figure 16.** TeleHybrid-to-video CODEC connection

Appendix A  
Continued 

**TeleHybrid to Audio Mixer in a News Edit Configuration**

The TeleHybrid can be used in News Edit configuration with audio mixer, powered speaker, tape recorder and headphones.



**Figure 17.** TeleHybrid-to-audio news-edit configuration

**TeleHybrid use for Teleconferencing**

The TeleHybrid and an Audio Teleconferencer can be connected with the XLR connectors to the receive and send audio jacks on the back of an Audio Teleconferencer.

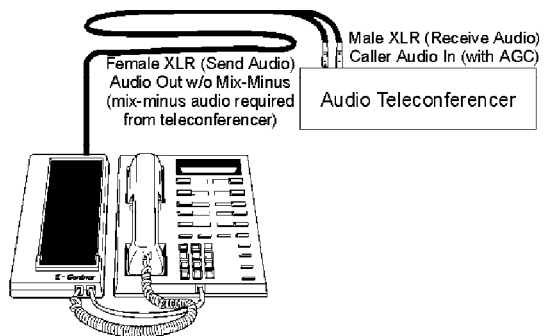

**Figure 18.** TeleHybrid set up with an audio teleconferencer



*“Our vision is to provide our customers with  
the total audio solution for conferencing.”*



GENTNER COMMUNICATIONS CORPORATION

Sales and Technical Assistance

1825 Research Way

Salt Lake City, Utah 84119

Toll Free 800-945-7730

Telephone 801-975-7200

FAX 801-977-0087

FAX-On-Demand 800-695-8110

Worldwide Web Page @ <http://www.gentner.com>

*Gentner Part No. 800-006-010 (Rev. 2.10)*