



ClearOne[®]

CONFERENCEING PRODUCTS GUIDE

**how many conferencing systems
do you see in this picture?**



ClearOne now has the best portfolio of audio conferencing solutions for a complete range of applications

When you drive around your city and look at corporate offices, schools and other buildings, do you imagine how many places need AV communications?

Well, you have now become a seasoned AV solution provider. You're able to master the integrated room with XAP and Converge.

Beyond the installed boardroom and main conference or training room, there are some straight-ahead rooms and now even desktops, where you can place RAV, MAX Attach, MAX Wireless or the new MAX IP and Chat 50.

A multitude of rooms are out there for tabletop conferencers like MAX Attach (wired for up to four daisy-chained units and Wireless - now with up to two pods working together.)

If you mine your accounts you will soon find, not only those incremental additional rooms, but also the opportunity for a fleet sale of multiples. ClearOne gives more margin and better features than the Polycoms available everywhere on the net, with phone companies and so on.

how many conferencing systems

do you see *now* in this picture?



• **XAP**- The most advanced processing product in the industry. Now on version 5.0.6, it has been constantly refined and improved. Unit linking allows designers to create a large cross-point audio routing matrix. While the processor is highly configurable, the interface to do so is the easiest and fastest you can find.

PAGES 10-12

• **CONVERGE**- This new mid-priced unit allows you to apply it where 6 or 9 mics are required. It's like the RAV processor with more. Select your favorite types of mics from wireless to goose-neck to table mics. A set-up wizard makes this a very quick implementation.

PAGE 9

• **RAV**- 6 and 9 mic systems of complete bundled packages that have dedicated 360 degree mics and optional ceiling or wall/table-top speakers.

PAGES 7-8

• **MAX Attach & EX**- Wired MAX handles the simple department meeting space where one pod or 2, 3 & 4 linked together can provide the step-up from clipping, non-duplex speaker phones.

PAGES 3-4

• **MAXWireless & MAX Attach Wireless**- Get cables clutter off the table and give your customer freedom to use the conferencer where ever they want to. The Attach version now gives you two wireless units for more coverage.

PAGE 2

• **MAX IP**- designed to work for the company that's made the change to a VoIP phone system.

PAGE 5

• **CHAT 5** - the ideal personal conference unit that interfaces to PC, phone & even your iPod.

PAGE 6

• **Microphones & Mic Bundles**- The best selection of conference mics are now packaged with XAP & Converge

PAGES 15-17

• **Pro Sound Reinforcement**- The PSR packs a lot of audio DSP processing in a great value, using the same familiar interface engineers know with the XAP line.

PAGE 18

• **Furniture**- You're writing the electronic equipment for the room, add needed furniture for it too.

PAGES 19-25

ClearOne. WIRELESS TABLE-TOP CONFERENCERS

POLYCOM, YOU'VE GOT A CHALLENGER ON LINE ONE

**MAX™ Wireless
Part# 910-158-001**



- 150 foot wireless signal range
- Up to 8 hours of talk-time
- Distributed Echo Cancellation®
- Dual function power supply / charger included
- Automatic power-save mode
- 360° microphone coverage
- 2.4 GHz WDCT operation range

The MAX™ Wireless offers superior ClearOne-signature quality in a portable, wireless unit. Simply plug in the base and use the phone in any room within signal range. The wireless design creates a clean look, removing the wires and cords that can be tripped on or run over with chairs. It features Gentner® Distributed Echo Cancellation®, noise cancellation, advanced audio processing, and full-duplex performance so you can count on clear, highly intelligible audio for effective, interactive conferences.

**MAX™ Attach Wireless
Part# 910-158-070**



- Dual-phone configuration provides outstanding mid-sized room coverage with multiple microphones and loudspeakers
- Digital spread spectrum provides completely secure conferencing
- 150-foot wireless signal range allows use in multiple rooms without moving the base unit
- Up to 12 hours of talk-time lets you conduct lengthy conferences without recharging
- Dual-function power supply/charger enables you to continue your conference while charging
- 4-hour charging time quickly prepares phone for its next conference
- Automatic power-save mode

Wireless conferencing phone (WDCT 2.4 GHz, US Version) MAXAttach Wireless brings you ClearOne's industry-leading, professional audio technology for crisp, clear sound in an easy-to-use conferencing system with two wireless phones for expanded room coverage

**Battery Pack
Part# 592-158-001**

7.2 V 1800 MAH for Max Wireless Phones for 8 hour talk time

**Battery Pack
Part# 592-158-002**

7.2 V 2200 MAH for Max Wireless Phones for 12 hour talk time



Wireless

Compare to Polycom SoundStation 2W with 2 mics

POLYCOM

- ❖ \$1099 MSRP
- ❖ Full-duplex
- ❖ Automatic Gain Control
- ❖ Gated microphones
- ❖ 1 fully functional dial pad
- ❖ 3 built in mics & 2 external
- ❖ 1 built in speaker
- ❖ LCD display
- ❖ 1 year warranty

CLEAR-ONE MAX ATTACH WIRELESS

- ❖ **\$999 MSRP**
- ❖ Full-duplex
- ❖ Automatic Level Control
- ❖ Gated microphones
- ❖ **2 fully functional dial pads**
- ❖ **6 built in microphones**
- ❖ **2 built in speakers**
- ❖ LCD display
- ❖ **2 year warranty**

The SoundStation 2W single base unit has an MSRP of \$699, compared to the single MAX Wireless of \$599.

PLUS YOU WILL MAKE MORE MARGIN WITH CLEAR ONE

ClearOne. TABLE-TOP AUDIO CONFERENCERS

**MAX™ Attach
Part# 910-158-055**



The MAX™ Attach comes packaged as two phone units and a single base unit for medium conference rooms. It is also available in 3-phone and 4-phone kits. Link up to four complete phones (not just microphones) for expanded coverage with MAX EX Expansion Kits.

Divide MAXAttach into multiple phone systems for use in separate rooms with MAX EX Expansion Base.

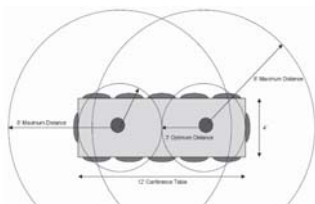

- Comes with two phone units and a single base
- Up to 8 hours of talk-time
- Distributed Echo Cancellation®
- 360° microphone coverage
- Link up to four complete phones

It features Gentner® Distributed Echo Cancellation®, noise cancellation, advanced audio processing, and full-duplex performance. You can count on clear, highly intelligible audio for effective, interactive conferences. Automatic level controls keep participants' audio balanced and consistent. First-mic priority eliminates hollow "tunnel" sound by activating only the microphone closest to the person speaking.

**MAX™ Attach Plus One
Part# 910-158-055-01**

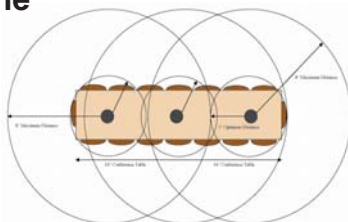

Wired

**MAX™ Attach Plus Two
Part# 910-158-055-02**

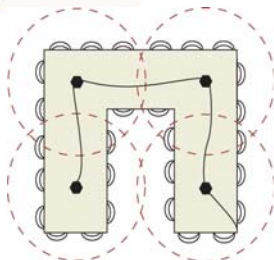

Compare to Polycom SoundStation 2

| POLYCOM | CLEAR-ONE MAX ATTACH |
|---|---|
| ❖ \$899 MSRP | ❖ \$799 MSRP |
| ❖ Full-duplex | ❖ Full-duplex |
| ❖ Automatic Gain Control | ❖ Automatic Level Control |
| ❖ Gated microphones | ❖ Gated microphones |
| ❖ 1 fully functional dial pad | ❖ 2 fully functional dial pads |
| ❖ 3 built in mics & 2 external | ❖ 6 built in microphones |
| ❖ 1 built in speaker | ❖ 2 built in speakers |
| ❖ LCD display | ❖ LCD display |
| ❖ 1 year warranty | ❖ 2 year warranty |
| ❖ Not expandable further after extension mics are added | ❖ Expandable – Add up to two more pods for larger rooms. |

MAXAttach with 4 pods will expand for more coverage area than a Polycom with 2 mics. MAX Attach or any Plus package distributes speakers where listeners are, for an even sound and better audibility. Comparisons to VTX1000 also available; ask your ClearOne rep.

ClearOne™ TABLE-TOP AUDIO CONFERENCERS

MAX™ EX Part# 910-158-015



- Gentner® Distributed Echo Cancellation
- Noise cancellation
- Full duplex - enables participants to speak and listen at the same time
- Automatic level control — keeps participant audio balanced and consistent

The MAX™ EX is unique in its expansion capabilities. It allows for additional phones to be connected, not just microphones. This creates an even distribution of microphones, loudspeakers, and controls for better sound quality and user access. Max EX features Gentner® Distributed Echo Cancellation®, noise cancellation, and advanced microphone activation process. Add these to its simple setup and you've got the perfect conferencing solution for virtually any size group.

MAX™ EX Expansion Kit Part# 910-158-050



- Gentner® Distributed Echo Cancellation
- Noise cancellation
- Full duplex - enables participants to speak and listen at the same time
- Automatic level control — keeps participant audio balanced and consistent

The MAX™ EX expansion kit allows the user to EXPAND the Max EX. Up to 3 expansion kits can be added to the original MAX EX for a total of 4 units. MAX EX features Gentner® Distributed Echo Cancellation®, noise cancellation, and advanced microphone activation process. Add these to its simple setup and you've got the perfect conferencing solution for virtually any size group.

Single phone



Two linked phones



Three linked phones



Four linked phones



For assistance with non-standard configurations, please contact technical support at 1.800.283.5936 (USA) or 1.801.974.3760.

Wired

PARTS FOR MAX SERIES

Power Supply

Part# 910-158-020

120VAC/12VDC Center Pin Straight for Max Wireless WDCT
others for Euro, UK, S.Africa & Australia available

Replacement Base

Part# 910-158-041

Max EX Base includes 25' cable assembly.



Extension cable

Part# 830-158-005

12' cable for EX.

Konexx digital-to-analog converter

Part# 910-156-120

ClearOne. VoIP TABLE-TOP AUDIO CONFERENCERS

**MAX™ IP
Part# 910-158-301**



- Same quality features as all MAX
- Connect to a wide variety of SIP platforms
- VLAN tagging allows for bandwidth management & secure separation of voice & data networks
- 3-way calling allows for ad-hoc conferences without need for a bridge
- TLS & SRTP encryption-ready (with future release of firmware upgrade); secures voice communications over the network
- Field upgradeability - allows users to easily download firmware upgrades from ClearOne website and load directly into the conference phone

With MAX IP™ and MAXAttach IP™, customers with SIP-based VoIP systems can now enjoy outstanding audio clarity and superior room coverage, at a price point well below the competition. They allow customers to daisy-chain multiple phones together, up to a total of four. This provides multiple speakers, multiple microphones, and multiple dial pads distributed throughout the room for unrivaled coverage. In addition, these VoIP conference phones offer the advanced audio signal processing technologies that were originally developed for ClearOne's market-leading professional audio conferencing products.

**MAX™ ATTACH IP
Part# 910-158-355**

**MAX™ ATTACH IP - Plus One
Part# 910-158-355-01**

**MAX™ ATTACH IP - Plus two
Part# 910-158-355-02**

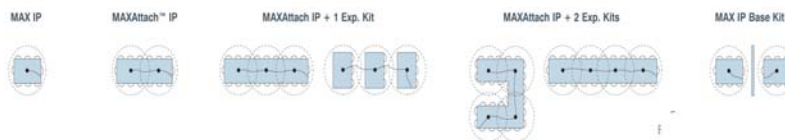

VoIP

**MAX™ IP Expansion Kit
Part# 910-158-350**

phone, cable, no base unit

**MAX™ IP Base Unit
Part# 910-158-345**

Compare to Polycom SoundStation IP4000 with mics

- POLYCOM**
- ❖ \$1398 MSRP
 - ❖ Full-duplex
 - ❖ Automatic Gain Control
 - ❖ Gated microphones
 - ❖ 1 fully functional dial pad
 - ❖ 3 built in mics & 2 external
 - ❖ 1 built in speaker
 - ❖ LCD display
 - ❖ 1 year warranty
 - ❖ Not expandable further after extension mics are added

- CLEAR-ONE MAX ATTACH IP**
- ❖ **\$1199 MSRP**
 - ❖ Full-duplex
 - ❖ Automatic Level Control
 - ❖ Gated microphones
 - ❖ **2 fully functional dial pads**
 - ❖ **6 built in microphones**
 - ❖ **2 built in speakers**
 - ❖ LCD display
 - ❖ **2 year warranty**
 - ❖ **Expandable – Add up to two more pods for larger rooms.**

MAXAttach IP with 4 pods will expand for more coverage area than a Polycom with 2 mics. Max Attach or any Plus package distributes speakers where listeners are, for an even sound and better audibility.

ClearOne. PERSONAL AUDIO CONFERENCERS

**Chat 50™ USB
Part# 910-159-001**

Includes Chat 50 Personal Speaker Phone, USB cable & power supply



- Crisp, Clear Audio; full duplex
- Hands-free Comfort - move freely
- Slightly bigger than a pack of cards,
- Multiple connection options- USB, mini-plug analog to various connectors
- Avoid ear fatigue as with headsets
- Accessories; case, international power adapters, USB cable, 2.5mm-3.5mm cell cable, 3.5-3.5mm MP3 player cable, plus optional accessories
- Configuration software allows easy switch between devices

The age of internet phone calls, VoIP, web conferencing & collaboration is here..... and Chat™ 50 personal speaker phones are ideal for such use and more. Chat 50 is a mobile audio peripheral that connects to a wide variety of devices for crystal-clear, hands-free audio communications. With the desktop or with the wired or cellular phone, Chat provides impressive audio quality.

Chat 50 has full-duplex capability, unmatched in such a small device. Simultaneously speak and listen without audio cutting in and out. The high-quality audio can be useful for music, gaming and other sound files playback.

**Chat 50™ USB-Plus
Part# 910-159-002**

Includes Chat 50 Personal Speaker Phone, USB cable, 2.5mm-3.5mm cell phone audio cable & power supply

**Chat 50™ Global Traveler
Part# 910-159-003**

Includes Chat 50 Personal Speaker Phone, USB cable, 2.5mm-3.5mm cell phone audio cable, travel case, MP3 interface cable, international power supply with clips (US, EUR, UK, AUS)



APPLICATIONS

- Internet Telephony
 - + Skype, Vonage
- Enterprise Telephones
 - + Avaya, Cisco, NEC, Nortel
- VoIP Softphones
 - + Avaya, Cisco, Nortel
- Cell Phones
 - + Motorola, Nokia
- Web Conferencing
 - + HitCast
 - + IBM/Lotus Sametime
 - + Microsoft Live Meeting, WebEx
- Instant Messenger
 - + AOL, Microsoft MSN, Yahoo
- Desktop Video Conferencing
 - + Polycom, Sony, Tandberg
- Audio Playback
 - + iPod
 - + QuickTime, RealPlayer
 - + Windows Media Player
- PC-Based Gaming
 - + TeamSpeak

Web

ACCESSORIES & PARTS

- 830-159-001 USB cable (3')
- 830-159-002 Cellphone audio cable (2.5-3.5mm)
- 830-159-003 Video conferencing cable (3.5mm-RCA)
- 830-159-004 Video conferencing cable (3.5-3.5mm)
- 830-159-005 MP3 player audio cable (3.5-3.5mm)
- 830-159-006 Headset-to-headphone/microphone splitter (3.5-3.5mm/3.5mm)
- 460-159-001 Travel case (hard shell)
- 551-159-001 Power supply
- 551-153-500-01G Power supply clips (US, EU, UK, & AUS)

ClearOne PACKAGED AUDIO CONFERENCERS

RAV™ 600

Part# 910-153-101

two microphone pods and BOSE ceiling speakers, **wireless remote**

RAV™ 600

Part# 910-153-102

two microphone pods and BOSE wall-mount speakers, **wireless remote**

RAV™ 600

Part# 910-153-100

two microphone pod base system without speakers, **wireless remote**

- Ease of installation (IE:CAT5) provides lower cost and maintenance
- Ease of use- centralizes operational functionality through wireless or wired tabletop controller
- Familiar user interface that resembles a standard phone
- Connect to video or web conferencing
- Gentner® Distributed EchoCancellation® and Noise Cancellation.
- AMX/Crestron control system capable.
- Camera Control with VC systems allow Voice Tracking Mode to have camera presets triggered by microphone activation
- 2 year warranty

RAV is a complete, out-of-the-box audio conferencing system that includes an audio mixer, loudspeakers, microphones and a wireless or wired control device. RAV is a higher-quality alternative to standard pod conferencers and allows connection to video codecs, webconferencing and other AV devices like DVDs, VCRs, etc.

It features Distributed Echo Cancellation®, noise cancellation, microphone gating and a drag-and-drop graphical user interface for easy system setup, control and management.

RAV is available in two models, RAV 600 and RAV 900. RAV 600 includes an audio mixer with an integrated telephone interface and amplifier, a wireless or wired control unit, RAV-Ware™ software, and two RAV microphone pods comprised of three microphones each. RAV 900 adds an extra microphone pod to deliver optimal voice pickup in larger rooms. Both models include Ethernet control for remote management and configuration capabilities.

Systems can include two Bose® ceiling- or wall-mount speakers or have the RAV base alone for addition of your choice of speakers. The amplifier is 10 watts.



RAV™ 600

Part# 910-153-113

two microphone pods and BOSE ceiling speakers, **wired remote**

RAV™ 600

Part# 910-153-114

two microphone pods and BOSE wall-mount speakers, **wired remote**

RAV™ 600

Part# 910-153-112

two microphone pod base system without speakers, **wired remote**



- Line input: Unbalanced RCA -10 dBu adjustable from -14 dB to +18 dB Nominal Level: -10
- Line output: Unbalanced RCA -10 dBu adjustable from -14 dB to +18 dB Nominal Level: -10
- Mic pod connection:RJ-45 with Cat.
- Record/Playback I/O: 2 Unbalanced RCA -10 dBu adjustable from -14 dB to +18 dB Nominal Level: -10
- Loudspeaker out: Left and right push terminals
- Telephone interface: RJ11 (1-in; 1-thru to phone set)
- RS-232 port: DB9 female
- 10/100 Ethernet Control Port: RJ 45
- VISCA camera control port: DIN, 9600 baud, no Flow Control
- Dimensions: Mixer: 17" x 7.5" x 2" RF Controller: 10.5" x 4.5" x 2.75"
- Mic Pod Diameter: 7" (17.8 cm), Height: 1.5" (3.8 cm)
- Weights: Mixer: 4.5 lb RF Controller: 2.0 lb Mic Pod: 1.1 lb

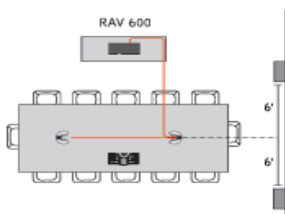

ClearOne PACKAGED AUDIO CONFERENCERS

RAV™ 900
Part# 910-153-301

 three microphone pods and BOSE ceiling speakers, **wireless remote**
RAV™ 900
Part# 910-153-302

 three microphone pods and BOSE wall mount speakers, **wireless remote**
RAV™ 900
Part# 910-153-300

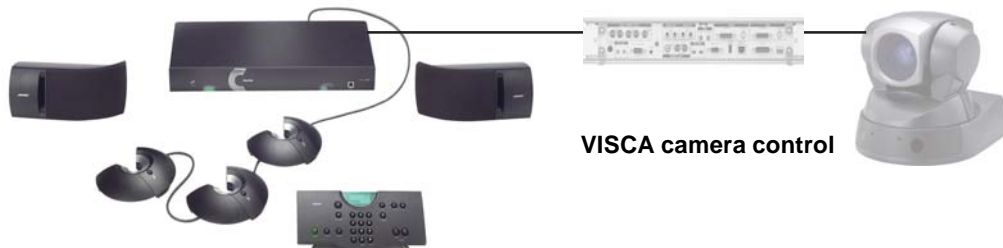
 three microphone pods does not include speakers, **wireless remote**

RAV™ 900
Part# 910-153-314

 three microphone pods and BOSE ceiling speakers, **wired remote**
RAV™ 900
Part# 910-153-315

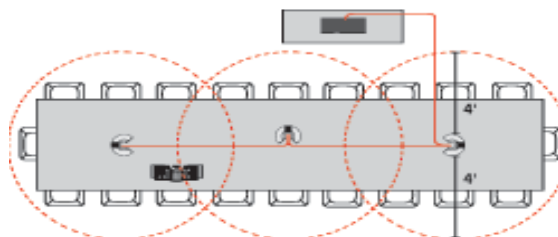
 three microphone pods and BOSE wall mount speakers, **wired remote**
RAV™ 900
Part# 910-153-313

 three microphone pods does not include speakers, **wired remote**

RAV-WARE™ SOFTWARE

Customize the audio settings and configure system via the built-in USB or Ethernet connection with drag-and-drop user interface.

- + Device Toolbox: Pre-configured audio settings for common auxiliary devices
- + Set-up wizard driven
- + System Check: Verify RAV components
- + Event Logging: Track system events
- + Network Find: Connect to other RAV units
- + Firmware Upgrades: Update RAV remotely

RAV™ Wired Controller
Part# 910-153-025

RAV™ Remote Antenna Accessory kit
Part# 910-153-050

Wired or wireless controllers available in system packages

ClearOne™ INSTALLED AUDIO CONFERENCING

Converge™ 560 Part# 910-153-560

two distribution mic boxes for 6 mics, **wireless remote**

Converge™ 560 Part# 910-153-565

two distribution mic boxes for 6 mics, **wired remote**



- Distributed Echo Cancellation®, Noise Cancellation, First Mic Priority, Look-Ahead Gating, ClearEffect™, Adaptive Modeling, Chairman Override Mode
- Single speaker zone sound distribution allows amplification of presenter's voice in near-end room
- Camera control: Camera presets triggered by microphone activation with video conferencing
- Customize the audio settings and configure system via the built-in USB or Ethernet connection with drag-and-drop user interface.

The Converge 560 and 590 conferencing systems deliver optimum audio performance and configuration flexibility for medium-sized rooms requiring up to nine microphones, all at a price point hundreds or even thousands of dollars below competitive offerings.

Converge 560 and 590 allow customers to connect their preferred microphones, such as wireless, tabletop, button and podium using industry-standard XLR connectors.

Converge™ 590 Part# 910-153-590

three distribution mic boxes for 9 mics, **wireless remote**

Converge™ 590 Part# 910-153-595

three distribution mic boxes for 9 mics, **wired remote**



The Converge 560 and 590 distribution box transports microphone signals over a single Cat 5 cable back to the mixer via distribution boxes significantly reducing on-site wiring complexity and installation time. Converge 560 and 590 also include an intuitive controller for simple user operation, eliminating the need for more expensive control systems and delivering a much lower total system cost.

Improved features over the RAV platform include a new 3 PEQ from 20 to 15 KHZ and -15 to +15 dB is available, camera control has one preset per mic, a home (silence) preset and a device toolbox to add mic objects.

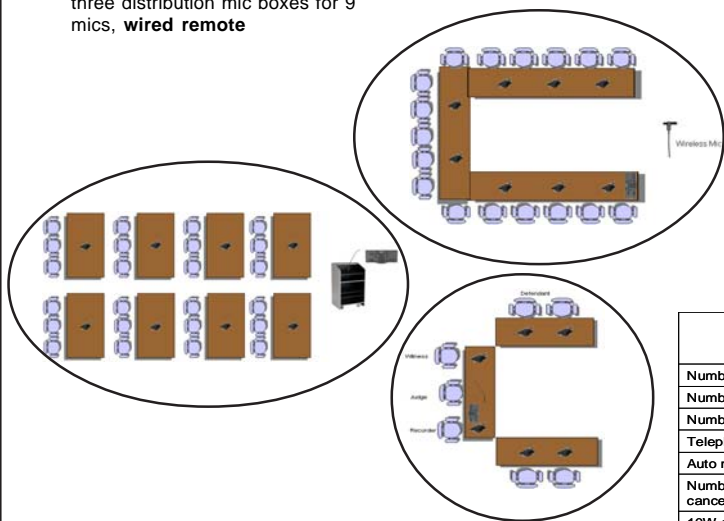

Converge™ Remote Antenna kit Part# 910-153-050

| | ClearOne Converge 560 | Polycom Vortex EF2241 | ClearOne Converge 590 | Polycom Vortex EF2280 |
|--|---------------------------------------|-----------------------------|---------------------------------------|-----------------------------|
| Number of mic inputs | 6 | 4 | 9 | 8 |
| Number of line level inputs | 2 | 4 | 2 | 4 |
| Number of line level outputs | 2 | 8 | 2 | 12 |
| Telephone interface | X | X | X | No |
| Auto mic mixer | X | X | X | X |
| Number of independent mic echo cancellation channels | 6 | 4 | 9 | 8 |
| 10W speaker amplifier | X | X | X | No |
| Dial pad controller included | X | No | X | No |
| LAN connection for remote management | X | No | X | No |
| Converge MSRP including controller | <i>List price</i> \$3099.00 | | <i>List price</i> \$3499.00 | |
| Polycom MSRP without controller | | \$3995 | | \$4615 |
| Converge price advantage | Significantly less | | Significantly less | |

ClearOne. INSTALLED AUDIO CONFERENCING

XAP 800

Part# 910-151-101



What's included:

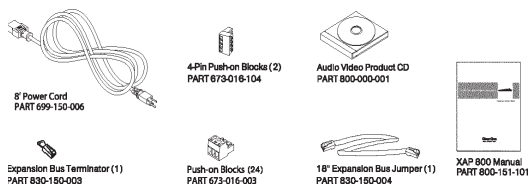

ClearOne's XAP 800 takes the revolutionary AP800 to the next level of functionality and becomes the new standard of audio conferencing performance.

Easy, effective and reliable the XAP 800 features a 12x12 matrix with level control at each cross point to simplify complex mixing operations; and 20Hz-20kHz bandwidth for full-range audio response. The XAP 800 uses ClearOne's proprietary Gentner Distributed Echo Cancellation® and noise cancellation technology.

Distributed Echo Cancellation features 130ms of tail time, which provides highly effective echo cancellation reaction time short prevents additional noise created.

NOTE: No built-in phone line on this unit.

XAP 400

Part# 910-151-201



What's included:

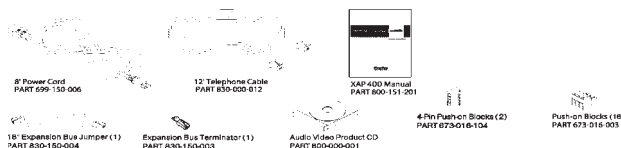

The XAP™ 400 conferencing unit combines the great features of the XAP™ 800 with a single-line digital telephone hybrid and 10W amplifier to create a stand-alone teleconferencing unit. It has four microphone inputs, a microphone mixer, echo and noise cancellation, and advanced audio processing and filters. The XAP 400 manages microphones and speakers, as well as local and auxiliary audio.

XAP TH2 Phone Interface

Part# 910-151-301



ClearOne's XAP TH2 telephone interface routes caller audio from a single analog telephone line into the XAP 800 or 400 audio conferencing systems. Up to 16 callers can be added to a conference by using 16 XAP TH2s.

An Expansion Bus port that enables it to be linked to the XAP, which can then pass control to the XAP TH2. The XAP TH2 is configured with the G-Ware software and controlled via RS-232 or through contact closures on the DB25 port. XAP TH2 can access DTMF (touch-tone) dialing through the Expansion Bus or RS-232 connection, which allows you to dial telephone numbers or issue tones to access voice mail. The XAP TH2 will also store 10 speed dial numbers.

ClearOne. INSTALLED AUDIO CONFERENCING

**GT 1524 Single Channel Echo Canceller
Part# 910-114-101**

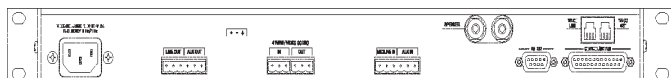

The GT1524 provides the highest possible audio quality available in a single-channel echo canceller and features a telephone interface to turn your existing audio system into a teleconferencing system. Plus, it has simultaneous two-wire/four-wire operation so you can audio conference and video conference at the same time.

The GT1524 connects to your existing system via an output from your mic mixer routed to the GT1524's line input and features a line output for an amplifier. For smaller rooms, you can simply connect to one mic and one speaker of the unit. A 5W power amp is included.

**XAP Net
Part# 910-151-150**



XAP™ Net brings Ethernet connectivity to all your XAP products. This advanced control interface gives you the freedom to access your ClearOne audio devices remotely via either local-area network or the Internet. Program your audio system or perform system diagnostics from anywhere.

**XAP IR Remote
Part# 910-170-10**



The AP IR Remote Control system operates the XAP product line. Using infrared transmission, it controls all XAP800, XAP400, and PSR1212 single and combined-unit systems. The XAP IR operates dialing, mute, connect, disconnect, and volume and is a cost effective alternative to expensive control devices.

XAP Control Panels

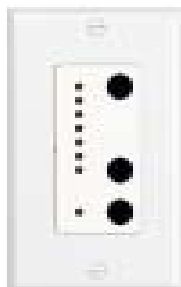

The Control Panel provides convenient control of zoning, volume, and other functions of the PSR1212, XAP800, and XAP400 and is available in two models: the Volume Control Panel and Select Control Panel.

**Select Control Panel
910-155-050**

**Volume Control Panel
910-155-051**

ClearOne. CONTROLLER & INTERFACES

**XAP Table-top controller
Part# 910-151-890**



Start and navigate an audio conference without the need for touch panel control systems, which can be expensive, complex, or intimidating to users. The dial pad on the device resembles a telephone keypad for instant familiarity, and users can dial a conference call as easily as dialing a telephone with no training required. It offers five user-definable keys to manage the most commonly-used audio conference and presentation

control functions, such as presenter mic volume up/down, lights on/off, projector on/off, screen up/down, etc. These keys are easily programmed using the included configuration builder software.

The controller comes with a 40-foot cable that connects to both the XAP and a power source, eliminating the need for batteries. Longer distances of up to 150 feet are easily achieved with standard Cat 3, Cat 5 or Cat 6 cabling. Connect directly to the XAP and send commands to third-party devices that are connected to the communications port on the XAP. Pre-printed labels with common presentation, audio conference, and room control functions apply easily to user-definable keys.

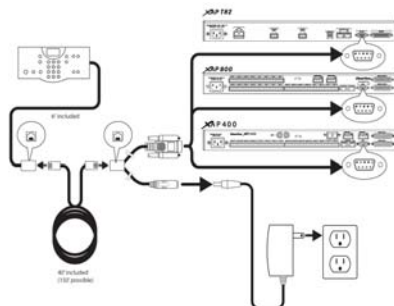

Analog-to-digital converters

**AT&T Digital to Analog Converter
910-151-050**

**Rolm Digital to Analog Converter
910-151-051**

**Nortel Digital to Analog Converter
910-151-052**

**Konnexx General Digital to Analog Converter
910-156-120**



ClearOne. MICROPHONES**Button Mic**

The Button Mic is ideal unobtrusive table top placement. Commonly used in custom applications in which mics are permanently built into the table, the button mic provides excellent pick-up range.

Button Omni-Mic Black
910-103-162

Button Uni-Mic Black
910-103-164

**Delta Mic**

910-103-340

The Delta Mic's professional design accentuates teleconferencing applications which demand high performance audio quality. Its compact size makes it ideal for conference table which require minimum visibility mics with 360-degree pickup.

**Tabletop Mic**

The Tabletop Mic is perfect for teleconferencing applications that demand high performance audio quality. Their small size makes them ideal for conference tables that require minimum visibility microphones.

Tabletop Omni-Mic
910-103-160

Tabletop Uni-Mic
910-103-161

**AccuMic II**

910-156-115

ClearOne's AccuMic II utilizes Gentner Echo Cancellation and noise cancellations to provide the clearest, most intelligible audio to enhance your video conferencing experience. Each AccuMic II contains three microphone modules and leading-edge DSP audio technology for superior sound.

AccuMic II Extension Mic

910-156-117

You can extend the audio pick-up range of the AccuMic II while maintaining sound quality by connecting an optional AccuMic II extension mic. This flexibility makes the AccuMic II a great fit in a variety of conferencing environments.

ClearOne. MICROPHONES

SOLO EXECUTIVE



- 8 Channels of 128 bit encrypted, voice optimized audio
- 1.9Ghz DECT spread-spectrum transmission
- Cardioid mics provide clarity / presence
- Up to 24 channels possible with 3 synchronized rack transceiver units
- Wearable mics allow mobility
- No cable to pull or clutter the room
- Works ideally with XAP and Converge
- 30 meter range; mic beeps to notify when out of range to prevent walk-off
- 8 hour talk time
- Includes charging base
- Global mute function
- Mini plug on mic for ear-bud (provided) allows mix-minus feed, lanuage interpretation, IFB or other applications
- SMA attenae can be remotely mounted
- Phoenix connectors

The Solo® Executive Wireless Microphone System provides unmatched audio performance in conferencing, distance learning and other mission critical applications. The system combines the advanced audio capabilities of full duplex, wideband quality with proven encryption for security in an innovative, wearable format.

It connects seamlessly to other XAP, Converge or video conferencing equipment and it can be easily managed by room control systems.

WIRELESS TABLE MIC

Part# WTM-5

5" Gooseneck

WIRELESS TABLE MIC

Part# WTM-12

12" Gooseneck

WIRELESS TABLE MIC

Part# WTM-18

18" Gooseneck



The wireless conference mic brings benefits to the boardroom, conference center or training facility.

The wireless tabletop conference mic is a free-standing gooseneck style microphone firmly anchored in place by its low-profile, elegantly designed base. Turn the base over to reveal the specially designed compartment for housing the supplied transmitter. Place the easy-to-use microphone anywhere required.

No longer do you have to drill holes in tables, trench or core floors, run long cables or compromise the architectural integrity of an installation. Also available in an audio-encrypted version for applications that require secure voice information (medical, government & high profile corporation applications).

WIRELESS TABLE MIC

Part# STM-5

950-Channel Agile ENCRYPTED 5" Gooseneck

WIRELESS TABLE MIC

Part# STM-12

950-Channel Agile ENCRYPTED 12" Gooseneck

WIRELESS TABLE MIC

Part# WTM-18

950-Channel Agile ENCRYPTED 18" Gooseneck

- RM-D** Dual rackmount adaptor for wireless tabletop mic
- RM-S** Single rackmount adaptor for wireless tabletop mic

ClearOne. MICROPHONE & XAP / CONVERGE BUNDLES

Get special pricing when you order these configured bundles for you conference room project.



Polar Choice Satellite

Wireless Table *multi-pattern!* **Goosenecks**

SCM-1A: 4- EV PC Satalite Table Mics & XAP400

SCM-1B: 8- EV PC Satalite Mics & XAP800

SCM-1C: 7- EV PC Satalite Mics, 1Presenter Wireless Lav & XAP800

SCM-1D: 8- EV PC Satalite Mics, 1Presenter Wireless Lav & Converge 590

Inset Button Omni or Uni

SCM-2A: 4- Button Mics & XAP400

SCM-2B: 8- Button Mics & XAP800

SCM-2C: 7- Button Mics, 1Presenter Wireless Lav & XAP800

SCM-2D: 6- Button Mics & Converge 560



Table-top Microphones

SCM-3A: 4- Table-top Mics & XAP400

SCM-3B: 8- Table-top Mics & XAP800

SCM-3C: 7- Table-top Mics, 1Presenter Wireless Lav & XAP800

SCM-3D: 6- Table-top Mics & Converge 560

SCM-3E: 9- Table-top Mics & Converge 590

SCM-3F: 8- Table-top Mics, 1Presenter Wireless Lav & Converge 590



ClearOne.

MICROPHONE & XAP / CONVERGE BUNDLES

360 degree DELTA Table Mics

- SCM-4A: 1- Delta Mic & XAP400
- SCM-4Ax: 1- Delta Mic, 1 Podium or Head Table Gooseneck & XAP400
- SCM-4B: 2- Delta Mics & XAP800
- SCM-4Bx: 2- Delta Mics , 1Presenter Wireless Lav, 1 Podium/Table Gooseneck & XAP800



Gooseneck Table-top Microphones

- SCM-5A: 4- Gooseneck Mics & XAP400
- SCM-5B: 8- Gooseneck Mics & XAP800
- SCM-5Bx: 7- Goosenecks, 1Presenter Wireless Lav & XAP800
- SCM-5C: 4- Gooseneck Mics w/ Switch & XAP400
- SCM-5D: 8- Gooseneck Mics w/ Switch & XAP800



Hanging Ceiling Microphones

Ceiling mics may have to be used to cover general areas in meeting hall seating or in multi-purpose rooms that have flexible furniture set-ups and cabling to tables is not permitted.

Ceiling mics are not recommended as best practice in most conference rooms because the distance from talker-to-mic results in added "roominess" and an increase in background noise. For an example of how distance from a mic affects sound, visit- <http://clearone.com/solutions/professional.php?content=main> and click the Audio Demo Link. If a client accepts the possibility that the sound may be affected and still wants "no mics on the table", then ceiling mics may satisfy the situation.

- SCM-7A: 4- Hanging Mics (white - W or black-B) & XAP400
- SCM-7B: 8- Hanging Mics & XAP800
- SCM-7Bx: 7- Hanging Mics 1Presenter Wireless Lav & XAP800



EV Re92H available in WHITE or BLACK

ClearOne. MICROPHONE & XAP / CONVERGE BUNDLES

Wireless Personal Conference Mics

SCM-8A: 8 Revolabs Solo Mics & XAP800

SCM-8B: 16 Revolabs Solo Mics & 2- XAP800

SCM-8C: 24 Revolabs Solo Mics & 3 XAP800

SCM-8D: 8 Revolabs Solo Mics & Converge 590

SCM-8E: 8 Revolabs Solo Mics, 1 Gooseneck mic & Converge 590



The companion price list to this product guide is available to all ClearOne franchised resellers in PDF format at www.Starin.biz.

The best way to keep current is to download prices on-line.

ClearOne. SOUND REINFORCEMENT DIGITAL SIGNAL PROCESSOR

PSR1212
910-155-001



The PSR1212 is a highly advanced 12x12 digital matrix mixer with audio processing. It features 32 user-definable presets to quickly adapt to a variety of sound reinforcement and room-combining applications in auditoriums, theaters, gymnasiums, hotel/convention venues, conference rooms, training rooms.

Advanced G-Ware software allows you to customize all input, output, and processing parameters. You can route any input to any output. Basic functions can be controlled remotely with the optional ClearOne Control Panel or other control unit.

The PSR1212 features eight audio processing buses, each with 15 configurable filters, compressors, and delay capability to tailor the PSR1212's audio response to optimize the audio quality and fidelity.

Back Panel:

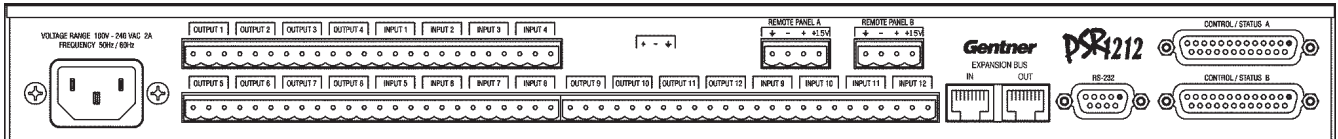

Hotel/Convention Center Room-Combine System Example

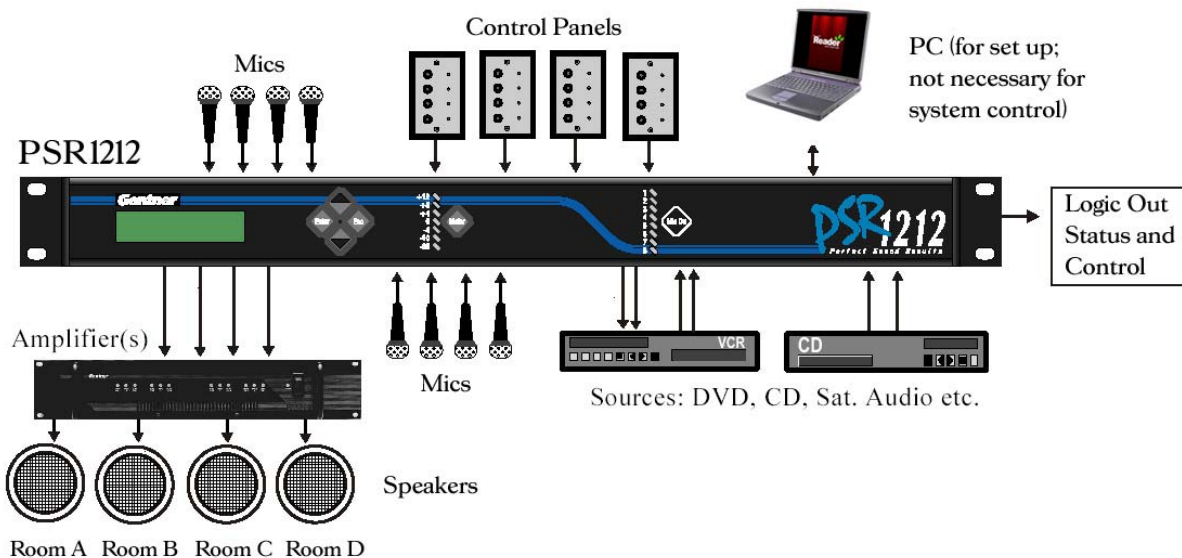

ClearOne. SET-TOP VIDEO CONFERENCING CARTS

DST™ Monitor Cart

ClearOne DST Monitor Carts provide superior strength and mobility at an unbelievable price. More than 22" of interior cabinet depth offers plenty of room for peripheral equipment. The mobility and value of the ClearOne DST cart make it ideal for large corporate or educational facilities where resources are limited and must often be shared among multiple rooms. The DST easily supports up to 36" monitors for use in videoconferencing areas, training rooms and distance-learning classrooms. It also features generous cabinet space for mounting AV equipment.

911-171-271

DST Wood Economy Monitor Cart

911-171-271-12

12-Pack of DST

911-171-271-24

24-Pack of DST

Set Top Video Conference Carts

The Set Top Video Conferencing Carts were specifically designed to meet the needs of the new set top conferencing units. The rounded look gives this cart a sleek appearance that is welcome everywhere from the training room to the boardroom. With more than 20" of depth in the interior cabinet, there is room for your VCR and other peripheral equipment.

911-171-012

27" Monitor Cart, curved front, grommet back, fits 27" and Wega 24" monitors

911-171-013

32" Monitor Cart, curved front, grommet back, fits 32" and Wega 27" monitors

911-171-014

35" Monitor Cart, curved front, grommet back, fits 35/36" and Wega 32" monitors

911-171-015

38" Monitor Cart, curved front, grommet back, fits Wega 36" monitor

Standard Video Conference Carts

ClearOne's Standard Video Conferencing Carts are built for maximum strength, durability, and versatility. These carts are specifically designed to hold monitors and large equipment. They have a deeper equipment enclosure to allow space for deeper legacy codecs or tower systems.

911-171-040

27" Monitor Cart, vented back panel, fits 27" and Wega 24" monitors

911-171-041

32" Monitor Cart, vented back panel, fits 32" and Wega 27" monitors

911-171-042

35" Monitor Cart, vented back panel, fits 35/36" and Wega 32" monitors

ClearOne.
HIGH-BOY CARTS, AV & DOCUMENT CAMERA CARTS

Highboy AV Carts

The Highboy AV Cart is perfect for front of the room applications. At a 42" clearance, this cart allows easy viewing in any training or classroom environment. With over 26" of interior cabinet height and a depth of 23", there is plenty of room for all your AV equipment.

911-171-060

Highboy AV Cart for up to 32" monitor, 42" tall, with fixed peripheral shelf

911-171-061

Highboy AV Cart for up to 35" monitor, 42" tall, with fixed peripheral shelf

911-171-062

Highboy AV Cart for up to 36" Wega monitor, 42" tall, fixed peripheral shelf

AV Carts

Clearone's AV Carts were built to integrate design, function, and affordability. Unlike most standard industry carts, ClearOne's carts are portable and extremely durable. All of our AV Carts are 33" high to allow easy viewing over most industry standard 30" furniture.

911-171-070

20" Monitor Cart, fixed peripheral shelf, grommet back

911-171-071

27" Monitor Cart, fixed peripheral shelf, grommet back, fits 27" and Wega 24" montiors

911-171-072

32" Monitor Cart, fixed peripheral shelf, grommet back, fits 32" and Wega 27" montiors

911-171-073

35" Monitor Cart, fixed peripheral shelf, grommet back, fits 35/36" and Wega 32" montiors

911-171-074

38" Monitor Cart, fixed peripheral shelf, grommet back, fits Wega 36" monitor

Document Camera Carts

Document Camera Carts are offered in two different configurations, standard and trapezoid, which are stylish as well as versatile. Designed for use with document cameras, these carts can be used with a wide variety of electronic peripheral equipment.

911-171-120

Standard Document Camera Cart, grommet back

911-171-121

Trapezoid Top Document Camera Cart, grommet back

ClearOne. DUAL MONITOR & PROJECTOR CARTS



Dual Monitor Carts

These carts provide the stable surface you need for a variety of electronic equipment. Available in 27" and 32", as well as in Highboy versions of the same size.

911-171-136

Dual 27" Monitor Cart, with heavy duty casters

911-171-137

Dual 32" Monitor Cart, with heavy duty casters

911-171-138

Dual 27" Highboy Monitor Cart, 42" Tall with heavy duty casters

911-171-139

Dual 32" Highboy Monitor Cart, 42" Tall with heavy duty casters



Standard Projector Carts

Projectors are an integral part of most training centers these days. That's why ClearOne offers a wide choice of LCD carts that make sense, incorporating style, value, and utility. We offer two distinct choices, standard and deluxe. All of these carts come standard with 19 1/8" internal dimensions, allowing them to be fitted with rack rail for equipment storage. We also offer these units in different heights, allowing you to best match the projector height to your screen.

911-171-140

29" Tall Projector Cart square top

911-171-141

38" Tall Projector Cart square top

911-171-142

36" Tall Projector Cart with trapezoid top

911-171-143

44" Tall Projector Cart with trapezoid top

ClearOne. FLAT PANEL CARTS



Plasma Carts

ClearOne's Plasma Carts are designed to fit 42" and 50" flat panel monitors. At a depth of 24", they are narrower than our standard line to better match the sleeker profile of today's plasma screens. These carts are also available in a depth of 29" so you can choose the one that meets your equipment storage needs.

911-171-090

42" Plasma Monitor Cart, 24" deep, grommet back, peripheral shelf

911-171-091

50" Plasma Monitor Cart, 24" deep, grommet back, peripheral shelf

911-171-092

42" Plasma Monitor Cart, 29" deep, vented back, peripheral shelf

911-171-093

50" Plasma Monitor Cart, 29" deep, vented back, peripheral shelf



Plasma Pedestals

Plasma Pedestals are an attractive and convenient way to store video equipment for use with a wall-mounted screen. Their double bay systems were created with storage in mind.

911-171-102

42" Plasma Monitor Pedestal, 29" deep, vented back

911-171-103

42" Plasma Monitor Pedestal, 29" deep, vented back

Conferencing Furniture Accessories

911-171-305

Locks for smoke plexiglass doors

911-171-306

Extra adjustable internal shelf

911-171-308

Rack Rails

911-171-309

Additional smoked plexiglass door

ClearOne. RACK CARTS



Rack Carts

Rack Rail systems are offered in a wide variety of wood grains and solid colors, allowing them to blend into any environment. The Rack Carts are available with many options including locking doors, wheels, and back vents.

911-171-200

AV Rack Cart, 12 rack unit, 20" internal depth

911-171-201

AV Rack Cart, 16 rack unit, 20" internal depth

911-171-202

AV Rack Cart, 20 rack unit, 20" internal depth

911-171-207

VC Rack Cart, 12 rack unit, 24" internal depth

911-171-208

VC Rack Cart, 16 rack unit, 24" internal depth

911-171-209

VC Rack Cart, 20 rack unit, 24" internal depth

911-171-181

Mobile Rack Shell, 12 space rack unit, 15" internal depth

911-171-182

Mobile Rack Shell, 16 space rack unit, 15" internal depth

911-171-203

8 Space Rack Shell, 18" internal depth

911-171-204

12 Space Rack Shell, 18" internal depth

911-171-205

16 Space Rack Shell, 18" internal depth

911-171-206

20 Space Rack Shell, 18" internal depth

ClearOne. SECURE CABINET & TABLES

Secure Cabinet

911-171-280

The Secure Cabinet houses a 32" monitor and set top video conferencing system. This attractive cabinet offers the added security of a lockable microphone pod pullout and a 1/2" Lexan monitor cover.

Tables

Your table is not only the visual focus of a meeting or video conference, it also affects the communication dynamics. Meeting Room Tables are designed in a variety of shapes and sizes to help create an optimal environment for your meetings. Training Tables are designed to be durable enough for factory training rooms and lunchrooms. And with your choice of laminates, they are elegant enough for high-visibility training rooms. All have modesty panel and provisions for cable management.



911-171-240

5-Person Trapezoid Table

911-171-241

7-Person Trapezoid Table

911-171-242

9-Person Trapezoid Table

911-171-245

48" Round Table, seats 4

911-171-246

60" Round Table, seats 6

911-171-250

96" Race Track Table (oval), seats 8

911-171-251

120" Race Track Table (oval), seats 10

911-171-260

54" Wide Training Table

911-171-261

72" Wide Training Table

ClearOne. SET-TOP MOUNTING KITS**Set Top Shelf Kits**

The Set Top Shelf Kit is a discrete way to mount your video conferencing equipment. It comes with a black powder coated finish, and is made from heavy-duty aluminum alloy. Included with the kit are four holding pins to secure your video conferencing unit and wiring knockouts that allow for wiring through the back or bottom of the shelf.

911-171-299

Video Conferencing Set Top Shelf for a PTZ camera, wall mount

911-171-300

Video Conferencing Set Top Shelf for a Polycom ViewStation

**Plasma Set Top Mounting Kits**

The Plasma Set Top Mounting Kit includes telescoping extension tubes that allow for adjustment between 42 and 60 inches. Cable can be run through hollow extension tubes to hide unsightly cables. A Set Top Shelf Kit is included for mounting teleconferencing equipment atop the extension arm.

911-171-298

Video Conferencing Set Top Mounting Kit, fits 42-60" plasma screens, with telescoping pole and PTZ shelf

911-171-302

Video Conferencing Set Top Mounting Kit, fits 42-60" plasma screens, with telescoping pole and shelf for Polycom ViewStation

**ClearOne. PARTS****Part No. Products****Professional Audio Conferencing Spare Parts and Accessories**

830-150-003 Cable Assy RJ-45 Term. Black, AP10/AP800 (G-Link Terminator)

673-016-003 Connector Term Block/F Euro 3P (Phoenix Connector)

673-016-104 Connector Term Block/F Euro 4P (Phoenix Connector)

RAV Spare Parts and Accessories

910-153-050 RAV Remote Antenna accessory kit

Conferencing Phone Spare Parts and Accessories

910-158-041 Replacement Max EX Base (North America, Brazil, Taiwan) - includes 25' cable assembly.

910-158-042 Replacement Max EX Base (all other countries) - incl.25' cable assembly. Country specific power cord req.

592-158-002 Battery Pack 7.2 V 2200 MAH for Max Wireless Phones

592-158-001 Battery Pack 7.2 V 1800 MAH for Max Wireless Phones

910-158-020 Power Supply 120VAC/12VDC Center Pin Straight for Max Wireless WDCT

910-158-021 Power Supply 220VAC/12VDC Euro-Type Center Pin Straight for Max Wireless DECT

910-158-022 Power Supply 220VAC/12VDC UK-Type Center Pin Straight for Max Wireless DECT

910-158-023 Power Supply 220VAC/12VDC South Africa-Type Center Pin Straight for Max Wireless DECT

910-158-024 Power Supply 220VAC/12VDC Australia-Type Center Pin Straight for Max Wireless WDCT \$

830-158-005 Cable Assembly RJ-45/RJ-45 12 Ft

830-000-012 Cable Assembly Telephone 12 Ft

830-158-002 Cable Assembly RJ-45/RJ-45 25 Ft

699-158-001 Power Cord Euro Type 3-Pin Figure 8

699-158-002 Power Cord UK Type 3-Pin Figure 8

699-158-003 Power Cord Australia-Type 3-Pin Figure 8

699-158-004 Power Cord South Africa-Type 3-Pin Figure 8 C

699-158-005 Power Cord Switzerland-Type 3

699-158-015 Power Cord US-Type 3-Pin Figure 8 \$

AccuMic Spare Parts

830-156-003 Cable Assembly AccuMic VC, 10-Pin Mini Din to 4-Plug RCA

551-156-005 Power Supply 100-240V, 50/60HZ in line AccuMic VC

830-157-001 Cable Assembly AccuMic PC, 10-Pin Mini Din to 3.5 mm

830-156-001 Cable Assembly Mini Din, 8 PM (2), 10'

Camera Spare Parts and Accessories

910-171-320 FlexLite Flexneck top lights that attach to camera base (NTSC 110V)

910-171-474 3.5 mm C-Mount Lens For StudentCam, TeachCam and IDCam

910-171-476 6 mm C-Mount Lens For StudentCam, TeachCam and IDCam

910-171-478 8 mm C-Mount Lens For StudentCam, TeachCam and IDCam

910-171-482 Zoom 6-15 mm C-Mount Lens For StudentCam, TeachCam and IDCam

910-171-484 16 mm C-Mount Lens For StudentCam, TeachCam and IDCam

910-171-327 Microscope Eyepiece Adapter Metal

910-171-326 Microscope Couplers 26mm, 28mm & 34mm, plastic

910-171-434 Cable Snap & Click 5 Ft #A05013

910-171-435 Cable Snap & Click 25 Ft #A05014

551-171-001 Power Supply n Univ DC Out 12VDC 0.534A

551-171-001-01 Plug Power No. Amer Clip Use w/ 551-171-001

551-171-001-02 Plug Power Euro Clip use w/ 551-171-001

551-171-001-03 Plug Power UK Clip use w/ 551-171-001

662-171-002 Connector Pigtail Adapter SVHS-F to RCA Plug

662-171-003 Connector Plug Adapter BNC to RCA jack



Professional AV Representatives

CentricAV
P: 509-363-1500
F: 509-363-1501

Pro Tech Marketing
P: 801-561-8844
F: 801-561-9969

Starin Marketing, Inc.
P: 219-929-4127
F: 219-929-4377

Progressive Audio Sales
P: 707-751-1626
F: 707-751-1697

Sonic Sales
P: 310-322-3333
F: 310-322-3334

TOTAL Marketing
P: 817-560-3970
F: 817-560-9923

Nu-Way Technologies
P: 334-222-8950
F: 334-222-4317

BC Electronics Sales Inc
P: 913-962-1990
F: 913-962-0718

