

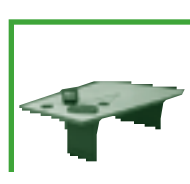

VIDEOLABS[®]
*Furniture For Today's
 Technology*





A/V Carts

RC-HB

Highboy A/V Carts



VideoLabs' Highboy A/V Carts are perfect for front of the room applications. At a head clearing 42", these carts allow easy viewing in any training or classroom environment. With over 26" of interior cabinet height and a depth of 23", there is plenty of room for all your A/V equipment.

Features

- 5" twin wheel casters for easy maneuvering
- Monitor strap to keep monitor securely in place
- Standard rubber bumper edge molding
- Built-in peripheral shelf
- Smoked Plexiglass® doors
- Removable vented back panel

Part Number	Description
RC-CART-32HB	Highboy A/V Cart for up to 32" monitor
RC-CART-35HB	Highboy A/V Cart for 35" monitor
RC-CART-43HB	Highboy A/V Cart for 43" monitor (34" tall)

**See foldout for options and laminate colors.*

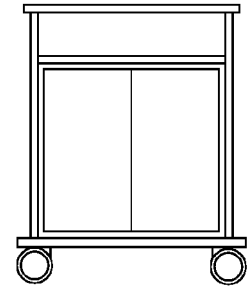

RC-AV

A/V Carts



VideoLabs' A/V Carts were built to integrate design, function and affordability. Unlike most standard industry carts, VideoLabs' carts are truly portable and extremely strong. All of our A/V Carts are 33" high to allow easy viewing over most industry standard 30" furniture.

Features

- 5" twin wheel casters for easy maneuvering
- Monitor strap to keep monitor securely in place
- Built-in peripheral shelf
- Adjustable internal shelf
- Smoked Plexiglass doors
- Two back grommets for flexible wiring

Part Number	Description
RC-CART-20AV	20" monitor cart
RC-CART-27AV	27" monitor cart
RC-CART-32AV	32" monitor cart
RC-CART-35AV	35" monitor cart
RC-CART-43AV	43" monitor cart (26" tall)

** See foldout for options and laminate colors.*

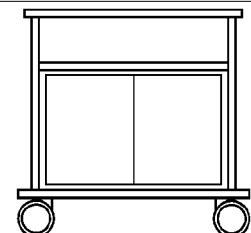

Plasma Carts and Pedestals



Plasma Carts

RC-CART-PL

VideoLabs' Plasma Carts are designed to fit 42" and 50" flat panel monitors. At a depth of 24", they are narrower than our standard line to better match the sleeker profile of today's plasma screens. These carts are also available in a depth of 29" so you can choose the one that meets your equipment storage needs.

Features

- Stationary peripheral opening
- Adjustable interior shelves
- Smoked Plexiglass doors
- 5" twin wheel casters for easy maneuvering
- Standard rubber bumper edge molding
- Dual 19 1/8" equipment bays
- Top and back grommets for flexible wiring options
- Optional rack rails available

Part Number	Description
RC-CART-42PLST	42" Plasma Cart – 24" deep; grommet back
RC-CART-50PLST	50" Plasma Cart – 24" deep; grommet back
RC-CART-42PL	42" Plasma Cart – 29" deep; vented back
RC-CART-50PL	50" Plasma Cart – 29" deep; vented back

** See foldout for options and laminate colors.*

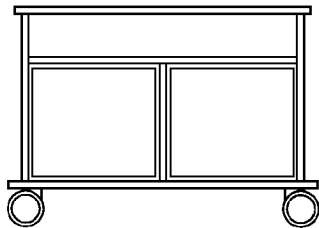

Plasma Pedestals

RC-PED-PL

VideoLabs' Plasma Pedestals are the answer when you are looking for a place to store your equipment when using a wall mounted screen. Their double bay systems were created with storage in mind.

Features

- Optional rackrails available
- Smoked Plexiglass doors
- Dual 19 1/8" equipment bays
- Top and back grommets for flexible wiring options

Part Number	Description
RC-PED-42PLST	42" Plasma Pedestal – 24" deep; grommet back
RC-PED-50PLST	50" Plasma Pedestal – 24" deep; grommet back
RC-PED-42PL	42" Plasma Pedestal – 29" deep; vented back
RC-PED-50PL	50" Plasma Pedestal – 29" deep; vented back

** See foldout for options and laminate colors.*

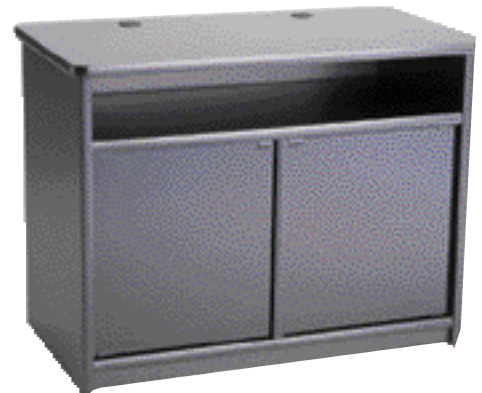
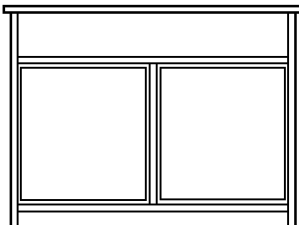

Set Top Videoconferencing and Standard Videoconferencing Carts

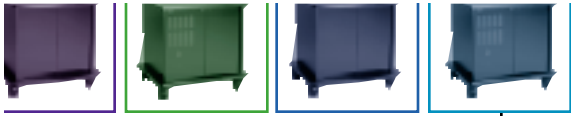

RC-ST

Set Top VC Carts



VideoLabs' Set Top Videoconferencing Carts were specifically designed to meet the needs of the new set top conferencing units. The rounded look gives this cart a sleek appearance that is welcome everywhere from the training room to the boardroom. With more than 20" of depth in the interior cabinet, there is room for your VCR and other peripheral equipment.

Features

- Smoked Plexiglass doors
- 5" twin wheel casters for easy maneuvering
- Standard rubber bumper edge molding
- Full rear panel with two grommets for easy pass-through for your cables

Part Number	Description
RC-CART-2029ST	Open cart for up to a 29" monitor
RC-CART-20ST	20" monitor cart
RC-CART-27ST	27" monitor cart
RC-CART-32ST	32" monitor cart
RC-CART-35ST	35" monitor cart
RC-CART-43ST	43" monitor cart (26" tall)
RC-CART-27STSS	27" speaker system ready cart
RC-CART-32STSS	32" speaker system ready cart
RC-CART-35STSS	35" speaker system ready cart
RC-CART-32WEGAST	Cart for a 32" Sony® Wega monitor (flat front)
RC-CART-36WEGAST	Cart for a 36" Sony® Wega monitor (flat front)

* See foldout for options and laminate colors.

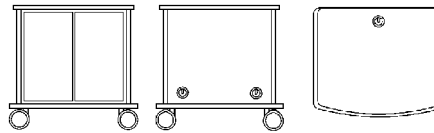

RC

Standard VC Carts



VideoLabs' Standard Videoconferencing Carts are built for maximum strength, durability and versatility. These carts are specifically designed to hold monitors and large equipment. They have a deeper equipment enclosure to allow space for deeper legacy codecs or tower systems.

Features

- Smoked Plexiglass doors
- 5" twin wheel casters for easy maneuvering.
- Standard rubber bumper edge molding.
- Weighted, wide base for stability.
- Rear panel has venting for heat producing equipment.

Part Number	Description
RC-CART-27	27" monitor cart
RC-CART-32	32" monitor cart
RC-CART-35	35" monitor cart
RC-CART-43	43" monitor cart (26" tall)
RC-CART-27SS	27" speaker system ready cart
RC-CART-32SS	32" speaker system ready cart
RC-CART-35SS	35" speaker system ready cart
RC-CART-32WEGA	Cart for a 32" Sony Wega monitor (flat front)
RC-CART-36WEGA	Cart for a 36" Sony Wega monitor (flat front)

* See foldout for options and laminate colors.

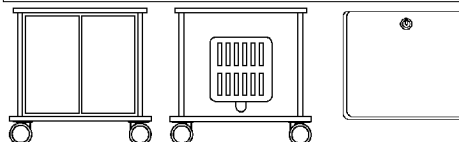

Document Camera Carts and Dual Monitor Pedestals

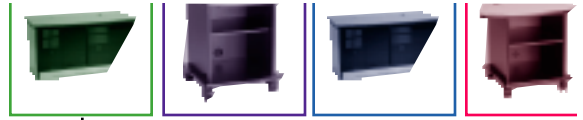

Doc Carts

RC-DOC

VideoLabs' Document Camera Carts are offered in three different configurations which are stylish as well as versatile. Designed for use with document cameras, these carts can be used with a wide variety of electronic peripheral equipment.

Features

- High-grade medium and high-density fiberboard construction
- Finished standard in black laminate and melamine
- Top and back grommets for flexible wiring options
- Adjustable laminated shelf
- Premium 4" casters for easy maneuvering

Part Number	Description
RC-DOC-EC	Standard Document Camera Cart
RC-DOC-TRAP	Trapezoid Top Document Camera Cart
RC-DOC-29LM	Document Camera Cart with folding extension leaves

** See foldout for options and laminate colors.*

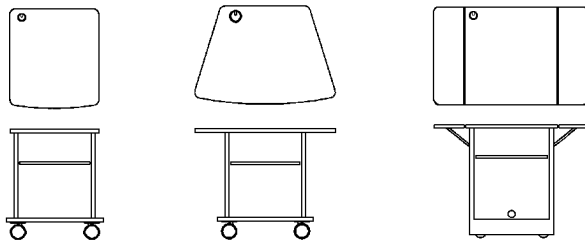

Models RC-DOC-EC and RC-DOC-TRAP shown.

Pedestals

RC-PED

VideoLabs' Pedestals provide the stable surface you need for a variety of electronic equipment. Designed to hold larger monitors, these sturdy units also provide ample interior storage for peripheral electronics and meeting supplies. These pedestals are built with an integrated framing technique that ensures maximum strength and stability.

Features

- High-grade medium and high-density fiberboard construction
- All surfaces are laminated for strength, stability and durability
- Smoked Plexiglass doors
- Cable grommet on top ensures simple cabling access
- Dual rear removable vented back panels
- Standard rubber bumper edge molding
- 33" in height for easy viewing in any conferencing environment

Part Number	Description
RC-PED-227	Dual 27" monitor pedestal
RC-PED-232	Dual 32" monitor pedestal
RC-PED-235	Dual 35" monitor pedestal
RC-PED-227SS	Dual 27" monitor pedestal; speaker opening
RC-PED-232SS	Dual 32" monitor pedestal; speaker opening
RC-PED-235SS	Dual 35" monitor pedestal; speaker opening

** See foldout for options and laminate colors.*

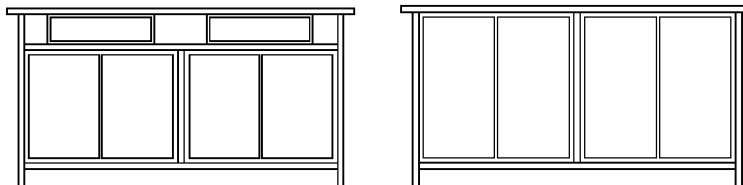

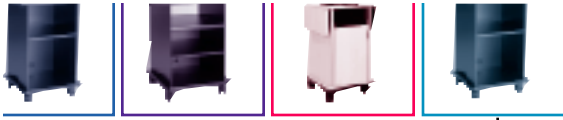

LCD Carts

Projectors are an integral part of most training centers these days. That's why VideoLabs offers a wide choice of LCD carts that make sense, incorporating style, value and utility. We offer three distinct choices, and all of those have the flexibility to be customized from our list of standard options. All of these carts come standard with 19 1/8" internal dimensions, allowing them to be fitted with rack rail for equipment storage. We also offer these units in different heights, allowing you to best match the projector height to your screen.

RC-PROJ-EC Standard LCD Cart



Part Number	Description
RC-PROJ-EC29	29" tall projector cart
RC-PROJ-EC38	38" tall projector cart

**See foldout for options and laminate colors.*

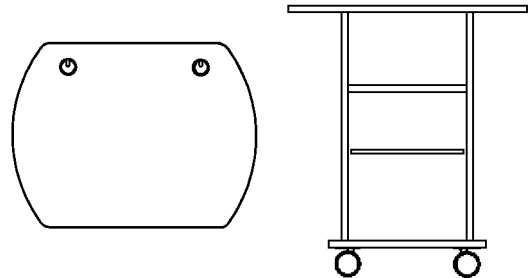

RC-PROJ-TT Deluxe LCD Cart



Part Number	Description
RC-PROJ-TT36	36" tall projector cart; trapezoid top
RC-PROJ-TT44	44" tall projector cart; trapezoid top

**See foldout for options and laminate colors.*

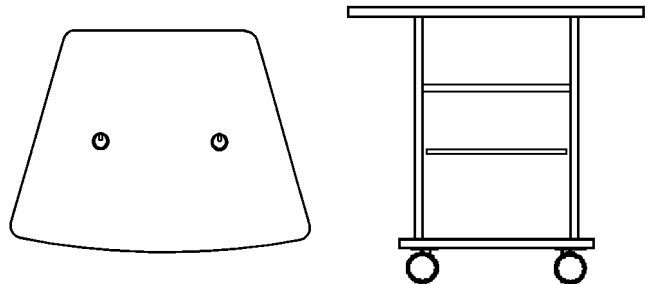

RC-PROJ-WD Premium LCD Cart



Part Number	Description
RC-PROJ-WD36	36" tall projector cart; extension leaves; door
RC-PROJ-WD44	44" tall projector cart; extension leaves; door

**See foldout for options and laminate colors.*

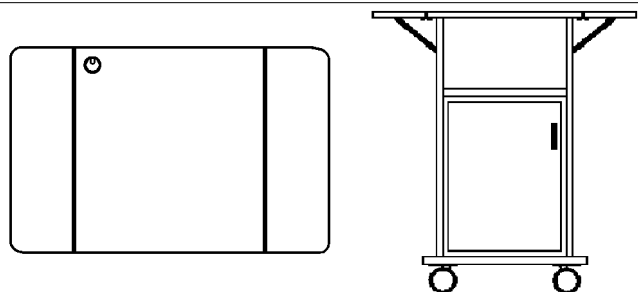

LCD/Overhead Carts



Overhead Cart

RC-OH

VideoLabs' Overhead Projector Cart is ideal for most overhead applications. There is plenty of room on the oversized top surface to hold presentation materials. The interior bay is ready for rack rails or could be used to store the overhead when it's not in use.

Features

- Premium 4" casters for easy mobility
- Stain and scratch resistant melamine construction
- Standard rubber edge molding
- Adjustable shelf

Part Number	Description
RC-OH	Overhead projector cart

**See foldout for options and laminate colors.*

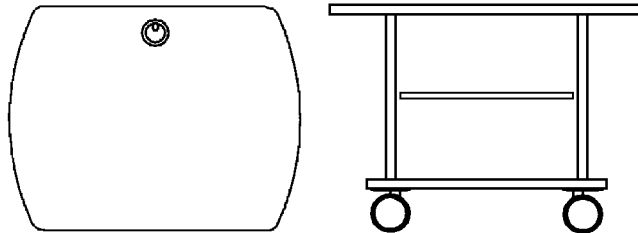

Dual LCD/Overhead Cart

RC-OH-LCD

VideoLabs' LCD/Overhead Projector Cart has a handy split-top surface for ideal projection height from both projectors. The cabinet interior has two 19 1/8" storage bays with doors – both bays are perfect for either storing the projectors, or for mounting rack rail to hold peripheral electronics.

Features

- Premium 4" casters for easy mobility
- Smoked Plexiglass doors
- Stain and scratch resistant melamine construction
- Standard rubber edge molding
- Built-in peripheral shelf for storage
- Rounded top surface
- Single adjustable shelf

Part Number	Description
RC-OH-LCD	Combination overhead and LCD projector cart

**See foldout for options and laminate colors.*

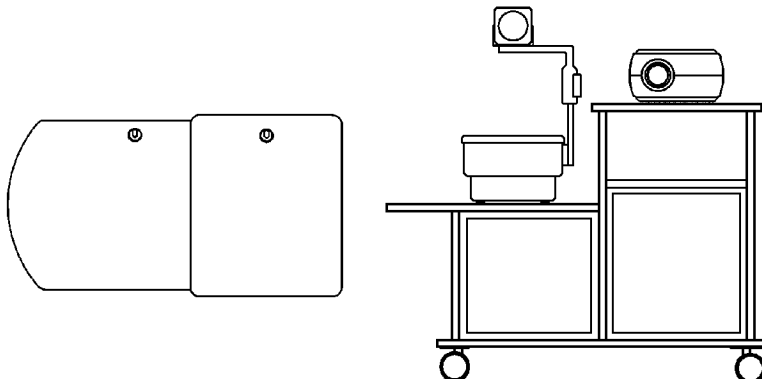



Presenter and Solo Stations

RC-PS

Presenter Station

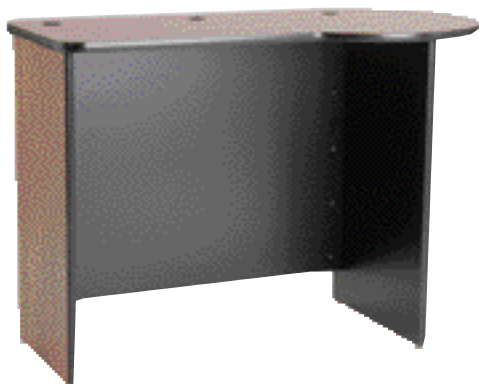

VideoLabs' Presenter Station is as stylish as it is versatile. Designed for today's technology-driven presenters, the ergonomic design allows plenty of space to lay out your presentation and still have room for your laptop and LCD projector. This panel-based system is available with a roll under storage unit in a variety of styles equipped with wheels for easy mobility.

Features

- Spacious 60" wide work surface
- 3 top grommets for easy cabling
- Durable, stain and scratch resistant melamine surface

Part Number

RC-PS

Description

Presenter Station

Presenter Station Accessories

12-RR	Rack Rail Cart – 12 space
16-RR	Rack Rail Cart – 16 space
12-RS	Adjustable Shelf Cart – 2 shelf
16-RS	Adjustable Shelf Cart – 3 shelf
12-RD	Drawer Stack Cart – 3 drawer
16-RD	Drawer Stack Cart – 4 drawer

* See foldout for options and laminate colors.

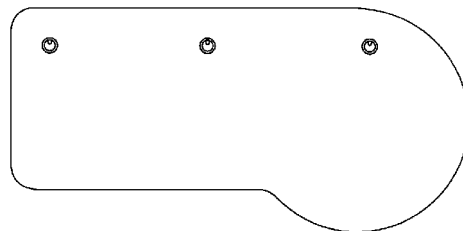
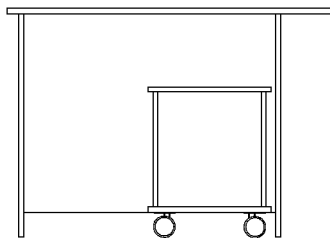

RC-PS-SOLO

Solo Station



VideoLabs' Solo Station was designed to look great in any presentation environment. An ideal size for a teacher or presenter, this unit has a modern shape that provides a wrap around work space.

Features

- Built-in peripheral shelf
- 2 top grommets for easy cabling
- Panel based system
- Durable, stain and scratch resistant melamine surface

Part Number

RC-PS-SOLO

Description

Solo Station – 48" wide top

* See foldout for options and laminate colors.

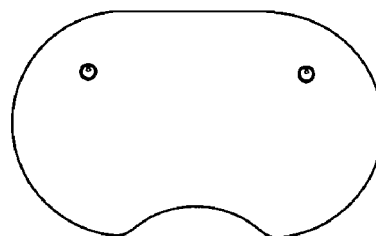
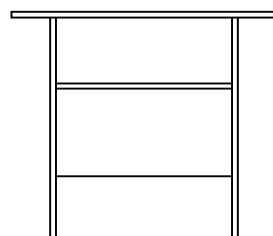

Rack Carts and Racks

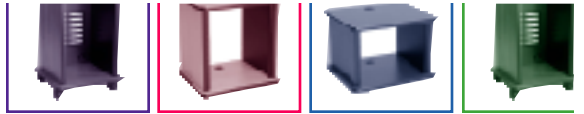

Rack Carts

RC-RK

If you are looking for an affordable and stylish option to the metal rack rail carts you have found – this is it! VideoLabs' Rack Rail systems are offered in a wide variety of woodgrains and solid colors, allowing them to blend into any environment. Offered with many options including locking doors, wheels and back vents. If you don't see what you like, remember, we do custom work and can easily adapt any of these to meet your specific needs.

<u>Part Number</u>	<u>Description</u>
RC-CART-RK12	Rack Cart – 12 space
RC-CART-RK16	Rack Cart – 16 space
RC-CART-RK20	Rack Cart – 20 space

**See foldout for options and laminate colors.*

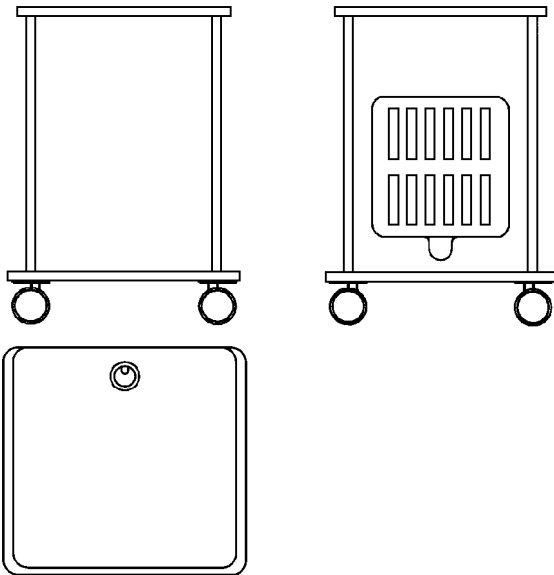

Racks

RC-RACK

<u>Part Number</u>	<u>Description</u>
RC-RACK-8	Rack Shell – 8 space
RC-RACK-12	Rack Shell – 12 space
RC-RACK-16	Rack Shell – 16 space
RC-RACK-20	Rack Shell – 20 space

** See foldout for options and laminate colors.*

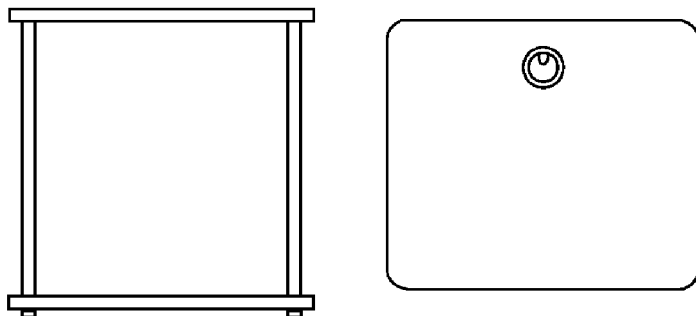

Models RC-RACK-8 and RC-RACK-12 shown.

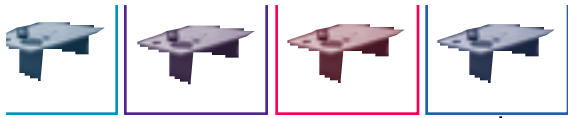

Tables and Credenzas

RC-TBL, R, & RT

Tables

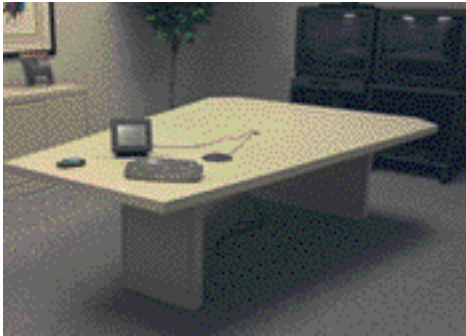

Your table is not only the visual focus of a meeting or videoconference, it also affects the communication dynamics. Your table's shape, size and finish determine how well people are seen and heard and how well communication flows between meeting participants. VideoLabs' Meeting Room Tables are designed in a variety of shapes and sizes to help create an optimum environment for your meetings. VideoLabs' Training Tables are designed to be durable enough for factory training and lunchrooms, yet with your choice of laminates, they are elegant enough for high visibility training rooms. All have a modesty panel and provisions for cable management.

Features

- A special integrated framing technique ensures stability and rigidity
- High-grade medium and high-density fiberboard construction
- All surfaces laminated for strength, stability and durability
- Lineal edge is standard for smooth, finished look

Part Number	Description
RC-TBL-5	Trapezoid Videoconferencing Table – 5 person
RC-TBL-7	Trapezoid Videoconferencing Table – 7 person
RC-TBL-9	Trapezoid Videoconferencing Table – 9 person
RC-R48	48" Round Table
RC-R60	60" Round Table
RC-RT96	96" Race Track Table
RC-RT120	120" Race Track Table
RC-TT5427	54" Training Table
RC-TT7224	72" Training Table

* See foldout for options and laminate colors.

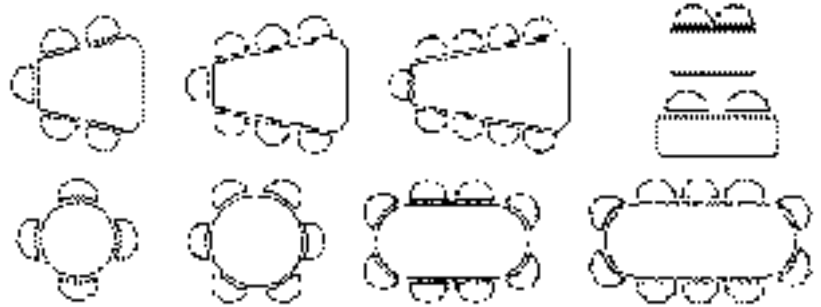

RC-CRD

Credenzas

VideoLabs' Credenzas provide the stable surface you need for a variety of electronic equipment. The perfect design for telephone, fax machines and other meeting room tools. These sturdy units also provide ample interior storage for peripheral electronics and meeting supplies. Built with an integrated framing technique that ensures maximum strength and stability.

Features

- High-grade medium and high-density fiberboard construction
- All surfaces are laminated for strength, stability and durability
- Adjustable internal shelves

Part Number	Description
RC-CRD-36LM	36" Standard Credenza
RC-CRD-54LM	54" Standard Credenza
RC-CRD-72LM	72" Standard Credenza

* See foldout for options and laminate colors.



Furniture Options

Model Number	Internal Dimensions			External Dimensions					Accessories										
	Width	Height	Depth	Width (Top)	Width (Bottom)	Height	Depth (Top)	Depth (Bottom)	Adjustable Shelf	Fixed Peripheral Shelf	Exposed Speaker Shelf	Back Vent	Doors	Door Locks	Extra Internal Shelf	Monioir Tie Down	Rack Rails	Custom Laminate	Casters
RC-CART-32HB	25"	26"	26"	32"	34"	42"	28 1/4"	29"	S	S	-	S	S	O	O	S	O	O	S
RC-CART-35HB	29"	26"	26"	35"	37"	42"	28 1/4"	29"	S	S	-	S	S	O	O	S	O	O	S
RC-CART-43HB	33"	19"	26"	38 1/2"	40 1/2"	35"	28 1/4"	29"	S	S	-	S	S	O	O	S	O	O	S
RC-CART-20AV	19 1/8"	23 1/2"	21"	23 1/8"	25 1/8"	30 1/2"	26"	26 3/4"	S	S	-	O	S	O	O	S	O	O	S
RC-CART-27AV	21 1/2"	25"	23 1/2"	27"	29"	33"	28 1/4"	29"	S	S	-	O	S	O	O	S	O	O	S
RC-CART-32AV	27"	25"	23 1/2"	32"	34"	33"	28 1/4"	29"	S	S	-	O	S	O	O	S	O	O	S
RC-CART-35AV	29"	25"	23 1/2"	35"	37"	33"	28 1/4"	29"	S	S	-	O	S	O	O	S	O	O	S
RC-CART-43AV	33"	18"	23 1/2"	38 1/2"	40 1/2"	26"	28 1/4"	29"	S	-	-	O	S	O	O	S	O	O	S
RC-CART-42PL	19 1/8"(2)	25"	27"	43 1/4"	45 1/4"	32 3/4"	29"	29 1/2"	S	S	-	S	S	O	O	-	O	O	S
RC-CART-50PL	19 1/8"(2)	25"	27"	48"	45 1/4"	32 3/4"	29"	29 1/2"	S	S	-	S	S	O	O	-	O	O	S
RC-CART-42PLST	19 1/8"(2)	17 1/2"	21 1/2"	43 1/4"	45 1/4"	32 3/4"	23 1/4"	23 3/4"	S	S	-	O	S	O	O	-	O	O	S
RC-CART-50PLST	19 1/8"(2)	17 1/2"	21 1/2"	48"	45 1/4"	32 3/4"	23 1/4"	23 3/4"	S	S	-	O	S	O	O	-	O	O	S
RC-PED-42PL	19 1/8"(2)	21"	27"	43 1/4"	41 1/4"	32 3/4"	29"	27 3/4"	S	S	-	S	S	O	O	-	O	O	-
RC-PED-50PL	19 1/8"(2)	21"	27"	48"	41 1/4"	32 3/4"	29"	27 3/4"	S	S	-	S	S	O	O	-	O	O	-
RC-PED-42PLST	19 1/8"(2)	21"	21 1/2"	43 1/4"	41 1/4"	32 3/4"	23 1/4"	21 1/2"	S	S	-	O	S	O	O	-	O	O	-
RC-PED-50PLST	19 1/8"(2)	21"	21 1/2"	48"	41 1/4"	32 3/4"	23 1/4"	21 1/2"	S	S	-	O	S	O	O	-	O	O	-
RC-CART-27	21 1/2"	25"	25 1/2"	27"	29"	33"	29"	29 1/2"	S	-	-	S	S	O	O	O	O	O	S
RC-CART-27SS	21 1/2"	17"	25 1/2"	27"	29"	33"	29"	29 1/2"	S	-	S	S	S	O	O	O	O	O	S
RC-CART-32	27"	25"	25 1/2"	32"	34"	33"	29"	29 1/2"	S	-	-	S	S	O	O	O	O	O	S
RC-CART-32SS	27"	17"	25 1/2"	32"	34"	33"	29"	29 1/2"	S	-	S	S	S	O	O	O	O	O	S
RC-CART-35	29"	25"	25 1/2"	35"	37"	33"	29"	29 1/2"	S	-	-	S	S	O	O	O	O	O	S
RC-CART-35SS	29"	17"	25 1/2"	35"	37"	33"	29"	29 1/2"	S	-	S	S	S	O	O	O	O	O	S
RC-CART-43	33"	18"	25 1/2"	38 1/2"	40 1/2"	26"	29"	29 1/2"	S	-	-	S	S	O	O	O	O	O	S
RC-CART-32WEGA	31"	17 3/8"	25 1/2"	35 1/2"	37 1/2"	33"	29"	29 1/2"	S	S	-	S	S	O	O	O	O	O	S
RC-CART-36WEGA	34"	17 3/8"	25 1/2"	38 1/2"	40 1/2"	33"	29"	29 1/2"	S	S	-	S	S	O	O	O	O	O	S
RC-CART-2029ST	21 1/2"	25"	22 1/4"	27"	29"	33"	28 1/4"	29"	S	-	-	O	S	O	O	O	O	O	S
RC-CART-20ST	19 1/8"	23 1/2"	20"	23 1/8"	25 1/8"	30 1/2"	26"	26 3/4"	S	-	-	O	S	O	O	O	O	O	S
RC-CART-27ST	21 1/2"	25"	22 1/4"	27"	29"	33"	28 1/4"	29"	S	-	-	O	S	O	O	O	O	O	S
RC-CART-27STSS	21 1/2"	17"	22 1/4"	27"	29"	33"	28 1/4"	29"	S	-	S	O	S	O	O	O	O	O	S
RC-CART-32ST	27"	25"	22 1/4"	32"	34"	33"	28 1/4"	29"	S	-	-	O	S	O	O	O	O	O	S
RC-CART-32STSS	27"	17"	22 1/4"	32"	34"	33"	28 1/4"	29"	S	-	S	O	S	O	O	O	O	O	S
RC-CART-35ST	29"	25"	22 1/4"	35"	37"	33"	28 1/4"	29"	S	-	-	O	S	O	O	O	O	O	S
RC-CART-35STSS	29"	17"	22 1/4"	35"	37"	33"	28 1/4"	29"	S	-	S	O	S	O	O	O	O	O	S
RC-CART-43ST	33"	18"	22 1/4"	38 1/2"	40 1/2"	26"	28 1/4"	29"	S	-	-	O	S	O	O	O	O	O	S
RC-CART-32WEGAST	31"	17 3/8"	22 1/4"	35 1/2"	37 1/2"	33"	28 1/4"	29"	S	S	-	O	S	O	O	O	O	O	S
RC-CART-36WEGAST	34"	17 3/8"	22 1/4"	38 1/2"	40 1/2"	33"	28 1/4"	29"	S	S	-	O	S	O	O	O	O	O	S
RC-DOC-EC	19 1/8"	22"	23"	27 1/8"	25 1/8"	29"	26"	26 3/4"	S	-	-	O	O	O	O	-	O	O	S
RC-DOC-TRAP	19 1/8"	22"	23"	39 1/8"	25 1/8"	29"	26"	26 3/4"	S	-	-	O	O	O	O	-	O	O	S
RC-DOC-29LM	19 1/8"	22"	23"	40"	24"	29"	26"	26 3/4"	S	-	-	O	O	O	O	-	O	O	S
RC-PED-227	23 1/2"	24 3/4"	22"	54"	52"	33"	28"	26"	S	-	-	S	S	O	O	-	O	O	-
RC-PED-232	28 1/2"	24 3/4"	22"	64"	62"	33"	28"	26"	S	-	-	S	S	O	O	-	O	O	-
RC-PED-235	32 1/2"	24 3/4"	22"	72"	70"	33"	28"	26"	S	-	-	S	S	O	O	-	O	O	-

KEY (S) - Standard; (O) - Optional; - (-) Not Available.

Furniture Options



Model Number	Internal Dimensions			External Dimensions					Accessories										
	Width	Height	Depth	Width (Top)	Width (Bottom)	Height	Depth (Top)	Depth (Bottom)	Adjustable Shelf	Fixed Peripheral Shelf	Exposed Speaker Shelf	Back Vent	Doors	Door Locks	Extra Internal Shelf	Monioir Tie Down	Rack Rails	Custom Laminate	Casters
RC-PED-227SS	23 1/2"	26 3/4"	22"	54"	52"	33"	28"	26"	S	-	S	S	S	O	O	-	O	O	-
RC-PED-232SS	28 1/2"	26 3/4"	22"	64"	62"	33"	28"	26"	S	-	S	S	S	O	O	-	O	O	-
RC-PED-235SS	32 1/2"	26 3/4"	22"	72"	70"	33"	28"	26"	S	-	S	S	S	O	O	-	O	O	-
RC-PROJ-EC29	19 1/8"	10 1/2"	21 3/4"	30 5/8"	23 3/4"	29"	23 1/2"	23 1/2"	O	S	-	O	O	O	O	-	O	O	S
RC-PROJ-EC38	19 1/8"	9 1/2"	21 3/4"	30 5/8"	23 3/4"	38"	23 1/2"	23 1/2"	O	S	-	O	O	O	O	-	O	O	S
RC-PROJ-TT36	19 1/8"	9 1/9"	23 3/4"	38 1/16"	25 1/8"	36"	28"	26 3/4"	S	S	-	O	O	O	O	-	O	O	S
RC-PROJ-TT44	19 1/8"	12 1/4"	23 3/4"	38 1/16"	25 1/8"	44"	28"	26 3/4"	S	S	-	O	O	O	O	-	O	O	S
RC-PROJ-WD36	19 1/8"	9 1/9"	21 3/4"	45"	25 1/2"	36"	26"	26 3/4"	S	S	-	O	S	O	O	-	O	O	S
RC-PROJ-WD44	19 1/8"	12 1/4"	21 3/4"	45"	25 1/2"	44"	26"	26 3/4"	S	S	-	O	S	O	O	-	O	O	S
RC-OH/LCD	19 1/8" ⁽²⁾	21 1/7 1/2"	23 3/4"	51 1/4"	45 1/4"	38 1/4"	28"	28 3/4"	S	S	-	-	S	O	O	-	O	O	S
RC-OH	19 1/8"	17 1/2"	23 3/4"	33 1/8"	25 1/8"	24 1/4"	26"	26 3/4"	S	-	-	-	O	O	O	-	O	O	S
RC-PS	46"	41"	20-24"	60"	48"	42"	29 1/2"	24"	-	-	-	-	-	-	-	-	-	O	-
RC-PS-12RR	19 1/8"	21"	18"	22 5/8"	22 5/8"	27 1/2"	20"	20"	-	-	-	-	O	O	-	-	S	O	S
RC-PS-16RR	19 1/8"	28"	18"	22 5/8"	22 5/8"	34 1/2"	20"	20"	-	-	-	-	O	O	-	-	S	O	S
RC-PS-12RS	19 1/8"	21"	18"	22 5/8"	22 5/8"	27 1/2"	20"	20"	-	-	-	-	O	O	-	-	-	O	S
RC-PS-16RS	19 1/8"	28"	18"	22 5/8"	22 5/8"	34 1/2"	20"	20"	-	-	-	-	O	O	-	-	-	O	S
RC-PS-12RD	19 1/8"	21"	18"	22 5/8"	22 5/8"	27 1/2"	20"	20"	-	-	-	-	-	-	-	-	-	O	S
RC-PS-16RD	19 1/8"	28"	18"	22 5/8"	22 5/8"	34 1/2"	20"	20"	-	-	-	-	-	-	-	-	-	O	S
RC-PS-SOLO	32"	41"	18"	48"	34"	42"	29 1/2"	20"	-	S	-	-	-	-	-	-	-	O	-
RC-RACK-8	19 1/8"	14"	18"	23 1/8"	23 1/8"	16"	20"	20"	-	-	-	-	O	O	-	-	S	O	-
RC-RACK-12	19 1/8"	21"	18"	23 1/8"	23 1/8"	23"	20"	20"	-	-	-	-	O	O	-	-	S	O	-
RC-RACK-16	19 1/8"	28"	18"	23 1/8"	23 1/8"	30"	20"	20"	-	-	-	-	O	O	-	-	S	O	-
RC-RACK-20	19 1/8"	35"	18"	23 1/8"	23 1/8"	37"	20"	20"	-	-	-	-	O	O	-	-	S	O	-
RC-CART-RK12	19 1/8"	21"	21"	23 1/8"	25 1/8"	27 3/4"	23"	23 3/4"	-	-	-	S	O	O	-	-	S	O	S
RC-CART-RK16	19 1/8"	28"	21"	23 1/8"	25 1/8"	34 3/4"	23"	23 3/4"	-	-	-	S	O	O	-	-	S	O	S
RC-CART-RK20	19 1/8"	35"	21"	23 1/8"	25 1/8"	41 3/4"	23"	23 3/4"	-	-	-	S	O	O	-	-	S	O	S
RC-TBL-5	-	-	-	68"	-	29"	-	72"	-	-	-	-	-	-	-	-	-	O	-
RC-TBL-7	-	-	-	68"	-	29"	-	96"	-	-	-	-	-	-	-	-	-	O	-
RC-TBL-9	-	-	-	68"	-	29"	-	120"	-	-	-	-	-	-	-	-	-	O	-
RC-R48	-	-	-	48"	-	29"	-	-	-	-	-	-	-	-	-	-	-	O	-
RC-R60	-	-	-	60"	-	29"	-	-	-	-	-	-	-	-	-	-	-	O	-
RC-RT96	-	-	-	48"	-	29"	-	96"	-	-	-	-	-	-	-	-	-	O	-
RC-RT120	-	-	-	48"	-	29"	-	120"	-	-	-	-	-	-	-	-	-	O	-
RC-TT5427	-	-	-	54"	-	29"	-	27"	-	-	-	-	-	-	-	-	-	O	-
RC-TT7224	-	-	-	72"	-	29"	-	24"	-	-	-	-	-	-	-	-	-	O	-
RC-CRD-36LM	33"	25"	17"	36"	36"	29"	18 1/2"	18 1/2"	S	-	-	-	S	O	O	-	-	O	-
RC-CRD-54LM	51"	25"	17"	54"	54"	29"	18 1/2"	18 1/2"	S	-	-	-	S	O	O	-	-	O	-
RC-CRD-72LM	69"	25"	17"	72"	72"	29"	18 1/2"	18 1/2"	S	-	-	-	S	O	O	-	-	O	-

KEY (S) - Standard; (O) - Optional; - (-) Not Available.

Laminate
Colors

Laminate
Colors

Laminate
Colors

Laminate
Colors

Finishes

Colors

Furniture

Seattle Cherry

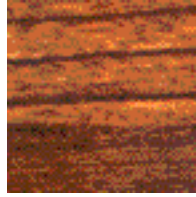

Natural Oak



Graphite Nebula

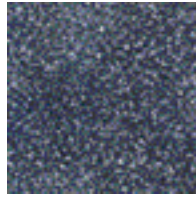

Matte Black



Hardrock Maple

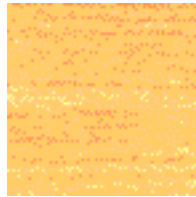

African Walnut

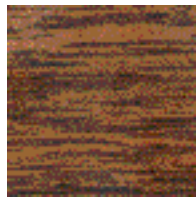

Grey Nebula

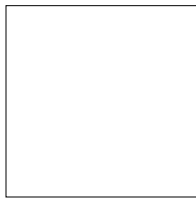

June Mahogany



VideoLabs' selection of fine, quality meeting room furniture is designed and engineered to provide lasting value. Our standard line of furniture is built with laminate and melamine to resist scratching and damage from everyday use. Seven additional color options (shown) are available at no extra charge. Custom laminates are available at a nominal charge. The options offered give you the flexibility to create the perfect environment. For organizations that demand more from their meeting room furniture, VideoLabs has what you need.

VideoLabs' furniture line comes standard in black. Also available in seven additional colors with a black rubber bumper. Standard pieces are shipped in 2-4 weeks. Please allow 4-6 weeks for pieces ordered in color selection shown. Custom laminates are also available at a nominal up charge. Contact VideoLabs for specifics on custom pieces.

Custom
Finishes

Custom
Laminates

Custom
Sizes

Custom
Looks

Custom Furniture

Give Us A Call

We have found that there are many times that a standard piece doesn't fit the needs of our customers.

A new oddly shaped piece of equipment, or a different room size may require

something a little different. We have the ability to modify our current line, or create

an entirely new piece that fits the needs for that specific environment. We would

be happy to work with you to achieve the

look you need.



Custom Finishes

In addition to our standard line of melamine and laminate products, we have the ability to build beautiful hardwood pieces. We offer as an additional service the ability to match your custom stains and finishes. A customer provided finish sample or stain sample is required before the process of matching approval, or any work can begin. Please note that color variation will occur in the grain of all wood species. In some species, this color variation is very subtle, in others it is more radical.

Custom Laminates

Any commercially available laminate may be specified. Some custom laminate orders can be completed without extending the delivery date. Some hard to find or non-stock colors may extend the ship date.

Videolabs has the capability to manufacture any piece in the product line to your specifications. All of our furniture is American made by our professional cabinetmakers.

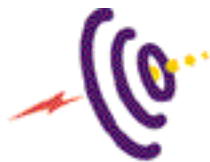

VIDEOLABS®

5960 Golden Hills Drive • Minneapolis, MN 55416-1040

Phone: 763.542.0061 • Fax: 763.542.0069

Toll-Free: 800.467.7157

E-Mail: info@videolabs.com

www.videolabs.com