



## OPERATORS MANUAL

Klark Teknik Group,  
Klark Teknik Building,  
Walter Nash Road,  
Kidderminster.  
Worcestershire.  
DY11 7HJ.  
England.

Tel:+44 1562 741515  
Fax:+44 1562 745371

Email: [sales@ktgplc.com](mailto:sales@ktgplc.com)  
Website: [www.midasconsoles.com](http://www.midasconsoles.com)



# IMPORTANT SAFETY INSTRUCTIONS



These symbols are internationally accepted symbols that warn of potential hazards with electrical products.



The lightning flash with arrowhead symbol, within an equilateral triangle is intended to alert the user to the presence of uninsulated “dangerous voltage” within the product's enclosure that may be of sufficient magnitude to constitute a risk of electric shock to persons.



The exclamation point within an equilateral triangle is intended to alert the user to the presence of important operating and maintenance (servicing) instructions in the literature accompanying the appliance.

1. Read these instructions.
2. Keep these instructions.
3. Heed all warnings.
4. Follow all instructions.
5. Do not use this apparatus near water.
6. Clean only with a dry cloth.
7. Do not block any of the ventilation openings. Install in accordance with the manufacturers instructions.
8. Do not install near any heat sources such as radiators, heat registers, stoves, or other apparatus that produce heat.
9. Do not defeat the safety purpose of the polarized or grounding-type plug. A polarized plug has two blades with one wider than the other. A grounding type plug has two blades and a third grounding prong. The wide blade or third prong are provided for your safety. When the provided plug does not fit into your outlet, consult an electrician for replacement of the obsolete outlet.
10. Protect the power cord from being walked on or pinched particularly at plugs, convenience receptacles, and the point where they exit from the apparatus.
11. Unplug this apparatus during lightning storms or when unused for long periods of time.
12. Refer all testing to qualified personnel. Servicing is required when the apparatus is damaged in any way, such as power-supply cord or plug is damaged, liquid has been spilled or objects have fallen into the apparatus, the apparatus has been exposed to rain or moisture, does not operate normally, or has been dropped.



# KLARK TEKNIK GROUP

Walter Nash Road, Kidderminster, Worcestershire. DY11 7HJ. England

Tel: +44 1562 741515. Fax: +44 1562 745371

Company Registration No: 2414018

**KLARK TEKNIK**  
SIGNAL PROCESSING BY DEFINITION

**MIDAS**  
DESIGNED FOR A PURE PERFORMANCE

## DECLARATION OF CONFORMITY

We, **Klark Teknik Group (UK) Plc**

of, Klark Teknik Building, Walter Nash Road, Kidderminster, Worcestershire, DY11 7HJ.

Declare that a sample of the following product:-

Product Type Number	Product Description	Nominal Voltage (s)	Current	Freq
Verona	Professional Audio Mixing Desk	115V AC 230V AC	2.2A 1.1A	50/60Hz

to which this declaration refers, is in conformity with the following directives and/or standards:-

Directive(s)	Test Standard(s)
<i>Generic Standard using EN55103 Limits and Methods</i>	
<i>Class B Conduct Emissions</i>	<i>EN55103</i>
<i>Class B Radiated Emissions</i>	<i>EN55103</i>
<i>Fast Transient Bursts</i>	<i>EN61000-4-4</i>
<i>Static Discharge</i>	<i>EN61000-4-2</i>

Signed:   
Name: Simon Harrison

Date: 1st January 2004

Authority: Research and Development Director, Klark Teknik Group (UK) Plc

Attention!

Where applicable, the attention of the specifier, purchaser, installer or user is drawn to special limitations of use which must be observed when these products are taken into service to maintain compliance with the above directives. Details of these special measures and limitations to use are available on request and are available in product manuals.



**Thank You** for using a Midas Verona mixing console. The Verona has been developed to meet the needs of demanding live sound engineers and meets the quality of build and performance that you would expect from a Midas.

The Verona is an all purpose FOH, Monitor or FOH and Monitor Hybrid console that is quickly and easily configurable. Each mono input channel offers microphone and line inputs, direct output and insert points and four band sweep equaliser stage. In addition the Verona has a flexible buss structure allowing the engineer to mix in stereo or LCR.

The Verona, also allows the user to route to any of 20 other busses (8 Auxiliary Busses, 8 Group Busses and 4 Matrix Busses) for even the most demanding application.

All backed up, of course, by the standard Midas Three Year Warranty.

Please take the time to complete and return the registration card and, to obtain the best results with a minimum of effort, also read this operators manual.

Finally,

Enjoy your new Midas Verona Console!

## Contents

<b>ATTENTION: Installation and power</b>	<b>6</b>
<b>Mono Input Channels</b>	<b>7</b>
Rear Panel and Gain	8
Equalisation	9
Auxiliary Outputs	10
Pan and Routing	11
Metering and Automutes	12
<b>Multifunction Input Channels</b>	<b>13</b>
Rear Panel and Gain	14
Channel Equalisation	15
Auxiliary Outputs	16
Pan and Routing	17
Metering, Automutes and Hints and Tips	18
<b>Output Module</b>	<b>19</b>
Output Module notes	20
Groups	21
Matrix	22
Meters	24
Features	26
<b>Setting up the Verona</b>	<b>27</b>
<b>Functional Block Diagrams</b>	<b>33</b>
Mono Input	34
Multifunction Input	35
Group/Matrix Module	36
Master Module	37
<b>Dimensions and Weights</b>	<b>39</b>
<b>Specification and Features</b>	<b>41</b>
<b>Crib Sheet</b>	<b>45</b>

# ATTENTION

The following special limitations must be observed in order to maintain safety and electromagnetic compatibility performance.

## Power Connection

The console should only be operated with the power supply connected to ground via the ground in the mains connector.

## Audio Connections

The console should only be operated with high quality twisted-pair audio cables. All connector shells should be of metal construction so that they provide a screen when connected to the console. All jack connector shells should be connected to the cable screen. All XLR plugs should have pin one (1) connected to the cable screen.

## Electric Fields

If the console is operated in an electromagnetic field that is amplitude modulated by an audio frequency signal, the signal to noise ratio may be degraded. Degradation of up to 60dB may be experienced under extreme conditions (3V/m, 90% modulation).

## INSTALLATION

### Position

The position of the console will vary from venue to venue. However, when positioning the console for front of house usage it is worth placing the console in a position where the sound system used can be heard properly from the mix position. Try to avoid placing the console behind pillars or large objects, or mixing from a level above the speaker position (e.g. from a balcony).

Also try to avoid placing the console near or on any power distribution units or power amplifiers.

### Power

If using an external power supply, it should be located as far away from the console as the connecting cable will allow. The power supply should be set for the voltage supply available in your area and plugged into the mains outlet using the cable provided.



**THE POWER SUPPLY SHOULD NEVER BE OPERATED WITH THE MAINS EARTH DISCONNECTED**

**Please note that the power supply contains LETHAL VOLTAGES greatly in excess of the mains voltage and that it's rails can produce extremely large currents which could burn out equipment and wiring if shorted. All testing and servicing should ONLY be carried out by a qualified engineer.**

## Connections

To ensure the correct and reliable operation of your Midas Verona console, only high quality screened twisted pair audio cable and metal bodied connectors should be used.

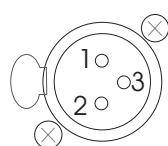

### Female XLR

Pin 1 - Screen/Ground  
Pin 2 - Hot Signal  
Pin 3 - Cold Signal

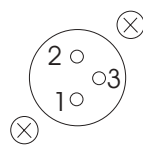

### Male XLR

Pin 1 - Screen/Ground  
Pin 2 - Hot Signal  
Pin 3 - Cold Signal

Note: Sockets are viewed from the front face.

### Quarter Inch Jack

	TRS Signal	TRS Insert	TRS Headphone
Sleeve	Screen/Ground	Screen/Ground	Screen/Ground
Ring	Cold Signal	Insert Return	Right
Tip	Hot Signal	Insert Send	Left

### RCA (Tape In/Out)

Centre - Signal  
Surround - Screen

The Venice's Tape In/Out sockets are unbalanced and operate at a nominal signal level of -10dBu.

For increased protection against interference use metal bodied RCA plugs.







# Mono Input Channel

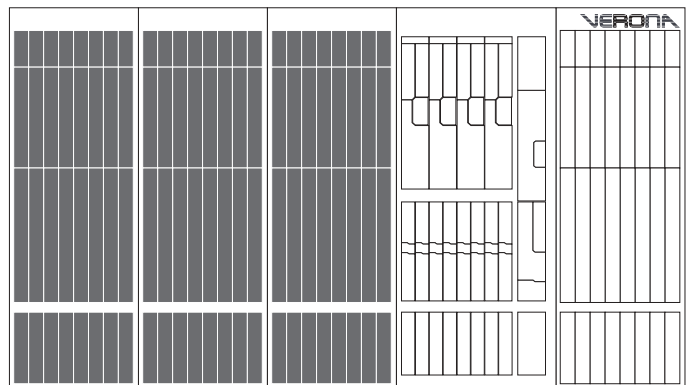

# Mono Input Channels

## Rear Panel

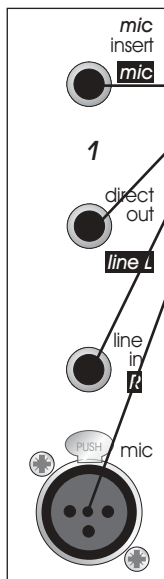

The Verona channel inputs are located on the rear of the console. Each mono channel provides

- one insert point on a single TRS jack socket.
- one direct output on a single impedance balanced quarter-inch jack socket
- one line in quarter-inch TRS balanced jack socket
- one mic XLR female

The insert point is unbalanced and requires a conventionally wired insert lead where:

- Tip** - Channel Signal Send
- Ring** - Channel Signal Return
- Sleeve** - Signal Common Ground

The direct out and insert points operate at a nominal level of 0dBu.

Balanced XLR and Jack inputs are conventionally wired:

- XLR** - 1. Screen - 2. Hot Signal - 3. Cold Signal
- TRS** - T. Hot Signal - R. Cold Signal - S. Screen

## Front Panel

The actual number of mono input channels on your Verona will depend upon your choice of frame, however functionality remains the same

**48V Power** - When depressed, the Verona will apply 48 volts phantom power to the microphone input. This is used to power condenser microphones, direct inject boxes and other devices that require phantom power.

The red phantom LED will light to indicate that 48V phantom is in operation.

**Mic Ø** - The mic phase switch, when depressed, causes a 180 degree phase change (with respect to the input signal) to occur in the input amplifier such that the channel signal will have opposite polarity to the input signal.

The mic phase switch is commonly needed where two microphones are used facing each other (for example when using a microphone on both the top and bottom of a snare drum). Ordinarily the two microphones would be out of phase causing cancellation when the console sums the two signals into the output. Reversing the phase of one signal causes the microphones to have the same phase and no cancellation.

**Hi-Pass** - The high pass switch enables high pass filter on the microphone input. This is commonly used to remove handling noise, bass rumble through coupling with the stage or mains hum.

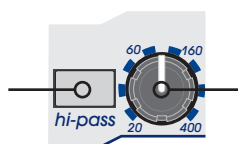
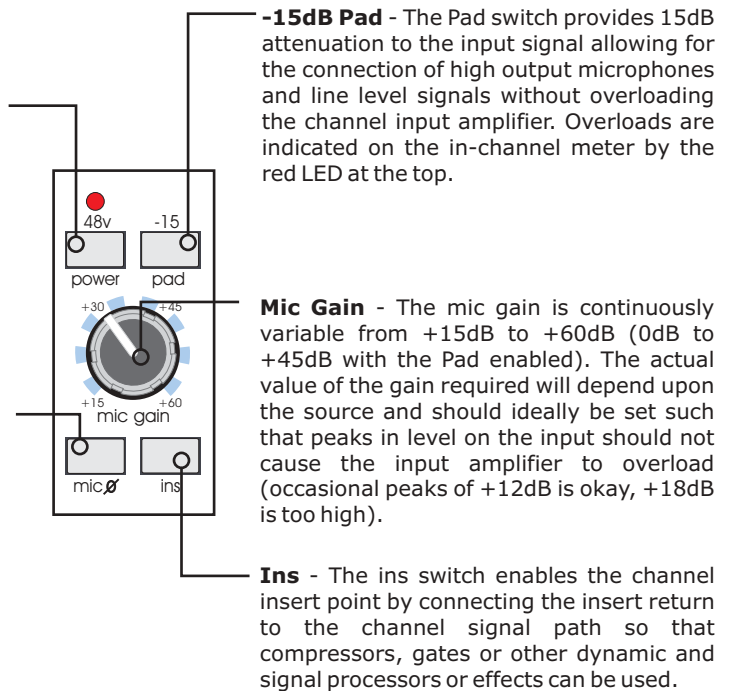

**High Pass Frequency** - The cutoff frequency of the high pass filter is continuously variable from 20Hz to 400Hz.

# Mono Input Channels

## Channel Equalisation

Each mono input channel of the Verona has a four (4) band sweep EQ allowing tonal control over the input signal.

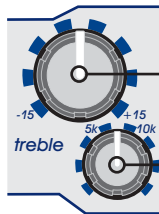
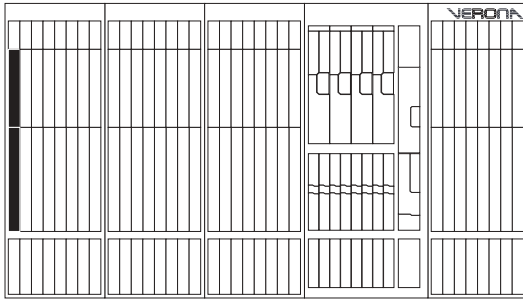

**Treble (Gain)** - The gain of the treble equaliser is continuously variable from -15dB to +15dB with a centre detent at 0dB.

**Treble (frequency)** - The centre frequency of the treble equaliser is continuously variable from 2kHz to 20kHz.

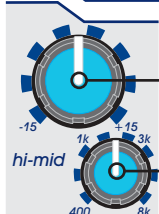

**Hi-Mid (Gain)** - The gain of the hi-mid equaliser is continuously variable from -15dB to +15dB with a centre detent at 0dB.

**Hi-Mid (frequency)** - The centre frequency of the hi-mid equaliser is continuously variable from 400Hz to 8kHz.

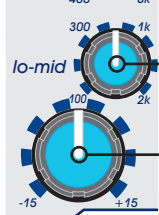

**Lo-Mid (frequency)** - The centre frequency of the lo-mid equaliser is continuously variable from 100Hz to 2kHz.

**Lo-Mid (Gain)** - The gain of the lo-mid equaliser is continuously variable from -15dB to +15dB with a centre detent at 0dB.

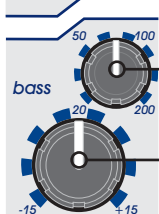

**Bass (frequency)** - The centre frequency of the bass equaliser is continuously variable from 20Hz to 200Hz.

**Bass (Gain)** - The gain of the bass equaliser is continuously variable from -15dB to +15dB with a centre detent at 0dB.

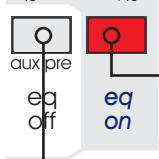

**EQ On** - The Equaliser can be enabled by depressing the EQ On switch. Otherwise changes on the Equaliser controls have no effect. This can be used to compare the sound with and without EQ during sound check.

**EQ Off (aux pre)** - If desired, the channel signal can be sent to the auxiliary outputs without equalisation. Depressing the EQ Off (Aux Pre) switch causes pre-fader auxiliary sends 1-6 to be sourced before the channel equaliser (Pre-EQ). Note: Post fader sends are always Post EQ.

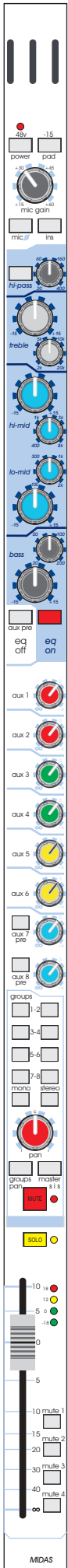

# Mono Input Channels

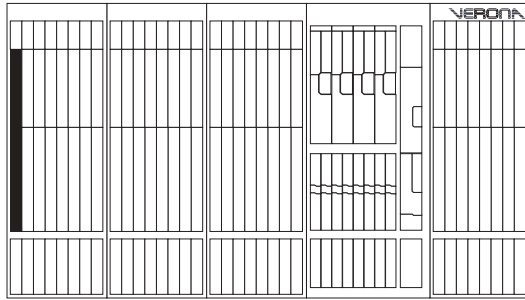

## Auxiliary Outputs

The Verona has 8 auxiliary outputs which can be used for effects sends, monitors or as extra assignable outputs from the console.

**Pre-Fade** auxiliary (aux) sends are sourced after the channel Insert, Mute and EQ but before the channel fader (and EQ if the Aux Pre EQ switch is depressed). As a result, the actual level sent to the aux buss is proportional to the aux send control only.

**Post-Fade** aux sends are sourced after the channel Insert, Mute, EQ and channel Fader. As a result, the actual level sent to the aux buss is proportional to the aux send control AND the channel fader.

Typical uses of auxiliaries are:

Application	Pre/Post Fade	Reason
Stage Monitors	Pre (Post-EQ)	The level in the monitor stays constant so that the engineer can change the FOH level without affecting the performer.
Effects Sends	Post	The level sent to the effects is proportional to the level on the fader so the balance between wet (processed) and dry (un-processed) sound stays the same even when the channel level is changed
Multi Track Recording or Monitors from FOH	Pre (Pre-EQ)	The recording is made at constant level without any equalisation so that changes in the mix level and EQ can be set in post-production. (You can also use the Direct Out for this but the output will be at unity).
Mixed Recording (for the artist)	Post(Post-EQ)	If the aux is set to unity, the FOH mix is replicated on the aux output including EQ but excluding PAN.

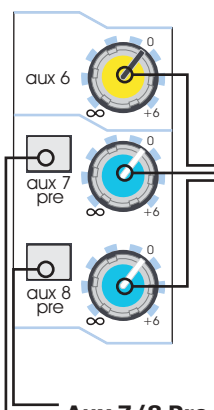

Aux sends 1 through 6 are globally switched Pre or Post Fader. However, Aux 7 and 8 may be individually sourced either Post Fader or Pre Fader using the selector switch on the channel and can not be set pre-EQ.

Please note that, for illustration purposes, auxiliary 1 through 5 sends have been omitted but work in the same manner as auxiliary 6 (illustrated).

**Aux Send Level** - The auxiliary send level is continuously variable from off (-inf) to +6dB.

**Aux 7/8 Pre** - Auxiliary 7 and 8 sends are assignable Pre of Post fader. When depressed, the auxiliary is sourced pre-fader (i.e. the channel fader has no effect upon the level of the signal sent to the auxiliary).

Note: When a channel Mute is enabled, aux sends for the channel are also muted.

# Mono Input Channels

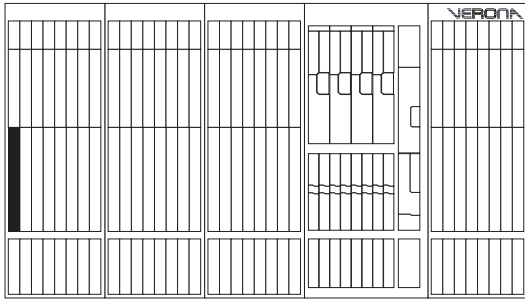

## Pan and Routing

The Verona is a flexible mixing console with eight group buss outputs plus stereo and mono outputs.

### Groups

Signal can be routed to any of the eight group busses by depressing the corresponding group select switch.

Group sends are post channel equalisation, mute and fader.

The group sends can be configured in either of two modes:-

#### 1. Pre-Pan (mono)

Each group is sent the same mono signal.

i.e. Selecting 1, 2 & 3 will send to each group equally.

#### 2. Post-Pan (stereo)

Each pair of groups behave as if they were stereo groups. The mono signal is positioned in a stereo field by the pan control. The Left signal is routed to the odd numbered buss and the right to the even numbered buss.

i.e. Selecting groups 1, 2 & 3 with pan hard left will result in signal being routed to groups 1 & 3 only. Similarly, with pan hard right, signal will be sent only to group 2.

This configuration is made by depressing the 'Groups Pan' key for stereo group operation or released for mono group mode.

This selection, however, is on a channel-by-channel basis and so some may be assigned to the groups as mono or as stereo depending upon the desired usage.

For example:

Application	Config.	Reason
Multitrack Recording	Mono	Inputs can be sent to a particular input on the multitrack recorder without affecting the stereo image used at FOH.
Alternative/Delay Output	Stereo	The Group would behave in the same manner as the stereo output allowing for separate level control but retaining the original stereo image from FOH.

**Group 1-8** - Depressing the group switch routes the channel signal to the group busses as described above.

**Mono** - Depressing the mono switch routes the channel signal to the mono buss (post-EQ, mute and fader).

**Pan** - The pan control allows the channel signal to be positioned in a stereo field when routed to the stereo buss or when group sends are configured to be stereo. The pan control allows continuous adjustment of the image from hard left, to hard right with a centre detent and obeys a constant power law (i.e. -3dB at the centre so that the output power remains at unity).

**Groups Pan** - As described above the Verona's group sends may be configured by depressing the 'Groups Pan' key for stereo group operation or released for mono group mode.

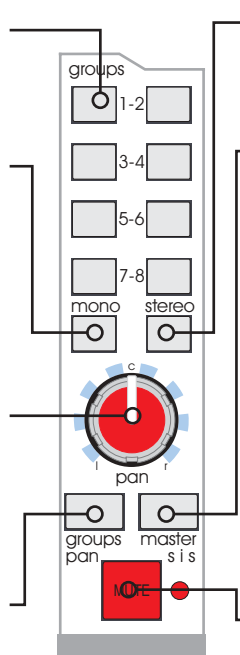

**Stereo** - Depressing the stereo switch routes the channel signal to the stereo (main left and right) buss (post-EQ, pan, mute and fader).

**Master SIS** - The master SIS switch will enable the spacial imaging system whereby the channel pan control operates in a different way. When panned hard left, signal is routed to the stereo left output as normal, similarly when panned hard right, the signal is routed to the stereo right output as normal. However, when panned centre, the signal is routed ONLY to the mono output creating a LCR (left-centre-right) system instead of the normal LR (left-right) system.

You may use SIS mode if using a centre speaker for speech or solo instruments while retaining the stereo for backing vocals and instruments.

**Mute** - The mute switch mutes the channel signal. Note that signal will still be sent to the insert point and to the direct output. The mute status of the channel is indicated by the corresponding mute LED

# Mono Input Channels

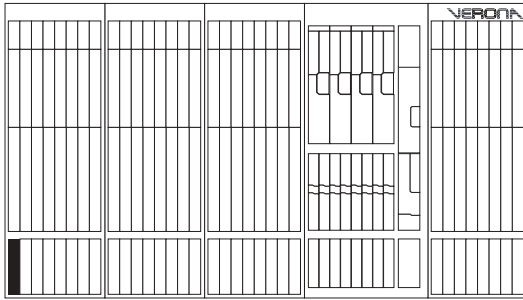

**Solo** - When depressed, the channel signal will be sent to the After Fade Listen (AFL) stereo and Pre Fade Listen (PFL) mono outputs. The solo LED indicator will illuminate to show that the channel solo is active.

The Left and Right Monitor and the PFL console outputs can be used, for example, when operating from within a booth to hear selected solos and not the whole FOH mix.

Note: If Solo In Place is activated on the console, any active input solos will replace the master outputs completely until the solo is removed.

**Channel Fader** - The channel fader allows for continuous adjustment of the channel level from off (-inf) to +10dB.

At 0dB, the output of the channel to the Stereo, Mono and Group busses will be at unity (i.e. no boost or cut in level from the input).

**Mute 1,2,3 & 4** - The Verona has four (4) automute busses that can be controlled from the centre section of the console. To assign an input channel to an automute, switch in the desired mute switch.

Commonly, these are used to mute similar channels, for example:

Channels	Reason
Drum Mics	Allows the engineer to mute the whole drum kit at once.
Choir Overheads	Allows the engineer to quickly remove all choir mics at once
Orchestra Parts	Allows the engineer to zone mics together (e.g. Brass, Strings, etc.) and mute sections together if they were not playing.

Note that if any assigned automute or the channel mute is activated then the channel will be muted until all assigned automutes and the channel mute are removed (i.e. the mutes work like a logical OR where any single or combination of mutes will mute the channel output).

**4 LED Meter** - Each input channel contains in-channel monitoring allowing the user to monitor the input signal without the need for using the PFL.

The in-channel meter is especially useful when setting the microphone gain of a channel. Also, as the meter is post-EQ, it is possible to see the effect that the channel equalisation has upon the level. It may be necessary to turn the input gain down when excessive EQ is used to prevent the channel from overloading.

- 18dB - Signal Present
- 0dB - Normal Level
- +12dB - High Level
- +18dB - Overload (Peak)

Note: The LED meter and the direct output are fed from the same source and are Post-Insert and EQ but Pre-Fader and Mute. The channel in-line meter and direct output are unaffected by the channel mute or automutes.

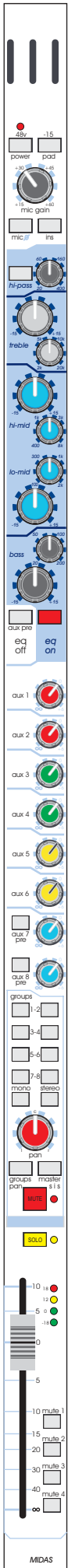
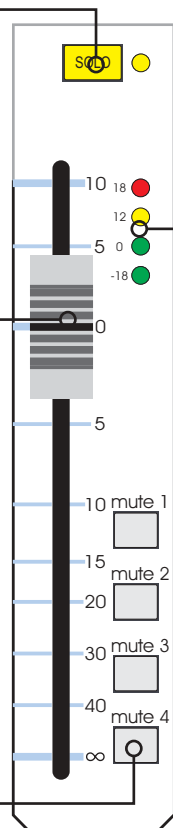



# Multi Function Input Channel

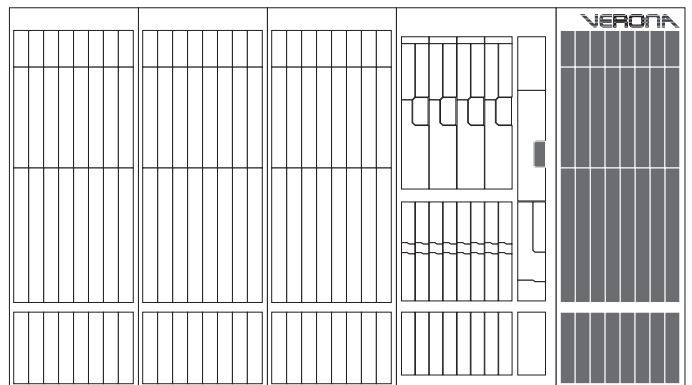

# Multi Function Input Channels

## Rear Panel

The Verona channel inputs are located on the rear of the console. Each multifunction channel provides:

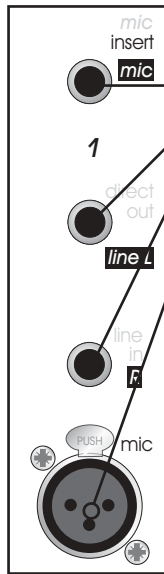

- one insert point on a single TRS jack socket;
- two quarter-inch TRS balanced line in jack socket inputs;
- one mic XLR female.

The insert point operates on the XLR microphone input only (i.e. not on the line inputs) and is unbalanced and conventionally wired insert where:

- Tip** - Channel Signal Send
- Ring** - Channel Signal Return
- Sleeve** - Signal Common Ground

The direct out and insert points operate at a nominal level of 0dBu.

Balanced XLR and Jack inputs are conventionally wired:

- XLR** - 1. Screen - 2. Hot Signal - 3. Cold Signal
- TRS** - T. Hot Signal - R. Cold Signal - S. Screen

## Front Panel

The actual number of multifunction input channels on your Midas Verona will depend upon your choice of frame. However, each frame functions in essentially the same way.

**48v Power** - When depressed, the Verona will apply 48 volts phantom power the channel's microphone input to power condenser microphones, direct inject boxes or other devices that require phantom power.

The red phantom power LED will light to indicate that phantom power is being applied.

**Mic Ø** - The microphone phase switch causes a 180 degree phase change (with respect to the input) to occur in the input amplifier inverting the phase of the microphone signal to the channel. This is generally desirable when trying to sum two signals that are out of phase which would lead to cancellation (especially at low frequencies). For example, when trying to use microphone signals from both the top and bottom head of a snare drum.

Note: On stereo channels, the phase switch has no effect upon the left and right line inputs.

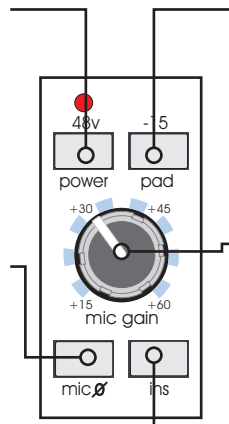

**Pad** - The Pad switch provides 15dB attenuation on the input to allow the connection of high output microphones and line level signals (to the microphone input) without overloading the channel's input amplifier.

Note: On multifunction channels, the Pad switch has no effect upon the left & right line level inputs.

**Mic Gain** - The microphone gain is continuously variable from +15dB to +60dB (effective channel input gain 0dB to +45dB with pad enabled). The pre-fade channel input level can be monitored on the in-channel LED meter (discussed later in this section).

**Ins** - The insert switch enables the channel insert point by connecting the insert return to the channel signal path. This allows for the insertion of dynamic processors or effects into the signal path (for example, compression, limiting or gating of microphone signals).

Note: On stereo channels, the channel insert has no effect upon the left and right line inputs.

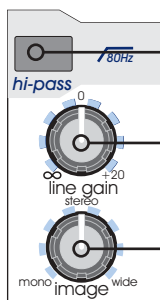

**Hi-Pass** - The high pass switch enables an 80Hz high pass filter on the microphone input. This is commonly used to remove handling noise, bass rumble through coupling with the stage or mains hum.

**Line Gain** - The line gain is continuously variable from off (-inf) to +20dB allowing for low level line signals to be trimmed to obtain the optimal signal level. The pre-fade input signal level can be monitored using the in-channel LED meter (discussed later in this section).

**Image** - The image control controls the stereo image of the channel and is continuously variable from mono through Left-Right stereo to a wide stereo image. The wide stereo image uses phase cancellation techniques to create a 'wider' sounding signal by removing an amount of signal common to both the left and right signals.



# Multi Function Input Channels

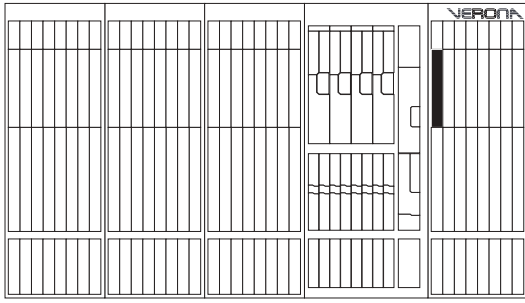

## Channel Equalisation

The Verona's multifunction channels each have treble and bass shelving EQ and hi and lo-mid sweep EQ stages for tonal control.

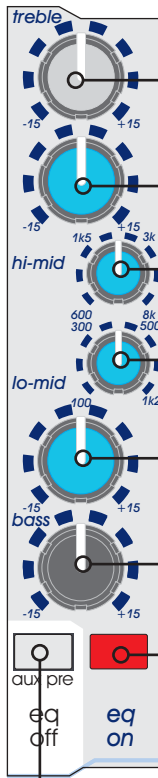

**Treble** - The treble shelving EQ gain is continuously variable from -15dB to +15dB.

**Hi-Mid Gain** - The Hi-mid gain is continuously variable from -15dB to +15dB.

**Hi-Mid Frequency** - The centre frequency of the hi-mid EQ is continuously variable from 600Hz to 8kHz allowing the operator to select the desired centre frequency for the equaliser.

**Lo-Mid Frequency** - The centre frequency of the lo-mid EQ is continuously variable from 100Hz to 1.2kHz allowing the operator to select the desired centre frequency for the equaliser.

**Lo-Mid Gain** - The Lo-mid gain is continuously variable from -15dB to +15dB.

**Bass Gain** - The bass shelving EQ gain is continuously variable from -15dB to +15dB.

**EQ On** - The channel equalisation stages are enabled by depressing the EQ on switch. Otherwise the settings of the channel EQ will have no effect.

**EQ Off (aux Pre)** - When depressed, auxiliary sends 1 through 6 will be sourced pre-equalisation. Otherwise auxiliary sends will be sourced post EQ. The use of this option depends upon how the auxiliary sends are to be used.



# Multi Function Input Channels

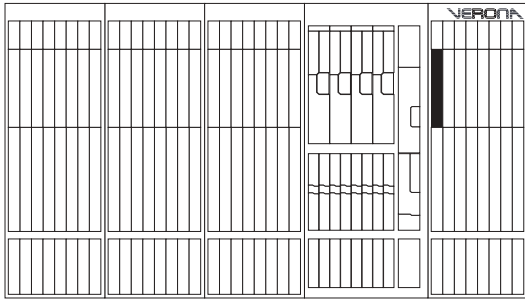

## Auxiliary Outputs

Note: Multifunction channel signals are summed into a mono signal which can be routed to the auxiliary busses by the channel aux sends.

The Verona has eight (8) auxiliary outputs which can be used for effects sends, monitor sends or as extra assignable outputs from the console.

**Pre-Fade** auxiliary (aux) 1-6 sends are sourced after the channel Insert, Mute and EQ but before the channel fader (and EQ if the Aux Pre EQ switch is depressed). As a result, the actual level sent to the aux buss is proportional to the aux send control only.

**Post-Fade** aux sends are sourced after the channel Insert, Mute, EQ and channel Fader. As a result, the actual level sent to the aux buss is proportional to the aux send control AND the channel fader.

Typical uses of auxiliaries are:

Application	Pre/Post Fade	Reason
Stage Monitors	Pre (Post-EQ)	The level in the monitor stays constant so that the engineer can change the FOH level without affecting the performer.
Effects Sends	Post	The level sent to the effects is proportional to the level on the fader so the balance between wet (processed) and dry (un-processed) sound stays the same even when the channel level is changed
Multi Track Recording	Pre (Pre-EQ)	The recording is made at constant level without any equalisation so that changes in the mix level and EQ can be set in post-production. (You can also use the Direct Out for this but the output will be at unity).
Mixed Recording	Post (Post-EQ)	If the aux is set to unity, the FOH mix is replicated on the aux output including EQ but excluding PAN.

Aux sends 1 through 6 are always globally switchable pre or post fader. However, Aux 7 and 8 may individually be sourced either Post Fader or Pre Fader using the selector switch on the channel and can not be pre-EQ.

Please note that, for illustration purposes, auxiliary 1 through 4 sends have been omitted but work in the same manner as auxiliary 6 (illustrated).

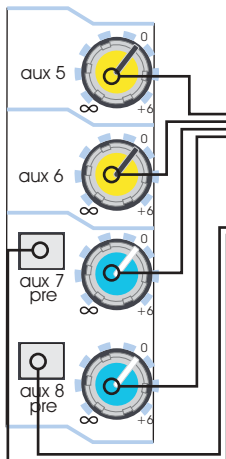

**Aux Send Level** - The auxiliary send level is continuously variable from off (-inf) to +6dB.

**Aux 7/8 Pre** - Both aux 7 and aux 8 are assignable Pre or Post fader. When depressed, the auxiliary is sourced pre-fader (i.e. the channel fader has no effect upon the level of the signal sent to the auxiliary).

Note: When a channel Mute is enabled, aux sends for the channel are also muted, however when a signal is sent pre-fader (for example to stage monitoring) the signal will continue to be sent to the auxiliary buss even when the channel fader is at the off position. This can be very embarrassing, for example, when queueing up backing tracks during a show without the channel mute enabled (and playing the track to whoever may be on stage at the time)

NOTE: Stereo modules can equally be used for mono signals (plugged in via the microphone socket). The EQ on the stereo channels has fixed frequency high and low sections which are optimised for vocals.

# Multi Function Input Channels

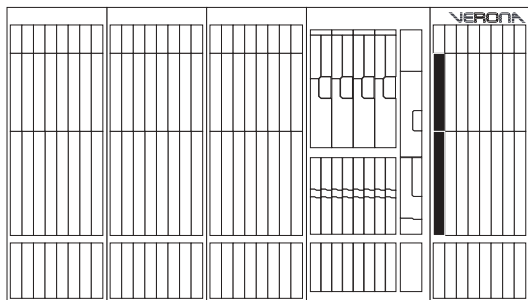

## Pan and Routing

The Verona is a flexible mixing console with eight group buss outputs plus stereo and mono outputs.

### Groups

Signal can be routed to any of the eight group busses by depressing the corresponding group select switch.

Group sends are post channel equalisation, mute and fader.

The group sends can be configured in either of two modes:-

#### 1. Pre-Pan (mono)

The stereo signals are sent to the busses as a mono sum of L & R regardless of the pan control.

#### 2. Post-Pan (stereo)

Each pair of groups behave as if they were stereo groups. The relative odd and even numbered send level is controlled by the pan control.

This configuration is made by depressing the 'Groups Pan' key for stereo group operation or released for mono group mode.

This selection is on a channel-by-channel basis and so some may be assigned to the groups as mono or as stereo depending upon the desired usage which is especially useful if the stereo input is to be used as a mono input.

For example:

Application	Config.	Reason
Multitrack Recording	Mono	Inputs can be sent to a particular input on the multitrack recorder without affecting the stereo image used at FOH.
Alternative/Delay Output	Stereo	The Group would behave in the same manner as the stereo output allowing for separate level control but retaining the original stereo image from FOH.

**Group 1-8** - Depressing the group switch routes the channel signals as described above.

**Mono** - Depressing the mono switch routes the channel signals to the mono buss (post-EQ and fader).

**Pan** - The pan control allows continuous reciprocal adjustment of the stereo image created by the channel. In the case of a mono microphone signal this will be a simple L-R pan, where, with a stereo signal this will be a balance allowing the user to determine the relative output power to each the Left and Right output. At all points the pan retains constant power (i.e. -3dB at the centre, 0dB at each extreme).

**Groups Pan** - As described above the Verona's group sends may be configured by depressing the 'Groups Pan' key for stereo group operation or released for mono group mode.

Note: That SIS is not available on stereo input channels.

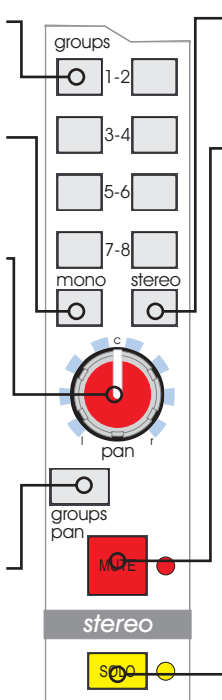

**Stereo** - Depressing the stereo switch routes the channel signals to the stereo (main left and right) buss (post-EQ, pan and fader).

**Mute** - The mute switch mutes the channel signal. Note that signal will still be sent to the insert point and to the direct output. The mute status of the channel is indicated by the corresponding mute LED.

The channel can also be muted by the four (4) assignable mute groups which will be explained later in this section.

**Solo** - When depressed, the channel signal will be sent to the AFL stereo and PFL mono outputs. The solo LED indicator will illuminate to show that the channel solo is active.

The Left and Right Monitor and the PFL console outputs can be used, for example, when operating from within a booth to hear selected solos and not the whole FOH mix.

Note: If Solo In Place is activated on the console, any active solos will replace the master outputs completely until the solo is removed.



# Multi Function Input Channels

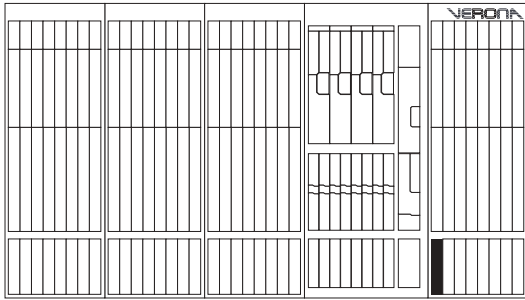

**Mute 1,2,3 & 4** - The Verona has four (4) automute busses that can be controlled from the centre section of the console. To assign an input channel to an automute, switch in the desired mute switch.

Commonly, these are used to mute similar channels, for example:

Channels	Reason
Drum Mics	Allows the engineer to mute the whole drum kit at once.
Choir Overheads	Allows the engineer to quickly remove all choir mics at once
Orchestra Parts	Allows the engineer to zone mics together (e.g. Brass, Strings, etc.) and mute sections together if they were not playing.

Note that if any assigned automute or the channel mute is activated then the channel will be muted until all assigned automutes and the channel mute are removed (i.e. the mutes work like a logical OR where any single or combination of mutes will mute the channel output).

**4 LED Meter** - Each input channel contains in-channel monitoring allowing the user to monitor the input signal without the need for using the PFL.

The in-channel meter is especially useful when setting the microphone gain of a channel. Also, as the meter is post-EQ, it is possible to see the effect that the channel equalisation has upon the level. It may be necessary to turn the input gain down when excessive EQ is used to prevent the channel from overloading.

Note: The LED meter is Post-Insert and EQ but Pre-Fader and Mute.

**Channel Fader** - The channel fader allows for continuous adjustment of the channel level from off (-inf) to +10dB.

At 0dB, the output of the channel to the Stereo, Mono and Group busses will be at unity (i.e. no boost or cut in level from the input).

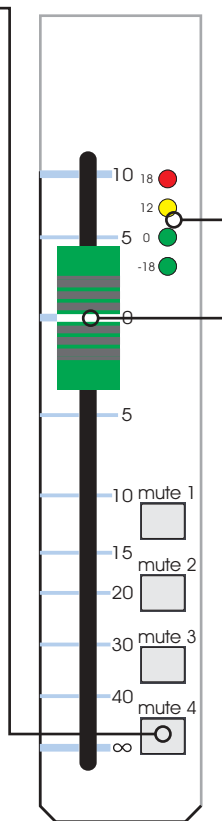

## Multi Function Module hints & Tips

### I want direct outs for recording but multi function channels don't have any . . .

The multi function channels don't have a specifically labelled direct output BUT, if you are using a microphone input and don't need to use the insert channel, you can insert a standard unbalanced quarter-inch jack lead into the insert point and use this as a direct output. This will work on the condition that you do not activate the insert point on the channel strip (the insert switch) as this will cause signal to the channel to be lost.

To see for yourself why this works, look at the block diagrams later in the manual.

### I'm running monitors from FOH and I've run out of auxes for effects . . .

To add effects to a mono mic on a multifunction channel, use the insert send of the channel into the effects unit and the stereo outputs into the stereo line inputs of the same channel. Use the mic gain for the mic and the line gain for the effect return level. Now the aux sends and channel fader will control both the mic and effects.



# VERONA

## Output Module

- groups -
- auxes -
- masters -
- matrixes -
- talk buss -
- solo control -
- automutes -

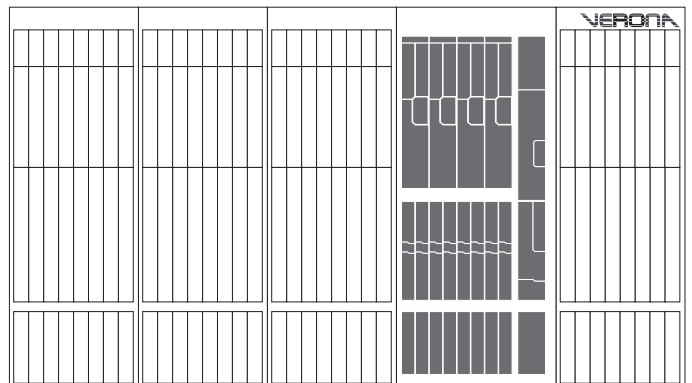

# Output Module Notes

Before looking at the function of the output section of the console it is essential that the user is first comfortable with a few of the console's features that affect groups, matrixes and auxes. Rather than discuss these features in each section (although they will be repeated there) an understanding of their function in a more general context is desirable.

## Group Aux Changeover

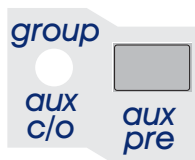

The Verona is a dual purpose console. That is, that the Verona is equally as comfortable as a monitor console as it is as a front of house console.

### What does this actually mean?

**Monitor** engineers tend to prefer the output faders on their console to operate the auxiliary outputs (for monitors) where **Front of House** engineers would rather have their output faders for groups (either for sub mixes or delay/alternative outputs).

The Verona achieves this flexibility using the **group aux c/o** (changeover) switch. Each output can be individually 'changed over' so that the group output path becomes that of the aux output and vice versa.

### Why not buy a monitor or FOH console?

The Verona has been developed with real world sound engineers in mind. The real flexibility of the Verona is in the speed in which the change over can be made and also the ability to create a **hybrid** console that can be used for FOH and monitors for the smaller venue where you still need monitors but don't have space or money for a monitor engineer or console.

Depressing the group aux changeover switch (using a pointed object such as a pencil) will connect the auxiliary buss to the group **insert**, group **mute**, group **fader**, group **pan** and finally the group **output XLR**.

The group buss is connected to the auxiliary output **pot** and to the auxiliary **output XLR**.

This routing flexibility is available on each group/aux buss.

## Meter Changeover



It is possible on the Verona to change the group meters to monitor the aux or matrix output rather than the group output. For example, if using the matrix outputs to drive delay speakers, it may be desirable to monitor the output from those outputs.

When depressed, the **aux** switch will send the aux signal to the meter array (note that, if you have used group aux c/o, the aux switch should really read group!).

When depressed, the **mtx** switch will send the matrix signal to the meter array. This switch ALWAYS overrides the aux meter select switch and must be released to allow the aux signal to be sent to the meter array.

Note: Meters are Post Fader and Post Mute

### TIP

If you wish to understand more about how the Verona routes its signals, please refer to the block diagram section of this manual.

## Direct Inputs

The Verona has four (4) direct inputs on balanced TRS quarter-inch jack sockets located next to the matrix outputs on the rear panel which can be used for console linking or effects returns.

**Mono** - Routes the direct input to the main mono buss.

**Mtx** - Routes the direct input to the similarly numbered matrix buss (i.e. 1 through 4).

**Solo** - Routes the direct input to the mono PFL and stereo AFL buss

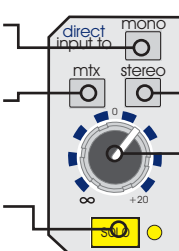

**Stereo** - Routes the mono direct input to the main stereo Left and Right busses equally.

**Level** - The direct input level is continuously variable from off (-inf) to +20dB.

# Verona Group Outputs

## Rear Panel

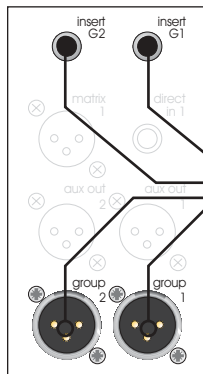

Each group buss can be connected to external equipment by means of one single balanced male XLR socket (0dBu nominal level).

In addition to this, each group can be inserted into by means of a single unbalanced quarter-inch TRS jack conventionally wired (0dBu nominal level).

Group Insert  
Group Output

### XLR Sockets

1 - Screen 2 - Signal Hot 3 - Signal Cold

### TRS Insert Jacks

T - Signal Send R - Signal Return S - Screen

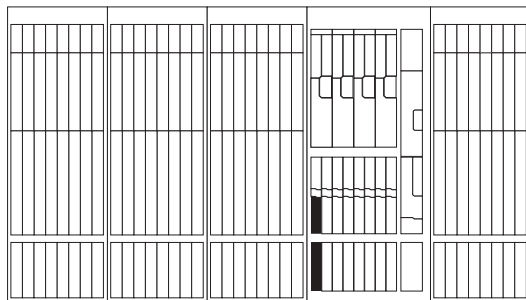

## Front Panel

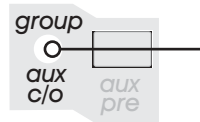

**Group Aux C/O** - The group auxiliary changeover switch is described on the previous page. When enabled, auxiliary signals are routed into the group output controls and hence group should be mentally changed to 'aux'.

**Group to Mtx** - The group to mtx switch routes the group signal to the matrix send pots (discussed later in this section).

**Mono** - When depressed, the signal will be sent to the main mono buss via the master sis switch.

**Pan** - The pan control allows the channel signal to be positioned in a stereo field when routed to the stereo buss. The pan control allows continuous adjustment of the image from hard left, to hard right with a centre detent and obeys a constant power law (i.e. -3dB at the centre so that the output remains at unity).

**Mute** - The mute switch mutes the group signal at all points after the insert return (and hence any matrix sends).

**Solo** - The solo switch sends the group signal to the AFL stereo and PFL mono busses.

**Fader** - The fader allows continuous adjustment of the group output level from off (-inf) to +10dB.

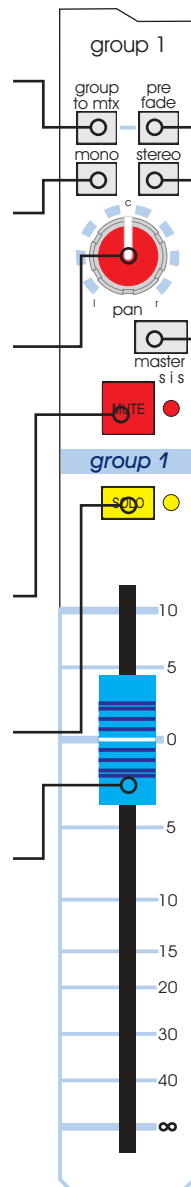

**Pre-Fade (Group to Mtx)** - When depressed, the signal sent to the matrix send pots is sourced pre-fader and hence the level will be proportional to the matrix send pot only. This may be desirable if using the matrix for recording or monitoring (e.g. stage side fills).

**Stereo** - When depressed, the signal will be sent to the main stereo buss via the pan and master sis switch.

**Master SIS** - The master SIS switch will enable the spacial imaging system whereby the channel pan control operates in a different way. When panned hard left, signal is routed to the stereo left output as normal, similarly when panned hard right, the signal is routed to the stereo right output as normal. However, when panned centre, the signal is routed ONLY to the mono output creating a LCR (left-centre-right) system instead of the normal LR (left-right) system.



# Verona Matrix Outputs

## Rear Panel

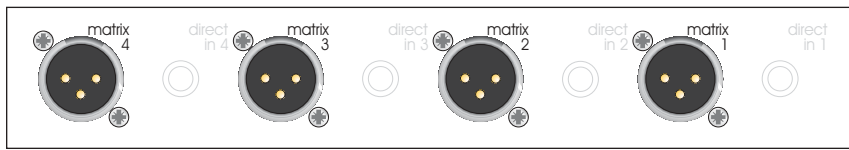

The Verona's matrix outputs can be found on the rear of the console.

Four male XLR sockets are provided, one for each matrix output.

### XLR Wiring

Pin 1 - Shield, Pin 2 - Hot Signal, Pin 3 - Cold Signal

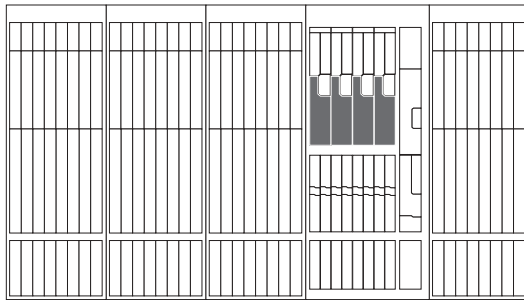

## Front Panel

The matrix provides another four outputs from the console which can be 'made' from a combination of the console's other outputs.

The matrix signal can be made by combination of the group buss signals and mono, left and right master signals. They can be used to drive additional speaker zones or as effects sends from the groups (like the auxes from inputs)

**Group (1-8)** - The group level sent to the matrix is continuously variable from off (-inf) to +6dB. Unity (0dB) is also marked on the scale allowing signal to be routed to the matrix without any attenuation or gain.

Each of the groups (1-8) has its own individual matrix send level.

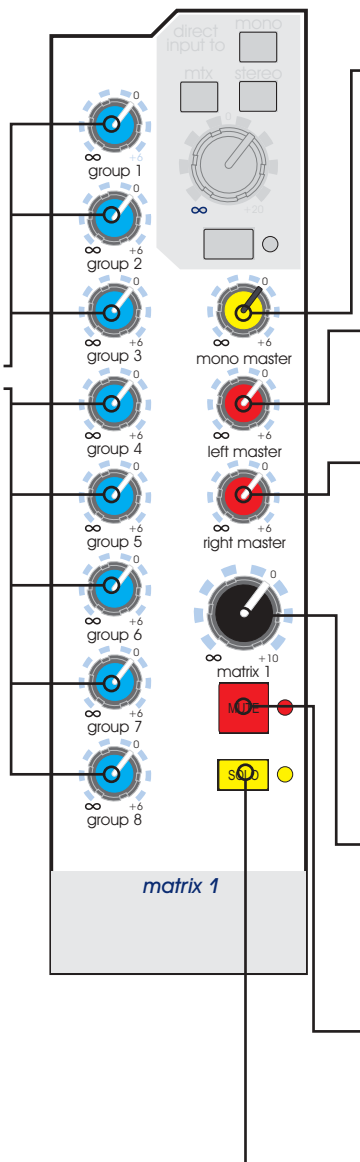

**Mono Master** - The master mono signal sent to the matrix is continuously variable from off (-inf) to +6dB. Unity (0dB) is also marked on the scale allowing signal to be routed to the matrix without any attenuation or gain.

**Left Master** - The master left signal sent to the matrix is continuously variable from off (-inf) to +6dB. Unity (0dB) is also marked on the scale allowing signal to be routed to the matrix without any attenuation or gain.

**Right Master** - The master right signal sent to the matrix is continuously variable from off (-inf) to +6dB. Unity (0dB) is also marked on the scale allowing signal to be routed to the matrix without any attenuation or gain.

Alternatively, the auxiliaries can be routed to the matrix by depressing the group/aux changeover switch. This is especially useful for generating additional monitor mixes or re-routing existing monitor mixes (for example if artists are moving around to other parts of the stage).

The overall level of the matrix output is controlled by the **Matrix x** pot (where x is the number of the matrix 1 through 4) and is continuously variable from off (-inf) to +10dB.

**Mute** - The matrix output can be muted immediately after the group and master matrix sends.

**Solo** - The solo switch routes the matrix signal to the mono PFL and the stereo AFL buss.



# Verona Aux Outputs

## Rear Panel

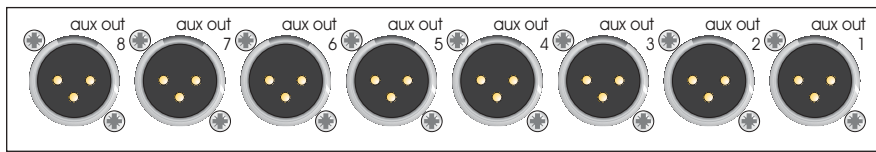

The Verona's auxiliary outputs can be found on the rear of the console.

Eight male XLR sockets are provided, one for each auxiliary output.

### XLR Wiring

Pin 1 - Shield, Pin 2 - Hot Signal, Pin 3 - Cold Signal

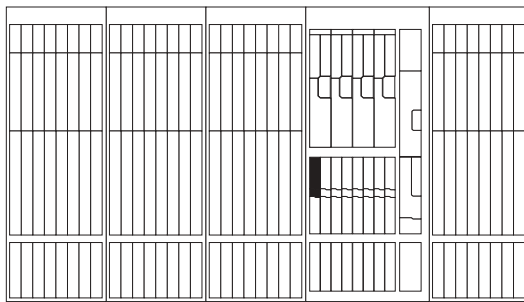

## Front Panel

The Verona provides eight independent auxiliary outputs which are controlled in this section.

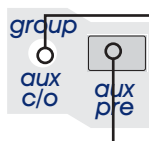

**Group Aux C/O** - The group auxiliary changeover is described at the beginning of this section. When depressed, group signals will be controlled in this section and hence aux should be mentally interchanged with 'group'.

**Aux Pre** - The auxiliary pre switch is the global control which determines whether the auxiliary is taken from the input channel pre fader or post fader. This switch can be found on each of the auxiliaries 1 through 6. On aux 7 and 8 these are assignable individually pre/post on the channel modules.

**Pre-Fade** auxiliary (aux) sends are sourced after the channel Insert, Mute and EQ but before the channel fader (and EQ on 1-6 if the Aux Pre EQ switch is depressed). As a result, the actual level sent to the aux buss is proportional to the aux send control only.

**Post-Fade** aux sends are sourced after the channel Insert, Mute, EQ and channel Fader. As a result, the actual level sent to the aux buss is proportional to the aux send control AND the channel fader.

Typical uses of auxiliaries are:

Application	Pre/Post Fade	Reason
Stage Monitors	Pre (Post-EQ)	The level in the monitor stays constant so that the engineer can change the FOH level without affecting the performer.
Effects Sends	Post	The level sent to the effects is proportional to the level on the fader so the balance between wet (processed) and dry (un-processed) sound stays the same even when the channel level is changed
Multi Track Recording or Monitors from FOH	Pre (Pre-EQ)	The recording is made at constant level without any equalisation so that changes in the mix level and EQ can be set in post-production. (You can also use the Direct Out for this but the output will be at unity).
Mixed Recording (for the artist)	Post (Post-EQ)	If the aux is set to unity, the FOH mix is replicated on the aux output including EQ but excluding PAN.

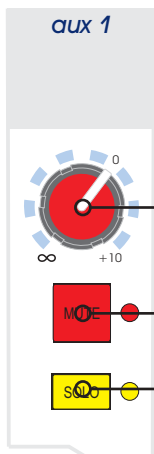

**Auxiliary Master Level** - The output level of the auxiliary is continuously variable from off (-inf) to +10dB.

**Auxiliary Mute** - When depressed, the auxiliary signal is muted at every point after the master send level.

**Auxiliary Solo** - When depressed, the auxiliary signal is sent to the stereo AFL and mono PFL busses.

# Verona Master Outputs

The Verona's main outputs are located on the rear of the console and provide:

Output	Source	Connector	Nom. Level
Master L	Left Buss	XLR Male (Bal)	0dBu
Master C	Mono Buss	XLR Male (Bal)	0dBu
Master R	Right Buss	XLR Male (Bal)	0dBu
Monitor L	AFL Solo L Buss	XLR Male (Bal)	0dBu
PFL Out	PFL Solo Buss	XLR Male (Bal)	0dBu
Monitor R	AFL Solo R Buss	XLR Male (Bal)	0dBu
Tape Out L	Master Left	RCA Phono	-10dBu
Tape Out R	Master Right	RCA Phono	-10dBu
Talk Out	Talk Buss	XLR Male (Bal)	0dBu

Also provided are Master L-C-R insert points on conventionally wired quarter-inch TRS jacks (0dBu nominal level), tape inputs (RCA Phono, -10dBu nominal level) and Talk Input (Male XLR balanced, 0dBu nominal level).

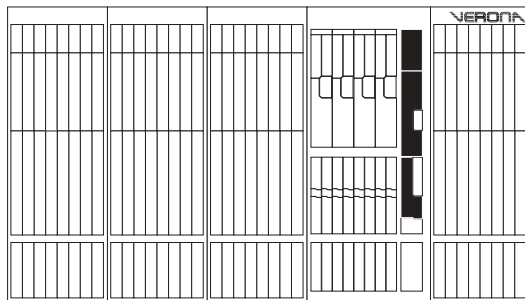
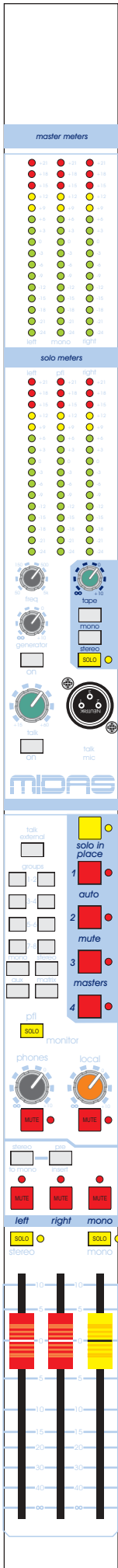
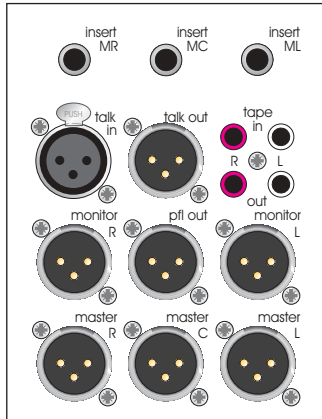

## Master Meters

The master meters show the actual peak output level from the console's left, right and centre (mono) busses.

Note that these meters are post master fader and post master output mute.

## Solo Meters

The solo (AFL L, AFL R and PFL) buss levels are shown on the solo meters. The solo meters are pre monitor or phones output mute and level and so are unaffected by changes in the headphone level or the level sent to the monitor outputs.

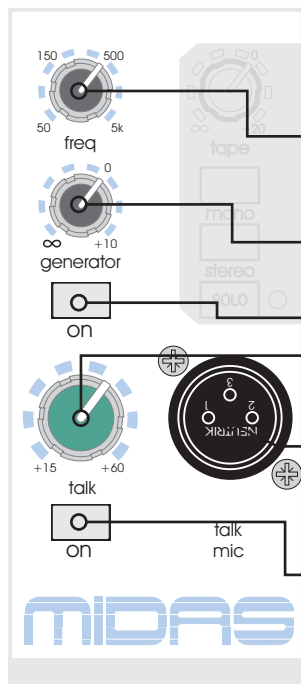
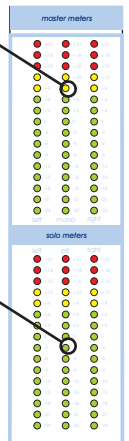

The Verona provides a signal generator which can be routed to any of the console's outputs.

**Freq** - The output frequency of the generator is continuously variable from 50Hz to 5kHz allowing the user to test, for example, three or four bands of a crossover system.

**Generator Level** - The level of the generator output is continuously variable from off (-inf) to +10dB.

**Generator On** - Enables the Signal Generator

**Talk Mic Gain** - The gain of the talk microphone input is continuously variable from +15dB to +60dB.

**Talk Mic** - The talk mic socket is a conventionally wired XLR male and is supplied with 48v phantom power allowing the connection of condenser microphones.

**Talk On** - When depressed, the talk microphone input is enabled and routed to the talk buss. When enabled, all local outputs are attenuated by 20dB to help prevent feedback.

# Verona Master Outputs

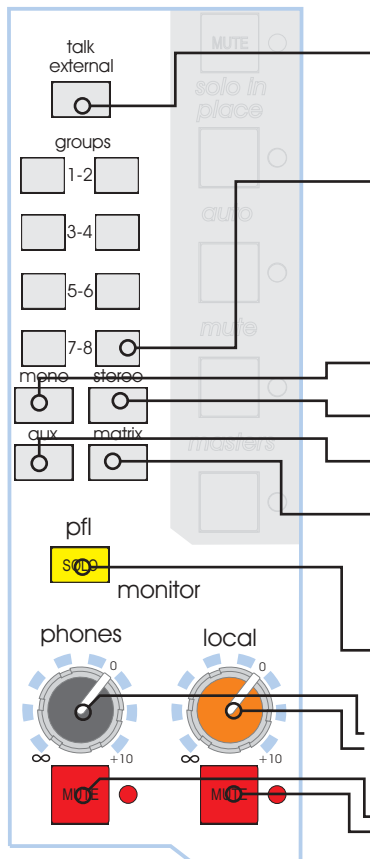
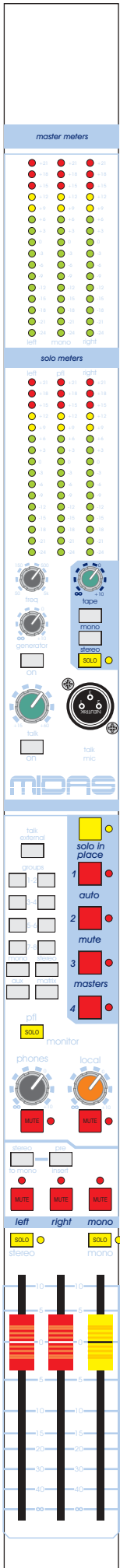
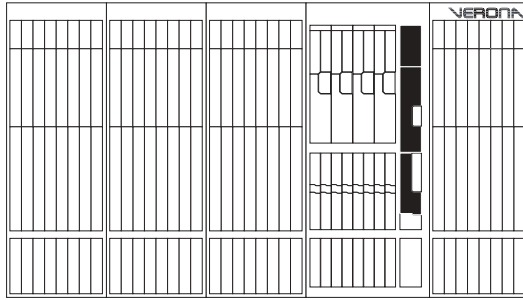

**Talk External** - Talk external enables the talk out and talk in signals on the rear of the console. The talk in signal is summed with the internal talk mic and generator signals.

**Groups 1-8** - When depressed, the talk buss signal is routed to the group buss.

**Mono** - When depressed, the talk buss signal is routed to the mono buss.

**Stereo** - When depressed, the talk buss signal is routed to the stereo buss.

**Aux** - When depressed, the talk buss signal is routed to the aux buss.

**Matrix** - When depressed, the talk buss signal is routed to the matrix buss.

Note: Essentially with all buttons depressed, the talk buss signal is routed to all the console's busses (except the local outputs and direct outputs).

**PFL Solo** - When depressed, the local monitor and headphones signal is sourced from the PFL mono signal rather than the AFL stereo default.

**Phones/Local Level** - The local and headphones level is continuously variable from off (-inf) to +10dB.

**Phones/Local Mute** - The local and headphones signal can be muted by depressing the mute switch.

# Verona Master Outputs

The controls on this page are those directly responsible for the main outputs from the console.

**Stereo to Mono** - When depressed, a sum of the stereo left and right signals are routed to the mono signal buss via the pre insert switch.

**Pre Insert** - When depressed, the stereo signal sent to the mono buss is sourced from the stereo signals before the stereo insert points. Otherwise the signal is taken after the stereo inserts.

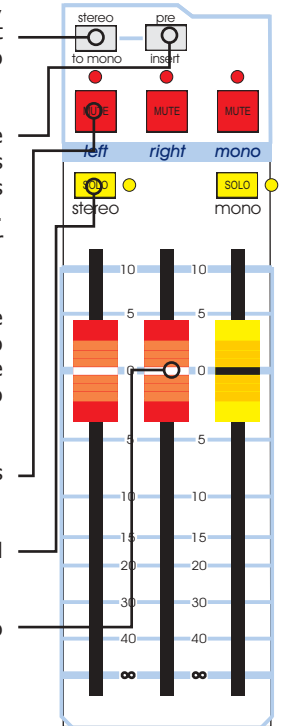

The setting of this depends upon the circumstances (and the usage of the centre mono output). For example, if an independent graphic EQ or limiter is required to control the mono centre speaker, then it may not be required (or desired) to have the graphic EQ/limiter inserted into the left and right output affect the mono centre.

**Mute** - Each of the left right and centre outputs have individual channel mutes which mute the signal post fader.

**Solo** - When depressed, the stereo or mono signal is routed to the PFL mono and AFL stereo busses.

**Output Level** - Each output level is continuously variable from off (-inf) to +10dB.

# Verona Features

The tape input on the rear of the console can be routed to the main mono or stereo busses by pressing the **Mono** or **Stereo** switches. The level of the tape input is continuously variable from off (-inf) to +20dB (the nominal input level is referenced to -10dB).

**Solo** - When depressed, the tape input signal is routed to the stereo AFL and mono PFL busses.

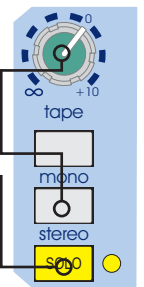

**WARNING: Solo in place is a major function and should be used for sound check ONLY. Please read this information carefully!**

**Solo in Place** - When depressed with a small object (eg. screwdriver or pencil tip), the solo in place switch causes all active input solos on the console to be exclusively routed to the main outputs of the console. (i.e. mute all un-soloed inputs).

i.e. If a solo is in place, only those active solos will be heard from the main front of house speakers. This is a major function worthy of note.

The solo in place function is more at home in studio surroundings where the engineer would expect only to hear active solos through the monitors. It's uses in live sound reinforcement are limited but include:

At sound check, Solo In Place could be used to check or EQ (or adjust insertions, effects etc.) for one or a number of channels at once without having to turn down or mute each of the undesired channels (which may upset the onstage monitors and hence the musicians!).

**Auto Mute Masters** - The auto mute masters are used to enable the mute groups (1 through 4) as assigned on the input channels.

Again, these switches are a major function worthy of note (i.e. don't forget that you have them enabled and the channels assigned or channel mutes will not be released).

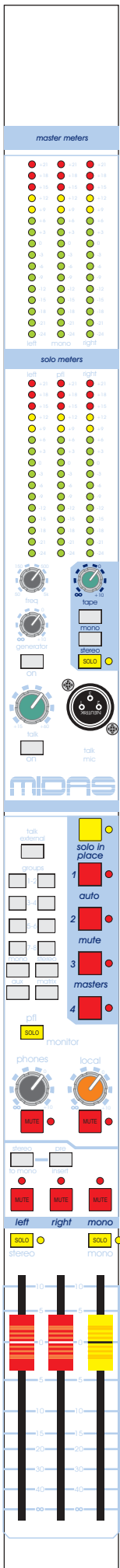



## Setting up the Verona

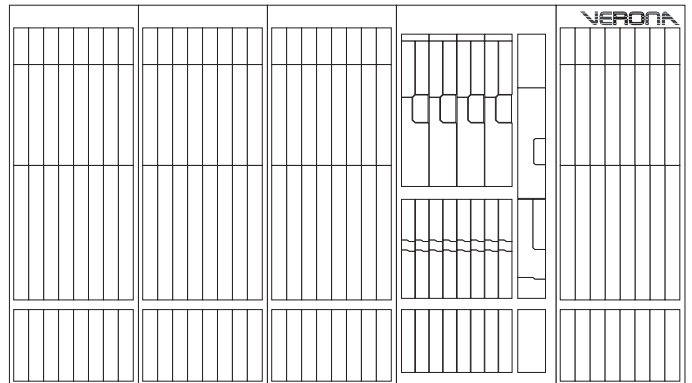

# Setting Up The Verona

The Verona was designed with real world sound engineers in mind, working in the real world. With it's flexible routing and dual purpose functionality, the Verona is as happy running monitors as it is front of house. For engineers that haven't got a great deal of experience in live sound engineering, here are a few helping guidelines.

## Gain

The Verona has two types of input channel; Mono and Multi Function (Stereo) both of also have a mono microphone input. Gain is provided on these channels to allow the operator to obtain the optimal signal for the system.

Microphone Gain	+15dB to +60dB (0dB to +45dB with pad switch enabled)
Mono Channel Line Gain	0dB to +45dB (-15dB to 30dB with pad switch enabled)
Stereo Channel Line Gain	Off to +20dB

Each channel of the Verona includes an in-line channel LED meter indicating the channel level (measured after the channel insert and EQ but before the channel fader). With the insert and EQ disabled, the in-channel meter will show the level at the input in four stages:-

-18dB	- Signal Present
0dB	- Normal operating level
+12dB	- High Signal Level
+18dB	- 3dB before channel overload (clipping)

The input gain of the channel can be used to obtain the best operating level for the console. Too small a signal level (too little gain) and the best signal to noise ratio will not be achieved; too high a signal level (too much gain) and there is the chance of overloading the channel causing distortion.

Clearly, the gain should be positioned between these two points, to gain an optimal signal to noise ratio without overloading the channel. The ideal level for input channels would be around +6dB with occasional illumination of +12dB.

## Headroom

A channel signal is only permitted to swing high and low by an amount fixed by the power supply. If the maximum output of the Verona channel strip is +21dBu (0dBu = 0.775 volts RMS) then imagine the following situation:

Headroom is the amount of spare 'swing' available to the system. If 6dB headroom was desired at all times, a maximum level of +15dB is required to retain the headroom.

To prevent overload, the gain must be set to a point that even the highest output from the microphone during sound check has some headroom left to prevent any surprises during the show!

The consoles Busses (e.g. Left and Right Main buss) are the point where all channel signals are summed together. In normal operation, it is unlikely that all channels will receive the same signal at the same time so typically when 48 channels are summed together a gain of around 6 to 9dB will be seen. It is important to leave some headroom in the summing amplifiers so that they do not overload, should the sum exceed the maximum level.

## The Effect of EQ

Channel equalisation should be used with care. Boosting or cutting equaliser bands can make monitoring your actual input level very difficult. Excessive boosting of EQ (+15dB is available on each band) will have the same effect as applying more gain to the input, taking up valuable headroom. Consider backing off the channel gain when using large amounts of boost (if you have to use large amounts of boost) to retain a sensible level at the output.

Excessive EQ cut can have a similarly undesirable effect. If a large amount of signal is cut in the equaliser section, gain may be used to 'make up' the level lost in the equaliser. However, the input pre-amplifier still has the same amount of available headroom. If gain, added to 'make up' the loss in the equaliser, exceeds the maximum level into the microphone pre-amp then the channel won't appear to be overloaded but the microphone pre-amp will. Turning off the equaliser will reveal the true story, whereby the microphone pre-amp may be overloaded. It is worth considering whether such large amounts of EQ cut is really required, or whether it is being used rather more as a volume control (in which case the input gain could be set to a normal operating level and the output adjusted on the channel fader).

TIP: You can monitor the level pre-EQ and post-EQ using the in-channel LED meter by switching the EQ in and out during sound check.

## Dynamic Processing

When working with signals that are constantly at a high level, the channel gain can accommodate these signals with ease. When working with varying signals (such as the vocalist discussed earlier) it may be desirable to reduce the dynamic range of the signal so that the loud parts aren't so loud (and don't overload your channel input) and the quiet bits aren't too quiet (so the signal to noise ratio would be increased).

Limiters and Compressors have a similar function which is to reduce the dynamic range of a signal. The means by which they do this won't be discussed here but, these devices have the ability to reduce the level of loud signals automatically and also raise the gain to 'make up' the level as desired. The channel gain can now be set with adequate headroom to accommodate both loud and quiet signals and the compressor can reduce the dynamic range and 'make up' any reduction in level. By inserting such a device into the channel's insert point you have the ability to remove the guesswork from setting your system gain.

However (and this is a big however), there are still sources of potential problems. The Verona is able to operate at levels up to +21dBu on both the insert send and return. If the maximum input level of the compressor was less than +21dBu then it is possible to overload the input of the compressor. The only way to resolve this situation would be to drop the channel input gain so that the input level of the compressor was not being overloaded. Bear in mind however, the level returned from the compressor would also be lower than +21dBu and excessive use of the compressor 'make up' gain would overload the output of the compressor!

## Unity Gain

Unity gain is a gain of 1 (i.e. no gain or attenuation is applied to a signal).

If a signal entered a mono line level input of the Verona at 0dBu and the gain was set to +15dB (an internal 15dB attenuation sets the net gain to 0dB), then the signal was routed to each output at 0dB, the channel fader was set to 0dB and each output fader was set to 0dB, the output should be 0dBu (or unity). Some console manufacturers mark the 0dB level of their faders and pots 'U'.

Simple. But that's just one signal. If we have two 0dBu signals entering the Verona to be summed in the busses, the output would no longer be 0dBu.

Simply,

$$\begin{aligned} 0\text{dBu} &= 0.775 \text{ volts} \\ 0.775 \text{ volts} + 0.775 \text{ volts} &= 1.55 \text{ volts} \end{aligned}$$

$$1.55 \text{ volts is } 0.775 \text{ volts } +6\text{dB (or a gain of 2)}$$

To retain an output of 0dBu (our previous unity level) each input must be reduced.

$$\begin{aligned} 0.775 \text{ volts} / 2 &= 0.3875 \text{ volts} \\ 0.3875 \text{ volts is } 0.775 \text{ volts } -6\text{dB (or a gain of } 1/2) \end{aligned}$$

So each fader must be reduced to -6dB to retain the unity gain level of 0dBu on the console output. When using four inputs at 0dBu, the faders must be reduced to -12dB. Real life signals are not continuous, but the principal is the same. If you have a sinusoidal input that is nominally 0dBu on all 48 inputs with the channel faders at 0dB, the output is likely to be well above the 21dBu maximum output of the console and leave no headroom spare. With real world signals, 48 channels summed together will give around 6 to 9dB gain because it is unlikely that all 48 channels will receive the same signal at the same time. Instead signals will occur at different times, and there will be cancellation due to phase and frequency differences.

## Signal Processing and Amplifiers

The final links in the system tend to be graphical equalisers, loudspeaker processors and finally amplifiers and speakers.

Graphical equalisers have the same problems as the Verona's EQ. If excessive boost is applied to the signal, the graphic equaliser's output may be overloaded. If, the output of the Verona is higher than the maximum input level of the graphic, the input of the graphic may be overloaded.

Loudspeaker processors have similar problems. If the input level to the processor is too high, the input may be overloaded and introduce distortion into the outputs (and to the speakers!). In addition to this, any boost on the processors outputs (say you want 3dB more bass) will cause that output to overload earlier (in this case 3dB before the other outputs).

Finally, amplifiers can introduce the most interesting results.

An amplifier has a sensitivity. That is, an input signal level that causes the amplifier to produce it's maximum output level. For many amps this is 0dBu (0.775 volts RMS), others use 0dBV (1 volt RMS) others use different levels. Beyond this sensitivity, the amplifiers output will not be able to produce any more power and 'CLIP' (usually indicated by some serious looking red lights). Sending +21dBu level from the Verona will clip the output of the amplifier causing damage to your loudspeaker system.

There are a number of solutions to this problem:

Reduce the amplifiers input attenuators to a level where the amplifier and console clip at the same point.

e.g. The input sensitivity is 0dBu, setting the input attenuator on the amplifier to -21dB would mean that the console would clip at the same time as the amplifier. So operating the console sensibly the amplifier should never be clipped. The console led Meters will also accurately show the available headroom left in the entire system.

-21dB may not be a sensible level to set as many operators choose not to run the output of the console so high. That is personal choice.

Run the output of the console at a level below 0dBu

This solution means that you won't get full benefit of the console, and may suffer a reduced signal to noise ratio. But the amplifiers should be saved from clipping.

As with many things in the audio world, use your ears. If something sounds distorted check:

Input Gain too high?	(lower input gain and check)
EQ Too Much Boost?	(disable eq and check)
EQ Too Much Cut coupled with a High Input Gain?	(disable eq and check)
Too High a level into Inserted Processor?	(disable insert and check)
Clipping Loudspeaker controller or Amplifiers	(Check CLIP lights on amps etc.)



## Routing

The flexible routing of the Verona allows the console to operate as both a Front of House (FOH) and Monitor console, or as a combination of both. For operators that haven't got a great deal of experience, here are a few helping guidelines.

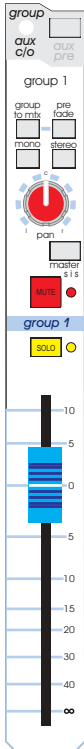

### Front of House Mode

The group aux changeover switch on each group should be released (i.e. off) so that the group fader controls the group buss signal.

Uses for groups vary, but include:

#### Submixes

Submixes are a common way of saving time (and possibly embarrassment) when using a large number of microphones at once. For example: Multiple Microphones for Choirs, Drum Kits/Percussion, Orchestras, etc . . .

The channel to be submixed should be routed to the group and any aux sends ONLY (i.e. not to the master L-C-R). The fader is, as normal, used to set the relative level between the channels in the submix. The group chosen for the submix should then be routed to the master L-C-R and panned as required.

The submix is now set up. The group level can be used to control the overall level of the channels (retaining their relative levels), mute the submix output or solo the submix signal.

Note: Muting the submix is not the same as muting the channels. Aux sends and other group sends will remain active. If channels in a submix are required to be muted, use the automute facility.

#### Common EQ/Processing

Often, it is either too expensive or undesirable to apply processing to each channel individually (for example: compression on a whole choir, graphic eq on a number of microphones, etc...). Setting up a submix as above, the signal is grouped together. Now the desired processor can be inserted into the group inserts applying the process to all of the submix channels (in their relative levels).

#### Alternative Outputs

example:, you were mixing a number of speakers in a venue and each needed a different level and processing.

Route the desired channels to any group or master output as necessary. Make sure the group is not routed to the main outputs. The group outputs should be wired into the necessary amplification and the insert points into any necessary processing (e.g. delay, EQ, etc...).

The levels are now individually controllable.

### Monitor Mode

The group aux changeover switch on each group should be depressed (i.e. on) so that the group fader controls the aux buss signal.

Channel signal should be sent to the auxiliary as required and the aux sends should usually be configured to pre-fader. The console group output sockets should be wired into the necessary amplification and the insert points into any necessary processing (e.g. EQ, etc...).

The monitor levels are now individually controllable on the group faders.

### Dual FOH/Monitor Mode

The group aux changeover switch on each group should be depressed (i.e. on) so that the group fader controls the aux buss signal for monitors or released (i.e. off) so that the group fader controls the group buss signal for FOH. The usage in this split mode can be any combination of the above!

Note: When the group aux changeover switch is depressed, control over the groups is performed by the auxiliary controls and hence, and group outputs may still be used. Submixes could be used by connecting the auxiliary output sockets on the rear of the console to four unused stereo input channels and routed to the Left and Right master busses.





# Functional Block Diagrams

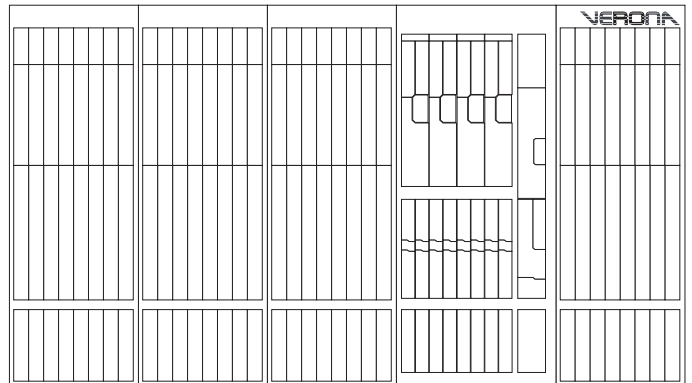

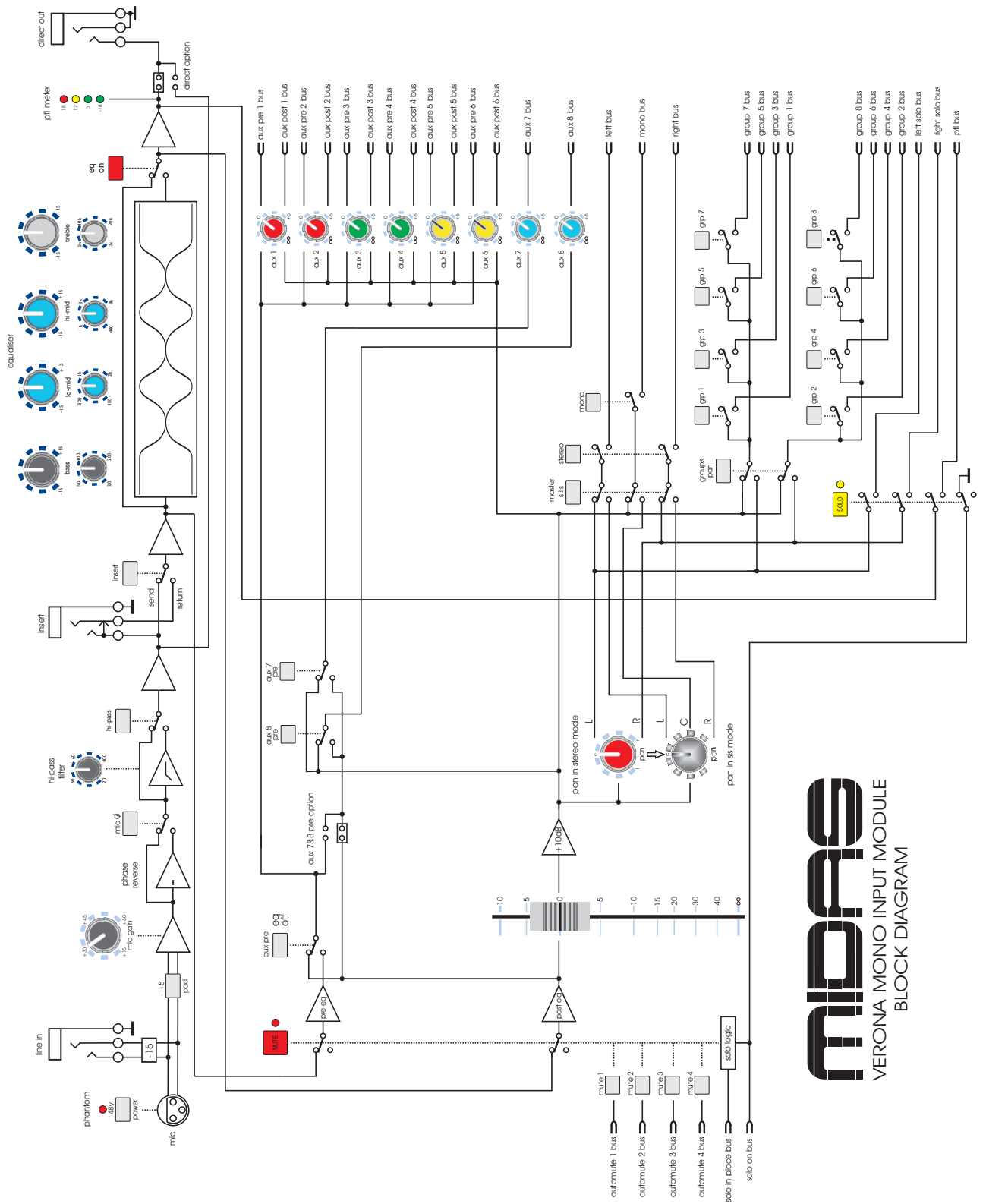

## miDPS

VERONA MONO INPUT MODULE  
BLOCK DIAGRAM

# MIDPES

## VERONA MULTI FUNCTION INPUT MODULE BLOCK DIAGRAM

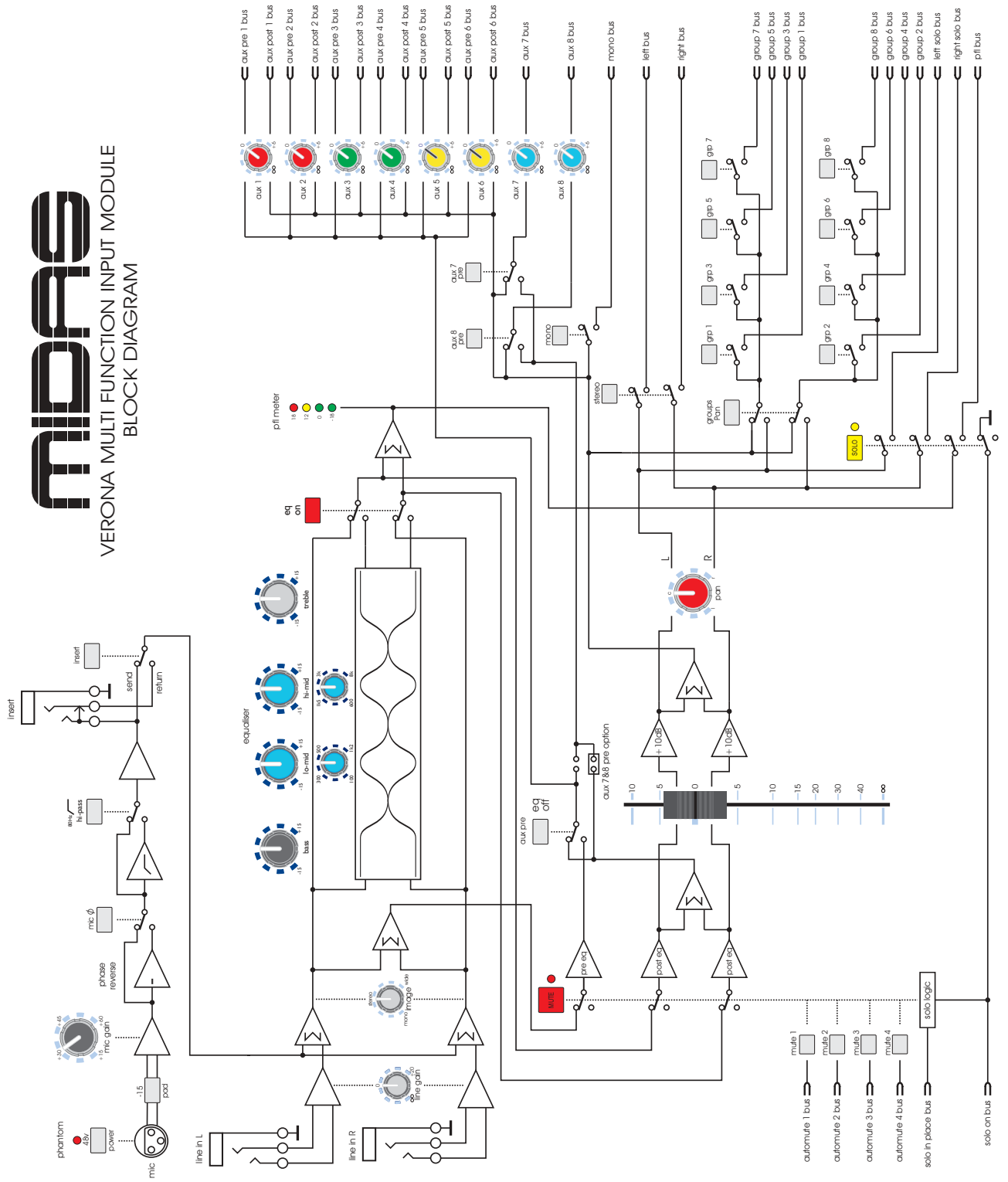

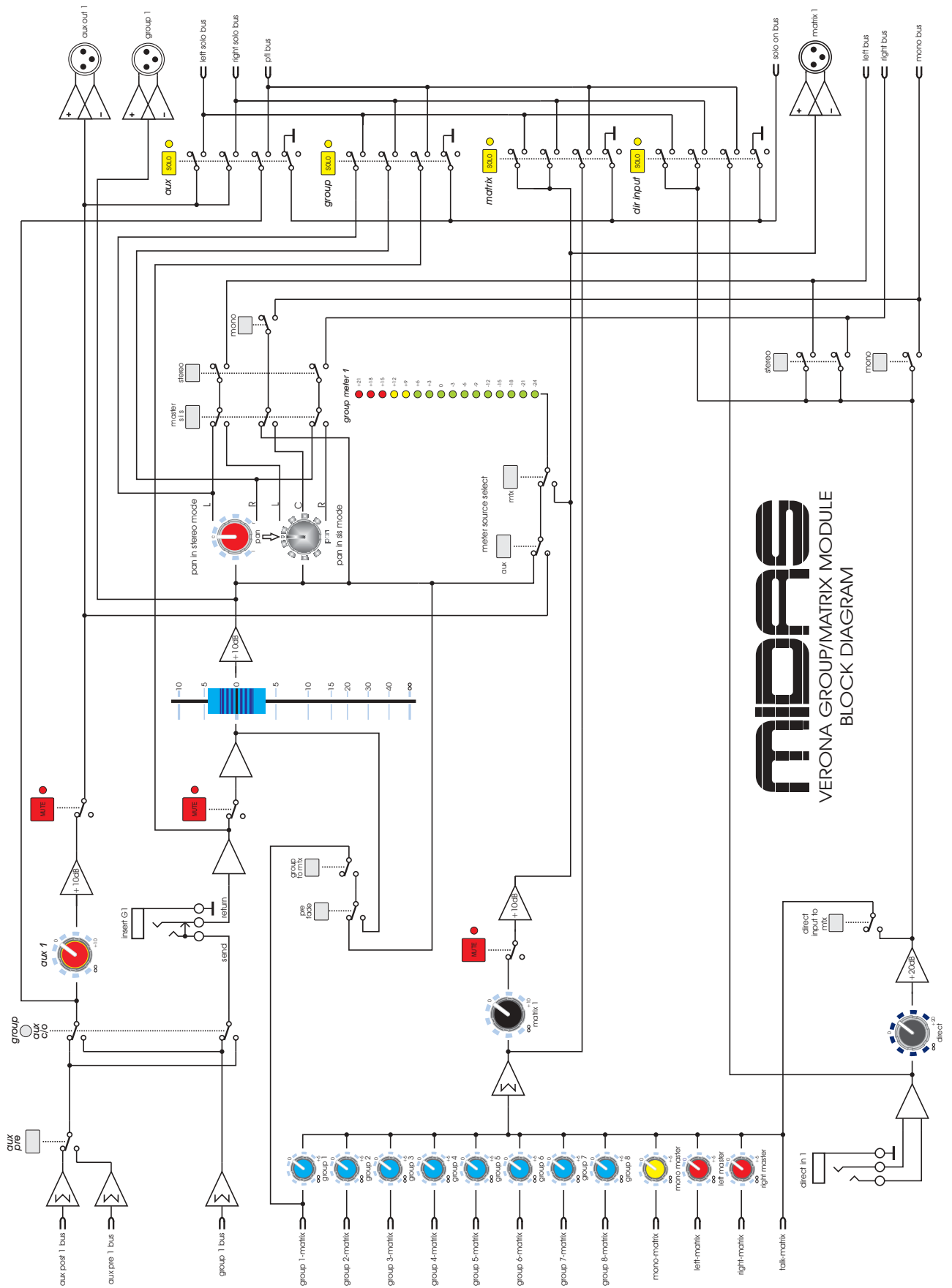

## MIDAS VERONA GROUP/MATRIX MODULE BLOCK DIAGRAM

## MIDPFS VERONA MASTER MODULE BLOCK DIAGRAM

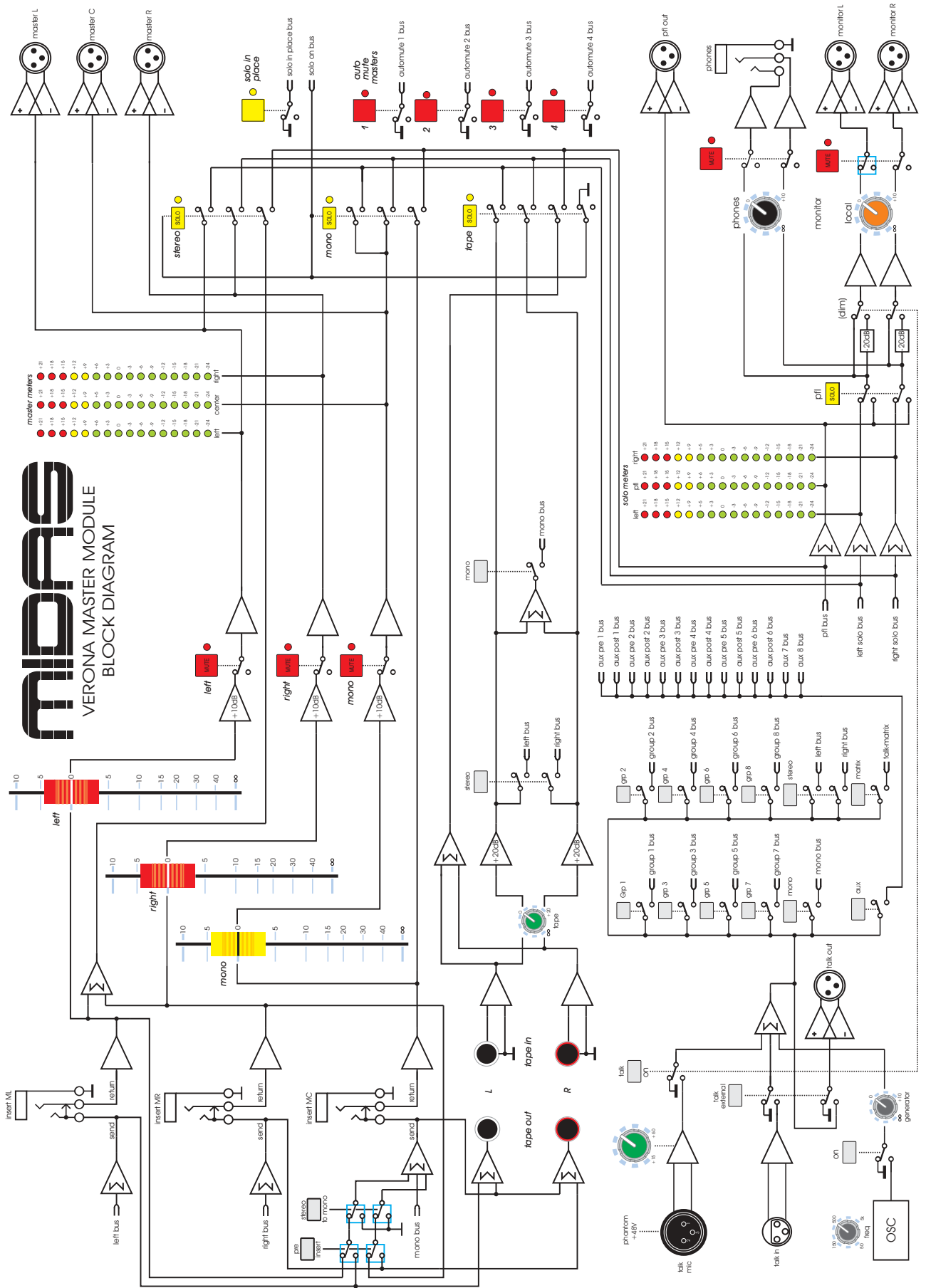







## Dimensions and Weights

				VERONA

# Dimensions and Weights

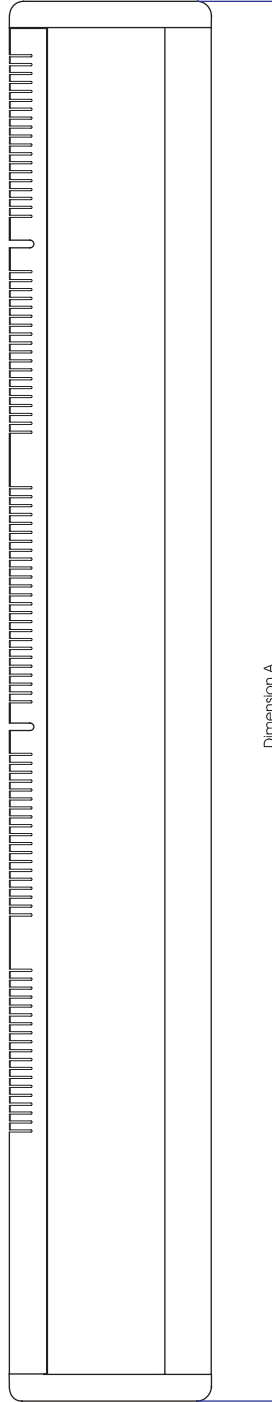
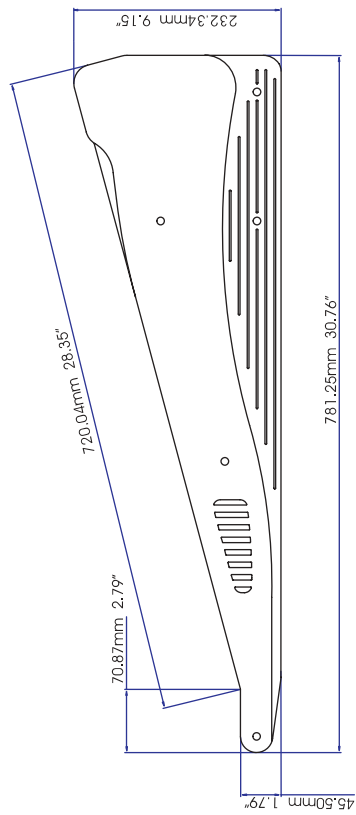

Dimension A:	Dimension A	Dimension A	Dimension A	Dimension A	Weight*	Weight*
24 channel	1085.00mm	42.72"	45kg	99.23lbs		
32 Channel	1327.00mm	52.24"	55kg	121.25lbs		
40 Channel	1569.00mm	61.78"	65kg	143.30lbs		
48 Channel	1811.00mm	71.30"	75kg	165.34lbs		
56 Channel	2053.00mm	80.83"	85kg	187.39lbs		
64 Channel	2295.00mm	90.35"	95kg	209.41lbs		

\*estimated weight out of flightcase



# Specification and Features

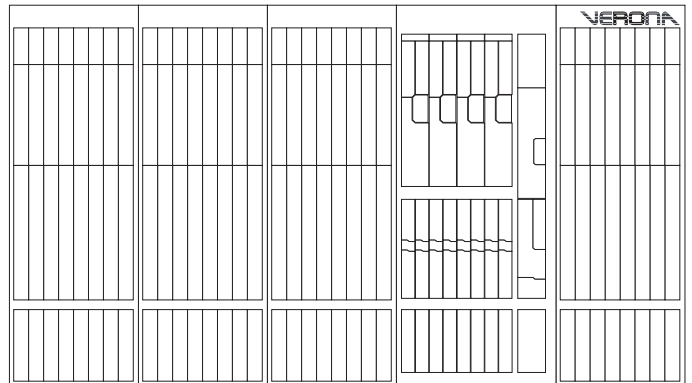

# Verona Features

The following list of features is based upon the thirty-two channel frame size console.

## The thirty-two channel Verona features:

- 24 mono input channels
- 8 stereo input channels
- 8 Auxiliary Outputs
  - 1 through 6 with Global Pre/Post Fader selection and selectable Pre/Post EQ
  - 7 & 8 with Channel selectable Pre/Post Fader selection and jumper selectable Pre/Post EQ
 For jumper selection configurations, contact you local Midas service agent.
- 8 Group Outputs
  - With Aux/Group Changeover option for dual purpose FOH/Monitor applications
- 4 Band Equaliser
  - Mono Channels: 4 Swept Frequency Bands (Treble, Hi Mid, Lo Mid, Bass)
  - Stereo Channels: 2 Shelving Bands (Bass, Treble), 2 Swept Frequency Bands (hi mid, lo mid)
- 48 volt phantom power independantly switchable on each channel (always on talk mic)
- Hi-Pass filter on all inputs (Mono Channels: Variable 20Hz to 400Hz, Stereo Channels: Fixed 80Hz)
- Signal Generator
- 32 Channel Inserts (jumper selectable pre/post insert and eq)

Inputs	Type	Connector	Impedance	Balanced	Level Nom (max)	No.
	Microphone	XLR(f)	1k5 ohm	Yes	Variable (+21dBu)	32
	M Ch Line Input	1/4" TRS Jack	10k ohm	Yes	Variable (+36dBu w/pad)	24
	MF Ch Line Input	1/4" TRS Jack	10k ohm	Yes	Variable (+26dBu)	16
	Direct Input	1/4" TRS Jack	10k ohm	Yes	Variable (+26dBu)	4
	Tape Input	RCA Phono	47k ohm	No	-10dBu (+26dBu)	2
	Talk Mic	XLR(f)	1k5 ohm	Yes	Variable (+6dBu)	1
	Talk Input	XLR(f)	10k ohm	Yes	0dBu (+26dBu)	1
<b>Outputs</b>	Direct Out	1/4" TRS Jack	100 ohm	Impedance Bal.	0dBu (+21dBu)	24
	Groups	XLR(m)	50 ohm	Yes	0dBu (+21dBu)	8
	Auxiliary	XLR(m)	50 ohm	Yes	0dBu (+21dBu)	8
	Matrix	XLR(m)	50 ohm	Yes	0dBu (+21dBu)	4
	Talk Out	XLR(m)	50 ohm	Yes	0dBu (+21dBu)	1
	Master Out	XLR(m)	50 ohm	Yes	0dBu (+21dBu)	3 (LCR)
	Monitor Out	XLR(m)	50 ohm	Yes	0dBu (+21dBu)	2 (LR)
	PFL Out	XLR(m)	50 ohm	Yes	0dBu (+21dBu)	1 (M)
	Tape Out	RCA Phono	600 ohm	No	-10dBu (+11dBu)	2
	Headphones	1/4" TRS Jack	To drive headphones > 100 ohm		+10dBu (+21dBu)	1
<b>Inserts</b>	Input	1/4" TRS Jack	50/10k ohm (s/r)	No	0dBu (+21dBu) (send/ret)	32
	Group	1/4" TRS Jack	50/10k ohm (s/r)	No	0dBu (+21dBu) (send/ret)	8
	Master	1/4" TRS Jack	50/10k ohm (s/r)	No	0dBu (+21dBu) (send/ret)	3

Total XLR input count	34
Total Jack input count	44
Total RCA Phono input count	2
Total XLR output count	27
Total Jack output count	25
Total RCA Phono output count	2
Total insert count	43



**XLR**

Pin 1 - Screen/Ground  
Pin 2 - Hot Signal  
Pin 3 - Cold Signal

Note: Sockets are viewed from the front face.

**RCA (Tape In/Out)**

Centre (Tip) - Signal  
Surround (Sleeve) - Screen



**Quarter Inch Jack**

	TRS Signal	TRS Insert	TRS Headphone
Sleeve	Screen/Ground	Screen/Ground	Screen/Ground
Ring	Cold Signal	Insert Return	Right
Tip	Hot Signal	Insert Send	Left



# Verona Specification

Internal Power Supply	Type	Switching
	Line Voltage	90 - 240V AC
	Line Frequency	50/60Hz
Input Impedance	Microphone	1k5 ohm Balanced
	Line	10k ohm Balanced
Input Gain (all faders at 0dB)	Microphone	Continuously variable from +15dB to +60dB
	Microphone + Pad	Continuously variable from 0dB to +45dB
	Mono Channel Line	Continuously variable from 0dB to +45dB (-15dB to +30dB Pad enabled)
	Stereo Channel Line	Continuously variable from off to +20dB
	Direct Inputs	Continuously variable from off to +20dB
Maximum Input Level	Mic	+6dBu
	Mic + Pad	+21dBu
	Mono Channel Line	+21dBu (+36dBu pad enabled)
	Stereo Channel Line	+26dBu
CMR at 100Hz	Microphone (Gain +40dB)	Typ 95dB
	Microphone + Pad (Gain 0dB)	Typ 80dB
	Line (Gain 0dB)	Typ 80dB
CMR at 1kHz	Microphone (Gain +40dB)	Typ 95dB
	Microphone + Pad (Gain 0dB)	Typ 80dB
	Line (Gain 0dB)	Typ 80dB
Frequency Response (20Hz to 20kHz)	Microphone to Mix	+0 to -1dB
Noise 20Hz to 20kHz	Microphone EIN ref. 150 ohms (Gain +60dB)	-129dBu
System Noise (20Hz to 20kHz)	Summing Noise (48 channels routed with faders down)	-80dB
	Line to Mix Noise (48 channels routed at 0dB, pan centre)	-75dB
Distortion at 1kHz	Microphone to Mix (Gain +40dB, 0dBu output)	<0.03%
Crosstalk at 1kHz	Channel to Channel	< -90dB
	Mix to Mix	< -90dB
	Channel to Mix	< -90dB
	Max. Fader Attenuation	> 100dB
	Max. Mute Attenuation	> 100dB
Output Impedance	All Line Outputs	50 ohms Balanced Source to drive > 600 Ohms
	Tape Output	600 ohms unbalanced
	Direct Output	100 ohms impedance balanced
	Insert Output	50 ohms unbalanced
	Headphones	to drive > 100 ohms
Maximum Output Level	All Line Outputs	+21dBu
	Headphones	+21dBu
Nominal Signal Level	Microphone	-60dBu to 0dBu
	Line	0dBu
	Headphones	+10dBu

## Equalisation

<b>Mono Channels</b>	Hi-pass slope	12dB/octave
	Treble Band	Cut/Boost +/-15dB Frequency range 2kHz to 20kHz
	Hi Mid Band	Cut/Boost +/-15dB Frequency range 400Hz to 8kHz Bandwidth 1 Octave
	Lo Mid Band	Cut/Boost +/-15dB Frequency range 100Hz to 2kHz Bandwidth 1 Octave
<b>Stereo Channels</b>	Bass Band	Cut/Boost +/-15dB Frequency range 20Hz to 400Hz
	Treble Band	Cut/Boost +/-15dB Frequency (-3dB) 12kHz
	Hi Mid Band	Cut/Boost +/-15dB Frequency range 600Hz to 8kHz Bandwidth 1 Octave
	Lo Mid Band	Cut/Boost +/-15dB Frequency range 100Hz to 1.2kHz Bandwidth 1 Octave
	Bass Band	Cut/Boost +/-15dB Frequency (-3dB) 100Hz

## External Power Supply (option)

Connection	6 Pin Male XLR
Pin 1	0V A
Pin 2	+18V A
Pin 3	-18V A
Pin 4	+12V L
Pin 5	+48V
Pin 6	0V L
Case	Chassis

Due to a policy of continual improvement, Midas reserves the right to alter the specification and performance at any time without prior notification.



Crib Sheet Mono Input

Notes:

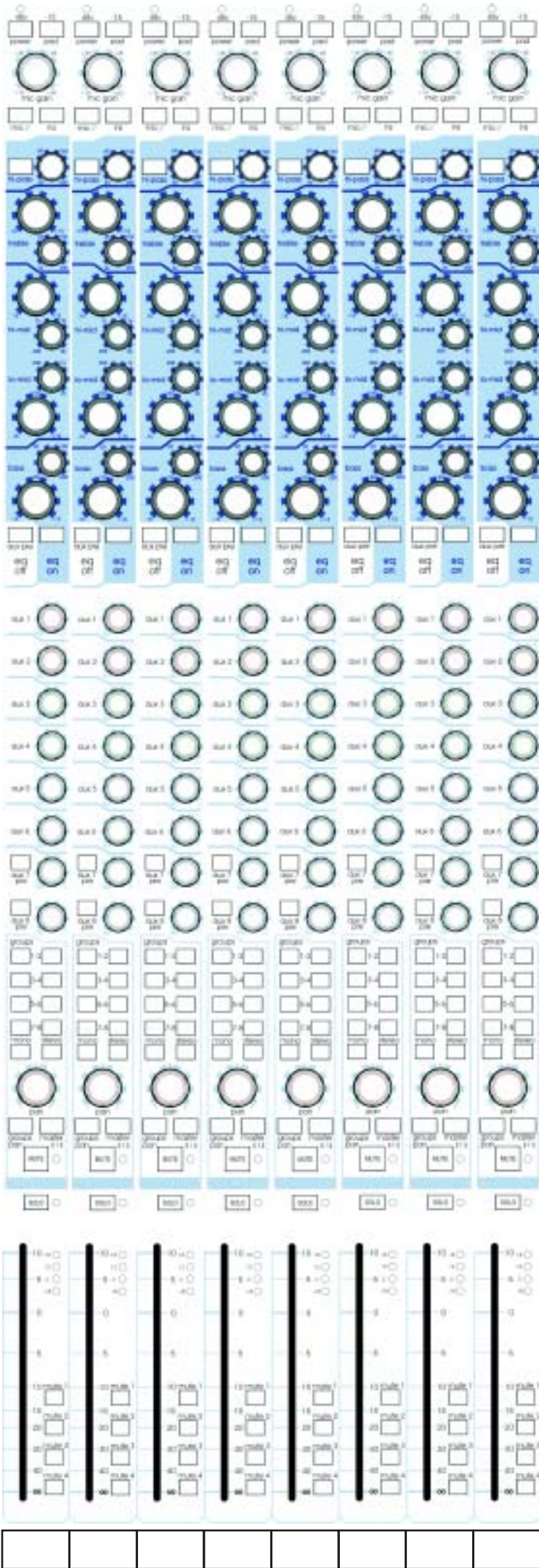





Crib Sheet  
Multi Function Input

Notes:

The image displays a large grid of input symbols and icons, organized into several distinct sections. At the top, there are two rows of small square icons, each with a small circle above it. Below these are two rows of larger circles. The middle section consists of a grid of blue rectangular icons, each containing a circle and a gear-like pattern. Below this is another grid of circles, followed by a grid of squares. The bottom section features a grid of vertical bars, each with a small circle to its right. At the very bottom, there is a single row of eight empty rectangular boxes.





Midas Verona Operators Manual  
Issue 1 - January 2004  
DOC02-Verona

Due to a policy of continual product improvement, specification and features  
may be subject to change without notice.