



Heritage 2000 Specification Overview and Statistics.

1. The 2000 is a 30 buss console with an additional 15 x 8 output matrix. The busses are as follows:-

12	audio groups	=	24
8	mono aux	=	8
2	stereo aux	=	4
1	stereo master	=	2
1	mono master	=	1
1	stereo AFL	=	2
1	mono PFL	=	1
	TOTAL	=	30

2. The 2000 has 10 automute sub groups and 10 VCA sub groups which include VCA sub group muting.

3. The 2000 has 52 input channels plus an additional 14 direct inputs on the group and master modules.

4. The 2000 has a total XLR input count of 95 as follows:-

52	channel mic inputs
12	group direct inputs
12	aux bus injects
8	matrix bus inject inputs
3	solo bus inject inputs
2	master direct inputs
2	external inputs (2 track return)
1	master bus inject
1	talk mic input
1	talk external input
1	test bus input

5. The 2000 has a total XLR output count of 89 as follows:-

44	input channel direct outputs
12	audio group outputs
12	aux outputs
8	matrix outputs
3	master outputs
3	solo outputs
6	local outputs
1	talk external output

6. The 2000 has a total of 180 balanced 1/4 inch jacks for inserts as follows:-

52	input channel insert sends
52	input channel insert returns
12	audio group insert sends
12	audio group insert returns
12	aux insert sends
12	aux insert returns
8	matrix insert sends
8	matrix insert returns
3	master insert sends
3	master insert returns
3	local insert sends
3	local insert returns

7. The 2000 has 58 long throw faders for mix control with fader position recall and virtual fader functions.

8. The 2000 has a total of 1043 automated switch functions as follows:-

- 480 input channel VCA sub group virtual assign switches

- 480 input channel mute sub group virtual assign switches

- 48 input channel mute switches

- 12 audio sub group mute switches

- 12 aux mute switches

- 8 matrix mute switches

- 3 master mute switches

9. The 2000 has a total of 89 peak program meters with 20 LED segments on all outputs and 11 LED segments on input channels.

Heritage 2000 Technical Specifications.

Input Impedance	Mic	2k Balanced
	Line	20k Balanced
Input Gain (all faders at 0dB)	Mic	Continuously variable from + 15dB to + 60dB
	Mic + Pad	Continuously variable from - 10dB to + 35dB
	Line Level Inputs	0dB
Maximum Input Level	Mic	+ 6dBu
	Mic + Pad	+ 31dBu
	Line Level Inputs	+ 21dBu
CMR at 1kHz	Mic (gain + 40dB)	> 100dB
	Mic + Pad (gain 0dB)	> 70dB
	Line	> 50dB
Frequency Response (20 to 20kHz)	Mic to Mix (gain + 40dB)	+ 0dB to - 1dB
Noise (20 to 20kHz)	Mic EIN ref. 150 Ω (gain + 60dB)	- 128dBu
System Noise (20 to 20kHz)	Summing Noise (48 channels routed with faders down)	- 80dB
	Line to Mix Noise (48 channels routed at 0dB, pan centre)	- 75dB
Distortion at 1kHz	Mic to Mix (+ 40dB gain, 0dBu output)	< 0.03%
Crosstalk at 1kHz	Channel to Channel	< - 90dB
	Mix to Mix	< - 90dB
	Channel to Mix	< - 90dB
	Maximum Fader attenuation	> 90dB

Output Impedance	All Line Outputs	50 Ohms Balanced Source to drive > 600Ω
	Headphones	To drive > 8Ω
Maximum Output Level	All Line Outputs	+ 21dBu
	Headphones	+ 21dBu
Nominal Signal Level	Mic	- 60dBu to + 10dBu
	Line	0dBu
	Headphones	+ 10dBu
Equaliser	Hi pass Slope	12dB / Oct
	Hi pass Frequency	Continuously variable - 3dB point from 20Hz to 400Hz
	Treble Gain	Continuously variable + 15 dB to - 15 dB Centre detent = 0dB
	Treble Shelving Freq.	Continuously variable - 3dB point from 1k to 20k
	Treble Bell Freq.	Continuously variable centre from 1k to 20k
	Treble Bell Bandwidth	Continuously variable 0.1 Oct. to 2 Oct Centre detent = 0.5 Oct
	Hi Mid Gain	Continuously variable + 15 dB to - 15 dB Centre detent = 0dB
	Hi Mid Freq.	Continuously variable centre from 400Hz to 8k
	Hi Mid Bandwidth	Continuously variable 0.1 Oct. to 2 Oct Centre detent = 0.5 Oct
	Lo Mid Gain	Continuously variable + 15 dB to - 15 dB Centre detent = 0dB
	Lo Mid Freq.	Continuously variable centre from 100Hz to 2k
Lo Mid Bandwidth	Continuously variable 0.1 Oct. to 2 Oct Centre detent = 0.5 Oct	

Bass Gain	Continuously variable + 15 dB to - 15 dB Centre detent = 0dB
Bass Shelving Freq.	Continuously variable - 3dB point from 20Hz to 400Hz
Bass Bell Freq.	Continuously variable centre from 20Hz to 400Hz
Bass Bell Bandwidth	Continuously variable 0.1 Oct. to 2 Oct Centre detent = 0.5 Oct



HERITAGE 2000 INPUT MODULE
BLOCK DIAGRAM

ISSUE A

DATE 11 - 5 - 98



HERITAGE 2000 MATRIX MODULE
BLOCK DIAGRAM
ISSUE A
DATE 1 - 5 - 98

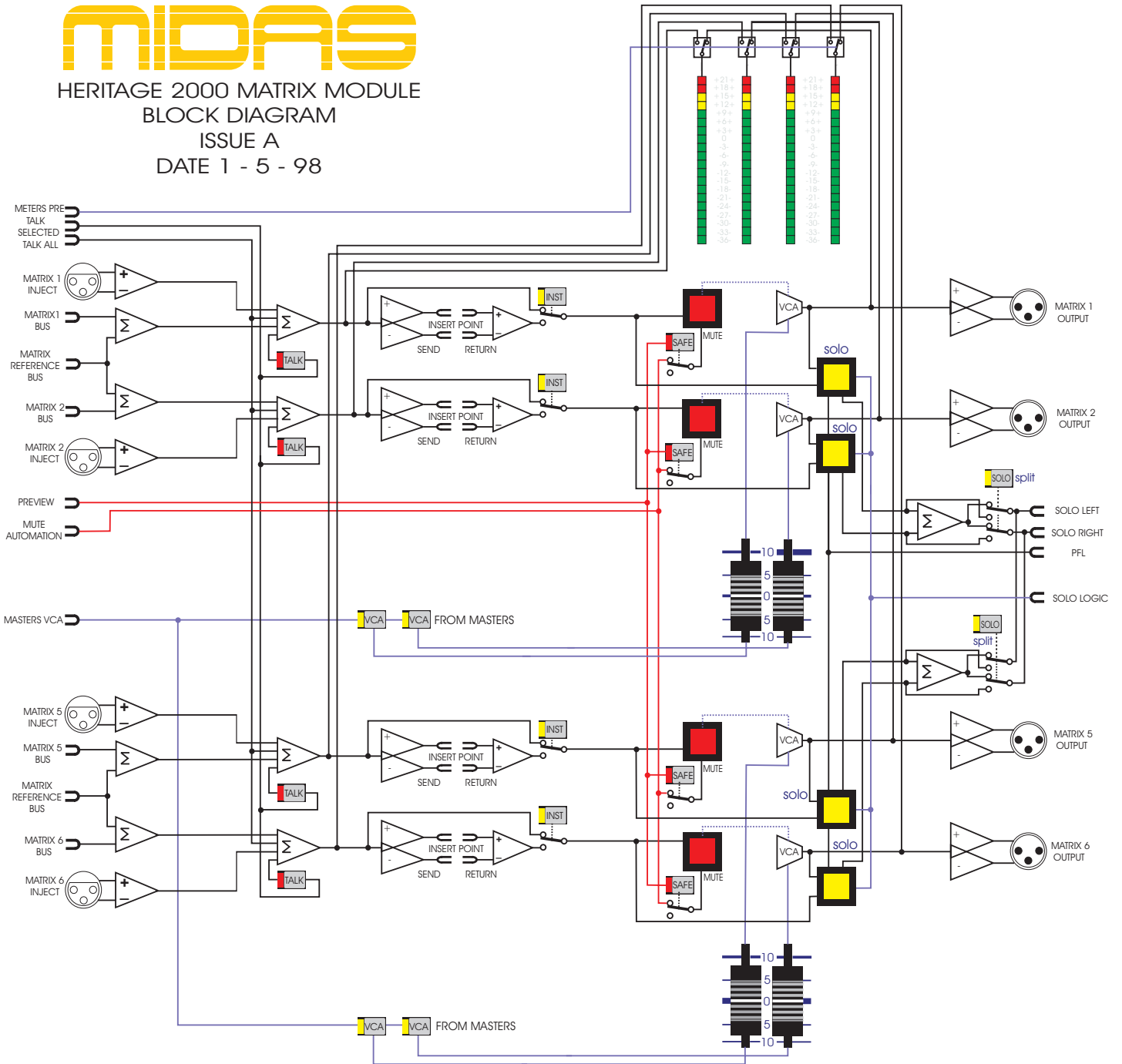



HERITAGE 2000 AUX MODULE
BLOCK DIAGRAM
ISSUE A
DATE 1 - 5 - 98

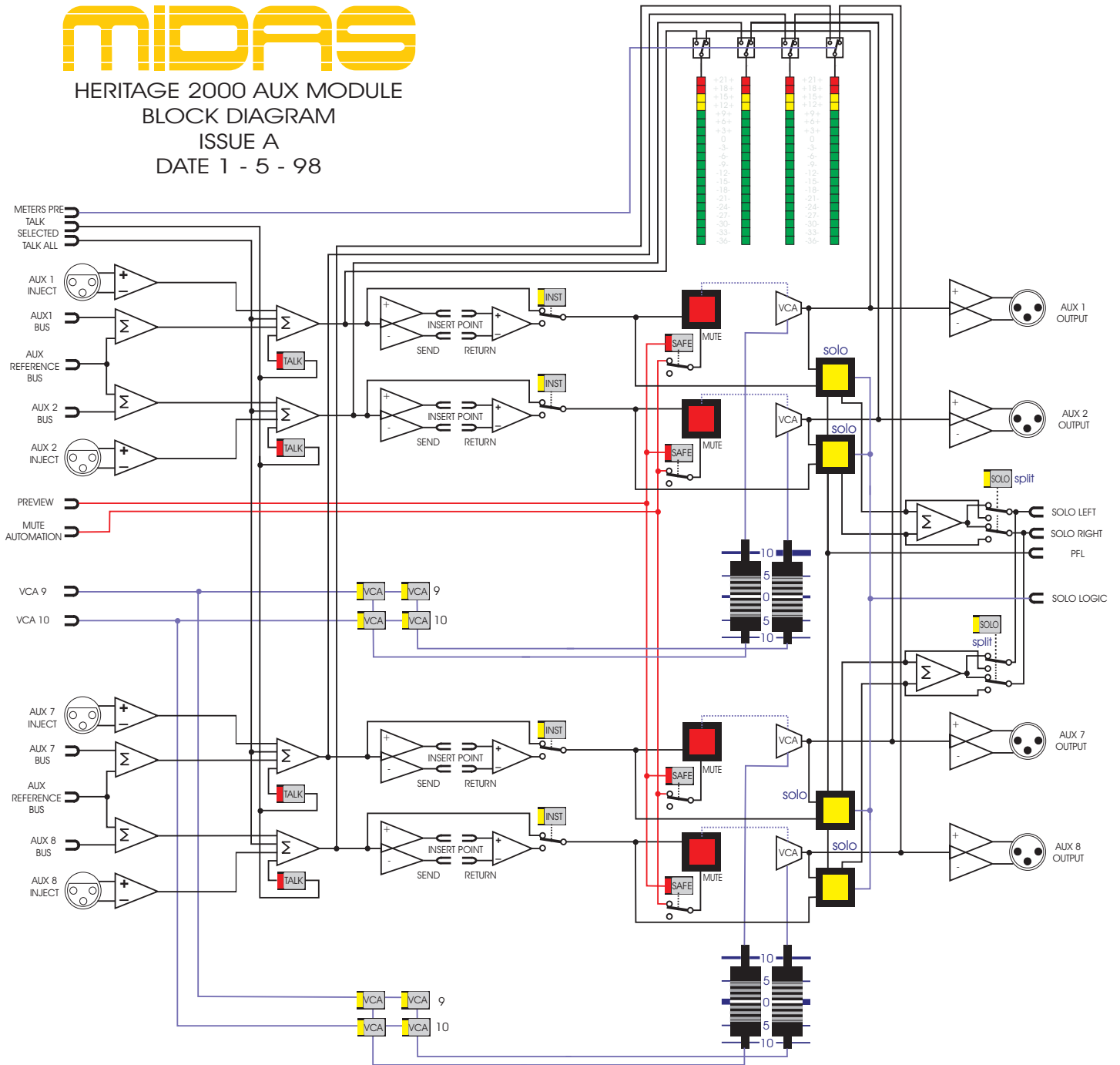



HERITAGE 2000 MASTER MODULE BLOCK DIAGRAM ISSUE A DATE 30 - 4 - 98

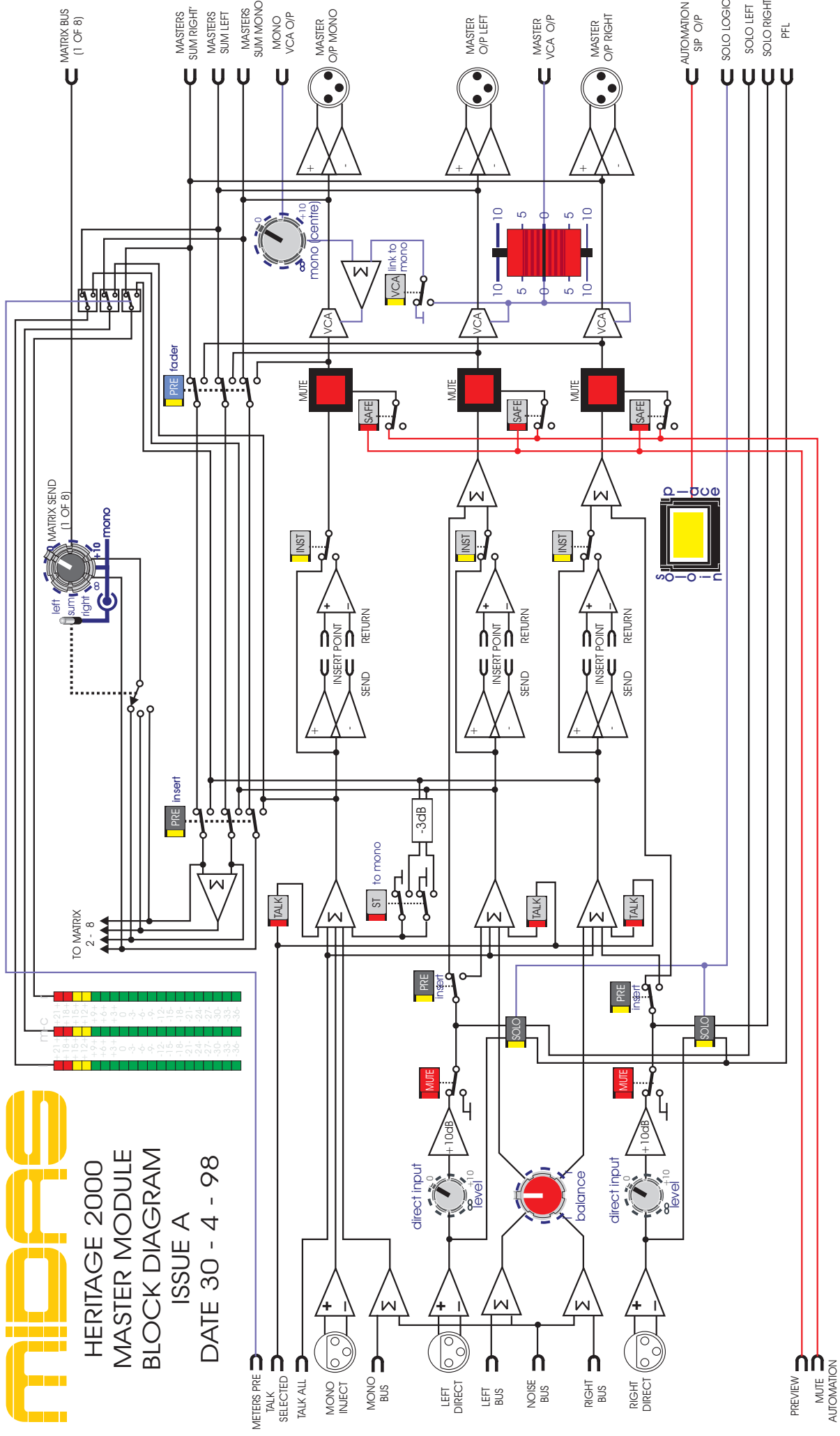

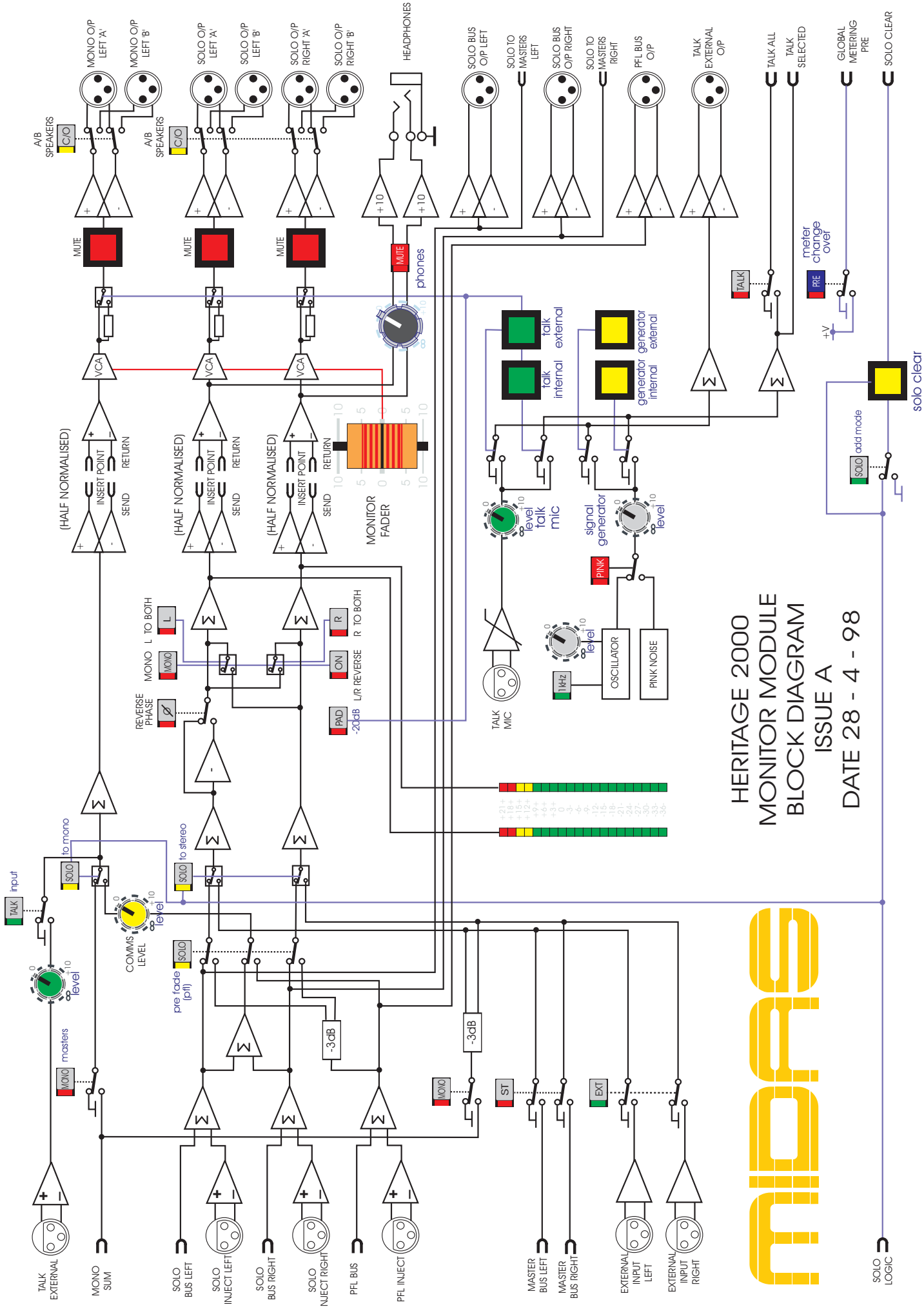

HERITAGE 2000
 MONITOR MODULE
 BLOCK DIAGRAM
 ISSUE A

DATE 28 - 4 - 98

midas

HERITAGE 2000

Back panel

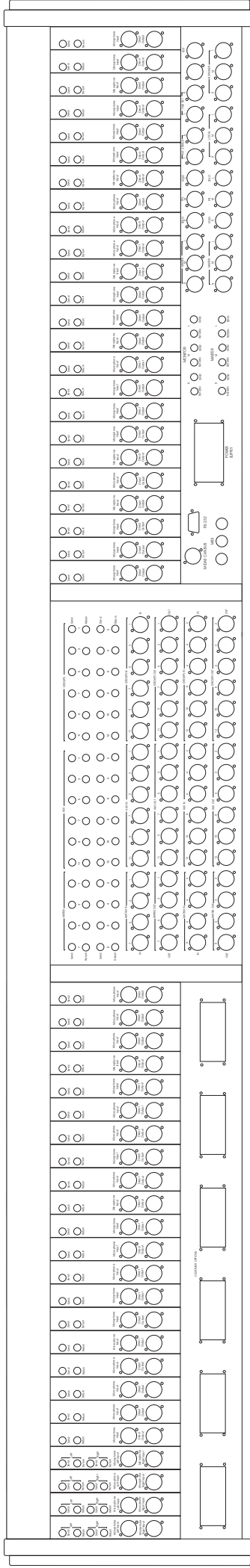

Rear Panel Left View

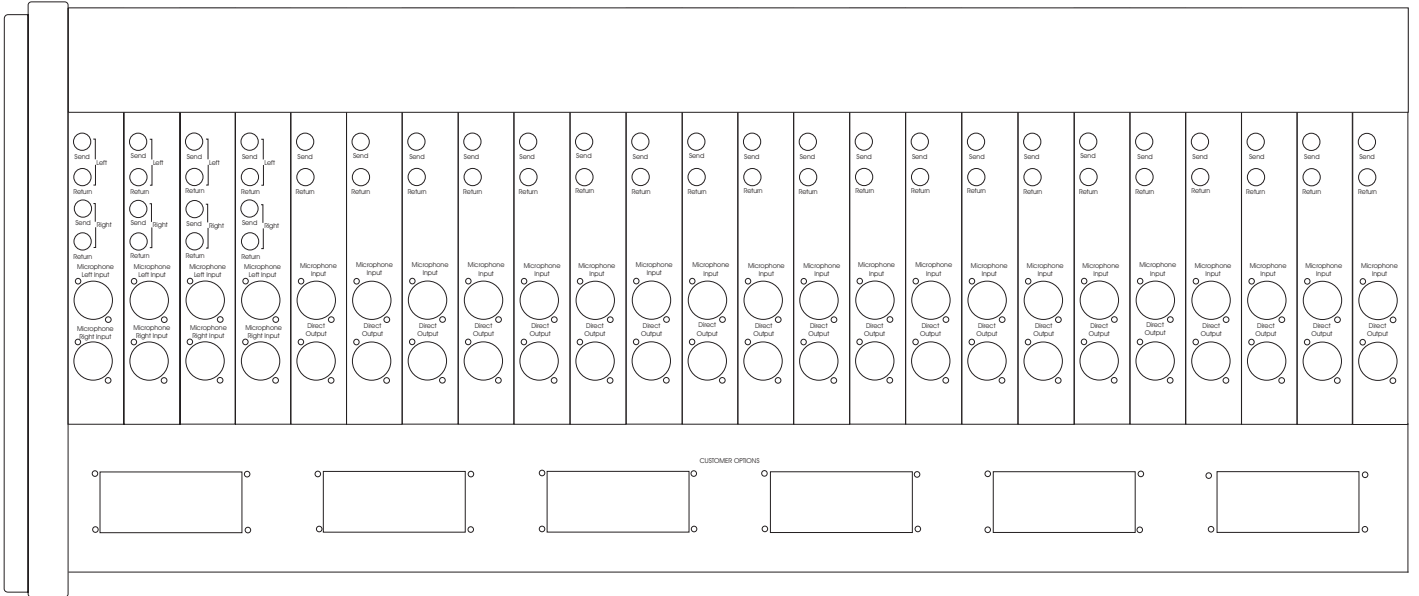

Rear Panel Centre View

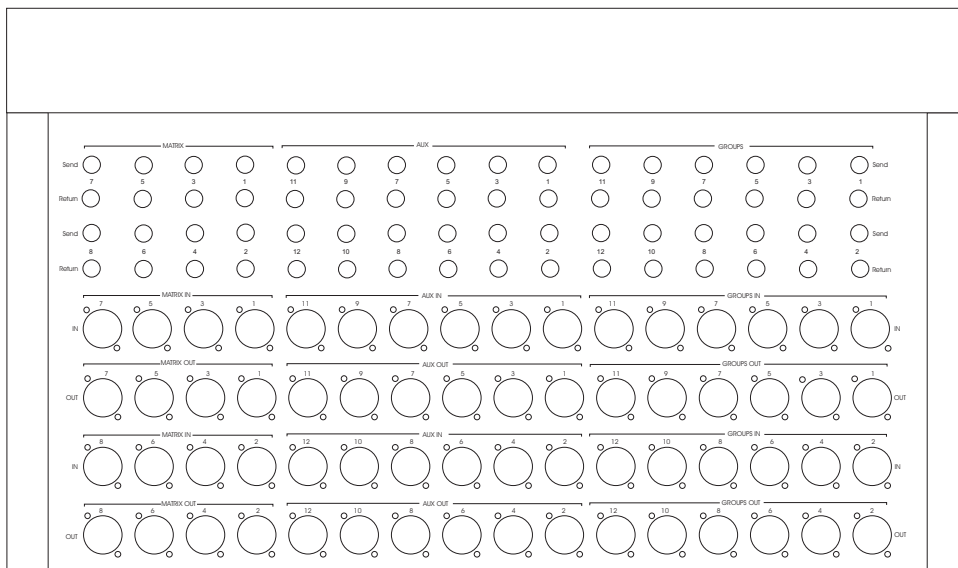

Rear Panel Right View

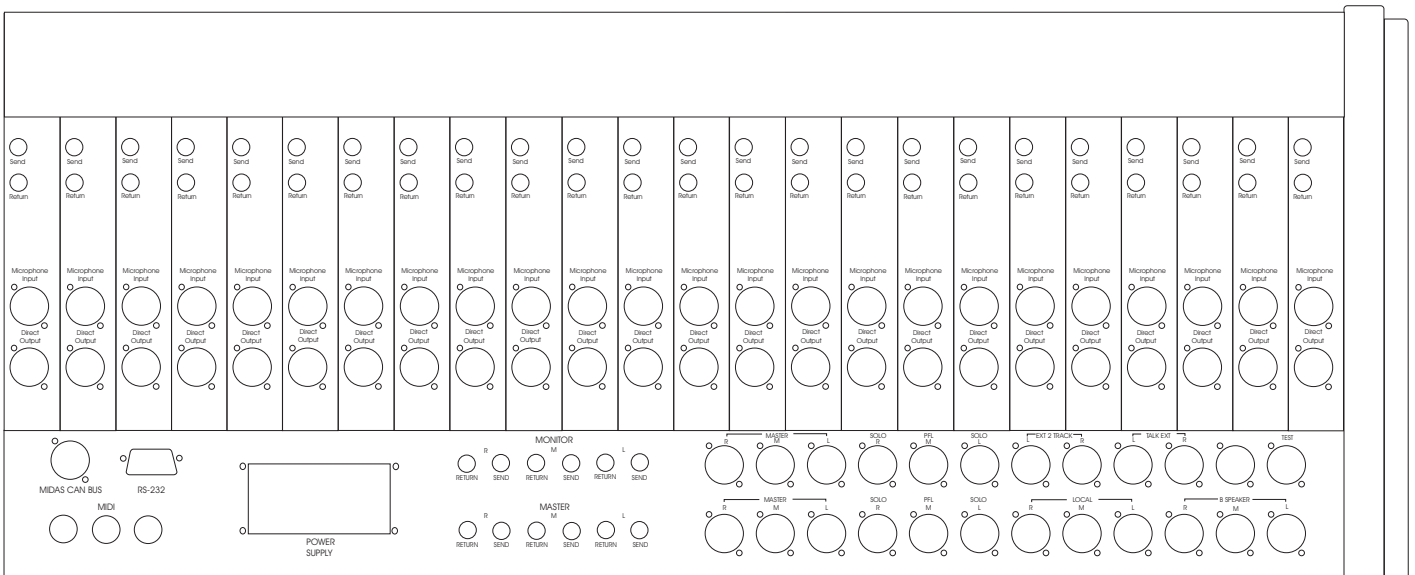

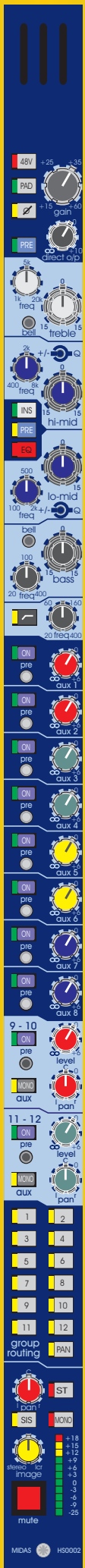

MIDAS HS0002 Mono Input Module

The 48V switch connects 48 volt phantom power to the input connector which is suitable for a condenser microphone or DI box.

The PAD switch gives 25dB of attenuation to the input signal which will allow the connection of high output microphones or line level signals. If the input amplifier is transformer coupled (option) the pad greatly reduces the risk of saturation at very low frequencies.

The PHASE switch activates a 180 degrees phase change within the input amplifier.

The PRE switch re configures the direct output to derive signal from the input channel pre insert and equaliser. It is important to note that pre insert direct outputs are also pre mute.

The treble FREQ control gives continuous adjustment of the frequency range that the treble equaliser acts on from 1k to 20k.

The treble BELL switch converts the treble equaliser from traditional MIDAS shelving response to full parametric operation.

The hi mid FREQ control gives continuous adjustment of the frequency range that the hi mid equaliser acts on from 400Hz to 8k.

The INS switch connects the input insert return signal to the input channel signal path.

The EQ switch connects the equaliser into the input channel signal path.

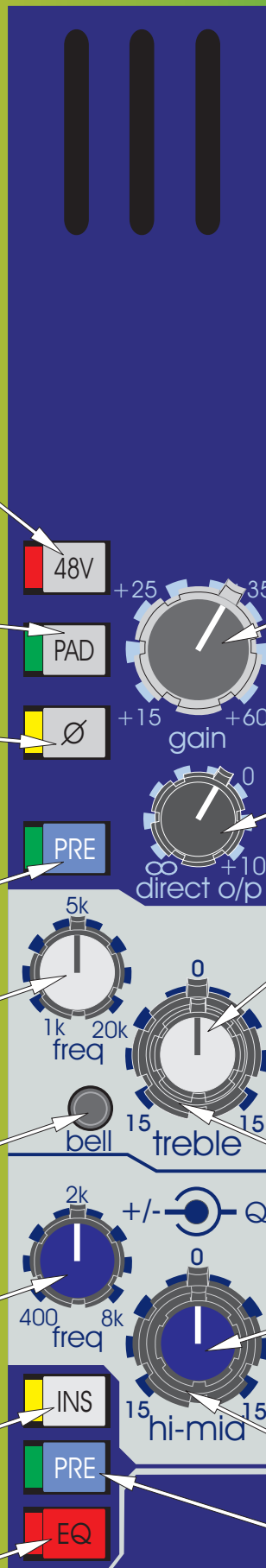

The GAIN control gives continuous adjustment of the input amplifier gain from + 15dB to + 60dB.

The DIRECT output control gives continuous adjustment of the direct output level from + 10dB to off. The output is derived from the input channel post equaliser pre fader signal.

The TREBLE (dual concentric top) control gives continuous adjustment of boost and cut from + 15dB to - 15dB with a 0dB centre detent.

The treble WIDTH (dual concentric bottom) control gives continuous adjustment of bandwidth from 0.1 to 2 octaves with a 0.5 octave centre detent. This only operates when the BELL switch is activated.

The HI MID (dual concentric top) control gives continuous adjustment of boost and cut from + 15dB to - 15dB with a 0dB centre detent.

The hi mid WIDTH (dual concentric bottom) control gives continuous adjustment of bandwidth from 0.1 to 2 octaves with a 0.5 octave centre detent.

The insert PRE switch arranges the input channel signal to pass through the insert point before the equaliser when activated and after the insert point when not activated.

The lo mid FREQ control gives continuous adjustment of the frequency range that the lo mid equaliser acts on from 100Hz to 2k.

The bass BELL switch converts the bass equaliser from traditional MIDAS shelving response to full parametric operation.

The bass FREQ control gives continuous adjustment of the frequency range that the bass equaliser acts on from 20Hz to 400Hz.

The HI PASS switch connects the filter in the input channel signal path before the insert point and equaliser.

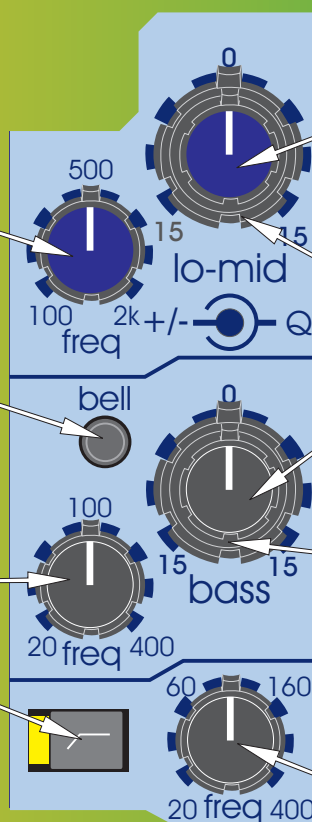

The LO MID (dual concentric top) control gives continuous adjustment of boost and cut from + 15dB to - 15dB with a 0dB centre detent.

The lo mid WIDTH (dual concentric bottom) control gives continuous adjustment of bandwidth from 0.1 to 2 octaves with a 0.5 octave centre detent.

The BASS (dual concentric top) control gives continuous adjustment of boost and cut from + 15dB to - 15dB with a 0dB centre detent.

The bass WIDTH (dual concentric bottom) control gives continuous adjustment of bandwidth from 0.1 to 2 octaves with a 0.5 octave centre detent.

This only operates when the BELL switch is activated.

The HI PASS filter control is continuously adjustable from 20Hz to 400Hz.

The mono aux ON switches connect signals from the input channel to the mono aux busses.

The mono aux PRE switches change the signal sent to the mono aux busses from post fader to pre fader.

The stereo aux ON switches connect signals from the input channel to the stereo aux busses.

The stereo aux PRE switches change the signal sent to the stereo aux busses from post fader to pre fader.

The MONO switches change either of the stereo aux busses into two independent mono aux busses with the pan controls becoming the second level control (bus 10 or 12).

The mono AUX controls (1 to 8) give continuous adjustment of the level sent from the input channel to the aux busses. The level adjustment is from +6dB to off.

The stereo aux LEVEL controls (9 and 11) give continuous adjustment of the level sent from the input channel to the stereo aux busses. The level adjustment is from +6dB to off.

The stereo aux PAN controls are used to place the channel within a stereo aux mix and have a constant power law, i.e. -3dB at the centre position.

The GROUP ROUTING switches (1 to 12) assign the post fader channel signals to the group busses.

The PAN switch effects all group routing by moving the channel source from post fader to post the fader and pan control.



The PAN defaults to control the channel placement within a group or master stereo mix and has a constant power law i.e. - 3dB at the centre position.

The SIS switch enables the spacial imaging system which operates in conjunction with the pan and image controls. It also acts as a left, centre, right master bus enable overriding any stereo and mono master bus assignments.

When the spacial imaging system is active the IMAGE control can modify the action of the pan control so as to place the channel within a three speaker system. When the image control is fully clockwise the pan control will operate in full left, centre, right such that a centre panned signal will route to the centre speaker only and will not appear in either of the left or right outputs. When the image control is fully anti-clockwise the pan control reverts to stereo such that a centre panned signal will route at equal power to the left and right speakers. All other Image control positions generate a composite blend of the stereo and LCR panning systems so that the optimum degree of center image focus and speaker power can be obtained. When the image control and pan control are both set central the channel will be routed with equal power to all three speakers. Constant power is maintained at all times so that the image can be adjusted during the show without any perceived level change.

The ST switch connects the post fader channel signal to the master stereo bus via the pan control.

The MONO switch connects the post fader channel signal to the mono master bus.

The METER monitors the peak signal level of the pre fader input channel.

The MUTE switch mutes the input channel at all points after the insert send. The switch can be controlled from snapshot automation and by automute scenes.

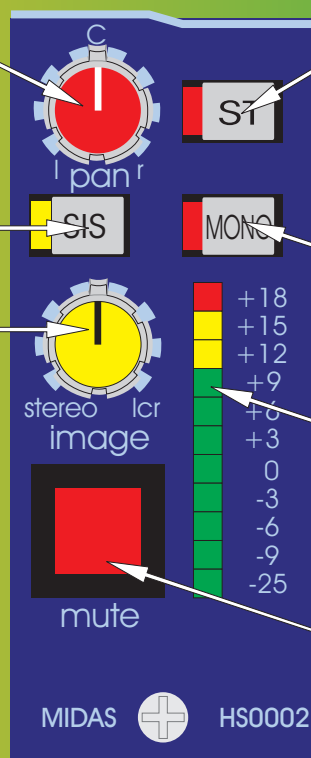

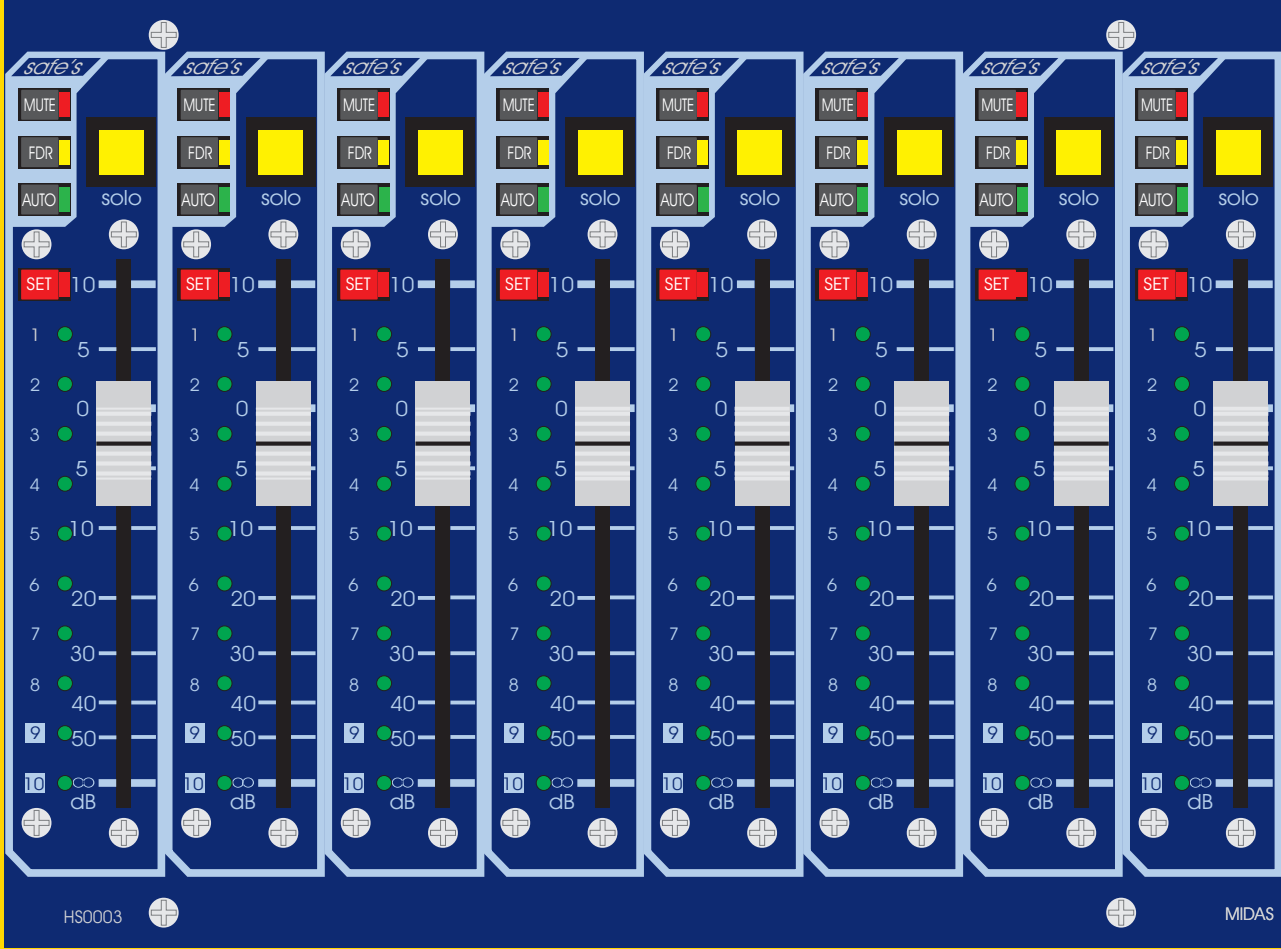

MIDAS | HS0003 | Input Fader

The SAFE switches disable remote control of the channels as follows:-

- i. The MUTE SAFE removes the channel mute from the snapshot automation and automute scenes.
- ii. The FADER SAFE removes the channel fader from the virtual fader automation and VCA master fader control including vca mutes.
- iii. The AUTO SAFE removes the channel from the snapshot automation system only; leaving the automutes, VCA masters and assignment systems active.

The SET switch is used to programme the channel automute and VCA master assignment. The central controller MODE and ASSIGN keys select the desired automute or VCA group and the SET switch will toggle the channel on and off with each alternate press.

The STATUS leds are used to show fader positions and the status of VCA and MUTE group assignments. The central controller MODE switches toggle through the four available states:- VCA group assignment, MUTE group assignment, FADER position manual recall and null, and full automated VIRTUAL FADER RECALL.

FADER MANUAL RECALL AND NULL
In this mode, the STATUS LEDs are used to prompt the operator where to move the fader. If the fader is not at the position stored in the current recalled snap shot, one/two LEDs will flash to indicate where the fader should be. A single flashing LED indicates that the fader should be positioned next to that LED, if two LEDs are flashing the fader should be between the two LEDs. As the fader is moved closer to the required position the LED(s) will stop flashing and will be replaced by a single continuously lite LED. Once the fader is at the correct position all LEDs will extinguish.

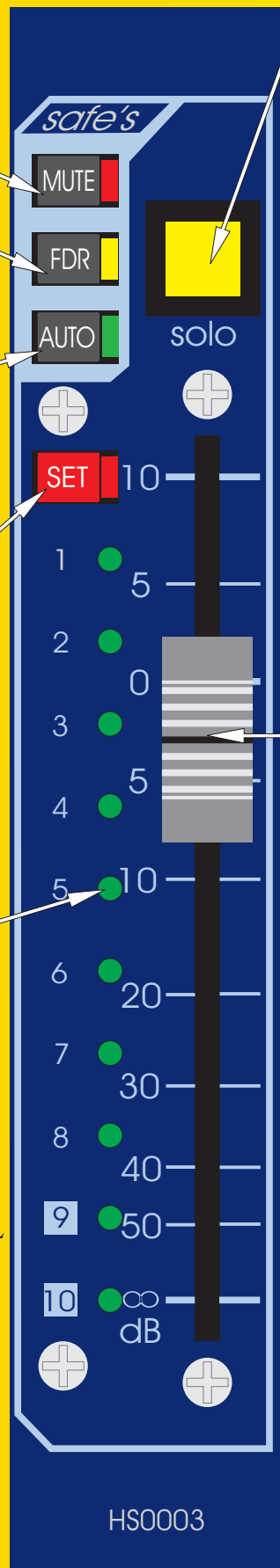

The SOLO switch sends the input channel signal to the PFL mono and AFL stereo busses. If the switch is pressed for a short time it will latch on or off, but if it is held on for more than 1 second the latching is disabled and when the switch is released the channel solo will turn off. As a default the solo system is auto cancelling so each new solo cancels the last. This function is time dependant which allows several solos to be active as long as they are switched on at approximately the same time. The SOLO ADD MODE switch on the MONITOR module defeats the auto cancelling and allows multiple channel monitoring. In this mode input solos have priority over outputs and will temporarily override any active output solos. The input solos also override any active VCA solos.

The FADER gives continuous adjustment of the input channel level from + 10dB to off.

FADER POSITION CHECK
When a scene's contents are being "checked" (see automation operation) the STATUS LEDs will indicate the fader position stored in the scene by continuously illuminating one or two LEDs as appropriate.

VIRTUAL FADER RECALL
When in VIRTUAL FADER mode (see automation operation) the automation system will generate a "virtual" fader, set to the level of the input fader at the time the snap shot was stored. The level of the virtual fader is added to the level of the physical input fader. In this mode the STATUS LEDs indicate the "position" of the virtual fader by illuminating a bar of LEDs starting at - ∞.

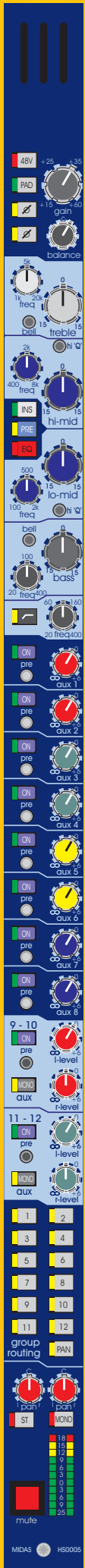

MIDAS HS0005 Stereo Input Module

The 48V switch connects 48 volt phantom power to both input connectors and is suitable for condenser microphones or DI boxes.

The PAD switch gives 25dB of attenuation in both input signals to allow the connection of high output microphones or line level signals. If the input amplifiers are transformer coupled (option) the pad greatly reduces the risk of saturation at very low frequencies.

The PHASE switches activate a 180 degree phase change within the input amplifiers. The upper switch acts on the left channel and the lower switch acts on right channel.

The treble **FREQ** control gives continuous adjustment of the frequency range that the treble equalisers act on from 1k to 20k.

The treble **BELL** switch converts the treble equalisers from traditional MIDAS shelving response to bell filters with a 1.5 octave bandwidth.

The hi mid **FREQ** control gives continuous adjustment of the frequency range that the hi mid equalisers act on from 400Hz to 8k.

The **INS** switch connects the left and right input insert return signals to the input channel.

The insert **PRE** switch arranges the input channel signals to pass through the insert points before the equalisers when activated and after the insert points when not activated.

The **EQ** switch connects the left and right equalisers into the input channel signal paths.

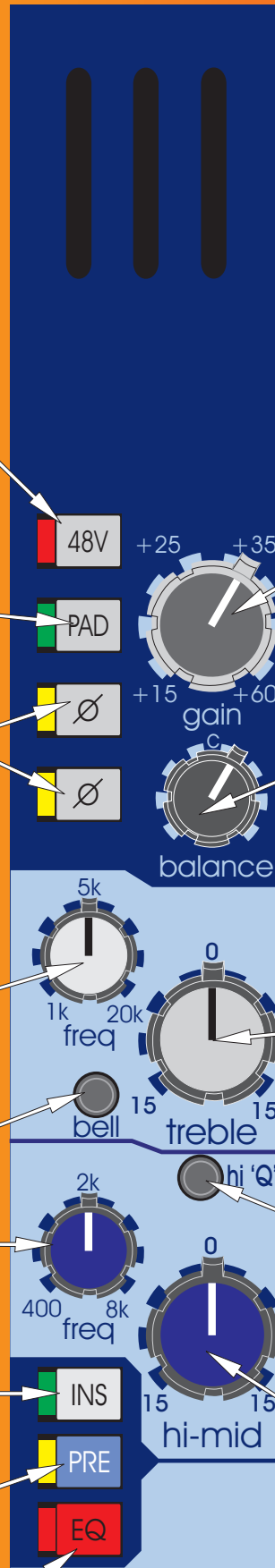

The **GAIN** control gives continuous adjustment of the input amplifier gains from +15dB to +60dB.

The **BALANCE** control gives continuous and reciprocal adjustment of the stereo left and right signal levels by +10dB to -10dB. This allows fine adjustment of the left and right signal levels and imaging.

The **TREBLE** control gives continuous adjustment of left and right boost and cut from +15dB to -15dB with a 0dB centre detent.

The hi mid **HI Q** control changes the bandwidth of the hi mid equalisers from 1.5 octave to 0.5 octave.

The **HI MID** control gives continuous adjustment of left and right boost and cut from +15dB to -15dB with a 0dB centre detent.

The lo mid FREQ control gives continuous adjustment of the frequency range that the lo mid equalisers act on from 100Hz to 2k.

The bass BELL switch converts the bass equalisers from traditional MIDAS shelving response to bell filters with a 1.5 octave bandwidth.

The bass FREQ control gives continuous adjustment of the frequency range that the bass equalisers act on from 20Hz to 400Hz.

The HI PASS switch connects the filters in the input channel signal path before the insert points.



The LO MID control gives continuous adjustment of left and right boost and cut from +15dB to -15dB with a 0dB centre detent.

The lo mid HI Q control changes the bandwidth of the lo mid equalisers from 1.5 octave to 0.5 octave.

The BASS control gives continuous adjustment of the left and right shelving filters boost and cut from +15dB to -15dB with a 0dB centre detent.

The HI PASS filter control is continuously adjustable from 20Hz to 400Hz.

The mono aux ON switches connect signals from the input channel to the mono aux busses.

The mono aux PRE switches change the signal sent to the mono aux busses from post fader to pre fader.

The stereo aux ON switches connect signals from the input channel to the stereo aux busses.

The stereo aux PRE switches change the signal sent to the stereo aux busses from post fader to pre fader.

The MONO switches change either of the stereo aux busses into two independent mono aux busses with the level controls feeding a mono sum of the left and right input signals.

The mono AUX controls (1 to 8) give continuous adjustment of the level sent from the input channel to the aux busses. The signal is a mono sum of the left and right signals and the level adjustment is from +6dB to off.

The stereo aux LEVEL controls (9 to 12) give continuous adjustment of the level sent from the input channel to the stereo aux busses. The first control routes left channel signal to the left aux bus and the second control routes right channel signal to the right aux bus. The level adjustment is from +6dB to off.

The GROUP ROUTING switches (1 to 12) assign the post fader channel signals to the group busses in stereo (odd numbers are left and even numbers are right).

The PAN switch moves the channel source for the group routing to be post the two pan controls.



The left and right PAN controls are used to place the input channel signals within a stereo group or stereo master mix. As well as image placement, the controls can also adjust the image width from stereo through mono to reverse stereo (left and right crossed over). The controls have a constant power law i.e. -3dB at the centre position.

The ST switch connects the post fader channel signals to the stereo master bus via the pan controls.

The MUTE switch mutes the input channel at all points after the insert send. The switch can be controlled from snapshot automation and by automute scenes.

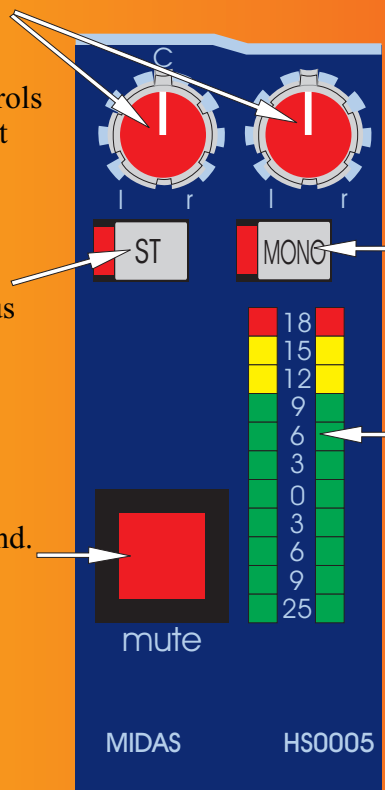

The MONO switch connects the post fader channel signals to the mono master bus.

The METERS monitor the pre fader peak signal levels of input channel.

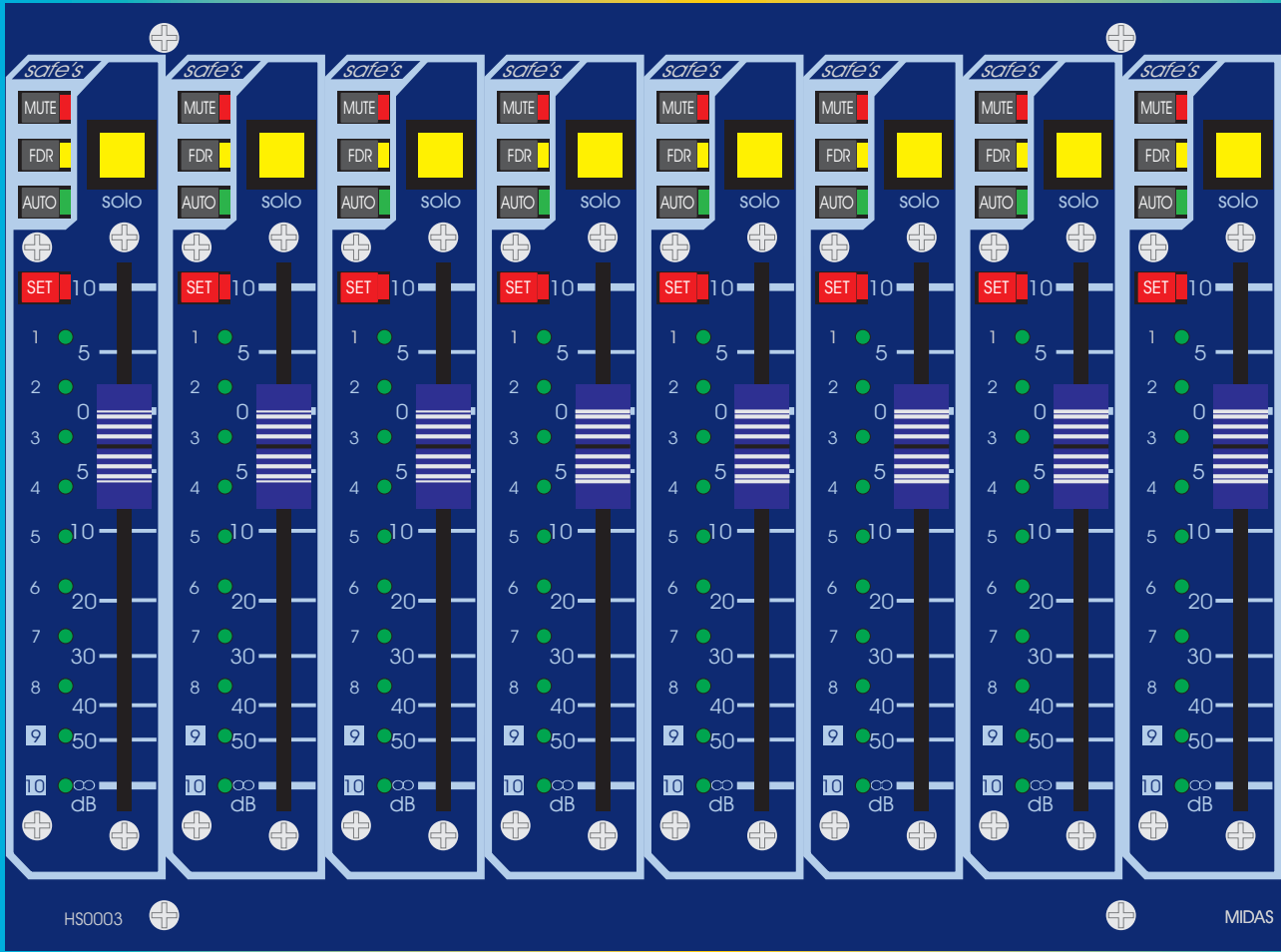

MIDAS HS0003 Input Fader

The SAFE switches disable remote control of the channels as follows:-

- i. The MUTE SAFE removes the channel mute from the snapshot automation and automute scenes.
- ii. The FADER SAFE removes the channel fader from the virtual fader automation and VCA master fader control including vca mutes.
- iii. The AUTO SAFE removes the channel from the snapshot automation system only; leaving the automutes, VCA masters and assignment systems active.

The SET switch is used to programme the channel automute and VCA master assignment. The central controller MODE and ASSIGN keys select the desired automute or VCA group and the SET switch will toggle the channel on and off with each alternate press.

The STATUS leds are used to show fader positions and the status of VCA and MUTE group assignments. The central controller MODE switches toggle through the four available states:- VCA group assignment, MUTE group assignment, FADER position manual recall and null, and full automated VIRTUAL FADER RECALL.

FADER MANUAL RECALL AND NULL
In this mode, the STATUS LEDs are used to prompt the operator where to move the fader. If the fader is not at the position stored in the current recalled snap shot, one/two LEDs will flash to indicate where the fader should be. A single flashing LED indicates that the fader should be positioned next to that LED, if two LEDs are flashing the fader should be between the two LEDs. As the fader is moved closer to the required position the LED(s) will stop flashing and will be replaced by a single continuously lit LED. Once the fader is at the correct position all LEDs will extinguish.

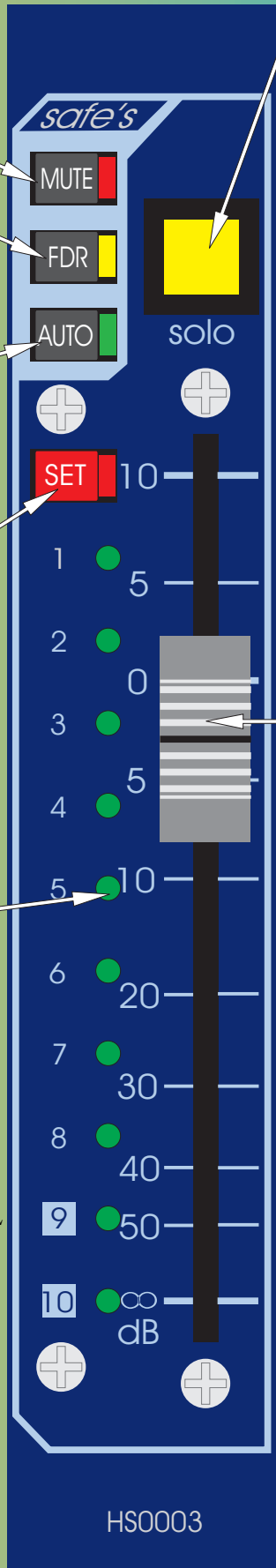

The SOLO switch sends the input channel signal to the PFL mono and AFL stereo busses. If the switch is pressed for a short time it will latch on or off, but if it is held on for more than 1 second the latching is disabled and when the switch is released the channel solo will turn off. As a default the solo system is auto cancelling so each new solo cancels the last. This function is time dependant which allows several solos to be active as long as they are switched on at approximately the same time. The SOLO ADD MODE switch on the MONITOR module defeats the auto cancelling and allows multiple channel monitoring. In this mode input solos have priority over outputs and will temporarily override any active output solos. The input solos also override any active VCA solos.

The FADER gives continuous adjustment of the input channel level from +10dB to off.

FADER POSITION CHECK
When a scene's contents are being "checked" (see automation operation) the STATUS LEDs will indicate the fader position stored in the scene by continuously illuminating one or two LEDs as appropriate.

VIRTUAL FADER RECALL
When in VIRTUAL FADER mode (see automation operation) the automation system will generate a "virtual" fader, set to the level of the input fader at the time the snap shot was stored. The level of the virtual fader is added to the level of the physical input fader. In this mode the STATUS LEDs indicate the "position" of the virtual fader by illuminating a bar of LEDs starting at - ∞.

MIDAS HS0012 Group Module



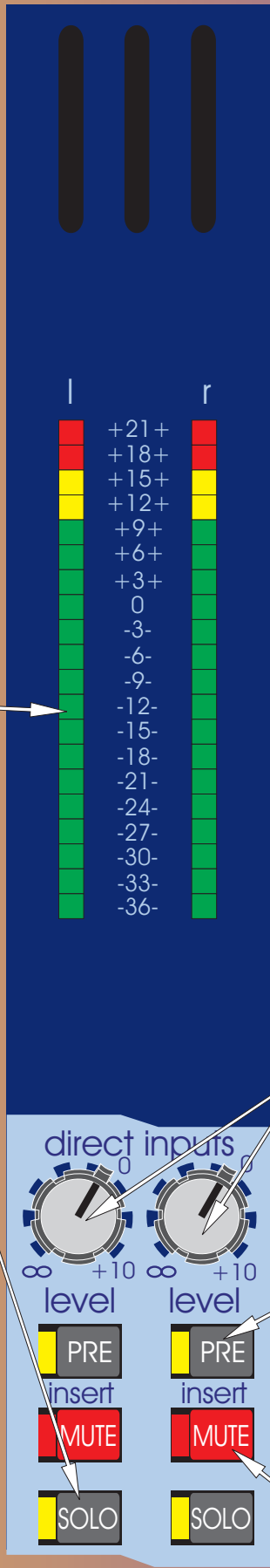

The METERS monitor the peak signal levels of the sub group outputs (post fader).

The direct SOLO switches send direct inputs to the PFL mono and AFL the stereo busses (AFL is selected as stereo or mono depending on the group SPLIT switch settings). If a SOLO switch is pressed for a short time it will latch on or off, but, if it is held on for more than 1 second the latching is disabled and when the switch is released the solo will turn off. As a default the solo system is auto cancelling so each new solo cancels the last. This function is time dependant which allows several solos to be active as long as they are switched on at approximately the same time, i.e. to solo both sides of a stereo mix press both solo switches at the same time. Alternatively the SOLO ADD MODE switch on the MONITOR module can be used to defeat the auto cancelling and allow multiple channel monitoring. In this mode input channel solos have priority over all other solos and will temporarily override them.

The DIRECT input controls give continuous adjustment of the direct input levels from + 10dB to off. The direct signals are summed into the sub group signals and can be used as effects returns etc. or for console bus linking.

The direct PRE switches move the point at which the direct signals are summed into the sub groups. The default is post insert but when the PRE switches are active the signals are summed at the sub group mix busses.

The direct MUTE switches mute the sub group direct inputs at all points.

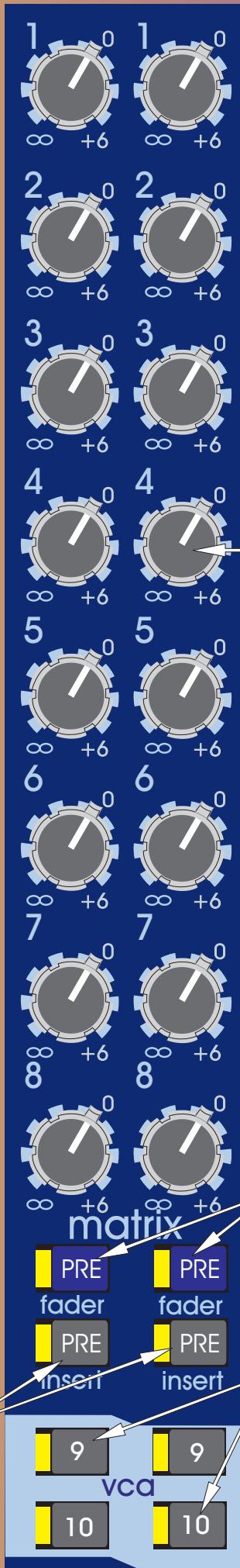

The matrix MIX controls (1 to 8) give continuous adjustment of the sub group levels sent to the matrix mixes from +6dB to off.

The PRE fader switches change the signals sent to the matrix mixes from post group fader to pre group fader.

The PRE insert switches change the signals sent to the matrix mixes from post group insert to pre group insert and override the pre fader switches. It is important to note that pre insert matrix sends are also pre the group mutes.

The VCA switches assign the audio sub groups to VCA control from VCA masters 9 and 10.

The MONO switches connect the post fader sub group signals to the mono master bus.

The TALK switches connect the sub groups to the MONITOR module. When the TALK INTERNAL or GENERATOR INTERNAL are active on the MONITOR module the oscillator, pink noise and talk mic can be routed to the sub groups.

The MUTE switches mute the sub group signals at all points after the insert send. The switches can be controlled from snapshot automation.

The SPLIT switch changes the sub group AFL solos from mono to stereo.

The GROUP FADERS give continuous adjustment of the sub group output levels from +10dB to off.

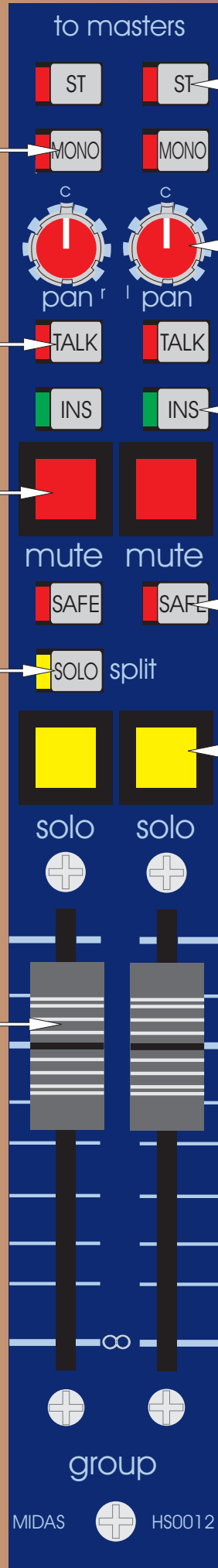

The ST switches connect the post fader sub group signals to the stereo master stereo busses via the pan controls.

The group PAN controls place the sub groups within the stereo master mix and have a constant power law i.e. -3dB at the centre position.

The INS switches connect the group insert return signals to the sub group signals.

The mute SAFE removes the channel mute from snapshot automation.

The SOLO switches send sub group signals to the PFL mono and AFL stereo busses. If a SOLO switch is pressed for a short time it will latch on or off, but, if it is held on for more than 1 second the latching is disabled and when the switch is released the channel solo will turn off. As a default the solo system is auto cancelling so each new solo cancels the last. This function is time dependant which allows several solos to be active as long as they are switched on at approximately the same time, i.e. to solo both sides of a stereo mix press both solo switches at the same time. Alternatively the SOLO ADD MODE switch on the MONITOR module can be used to defeat the auto cancelling and allow multiple channel monitoring. In this mode input channel solos have priority over the sub group solos and will temporarily override them. When the input solos are cancelled the mix group solos will be active again.

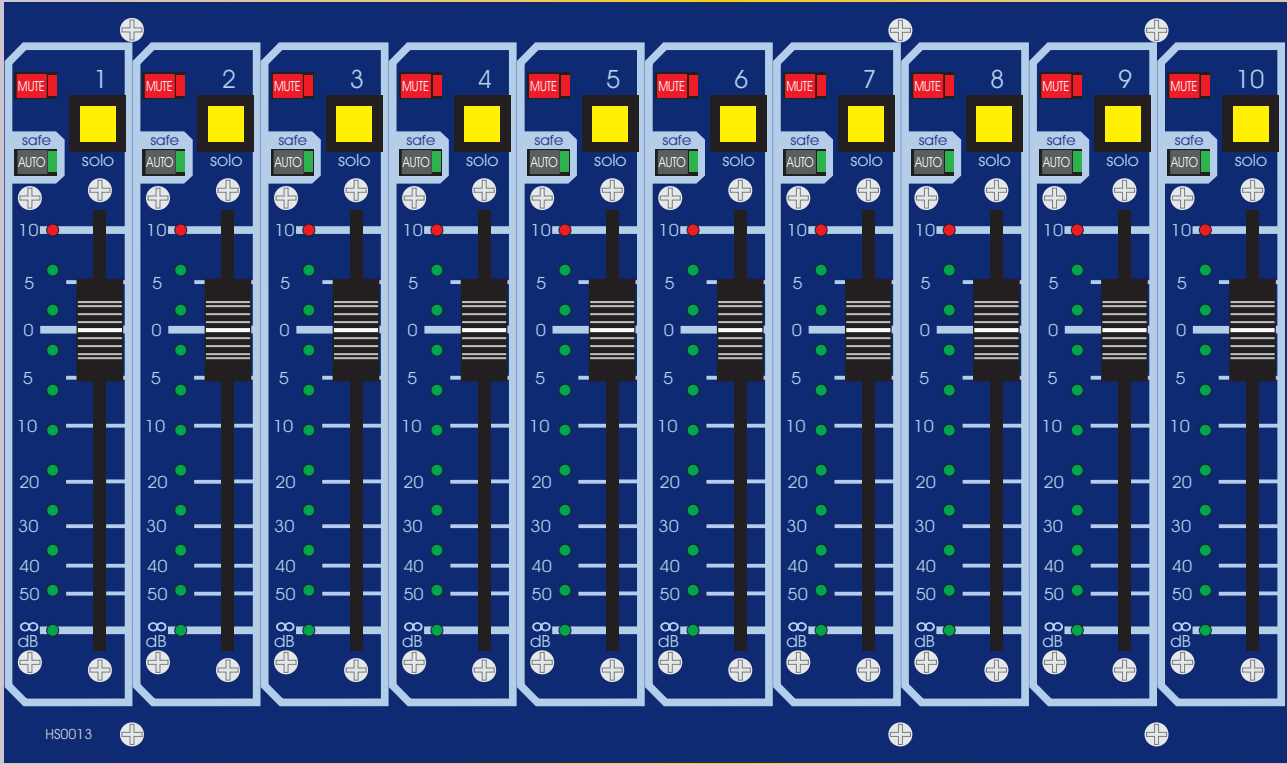

MIDAS HS0013 VCA Master Fader

The vca MUTE switches act on any post fader input channels or audio sub groups which are assigned to be controlled from the corresponding VCA masters. The switches can be controlled from snapshot automation.

The AUTO SAFE switches disable snapshot automation control of the VCA master faders and VCA mutes.

The STATUS LEDs are off when the console is in VCA or MUTE assignment modes (see assignment operation). When the console is in FADER mode the STATUS LEDs can indicate one of three states: -

FADER MANUAL RECALL AND NULL
 In this mode, the STATUS LEDs are used to prompt the operator where to move the fader. If the fader is not at the position stored in the current recalled snap shot, one/two LEDs will flash to indicate where the fader should be. A single flashing LED indicates that the fader should be positioned next to that LED, if two LEDs are flashing the fader should be between the two LEDs. As the fader is moved closer to the required position the LED(s) will stop flashing and will be replaced by a single continuously lit LED. Once the fader is at the correct position all LEDs will extinguish.

FADER POSITION CHECK
 When a scene's contents are being "checked" (see automation operation) the STATUS LEDs will indicate the fader position stored in the scene by continuously illuminating one or two LEDs as appropriate.

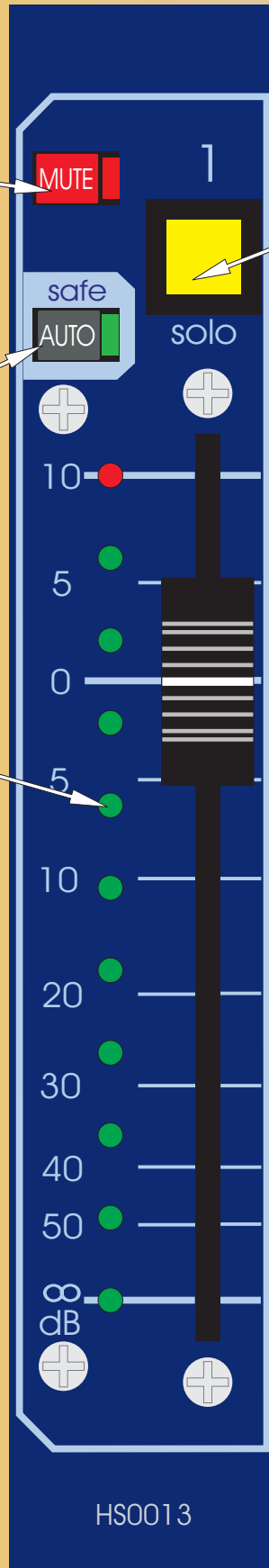

The vca SOLO switches are used to monitor the VCA master faders by creating a mix on the solo busses which consists of all input channels and audio sub groups which are assigned to control from the corresponding VCA masters. If a VCA solo switch is pressed for a short time it will latch on or off, but if it is held on for more than 1 second the latching is disabled and when the switch is released the solo will turn off. When the console is operating in SOLO ADD MODE input channels have priority over VCA solos and will temporarily override them.

VIRTUAL FADER RECALL
 When in VIRTUAL FADER mode (see automation operation) the automation system will generate a "virtual" fader, set to the level of the input fader at the time the snap shot was stored. The level of the virtual fader is added to the level of the physical input fader. In this mode the STATUS LEDs indicate the "position" of the virtual fader by illuminating a bar of LEDs starting at - ∞.



MIDAS HS0041 Aux Module

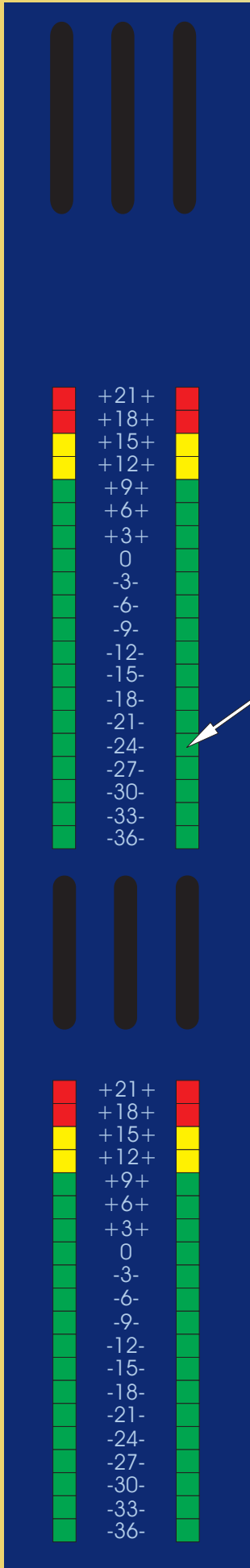

The METERS monitor the peak signal levels of the aux outputs (post fader).

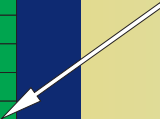

The VCA switches assign the aux output to VCA control from VCA masters 9 and 10.

The INS switches connect the aux insert return signals to the aux mixes.

The mute SAFE switches remove the aux mutes from snapshot automation.

The SPLIT switch changes the aux AFL solos from mono to stereo.

The AUX faders give continuous adjustment of the aux output levels from +10dB to off.

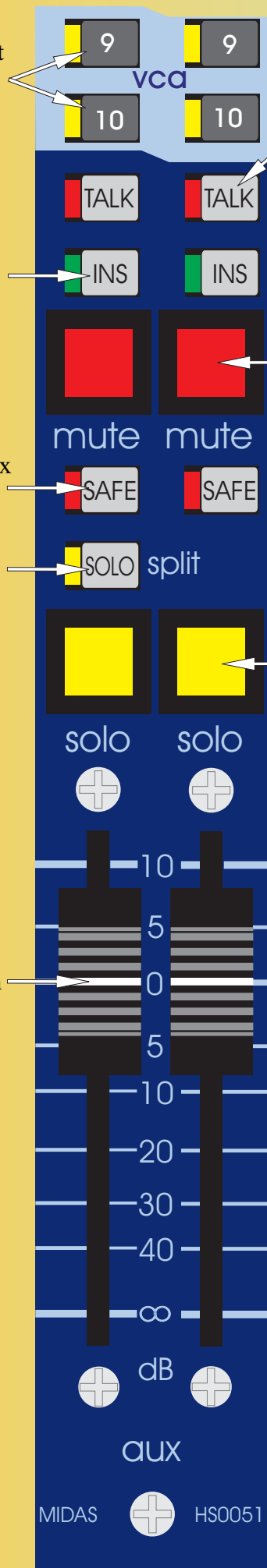

The TALK switches connect the aux mixes to the MONITOR module. When the TALK INTERNAL or GENERATOR INTERNAL are active on the MONITOR module the oscillator, pink noise and talk mic can be routed into the aux mixes.

The aux MUTE switches mute the aux signals at all points after the insert send. The switches can be controlled from snapshot automation.

The SOLO switches send aux signals to the PFL mono and AFL stereo busses. If a SOLO switch is pressed for a short time it will latch on or off, but, if it is held on for more than 1 second the latching is disabled and when the switch is released the channel solo will turn off. As a default the solo system is auto cancelling so each new solo cancels the last. This function is time dependant which allows several solos to be active as long as they are switched on at approximately the same time, i.e. to solo both sides of a stereo mix press both solo switches at the same time. Alternatively the SOLO ADD MODE switch on the MONITOR module can be used to defeat the auto cancelling and allow multiple channel monitoring. In this mode input channel solos have priority over the aux solos and will temporarily override them. When the input solos are cancelled the aux solos will be active again.



MIDAS HS0021 Masters Module

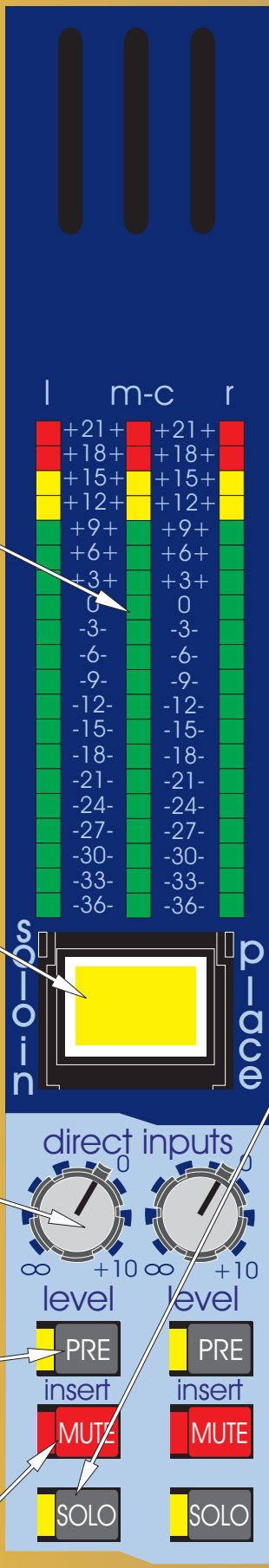

The METERS monitor the peak signal levels of the three master outputs (post fader).

The SOLO IN PLACE switch sets the console to solo in place mode. In this mode any input solo that is pressed activates a mute of all the other channels. The mute safe switches on the input channels can be used to protect channels from this function if desired.

The DIRECT input controls give continuous adjustment of the direct input levels from + 10dB to off. The direct signals are summed into the master left and right signals and can be used as effects returns etc. or for console bus linking. The master mono also has a direct input XLR on the rear of the console for which is intended for console linking only.

The direct PRE switches move the point at which the direct signals are summed into the masters. The default is post insert but when the PRE switches are active the signals are summed at the master mix busses.

The direct MUTE switches mute the master direct inputs at all points.

The direct SOLO switches send direct input to the PFL mono and AFL stereo busses. If a SOLO switch is pressed for a short time it will latch on or off, but, if it is held on for more than 1 second the latching is disabled and when the switch is released the solo will turn off. As a default the solo system is auto cancelling so each new solo cancels the last. This function is time dependant which allows several solos to be active as long as they are switched on at approximately the same time, i.e. to solo both sides of a stereo mix press both solo switches at the same time. Alternatively the SOLO ADD MODE switch on the MONITOR module can be used to defeat the auto cancelling and allow multiple channel monitoring. In this mode input channel solos have priority over all other solos and will temporarily override them.

The matrix STEREO switches select the source for the lower matrix mix controls as either left channel, right channel or a sum of both.

The PRE fader switches change the signals sent to the matrix mixes from post group fader to pre group fader.

The MONO level control gives continuous adjustment of the mono master output level from +10dB to off.

The mono TALK switch connect the mono master to the MONITOR module. When the TALK INTERNAL or GENERATOR INTERNAL are active on the MONITOR module the oscillator, pink noise and talk mic can be routed to the mono master outputs.

The mono INST switch connects the mono insert return signals to the mono master signals.

The matrix MIX controls (1 to 8) give continuous adjustment of the master levels sent to the matrix mixes from +6dB to off. The top control adjusts the feed from the mono master and the lower control adjusts the feed from the stereo masters.

The PRE insert switches change the signals sent to the matrix mixes from post group insert to pre group insert and override the pre fader switches. It is important to note that pre insert matrix sends are also pre the master mutes.

The MUTE switch mutes the mono master signals at all points after the insert send. The switch can be controlled from snapshot automation.

The mono mute SAFE removes the mono mute from snapshot automation.

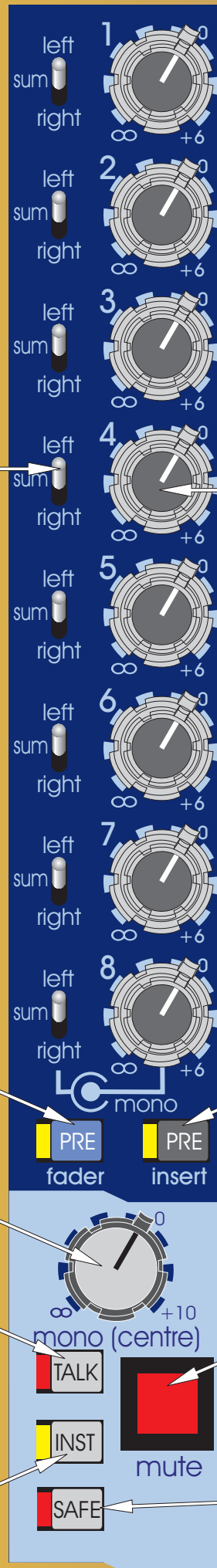



The TALK switches connect the stereo masters to the MONITOR module. When the TALK INTERNAL or GENERATOR INTERNAL are active on the MONITOR module the oscillator, pink noise and talk mic can be routed to the stereo masters.

The mute SAFE switches remove the stereo master mutes from snapshot automation.

The VCA link to mono switch connects the mono master level control to the stereo master fader so that the mono output tracks any change of the stereo master fader.

The BALANCE (pan) control gives continuous and reciprocal adjustment of the stereo left and right signal levels by + 3dB to off. This allows fine adjustment of the left, right power levels and imaging.

The INS switches connect the master insert return signals to the stereo master signals.

The MUTE switches mute the stereo master signals at all points after the insert send. The switches can be controlled from snapshot automation.

The STEREO to mono switch connects a mono sum of the pre insert stereo master signals to the mono master bus.

The MASTER FADER gives continuous adjustment of the stereo master output levels from + 10dB to off.

+21+
 +18+
 +12+
 +9+
 +6+
 +3+
 0
 -3-
 -6-
 -9-
 -12-
 -15-
 -18-
 -21-
 -24-
 -27-
 -30-
 -33-
 -36-

300 1k
 kHz
 100 10k
 signal freq
 generator
 PINK
 0
 ∞ +10
 level
 generator internal external
 generator internal external

TALK to all internal
 talk mic
 +40 0
 +20 +40 ∞ +10
 mic gain level
 talk internal external
 talk internal external

PRE meter change over
 TALK input
 MONO masters
 SOLO
 ∞ +10
 ∞ +10
 level level
 mono source
 mono output
 output 'b'
 mute
 MUTE phones
 ST EXT
 MONO SOLO
 stereo source
 stereo output
 output 'b'
 left only
 ON PAD
 L R
 L r reverse -20dB
 mute mute
 SOLO add mode
 SOLO pre fade (PTI)
 solo clear
 10 10
 5 5
 0 0
 5 5
 10 10
 20 20
 30 30
 40 40
 ∞ ∞
 dB dB
 monitor
 MIDAS HS0031

MIDAS HS0031 Monitor Module

The METERS monitor the peak signal levels of the stereo left and right monitor paths.

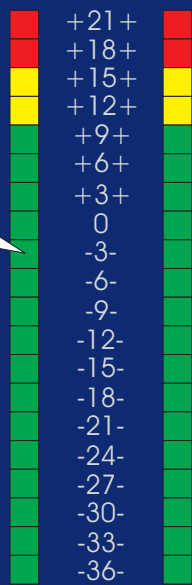

The 1kHz switch overrides the swept frequency control giving a fixed 1k tone.

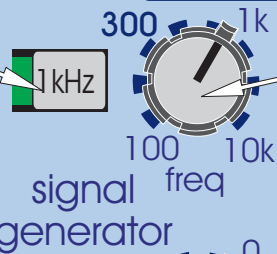

The FREQ. control gives continuous adjustment of the oscillator frequency from 100Hz to 10k.

The PINK switch overrides the oscillator by giving a pink noise output.



The generator LEVEL control gives continuous adjustment of the signal generator peak output signals from +10dBu to off.

The GENERATOR TO INTERNAL switch connects the signal generator output to the console's internal talk all and talk select busses.

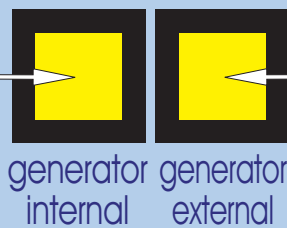

The GENERATOR TO EXTERNAL switch connects the signal generator output to the talk external output XLR.

The TALK TO ALL switch overrides all output talk switches so that the generator or talk mic can be routed to ALL OUTPUTS



The TALK XLR socket accepts balanced 150Ω microphone signals.

The MIC GAIN preset gives continuous adjustment of the microphone amplifier gain from +20dB to +60dB and operates in conjunction with a peak limiter which is factory set to +10dBu.

The TALK TO INTERNAL switch connects the talk mic output to the console's internal talk system and at the same time dims all the local outputs by 20dB to prevent howl round.

The TALK input routes the talk external input to the mono local monitor output.

The MONO masters switch routes the post fader mono master mix to the mono local monitor output.

The SOLO switch routes solo signals to the mono local monitor output when ever a solo is active on the console. This overrides any signals sent from the mono master but does not override talk inputs.

The mono output "b" C/O switch disconnects the mono local monitor output from the main "a" output and re-routes it to the secondary "b" output.

The phones MUTE switch mutes the headphone outputs.

The ST master switch routes the post fader stereo master mix to the stereo local monitor outputs.

The MONO master switch routes the post fader mono master mix to the stereo local monitor outputs.

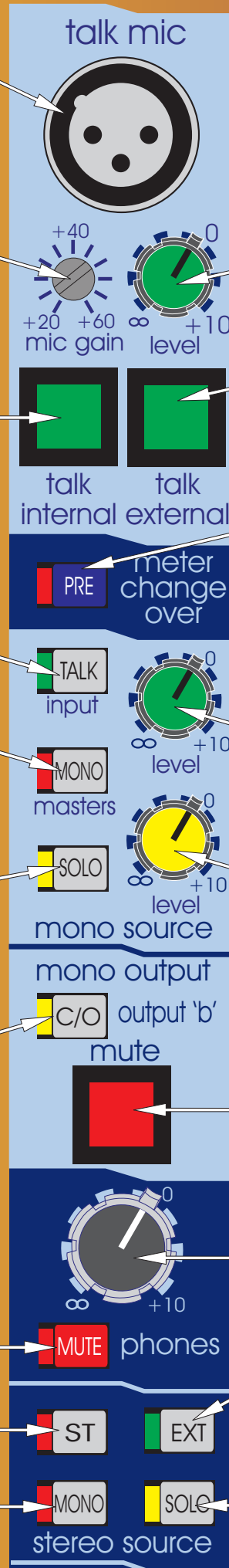

The talk LEVEL gives continuous adjustment of the post limiter signals from +10dB to off.

The TALK TO EXTERNAL switch connects the talk mic output to the talk external output XLR.

The PRE meter change over switch changes the operation of every meter on the console (except the monitor meters). The "normal" meter operation is to monitor pre fader on input channels and post fader on all other signals. When the pre meter change over is active the meters change to monitor input amplifiers or bus amplifiers (as appropriate) on all signals.

The talk LEVEL gives continuous adjustment of the external talk input from +10dB to off.

The talk LEVEL gives continuous adjustment of the external talk input from +10dB to off.

The mono output MUTE switch mutes the mono local monitor output.

The PHONES level control gives continuous adjustment of the headphone level from +10dB to off.

The EXT switch routes the stereo external input (2 track return etc.) to the stereo local monitor outputs.

The SOLO switch routes solo signals to the stereo local monitor outputs when ever a solo is active on the console. This overrides any signals sent from the stereo master, mono master or external input.

The stereo output "b" C/O switch disconnects the stereo local monitor outputs from the main "a" outputs and re-routes them to the secondary "b" outputs.

The PHASE switch reverses the phase of the left hand monitor signal.

When the left/right reverse is ON the left hand monitor signals are routed onto the right channel output speakers and the right hand monitor signal are routed onto the left channel output speakers.

The LEFT switch routes left hand monitor signal to both the left and right local monitor speaker outputs.

The left MUTE switch controls the mute function on the left hand side of the stereo local monitor speaker outputs.

The SOLO PFL switch sends the mono PFL solo bus signals to the headphones and local monitor outputs in place of the stereo AFL solo bus signals.

The SOLO ON / CLEAR switch and indicator has two functions; it illuminates when any solo switch is active and when pressed it clears any active solo switches.

The MONITOR fader gives continuous adjustment of all three local monitor output levels from + 10dB to off.

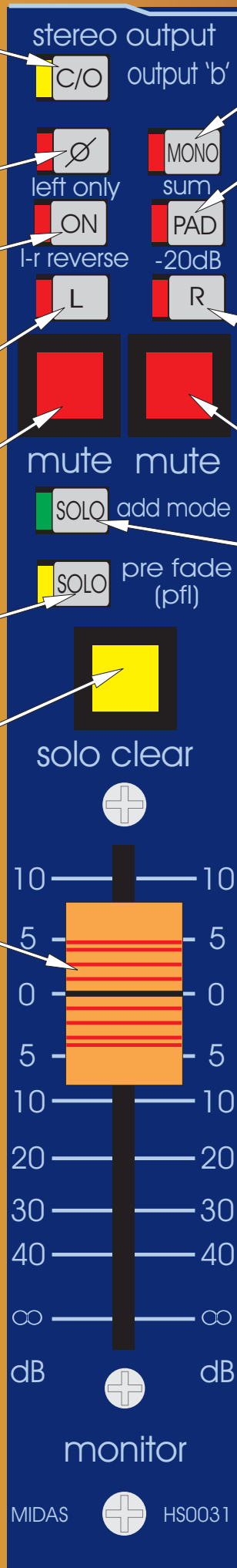

The MONO sum switch adds the left and right monitor signals with a 4.5dB summing loss.

The -20 PAD switch acts on all three local monitor outputs causing them to dim by 20dB. This function is also activated whenever the talk system is in use to prevent howl round.

The RIGHT switch routes right hand monitor signal to both the left and right local monitor speaker outputs.

The right MUTE switch controls the mute function on the right hand side of the stereo local monitor speaker outputs.

The SOLO ADD MODE switch allows multiple channel access to the solo busses. When the solo add mode is off the action of pressing a solo switch will cancel any previously active solo. Multiple solos such as stereo left and right signals can be monitored in this mode of operation as long as the solo switches are pressed at approximately the same time. When the solo add mode is on the auto cancelling is defeated which allows multiple channel or output soloing. In this mode input solos have priority over output solos and VCA solos and will temporarily override them. When the input solo is cancelled the output solos or VCA solos will return.

MIDAS HS0041 Matrix Module

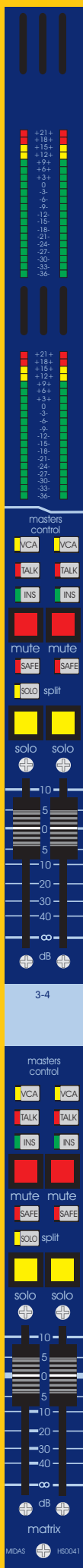

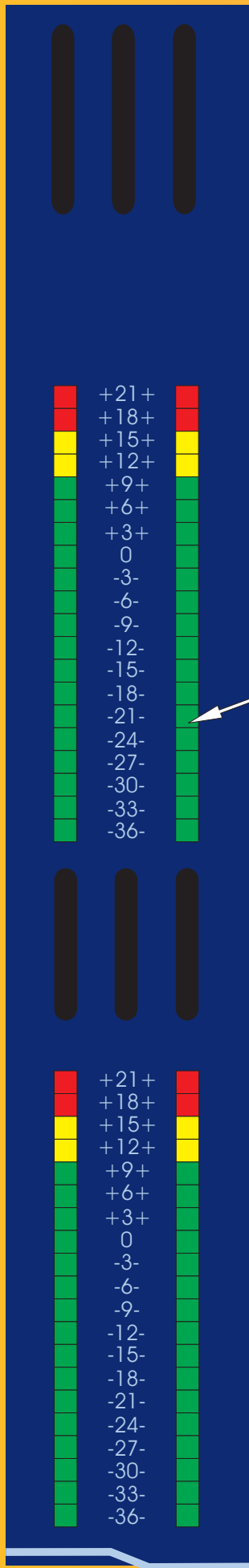

The METERS monitor the peak signal levels of the matrix outputs (post fader).



The VCA switches assign the matrix outputs to VCA control from the MASTER module fader.

The INS switches connect the matrix insert return signals to the matrix mixes.

The mute SAFE switches remove the matrix mutes from snapshot automation.

The SPLIT switch changes the matrix AFL solos from mono to stereo.

The MATRIX faders give continuous adjustment of the matrix output levels from +10dB to off.

The TALK switches connect the matrix mixes to the MONITOR module. When the TALK INTERNAL or GENERATOR INTERNAL are active on the MONITOR module the oscillator, pink noise and talk mic can be routed into the matrix mixes.

The matrix MUTE switches mute the matrix signals at all points after the insert send. The switches can be controlled from snapshot automation.

The SOLO switches send matrix signals to the PFL mono and AFL stereo busses. If a SOLO switch is pressed for a short time it will latch on or off, but, if it is held on for more than 1 second the latching is disabled and when the switch is released the channel solo will turn off. As a default the solo system is auto cancelling so each new solo cancels the last. This function is time dependant which allows several solos to be active as long as they are switched on at approximately the same time, i.e. to solo both sides of a stereo mix press both solo switches at the same time. Alternatively the SOLO ADD MODE switch on the MONITOR module can be used to defeat the auto cancelling and allow multiple channel monitoring. In this mode input channel solos have priority over the matrix solos and will temporarily override them. When the input solos are cancelled the matrix solos will be active again.

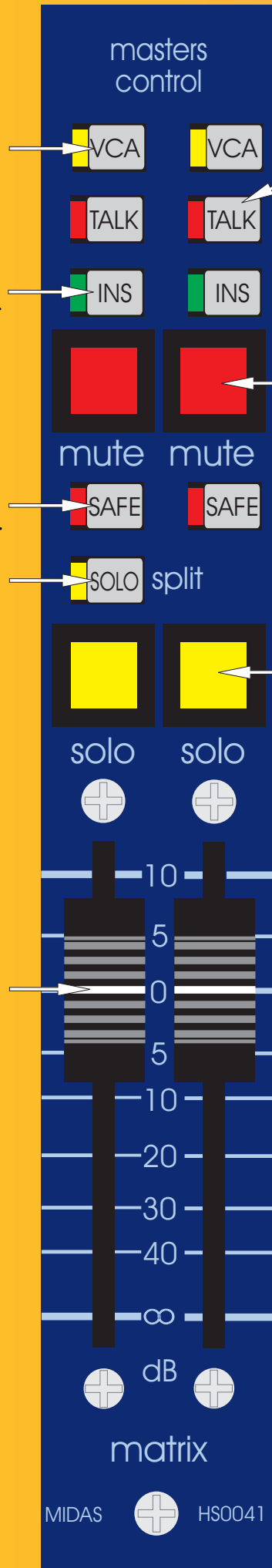

The image displays a control panel layout for a MIDAS automation system, organized into three main sections: assign keys, mode switches, and automation system.

assign keys: A vertical column of 10 buttons, numbered 1 through 10, each with a small red indicator light. Above and below the numbers are circular icons with a crosshair.

mode switches: A vertical column of four buttons: 'lock' (red), 'vca' (yellow), 'mute' (red), and 'fader' (green). Below these is a 'virtual fader recall mode' button (red) and two small circular buttons labeled 'a' and 'b'.

automation system: A grid of buttons for system control. The top row includes 'store' (red), 'midi' (yellow), and 'system' (yellow). The second row includes 'insert' (yellow), 'delete' (red), and 'copy' (green). The third row includes 'check' (yellow), 'cancel' (red), and 'confirm' (green). Below these is a display area with four green icons and labels 'act' and 'scene'. The next row includes 'act/scene c/o' (yellow), 'down' (yellow), and 'up' (yellow). The bottom row includes 'last' (red), 'now' (yellow), and 'next' (green).

Numbered Automation Keys: A central grid of 10 rows, each with a red button on the left, a number (1-10) in the center, and a green button on the right. The letters 'a', 'u', 't', 'o', 'm', 'u', 't', 'e', 's' are arranged vertically on both sides of the grid.

MIDAS Logo: A circular icon with a crosshair is located at the top right and bottom right of the panel.

Automation

Assignment control

When the LOCK switch is illuminated, all assignment changes are disabled. The LOCK switch will toggle state on each press. The console will automatically go into a locked state if no assignment controls are operated within 90 seconds.

The VCA, MUTE and FADER switches set the current assignment/display mode.

If the console is in VCA or MUTE mode, the ASSIGN KEYS set the changes for input VCA/automute assignment when its SET switch is operated. These can be selected in the following ways:-

To enter ASSIGNMENT mode

Depressing any single assign key that is OFF will set that assign key on.

In this mode, the assign keys define which groups an input VCA/automute is assigned to when its SET switch is operated. i.e. if VCA mode is active and assign keys one and two are on. Pressing an input SET switch will cause that channel to toggle the VCA 1 and 2 assignments of that input from on to off or visa versa.

To enter CLEAR mode set all assign keys to off.

To switch the assign keys off simply press the ones lit to off. Once in clear mode all the assign keys and the input channel sets switches will flash..

In this mode operating an input SET switch will clear all inputs VCA and /or automute assignments to off.

The AUTOMUTE GROUP MASTER keys activate the mute circuits on any assigned input channel.

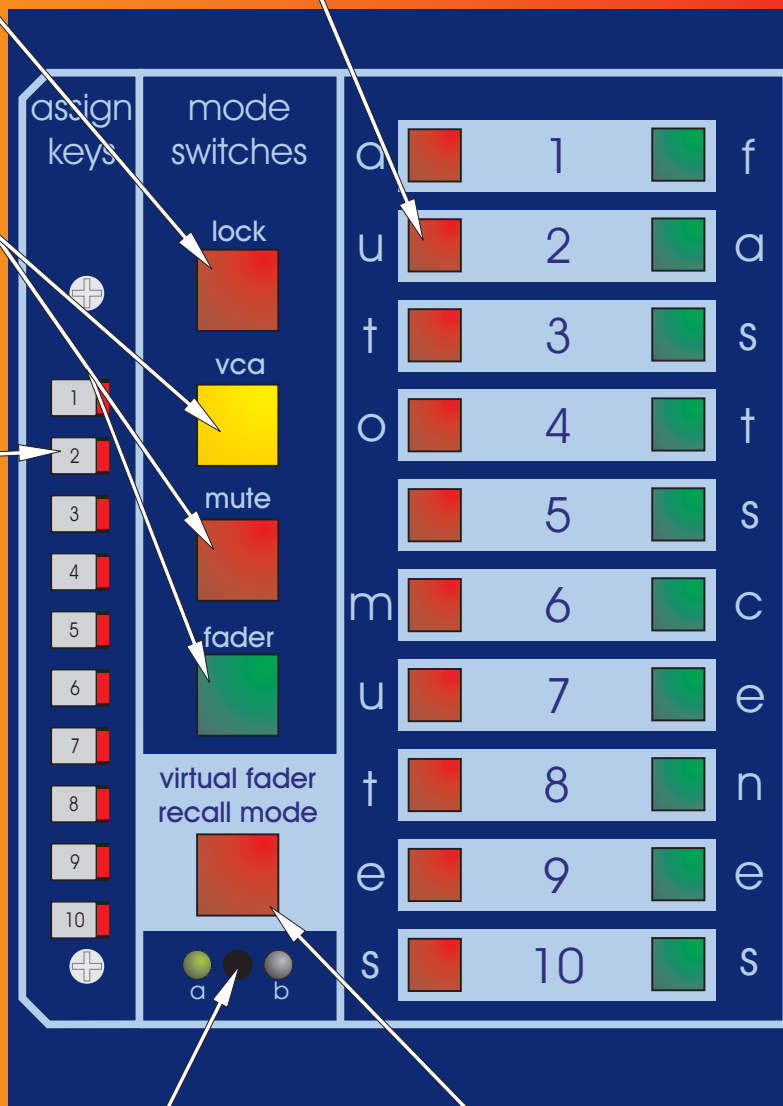

The VIRTUAL FADER key en/disables the operation of the virtual faders. It is only active if the console is unlocked to recall level.

The A/B switch selects which system is controlling the console.

For reliability the assignment/automation systems are 100% duplicated. The console can operate on either of the systems. All snap shots are stored on BOTH of the systems. The LEDs indicate the status of each system in the following manner.

LED green indicates which system is active

LED off indicates which system is inactive

LED red indicates that a system is damaged or not responding and that a service engineer must be called as soon as possible.

Automation control

The snap shots stored in the automation system are numbered in ACTs and SCENEs. There is no difference between an ACT and a SCENE apart from its numbering.

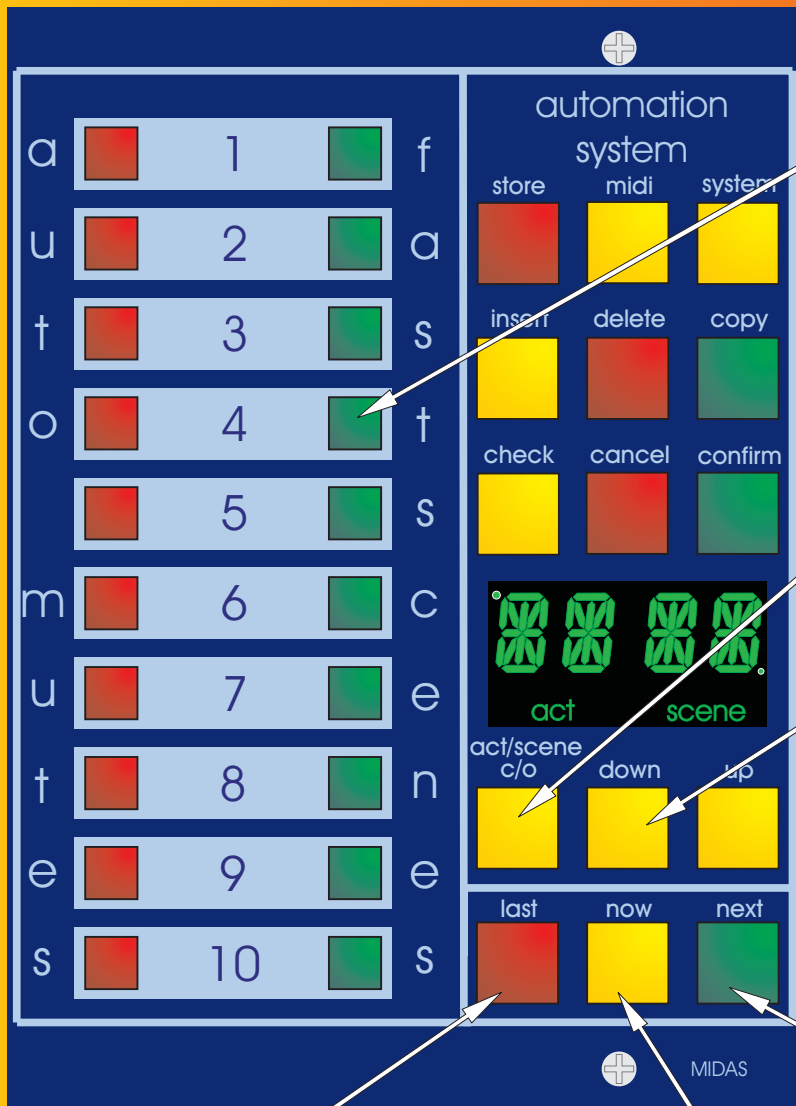

The FAST SCENE keys provide the operator with ten quick entry points into the ACT/SCENE sequence. I.e. if FAST SCENE key one is associated with ACT.SCENE 10.02, pressing it will recall ACT.SCENE 10.02.

When a menu function or midi editor is not selected, the ACT/SCENE C/O key selects the act or scene number. The appropriate indication, ACT or SCENE, will be illuminated to indicate this status.

The UP/DOWN keys allow the operator to enter act/scene numbers and navigate through menus.

The LAST, NOW and NEXT keys recall snap shots to the console surface.

NEXT recalls the snap shot numerically proceeding the snap shot that was currently recalled/stored.

LAST recalls the snap shot numerically preceding the snap shot that was currently recalled/stored.

NOW recalls the snap shot that is currently indicated on the numeric display.

The SYSTEM switch gives the operator access to the system menu. Navigation of the menu is achieved by using the UP/DOWN keys to select an entry, CONFIRM to execute a function, enter a sub menu and CANCEL to exit a menu/sub menu.

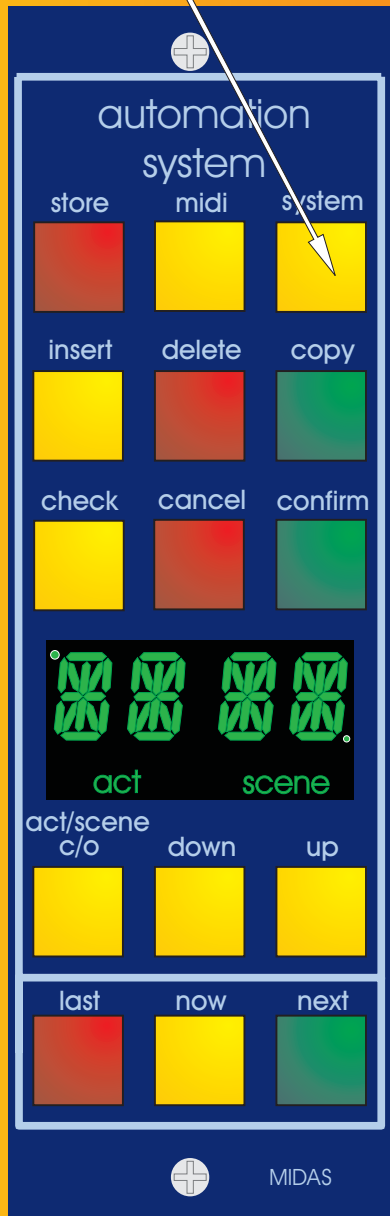

The system menu comprises: -

LOCK defines the level of console operation.

These are: -

TOTL All automation and assignment functions are disabled

RCAL Only recall and assignment functions are available.

STOR Scene storage/editing, recall and assignment are operational

SYST All functions are available.

All following levels of the menu are only available when the console is unlocked to system level.

MIDI accesses the following MIDI functions

CHIN Sets the MIDI channel for console snap shot triggering. i.e. on receipt of a note on message on this channel number the console will recall the ACT.SCENE contained in the note velocity part of the message.

SOUT Allow all snap shot data to be exported as a MIDI SYSEX dump.

SIN Allow all snap shot data to be imported from a MIDI SYSEX dump

CONS allows several consoles to operate as a single system

NONE The console will operate independently

MAST The console will be the master of the system.

SLAV The console will be a slave of the system

CLER Clears all the console snap shot data.

Operating the STORE key will store the current console assignments and settings to the snap shot being displayed on the numeric display.

The MIDI key allows the operator to edit the snap shot MIDI information. On entering this mode the operator will be presented with a menu of the four MIDI messages that are stored within each snap shot, its operation is similar to the system menu.

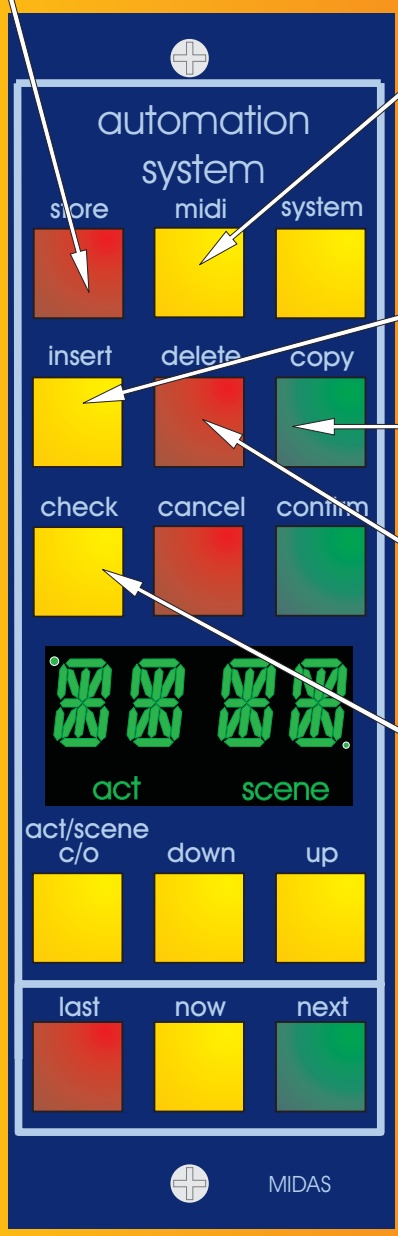

The COPY, DELETE and INSERT keys allow the operator to edit the snap shot sequence in the following manner.

INSERT operating this key will allow the operator to insert a snap shot at the number on the numeric display. The scene that was originally at the number and all con-current scenes will be renumbered by adding one to their scene numbers.

COPY will copy the snap shot currently displayed on the numeric display to a temporary store. This can then be stored/inserted to/at a new number in the normal fashion. If whilst in COPY mode the operator depresses a FAST SCENE keys the number of the snap shot will be associated with that FAST SCENE key.

DELETE allows the operator to delete the snap shot that is currently being displayed on the numeric display.

The CHECK key allows to operator to preview snap shot on the console surface WITHOUT recalling the setting to the console surface. Whilst in check mode the C/O, UP and DOWN keys can be used to step through the snap shots.