

## Sx80T

### Two-Way Speaker System with Transformer

- 8-inch woofer and DH2005 compression driver for great sound and reliable performance
- Constant-directivity 90° x 65° high-frequency horn with VariPath™ geometry for uniform coverage
- Ring-Mode Decoupling (RMD™) for increased intelligibility
- 60-watt transformer with selectable taps
- Molded-in attachment points allow for use with brackets or a stand mount
- Available in paintable black (Sx80TB) or white (Sx80TW)

---

#### Description

---

The Electro-Voice Sx80T is a compact, two-way, high-efficiency, constant-directivity speaker system for sound reinforcement and monitoring. The small size, high sensitivity and high power-handling capacity of the Sx80T make it an excellent choice for use in studios, clubs, bars, theaters or other applications. An internal, 60-watt line transformer with selectable taps allows easy connection to 70-volt or 100-volt speaker lines in distributed systems.

Through extensive use of computer-aided design and modeling, Electro-Voice engineers have developed a state-of-the-art professional loudspeaker system.

The high-frequency section of the Sx80T utilizes a molded-in 90° x 65° constant-directivity horn. This unique pattern contributes to high intelligibility and aims the speakers output where it is most useful. Vocals sound natural yet "cut through" in reverberant, noisy rooms. In addition, the coverage pattern is unusually uniform over its range of operation. The horn's unique, VariPath™ throat geometry helps direct driver output to the corners of the room, to points of coverage not described in the usual specifications

of horizontal and vertical coverage angles, and to parts of the audience that typically do not receive the strongest coverage.

One of the many other unique features of the Sx80T is the cabinet. Constructed of high-impact polystyrene it provides a stiff and extremely durable enclosure. The cabinet includes M6 threaded inserts for the optional Sx80MB U-bracket and M5 threaded inserts for the optional Sx80SM stand mount adaptor kit. It also has inserts for installing with an OmniMount® Series 75 mounting system.

The Sx80T's high-frequency horn is driven by the DH2005 one-inch throat, wide-bandwidth, titanium-diaphragm driver. This driver uses a unique, convex-drive Time Path™ phasing plug structure (U.S. Patent #4,525,604) for smooth and extended high-frequency performance. The voice coil is coupled to the diaphragm with EV's exclusive Resonant Drive™ Technology. This increases and smooths the high-frequency response and reduces the amount of internal equalization required for flat frequency response, which extends to 20,000 Hz.

A self-resetting high-frequency protection circuit, EV's PRO™ circuit, is included with the Sx80T to prevent against accidental overdrive and improve system reliability. If the

input power to the high-frequency driver exceeds the nominal rating, the protection circuit is activated and reduces the power delivered to the driver by 6 dB. The system will remain in this mode of operation until the input power is reduced to a safe level.

The low-frequency section of the Sx80T is a 203-mm (8-in.) direct radiating woofer installed in an optimally-vented enclosure. This results in exceptionally extended bass response and high efficiency in a very small cabinet.

---

#### Ring-Mode Decoupling (RMD™) Technology

---

The Sx80T controls both acoustical and mechanical ring modes to provide dramatically increased intelligibility, using techniques learned from the development of the Electro-Voice X-array™ concert speakers. There is much less coloration of the sound from resonating sources, leaving only the intended sound to be heard by the audience.

---

#### High-Frequency Protection Circuit

---

The Sx80T crossover includes the Electro-Voice automatically resetting PRO™ circuit for high-frequency driver protection. This circuit permits short-term transients to pass,

# Sx80T Two-Way Speaker System With Transformer

but protects the tweeter from long-term power extremes that would normally destroy the tweeter.

## Enclosure Construction

The Sx80T enclosure is constructed of very-durable High-impact polystyrene that is hard to dent, scratch, or break. This enclosure allows for molded in attachment points for the optional Sx80MB mounting bracket, Sx80SM stand mount, or for use with a OmniMount® Series 75 mounting system.

The enclosure is paintable to match any decor. It is recommended, however, that a small area should be tested with the desired paint in order to ensure that there are no adverse effects and that the paint has sufficient adhesion. Care should be taken not to get paint onto the woofer cone or into the horn throat.

## Frequency Response

The combination of a 203-mm (8-inch) woofer, a wide-bandwidth high-frequency driver and an equalized crossover results in the wide and smooth overall response shown in Figure 1. This response was measured at 1 meter (3.281 feet), using a 2.83-volt swept sine-wave input in a full-space anechoic chamber using the internal passive crossover. No external equalization was used.

Figure 1 also shows the half-space measurement of the Sx80T loudspeaker. This curve gives an indication of how the system will respond when mounted on a wall, which is a likely application. This response was also measured at 1 meter (3.281 feet), using a 2.83-volt swept sine-wave input using the internal passive crossover. No external equalization was used.

## Connections

The Sx80T is equipped with barrier strip connectors with a cover. Care should be taken to ensure that the correct polarity is observed when connecting the Sx80T. The barrier strip is marked with + for positive and - for negative.

## Constant-Directivity Speaker System

The crossover frequency and speaker component geometries have been selected so that the directional characteristics of the woofer

and constant-directivity high-frequency horn match at the crossover frequency to create a special system type, the constant-directivity system. At higher frequencies the horizontal coverage pattern remains constant and the vertical pattern smoothly transitions to a 90° angle above 5,000 Hz. Response within the 90° x 65° rated coverage angle is uniform, which means dependable audience coverage without “hot spots” or dead zones at certain frequencies. The 90° x 65° dispersion characteristic also helps avoid early reflections from nearby floor or side-wall surfaces which could degrade performance. The controlled directivity of the high- and low-frequency transducers also eliminates response irregularities caused by diffraction off nearby enclosure edges and, in combination with an essentially flat on-axis frequency response, produces a total acoustic power output that is uniform with frequency.

## Directivity

A unique feature of the Sx80T is the constant-directivity dispersion provided by the 90° x 65° horn. The polar response of the system at selected one-third-octave bandwidths is shown in Figure 2. These polar responses were measured in a full-space anechoic environment at 6.1 meters (20 feet) using one-third-octave pink-noise inputs. The frequencies selected are fully representative of the polar response of the system. Beamwidth of the system utilizing the complete one-third-octave polar data is shown in Figure 3. Directivity factor,  $R_Q$ , and directivity index,  $D_i$ , are plotted in Figure 4.

## Power-Handling Capacity

Electro-Voice components and systems are manufactured to exacting standards, ensuring they will hold up, not only through the most rigorous of power tests, but also through continued use in arduous, real-life conditions. The EIA Loudspeaker Power Rating Full Range (ANSI/EIA RS-426-A 1980) uses a noise spectrum which mimics typical music and tests the thermal and mechanical capabilities of the components. Electro-Voice will support relevant additional standards as and when they become available. Extreme, in-house power tests,

which push the performance boundaries of the woofers, are also performed and passed to ensure years of trouble-free service.

Specifically, the Sx80T passes ANSI/EIA RS-426-A 1980 with the following values:

$$R_{SR} = 6.21 \text{ ohms } (1.15 \times R_E)$$

$$R_E = \text{woofer DCR} = 5.4$$

$$P_{E(\text{MAX})} = 175 \text{ watts}$$

$$\text{Test voltage} = 32.97 \text{ volts rms,}$$

$$65.93 \text{ volts peak (+6dB)}$$

The “peak” power-handling capacity of a woofer is determined by the peak test voltage amount. For the Sx80T, a 65.93-volt peak test voltage translates into 700-watts short-term peak power-handling capacity. This is the equivalent of four times the “average” power-handling capacity, and is a peak that can be sustained for only a few milliseconds. However, this sort of short duration peak is very typical in speech and music. Provided the amplifier can reproduce the signal accurately, without clipping, the woofer will also perform accurately and reliably, even at these levels.

## Service

In the unlikely event the Sx80T requires service, the woofer can be removed from the front. The high-frequency driver can be removed by separating the front and the rear halves of the enclosure and removing the bolt that attaches the driver to the rear. A service data sheet is available from Electro-Voice.

## Stand Mounting

The Sx80T enclosure contains four M5 inserts (see Figures 6 and 8) for the attachment of the optional Sx80SM stand mount adaptor kit for mounting the Sx80T on a 1-3/8 in. stand. Please refer to the Sx80SM engineering data sheet for complete installation instructions.

## Suspending Sx80T Enclosures

**WARNING:** *Suspending any object is potentially dangerous and should be attempted only by individuals who have a thorough knowledge of the techniques and regulations of rigging objects overhead. Electro-Voice strongly recommends that the Sx80T be suspended taking into account all current na-*

# Sx80T Two-Way Speaker System With Transformer

tional, federal, state, and local regulations. It is the responsibility of the installer to ensure the Sx80T is safely installed in accordance with all such regulations. If the Sx80T is suspended, Electro-Voice strongly recommends that the system be inspected at least once a year. If any sign of weakness or damage is detected, remedial action should be taken immediately.

The Sx80T enclosure contains seven M6 inserts and (see Figure 6) which are built into the enclosure for the purpose of suspension. These inserts can be used with either the Sx80MB mounting bracket from Electro-Voice, or with an OmniMount® Series 75 mounting system.

## Sx80MB

The Sx80MB is a universal U-bracket designed to allow the suspension of the Sx80T at any angle and orientation from the wall or ceiling (See Figures 6 and 8). It uses M6 inserts on the top and the bottom of the enclosure. There is an extra M6 insert on the top of the enclosure for a safety chain. Full instructions are included in the Sx80MB engineering data sheet.

## OmniMount® Series 75

Four M6 threaded inserts and screws are located on the rear of the Sx80T for use with the OmniMount® Series 75 support system. A safety chain should be used to ensure safe operation. Full instructions for the OmniMount® Series 75 can be obtained from:

OmniMount Systems Inc.  
8201 South 48th Street  
Phoenix, AZ 85022  
Tel: 602/829-8000  
Fax: 602/756-9000

## Transformer Settings

A transformer and power selector switch are installed in the rear of the enclosure. The level of the Sx80T may be adjusted by changing the switch setting using a screwdriver. Turning the switch clockwise increases the power. Since the same switch and transformer are used for either the 100-volt or 70-volt line, the power setting depends upon the amplifier

output that is used, 100-volt or 70-volt.

**CAUTION:** When connected to a 100-volt line, do not use the switch setting marked “DO NOT USE,” as this may result in excessive power driving the Sx80T or excessive distortion.

## Architects’ and Engineers’ Specifications

The loudspeaker shall consist of a 200-mm (8.0-in.) low frequency transducer in a vented, trapezoidal-shaped enclosure: a DH2005 high-frequency compression driver with a pure titanium diaphragm coupled to a 90° X 65° constant-directivity horn molded into the front baffle of the enclosure. The system will use a passive crossover-equalize network with protection for the high-frequency driver. The loudspeaker shall meet the following performance criteria: frequency response of 65 to 20,000 Hz, -3 dB; maximum power handling of 60 watts long term and 240 watts short term with switch selectable taps for 60 W, 30 W, 15 W, 7.5 W, 3.7 W and 1.8 W, with a shaped random-noise input per ANSI/EIA RS-426-A 1980; sensitivity of 92 dB SPL at 1 meter with a 1-watt, 300-2,000-Hz pink-noise input; 6-dB-down horizontal coverage angle of 90° + 34°/-27° in the 2,000- to 20,000-Hz range; 6-dB-down vertical coverage angle of 65° + 31°/-4° in the 2,000- to 20,000-Hz range; crossover frequency of 2,200 Hz; nominal impedance of 8 ohms and minimum impedance of 7.2 ohms. Input connectors shall be push pins. The enclosure shall be constructed of high-impact polystyrene and fitted with a powder-coated steel grille, and M6 and M5 threaded inserts for optional accessories. Dimensions shall be 400 mm (15.75 in.) high x 292 mm (11.5 in.) wide x 240 mm (9.45 in.) deep. Net weight shall be 9.3 kg (20.5 lb).

The system shall be capable of producing average sound levels in excess of in the long term, and short-term peaks.

The loudspeaker system shall be the Electro-Voice Sx80TB (black) or Sx80TW (white).

## Uniform Limited Warranty

Electro-Voice products are guaranteed against malfunction due to defects in mate-

rials or workmanship for a specified period, as noted in the individual product-line statement(s) below, or in the individual product data sheet or owner’s manual, beginning with the date of original purchase. If such malfunction occurs during the specified period, the product will be repaired or replaced (at our option) without charge. The product will be returned to the customer prepaid.

**Exclusions and Limitations:** The Limited Warranty does not apply to: (a) exterior finish or appearance; (b) certain specific items described in the individual product-line statement(s) below, or in the individual product data sheet or owner’s manual; (c) malfunction resulting from use or operation of the product other than as specified in the product data sheet or owner’s manual; (d) malfunction resulting from misuse or abuse of the product; or (e) malfunction occurring at any time after repairs have been made to the product by anyone other than Electro-Voice Service or any of its authorized service representatives. **Obtaining Warranty**

**Service:** To obtain warranty service, a customer must deliver the product, prepaid, to Electro-Voice Service or any of its authorized service representatives together with proof of purchase of the product in the form of a bill of sale or receipted invoice. A list of authorized service representatives is available from Electro-Voice Service at 600 Cecil Street, Buchanan, MI 49107 (800/234/6831 or FAX 616/695/4743). **Incidental and**

**Consequential Damages Excluded:** Product repair or replacement and return to the customer are the only remedies provided to the customer. Electro-Voice shall not be liable for any incidental or consequential damages including, without limitation, injury to persons or property or loss of use. Some states do not allow the exclusion or limitation of incidental or consequential damages so the above limitation or exclusion may not apply to you. **Other Rights:** This warranty gives you specific legal rights, and you may also have other rights which vary from state to state.

**Electro-Voice Speakers and Speaker Systems** are guaranteed against malfunction due to defects in materials or workmanship for a period of five (5) years from the date of origi-

# Sx80T Two-Way Speaker System With Transformer

nal purchase. The Limited Warranty does not apply to burned voice coils or malfunctions such as cone and/or coil damage resulting from improperly designed enclosures. Electro-Voice active electronics associated with the speaker systems are guaranteed for three (3) years from the date of original purchase. Additional details are included in the Uniform Limited Warranty statement.

**Electro-Voice Electronics** are guaranteed against malfunction due to defects in materials or workmanship for a period of three (3) years from the date of original purchase. Additional details are included in the Uniform Limited Warranty statement.

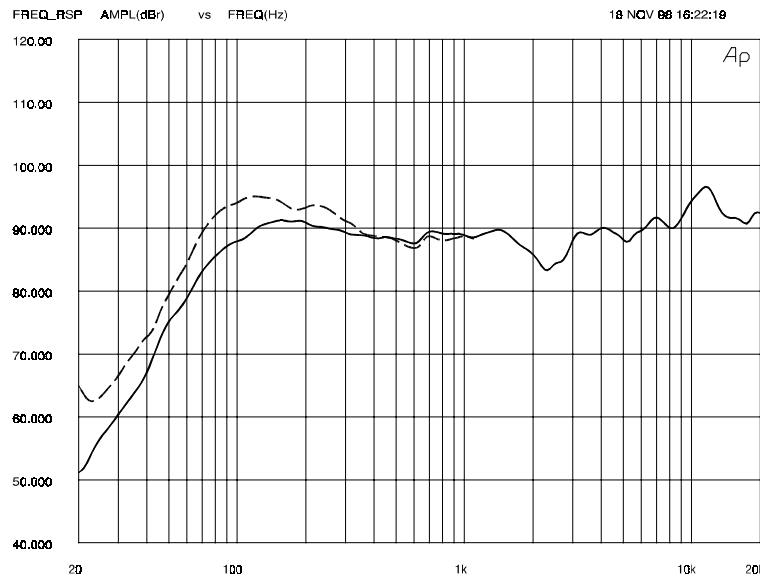
For warranty repair, service information, or a listing of the repair facilities nearest you, contact the service repair department at:

616/695-6831 or 800/685-2606.

**For technical assistance**, contact Technical Support at 800/234-6831 or 616/695-6831, M-F, 8:00 a.m. to 5:00 p.m. Eastern Standard time.

**Figure 1— Sx80T Axial Frequency Response, (full space and half space anechoic environment, 1 watt (2.83 volts) /1 meter (3.281 feet)**

— Full space  
 - - - Half space

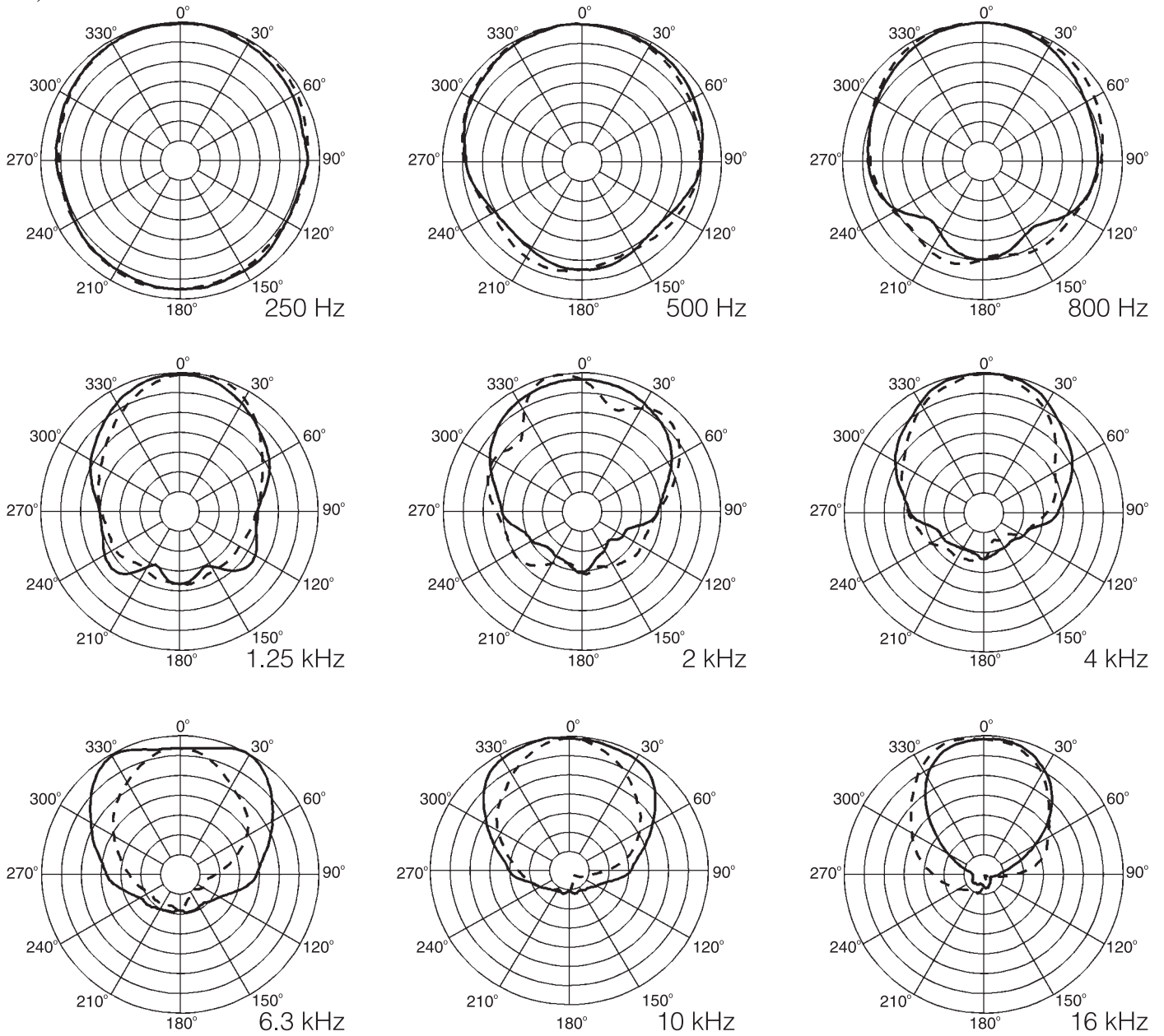


# Sx80T Two-Way Speaker System With Transformer

**Figure 2—Sx80T One-Third-Octave Polar Responses (full space anechoic environment, 4 volts/6.10 meters (20 feet))**

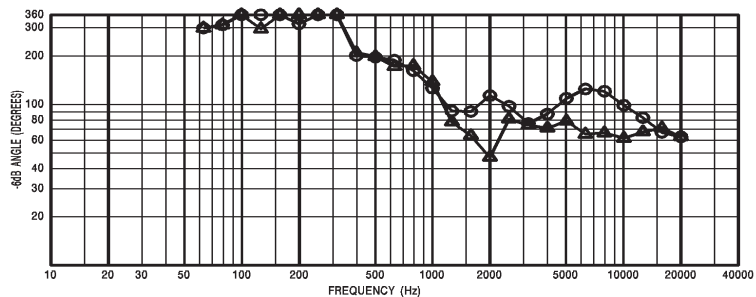
5 dB per division

— HORIZONTAL  
- - - VERTICAL



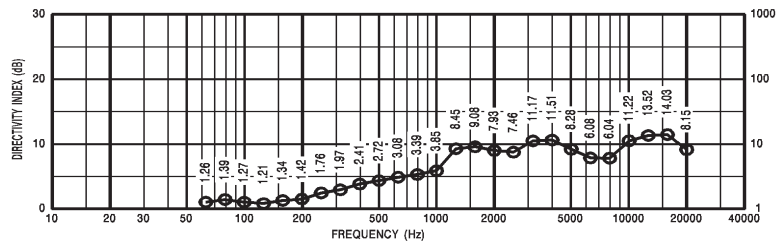
Sx80T Two-Way Speaker System With Transformer

**Figure 3—Sx80T Beamwidth vs. Frequency (full-space anechoic environment)**

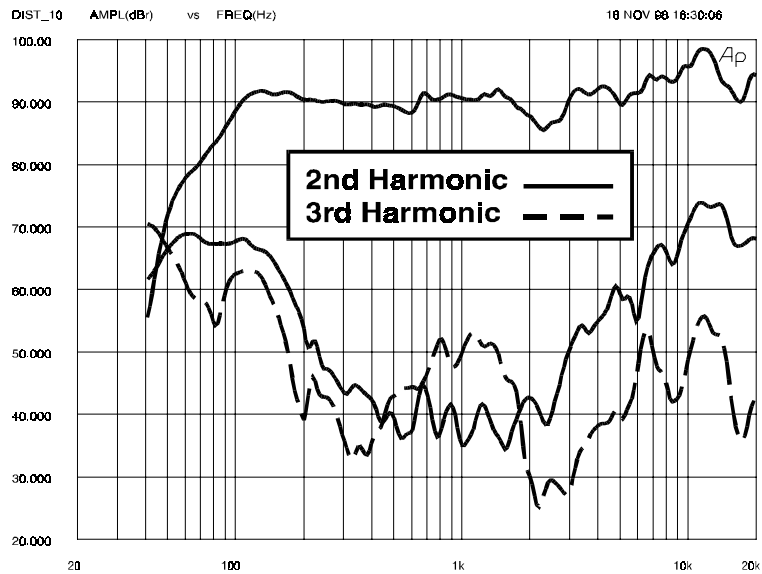


# Sx80T Two-Way Speaker System With Transformer

**Figure 4— Sx80T Directivity vs. Frequency (full-space anechoic environment)**

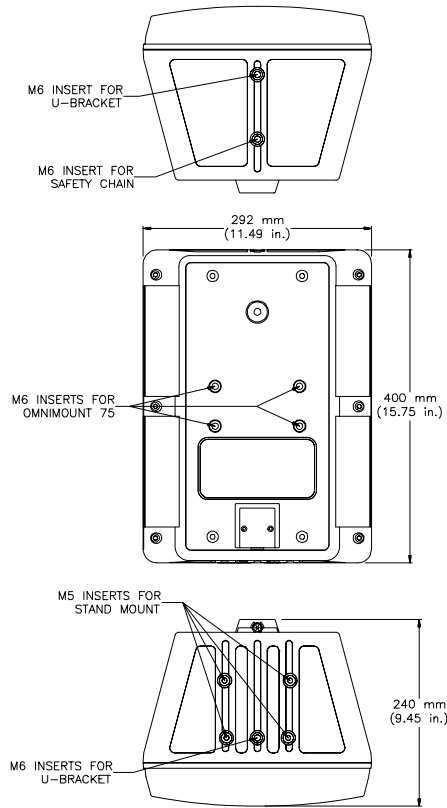


**Figure 5— Sx80T Harmonic Distortion Response 10% Rated Power Input (17.5 watts), (full-space anechoic environment, 3.05 meters (10 feet) on axis)**

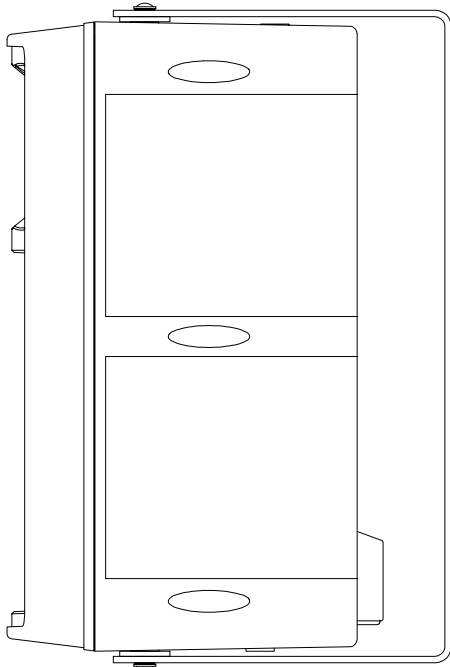


# Sx80T Two-Way Speaker System With Transformer

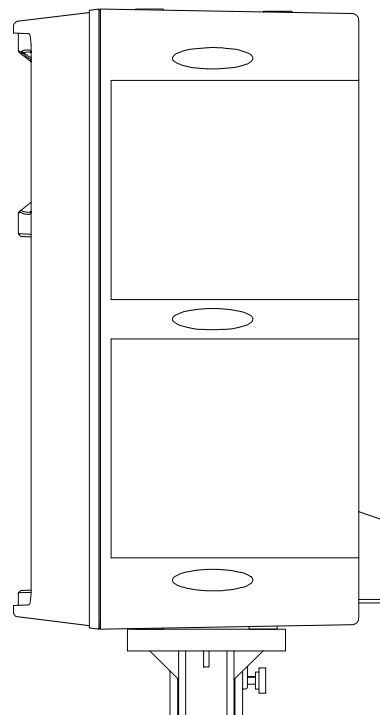
**Figure 6— Sx80T Dimensions and Inserts**



**Figure 7— Sx80T enclosure with Sx80MB wall/ceiling mounting bracket.**



**Figure 8— Sx80T enclosure with Sx80SM stand mounting kit.**



# Sx80T Two-Way Speaker System With Transformer

Sx80T Two-Way Speaker System With Transformer

## Specifications

**Typical Axial Frequency Response, Swept Sine Wave, 4 volts at 3.05 meters (10 feet), (half-space, normalized for 1 watt at 1 meter; see Figure 1):**

65-20,000 Hz

**Low-Frequency 3-dB-Down Point:**

65 Hz

**Usable Low-Frequency Limit (10-dB-down point):**

51 Hz

**Half Space Reference Efficiency:**

1.2 %

**Long-Term Average Power-Handling Capacity per EIA Standard RS-426-A 1980 (see Power-Handling Capacity section):**

2-60 watts, selectable in 3 dB steps (transformer-limited)

**Maximum Woofer Acoustic Output:**

2.1 watts

**Sensitivity (SPL at 1 watt, 1 meter input, half-space, swept sine wave):**

92 dB

**Nominal Coverage Angle,**

**Horizontal: 90°**

**Vertical: 65°**

**Dispersion Angle Included by 6-dB-Down Points on Polar Responses, Indicated One-Third-Octave Bands of Pink Noise (see Figure 3),**

2,000-20,000 Hz, Horizontal:

90° (+34°, -27°)

2,000-20,000 Hz, Vertical:

65° (+31°, -4°)

**Directivity Factor  $R_{\theta}(Q)$ , 800- to 16,000-Hz Median (see Figure 4):**

8.3 (+5.7, -4.9)

**Directivity Index  $D_s$ , 800- to 16,000-Hz Median (see Figure 4):**

9.2 dB (+2.3 dB, -3.9 dB)

**Distortion, 0.1 Full Power Input, (see Figure 5)**

**Second Harmonic,**

**100 Hz:**

-21 dB, 9.0%

**1,000 Hz:**

-55 dB, 0.2%

**10,000 Hz:**

-25 dB, 5.6%

**Third Harmonic,**

**100 Hz:**

-26 dB, 4.9%

**1,000 Hz:**

-41 dB, 0.9%

**10,000 Hz:**

-47 dB, 0.5%

**Transducer Complement,**

**High Frequency:**

DH2005 driver

**Low-Frequency:**

203-mm (8-in.) woofer

**Box Tuning Frequency:**

70 Hz

**Crossover Frequency:**

2,200 Hz

**Crossover Slope,**

12 dB per octave

**Impedance:**

Power Tap	Impedance	
	100-volt	70-volt
60 W	167 $\Omega$	83 $\Omega$
30 W	333 $\Omega$	167 $\Omega$
15 W	667 $\Omega$	333 $\Omega$
7.5 W	1,350 $\Omega$	667 $\Omega$
3.8 W	2,700 $\Omega$	1,350 $\Omega$
1.9 W	5,400 $\Omega$	2,700 $\Omega$

**Input Connections,**

**Sx80T:**

Barrier Strip with Cover

**Driver Protection, High Frequency:**

Solid-state self-resetting circuit (PROJ circuit) drops output 6 dB; blocking capacitor with 800-Hz corner frequency and 6-dB-per-octave slope

**Materials,**

**Enclosure:**

Injection-molded high-impact polystyrene, black or white

**Grille:**

Perforated metal grille matches enclosure color

**Dimensions (see Figure 6)**

**Height:**

400 mm (15.75 in.)

**Width:**

292 mm (11.49 in.)

**Depth:**

240 mm (9.45 in.)

**Net Weight:**

9.3 kg (20.5 lb)

**Shipping Weight:**

11.1 kg (24.5 lb)

**Optional Accessories:**

Sx80MB installation kit, black or white

Sx80SM stand mount kit

**Attachment Points:**

Seven M6 and four M5 metric inserts (see Figures 6, 7, and 8 and Suspending Sx80T Enclosures section)

## Electro-Voice®

600 Cecil Street, Buchanan, MI 49107

616/695-6831, 616/695-1304 Fax