

Sx200a

350-Watt Powered Two-Way Portable Speaker System

- Internal, 350-watt continuous, 600-watt dynamic power amplifier—includes active analog processing
- Fully balanced input with switchable crossover at 125 Hz
- Lightweight and compact (47 lb)
- Very strong structural-foam enclosure with integral handle and monitor foot attachment
- Stand mountable and arrayable
- High output—126 dB SPL at 1 meter
- Concert-proven components
- Molded-in HF horn, with 65° x 65° constant-directivity coverage, increases intelligibility in noisy, reverberant rooms
- VariPath™ horn throat geometry helps direct energy to the corners—for better coverage

SPECIFICATIONS:

SYSTEM

Axial Frequency Response (swept sine-wave input, 4 volts at 10 feet on axis, anechoic environment normalized for 1 watt/1 meter; see Figure 1):

80-20,000 Hz

Low-Frequency 3-dB-Down Point:

80 Hz

Usable Low-Frequency Limit with Xp200A Controller (10-dB-down point):

55 Hz

Sound Pressure Level at 1 Meter, Maximum Gain and Amplifier at Clipping Threshold, 0 dBu (0.775 volts rms) into Balanced Input, Anechoic Environment, 300- to 2,000-Hz Average:

126 dB

Maximum Acoustic Output:

11.1 watts

Electronic Crossover,

Frequency:

125 Hz

Slope:

24 dB per octave

Dispersion Angle Included by 6-dB-Down Points on Polar Responses, Indicated One-Third-Octave Bands of Pink Noise (see Figure 4),

2,000-20,000 Hz, Horizontal:

65° ±15°

2,000-20,000 Hz, Vertical:

65° ±15°

Directivity Factor R₀ (Q), 800- to 16,000-Hz Median (see Figure 6):

14.3 (+7.9, -9.3)

Directivity Index D_i, 800- to 16,000-Hz Median (see Figure 6):

11.1 dB (+2.4 dB, -4.1 dB)

Distortion, 0.1 Full Power Output,

Second Harmonic,

100 Hz: 1.2%

1,000 Hz: 1.4%

10,000 Hz: 10%

Third Harmonic,

100 Hz: 0.4%

1,000 Hz: 0.3%

10,000 Hz: 2.2%

Transducer Complement,

High Frequency:

DH2010A driver

Low Frequency:

12-inch EV woofer

Box Tuning Frequency:

65 Hz

Passive Crossover,

Frequency:

1,500 Hz

Slope,

Low Pass:

12 dB per octave

High Pass:

12 dB per octave

Enclosure Materials and Colors:

Black polypropylene structural foam

Supplied Accessories:

Suspending System 200™ Loudspeakers
instruction manual

Optional Accessories:

100BK mounting stand

Mb200 installation kit

Mb300 horizontal array kit

VPCSx protective cover

PDSx padded cover

Other Product Available for Enhancement of Sx200a Performance:

Xp200A electronic system controller

Attachment Points:

Three metric metal inserts (M8 x 1.25)

(see Figure 2 and Suspending the Sx200a Enclosure section)

Safety Approvals (in progress):

UL-813; CSA-C22.2; IEC-65 (ENG-0065);

EMC Directive for European RFI/EMI emissions

Dimensions (see Figure 2),

Height:

58.6 cm (23.1 in.)

Width:

42.9 cm (16.9 in.)

Depth:

31.2 cm (12.3 in.)

Net Weight:

21.3 kg (47.0 lb)

Shipping Weight:

22.6 kg (49.9 lb)

AMPLIFIER

System Output Power, Continuous (4-ohm load, 100- to 130-volt or 200- to 250-volt, 50/60-Hz ac line voltage):

350 watts

Dynamic Range:

>100 dB

Power Bandwidth (-3 dB):

10-40,000 Hz

Frequency Response (±0.5 dB):

65-18,000 Hz

Total Harmonic Distortion (100 Hz),

< 0.5%

Input,

Type:

True balanced, electronic

Sensitivity (for 350-Watt,

unclipped output),

System Gain Control Full Clockwise:

0 dBu (0.775 volts)

System Gain Control Full Counter

clockwise (Input closed):

-∞ dBu

Impedance:

10 kilohms

Sx200a SPECIFICATION GRAPHICS

FIGURE 1 — Sx200a Frequency Response (1 watt/1 meter, anechoic environment)

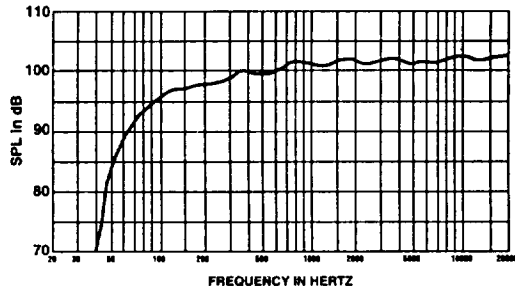

FIGURE 2 — Sx200a Dimensions

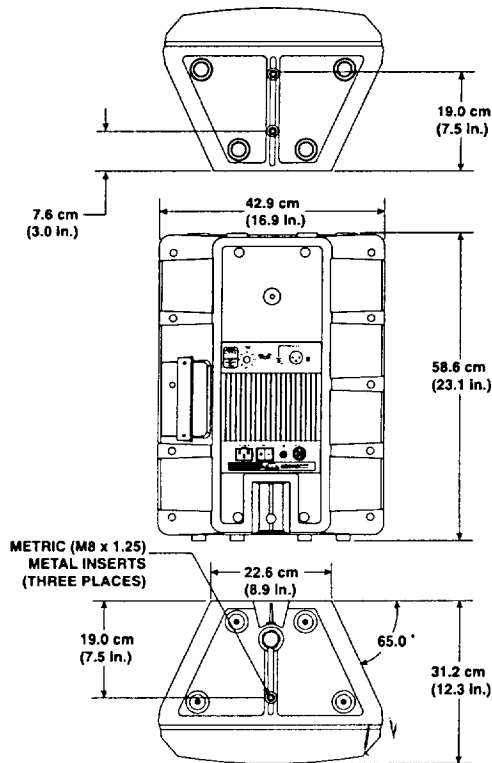

FIGURE 3 — Sx200a Back Panel

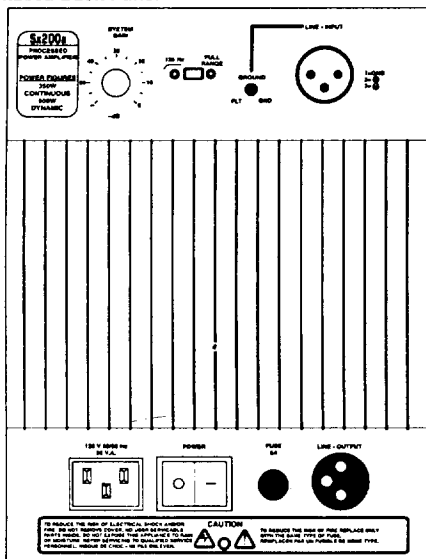

FIGURE 4 — Sx200a Polar Response (anechoic environment)

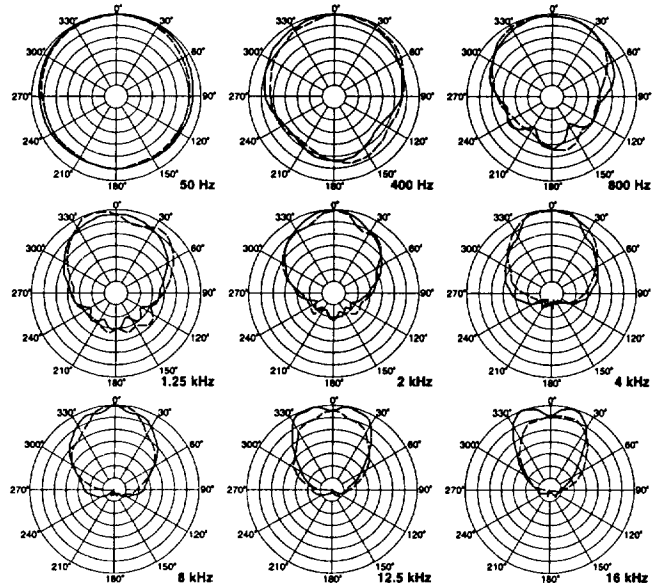

FIGURE 5 — Sx200a Beamwidth Response (anechoic environment)

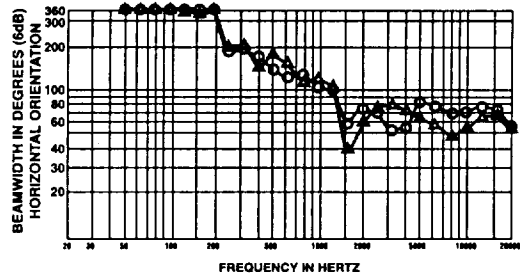

FIGURE 6 — Sx200a Directivity Response (anechoic environment)

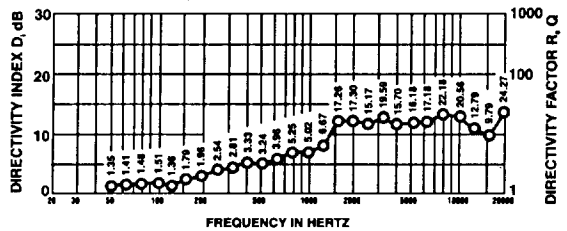
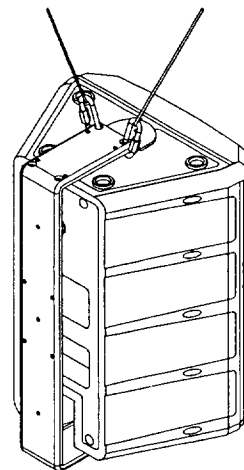

FIGURE 7 — Suspending the Sx200a Using the Mb200 Installation Kit



Controls and Indicators:

- System Gain control (0 to ∞ dB)
- Power on-off switch (illuminated when on)

Connectors:

- XLR-type jack in parallel with 3-pin male XLR-type jack (allows paralleling of Sx200a's)

Polarity (for positive sound pressure):

- Pin 2 positive

Power,

Requirement (per UL-813, maximum average, soft-start power supply):

- 500 watts

Minimum Service Amperage:

- 6 amps

Input Voltage,

- Sx200a: 100-130 V, 50/60 Hz ac

- Sx200a Export: 200-250 V, 50/60 Hz ac

Input Connector: IEC

ac Line Cord (detachable, supplied):

Sx200a:

- 3.0-m (10-ft) three-conductor polarized cable

Sx200a Export:

- 2.5-m (8.2-ft) two-conductor nonpolarized cable with continental-Europe-type wall plug

DESCRIPTION

The Electro-Voice Sx200a is an amplified, 350-watt continuous, 600-watt dynamic, 12-inch, two-way, high-efficiency, constant-directivity portable speaker system. The Sx200a's internal power amplifier includes a clip-free limiter that monitors the woofer and compression driver separately, maintaining spectral balance at any listening level. Extensive headroom brings a good match to the speaker capabilities, producing a great-sounding system in a very portable package.

The high-frequency section of the Sx200a utilizes a molded-in, 65° x 65° constant-directivity horn. This unique pattern contributes to high intelligibility. Vocals sound natural yet "cut through" in reverberant, noisy rooms. In addition, the coverage pattern is unusually uniform over its range of operation. Sound quality off axis is very well maintained, even at 45° off axis (a 90° total coverage angle), well beyond the rated coverage angle. The horn's unique, Varipath™ throat geometry helps direct driver output to the corners of the room, points of coverage not described in the usual specifications of horizontal and vertical coverage angles, and parts of the audience that typically do not receive the strongest coverage.

One of the many other unique features of the Sx200a is the cabinet. Constructed of high-impact polypropylene structural foam, it provides a stiff and extremely durable enclosure. Molded into the cabinet are an integral carrying handle and a stand socket for mounting on 1 $\frac{3}{8}$ -inch stands such as the Electro-Voice model 100BK. Rubber feet that are attached to the bottom of the cabinet and mating sockets that are molded into the top provide a means of stacking systems. The trapezoidal-shaped cabinet, in combination with the uniform, 65° x 65° directivity characteristics, make the Sx200a ideal for use alone or in arrays.

Two feet are supplied with the Sx200a which allow the system to be used horizontally as a stage monitor. The feet are used by inserting them into the holes at the rear of the cabinet. The "O" rings on the feet allow the feet to be removed many times without wear. Two screws are provided to position the feet permanently, if desired.

In situations requiring additional bass output, the Sx200a can be used in combination with the Electro-Voice Xp200A system controller. The Xp200A includes a low-frequency enhancement circuit that is tailored to match the low-frequency characteristics of the Sx200a. Up to 12 dB of additional bass output can be obtained from the system when used with the Xp200A system controller. The amount of low-frequency enhancement can be adjusted to suit the user's personal preference.

For the most demanding situations, two bass-module models are available to complement the Sx200a: the Electro-Voice Sb120 nonpowered bass module and the Electro-Voice Sb120a powered bass module. Both bass modules were designed to be used with the Sx200a and are constructed in similar structural foam enclosures. The Sb120a includes a 400-watt power amplifier that is built into the speaker cabinet. The Xp200A system controller provides a sub-woofer output that is a crossed-over sum of the left and right channels.

The Sx200a's high-frequency horn is driven by the DH2010A one-inch-throat, wide-bandwidth, titanium-diaphragm driver. The DH2010A uses a unique, convex-drive Time Path™ phasing plug structure (U.S. Patent #4,525,604) for smooth and extended high-frequency performance. The voice coil is coupled to the diaphragm with EV's exclusive Resonant Drive™ technology. This increases and smooths the high-frequency response and reduces the amount of internal equalization required for flat frequency response. Driver output extends to 25,000 Hz.

The bass section of the Sx200a is designed using Thiele-Small parameters for efficient performance to below 80 Hz. The woofer is a 12-inch unit featuring beryllium copper lead wires, a low-mass, edge-wound voice coil and high-temperature materials. The part of the magnetic structure adjacent to the coil is insulated using the exclusive EV PROTEF™ process (U.S. Patent #4,547,632). The coil is driven by a 16-lb magnetic structure. The system combines professional-quality components, arranged in a time-coherent vertical array, with an unusually durable Thiele-Small-aligned vented enclosure. The result is clear and articulate, high-quality sound.

FREQUENCY RESPONSE

The combination of a 12-inch woofer, wide-bandwidth high-frequency driver and an equalized crossover results in the wide and smooth overall response shown in Figure 1. This response was measured at 10 feet, using a 4-volt input in an anechoic chamber, and was measured using a swept sine-wave input. No external equalization was used. Figure 1 has been averaged and corrected for 1 watt at 1 meter.

CONSTANT-DIRECTIVITY SPEAKER SYSTEM

The crossover frequency and speaker component geometries have been selected so that the directional characteristics of the woofer and constant-directivity horn match at the crossover frequency to create a special system type—the constant-directivity system. Response within the 65° rated coverage angle is uniform, which means dependable audience coverage without "hot spots" or dead zones at certain frequencies. The 65° dispersion characteristic also helps avoid early reflections from nearby floor or side-wall surfaces which could degrade performance. The controlled directivity of the high- and low-frequency transducers also eliminates response irregularities caused by diffraction off nearby enclosure edges and, in combination with an essentially flat on-axis frequency response, produces a total acoustic power output that is uniform with frequency.

DIRECTIVITY

A unique feature of the Sx200a is the constant-directivity dispersion provided by the 65° x 65° horn. The polar response of the system at selected one-third-octave bandwidths is shown in Figure 4. These polar responses were measured in an anechoic environment at 10 feet using one-third-octave pink-noise inputs. The frequencies selected are fully representative of the polar response of the system. Beamwidth of the system utilizing the complete one-third-octave polar data is shown in Figure 5. R_0 and directivity index (D_i) are plotted in Figure 6.

XP200A ELECTRONIC SYSTEM CONTROLLER

The optional Xp200A electronic system controller complements the characteristics of the Sx200a. Its mono-summed subwoofer outputs provide additional crossover and infrasonic protection. 24-dB-per-octave filters roll off response below 37 Hz and above 100 Hz. The Xp200A also includes a special low-frequency profile circuit that enhances the performance of the Sx200a. The amount of enhancement can be adjusted to suit the user's personal preference.

ELECTRONICS OPERATION AND INSTALLATION

To facilitate operation and installation, Sx200a back-panel detail is shown in Figure 3.

Precautions

Please read the entire data sheet before connecting the Sx200a to your system. For optimum performance, observe the following precautions:

1. Keep the ac power switch off while making connections.
2. Be certain that plugs and jacks are tightly mated. Loose connections cause hum, noise or intermittences that could damage your speakers.
3. Use the proper, high-quality shielded cables in your entire system. Low-capacitance cable is preferred.
4. Turn on the mixer, EQ and effects first. Wait eight to ten seconds, then turn on the Sx200a. This prevents any transient "pop" which could damage a loudspeaker.
5. Always begin with the mixer master faders at minimum. Wait a few seconds to turn up the volume.
6. Use restraint in operating controls. Move them slowly. Rapid movements could damage speakers through accidental amplifier clipping.
7. To prevent fire or electrical shock, do not expose the Sx200a to rain or excess moisture.
8. Do not be concerned when the speaker "pops" when turned on. This is intentional to indicate status and does not signify a problem.

Signal Input

The Sx200a may be driven by any line-level signal source, balanced or unbalanced. **Caution: do not connect the output of a power amplifier to the input.** Although this should not damage the Sx200a, it is very likely to result in distorted sound quality because the output voltage of a power amplifier is typically high enough to severely clip the input of the Sx200a.

The connector accepts a balanced signal from a 3-pin male XLR-type connector.

Driving Multiple Sx200a's

The high, 10,000-ohm input impedance allows several Sx200a systems to be connected in parallel (daisy chained) to the usual single signal source, without undesirable loading effects on the source.

The 3-pin male XLR-type Full-Range Output connector is in parallel with the Input connector and should be used for this purpose. Pins 1 and 3 will be common and pin 2 will be hot.

Amplifier Controls and Indicators

The amplifier has minimal controls, for ease of use in the field.

The System Gain control adjusts the output of the system in order to help balance the output of the Sx200a with the rest of your system. The fully clockwise setting has 0-dB attenuation and fully counterclockwise offers full attenuation.

Ventilation

The metal amplifier plate and heat sink on the rear of the enclosure serves as a thermal radiator to maintain the amplifier operating temperature within design limits. It is normal for this panel to become warm in use, particularly when the system is operated at high levels for a prolonged period of time. During operation, use care to ensure that there is at least one inch of space behind the panel to allow free circulation of air. Worst-case temperature rise is approximately 20 °C (36 °F) from ambient.

ELECTRONIC CROSSOVER

The Sx200a is equipped with a built-in crossover, a fourth-order, 24-dB-per-octave low-pass filter at 125 Hz. The Sx200a may be driven by the high-frequency output of an external active crossover network. A crossover frequency in the range of 100-200 Hz is recommended.

SUSPENDING Sx200a ENCLOSURES

WARNING: Suspending any object is potentially dangerous and should only be attempted by individuals who have a thorough knowledge of the techniques and regulations of rigging objects overhead. Electro-Voice strongly recommends that the Sx200a be suspended taking into account all current national, federal, state and local regulations. It is the responsibility of the installer to ensure the Sx200a is safely installed in accordance with all such regulations. If the Sx200a is suspended, Electro-Voice strongly recommends that the system be inspected at least once a year. If any sign of weakness or damage is detected, remedial action should be taken immediately.

A manual entitled *Suspending System 200™ Loudspeakers* is included with every Sx200a system. It gives a summary of the suspension kits available and an idea of how each kit is used. A brief overview, which illustrates some approaches for single and multiple suspension, is given here for the benefit of the system designer. Please refer to individual suspension kit engineering data sheets for full details and safety information.

The first approach is to suspend an individual Sx200a enclosure. Electro-Voice recommends the use of the Mb200 bracket (see Figure 4), which encompasses the top and bottom of the enclosure and has additional features to make suspending the Sx200a easier and more flexible. The Mb200 has supplementary holes to allow the Sx200a to be attached to a wall or ceiling and aimed at an audience.

The Mb200 Installation Kit also allows the use of OmniMount® Series 100 mounting hardware by providing three-hole-pattern groups compatible with these support systems. When OmniMount® Series 100 mounting hardware is specified, the Mb200 Installation Kit must first be attached to the speaker enclosure.

The second approach is to suspend multiple Sx200a enclosures. If an "array" is required, then multiple Mb200's must be used. Arrays may be constructed vertically by "daisy chaining" two Mb200's from each other. The Mb300 Horizontal Array Kit allows the easy and secure construction of horizontal arrays using Mb200's to support the enclosure.

SYSTEM RESPONSE DUE TO THE ACOUSTICAL ENVIRONMENT

Several factors must be considered when determining the overall response of a speaker system in any listening environment. Physical characteristics of the room itself and placement of the speakers and listener can have considerable affect on SPL capability, perceived and/or measured frequency response and stereo imaging.

The low-frequency response of the Sx200a can be adversely affected by poor placement. The Sx200a was designed for quarter- or half-space use. This requires that the speaker system be positioned as close as possible to floor or wall surfaces (half space) or a floor/wall junction (quarter space). Corner placement, in most cases, will reinforce low frequencies the most. Also, placement in loose cavities or resonant mountings can seriously degrade the overall response.

ARCHITECTS' AND ENGINEERS' SPECIFICATIONS

The loudspeaker shall consist of a 30.5-cm (12-inch) low-frequency transducer in a vented, trapezoidal-shaped enclosure; a high-frequency compression driver with a pure titanium diaphragm coupled to a 65° x 65° constant-directivity horn molded into the front baffle of the enclosure; and a passive crossover-equalizer network with protection for the high-frequency driver. Up to 12 dB additional bass output can be obtained with the Electro-Voice Xp200A speaker-system controller.

The system will have a self-contained high-power amplifier, with a switchable fourth-order, 24-dB-per-octave high-pass network at a frequency of 125 Hz.

The loudspeaker system shall have an operating bandwidth of 65 Hz to 20,000 Hz. The sound pressure level shall be 126 dB at maximum gain, with an input signal of 0 dBu into the power amplifier's balanced input and the amplifier at clipping threshold, measured at 1 meter on the system axis.

The power amplifier section shall be capable of providing 350 watts into a 4-ohm reactive load with 0.5% total harmonic distortion at 100 Hz (typical). The power bandwidth shall extend from 65 Hz to 18,000 Hz. The amplifier shall accept balanced inputs and have a maximum sensitivity of 1.3 volts for full output, and an input impedance of 10 kilohms.

There will be three metric M8 x 1.25-mm attachment points capable of supporting the system in a permanent installation application. The loudspeaker shall have a black, perforated metal grille covering the woofer. Overall dimensions shall be 58.7 cm (23.1 in.) high, 42.9 cm (16.9 in.) wide, 31.2 cm (12.3 in.) deep. The weight shall be 21.3 kg (47.0 lb).

The loudspeaker system shall be the Electro-Voice model Sx200a.

UNIFORM LIMITED WARRANTY

Electro-Voice products are guaranteed against malfunction due to defects in materials or workmanship for a specified period, as noted in the individual product-line statement(s) below, or in the individual product data sheet or owner's manual, beginning with the date of original purchase. If such malfunction occurs during the specified period, the product will be repaired or replaced (at our option) without charge. The product will be returned to the customer prepaid. **Exclusions and Limitations:** The Limited Warranty does not apply to: (a) exterior finish or appearance; (b) certain specific items described in the individual product-line statement(s) below, or in the individual product data sheet or owner's manual; (c) malfunction resulting from use or operation of the product other than as specified in the product data sheet or owner's manual; (d) malfunction resulting from misuse or abuse of the product; or (e) malfunction occurring at any time after repairs have been made to the product by anyone other than Electro-Voice or any of its authorized service representatives. **Obtaining Warranty Service:** To obtain warranty service, a customer must deliver the product, prepaid, to Electro-Voice or any of its authorized service representatives together with proof of purchase of the product in the form of a bill of sale or receipted invoice. A list of authorized service representatives is available from Electro-Voice at 600 Cecil Street, Buchanan, MI 49107 (616/695-6831 or 800/234-6831). **Incidental and Consequential Damages Excluded:** Product repair or replacement and return to the customer are the only remedies provided to the customer. Electro-Voice shall not be liable for any incidental or consequential damages including, without limitation, injury to persons or property or loss of use. Some states do not allow the exclusion or limitation of incidental or consequential damages so the above limitation or exclusion may not apply to you. **Other Rights:** This warranty gives you specific legal rights, and you may also have other rights which vary from state to state.

Electro-Voice Speakers and Speaker Systems are guaranteed against malfunction due to defects in materials or workmanship for a period of five (5) years from the date of original purchase. The Limited Warranty does not apply to burned voice coils or malfunctions such as cone and/or coil damage resulting from improperly designed enclosures. Electro-Voice active electronics associated with the speaker systems are guaranteed for three (3) years from the date of original purchase. Additional details are included in the Uniform Limited Warranty statement.

Service and repair address for this product: Electro-Voice, Inc., 600 Cecil Street, Buchanan, Michigan 49107 (616/695-6831 or 800/234-6831).

Specifications subject to change without notice.



ELECTRO-VOICE a MARK IV company 600 Cecil Street, Buchanan, Michigan 49107

MANUFACTURING PLANTS AT ■ BUCHANAN, MI ■ NEWPORT, TN ■ SEVIERVILLE, TN ■ OKLAHOMA CITY, OK ■ GANANOQUE, ONT.

© Electro-Voice, Inc. 1996 ■ Litho in U.S.A.

Part Number 533277 — 9602