

GLADIATOR



Gladiator Series 15" Two-Way and 18" Subwoofer



Key Features:

- 3-way system design using one amplifier channel allows 2-way full-range + sub to run on one amp channel
- 131 dB Max SPL
- RoadWood™ Enclosures are rugged and lightweight
- Steel pole included
- Steel grilles

Gladiator 1152-Way:

- High output EV-15FR 15" woofer
- 60° x 40° controlled coverage
- DH2010 compression driver for extended HF and reliability
- High sensitivity, 99 dB
- 400 Watts continuous, 1,600 Watts peak power rating

Gladiator 118Sub:

- EVS-185 18" woofer with high power 4-layer voice coil
- Extended low-end response to 32 Hz
- Built-in crossover for use as 3-way system
- 400 Watts continuous, 1,600 peak power rating
- Boosts LF output to 134 dB

The Electro-Voice® Gladiator G115 and G118 are designed to reproduce the latest music. The perfect system for mobile DJ's... powerful, extended LF response coupled with EV's great HF and unmatched vocal clarity due to RMD™ (Ring-Mode Decoupling).



The newly developed EV-Series woofers and crossover networks reliably produce very high SPL's all night. Roadwood enclosures, steel grilles, high impact corners, and comfortable handles complete the package for years of reliable service.

EV's innovative system design allows one amplifier channel to drive both the sub and the full-range speaker. No additional crossovers or amps required for a true 3-way system.

The EV Q66 amplifier, with up to 850W per channel, is the perfect amp for a stereo 3-way rig with one G118 and one G115 per side.

EV GLADIATOR



G115 / G118³

Technical Specifications

Freq. Response (-3 dB) ² :	46 Hz - 20 kHz/42 Hz - 160 Hz
Freq. Range (-10 dB) ² :	35 Hz - 20 kHz/32 Hz - 600 Hz
Power Handling, Continuous ¹ :	400W
Power Handling, Program ¹ :	800W
Power Handling, Short Term ¹ :	1,600W
Dispersion:	60° x 40°/Omnidirectional
Sensitivity (SPL 1W/1m):	99 dB
Impedance (Nominal, Min.):	8 ohms/8 ohms, 6.5 ohms
Max Calculated SPL:	131 dB
Enclosure:	Roadwood™ Covered in Heavy Duty Black Carpet
Connectors:	Speakon NL4
Grille:	Powder-Coated Steel
G115 Dimensions (H x W x D):	29.9" x 17.3" x 22.0" (760mm x 438mm x 559mm)
G118 Dimensions (H x W x D):	29.9" x 20.0" x 23.3" (760mm x 508mm x 591mm)
Net Weight:	75.0 lbs. (34.1 kg)/80.0 lbs. (36.3 kg)
Shipping Weight:	80.0 lbs. (36.3 kg)/85.0 lbs. (38.6 kg)

¹ EIA-RS426A

² Frequency response 1/2 space

³ All specifications equal for both models, except where noted or split.

Frequency Response (Two Way):

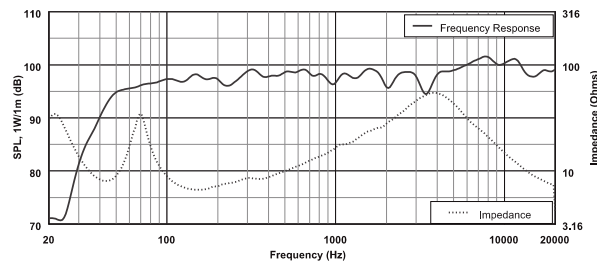

Frequency Response (Subwoofer):

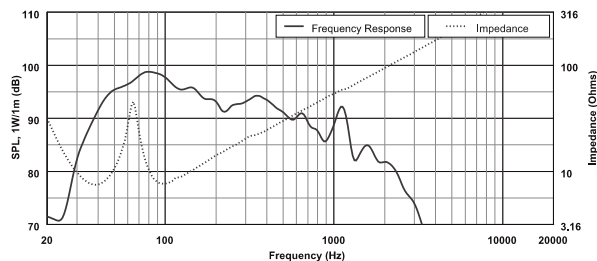

Frequency Response (Combined):

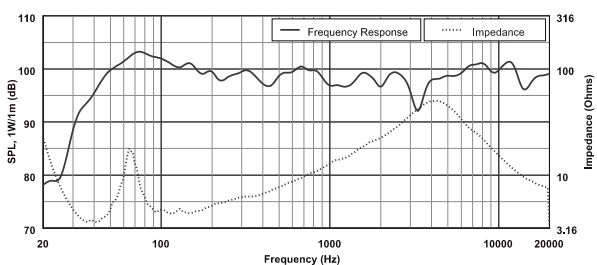

Block Diagram (Combined):

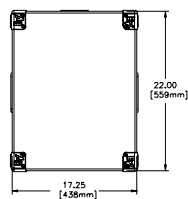
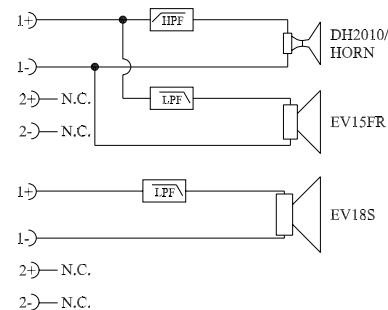

Dimension Drawing (Two-Way):

Gladiator Part Number
G115 Gladiator —
301365-001

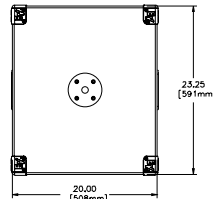
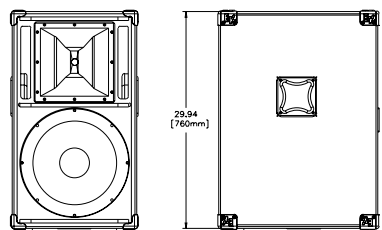

Dimension Drawing (Subwoofer):

Gladiator Part Number
G118 Gladiator Sub —
301366-001

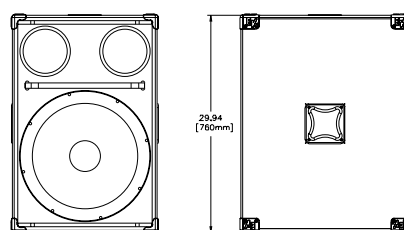

12000 Portland Avenue South, Burnsville, MN 55337
Phone: 952-884-4051, Fax: 952-884-0043

www.electrovoice.com

© Telex Communications, Inc. 01/03
PART NO. PA 20622

U.S.A. and Canada only. For customer orders, contact Customer Service at:
800-392-3497 Fax: 800-955-6831

Europe, Africa, and Middle East only. For customer orders, contact Customer Service at:
+ 49 9421-706 0 Fax: + 49 9421-706 265

Other International locations. For customer orders, contact Customer Service at:
+ 1 952 884-4051 Fax: + 1 952 736-4212

For warranty repair service information, contact the Service Repair department at: 800-685-2606

For technical assistance, contact Technical Support at: 866-78AUDIO

Specification subject to change without notice.