

FRX+660

15-Inch Two-Way
Horn-Loaded 60° x 60°
Coaxial Speaker System



Key Features:

- Pattern Control to 500 Hz
- 60° x 60° coverage
- Built-in L-track rigging
- Available in black, white and unfinished
- Passive or bi-amp operation
- High sensitivity, 104 dB
- Ring-Mode Decoupling / RMD™
- Full Coaxial Design



General Description:

FRX+ series is designed for applications in highly reverberant spaces where excellent directivity control down to 500 Hz is critical. In a trapezoidal enclosure no taller than a typical compact system and only a bit wider, they maintain control of coverage angles down to 500 Hz. A 15" LF transducer is coaxially horn loaded with a mouth nearly the size of the enclosure to provide excellent LF pattern control. These professional fixed install speakers deliver a broad range of performance options including multiple rotatable horn patterns, matching sub-woofer, easily switchable passive or bi-amp operation, and EV's world renowned transducer technology for response that is smooth and linear. The FRX+ is an economical and flexible solution for the most demanding installations.

Same size full-range and sub-woofer systems allow the installer to construct arrays covering the most demanding acoustical environments while maintaining an aesthetic and uniform installation. The structural integrity of the FRX+ cabinets allows for vertical arrays up to 2 boxes in depth. All FRX+ systems are available in weather resistant black or white Futura, and unfinished. A severe environment weatherization option is also available. Performance may be further enhanced by bi-amping with the Electro-Voice Dx-38 Digital Sound System Processor.

Technical Specifications:

Freq. Response ¹ (-3 dB):	60Hz-15kHz
Freq. Range ¹ (-10 dB):	52Hz-16kHz
Max Calculated SPL:	133 dB
Horizontal Coverage:	60°
Vertical Coverage:	60°
LF Power Handling:	400W Continuous, 1600W Peak
HF Power Handling:	60W Continuous, 240W Peak
LF Sensitivity (Bi-Amp):	105 dB, 1W/1m
HF Sensitivity (Bi-Amp):	109 dB, 1W/1m
LF Transducer:	DL15X 15" (381mm) Driver
HF Transducer:	DH2t 2" (51mm) Diaphragm Comp. Driver
Passive Crossover Frequency:	1350 Hz
Connectors:	Two barrier strips
Enclosure Material:	13-ply Birch plywood
Grille:	16 GA steel
Environmental Spec:	IEC 529 IP24 MIL STD 810
Dim (H x W x D):	31.0" x 28.3" x 26.0" (787 x 719 x 660 mm)
Net Weight (each):	152 lbs (69.0 kg)
Shipping Weight:	157 lbs (71.2 kg)

¹ Full Space measurement. Half Space use will improve LF response.

FRX+660 Full Range Loudspeaker

Frequency Response (Full Space):

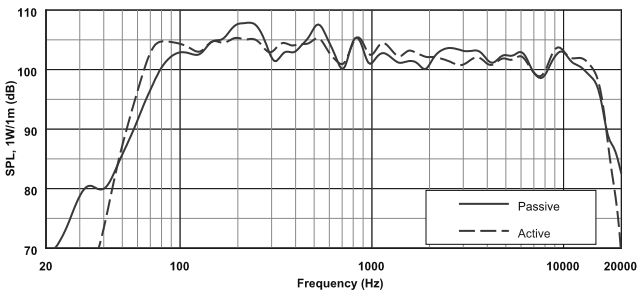

Impedance:

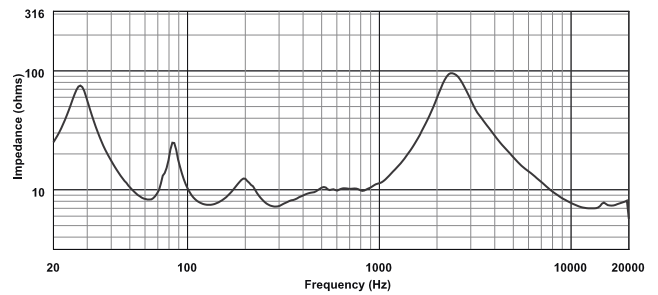

Beamwidth:

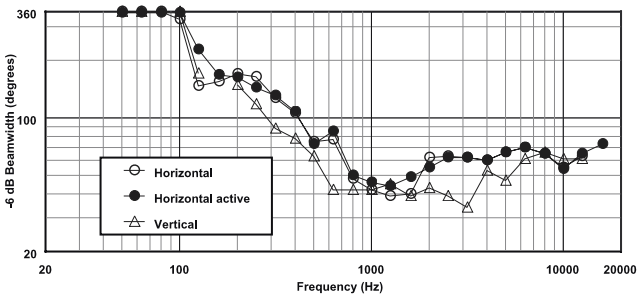

Horizontal Off Axis Frequency Response:

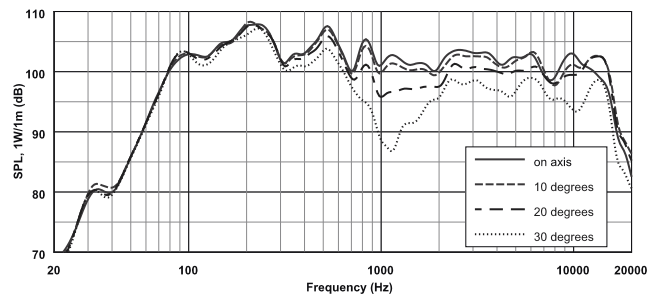

Directivity:

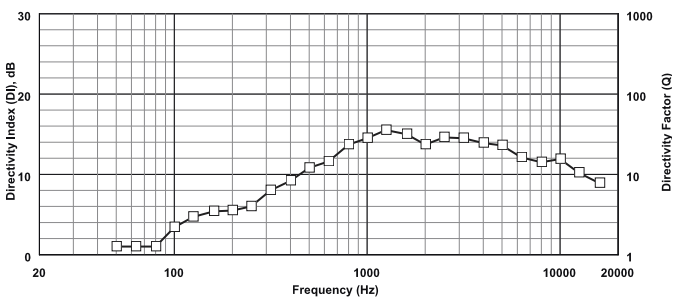

Vertical Off Axis Frequency Response (up/down):

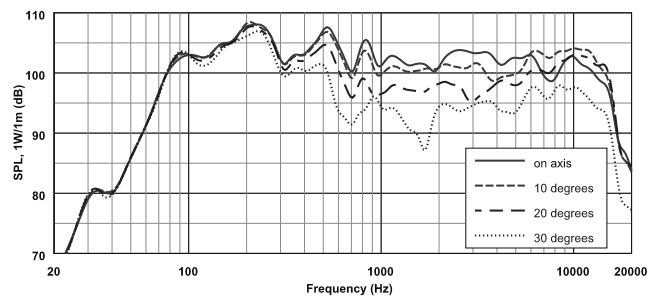

Block Diagram:

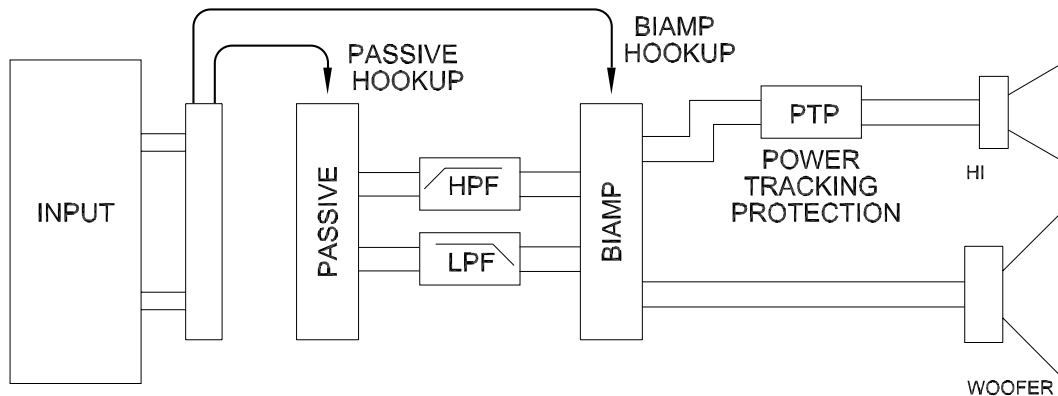

Horizontal 1/3 Octave Polars:

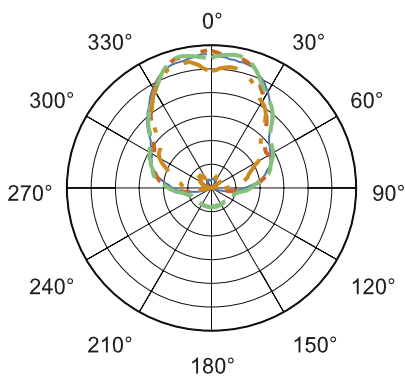
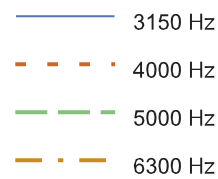
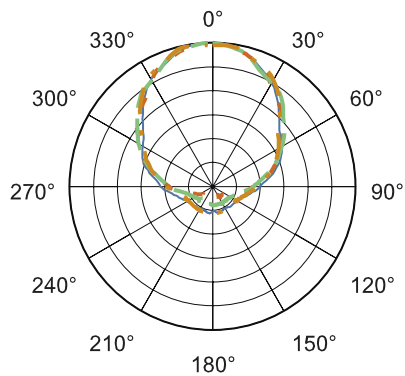
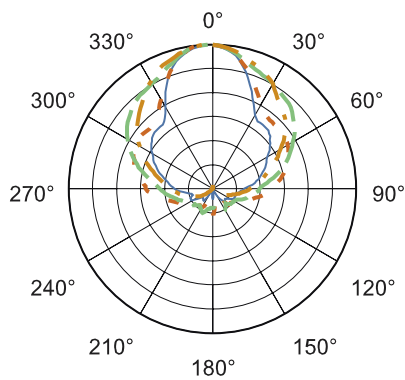
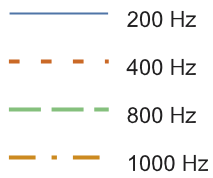
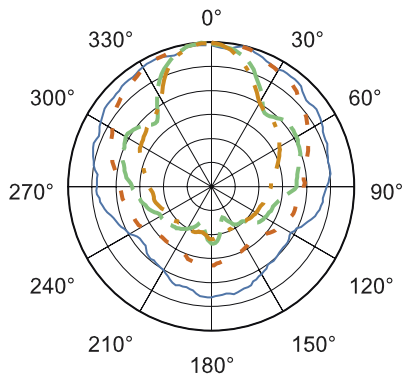

Graph scales are 6 dB per division

Vertical 1/3 Octave Polars:

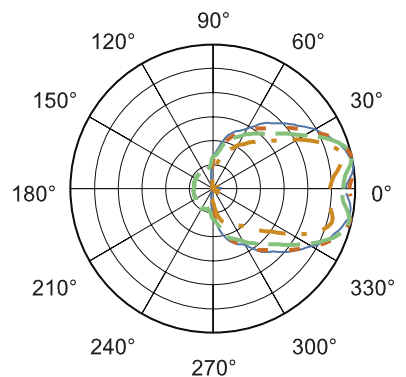
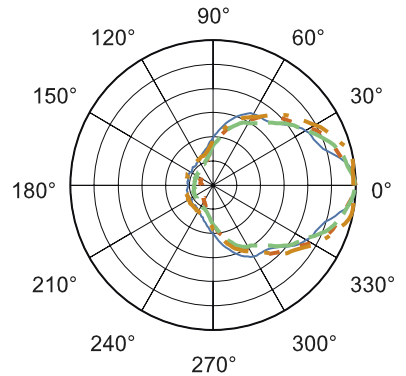
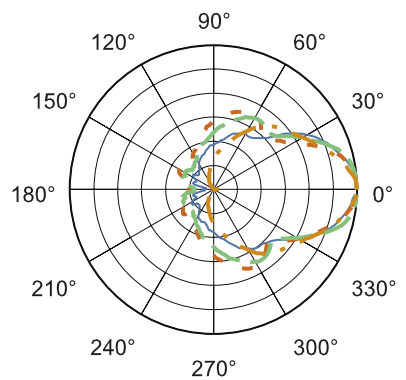
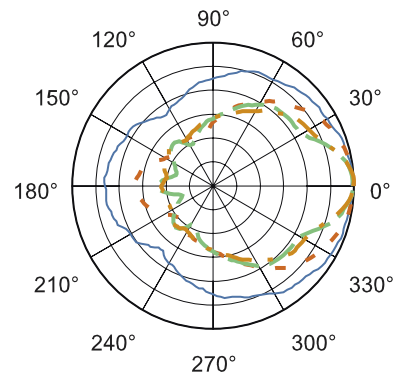

Dimension Drawings:

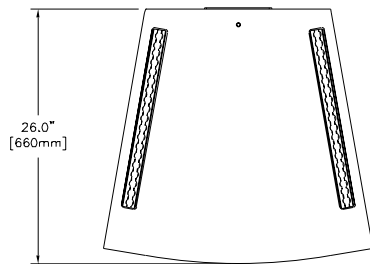

Top View

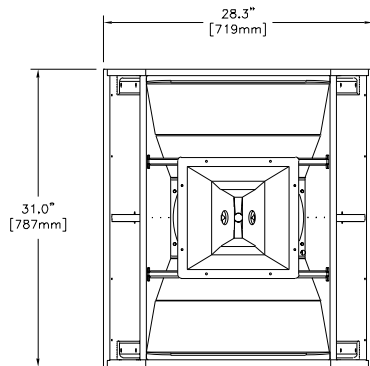

Front View

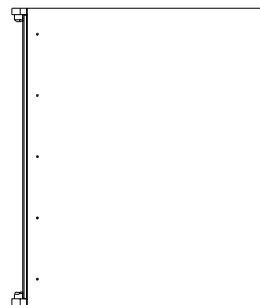

Side View

Architectural & Engineering Specs:

The loudspeaker system shall be a coaxial, two-way full range design consisting of a 15-inch woofer, a high-frequency compression driver on a molded constant-directivity horn and dividing network providing an acoustic crossover frequency of 1,350 Hz. The system shall be configurable in a biamp mode by moving a single connector in the crossover network. The loudspeaker shall meet the following performance criteria; power-handling, 400 watts, based upon ANSI/EIA RS-426-A 1980 standard for full-range loudspeaker systems; frequency response, smooth and usable at high SPL levels from 60 Hz to 15 kHz; pressure sensitivity, 104 dB SPL (passive mode) or 105 dB (LF)/109 dB (HF) in biamp mode for 1W at 1m; impedance, 8 ohms nominal, 5 ohms minimum. The system shall have a distribution pattern of 60° nominal horizontally from 2 kHz to 15 kHz and 60° nominal vertically from 2 kHz to 15 kHz. The enclosure shall be constructed from 13-ply birch plywood and braced appropriately, and the grille shall be constructed from 16GA powder-coated steel backed by acoustically transparent fabric. The dimensions shall be 78.7 cm (31.0 in.) high by 71.9 cm (28.3 in.) wide by 66.0 cm (26.0 in.) deep. Net weight shall be 68.95 kg (152 lb).

The two-way loudspeaker shall be the Electro-Voice FRX+660.

FRX+660 Part Numbers

- 301237-000 - Unfinished
- 301237-001 - Black Futura
- 301237-002 - White Futura



12000 Portland Avenue South, Burnsville, MN 55337

Phone: 952/884-4051, Fax: 952/884-0043

www.electrovoice.com

© Telex Communications, Inc. 4/2002

Part Number 38110-123 Rev. B

U.S.A. and Canada only. For customer orders, contact Customer Service at:

800/392-3497 Fax: 800/955-6831

Europe, Africa, and Middle East only. For customer orders, contact Customer Service at:

+ 49 9421-706 0 Fax: + 49 9421-706 265

Other International locations. For customer orders, contact Customer Service at:

+ 1 952 884-4051 Fax: + 1 952 887-9212

For warranty repair or service information, contact the Service Repair department at:

800/685-2606

For technical assistance, contact Technical Support at: **866/78AUDIO**

Specifications subject to change without notice.