

Eliminator® Monitor

Floor Monitor

- Exclusive Ring Mode Decoupling (RMD™)
- Integral stand adaptor
- PRO™ circuit provides HF driver protection
- Constant-directivity 80° x 55° horn
- Usable monitor angles of 50° and 65°
- 350-watt long-term rms power capacity
- Dual 1/4-inch phone jack or dual Neutrik Speakon® inputs¹

¹ See Connections section

Description

The Electro-Voice Eliminator® Monitor is a 350-watt 2-way floor monitor that incorporates Electro-Voice's exclusive ring mode decoupling (RMD™) technology. The Eliminator monitor features a constant directivity 80° x 55° horn in a vertical orientation that provides usable monitor angles of 50° and 65°. The combined professional quality Electro-Voice manufactured components arrange in a horizontal array with a very durable/road worthy light weight enclosure. The result is a very high performance system with excellent vocal reproduction and extended bass response. The Eliminator Monitor incorporates Electro-Voice's exclusive ring mode decoupling technology. This technology deals with the common resonance or "ringing modes" found in all loudspeaker systems. It deals with mechanical modes utilizing mechanical solutions, and deals with acoustical resonant or ringing modes utilizing acoustical solutions. The result is substantially cleaner vocal reproduction and a response that is more uniform regardless of input level conditions. The system uses the newly developed

DL15BFH low frequency driver to provide both extended low frequency response and cleaner fundamental vocal reproduction. It also utilizes the DH2010A high frequency pure Titanium driver coupled to a constant directivity 80° x 55° horn to produce extended high frequency response and low distortion upper vocal reproduction.

The Eliminator Monitor features a self-resetting high frequency protection circuit, EV's PRO™ circuit. This is included with the high quality passive network to prevent accidental high frequency overload and improve system reliability. The bass section of the Eliminator Monitor is designed using Thiele Small optimized parameters for a solid performance to 77 Hz. In addition to including RMD techniques, the 15" (381 mm) DL15BFH woofer is specially designed to provide extended 350-watt continuous (1200-watt peak) power handling. These power handling ratings are achieved using a 6 dB crest factor which provides peak levels 4 times that above the continuous rating of 350-watts.

The Eliminator Monitor also features a stand mount adapter on the woofer side for vertical orientation (standard

1 3/8 diameter.)

Speaker Protection

The Eliminator Monitor, like all other vented systems, experiences rapidly increasing cone excursion below the box-tuning frequency, while the acoustic output decreases rapidly. Therefore, to protect the Eliminator Monitor and maximize the power output of the system, it is necessary to insert an active 45- to 80-Hz high-pass filter into the circuit. The filter should have a slope of at least 12 dB per octave. Such subpassband filters are found in many crossovers and equalizers manufactured by Electro-Voice, as well as other commercially available equipment.

Enclosure Construction

The Eliminator Monitor enclosure is constructed of Road-Wood™, a structural material that combines the strength of high-quality plywood with the density and acoustic damping of particle board without brittleness. Road-Wood™ uses the same principle of crossbanding veneers, as in plywood, in order to achieve its very high rigidity. A tough liquid-phenolic resin is blended with long, narrow strands of

hardwood. Alternate layers are perpendicularly bonded under intense heat and pressure to form panels of superior uniformity. Unlike many grades of plywood, Road-Wood™ is dimensionally stable, water resistant and free from voids.

A combination of dado-cut joints and tough adhesives ensure a sonically dead enclosure free from panel resonances.

The densely woven, industrial-grade, abuse-resistant carpeting provides a finish that is both attractive and highly durable. Heavy-duty corner protectors, firmly secured rubber feet, recessed handles and a protective metal grille complete the picture and ensure that the Eliminator Monitor speaker system is ideally suited to a long and reliable life on the road.

Frequency Response

The combination of a 15-inch woofer, wide-bandwidth high-frequency driver and an equalized crossover results in the wide and smooth overall response shown in Figure 1. This response was measured at 3.05 meters (10 feet), using a 4-volt swept sine-wave input in an anechoic chamber. No external equalization was used. Figure 1 has been averaged and corrected for 1 watt at 1 meter.

Connections

The Eliminator monitor is equipped with two parallel 1/4-inch phone jacks. (The Eliminator Monitor E version has two parallel Neutrik Speakon® NL4MP connectors.) Another system can be connected in parallel by using the other connector. Care must be taken not to abuse the amplifier by connecting impedances which are too low.

Constant-Directivity Speaker System

The crossover frequency and speaker component geometries have been selected so that the directional characteristics of the woofer and constant-directivity horn match at the crossover frequency to create a special system type — the constant-directivity system. At higher frequencies the vertical coverage pattern remains constant and the horizontal pattern smoothly transitions to a 55° angle above 5,000 Hz. Response within the 80° x 55° rated coverage angle is uniform, which means

dependable coverage without “hot spots” or dead zones at certain frequencies. The 80° x 55° dispersion characteristic also helps avoid early reflections from nearby surfaces which could degrade performance. The controlled directivity of the high- and low-frequency transducers also eliminates response irregularities caused by diffraction off nearby enclosure edges and, in combination with an essentially flat on-axis frequency response, produces a total acoustic power output that is uniform with frequency.

Directivity

A unique feature of the Eliminator Monitor is the constant-directivity dispersion provided by the 80° x 55° horn. The polar response of the system at selected one-third-octave bandwidths is shown in Figure 5. These polar responses were measured in an anechoic environment at 6.1 meters (20 feet) using one-third-octave pink-noise inputs. The frequencies selected are fully representative of the polar response of the system. Beamwidth of the system utilizing the complete one-third-octave polar data is shown in Figure 6. Directivity factor, R_p and directivity index, D_p , are plotted in Figure 7.

Power-Handling Capacity

Electro-Voice components and systems are manufactured to exacting standards, ensuring they will hold up, not only through the most rigorous of power tests, but also through continued use in arduous, real-life conditions. The EIA Loudspeaker Power Rating Full Range (ANSI/EIA RS-426-A 1980) uses a noise spectrum which mimics typical music and tests the thermal and mechanical capabilities of the components. Electro-Voice will support relevant additional standards as and when they become available. Extreme, in-house power tests, which push the performance boundaries of the woofers, are also performed and passed to ensure years of trouble-free service.

Specifically, the Eliminator passes ANSI/EIA RS-426-A 1980 with the following values:

$$R_{SR} = 5.175 \text{ ohms } (1.15 \times R_E)$$

$$P_{E(MAX)} = 350 \text{ watts}$$

$$\text{Test voltage} = 42.55 \text{ volts rms,}$$

$$85.10 \text{ volts peak (+6dB)}$$

The “peak” power-handling capacity of a woofer is determined by the peak test voltage amount. For the Eliminator Monitor, a 85.10-volt-peak-test voltage translates into 1,400-watts short-term peak power-handling capacity. This is the equivalent of four times the “average” power-handling capacity, and is a peak that can be sustained for only a few milliseconds. However, this sort of short duration peak is very typical in speech and music. Provided the amplifier can reproduce the signal accurately, without clipping, the woofer will also perform accurately and reliably, even at these levels.

Amplifier Recommendations.

The power-handling rating of the Eliminator® Monitor is 350-watts continuous. The specific tests used employ a crest factor (ratio of peak energy to continuous energy) of at least 6 dB. During extended testing, the Eliminator® Monitor is routinely subjected to peak levels far in excess of its continuous rating of 350 watts. Many amplifier designs are capable of producing peak power levels in excess of their ratings as well, so exact “pairing” of loudspeaker rating and amplifier ratings is not necessary. Amplifier continuous ratings of 250 watts to 400 watts are suggested. Larger amplifier ratings are recommended for maximum dynamic range, but it should be recommended that amplifier continuous levels (as opposed to peak levels) be within the range quoted for the Eliminator® Monitor long-term average power-handling rating.

Service

In the unlikely event the Eliminator Monitor requires service, the woofer and driver can both be replaced or serviced from the front. A service data sheet is available from Electro-Voice.

Architects’ and Engineers’ Specifications

The loudspeaker shall be a compact vented-box type. The low frequencies

Eliminator® Monitor

shall be reproduced with one 350-watt (ANSI/EIA RS-426-A 1980) DL15BFH 381-mm (15-in.) vented woofer, and a DH2010A high-frequency compression driver mounted on a 80° x 55° constant-directivity horn. The system will reproduce the frequencies from 77 to 20,000 Hz. The system shall be capable of producing average sound levels in excess of 124 dB in the long term, and short-term peaks of 130 dB.

The enclosure shall be constructed of black, carpeted, Road-Wood™. The dimensions shall be 645 mm (25.39 in.) wide, 406 mm (15.98 in.) high, and 471 mm (18.53 in.) deep. The system shall weigh 19.5 kg (43 lb). Two parallel 1/4-inch phone jack connections shall be provided. (Two Neutrik Speakon® connections shall be provided on the “E” version).

The loudspeaker system shall be the Electro-Voice Eliminator® Monitor (Monitor (E)).

Uniform Limited Warranty

Electro-Voice products are guaranteed against malfunction due to defects in materials or workmanship for a specified period, as noted in the individual product-line statement(s) below, or in the individual product data sheet or owner’s manual, beginning with the date of original purchase. If such malfunction occurs during the specified period, the product will be

repaired or replaced (at our option) without charge. The product will be returned to the customer prepaid. **Exclusions and Limitations:** The Limited Warranty does not apply to: (a) exterior finish or appearance; (b) certain specific items described in the individual product-line statement(s) below, or in the individual product data sheet or owner’s manual; (c) malfunction resulting from use or operation of the product other than as specified in the product data sheet or owner’s manual; (d) malfunction resulting from misuse or abuse of the product; or (e) malfunction occurring at any time after repairs have been made to the product by anyone other than Electro-Voice Service or any of its authorized service representatives. **Obtaining Warranty Service:** To obtain warranty service, a customer must deliver the product, prepaid, to Electro-Voice Service or any of its authorized service representatives together with proof of purchase of the product in the form of a bill of sale or receipted invoice. A list of authorized service representatives is available from Electro-Voice Service at 600 Cecil Street, Buchanan, MI 49107 (800/234-6831 or FAX 616/695-4743). **Incidental and Consequential Damages Excluded:** Product repair or replacement and return to the customer are the only remedies provided to the customer. Electro-Voice shall not be liable for any incidental or consequential damages including, without limi-

tation, injury to persons or property or loss of use. Some states do not allow the exclusion or limitation of incidental or consequential damages so the above limitation or exclusion may not apply to you. **Other Rights:** This warranty gives you specific legal rights, and you may also have other rights which vary from state to state.

Electro-Voice Speakers and Speaker Systems are guaranteed against malfunction due to defects in materials or workmanship for a period of five (5) years from the date of original purchase. The Limited Warranty does not apply to burned voice coils or malfunctions such as cone and/or coil damage resulting from improperly designed enclosures. Electro-Voice active electronics associated with the speaker systems are guaranteed for three (3) years from the date of original purchase. Additional details are included in the Uniform Limited Warranty statement.

For warranty repair, service information, or a listing of the repair facilities nearest you, contact the service repair department at: 616/695-6831 or 800/685-2606.

For technical assistance, contact Technical Support at 800/234-6831 or 616/695-6831, M-F, 8:00 a.m. to 5:00 p.m. Eastern Standard time.

Specifications subject to change without notice.

Figure 1—Axial Frequency Response, (anechoic environment, 4 volts/3.05 meters (10 feet), normalized to 1 watt/1 meter)

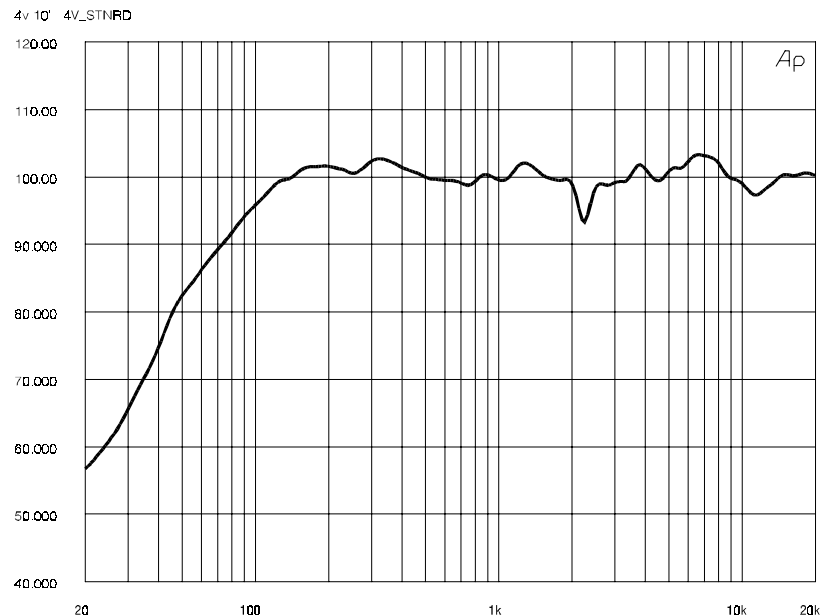

Figure 2—Harmonic Distortion Response 10% Rated Power Input (25 watts), (anechoic environment, 3.05 meters (10 feet) on axis)

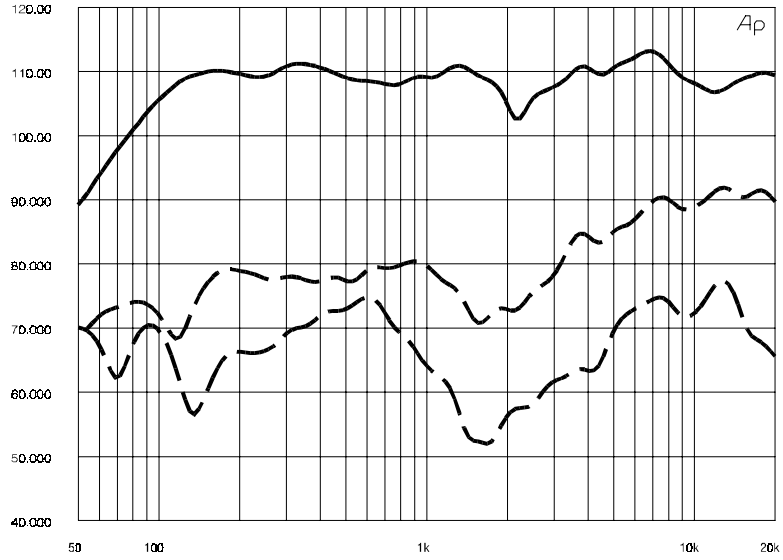

Figure 3—Impedance Curve

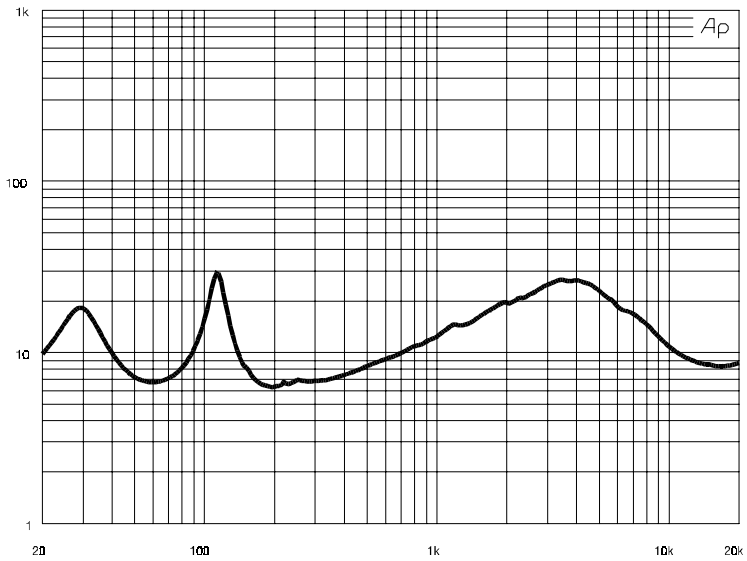
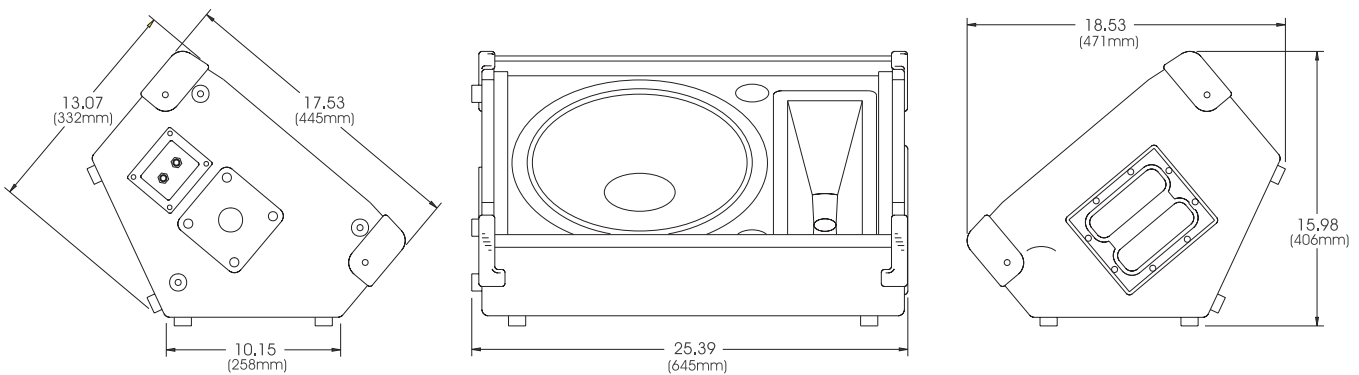

Figure 4—Dimension Line Drawing



Eliminator[®] Monitor

Figure 5—One-Third-Octave Polar Responses (anechoic environment, 4 volts/6.10 meters (20 feet))

— HORIZONTAL
 - - - VERTICAL

Scale - 5 dB per division

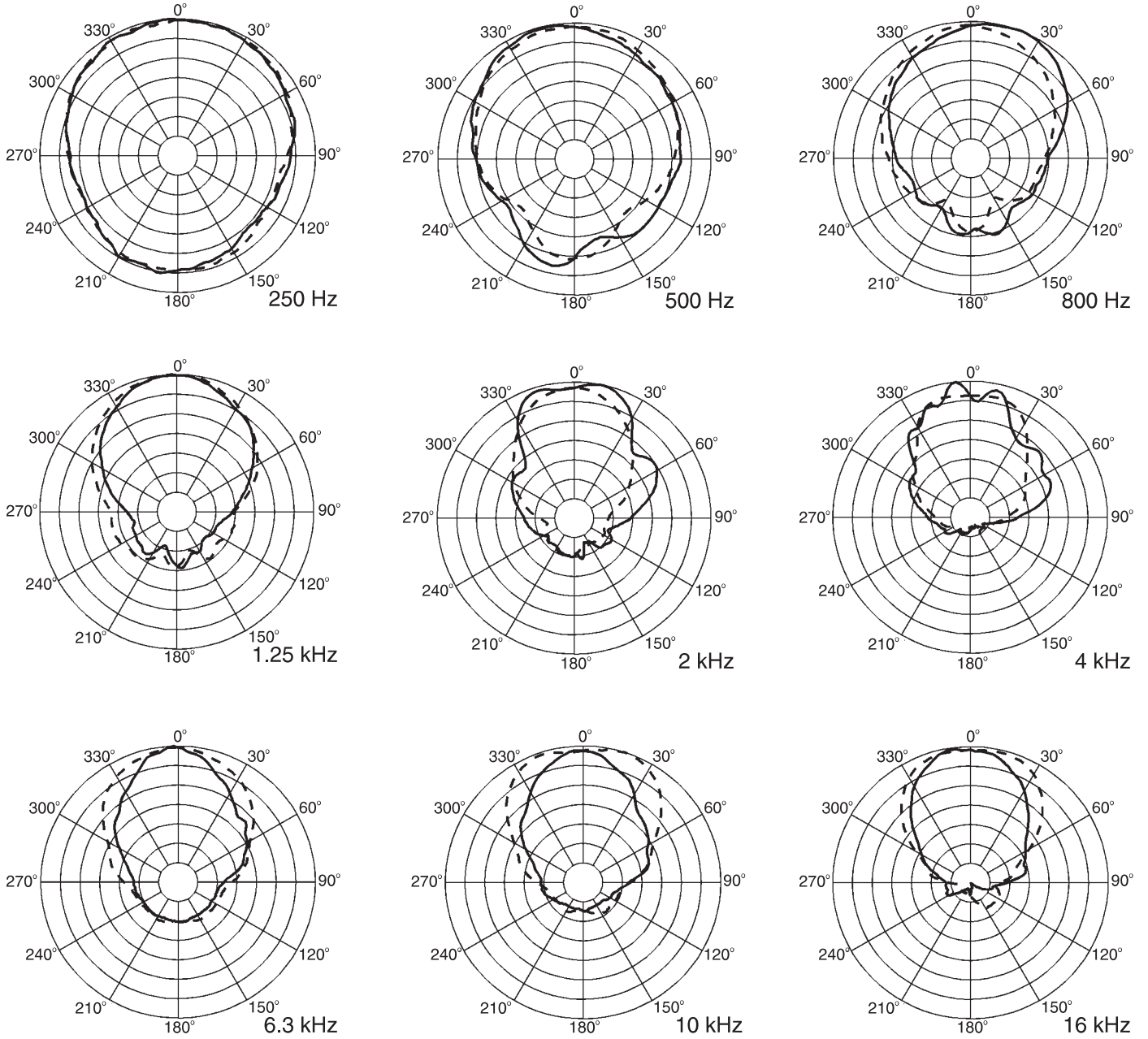

Eliminator[®] Monitor

Figure 6—Beamwidth vs. Frequency (anechoic environment)

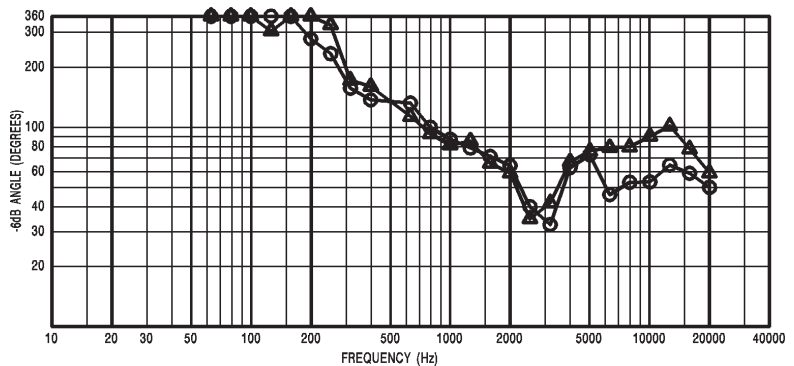

Eliminator[®] Monitor

Figure 7—Directivity vs. Frequency
(anechoic environment)

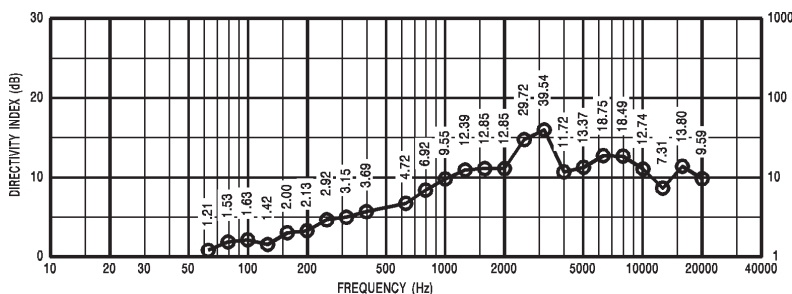

Eliminator[®] Monitor

Specifications

Typical Axial Frequency Response, Swept Sine Wave, 4 volts at 3.05 meters (10 feet), (anechoic environment, normalized for 1 watt at 1 meter; see Figure 1):

77-20,000 Hz (half space)

Low-Frequency 3-dB-Down Point:

77 Hz (half space)

Usable Low-Frequency Limit (10-dB-down point):

65 Hz (half space)

Efficiency:

3.3%

Long-Term Average Power-Handling Capacity per EIA Standard RS-426-A 1980 (see Power-Handling Capacity section):

350 watts

Maximum Woofer Acoustic Output:

8.3 watts

Sensitivity (SPL at 1 watt, 1 meter input, anechoic environment, swept sine wave):

99 dB

Dispersion Angle Included by 6-dB-Down Points on Polar Responses, Indicated One-Third-Octave Bands of Pink Noise (see Figure 6),

4,000-20,000 Hz, Horizontal:

55° (+18°, -9°)

4,000-20,000 Hz, Vertical:

80° (+21°, -21°)

Directivity Index D_i ,

($D_i = 10 \log_{10} R(Q)$) 800- to 16,000-Hz Median (see Figure 7):

12.0 dB (+4.0 dB, -3.6 dB)

Distortion, 0.1 Full Power Input, (see Figure 2)

Second Harmonic,

100 Hz:

-27 dB, 4.7%

1,000 Hz:

-35 dB, 1.8%

10,000 Hz:

-19 dB, 11.4%

Third Harmonic,

100 Hz:

-36 dB, 1.6%

1,000 Hz:

-44 dB, 0.6%

10,000 Hz:

-34 dB, 2.1%

Transducer Complement,

Low Frequency:

DL15BFH

High Frequency:

DH2010A driver

HP85M constant-directivity horn

Box-Tuning Frequency:

60 Hz

Crossover Frequency:

2,000 Hz

Crossover Slope:

12 dB per octave

Impedance, (see Figure 3)

Nominal:

8 ohms

Minimum:

5.1 ohms

Input Connections:

Two parallel 1/4-inch phone jacks
(Two parallel Neutrik Speakon[®]
NL4MP connectors on Eliminator
Monitor (E))

Enclosure Materials and Colors:

Black carpet-covered Road-Wood[™]
Black perforated metal grille

Dimensions (see Figure 4)

Width:

640 mm (25.39 in.)

Height:

406 mm (15.98 in.)

Depth:

471 mm (18.53 in.)

Net Weight:

19.5 kg (43 lb)

Shipping Weight:

22.7 kg (50 lb)

Electro-Voice[®]

600 Cecil Street, Buchanan, MI 49107

616/695-6831, 616/695-1304 Fax