



Electro-Voice®
a MARK IV company



FIGURE 1
Axial Frequency Response, 1 Watt/1 Meter
Curved on HP64 Horn

DH2A/4MT High-Frequency Acoustic Summation System

SPECIFICATIONS:

The following specifications are in accordance with or exceed the AES Recommended Practice for Specification of Loudspeaker Components Used in Professional Audio and Sound Reinforcement (AES2-1984; ANSI S4.26-1984). See AES Recommended Practice section.

Power Frequency Response:

500-20,000 Hz (essentially flat
500-3,000 Hz with 6-dB-per-octave
rolloff to 20,000 Hz, rapid rolloff
beyond)

Nominal Impedance, on HP Series Horns above 500 Hz:

8 ohms (single driver)

Minimum Impedance:

6 ohms at 5,000 Hz (single driver)

DC Resistance:

4.5 ohms (single driver)

Long-Term Average Power Capacity on HP Horns, Indicated Bands of Pink Noise, 8-Ohm Impedance Assumed,

24 Hours, 10-dB Crest Factor:

120 watts (800-20,000 Hz)

2 Hours, 6-dB Crest Factor:

160 watts (800-8,000 Hz)

240 watts (1,500-15,000 Hz)

Nominal Efficiency, 800-3,000-Hz Pink Noise, 8-Ohm Impedance Assumed:

25%

Maximum Long-Term Acoustic Power Output (24 hours):

30 watts

Recommended Minimum Crossover

Frequency:

800 Hz

Sound Pressure Level at 1 Meter, 1 Watt Input Averaged from 500 Hz to 5,000 Hz:¹

115 dB, HP4020 horn

113 dB, HP6040 horn

111 dB, HP9040 horn

112 dB, HP64 horn

110 dB, HP94 horn

114 dB, HP420 horn

112 dB, HP640 horn

110 dB, HP940 horn

108 dB, HP1240 horn

Throat Diameter:

4.92 cm (1.94 in.)

Weight:

21.6 kg (47.5 lb)

Shipping Weight:

22.9 kg (50.5 lb)

DH2Amt

Voice Coil Diameter:

5.08 cm (2.00 in.)

Voice-Coil Construction:

Pure aluminum wire wound on high-temperature polyimide coil form

Diaphragm Construction:

Integral all-titanium construction consisting of spherical diaphragm dome and geometrically optimized suspension; high-temperature, long-duration-cure adhesive bonds the coil form to the diaphragm.

Electrical Connection:

Push terminals

Polarity:

A positive voltage applied to the positive (red) terminal produces a positive acoustic pressure in the throat.

MTA-42

Physical Connections:

Entrances (4):

1 3/8" -18 mounting threads

Exit:

Bolt-on, standard 2" -diameter throat,
5" -diameter mounting flange and four
clearance holes for 1/4" bolts on a 4" -diameter

bolt circle. Bolt heads are captured by molded-in detail.

Mounting Hardware Included:

- 4 driver-entrance gaskets
- 4 1/4" -20 mounting bolts
- 4 1/4" washers
- 4 1/4" -20 nuts

DESCRIPTION

The Electro-Voice DH2A/4MT is a high-performance, high-frequency acoustic summation system capable of unprecedentedly high acoustic power output over a wide frequency range.

The DH2A/4MT combines four DH2Amt frequency drivers on a MTA-42 Manifold Technology® adapter.

High sound-pressure level applications often require the use of multiple horn-and-driver combinations. This results in physically cumbersome arrays and, when two or more horns cover the same area, it results in destructive interference, often referred to as comb-filtering. This results in a familiar "swishing" sound when moving through or "walking" a system with music being played. By combining the outputs of four drivers into a single horn, the DH2A/4MT allows extremely high sound pressure levels to be generated by compact, cost-effective arrays and without destructive interference.

The combination of extremely close driver packing, complementary positioning and a specially designed reflective insert results in phase-coherent summation.

¹ Measured on axis in the far field with 1 watt input of band-limited pink noise from 500-5,000 Hz and calculated to 1 meter equivalent by inverse square law.

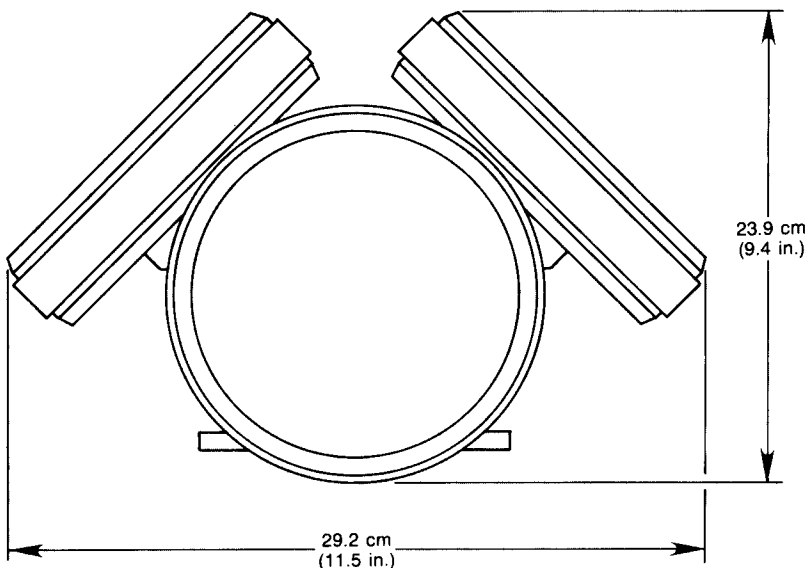

FIGURE 2
Dimensions

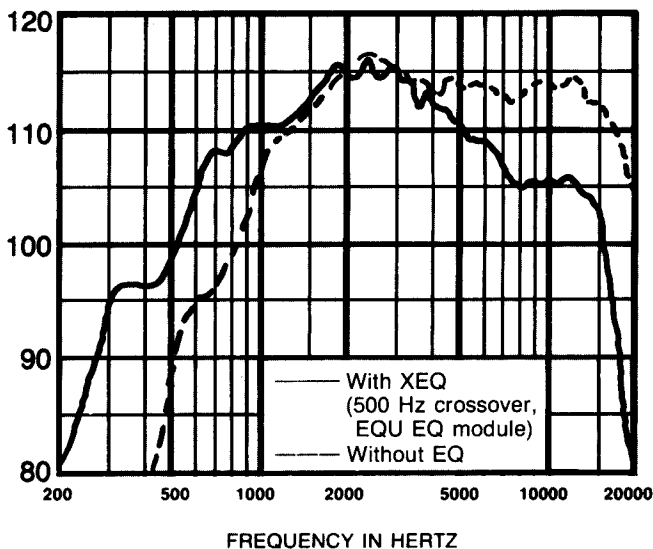

FIGURE 3
Axial Frequency Response with and without Equalization, 1 Watt/1 Meter, HP64 Horn

MECHANICAL CONNECTION

Bolts, washers, and nuts are provided for connecting the DH2A/4MT to a standard 2-inch-throat horn. The flange of the DH2A/4MT is molded to capture the bolt head, so installation is possible with a single wrench. Four driver-entrance gaskets are also provided. These should be inserted into the driver entrances before installing the drivers.

ELECTRICAL CONNECTION

With four 8-ohm drivers and one amplifier 2-ohm, 8-ohm and 32-ohm systems are possible. The recommended electrical connection for these three systems are shown in Fig. 8.

With more amplifiers, other wiring arrangements are possible. When using multiple amplifiers, care should be taken to ensure equal drive voltage across each driver.

RECOMMENDED HORNS

The following Electro-Voice horns are recommended for use with the HP64, HP94, HP420, HP640, HP940, HP1240, HP4020, HP6040, and HP9040.

CROSSOVER AND EQUALIZATION

As with all horn/driver combinations that combine high overall efficiency with constant directivity, the DH2A/4mt and HP series horns provide "raw" or unequalized frequency response that rolls off above 3,000 Hz or so at about 6 dB per octave. Figure 3 shows the DH2A/4mt on an HP64 horn, with and without equalization. The equalization has been provided by an Electro-Voice XEQ-2 crossover/equalizer equipped with the EQO equalization module. While the equalization of a constant-directivity horn/driver combination can be achieved with a conventional one-third-octave equalizer, the use of the XEQ-2 crossover/equalizer with the appropriate accessory EQ module is recommended. This way, the broad-band equalization required by the horn/driver combination is supplied by the crossover/equalizer network, and the one-third-octave equalizer can be devoted to correcting the more subtle room- and array-related response anomalies. The following EQ modules are available for the DH2A/4mt:

Module	Horn(s)
EQR	HP940
EQS	HP1240
EQT	HP640
EQU	HP4020; HP9040 ; HP6040
EQV	HP420
EQW	HP94; HP64

Refer to the XEQ-2 and XEQ-3 engineering data sheet for more information on XEQ-2 and XEQ-3 performance and application.

For passively crossed over systems, the XEQ804 and XEQ808 crossover/equalizers are available.

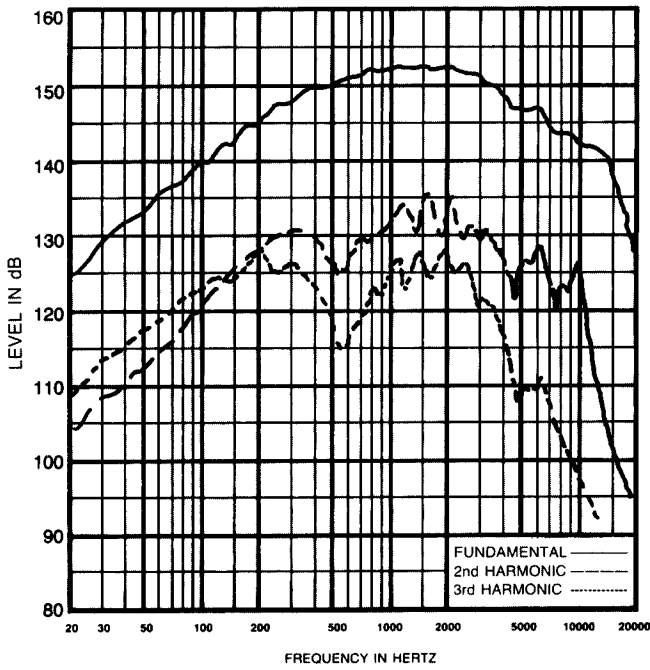

FIGURE 4
Distortion Response,
2-Inch Plane-Wave Tube, 12 Watts

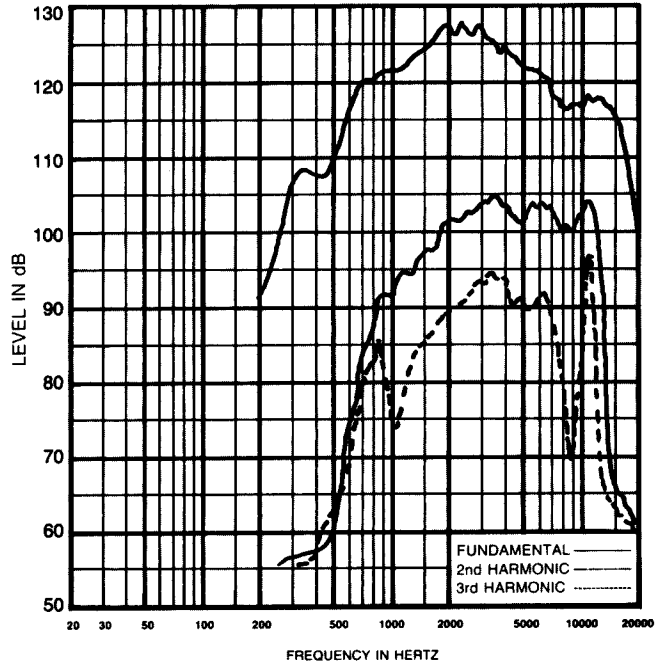

FIGURE 5
Distortion Response,
HP64 Horn, 12 Watts/1 Meter

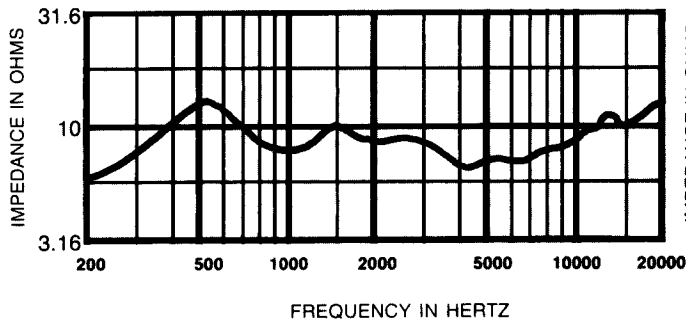

FIGURE 6
Impedance Response — 2-Inch Plane-Wave Tube

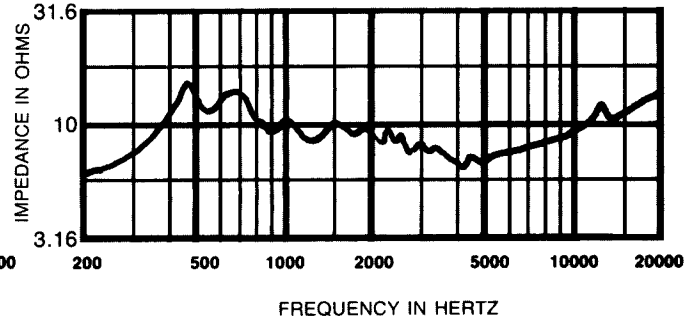

FIGURE 7
Impedance Response — HP64 Horn

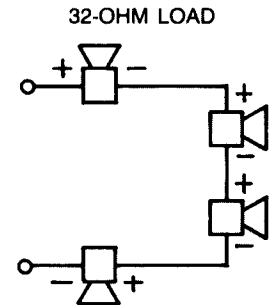
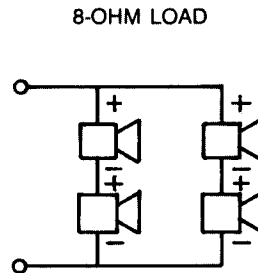
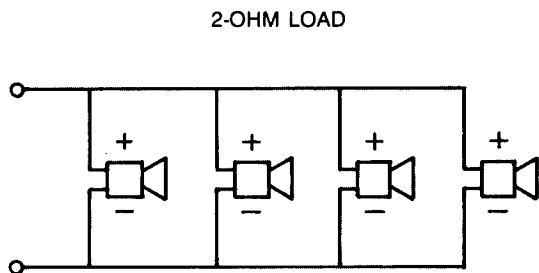

FIGURE 8
Electrical Connections

FIELD REPLACEMENT

In case of voice-coil or diaphragm failure, the diaphragm cover subassembly can be replaced by just removing the driver from the Manifold Technology®, then replacing the cover subassembly itself by the removal of six cover screws. A replacement kit with instructions may be ordered under Electro-Voice Part No. 81161XX from the Electro-Voice Service Department in Buchanan, Michigan. Spare driver assemblies may be ordered as the DH2Amt. If desired, the complete driver may be returned for service.

AES RECOMMENDED PRACTICE

The DH2A/4MT's specifications conform to the AES Recommended Practice for Specification of Components Used in Professional Audio and Sound Reinforcement (AES2-1984; ANSI S4.26-1984). This recommended practice was developed over a number of years by consultants, manufacturers and government agencies from around the world, so that the detailed performance information required in professional applications could be provided in a unified format. The recommended practice has been published in the October, 1984, issue of the *Journal of the Audio Engineering Society* (vol. 26, pp. 771-780). Individual copies of the recommended practice are available from the Audio Engineering Society, 60 East 42nd Street, New York, New York 10165, USA. Also appearing in this issue is an article which comments on the recommended practice from an engineering point of view (C.A. Henricksen, "Engineering Justifications for Selected Portions of the AES Recommended Practice for Specification of Loudspeaker Components," pp. 763-769). The comments in this article will be particularly of interest to those not involved in the day-to-day design and testing of loudspeakers.

ARCHITECTS' AND ENGINEERS' SPECIFICATIONS

The loudspeaker shall be comprised of four compression-type drivers acoustically summed by a high-frequency manifold. Each of the drivers uses a 0.0030 cm (0.0012 in.) thick titanium diaphragm joined to a pure aluminum voice coil on a polyimide form.

The loudspeaker shall exhibit essentially flat power response from 500 to 3,000 Hz, with a smoothly rolled-off response from 3,000 to 20,000 Hz. Its efficiency shall not be less than 25%. Its sensitivity, when mounted on an EV HP4020 horn, shall be 115 dB (1W/1m) with a 500-to-5,000-Hz pink-noise signal applied.

The loudspeaker shall be capable of handling a 120-watt, 800-to-20,000-Hz pink-noise signal with a 10-dB crest factor (1,200 watts peak) for a period of 24 hours. In addition, it shall be capable of handling a 160-watt, 800-to-8,000-Hz pink-noise signal and a 240-watt, 1,500-to-15,000-Hz pink-noise signal, with 6-dB crest factors for a period of two hours in both cases.

The loudspeaker shall have a diameter of 29.2 cm (11.5 in.) and a depth of 23.9 cm (9.4 in.). It shall have a 1.94-inch throat opening, with four ¼-20 threaded bolt holes on a four-inch-diameter circle for mounting.

The unit shall weigh no more than 21.6 kg (47.5 lb).

The loudspeaker shall be the Electro-Voice model DH2A/4MT.

WARRANTY (Limited)

Electro-Voice products are guaranteed against malfunction due to defects in materials or workmanship for a specified period, as noted in the individual product-line

statement(s) below, or in the individual product data sheet or owner's manual, beginning with the date of original purchase. If such malfunction occurs during the specified period, the product will be repaired or replaced (at our option) without charge. The product will be returned to the customer prepaid. **Exclusions and Limitations:** The Limited Warranty does not apply to: (a) exterior finish or appearance; (b) certain specific items described in the individual product-line statement(s) below, or in the individual product data sheet or owner's manual; (c) malfunction resulting from use or operation of the product other than as specified in the product data sheet or owner's manual; (d) malfunction resulting from misuse or abuse of the product; or (e) malfunction occurring at any time after repairs have been made to the product by anyone other than Electro-Voice or any of its authorized service representatives. **Obtaining Warranty Service:** To obtain warranty service, a customer must deliver the product, prepaid, to Electro-Voice or any of its authorized service representatives together with proof of purchase of the product in the form of a bill of sale or receipted invoice. A list of authorized service representatives is available from Electro-Voice at 600 Cecil Street, Buchanan, MI 49107 (616/695-6831) and/or Electro-Voice West, at 8234 Doe Avenue, Visalia, CA 93291 (209/651-7777). **Incidental and Consequential Damages Excluded:** Product repair or replacement and return to the customer are the only remedies provided to the customer. Electro-Voice shall not be liable for any incidental or consequential damages including, without limitation, injury to persons or property or loss of use. Some states do not allow the exclusion or limitation of incidental or consequential damages so the above limitation or exclusion may not apply to you. **Other Rights:** This warranty gives you specific legal rights, and you may also have other rights which vary from state to state.



ELECTRO-VOICE, INC., 600 Cecil Street, Buchanan, Michigan 49107

MANUFACTURING PLANTS AT ■ BUCHANAN, MI ■ NEWPORT, TN ■ SEVIERVILLE, TN ■ OKLAHOMA CITY, OK ■ GANANOQUE, ONT.
©Electro-Voice Inc. 1991 ■ Litho in U.S.A. Part Number 531731-134

a MARK IV company