

Electro-Voice®

a MARK IV company

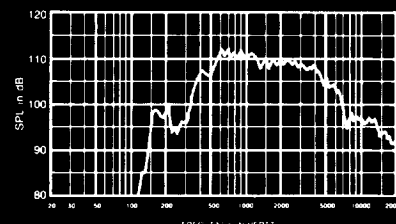

FIGURE 1
Axial Frequency Response 1 Watt/1 Meter

Model DH1A/2MT High-Frequency Acoustic Summation System

SPECIFICATIONS

The following specifications are in accordance with or exceed the AES Recommended Practice for Specification of Loudspeaker Components Used in Professional Audio and Sound Reinforcement (AES2-1984; ANSI S4.26-1984). See AES Recommended Practice section.

Power Frequency Response:
500-20,000 Hz (essentially flat
500-5,000 Hz with 6-dB-per-octave
rolloff to 20,000 Hz, rapid rolloff
beyond)

**Nominal Impedance, on HP Series Horns
above 500 Hz:**

16 ohms (single driver)

Minimum Impedance:

14 ohms at 6,000 Hz (single driver)

DC Resistance:

10.5 ohms (single driver)

**Long-Term Average Power Capacity on
HP Horns, Indicated Bands of Pink Noise,
8-Ohm Impedance Assumed,**

24-Hours, 6-dB Crest Factor:

100 watts (500-20,000 Hz)

2 Hours, 6-dB Crest Factor:

150 watts (1,000-10,000 Hz)

Nominal Efficiency, 1,000-5,000-Hz Pink

Noise, 8-Ohm Impedance Assumed:
25%

Maximum Long-Term Acoustic Power

Output (24 hours):

25 watts

Recommended Minimum Crossover

Frequency:

500 Hz

**Sound Pressure Level at 1 Meter, 1 Watt
Input Averaged from 500 Hz to 5,000 Hz:¹**

115 dB, HP4020 horn

113 dB, HP6040 horn

111 dB, HP9040 horn

112 dB, HP64 horn

110 dB, HP94 horn

114 dB, HP420 horn

112 dB, HP640 horn

110 dB, HP940 horn

108 dB, HP1240 horn

Throat Diameter:

4.92 cm (1.94 in.)

Weight:

21.4 kg (47.0 lb)

Shipping Weight:

22.9 kg (50.4 lb)

DH1Amt-16

Voice Coil Diameter:

7.62 cm (3.00 in.)

Voice Coil Construction:

Rectangular edge-wound pure
aluminum wire on a high-temperature
polyimide form

Diaphragm Construction:

Integral all-titanium construction consisting
of spherical diaphragm dome and
geometrically optimized suspension; a low-
fatigue, high temperature, long-duration-cure
engineering polymer bonds the coil form
to the diaphragm

Electrical Connection:

Screw terminals, each of which will accept
a pair of 12-gauge wires and any
smaller size

Polarity:

A positive voltage applied to the positive
(+) terminal produces a positive
acoustic pressure in the throat

MTA-22

Physical Connections,

Entrances (2):

Bolt-on, 1.30-in. diameter throat,

5-in. diameter mounting flange and four

clearance holes for ¼-in. bolts on a
3.50-in. diameter bolt circle.

Exit:

Bolt-on, standard 2-in. diameter throat,
5-in. diameter mounting flange and four
clearance holds for ¼-in. bolts on a
4-in. diameter bolt circle. Bolt heads
are captured by molded-in detail.

1. Measured on axis in the far field with 1 watt input of
band-limited pink noise from 500,5,000 Hz and
calculated to 1 meter equivalent by inverse square law.

DESCRIPTION

The Electro-Voice DH1A/2MT is a high-
performance, high-frequency acoustic
summation system capable of unprecedent-
edly high acoustic power output over a wide
frequency range.

The DH1A/2MT combines two DH1Amt-16
high-frequency drivers on an MTA-22
Manifold Technology® adapter.

High sound-pressure-level applications often
require the use of multiple horn-and-driver
combinations. This results in physically
cumbersome arrays and, when two or more
horns cover the same area, it results in
destructive interference, often referred to as
comb-filtering. This results in a familiar
"swishing" sound when moving through or
"walking" a system with music being played.
By combining the outputs of two drivers into
a single horn, the DH1A/2MT allows ex-
tremely high sound pressure levels to be
generated by compact, lightweight arrays
and without destructive interference.

The combination of extremely close driver
packing, complementary positioning and a
specially designed reflective summation path
results in phase-coherent summation.

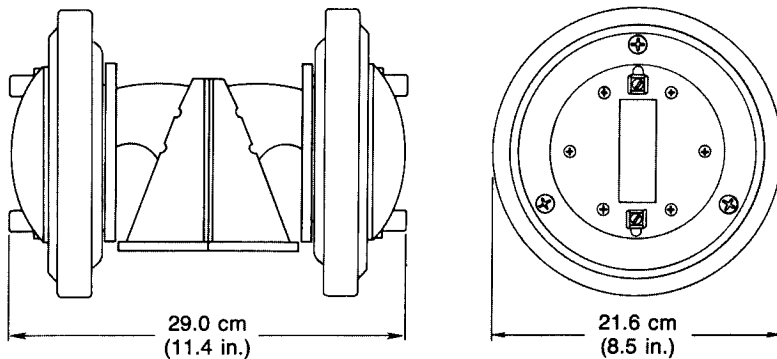

FIGURE 2
Dimensions

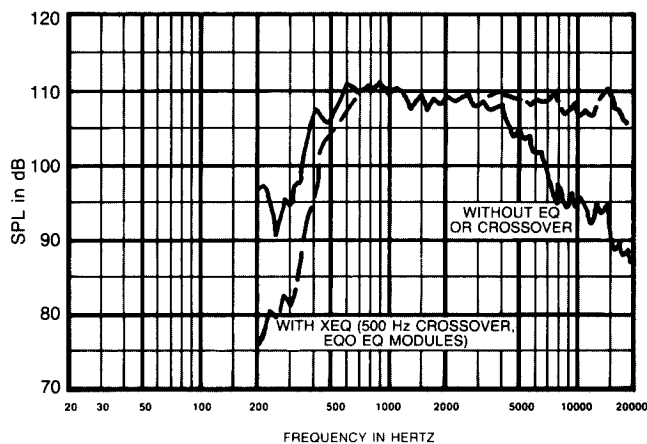

FIGURE 3
Axial Frequency Response with and without
Equalization, 1 Watt/1 Meter, HP9040 Horn

MECHANICAL CONNECTION

Bolts, washers, and nuts are provided for connecting the DH1A/2MT to a standard 2-inch-throat horn. The flange of the DH1A/2MT is molded to capture the bolt head, so installation is possible with a single wrench.

ELECTRICAL CONNECTION:

With two 16-ohm drivers and one amplifier 8-ohm, and 32-ohm systems are possible. The recommended electrical connections for these two systems are shown in Figure 8.

With more amplifiers, other wiring arrangements are possible. When using multiple amplifiers, care should be taken to ensure equal drive voltage across each driver.

RECOMMENDED HORNS

The following Electro-Voice horns are recommended for use with the HP64, HP94, HP420, HP640, HP940, HP1240, HP4020, HP6040, and HP9040.

CROSSOVER AND EQUALIZATION

As with all horn/driver combinations that combine high overall efficiency with constant-directivity, the DH1A/2MT and HP series horns provide "raw" or unequalized frequency response that rolls off above 5,000 Hz or so at about 6 dB per octave. Figure 3 shows the DH1A/2MT-HP9040 horn, with and without equalization. The equalization has been provided by an Electro-Voice XEQ-2 crossover/equalizer equipped with the EQU equalization module. While the equalization of a constant-directivity horn/driver combination can be achieved with a conventional one-third-octave equalizer, the use of the XEQ-2 crossover/equalizer with the appropriate accessory EQ module is recommended. This way, the broad-band equalization required by the horn/driver combination is supplied by the crossover/equalizer network, and the one-third-octave equalizer can be devoted to correcting the more subtle room- and array-related response anomalies. The following EQ modules are available for the DH1A/2MT:

Module	Horn(s)
EQR	HP940
EQS	HP1240
EQT	HP640
EQU	HP4020; HP6040; HP9040
EQV	HP420

Refer to the XEQ-2 and XEQ-3 engineering data sheets for more information on performance and application.

For passively crossed over systems, the XEQ804 and XEQ808 crossover/equalizers are available.

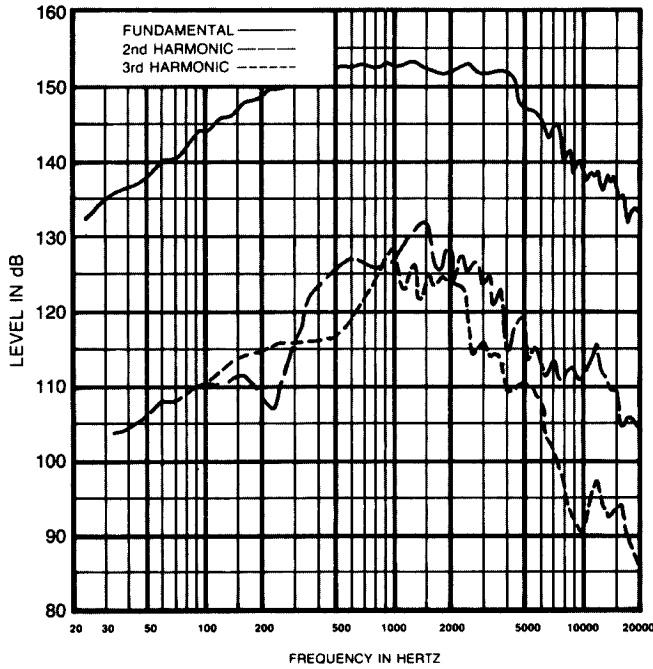

FIGURE 4
Distortion Response,
2-Inch Plane-Wave Tube, 10 Watts

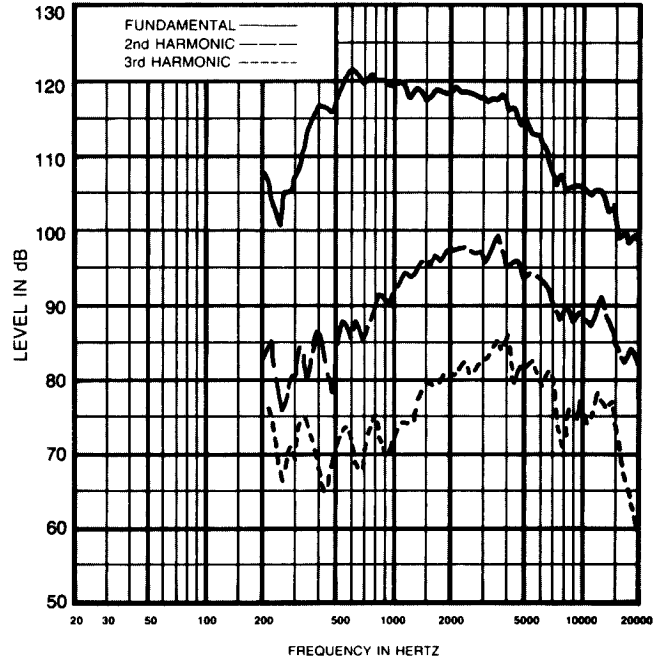

FIGURE 5
Distortion Response,
HP9040 Horn, 10 Watts/1 Meter

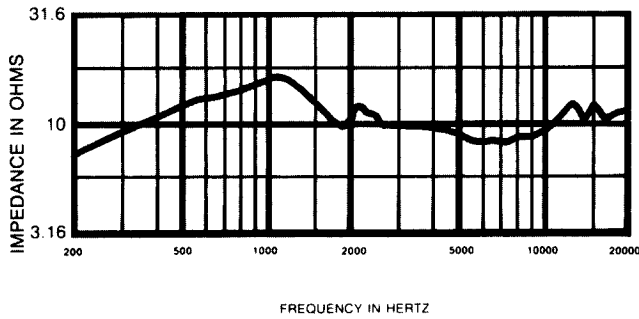

FIGURE 6
Impedance Response — 2-Inch Plane-Wave Tube

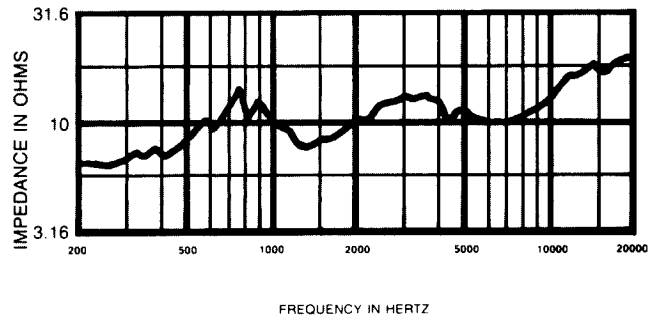

FIGURE 7
Impedance Response — HP9040 Horn

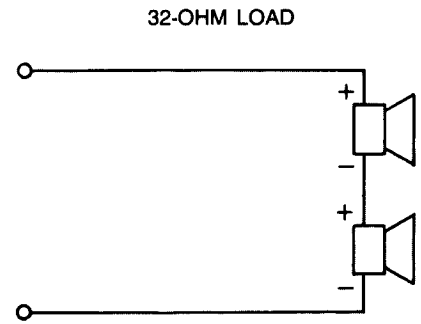
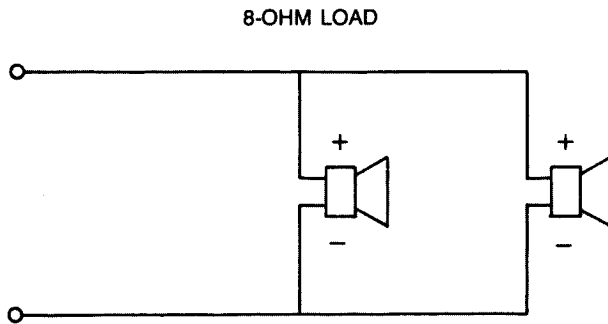

FIGURE 8
Electrical Connections

FIELD REPLACEMENT

In case of voice-coil or diaphragm failure, the diaphragm cover subassembly can be replaced by the removal of six cover screws. A replacement kit with instructions may be ordered under Electro-Voice Part No. 81338XX from the Electro-Voice Service Department in Buchanan, Michigan. Spare driver assemblies may be ordered as the DH1Amt-16. If desired, the complete driver may be returned for service.

AES RECOMMENDED PRACTICE

The DH1A/2MT specifications conform to the AES Recommended Practice for Specification of Components Used in Professional Audio and Sound Reinforcement (AES2-1984; ANSI S4.26-1984). This recommended practice was developed over a number of years by consultants, manufacturers and government agencies from around the world, so that the detailed performance information required in professional applications could be provided in a unified format. The recommended practice has been published in the October, 1984 issue of the *Journal of the Audio Engineering Society* (vol. 26, pp. 771-780). Individual copies of the recommended practice are available from the Audio Engineering Society, 60 East 42nd Street, New York, New York 10165, USA. Also appearing in this issue is an article which comments on the recommended practice from an engineering point of view (C.A. Henricksen, "Engineering Justifications for Selected Portions of the AES Recommended Practice for Specification of Loudspeaker Components," pp. 763-769).

The comments in this article will be particularly of interest to those not involved in the day-to-day design and testing of loudspeakers.

ARCHITECTS' AND ENGINEERS' SPECIFICATIONS

The loudspeaker system shall be comprised of two compression type drivers acoustically summed by a high-frequency manifold. Each of the drivers uses a 0.0037 cm (0.0015 in.) thick titanium diaphragm joined to an aluminum ribbon voice coil on a polyimide form.

The system shall exhibit essentially flat power response from 500 to 5,000 Hz, with a smoothly rolled-off response from 5,000 to 20,000 Hz. Its efficiency shall not be less than 25%. Its sensitivity, when mounted on an EV HP4020 horn, shall be 115 dB (1 W/1 m) with a 500-to-5,000-Hz pink-noise signal applied.

The system shall be capable of handling a 100-watt, 500-to-20,000-Hz pink-noise signal with a 6-dB crest factor (400 watts peak) for a period of 24 hours. In addition, it shall be capable of handling a 150-watt, 1,000-to-20,000-Hz pink-noise signal, with 6-dB crest factor, for a period of two hours.

The loudspeaker system shall have a length of 29.0 cm (11.4 in.) and a depth of 21.6 cm (8.5 in.). It shall have a 1.94-inch throat opening, with four 1/4-20 threaded bolt holes on a 4-inch-diameter circle for mounting.

The unit shall weigh no more than 21.4 kg (47.0 lb).

The loudspeaker system shall be the Electro-Voice model DH1A/2MT.

WARRANTY (Limited)

Electro-Voice Speakers and Speaker Systems (excluding active electronics) are guaranteed for five years from date of original purchase against malfunction due to defects in workmanship and materials. If such malfunction occurs, unit will be repaired or replaced (at our option) without charge for materials or labor if delivered prepaid to the proper Electro-Voice service facility. Unit will be returned prepaid. Warranty does not extend to finish, appearance items, burned coils, or malfunction due to abuse or operation under other than specified conditions, including cone and/or coil damage resulting from improperly designed enclosures, nor does it extend to incidental or consequential damages. Some states do not allow the exclusion or limitation of incidental or consequential damages, so the above exclusion may not apply to you. Repair by other than Electro-Voice or its authorized service agencies will void this guarantee. A list of authorized warranty service agencies is available from Electro-Voice, Inc., 600 Cecil Street, Buchanan, MI 49107 (AC/616-695-6831); or Electro-Voice West, 8234 Doe Avenue, Visalia, CA 93291 (AC/209-651-7777). This warranty gives you specific legal rights, and you may also have other rights which vary from state to state.

Service and repair address for this product: Electro-Voice, Inc., 600 Cecil Street, Buchanan, Michigan 49107.

Specifications subject to change without notice.



ELECTRO-VOICE, INC., 600 Cecil Street, Buchanan, Michigan 49107

MANUFACTURING PLANTS AT ■ BUCHANAN, MI ■ NEWPORT, TN ■ SEVIERVILLE, TN ■ OKLAHOMA CITY, OK ■ GANANOQUE, ONT.
©Electro-Voice Inc. 1991 ■ Litho in U.S.A. Part Number 531183-851

a MARK IV company