

Xds

X-Array™ Double Subwoofer System

- Unprecedented acoustic output in a small, lightweight package
- Ring Mode Decoupling (RMD)™ provides accurate transient detail
- EVX-180B woofers
- Unique rear-hinge rigging
- Enclosure shell matches two full-size X-Array™ systems
- Optimized for maximum subwoofer -frequency acoustic output

Description

The X-Array™ product line represents important advancements in concert-sound-reinforcement technology. The design goals called for the highest acoustic output capability with the highest fidelity in lightweight, compact enclosures that were easy to array. The development began with a clean sheet of paper and took an integrated approach. The individual loudspeaker drivers, horns, enclosures, rigging hardware and system configurations were designed from the ground up specifically for this high-performance application.

The Xds is a manifolded, vented-box subwoofer system utilizing two 457-mm (18-in.) woofers in the double-wide X-Array™ enclosure shell. The enclosure has been optimized for maximum subwoofer-frequency output. The two woofers face each other in a manifold chamber at the center of the enclosure. This manifolding technique (U.S. Patent Number 4,733,749) increases the acoustic loading, resulting in increased low-frequency efficiency (at slightly above box tuning) and reduced distortion compared to conventional direct-radiating designs. The woofers were designed as part of the Xds development and represent a step forward in state-of-the-art loudspeaker design in

terms of high acoustic output with low distortion and low power compression.

Electro-Voice engineers developed a new technology dubbed Ring Mode Decoupling (RMD™) to substantially improve clarity and intelligibility by reducing both linear and nonlinear resonance modes that color the sound.

The low-frequency driver in the Xds is the EVX-180B. An improved version of the industry-standard EVX-180A high-excursion 467-mm (18-in.) woofer that has distinguished itself as an industry standard for high-power, low-frequency reproduction. During the X-Array™ development, the thermal conduction of the motor was improved and the suspension was redesigned, giving the EVX-180B even lower power compression and a longer mechanical lifetime. In the Xds, the woofers are manifolded in a vented enclosure optimized for maximized subwoofer output from 3-160 Hz with minimized distortion.

Ring Mode Decoupling, (RMD™), is a technique utilized and named by Electro-Voice to describe a process used to improve sound quality in loudspeaker systems. RMD™ offers a solution to a very fundamental problem. It has long been recognized that two different loudspeaker systems can sound different even though they both may be equal-

ized to have the same frequency response. This difference is due to a variety of resonances, or ring modes that color the sound. Although this ringing may be very low in level compared to the program material, it is still audible. The source of these resonances may be mechanical or acoustical in nature, or a combination of both. In addition, they may be linear or nonlinear, resulting in their character changing with level. Furthermore, these Ring Modes may be aggravated when multiple loudspeaker enclosures are assembled into arrays. The result is a coloration that decreases intelligibility and clarity, with the nature of that coloration varying with level. Often, the listener perceives that coloration as imbalance in the frequency response, and will attempt to electronically adjust the system to restore the spectral balance. However this electronic equalization has the negative effect of changing the program material itself.

Ring Mode Decoupling (RMD™) addresses mechanical resonances with mechanical solutions, and acoustical resonances with acoustical solutions. In the Xds development, RMD™ was applied at every level – to the individual low-frequency drivers, the low-frequency enclosure chambers and the interaction between multiple enclosures. The design process included, for example, the driver

Xds Double Subwoofer System

cone, suspension geometry and materials, enclosure geometry and materials, absorptive materials, etc. The result is a dramatic improvement in clarity and with a much more neutral sound (a lack of coloration) with the loudspeaker system maintaining its sonic integrity from the very-lowest sound pressure levels to the very-highest sound pressure levels. This means that the front-of-house engineer will not have to retune the EQ and level settings as the SPL is increased throughout the show. This also means that the sound-system performance will remain consistent in different array configurations and from venue to venue.

The Xds utilizes a double-wide X-Array™ enclosure shell. The height of the Xds is identical to the standard, full-size X-Array™ enclosures (like the Xf, Xn and Xb); however the footprint matches that of two standard X-Array™ enclosures sitting side by side with their sides parallel. Thus, two standard X-Array™ enclosures (like the Xf, Xn, Xcn or Xb) may be stacked on top of the Xds. The Xds does not have rigging hardware for flying.

The durable Xds enclosure is constructed of 18-mm, 13-ply birch plywood and has a wear-resistant black, textured paint finish. The system is trapezoidal, forming a 36° wedge and includes a heavy-duty steel grille with a water-resistant charcoal-gray foam interlining. The enclosure features vinyl bumper pads on the front corners to and feet on the bottom to resist wear.

A variety of accessories are available for the X-Array™ loudspeaker systems, including rigging hardware, dollies, covers, electronic crossovers, amplifier racks and speaker cabling. Consult the *X-Array™ Accessories* section for a complete listing of the available accessories

Applications

The X-Array™ loudspeaker systems were designed for optimal performance in both concert-sound and permanent-installation applications where studio-monitor sound quality is required at concert-sound levels. The X-Array™ loudspeaker systems work well individually, in small arrays and in large arrays. The high acoustic output from these

compact, lightweight systems provide the highest acoustic-power-to-weight ratio, the highest acoustic-power-to-frontal-area ratio, and the highest acoustic-power-to-bulk-volume ratio in the industry. That means that X-Array™ systems will be considerably smaller and lighter compared to competitive systems having equivalent acoustic output.

With its response from 32-200 Hz, the Xds is recommended for subwoofer and low-frequency applications where extremely high levels of bass are required. Specifically, the Xds has been optimized to provide subwoofer reinforcement for all of the X-Array™ loudspeaker systems. Typically, the Xds would be crossed over to provide subwoofer reinforcement from 80 Hz and below in parallel with the full-range systems (made up of Xf, Xn, Xcn, Xb and Xcb systems that cover 40 Hz and above). However, the Xds may be crossed over at 125 Hz and used as a combination subwoofer/low-frequency system in place of or in addition to the standard low-frequency systems (like the Xb and Xcb). The Xds may be used individually or in multiples to construct subwoofer/low-frequency arrays, or may be used with the full-range X-Array™ systems to construct full-range, large-scale arrays. The double-wide Xds enclosure footprint matches that of two standard X-Array™ enclosures sitting side by side with their sides parallel, allowing two standard, full-size systems to be stacked on top of the Xds. The Xds does not have flying hardware and is intended for stacking only. The Xds would be well suited for front-of-house, front-fill, and side-fill applications. The Xds is intended to be used with other X-Array™ systems for a full-range response as an active system that requires an active electronic crossover. Both the Electro-Voice Dx34A and Klark Teknik digital crossovers are recommended for signal control. (See the *Crossover, Equalization and Signal Delay Controller* section.) The Electro-Voice P3000 amplifier is recommended for powering the Xds. (See the *Amplifier Recommendations* section.)

Power-Handling Capabilities

The Xds systems are rated as per the “ANSI/EIA RS-426-A Loudspeaker Power-Rating,

Full-Range Test,” which uses a shaped-random-noise signal to simulate typical music to test the mechanical and thermal capabilities of the loudspeakers. A digital crossover was used to provide the appropriate filtering and equalization. The test parameters are as follows:

Subwoofer Section (Pins 1 and 2 paralleled):

$P_{E(MAX)}$:	1,200 watts
Test Voltage:	58.7-volts rms 117.4-volts peak
$R_{SR} (1.15R_E)$:	2.88 ohms

Amplifier Recommendations

Power amplifiers with the following ratings are recommended for use with the Xds loudspeaker systems:

SUB:	800 watts into 8 ohms 91-volts rms short term 130-volts peak
------	--

Xds loudspeakers may be paralleled with other Xds systems as long as the amplifiers can drive the lower impedances. To maintain a sufficient damping factor with long cable runs, amplifier loads of four ohms per channel are recommended. The Electro-Voice P3000 amplifiers are ideal for powering the X-Array™ systems.

Crossover, Equalization and Signal Delay Controller

The Xds is intended to be used with other X-Array™ loudspeaker systems (like the Xf, Xn, Xcn, Xb or Xcb) to construct full-range arrays as an active system requiring an active crossover, equalization and signal delay controller. For basic applications, the Electro-Voice Dx34A 2-in/4-out controller is recommended. For more sophisticated applications, the Klark Teknik DN8000 2-in/5-out controller is recommended. Linkwitz-Riley crossover filters with a minimum slope of 24 dB per octave at 80-125 Hz are recommended, and infrasonic filter protection at 32 Hz or higher with a minimum slope of 12-dB/octave is recommended. Both the Dx34A and the DN8000 offer appropriate filtering, equalization and signal delay capabilities to provide optimum performance of the X-Array™ loudspeaker systems. Digi-

Xds Double Subwoofer System

tal parameter settings for both controllers are available upon request.

Electrical Connection and System Wiring

Two paralleled Neutrik 8-pin Speakon® connectors are used for electrical connection to the Xds loudspeakers with the following pin assignments:

SUB1: Pins 1 Paralleled

SUB2: Pins 2 Paralleled

The Xds wiring diagram is shown in Figure 7. Since the connectors are paralleled, it does not matter which connector is used as the input or output when paralleling Xds systems. Although Pins 3 and 4 are not used by the Xds systems, they are paralleled on the input panel. This allows an X-Array™ MB/HF box (like the Xf or Xcn— which use Pins 3 and 4, but not Pins 1 and 2) to be paralleled with an Xds, allowing all eight conductors to be used with a single cable run to the amplifiers. Note that, when two Xds systems are jumped from one to another via the input/output connections, the amplifier home run cable will have two woofers on Pins 2 (for a 4-ohm load) and two woofers on Pins 1 (for a 4-ohm load).

Field Replacement

Normal service for the Xds requires only a #2 Phillips screwdriver and a 3/16-inch hex-key wrench. The drivers may be accessed as follows:

SUB: First remove the grille, then remove the screws securing the hatch on the front of the enclosure. Remove the screws securing the 18-inch woofer and lift the woofer out of the enclosure. In the event of failure, the entire woofer must be replaced or reconed.

The following service parts are available from the service department in Buchanan, Michigan USA:

LF #818-2883 EVX-180B complete driver

The complete drivers are available only for repair replacement and are not available for general sale.

Architects' and Engineers' Specifications

The loudspeaker system shall be a two-driver, manifolded, vented-box low-frequency system with a frequency response from 32-200 Hz. The loudspeaker system also shall have two 457-mm (18-in.) low-frequency woofers and each shall have an 8-ohm, 101-mm (4-in.) diameter voice coil and a 600-watt power rating. The loudspeaker shall have a rigging system enabling a column of loudspeakers to be hinged at their back corners, with relative downward angles set by adjustable rigging straps at the front. The enclosure shall be constructed of 18-mm thick, 13-ply birch plywood, and shall be trapezoidal, forming an 36° wedge and be 914 mm (36.00 in.) high, 1166 mm (45.92 in.) wide at the front, 736 mm (28.98 in.) wide at the back and 759 mm (29.88 in.) deep, and shall weigh 121 kg (267 lb).

The loudspeaker system shall be the Electro-Voice Xds.

Rigging Accessories:

Grid: This ATM Fly-Ware™ “T”-shaped, all-steel-construction grid was specifically designed as a single column of X-Array™ systems. Multiple grids can be linked together with couplers on front and back retractable arms, the position of which sets the splay angle between adjacent columns. Part number MEGS-4000-T. ATM Fly-ware™, 2100 S. Wilmington Ave., Carson, CA 90810 USA, 310/834-5914

Xrhg Grid Hinge: Two Xrhg grid rigging hinges are used to attach the rear of the top enclosure in a column to the rear of an X-Array™ compatible grid. Each hinge consists of two precision-machined steel rigging-track fittings connected by an alloy-steel chain. Part number 510-2999. Electro-Voice, 600 Cecil St., Buchanan, MI 49107 USA, 616/695-6831 or 800/234-6831

Xrhp Pickup Hinge: Two Xrhp pickup rigging hinges are used to create custom rigging assemblies to attach to the rear of the top enclosure in a column when an ATM grid is not used. Each hinge consists of one precision-machined steel rigging-track fitting with an alloy-steel chain. Part number 510-

3000. Electro-Voice, 600 Cecil St., Buchanan, MI 49107 USA, 616/695-6831 or 800/234-6831

Xrhl Linking Hinge: Two Xrhl linking rigging hinges are used to link two enclosures together at the rear. Each hinge consists of two precision-machined steel rigging-track fittings connected by a heavy-duty steel hinge. Part number 510-2998. Electro-Voice, 600 Cecil St., Buchanan, MI 49107 USA, 616/695-6831 or 800/234-6831

Xrsl Long Rigging Steel Straps: Two Xrsl long rigging straps are used at the front of two enclosures to adjust their relative vertical angles. The Xrsl may also be used to attach the front of the top enclosure to the ATM grid when upward angles are not required. Each all-steel strap consists of two New Haven NH32102-2 double-stud fittings connected by black plastic-coated wire rope. Sound Manufacturing Inc., 3336 Primera Ave., Hollywood, CA 90068 USA, 213/850-5042

Xrssl Short Rigging Steel Straps: Two Xrssl short rigging straps are used to attach the front of the top enclosure to the ATM grid. The Xrssl may also be used at the front of two enclosures when a limited range of vertical angles are required. The all-steel Xrssl utilizes the same construction as the Xrsl. Sound Manufacturing Inc., 3336 Primera Ave., Hollywood, CA 90068 USA, 213/850-5042

General Rigging Supplies: A wide variety of standard and specialty rigging hardware components for both touring and permanent-installation applications is available. Sound Manufacturing Inc., 3336 Primera Ave., Hollywood, CA 90068 USA, 213/850-5042 or ATM Fly-ware™, 2100 S. Wilmington Ave., Carson, CA 90810 USA, 310/834-5914

Electronic Accessories:

Klark Teknik DN8000 Digital Controller: The DN8000 digital electronic loudspeaker controller has a two-in/five-out architecture, with each output having programmable high-pass and low-pass filters, four-band equalization, signal delay, compressor-limiter-and noise-gate functions. Program parameters for optimal performance of the X-Array™ sys-

Xds Double Subwoofer System

tems are available. Klark Teknik, Klark Industrial Park, Walter Nash Road, Kidderminster, Worcestershire DY11 7HJ England, 44-156-274-1515

Electro-Voice Dx34A Digital Controller: The Dx34A digital electronic loudspeaker controller has a two-in/four-out architecture, with each output having programmable high-pass and low-pass filters, two- or three-band equalization, signal delay and limiter functions. Program parameters for optimal performance of the X-Array™ systems are available. EVI Audio, 600 Cecil St., Buchanan, MI 49107 USA, 616/695-6831

Electro-Voice P3000 Power Amplifiers: The stereo P3000 power amplifiers are rated at 800 watts into 8 ohms, or 91-volts rms short term. The amplifiers are 3-U high and weigh 28 kg (62 lb) each. EVI Audio, 600 Cecil St., Buchanan, MI 49107 USA, 616/695-6831

X-Array™ Amplifier Racks: These 16-U racks will hold four Electro-Voice P3000 power amplifiers, one Klark Teknik DN8000 digital controller, 1-U light module, and a 2-U multipin patch panel. The aluminum-frame/wood-panel racks are vibration-isolation mounted on heavy-duty wheel boards and come prewired for AC power, audio and control signal sends and Neutrik® Speakon speaker connectors. db Sound, L.P., 1219 Rand Road, Des Plaines, IL 60016 USA, 847/299-0357

X-Array™ Speaker Cables: Eight conductor cable with four #11 AWG conductors and four #13 AWG connectors. The larger conductors are used in the LF bands for increased damping factor. Lengths made to order. Standard terminations are Neutrik Speakon™ NL8FC connectors wired to X-Array™ standards; however, custom terminations are available. Entertainment Technology Cable, 1247 Rand Road, Des Plaines, IL 60016 USA, 800/529-6312

Miscellaneous Accessories:

X-Array™ Loudspeaker Covers: Heavy-duty covers are available for the X-Array™ speakers. These covers wrap around the enclosures, while sitting on a dolly, and Velcro

together at the back for fast installation and removal. db Sound, L.P., 1219 Rand Road, Des Plaines, IL 60016 USA, 847/299-0357

X-Array™ Dolly Boards: Double-wide dolly built to hold four X-Array™ loudspeakers, two wide by two high. The double-thick 18-mm birch-plywood construction includes cutouts and keys for loudspeaker enclosure shape and alignment feet. The dolly boards are painted black and utilize four extra-heavy-duty 4-inch x 2-inch casters. Custom-designed dolly boards are also available to meet specific requirements. R&R Cases and Cabinets, 1217 Rand Road, Des Plaines, IL 60016 USA, 847/299-8100

Racks and Road Cases: A variety of general purpose, custom racks and hard-shell road cases are available for touring or permanent-installation applications. R&R Cases and Cabinets, 1217 Rand Road, Des Plaines, IL 60016 USA, 847/299-8100

Limited Warranty

Electro-Voice products are guaranteed against malfunction due to defects in materials or workmanship for a specified period, as noted in the individual product-line statement(s) below, or in the individual product data sheet or owner's manual, beginning with the date of original purchase. If such malfunction occurs during the specified period, the product will be repaired or replaced (at our option) without charge. The product will be returned to the customer prepaid. **Exclusions and Limitations:** The Limited Warranty does not apply to: (a) exterior finish or appearance; (b) certain specific items described in the individual product-line statement(s) below, or in the individual product data sheet or owner's manual; (c) malfunction resulting from use or operation of the product other than as specified in the product data sheet or owner's manual; (d) malfunction resulting from misuse or abuse of the product; or (e) malfunction occurring at any time after repairs have been made to the product by anyone other than EVI Audio Service or any of its authorized service representatives. **Obtaining Warranty Service:** To obtain warranty service, a customer must deliver the product, prepaid, to EVI Audio

Service or any of its authorized service representatives together with proof of purchase of the product in the form of a bill of sale or receipted invoice. A list of authorized service representatives is available from EVI Audio Service at 600 Cecil Street, Buchanan, MI 49107 (800/234-6831 or FAX 616/695-4743). **Incidental and Consequential Damages Excluded:** Product repair or replacement and return to the customer are the only remedies provided to the customer. Electro-Voice shall not be liable for any incidental or consequential damages including, without limitation, injury to persons or property or loss of use. Some states do not allow the exclusion or limitation of incidental or consequential damages so the above limitation or exclusion may not apply to you. **Other Rights:** This warranty gives you specific legal rights, and you may also have other rights which vary from state to state.

Electro-Voice Speakers and Speaker Systems are guaranteed against malfunction due to defects in materials or workmanship for a period of five (5) years from the date of original purchase. The Limited Warranty does not apply to burned voice coils or malfunctions such as cone and/or coil damage resulting from improperly designed enclosures. Electro-Voice active electronics associated with the speaker systems are guaranteed for three (3) years from the date of original purchase. Additional details are included in the Uniform Limited Warranty statement.

Electro-Voice Accessories are guaranteed against malfunction due to defects in materials or workmanship for a period of one (1) year from the date of original purchase. Additional details are included in the Uniform Limited Warranty statement.

For warranty repair or service information, contact the service repair department at: 616/695-6831 or 800/685-2606.

For technical assistance, contact Technical Support at 800/234-6831 or 616/695-6831, M-F, 8:00 a.m. to 5:00 p.m. Eastern Standard Time.

Specifications subject to change without notice.

Xds Double Subwoofer System

Figure 1 — Polar Response

The directional response of the Xds was measured in an anechoic environment at a distance of 6.1 m (20 ft.) using 1/3-octave-filtered pink noise with a full spherical measurement system. The polar response of the loudspeaker system at selected 1/3-octave frequencies is shown. The selected frequencies are representative of the polar response of the system.

— Vertical
— Horizontal
5 dB per division

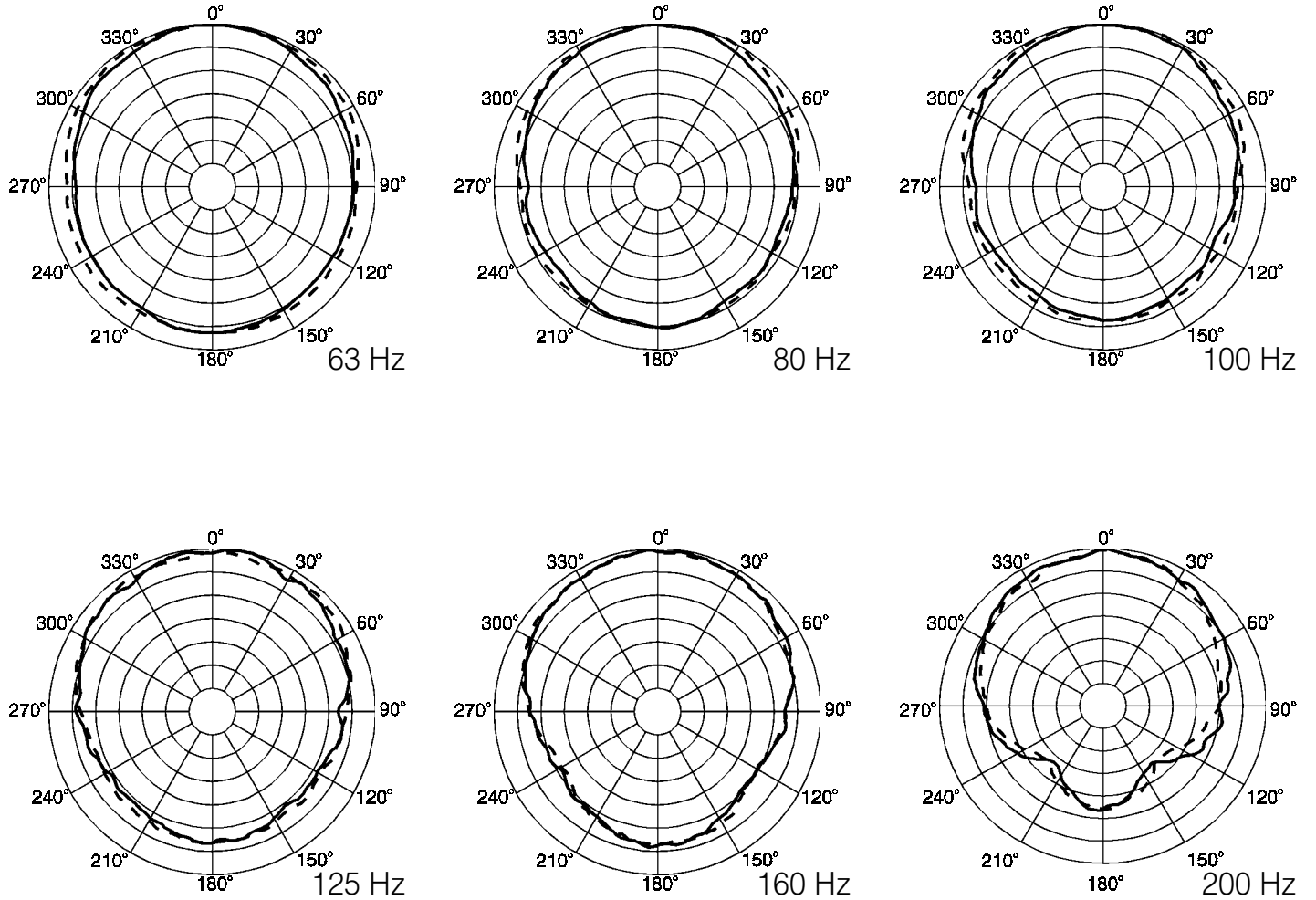

Xds Double Subwoofer System

Xds Double Subwoofer System

Figure 2 — Frequency Response

The frequency response of the Xds was measured on axis in the far field in an anechoic environment using a swept sine-wave signal. The Klark Teknik DN8000 digital electronic unit was used to provide the necessary crossover filters, equalization and time delay. One watt of power (2.00-volts rms at 70 Hz) was applied to the mid band of the low-frequency section. The sound pressure level was normalized for an equivalent one-meter distance.

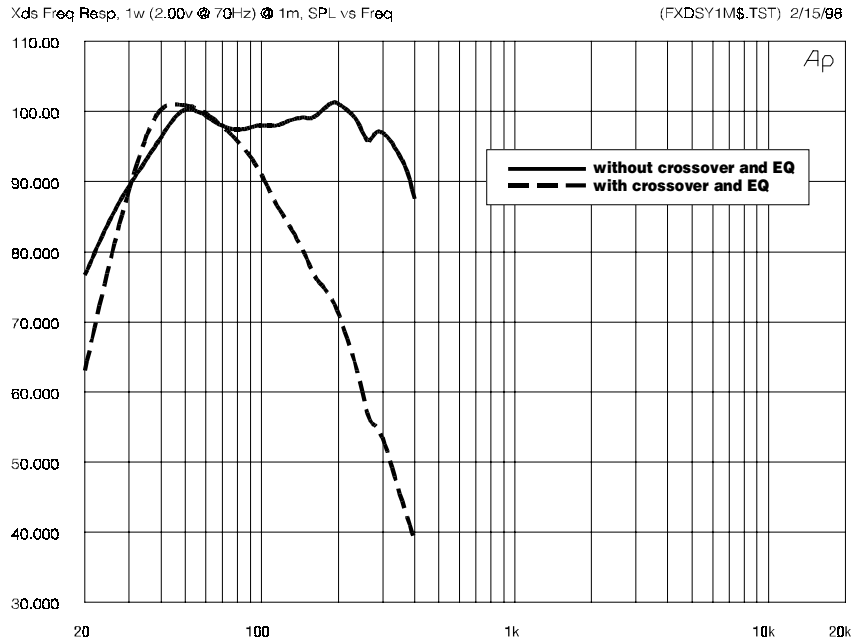

Figure 3 — Beamwidth

The beamwidth of the Xds, (i.e., the included horizontal and vertical coverage angles at the -6-dB points) was measured with a full-spherical measurement system as described in Figure 1.

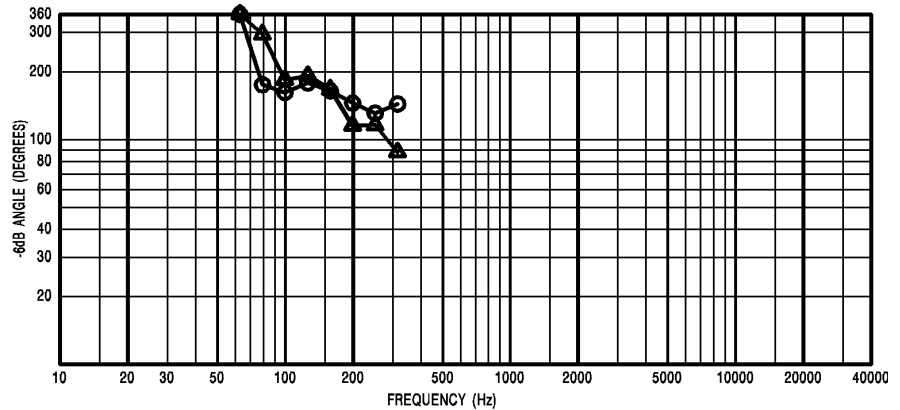
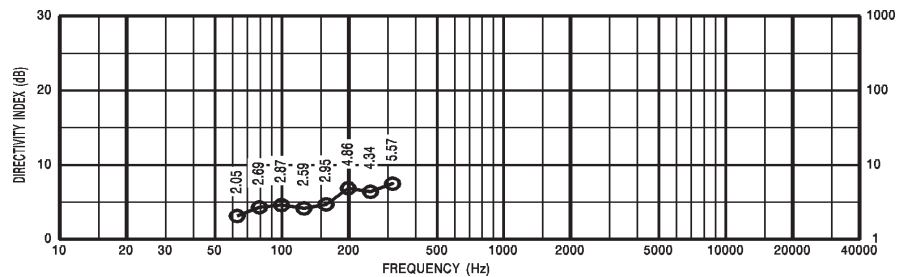

Figure 4 — Directivity

The directivity index, D_i , and directivity factor, R , of the Xds were measured with a full-spherical measurement system as described in Figure 1.



Xds Double Subwoofer System

Figure 5 — Distortion

Distortion for the Xds was measured on axis in the far field in an anechoic environment with an input signal that would result in a sound pressure level of 115 dB at one meter. The Klark Teknik DN8000 digital electronic unit was used to provide the necessary cross-over filters, equalization and time delay. The sound pressure level was normalized for an equivalent one-meter distance. Plots of second and third harmonic distortion are shown referenced to the fundamental.

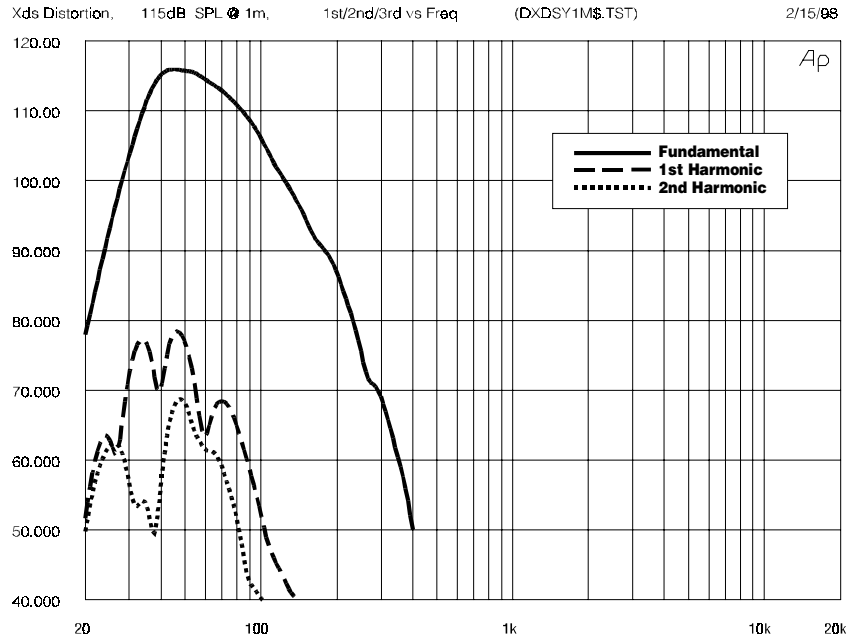

Figure 6 — Impedance

The impedance of each frequency band of the Xds was measured in an anechoic environment

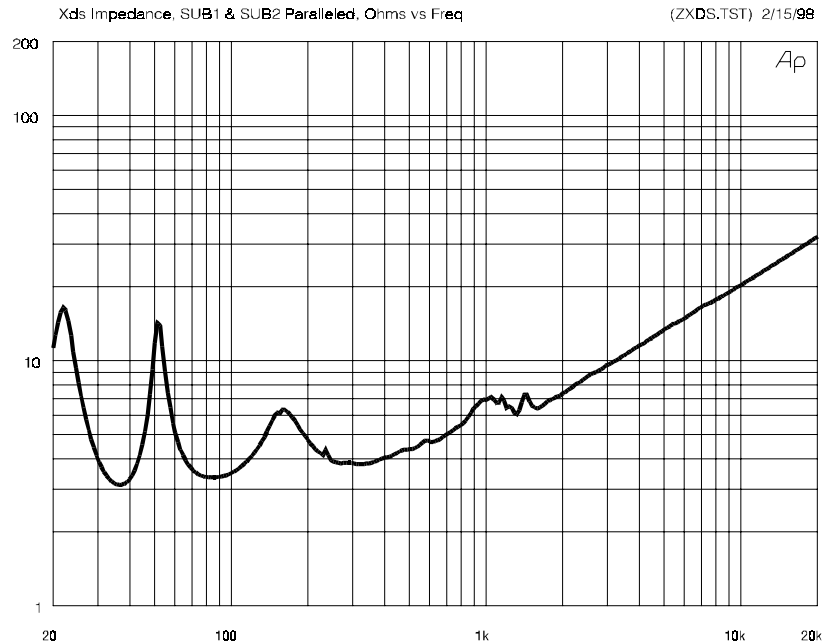
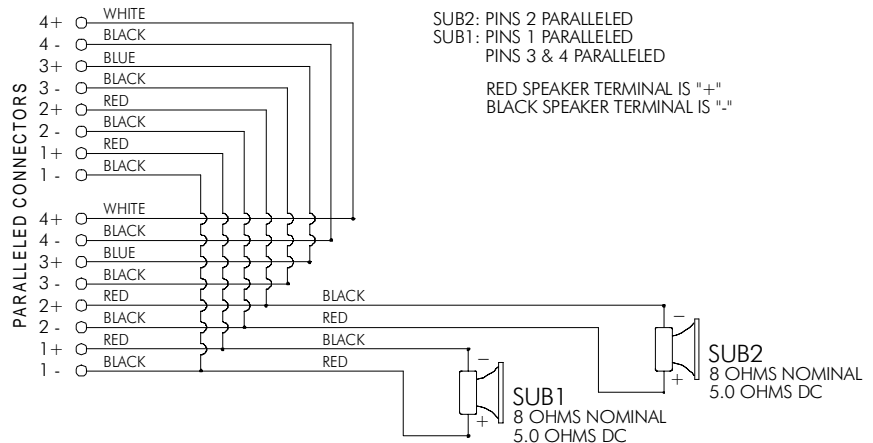

Figure 7 — Wiring Diagram

The wiring diagram of each frequency band of the Xds is shown.



Xds Double Subwoofer System

Figure 8—Dimensions

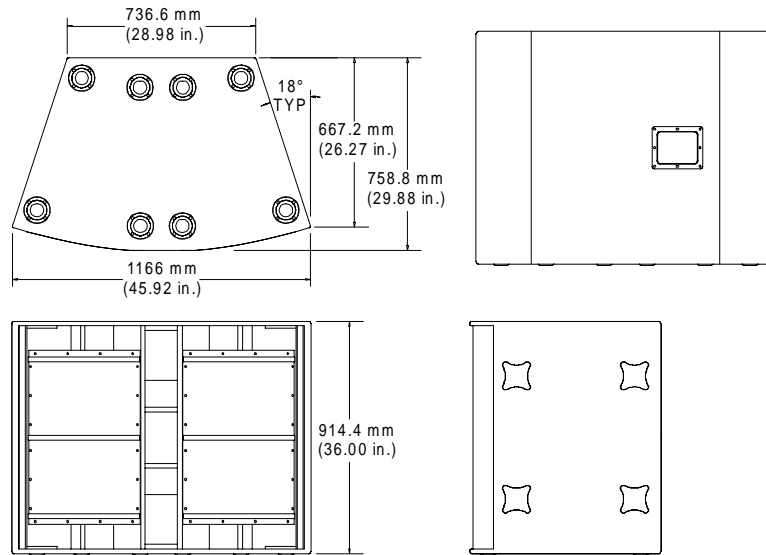

Specifications

Frequency Response (measured in far field, with and without crossover and equalization, calculated to one meter on axis, swept sine wave, one watt into system - 2.00 V at 70 Hz, anechoic environment; see Figure 2):

32-200 Hz

Crossover Frequency:

80-125 Hz

Efficiency Mid Band:

6.0 %

Maximum Long-Term-Average Power-Handling Capacity (per ANSI/EIA RS-426A 1980):

1,200 watts

Maximum Long-Term-Average Mid-Band Acoustic Output, LF/HF:

72 acoustic watts

Sensitivity (SPL at one meter, indicated input power, anechoic environment, average level),

1 watt:

100 dB

1,200 watts:

130.8 dB

Beamwidth (angle included by 6-dB-down points on polar responses,

indicated one-third-octave bands of pink noise; see Figures 1 and 3),

Horizontal, 63-200 Hz:

180° (+180°, -40°)

Vertical, 63-200 Hz:

200° (+160°, -80°)

Directivity Factor, R (Q), 63-200 Hz Average (see Figure 4):

3.0 (+1.9, -1.0)

Directivity Index, D_i, 63-200 Hz Average (see Figure 4):

4.8 dB (+2.1 dB, -1.7 dB)

Distortion (115 dB SPL at one meter, shaped spectrum; see Figure 5),

Second Harmonic,

40 Hz:

0.6%

80 Hz:

0.2 %

Third Harmonic,

40 Hz:

0.3 %

80 Hz:

0.1 %

Transducer Complement,

Two EVX-180B 18-in. woofers

Impedance (see Figure 6),

Nominal:

Two 8-ohm loads

Minimum:

Two 6.1-ohm loads

Input Connections:

Two Neutrik NL8MPR Speakon® connectors paralleled

Recommended Amplifier Power, Rating:

800 watts @ 8 ohms

(91-volts rms short term)

Enclosure Construction,

Enclosure Shell:

18-mm, 13-ply birch plywood

Finish:

Black textured paint

Grille:

Powder-coated steel with foam

Dimensions,

Height:

914 mm (36.00 in.)

Width (front):

1166 mm (45.92 in.)

Width (back):

736 mm (28.98 in.)

Depth:

759 mm (29.88 in.)

Angle:

36° wedge

Net Weight:

121 kg (267 lb)

Shipping Weight:

130 kg (282 lb)

Electro-Voice®

600 Cecil Street, Buchanan, MI 49107

616/695-6831, 616/695-1304 Fax

©EVI Audio, 1998 • Litho in U.S.A.