

SHOWN WITHOUT GRILL

MTH-4.5/42B Manifold Technology® Mid-Bass/Mid-Frequency/ High-Frequency Sound Reinforcement System

- Sonically improved lower midrange
- 40° x 20° constant-directivity pattern
- Larger MT rectangular enclosure
- High acoustic output, low distortion
- Manifold Technology® enables smaller and lighter loudspeaker arrays
- MT systems with different coverage patterns and output capabilities may be mixed and matched
- Unique rigging scheme for flexible array design and quick assembly
- Available without rigging hardware
- Available carpeted or painted

SPECIFICATIONS

Frequency Response (measured in far field, calculated to one meter on axis, swept sine wave, one watt into mid-bass section, anechoic environment; see Figure 1):
150-20,000 Hz

Recommended Crossover Frequencies:
160 Hz, 1,600 Hz, 8,000 Hz

Efficiency, MB/MF/HF:
14/25/25%

Long-Term Average Power-Handling Capacity (per EIA RS-426-A 1980; see Power Handling Section),
MB/MF/HF: 1,200/120/120

Maximum Long-Term Average Mid-Band Acoustic Output:
200 watts

Sensitivity (SPL at one meter, indicated input power, anechoic environment, band-limited pink-noise signal), MB/MF/HF,
1/1/1 Watt: 109/116.5/112 dB
1,200/120/120 Watts: 140/137.5/133 dB

Beamwidth (angle included by 6-dB-down points on polar responses, indicated one-third-octave bands of pink noise; see Figures 3 and 4),
1,000-16,000 Hz, Horizontal:
40° (+40°, -4°)
1,000-16,000 Hz, Vertical:
20° (+20°, -5°)

Directivity Factor R₀ (Q), 1,000- to 16,000-Hz Median (see Figure 5):
49.3 (+35.4, -26.7)

Directivity Index D_i, 1,000- to 16,000-Hz Median (see Figure 5):
16.9 dB (+2.4 dB, -3.4 dB)

Distortion, 120 dB SPL at 1 Meter, Shaped Spectrum (see Figure 6),
Second Harmonic,
200 Hz: 0.9%
1,000 Hz: 0.8%
3,000 Hz: 1.4%
10,000 Hz: 1.3%

Third Harmonic,
200 Hz: 0.9%
1,000 Hz: 0.5%
3,000 Hz: <0.1%
10,000 Hz: 0.6%

Transducer Complement,
MB: Four DL10X 10-inch drivers; integrated 60° x 40° horn
MF: Two DH2AS1 compression drivers; HPD42, 40° x 20° horn
HF: Two DH2AS1 compression drivers; HPD42, 40° x 20° horn

Impedance (MB1 and MB2 paralleled; see Figures 2 and 7),
Nominal, MB/MF/HF:
4/16/16 ohms
Minimum, MB/MF/HF:
2.6/12.5/12.5 ohms

Input Connections:
Neutrik Speakon® NL8MPR
Enclosure Materials, Structural, All Versions:
14-ply birch plywood
Finish,
MTH-4.5AC, MTH-4.5ACF:
Black carpet
MTH-4.5AP, MTH-4.5AF:
Black textured paint

Hanging (MTH-4.5ACF and MTH-4.5APF only):
Two-point flying system (tracks accept New Haven NH 32102-1 fittings)

Dimensions,
Height: 91.4 cm (36.00 in.)
Width: 91.4 cm (36.00 in.)
Depth: 75.9 cm (29.88 in.)

Net Weight:
161 kg (354 lb)
Shipping Weight:
182 kg (402 lb)

DESCRIPTION
The Electro-Voice MTH-4.5/42B mid-bass/mid-frequency/high-frequency loudspeaker system

is a member of the family of Manifold Technology® MT loudspeaker systems designed for high-level sound reinforcement in concert-sound touring and permanent-installation applications. The MTH-4.5/42B is an active, three-way, horn-loaded, 40° x 20° constant-directivity system with a rectangular enclosure, utilizing four high-power mid-bass drivers in the mid-bass frequency band, two high-power compression drivers in the mid-frequency band and two high-power compression drivers in the high-frequency band. This configuration results in exceptionally high acoustic output from a small enclosure. The MTH-4.5/42B may be combined with other members of the MT-4 and MT-2 loudspeaker family. The combination of the MTH-4.5/42B loudspeaker system and the MTL-4B low-frequency loudspeaker system form the MT-4/42B full-range system. There are four models in the MTH-4.5/42B series: the MTH-4.5/42BCF (carpeted finish with flying hardware), the MTH-4.5/42BC (carpeted finish without flying hardware), the MTH-4.5/42BPF (painted finish with flying hardware) and the MTH-4.5/42BP (painted finish without flying hardware).

The MTH-4.5/42B mid-bass section utilizes four high-efficiency, low-distortion DL10X 10-inch mid-bass drivers coupled to a unique phase plug (U.S. Patent No. 4,718,517). An Aperiodic Enhancer™, this phase plug extends the upper-end response by making use of the fact that only the apex area of the cone near the voice coil is in motion at the higher frequencies, and automatically adjusts the acoustic loading to maximize acoustic output. The output of the four drivers is summed through a mid-bass manifold (U.S. Patent No. 4,923,021) and coupled to a 60° x 40° constant-directivity horn. A 60° x 40° mid-bass pattern is utilized to make a smooth transition to the mid-frequency horn. (Because of its small size, the coverage pattern of the 40° x 20° mid-frequency horn widens at

MTH-4.5/42B SPECIFICATION GRAPHICS

FIGURE 1 — Axial Frequency Response

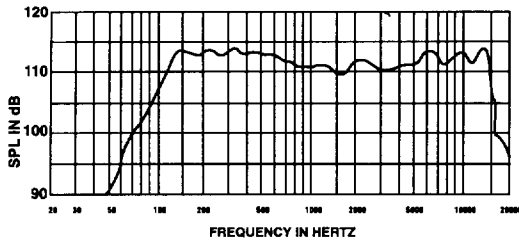

FIGURE 2 — Impedance vs. Frequency

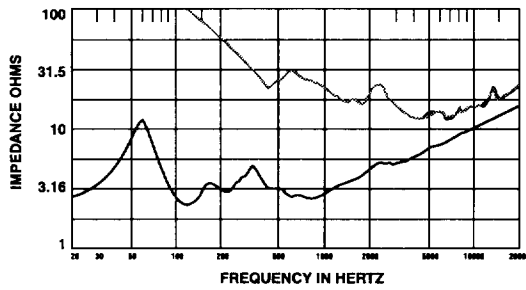

FIGURE 3 — Polar Response

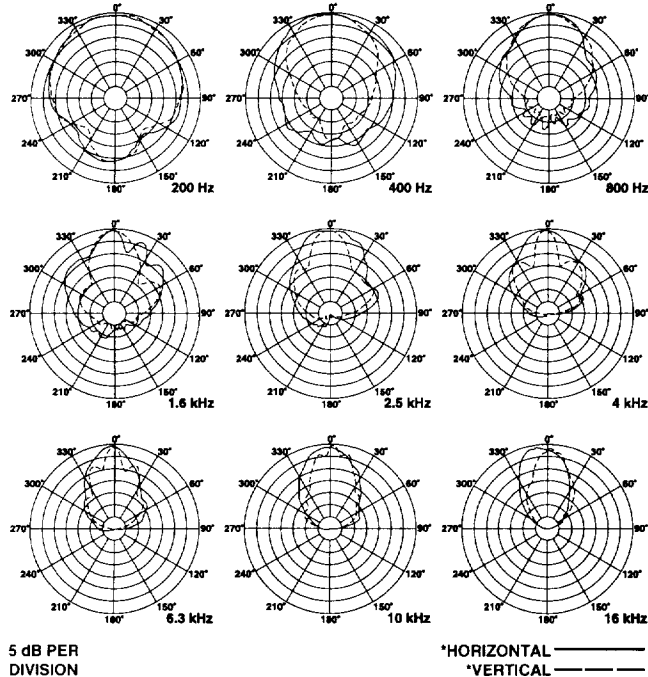
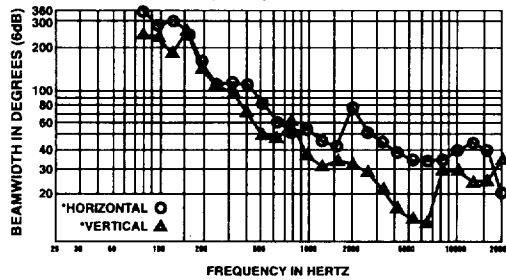

FIGURE 4 — Beamwidth vs. Frequency



*Long horn axis vertical

FIGURE 5 — Directivity vs. Frequency

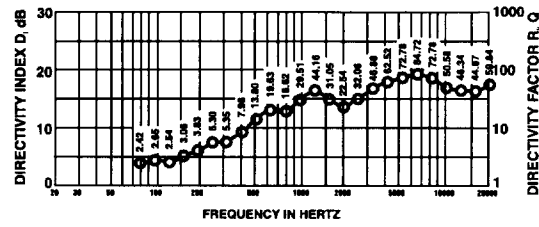

FIGURE 6 — Harmonic Distortion

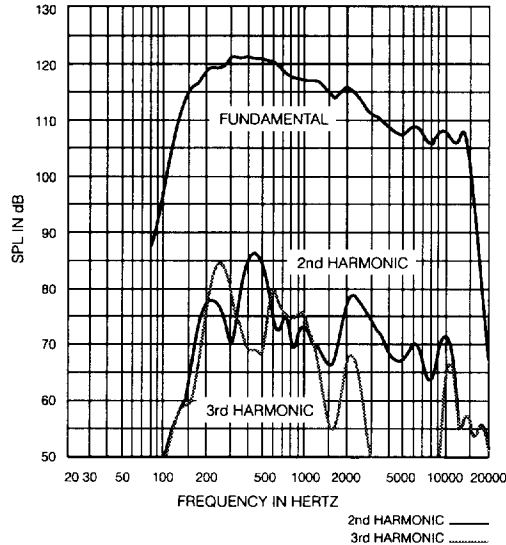
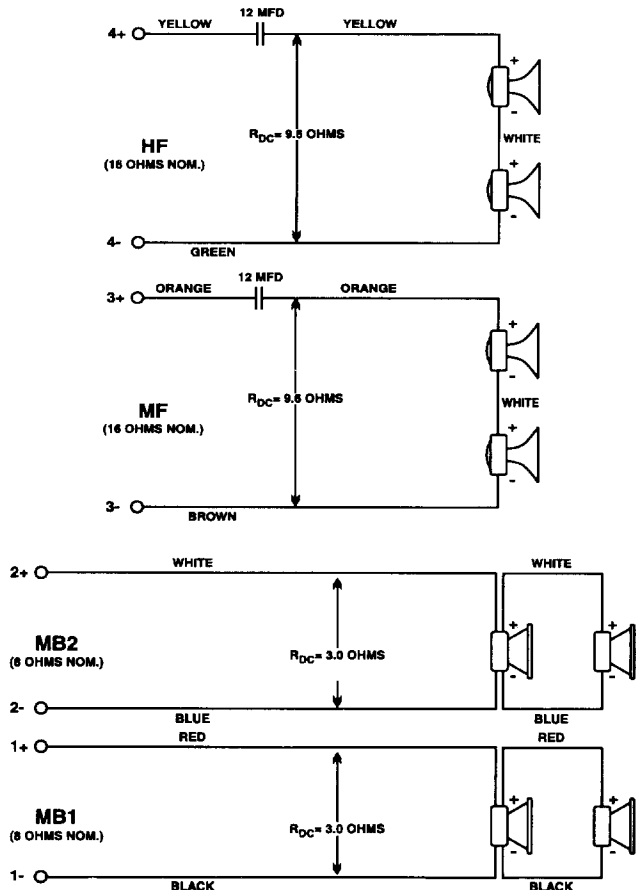

FIGURE 7 — Wiring Diagram



lower frequencies, approaching 60° x 40° at the mid-bass/mid-frequency crossover point.)

The MTH-4.5/42B mid-frequency section contains two DH2AS1 compression drivers manifolded onto a 40° x 20° constant-directivity horn. The DH2AS1 (1.375-inch bolt-on version of the DH2A) features a powerful motor structure and titanium diaphragm for maximum linear acoustic output, extended high-frequency response and accurate transient response. The two drivers are coupled to an HPD42 dual-throat constant-directivity, TransPlanar™ horn. The dual-throat design maintains the vertical horn height required for vertical pattern control while minimizing the horn length.

The MTH-4.5/42B high-frequency section is identical to the mid-frequency section, containing two DH2AS1 compression drivers coupled to an HPD42 dual-throat, 40° x 20° constant-directivity horn. The use of the same horn and driver in the mid- and high-frequency sections ensures identical coverage patterns and minimizes path-length differences between the two frequency bands.

All versions of the MTH-4.5/42B are constructed of 0.75-inch thick, 14-ply birch plywood and are extremely well braced to survive the rigors of the road. The MTH-4.5/42BCF (flying) and MTH-4.5/42B (nonflying) systems are covered with black Ozite Super TNT carpeting, the most rugged in the industry. For permanent installation applications, the MTH-4.5/42BPF (flying) and MTH-4.5/42B (nonflying) systems are available with a black textured paint finish. The MTH-4.5/42BCF (carpeted) and MTH-4.5/42BPF (painted) systems incorporate a two-point flying system. All models feature a black nylon cloth grille. The RD-1 removable dolly is available for use with the carpeted MTH-4.5/42BCF and MTH-4.5/42BC systems for portable applications.

APPLICATIONS

The MTH-4.5/42B is ideal for any professional concert-sound or permanent-installation application requiring high sound pressure levels with low distortion from a compact enclosure. The Manifold Technology® design maximizes the acoustic output per enclosure frontal area, acoustic output per enclosure bulk volume, and acoustic output per enclosure weight of the loudspeaker system. This enables loudspeaker arrays to be constructed that are significantly smaller and lighter than would be obtainable with conventional loudspeaker-systems. The MTH-4.5/42B may be combined with other members of the MT-4 and MT-2 loudspeaker family, providing the array designer a variety of coverage angles, acoustic output and enclosure sizes from which to choose. For full-range applications, the MTH-4.5/42B may be combined with any of the MTL-4B or MTL-2B low-frequency sound reinforcement systems. (The MTL-4B is a low-frequency system with a rectangular enclosure that is dimensionally identical to the MTH-4.5/42B.) For optimal acoustic performance of the MT loudspeaker systems, the Electro-Voice Dx34 digital electronic crossover/equalization/signal-delay/limiter unit is recommended.

Careful attention was paid to details to provide both the touring company and sound contractor a convenient and time-saving sound reinforcement package. The MTH-4.5/42B dimensions were chosen for efficient truck pack and high-

density array design. The systems may be stacked three high and three wide in a standard truck box, enabling 14,000 watts of sound system to be accommodated in only three feet of truck-floor length. The two-point rigging system offers flexible array design and efficient assembly. To facilitate service, a variety of screws, washers and hex key wrenches are provided with each loudspeaker system. In addition, there are wiring diagram labels in convenient locations inside the enclosure.

FREQUENCY RESPONSE

The MTH-4.5/42B frequency response (shown in Figure 1) was measured on axis in the far field in an anechoic environment using a swept sine-wave signal. The Dx34 digital electronic unit was used to provide the necessary crossover filters, equalization and signal delay. No high-pass crossover filters were applied to the low end of the mid-bass section. One watt of power (2.00 volts rms at 500 Hz) was applied to the mid band of the mid-bass section. The sound pressure level was normalized for an equivalent one-meter distance.

DIRECTIVITY

The directional response of the MTH-4.5/42B was measured in an anechoic environment at a distance of 6.1 meters (20 feet) using 1/3-octave filtered pink noise. A full spherical measurement system was used. The Dx34 digital electronic unit was used to provide the necessary crossover filters, equalization and signal delay. The polar response of the loudspeaker system at selected 1/3-octave frequencies is shown in Figure 3. The frequencies selected are fully representative of the polar response of the system. The beamwidth of the system utilizing the complete 1/3-octave polar data is shown in Figure 4. The directivity factor (Q), R_p , and directivity index, D_i , are shown in Figure 5. Complete AcoustaCADD™ data is available for the MTH-4.5/42B loudspeaker system.

DISTORTION

Distortion for the MTH-4.5/42B (shown in Figure 6) was measured on axis in the far field in an anechoic environment with an input signal that would result in a sound pressure level of 120 dB at one meter. The Dx34 digital electronic unit was used to provide the necessary crossover filters, equalization and signal delay. A 24-dB-per-octave high-pass crossover filter at 160 Hz was applied to the low end of the mid-bass section. A frequency spectrum typical of close-miked rock music was employed. The sound pressure level was normalized for an equivalent one-meter distance. Plots of second- and third-harmonic distortion are shown referenced to the fundamental.

POWER-HANDLING CAPACITY

Electro-Voice components and systems are manufactured to exacting standards to ensure reliability in continuous use in arduous real-life conditions. Besides utilizing industry-standard power tests, extreme in-house power tests which push the performance boundaries of the loudspeakers are also performed for an extra measure of reliability. The MT systems are rated per the EIA Loudspeaker Power Rating, Full Range (ANSI/EIA RS-426-A 1980), which uses a shaped random-noise signal to simulate typical music to test the mechanical and thermal capabilities of the loudspeakers. The Dx34 digital electronic unit was used to provide the necessary crossover filters and equalization

during power testing. Specifically, the MTH-4.5/42B passes the EIA RS-426-A 1980 power test with the following test parameters:

Mid-bass Section (MB1 & MB2 paralleled):

$P_{E(MAX)}$: 1,200 watts
Test Voltages: 45.5 volts rms
91.0 volts peak
 R_{SR} (1.15 x R_E): 1.73 ohms

Mid-Frequency Section:

$P_{E(MAX)}$: 120 watts
Test Voltages: 36.4 volts rms
72.8 volts peak
 R_{SR} (1.15 x R_E): 11.0 ohms

High-Frequency Section:

$P_{E(MAX)}$: 120 watts
Test Voltages: 36.4 volts rms
72.8 volts peak
 R_{SR} (1.15 x R_E): 11.0 ohms

CROSSOVER, EQ AND SIGNAL DELAY

The usable frequency ranges of the individual MTH-4.5/42B sections are 150-2,000 Hz for the mid-bass section, 1,200-20,000 Hz for the mid-frequency section and 6,000-20,000 for the high-frequency section. Crossover frequencies of 160, 1,600 and 8,000 Hz with 24-dB-per-octave slopes are recommended. For full-range applications, the MTL-4B low-frequency loudspeaker system is recommended for use with the MTH-4.5/42B. For optimal acoustic performance, the Electro-Voice Dx34 digital electronic crossover/equalization/signal-delay unit is recommended.

The Dx34 is a programmable, two-in/four-out digital electronic unit which may be configured for stereo two-way, mono three-way plus subwoofer, or mono four-way operation. Each output section includes crossover filters, equalization, limiting, signal delay, polarity and gain adjustment; the parameters of which all may be programmed and stored by the user. In the mono four-way configuration, the Dx34 includes a factory preset for optimal performance of the MT-4.5/42B loudspeaker system (the MTH-4.5/42B and MTL-4B systems combined) that utilizes Linkwitz-Riley 24-dB-per-octave crossover filters at 160, 1,600 and 8,000 Hz. Each output section has equalization specifically matched to the loudspeaker system, and signal delay set to achieve zero lobing error and time alignment between frequency bands. In addition, the output levels of each frequency band are set so that, with the output level controls set in the zero-dB position, the loudspeaker system will have a flat frequency response in an anechoic environment when used with amplifiers having identical gain.

ELECTRICAL CONNECTION AND SYSTEM WIRING

Electrical connections to the MTH-4.5/42B are made on the back of the enclosure via an 8-pin connector. There are two connectors on the input panel to allow paralleling of other MTH-4.5/42B systems. The Neutrik Speakon® NL8MPR is used for both connections. One mating Neutrik Speakon® NL8FC cable-end connector is supplied with each loudspeaker system. The pin assignments are as follows:

Pin 1+:	MB1 (+)	Pin 1-:	MB1 (-)
Pin 2+:	MB2 (+)	Pin 2-:	MB2 (-)
Pin 3+:	MF (+)	Pin 3-:	MF (-)
Pin 4+:	HF (+)	Pin 4-:	HF (-)

The mid-bass section has four 8-ohm drivers; however, the acoustic loading of the phase plugs and horn increases their electrical impedance to a nominal 16 ohms each. These four drivers are wired in parallel pairs, resulting in two nominal 8-ohm loads, with one pair connected to Pins 1+/1- and the other pair to Pins 2+/2-. The mid-frequency section has two 8-ohm drivers wired in series, resulting in a single 16-ohm nominal load connected to Pins 3+/3-. The high-frequency section also has two 8-ohm drivers wired in series for a single 8-ohm nominal load connected to Pins 4+/4-. A wiring diagram of the loudspeaker system is shown in Figure 7. The electrical impedance versus frequency is shown in Figure 2.

FLYING THE MT SYSTEMS

A manual entitled the *MT Flying Manual* is available from Electro-Voice, and is included with each flying MT loudspeaker system. A brief introductory overview is included here. The *MT Flying Manual* should be consulted for complete structural specifications and detailed information on safely suspending and using the MT systems.

The MTH-4.5/42BCF (carpeted) and the MTH-4.5/42BPF (painted) are versions of the MTH-4.5/42B loudspeaker system that include flying hardware. The MT systems incorporate a unique two-point flying system that permits a wide range of vertical angle adjustment, and offers maximum flexibility in array design and implementation for both touring sound and permanent installations. The quick-release, aircraft L-track-type hardware design allows arrays of loudspeakers to be assembled (and disassembled) very quickly, and offers such flexibility in the vertical angling of cabinets that pull-up points are usually unnecessary. Furthermore, all of the flying MT-4 and MT-2 loudspeaker models include the same rigging hardware, allowing the different models to be mixed as necessary throughout an array.

The rigging track accepts New Haven NH 32102-1 type double-stud ring fittings. Individual rigging points have typical break-strength ratings of 3,750-4,000 pounds, which translates to working-load ratings of 750-800 pounds for a 5:1 safety factor. (Consult the *MT Flying Manual* for specific structural strength ratings and limitations.) The enclosures may be oriented with the rigging track on the sides of the enclosure, or on the top and bottom, and may be daisy chained together as long as the safety factor is 5:1 or greater, and local regulations are met. Electro-Voice offers a line of flying-hardware accessories for use with the MT loudspeaker systems.

CAUTION: the MT loudspeaker systems should be suspended overhead only in accordance with the procedures and limitations specified in the *MT Flying Manual* and manual update notices.

FIELD SERVICE

In the unlikely event that the MTH-4.5/42B should require service, the mid-bass drivers can be accessed by removing the back of the enclosure using a #2 Phillips screwdriver. The mid-bass drivers can be unbolted using a 5/32-inch hex-key wrench, and can be lifted away from the baffle board and slid out around the phase plugs. There is a wiring diagram label for the mid-bass section located on the back of the

enclosure near the drivers. The mid- and/or high-frequency drivers can be accessed by removing the grille using a #2 Phillips screwdriver, and removing the MF/HF horn baffle using a 5/32-inch hex-key wrench. The mid- and high-frequency drivers can be unbolted from the horns manifold using a 5/32-inch hex-key wrench. There is a wiring diagram label for the mid- and high-frequency section located on the horn-baffle assembly near the drivers. As a further service convenience, a hardware kit that includes a 5/32-inch hex key and an assortment of spare screws and washers is included with every MTH-4.5/42B loudspeaker system.

Failure of the 10-inch mid-bass driver will require the entire driver to be returned to an authorized Electro-Voice service center for repair. A mid- or high-frequency-driver failure can be repaired in the field by replacing the diaphragm assembly; or, if desired, the entire driver can be returned to an authorized service center for repair. The following service parts are available from the Service Department in Buchanan, Michigan:

MTH-4.5/42B Service Data Sheet: #532483
HF: #81161-XX 8-ohm DH2A Diaphragm Kit
#832-2499 DH2AS1 Driver
MF: #81161-XX, 8-ohm DH2A Diaphragm Kit
#832-2499 DH2AS1 Driver
MB: #810-1491 DL10X Driver

ARCHITECTS' AND ENGINEERS' SPECIFICATIONS

The loudspeaker system shall be a three-way active mid-bass/mid-frequency/high-frequency system. The mid-bass section shall operate from 150-2,000 Hz with a sensitivity of 109 dB for one watt at one meter, and consist of four 10-inch cone drivers, each individually coupled to a mid-bass phase plug, then collectively manifolded and coupled to a 60° x 40° constant-directivity horn, have a total input impedance of 4 ohms, and have a power rating of 1,200 watts as per ANSI EIA RS-426-A 1980. The mid-frequency section shall operate from 1,200-20,000 Hz with a sensitivity of 116.5 dB for one watt at one meter, and consist of two compression drivers coupled to a dual-throat 40° x 20° constant-directivity horn, have a total input impedance of 16 ohms, and have a power rating of 120 watts as per ANSI EIA RS-426-A 1980. The high-frequency section shall operate from 1,200-20,000 Hz with a sensitivity of 112 dB for one watt at one meter, and consist of two compression drivers coupled to a dual-throat 40° x 20° constant-directivity horn, have a total input impedance of 16 ohms, and have a power rating of 120 watts as per ANSI EIA RS-426-A 1980. The overall system shall have a uniform on-axis frequency response from 150-20,000 Hz, and shall have a nominal horizontal beamwidth of 40° and a nominal vertical beamwidth of 20°. The loudspeaker system shall have an enclosure constructed from 0.75-inch thick, 14-ply birch plywood, be finished with a black carpet (or a black textured paint), have a black nylon grille, and have a two-point rigging system that will accept New Haven NH 32102-1 type double-stud ring fittings (if applicable). The loudspeaker enclosure shall be 91.4 cm (36.00 in.) high, 91.4 cm (36.00 in.) wide and 75.9 cm (29.88 in.) deep, and shall weigh 161 kg (354 lb). The loudspeaker system shall be the Electro-Voice MTH-4.5/42B (MTH-4.5/42BCF, MTH-4.5/42BC, MTH-4.5/42BPF or MTH-4.5/42BP).

UNIFORM LIMITED WARRANTY

Electro-Voice products are guaranteed against malfunction due to defects in materials or workmanship for a specified period, as noted in the individual product-line statement(s) below, or in the individual product data sheet or owner's manual, beginning with the date of original purchase. If such malfunction occurs during the specified period, the product will be repaired or replaced (at our option) without charge. The product will be returned to the customer prepaid. **Exclusions and Limitations:** The Limited Warranty does not apply to: (a) exterior finish or appearance; (b) certain specific items described in the individual product-line statement(s) below, or in the individual product data sheet or owner's manual; (c) malfunction resulting from use or operation of the product other than as specified in the product data sheet or owner's manual; (d) malfunction resulting from misuse or abuse of the product; or (e) malfunction occurring at any time after repairs have been made to the product by anyone other than Electro-Voice or any of its authorized service representatives. **Obtaining Warranty Service:** To obtain warranty service, a customer must deliver the product, prepaid, to Electro-Voice or any of its authorized service representatives together with proof of purchase of the product in the form of a bill of sale or receipted invoice. A list of authorized service representatives is available from Electro-Voice at 600 Cecil Street, Buchanan, MI 49107 (616/695-6831 or 800/234-6831). **Incidental and Consequential Damages Excluded:** Product repair or replacement and return to the customer are the only remedies provided to the customer. Electro-Voice shall not be liable for any incidental or consequential damages including, without limitation, injury to persons or property or loss of use. Some states do not allow the exclusion or limitation of incidental or consequential damages so the above limitation or exclusion may not apply to you. **Other Rights:** This warranty gives you specific legal rights, and you may also have other rights which vary from state to state.

Electro-Voice Speakers and Speaker Systems are guaranteed against malfunction due to defects in materials or workmanship for a period of five (5) years from the date of original purchase. The Limited Warranty does not apply to burned voice coils or malfunctions such as cone and/or coil damage resulting from improperly designed enclosures. Electro-Voice active electronics associated with the speaker systems are guaranteed for three (3) years from the date of original purchase. Additional details are included in the Uniform Limited Warranty statement.

Electro-Voice Flying Hardware (including enclosure-mounted hardware and rigging accessories) is guaranteed against malfunction due to defects in materials or workmanship for a period of one (1) year from the date of original purchase. Additional details are included in the Uniform Limited Warranty statement.

Electro-Voice Accessories are guaranteed against malfunction due to defects in materials or workmanship for a period of one (1) year from the date of original purchase. Additional details are included in the Uniform Limited Warranty statement.

Service and repair address for this product: Electro-Voice, Inc., 600 Cecil Street, Buchanan, Michigan 49107 (616/695-6831 or 800/234-6831).

Specifications subject to change without notice.



ELECTRO-VOICE a MARK IV company 600 Cecil Street, Buchanan, Michigan 49107

MANUFACTURING PLANTS AT ■ BUCHANAN, MI ■ NEWPORT, TN ■ SEVIERVILLE, TN ■ OKLAHOMA CITY, OK ■ GANANOQUE, ONT.
© Electro-Voice, Inc. 1996 ■ Litho in U.S.A. Part Number 533172 — 9609