

FR12-2B

Two-Way, Constant-Directivity Speaker System

- THX® approved for cinema surround application
- High output—complements the potential of digital surround on film
- 96-dB sensitivity
- 100 watts long-term power capacity
- Smooth, extended response
- ISO-2969 treble roll-off
- Easy suspension
- OmniMount® Series 100 mounting system compatible¹
- Black finish

SPECIFICATIONS

Axial Frequency Response (swept sine wave, 4 volts at 10 feet on axis, anechoic environment, normalized for 1 watt/1 meter; see Figure 1):

80-18,000 Hz

Low-Frequency 3-dB-Down Point:

80 Hz

Usable Low-Frequency Limit

(10-dB-down point):

50 Hz

Half-Space Reference Efficiency:

2.3%

Long-Term Average Power-Handling Capacity (per ANSI/EIA RS-426-A 1980; see Power-Handling Capacity section):

100 watts

Maximum Woofer Acoustic Output:

2.3 watts

Sensitivity (SPL at 1 m, 1 W into nominal impedance, anechoic environment, band-limited pink-noise signal, 100-15,000 Hz):

96 dB

Beamwidth (angle included by 6-dB-down points on polar responses, horizontal and vertical planes, indicated one-third-octave bands of pink noise; see Figure 4),

250-500 Hz:

150° ±30°

500-10,000 Hz:

100° ±20°

10,000-18,000 Hz:

60° ±12°

Directivity Factor D_p (Q), 800- to 16,000-Hz Median (see Figure 5):

10 (+12.5, -4.5)

Directivity Index D_i , 800- to 16,000-Hz Median (see Figure 5):

10 dB (+3.5 dB, -2.5 dB)

Phase Variation, 300-3,000 Hz:

±30°

Distortion, 0.1 Full Power Input (see Figure 6),

Second Harmonic,

100 Hz: <1%

1,000 Hz: 4%

10,000 Hz: 3%

Third Harmonic,

100 Hz: 1%

1,000 Hz: <1%

10,000 Hz: <1%

Distortion, 0.01 Full Power Input

Second Harmonic,

100 Hz: <.5%

1,000 Hz: 1%

10,000 Hz: 1.5%

Third Harmonic,

100 Hz: <1%

1,000 Hz: <1%

10,000 Hz: 1%

Transducer Complement:

12-inch woofer; 1½-inch Super-Dome™ tweeter coupled to 9-inch Direktor™

Box Tuning Frequency:

48 Hz

Crossover Frequency:

1,500 Hz

Crossover Slope:

12 dB per octave

Impedance,

Nominal:

8 ohms

Minimum:

6.5 ohms

Input Connections:

Screw terminals (#10) on barrier strip

Enclosure Materials and Colors:

Paintable, black vinyl-clad enclosure constructed of ProWood™ and particle board

Grille:

Black cloth

Suspension (see Suspending the FR12-2B section):

WCB-1 universal hanging bracket

WCB-2 cinema wall bracket

OmniMount® Series 100 support system¹

Optional Accessories:

WCB-1 universal hanging bracket

WCB-2 cinema wall bracket

Dimensions,

Height:

64.8 cm (25.50 in.)

Width:

41.9 cm (16.50 in.)

Depth:

22.2 cm (8.75 in.)

Net Weight:

20.8 kg (46 lb)

Shipping Weight:

22.6 kg (50 lb)

DESCRIPTION

The Electro-Voice FR12-2B is a black, compact, two-way, high-efficiency, constant-directivity speaker system with user-selectable frequency compensation for ISO-2969. Its primary intended application is for high-quality surround sound in premium cinema installations. The FR12-2B is THX® approved and has been designed with the rigors of a digital signal source in mind.² If the "flat" response (see Selecting Frequency Response section) is selected, the system can be used for general sound reinforcement in churches and small auditoriums. High-quality, professional-level components are used throughout the design, including a 100° x 100° Direktor™ horn coupled to a Super-Dome™ high-frequency driver and a professional-grade 12-inch woofer. The black

1. OmniMount® is a registered trademark of OmniMount Systems, Inc.

2. THX® is a registered trademark of Lucasfilm Ltd.

FR12-2B SPECIFICATION GRAPHICS

FIGURE 1 — Axial Frequency Response
(with APX-200 equalizer, anechoic environment,
1 watt at 1 meter)

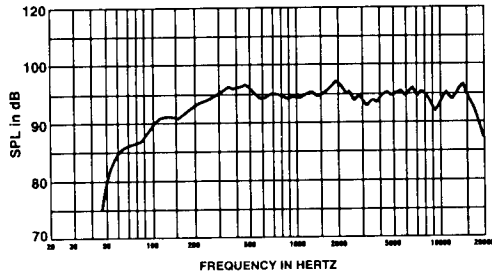

FIGURE 2 — Axial Frequency Response
(with ISO-2969 compensation,
anechoic environment, 1 watt at 1 meter)

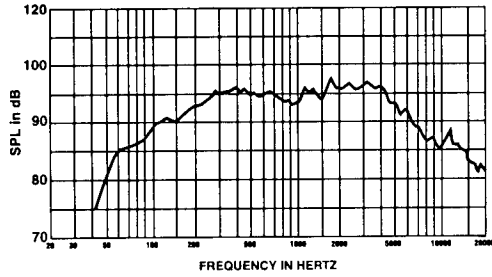

FIGURE 3 — One-Third-Octave Polar Response
(anechoic environment)

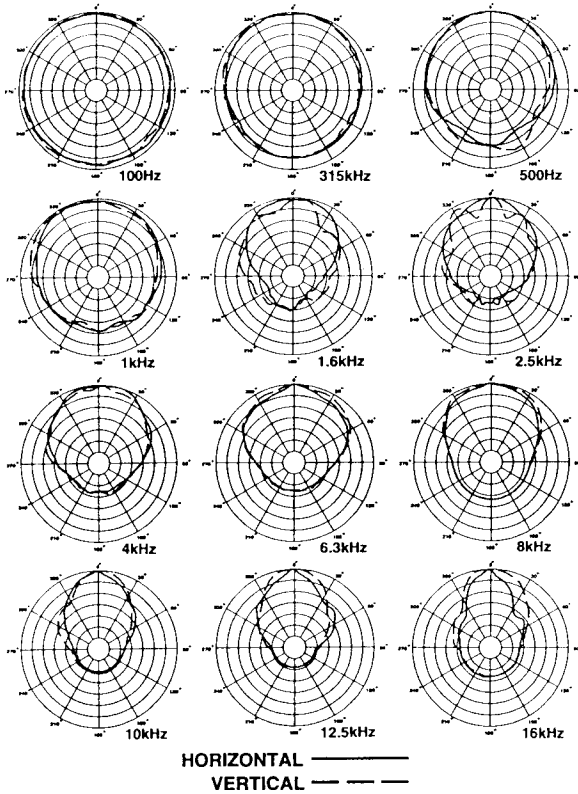

FIGURE 4 — Beamwidth vs. Frequency (anechoic environment)

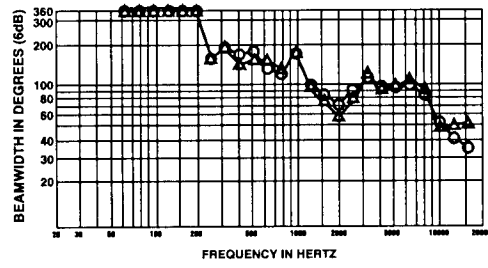

FIGURE 5 — Directivity vs. Frequency (anechoic environment)

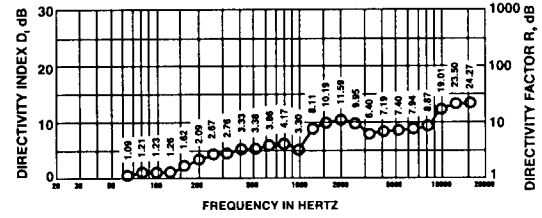
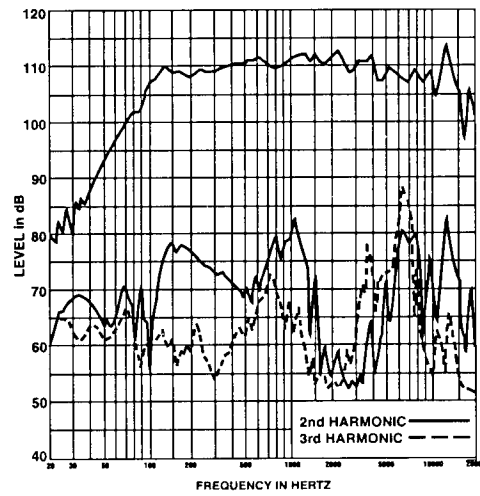

FIGURE 6 — Harmonic Distortion, 0.1 Rated Power Input
(10 watts)



FR12-2B SPECIFICATION GRAPHICS

FIGURE 7— Mounting the FR200B Using the WCB-1 Bracket

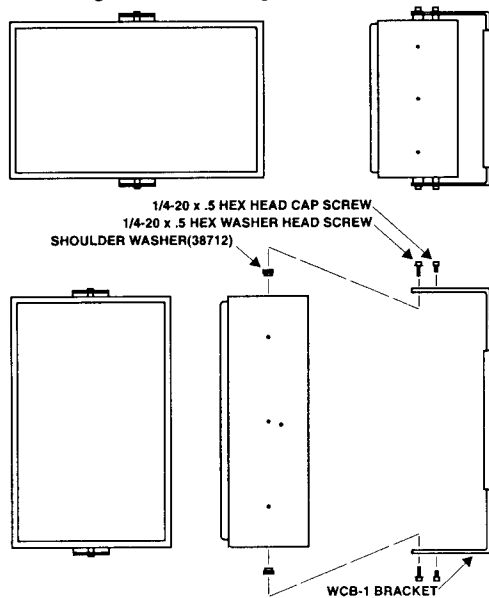
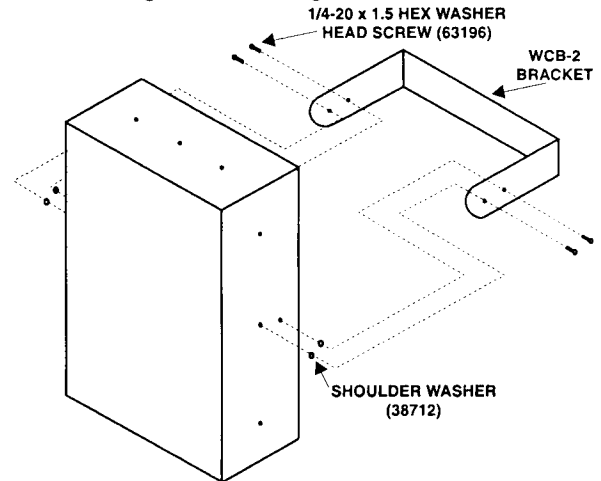

FIGURE 8 — Mounting the FR200B Using the WCB-2 Bracket



oak-grain vinyl has been selected to blend into most interior design concepts and is complemented with a removable black cloth grille. The black surface is a proprietary vinyl laminate which can be painted or stained to match any decorative environment (see Finishing section).

A second-order (12-dB-per-octave) crossover at 1,500 Hz is used to separate the two frequency sections and provide equalization for the Super-Dome™ and the Direktor™ horn. The bass section was designed for efficient low-end performance in a compact enclosure.

CONSTANT-DIRECTIVITY SPEAKER SYSTEM

The crossover frequency and speaker component geometries have been carefully selected so that the directional characteristics of the woofer and Direktor match at the crossover frequency (approximately 100 degrees circular coverage patterns for each) to create a special system type—the constant-directivity system. At higher frequencies, the horizontal and vertical coverage pattern remains essentially constant. Response within the 100° x 100° rated coverage angle is uniform, which means dependable audience coverage without “hot spots” or dead zones at certain frequencies. The 100° x 100° dispersion characteristic permits this small system to be used horizontally or vertically to aesthetically best suit the environment in which it is placed without changing the coverage angles. The controlled directivity of the high- and low-frequency transducers also eliminates response irregularities caused by diffraction off enclosure edges and, in combination with an essentially flat on-axis frequency response, produces a total acoustic power output that is uniform with frequency.

FREQUENCY RESPONSE

The FR12-2B axial frequency response was measured in Electro-Voice’s large anechoic chamber at a distance of 10 feet with a swept sine-wave input. Figure 1 shows the FR12-2B with the jumper in the “flat” mode. Figure 2 shows the FR12-2B without the jumper in the “ISO-2969” mode. Both figures have been normalized for 1 watt at 1 meter.

EQUALIZATION

The FR12-2B can be “equalized” in different ways:

1. No external equalization in “flat” mode. Ideal for high-level, high-quality voice reinforcement where extended bass response is not a requirement.
2. In “ISO-2969” mode for motion picture theatre applications. The high-frequency driver is tailored to match the response specified in ISO-2969 (see Figure 2).

DIRECTIVITY

The directional characteristics of the FR12-2B were measured in Electro-Voice’s large anechoic chamber. The test signal was one-third-octave filtered pink noise at the frequencies indicated. A full spherical measurement system was used, which is compatible with the AcoustaCADD™ computer-aided design program. All directional information was measured at 20 feet.

Figure 3 illustrates the horizontal and vertical polar responses.

Figure 4 shows the horizontal and vertical beamwidths. Beamwidth is the angle at which the horizontal and vertical polar responses have decreased in level by 6 dB when compared with the axial frequency response.

Figure 5 illustrates the total directivity of the FR12-2B. The directivity factor $R_0(Q)$ is the relative value, at a point, of the FR12-2B when compared to an ideal spherical response. The directivity index, D_i , is calculated by $D_i = 10 \log_{10} R_0$.

POWER-HANDLING CAPACITY

To our knowledge Electro-Voice was the first U.S. manufacturer to develop and publish a power test closely related to real-life conditions. A random-noise input signal is used because it contains many frequencies simultaneously, just like real voice or instrument program. The signal contains more energy at extremely high and low frequencies than typical actual program, adding an extra margin of reliability. The test combines not only the overall “long-term average” or “continuous” level—which our ears interpret as loudness—but also short-duration peaks which are many times higher than average, just like actual program. The long-term average level stresses the speaker thermally (heat). The instantaneous peaks test mechanical reliability (cone excursion). Note that the sine-wave test signals sometimes used have a much less demanding peak value relative to their average level. In actual use, long-term average levels exist from several seconds on up, but we apply the long-term average for several hours, adding another extra measure of reliability.

Specifically, the FR12-2B is designed to withstand the power test described in ANSI/EIA RS-426-A 1980. The EIA test spectrum is applied for eight hours. The spectrum is obtained by filtering white noise (a particular type of random noise with equal energy per bandwidth). The filter applies a 6-dB-per-octave roll-off below 40 Hz and above 318 Hz. When measured with a one-third-octave constant-percentage analyzer, this filter produces a spec-

trum whose 3-dB-down points are at 100 Hz and 1,200 Hz with a 3-dB-per octave slope above 1,200 Hz. This shaped signal is fed to the power amplifier with the continuous power set to provide 100 watts into the 6.0-ohm EIA equivalent impedance (24.5 volts rms).

Amplifier clipping sets instantaneous peaks at 6 dB above the continuous power or 400 watts peak (49.0 volts peak). This procedure provides a rigorous test of both thermal and mechanical failure modes.

USE IN MOTION PICTURE THEATRES

The FR12-2B has a number of features which make it particularly suitable for use in cinema surround sound. It is THX® approved when used in its selectable ISO-2969 mode. It is black to complement most theater interiors. The WCB-2 U-bracket provides a cost-effective and safe method of suspending the FR12-2B at the correct (15°) angle. The high dynamics and high power handling offered by professional-grade components make it especially suitable for digital signals.

SELECTING FREQUENCY RESPONSE

It is assumed that the FR12-2B will be used in a motion-picture, THX®-approved situation, so it is shipped with the ISO-2969 high-frequency response in place. If a "flat" response is required, the jumper on the input panel must be connected across the two marked terminals.

SUSPENDING THE FR12-2B

The FR12-2B is fitted with a number of 1/4-20 threaded inserts and can be suspended in several ways:

1. WCB-2 is a U-bracket designed specifically for the FR12-2B when being used in a cinema installation. It supports the FR12-2B vertically and can be locked at an angle of 15° (see Figure 8).
2. WCB-1 is a universal U-bracket designed to allow the suspension of the FR12-2B system at any angle and any orientation from the wall or ceiling (see Figure 7).
3. OmniMount® Series 100 support system. Four 1/4-20 threaded inserts are located in the rear panel to allow the use of the OmniMount® Series 100 support system. A safety chain should be used to ensure safe operation. (Obtain OmniMount® specifications for full instructions.)

It is the responsibility of the installer to ensure the integrity of the mounting surface. The grille of the FR12-2B is securely attached on the front of the cabinet with four screws.

FINISHING

Finishing the FR12-2B is simple and straightforward as long as the following points are understood:

1. ProWood™ has been tested with a large number of commercially available paints with 100% success. However, it is impossible to test every paint available. Electro-Voice

therefore recommends that you test a small area on the rear of the cabinet or under the grille to check that there are no adverse effects.

2. Ensure the surface is clean and free of grease (use soapy water if necessary).
3. Any latex, enamel or acrylic-based paint can be used. The special top layer of ProWood was developed in conjunction with Pittsburgh Paints. They developed their Manor Hall® Exterior House series of paints to complement the ProWood.³ Electro-Voice recommends the use of these paints in adverse or tough situations.
4. Water-based latex paints, in particular, can take a considerable time to dry fully. They can be handled in a few hours, but full strength may not be achieved for a week, particularly in damp or cool conditions.
5. The paint can be applied with a brush, roller or spray. Care should be taken not to get paint on the woofer cone.
6. Stain can be used to highlight the grain in the ProWood or match real wood. But the black surface must be initially painted a light color. Care should be taken when using stain because it is impossible to refinish the material after staining. A good approach is to use a stained varnish, but be careful. It is very difficult to lighten a stain.

ARCHITECTS' AND ENGINEERS' SPECIFICATIONS

The loudspeaker system shall be a two-way, full-range design consisting of an 12-inch woofer, a 1 1/2-inch Super-Dome™ tweeter coupled to a 9-inch, 100° x 100° Direktor™ constant-directivity horn, and a passive crossover network installed in a ProWood™/particle-board enclosure with a black cloth grille. Finish shall be paintable black vinyl.

The system shall have a crossover point of 1,500 Hz and have a nominal impedance of 8 ohms. Usable frequency range shall extend from 80 Hz to 18,000 Hz, with the frequency response selectable to match the ISO-2969 standard curve for the electroacoustic response of motion-picture control rooms and indoor theatres. Sensitivity shall be at least 96 dB for a 1 watt input at a distance of 1 meter on axis. Long-term power capacity shall be at least 100 watts, based on ANSI/EIA RS-426-A 1980 for full-range loudspeaker systems.

Input connections shall be #10 screw terminals on a barrier strip. Suspension of the system shall be achieved through the use of the WCB-2 U-bracket (for vertical suspension at 15°), the WCB-1 U-bracket (for suspension at any angle or orientation), or the OmniMount® Series 100 support system; four 1/4-20 threaded inserts shall be located in the rear panel of the speaker enclosure to accommodate the OmniMount hardware.

3. Manor Hall is a registered trademark of Pittsburgh Paints.

Overall dimensions shall be no greater than 64.8 cm (25.50 in.) high by 41.9 cm (16.50 in.) wide by 22.2 cm (8.75 in.) deep. Net weight shall be 20.8 kg (46 lb). The system shall be the Electro-Voice FR12-2B.

UNIFORM LIMITED WARRANTY

Electro-Voice products are guaranteed against malfunction due to defects in materials or workmanship for a specified period, as noted in the individual product-line statement(s) below, or in the individual product data sheet or owner's manual, beginning with the date of original purchase. If such malfunction occurs during the specified period, the product will be repaired or replaced (at our option) without charge. The product will be returned to the customer prepaid. **Exclusions and Limitations:** The Limited Warranty does not apply to: (a) exterior finish or appearance; (b) certain specific items described in the individual product-line statement(s) below, or in the individual product data sheet or owner's manual; (c) malfunction resulting from use or operation of the product other than as specified in the product data sheet or owner's manual; (d) malfunction resulting from misuse or abuse of the product; or (e) malfunction occurring at any time after repairs have been made to the product by anyone other than Electro-Voice or any of its authorized service representatives. **Obtaining Warranty Service:** To obtain warranty service, a customer must deliver the product, prepaid, to Electro-Voice or any of its authorized service representatives together with proof of purchase of the product in the form of a bill of sale or receipted invoice. A list of authorized service representatives is available from Electro-Voice at 600 Cecil Street, Buchanan, MI 49107 (616/695-6831 or 800/234-6831). **Incidental and Consequential Damages Excluded:** Product repair or replacement and return to the customer are the only remedies provided to the customer. Electro-Voice shall not be liable for any incidental or consequential damages including, without limitation, injury to persons or property or loss of use. Some states do not allow the exclusion or limitation of incidental or consequential damages so the above limitation or exclusion may not apply to you. **Other Rights:** This warranty gives you specific legal rights, and you may also have other rights which vary from state to state.

Electro-Voice Speakers and Speaker Systems are guaranteed against malfunction due to defects in materials or workmanship for a period of five (5) years from the date of original purchase. The Limited Warranty does not apply to burned voice coils or malfunctions such as cone and/or coil damage resulting from improperly designed enclosures. Electro-Voice active electronics associated with the speaker systems are guaranteed for three (3) years from the date of original purchase. Additional details are included in the Uniform Limited Warranty statement.

Service and repair address for this product: Electro-Voice, Inc., 600 Cecil Street, Buchanan, Michigan 49107 (616/695-6831 or 800/234-6831).

Specifications subject to change without notice.



ELECTRO-VOICE a MARK IV company **600 Cecil Street, Buchanan, Michigan 49107**

MANUFACTURING PLANTS AT ■ BUCHANAN, MI ■ NEWPORT, TN ■ SEVIERVILLE, TN ■ OKLAHOMA CITY, OK ■ GANANOQUE, ONT.
© Electro-Voice, Inc. 1994 ■ Litho in U.S.A. Part Number 532341 — 9432