

EVX-180A 18-Inch Low-Frequency Reproducer

- Exceptionally resistant to long-term failure in real-world low-bass applications
- Utilizes findings about failure modes not revealed in normal high-power testing
- 1,000 watts continuous program
- Advanced, HeatWick™ design “wicks” away heat from the voice coil
- Long, 4-inch voice coil has nearly twice the surface area of any other woofer, virtually eliminating power compression
- Ribbed, Kevlar® fiber composite cone resists collapse¹

SPECIFICATIONS

Power Handling (see Power Handling Test section):

1000 watts continuous program

Voice Coil Diameter:

100 mm (4.0 in.)

Sensitivity (SPL at 1 W, 1 m)

100-800-Hz Average:

98 dB

Impedance:

8 ohms

Frequency Response:

20-2,000 Hz

Highest Recommended Crossover:

500 Hz

Magnet Assembly Weight:

8.3 kg (18.3 lb)

THIELE-SMALL PARAMETERS

f_s : 29.0 Hz

R_e : 5.0 ohms

Q_{TS} : 0.266

Q_{MS} : 4.00

Q_{ES} : 0.285

V_{AS} : 416 liters (14.7 ft³)

S_D : 0.122 m² (189 in.²)

x_{max} : 6.4 mm (0.25 in.)

Displacement Limit:

49.5 mm (1.95 in.) peak to peak

η_0 : 3.42%

$P_{E(max)}$: 600 watts (EIA RS-426A);

500 watts (continuous sine wave)

DESCRIPTION

The EVX-180A low-frequency transducer is designed for professional sound reinforcement or studio monitoring applications that require maximum output with low distortion.

The EVX-180A woofer provides unprecedented power capacity, linearity and excursion, made possible by the HeatWick™ total-thermal-engineering design. The proprietary HeatWick design actually “wicks” heat away from the voice coil, significantly increasing power handling and long-term reliability. A special frame extension and elongated pole piece provide a metal surface with close proximity to the entire length of the voice coil, providing a major heat-transfer path. Also, the 100-mm (4-in.) diameter voice coil is longer than conventional medium-efficiency woofers to give additional power handling and virtually eliminate dynamic-range power compression.

Additionally, a Flux Demodulation Device (FDD™) reduces distortion in the critical mid band by providing a “short-circuit” effect to prevent amplifier-signal modulation of the static magnetic field. To further increase reliability, PROTEF™, a Teflon®-based coating, is applied to the internal diameter of the FDD and top plate.¹ PROTEF lubricates any rubbing contact and electrically insulates the coil from the FDD and top plate to guard against violent short-term power peaks.

A ribbed, Kevlar® fiber composite cone with an extremely high stiffness-to-weight ratio and exceptional strength gives the EVX-180A increased resistance to cone collapse and deformation, without sacrificing efficiency.¹ A rubber

mounting flange gasket provides a reusable seal for front or rear mounting, completely surrounding the frame flange.

DIRECTIONAL PERFORMANCE

The directional characteristics of the EVX-180A in the TL3512 256-liter (9-ft³) vented enclosure were measured by running a set of polar responses in EV's large anechoic chamber. The test signal was octave-band-limited pseudo-random pink noise centered at the ISO standard frequencies.

The curves show horizontal (side-to-side) dispersion when the enclosure's long axis is vertical. The vertical (up-and-down) polar responses deviate only slightly from the horizontal responses due to box geometry. Typical data is provided in Figures 3 and 4, which indicate 6-dB-down beamwidth versus frequency and directivity factor, respectively, for an EVX-180A in the TL3512 enclosure.

POWER HANDLING TEST

To our knowledge, Electro-Voice was the first U.S. manufacturer to develop and publish a power test closely related to real-life conditions. First, we use a random noise input signal because it contains many frequencies simultaneously, just like real voice or instrument program. Second, our signal contains more energy at extremely high and low frequencies than typical actual program, adding an extra measure of reliability. Third, the test signal includes not only the overall “long-term average” or “continuous” level—which our ears interpret as loudness—but also short-duration peaks which are many times higher than the average, just like actual program. The long-term average level stresses the speaker thermally (heat). The instantaneous peaks test mechanical reliability (cone and diaphragm excursion).

¹ PROTEF™ is covered by U.S. Patent No. 4,547,632; Teflon® and Kevlar® are registered trademarks of DuPont.

FIGURE 1 — Axial Frequency Response, 1 Watt/1 Meter, 10-Cubic-Foot Enclosure

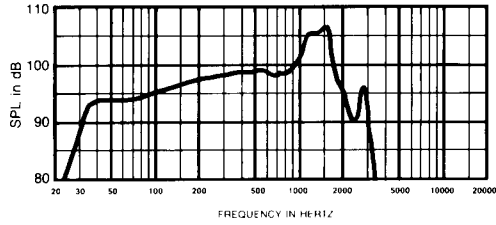

FIGURE 3 — Beamwidth vs. Frequency EVX-180A/TL3512 in a 255-Liter (9.0-ft³) Enclosure

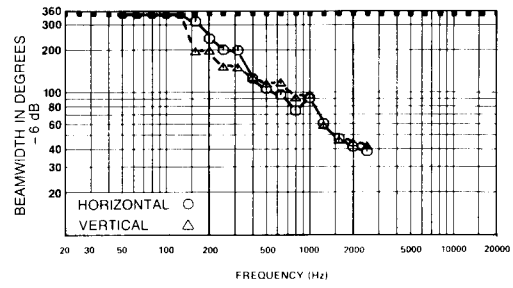

FIGURE 2A — EVX-180A Single-Driver Low-Frequency Performance: 170-Liter (6-ft³) Enclosure

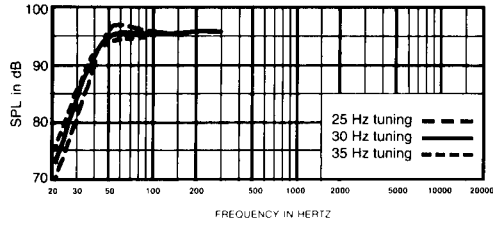

FIGURE 4 — Directivity Index vs. Frequency EVX-180A/TL3512 in a 255-Liter (9.0-ft³) Enclosure

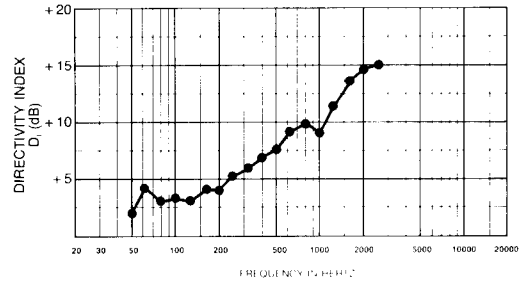

FIGURE 2B — EVX-180A Single-Driver Low-Frequency Performance: 227-Liter (8-ft³) Enclosure

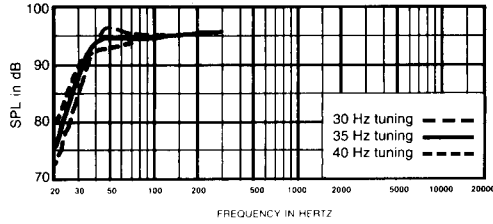

FIGURE 5 — Theoretical Low-Frequency Maximum SPL vs. Frequency, 227-Liter (8-ft³) Enclosure Tuned to 35 Hz

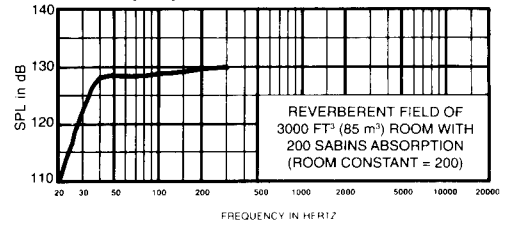

FIGURE 2C — EVX-180A Single-Driver Low-Frequency Performance: 283-Liter (10-ft³) Enclosure

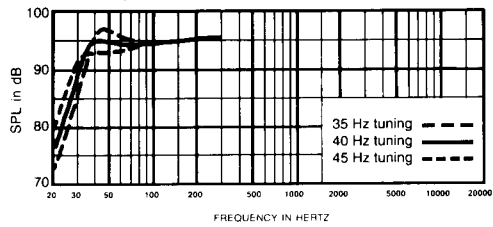

FIGURE 6 — Polar Response

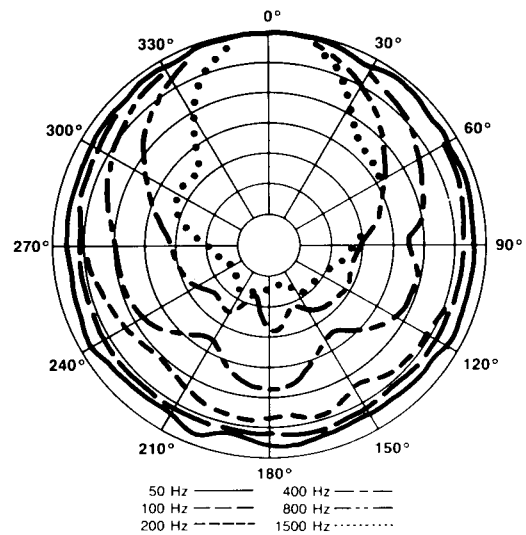

FIGURE 2D — EVX-180A Multiple-Driver Low-Frequency Performance: Two Drivers In a 566-Liter (20-ft³) Box or Two 283-Liter (10-ft³) Boxes in Close Proximity Tuned to 30 Hz

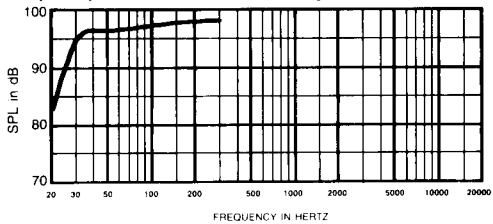
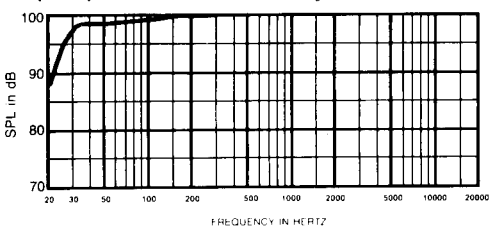

FIGURE 2E — EVX-180A Multiple-Driver Low-Frequency Performance: Four Drivers In a 1,132-Liter (40-ft³) Box or Four 566-Liter (20-ft³) Boxes in Close Proximity Tuned to 28 Hz



Specifically, the EVX-180A is designed to withstand the power test described in EIA Standard RS-426A. The EIA test spectrum is applied for eight hours. To obtain the spectrum, the output of a white noise generator (white noise is a particular type of random noise with equal energy per bandwidth in Hz) is fed to a shaping filter with 6-dB-per-octave slopes below 40 Hz and above 318 Hz. When measured with the usual constant-percentage-bandwidth analyzer (one-third octave), this shaping filter produces a spectrum whose 3-dB-down points are at 100 Hz and 1,200 Hz with a 3-dB-per-octave slope above 1,200 Hz. The signal has a 6-dB crest factor. This procedure provides a rigorous test of both thermal and mechanical failure modes.

The EVX-180A has also been power tested with a two-hour sine wave at minimum impedance so that competitive comparisons can be made using consistent methods. Continuous program power is defined as 3 dB above (double) the continuous sine-wave power rating.

RECOMMENDED ENCLOSURES

The most extended bass, lowest distortion and best control is usually realized in properly designed vented enclosures. In such designs, the vent, or port, actually provides the lowest octave of output. The vent is driven to full acoustic output by a relatively small motion of the speaker cone itself, acting through the air contained within the enclosure. The excursion of the EVX-180A at these frequencies is much reduced compared to sealed or open-back enclosures, directly reducing harmonic distortion and the possibility of speaker "bottoming." Several specific vented-enclosure recommendations are shown on the previous page. Alternate tunings are given so that designers can tailor the low-frequency response to their specific needs. Figure 5 shows the maximum long-term SPL versus frequency. The maximum output is limited by either: (1) the long-term thermal power-handling capacity or (2) the speaker's maximum cone excursion capability, whichever occurs first. Also provided are recommended enclosures for multiple driver configurations.

STEP-DOWN OPERATION

For extra-low bass use, the vent area can be reduced by one-half, thereby tuning the enclosure to the "step-down" mode. In step-down, the tuning frequency is reduced by half an octave (a factor of 0.7). The resulting alignment is then equalized for flat response. This procedure results in one-half octave lower bass (without any excursion penalty).

ARCHITECTS' AND ENGINEERS' SPECIFICATIONS

The low-frequency transducer shall have a nominal diameter of 460 mm (18 in.), overall depth not greater than 198 mm (7.92 in.), and weigh no more than 11 kg (25 lb). The frame shall be made of die-cast aluminum to resist deformation. The magnetic assembly shall have an extended pole piece to reduce inductive variances with excursion, and provide a symmetrical magnetic field at the voice-coil gap. Two aluminum rings shall encircle the pole piece above and below the magnetic gap, and

shall have internal diameters concentric with the internal diameter of the steel top plate. The upper ring shall be part of the loudspeaker frame. Both rings act to reduce flux modulation and provide a heat-transfer path from the outer diameter of the voice coil. The inner diameter of the steel top plate and the lower aluminum ring shall be Teflon® coated.¹

The voice coil shall be 100 mm (4 in.) in diameter and 28 mm (1.1 in.) in winding length, and shall be made of edge-wound aluminum ribbon. When centered in the magnetic gap, the voice coil shall produce a force of not less than 21.9 newtons (tesla-ampere-meters) with a dc current of 1 ampere.

Performance specifications of a typical production unit shall be as follows: measured sensitivity (SPL at 1 m (3.3 ft) with 1-watt input, 100-800-Hz pink noise) shall be at least 96 dB. The half-space reference efficiency shall be at least 3.0%. The usable frequency response shall be 20 Hz to 2,000 Hz, and the nominal impedance shall be 8 ohms. The rated power for the loudspeaker shall be 1,000 watts continuous program power.

The low-frequency transducer shall be the Electro-Voice EVX-180A.

AES SPECIFICATIONS

The following specifications are in accordance with the "AES Recommended Practice for Specification of Components Used in Professional Audio and Sound Reinforcement" (AES2-1984; ANSI S4.26-1984).

Dimension and Weight,

- Outer Diameter:**
46 cm (18.2 in.)
- Depth:**
20 cm (7.92 in.)
- Bolt Hole Diameter:**
7.1 mm (0.281 in.)
- Net Weight:**
11.3 kg (25 lb)
- Shipping Weight:**
14 kg (31 lb)

Mounting

The EVX-180A may be front or rear mounted against either surface of the mounting flange and requires a 422-mm (16.6-in.) diameter cut-out and a 441-mm (17.38-in.) bolt circle. Normal fasteners up to 6 mm (1/4 in.) will fit through the eight holes in the frame. Front mounting is simplest using the optional SMH-1 speaker mounting kit.

Electrical Connections

The EVX-180A is fitted with a pair of chrome-plated, frame-mounted connectors with color-coded ends. Electrical connection is made by pushing down, inserting wire completely through the rectangular slot and releasing pressure. One conductor of #9 AWG stranded, #8 AWG solid, a pair of twisted #15 AWG stranded or a pair of #14 AWG solid conductors will fit. A positive electrical signal applied to the red (+) terminal will displace the cone away from the magnet, thus producing a positive acoustic pressure.

ADDITIONAL DESCRIPTIVE INFORMATION

Voice-Coil Material:

Aluminum

Voice-Coil Insulation:

Polyimide, 220° C rating

Coil Form:

Polyimide

Frame:

Cast aluminum

Plating of Steel Parts:

Bright cadmium

Thermal Rise After Power Test:

82° C (147° F)

Recommended Enclosures:

6-10 ft³ (170-283 liters)

Physical Constants,

Effective Piston Diameter:

0.394 m (15.5 in.)

Total Moving Mass:

0.127 kg (0.280 lb)

Voice-Coil Winding Depth:

20.3 mm (0.80 in.)

Top-Plate Thickness at Voice Coil:

8.9 mm (0.35 in.)

Z_{min}:

7 ohms

BI Factor:

21.9 tesla-meters

Thiele-Small Parameters:

f_s: 29.0 Hz

R_E: 5.0 ohms

Q_{TS}: 0.266

Q_{MS}: 4.00

Q_{ES}: 0.289

V_{AS}: 416 liters (14.7 ft³)

S_D: 0.122 m² (189 in.²)

x_{max}: 6.4 mm (0.25 in.)

η₀: 3.42%

P_{E(max)}: 600 watts (EIA RS-426A);

500 watts (continuous sine wave)

Response in Standard Baffle

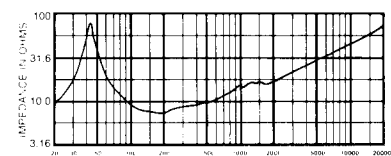

NOTE: AES requires a large, planar baffle for this test, WHICH IS INTENDED TO SHOW SMOOTHNESS AND OFF-AXIS RESPONSE, NOT BASS RESPONSE. This has proven to be inconvenient and prohibitive, due to its size. Here, we have chosen our lab-standard, low-diffraction, 12-cubic-foot test enclosure, which will demonstrate the same characteristics as the "AES standard baffle."

1. Teflon® is a registered trademark of DuPont.

695-6831) and/or Electro-Voice West, at 8234 Doe Avenue, Visalia, CA 93291 (209/651-7777).

Incidental and Consequential Damages Excluded: Product repair or replacement and return to the customer are the only remedies provided to the customer. Electro-Voice shall not be liable for any incidental or consequential damages including, without limitation, injury to persons or property or loss of use. Some states do not allow the exclusion or limitation of incidental or consequential damages so the above limitation or exclusion may not apply to you. **Other Rights:** This warranty gives you specific legal rights, and you may also have other rights which vary from state to state.

Electro-Voice Speakers and Speaker Systems are guaranteed against malfunction due to defects in materials or workmanship for a period of five (5) years from the date of original purchase. The Limited Warranty does not apply to burned voice coils or malfunctions such as cone and/or coil damage resulting from improperly designed enclosures. Electro-Voice active electronics associated with the speaker systems are guaranteed for three (3) years from the date of original purchase. Additional details are included in the Uniform Limited Warranty statement.

Service and repair address for this product: Electro-Voice, Inc., 600 Cecil Street, Buchanan, Michigan 49107.

Specifications subject to change without notice.



Distortion Response, 60 WATTS

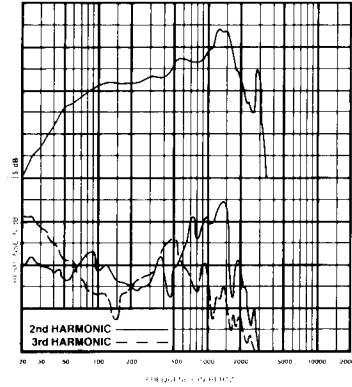

Impedance Response (EVX-180A)

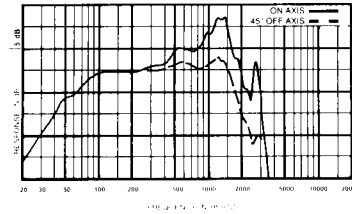

Designers will find the following in tuning their enclosures:

$$L_v = \frac{S_v}{3.7 \times 10^{-4} V_b f_b^2}$$

Where:

- L_v = Length of vent in inches
thickness of baffle t_b
- S_v = Area of vent in square inches
- V_b = Volume of box in cubic inches
- f_b = Box tuning in Hz
- r = Radius of vent
- K = 1.7 for a hole in baffle tube in inches

WARRANTY (Limited)

Electro-Voice products are guaranteed against malfunction due to defects in materials or workmanship for a specified period, individual product-line statements in the individual product data sheet manual, beginning with the date of purchase. If such malfunction occurs within the specified period, the product will be replaced (at our option) with a new product of equal or better quality. The Limited Warranty does not apply to finish or appearance; (b) certain conditions described in the individual product statement(s) below, or in the individual product data sheet or owner's manual; resulting from use or operator error.

600 Cecil Street, Buchanan, Michigan 49107

■ OKLAHOMA CITY, OK ■ GANANOQUE, ONT.
Part Number 531643 — 9309



ELECTRO-VOICE a MARK IV company

MANUFACTURING PLANTS AT ■ BUCHANAN, MI ■ NEWPORT, TN ■
© Electro-Voice, Inc. 1993 ■ Litho in U.S.A.