

# EP309-8T EP309-16T

## Duplex® Ceiling Loudspeaker System

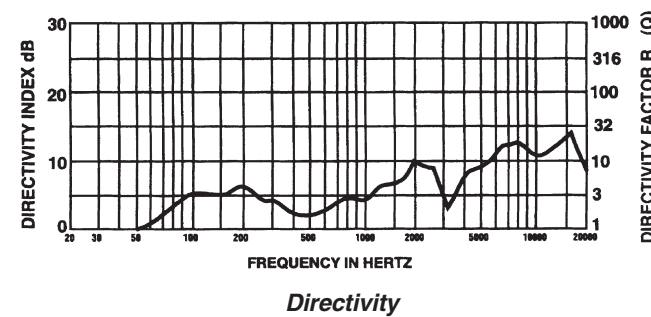

### Polar Response Charts

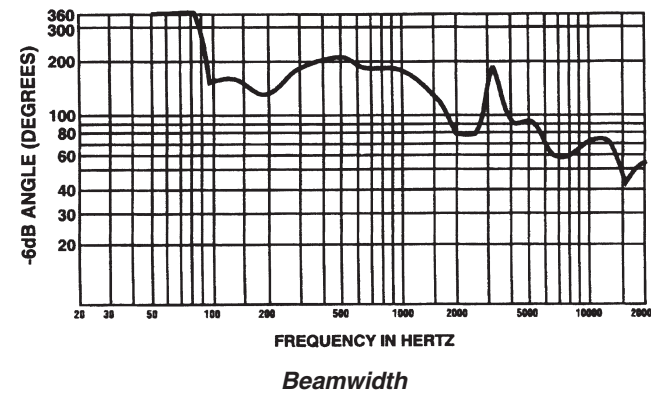
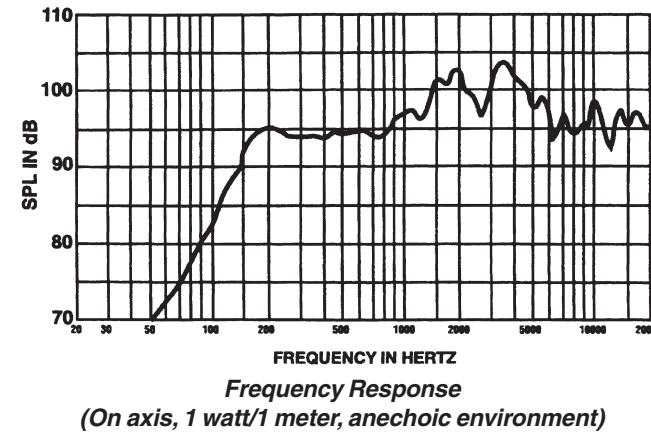
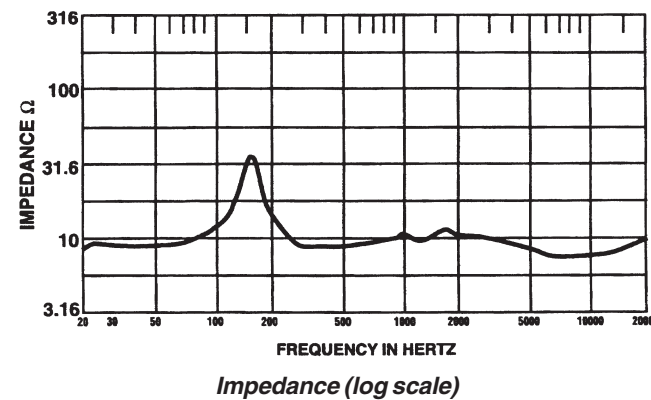
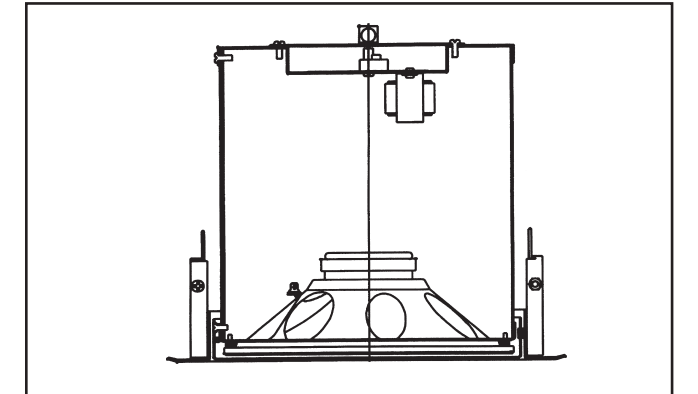
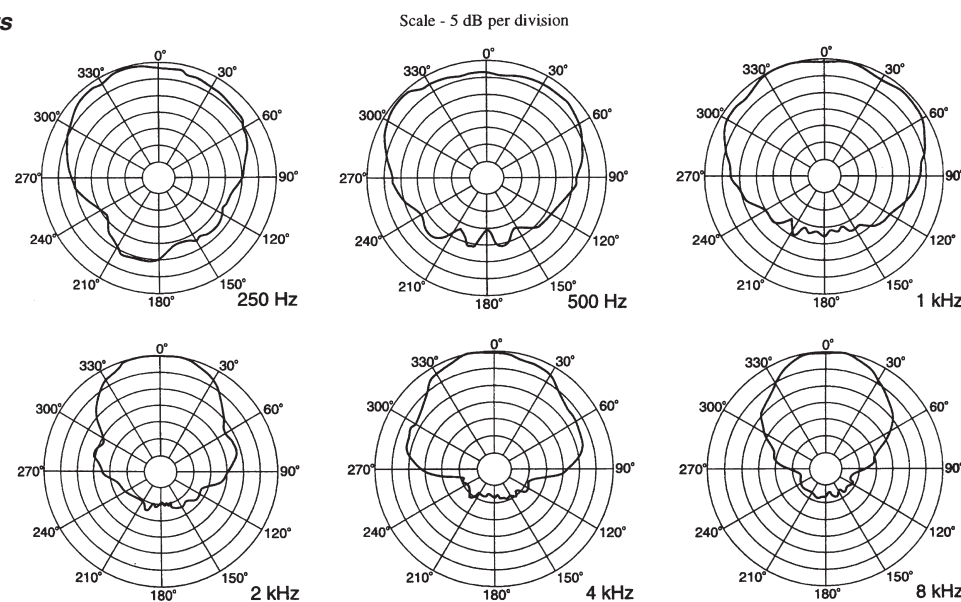

### General Product Description

The Electro-Voice® EP309 series Duplex® loudspeaker systems are complete two-way ceiling loudspeaker packages. The package consists of a spring/bezel assembly, grille, rear enclosure, 8-inch Duplex® loudspeaker and line-matching transformer. The loudspeakers feature 8-inch low-frequency cones and high-temperature voice-coil assemblies coaxially mounted with wide-dispersion cone tweeters. The dual magnet construction allows each speaker to be structurally, magnetically, electrically and mechanically independent of the other. The 309 series loudspeaker utilizes a crossover network, centered at 3,000 Hz, that provides 6-dB-per-octave tweeter protection outside of its operating range.

The EP309-8T utilizes a transformer that offers a selection of 1, 2, 4 and 8 watts delivered to the loudspeaker system using either 70-V or 100-V lines.

The EP309-16T utilizes a transformer that offers a selection of 2, 4, 8 and 16 watts delivered to the loudspeaker system using either 70-V or 100-V lines.

The bezel and perforated grille are finished in semi-gloss white powder-coated enamel. The rear enclosure is constructed from zinc-plated, cold-rolled steel.

The rear enclosure provides an optimum internal volume, ensuring extended low-frequency performance. It is constructed from heavy-gauge, rugged cold rolled steel, under-coated to prevent panel resonance, and finished with rust-inhibiting paint. A rear cover, with provisions for a junction box fitting, provides access to an 8-pin terminal block that allows direct connection to each of the transformer taps.

An optional tile bridge system is available for safe suspension of the EP309 series ceiling systems in a drop ceiling that uses mineral wool, or other fiber-based ceiling tiles.

These components have been designed to work together as a complete system in a wide range of different ceiling constructions. They provide wide dispersion, high-efficiency, high-maximum output, ease of installation, and wide-range reproduction of music or voice.

### Specifications:

<b>Pressure Sensitivity</b> (1 W, 500 Hz–3 kHz, re: 20 µPa):	96 dB SPL
<b>Frequency Response</b> (see back page):	85 Hz–18 kHz
<b>Power Handling:</b>	16 watts
85 Hz–18 kHz, AES method:	
<b>Maximum Long Term Output:</b>	107.6 dB SPL
(16 watts input, 1 m, re: 20µPa):	
<b>Impedance:</b>	
Nominal:	8.0 ohms
Minimum at 11 kHz:	6.0 ohms
<b>Components:</b>	
8-inch, high-efficiency, low-frequency driver with a coaxially mounted, 2.5 inch cone tweeter	
<b>Crossover Network:</b>	3,000 Hz

### Input Terminals:

Eight-way barrier strip with screw or push-type connectors that will accept up to two #10 AWG wires

**Accessories:** CTB-8 Ceiling Tile Bridge Dimensions,

**Loudspeaker diameter:** 273 mm (10.74 in.)  
**Depth:** 235 mm (9.26 in.)

### Net Weight

**EP309-8T:** 3.2 kg (7.0 lb)  
**EP309-16T:** 3.4 kg (7.5 lb)

### Shipping Weight

**EP309-8T:** 3.4 kg (7.5 lb)  
**EP309-16T:** 3.6 kg (8.0 lb)

**Finish:** White power coated enamel

USA 12000 Portland Ave South, Burnsville, MN 55337, Phone: 952-884-4051, FAX: 952-884-0043  
Canada 705 Progress Avenue, Unit 46, Scarborough, Ontario, Canada, M1H2K1, Phone: 416-431-4975, 800-881-1685, FAX: 416-431-4588  
Switzerland Kellenstrasse 11, CH-2563 IPSACH, Switzerland, Phone: 41(0)32-331-6833, FAX: 41(0)32-331-1221  
Germany Hirschberger Ring 45, D-94315, Straubing, Germany, Phone: 49 9421-706 392, FAX: 49 9421-706 287  
France Parc de Courcein, Alle Lech Walesa, Lognes, 77185 Marne La Vallee, France, Phone: 33(1)6480-0090, FAX: 33(1)6480-4538  
Australia Unit 23, Block C, Slough Business Park, Slough Avenue, Silverwater, N.S.W. 2128, Australia, Phone: 61(2)9648-3455, FAX: 61(2)9648-5585  
Hong Kong Unit E & F, 21/F, Luk Hop Industrial Bldg., 8 Luk Hop St., San PO Kong, Kowloon, Hong Kong, Phone: 852-2351-3628, FAX: 852-2351-3329  
Japan 2-5-60 Izumi, Suginami-ku, Tokyo, Japan 168, Phone: 81-3-3325-7900, FAX: 81-3-3325-7789  
Singapore 3015A Ubi Rd 1, 05-10, Kampong Ubi Industrial Estate, Singapore 408705, Phone: 65-746-8760, FAX: 65-746-1206  
Mexico Av. Parque Chapultepec #66-201, Col. El Parque Edo. Mex. 53390, Phone: (52) 5358-5434, FAX: (52) 5358-5588  
UK 4, The Willows Centre, Willow Lane, Mitcham, Surrey CR4 4NX, UK, Phone: 44 181 640 9600, FAX: 44 181 646 7074  
Africa, Mid-East 12000 Portland Ave South, Burnsville, MN 55337, Phone: 952-887-7424, FAX: 952-887-9212  
Latin America 12000 Portland Ave South, Burnsville, MN 55337, Phone: 952-887-7491, FAX: 952-887-9212

www.electrovoice.com • Telex Communications, Inc. • www.telex.com

© Telex Communications, Inc. 02/2001  
Part Number 38109-927 Rev A



U.S.A. and Canada only.  
For customer orders, contact the Customer Service department at 800/392-3497 Fax: 800/955-6831  
For warranty repair or service information, contact the Service Repair department at 800/685-2606  
For technical assistance, contact Technical Support at 866/78 AUDIO  
Please refer to the Engineering Data Sheet for warranty information.  
Specifications subject to change without notice.

**Electro-Voice®**

## Mounting the System in a Ceiling

### Using the T-bar Support Accessories

The Electro-Voice® EP Series ceiling speaker systems have been designed to accommodate a wide range of ceiling tile and structural ceiling materials. The spring assemblies can accommodate a range of material thicknesses from 0.375-inch up to 1.25-inch thick.

Before beginning the installation, determine the type of material employed in the ceiling. For all “soft” ceiling tiles, it is imperative that the optional CTB ceiling tile bridge be utilized. The support rails are 603 mm (23-3/4 in.) long and will support a loudspeaker system in a 2 ft x 4 ft (or 2 ft x 2 ft) tile. In addition, if angled at 10 to 15 degrees, the tile bridge can be used with 600-mm tiles (see Figure A).

Figure A

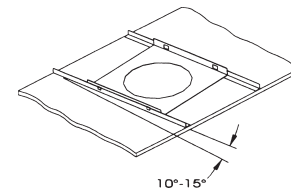

Ceilings constructed from particle board, gypsum board or plaster do not normally require the use of a tile bridge.

### Preparing the Wires

The ceiling system is provided with an eight-way barrier strip that provides access to each transformer tap. Up to #10 gauge wire can be used, and a choice of both screw terminal or spring-loaded push terminals have been provided (see Figure B). The recommended strip length is 6.4 mm to 8.0 mm (0.250 in. to 0.312 in.).

### Using Conduit Fittings

The rear cover has provisions for use of a junction box, or gland-nut style fitting (see Figure E). This allows both solid and flexible conduit to be connected directly to the system. If local codes require the use of conduit, ensure that it is well supported. Too much unsupported weight may prevent the ceiling system from closing flush against the ceiling surface.

### Selecting a Transformer Tap

The transformer tap of choice can be obtained by making connection between the ground terminal (# 1) and any of the wattage taps indicated on the input label (#5, 6, 7 or 8). Either 70-V or 100-V lines can be used — refer to the input panel label to determine the appropriate wattage for the line voltage used (see Figure B).

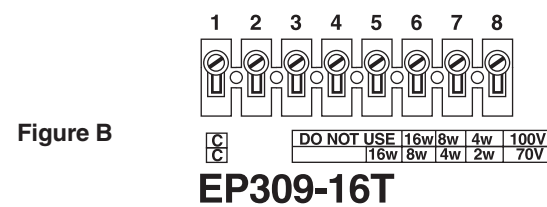

Figure B

### Cutting Mounting Holes

- The hole for the 4-inch systems should be 171 mm (6.75 in.) (See Figure C)
- The hole for the 6.5-inch systems should be 203 mm (8.00 in.)
- The hole for the 8-inch systems should be 241 mm (9.50 in.)

**Note:** The CTB-Series of tile support bridges provide a perfect hole template and will center the hole on the width of the tile.

Figure C

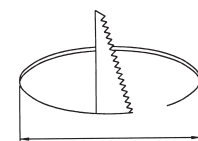

Check for electrical conduit/wiring and other hazards before cutting the hole. In addition, allow sufficient clearance for both the depth of the loudspeaker/enclosure and any electrical fittings used.

## Installation

### T-bar support

The T-bar system is comprised of two support bars and a support bridge. The bars are inserted through tabs formed in the two sides of the bridge and can be adjusted to allow the cut-out to be positioned at any point on the width of a ceiling tile. Additionally, the tile bridge system can be moved along the drop ceiling support rails and positioned at any point along the length of a ceiling tile. The ceiling bridge should be positioned directly above the hole cut in the ceiling tile with the bridge resting directly against the rear of the tile.

### Bezel / Spring Assembly

The bezel/spring assembly is installed from the “room side” by pushing the inner tubular section up through the hole cut in the ceiling tile. If a tile bridge is used, the bezel inner tube will also pass through the hole in the tile bridge. The top leg of the clamp springs ([3] for the 4-inch and 6.5-inch systems and [4] for the 8-inch system) should be released, one at a time, by reaching through the hole. Ensure that the metal arms are seated firmly, and evenly, on the ceiling

Figure D

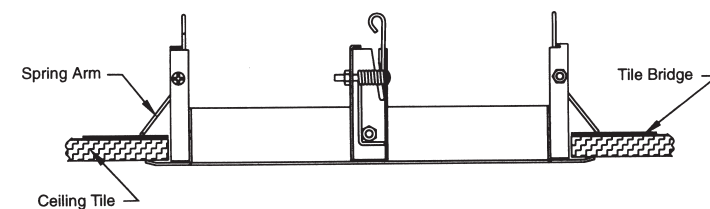

tile or ceiling tile/bridge combination (see Figure D). Then push the bottom leg of the clamp spring up through the slot in the spring bracket pushing slightly counter clockwise to lock in position. This keeps constant pressure on the spring leg.

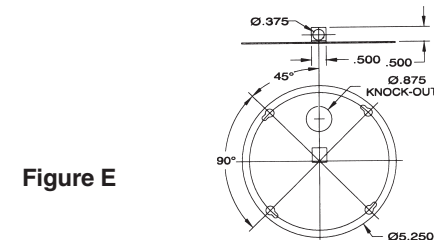

Figure E

### Loudspeaker System Assembly

Before installing the ceiling loudspeaker system it is necessary to pull the hook up wire downwards through the hole in the ceiling and make electrical connection to the terminal block on the rear cover — as previously discussed. If required by local regulations, a mounting point is provided on the rear cover that can be used for the attachment of a safety chain, or wire (see Figure B).

All Electro-Voice® EP Series loudspeaker systems can be installed by pushing this assembly through the central opening of the bezel assembly and then rotating the grille/loudspeaker until the “pins” on this item align with the “bayonet” slots on the bezel assembly (see Figure F).

Figure F

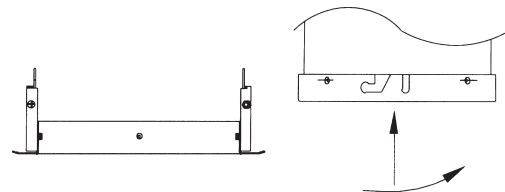

### Removing a Loudspeaker System Assembly

A loudspeaker system can be removed by pushing upwards on the grille and rotating the grille/loudspeaker combination until the pins on the grille escape the bayonet slots on the bezel assembly (see Figure F). Disconnect the safety chain or cable (if employed) and disconnect the electrical connection.

## Painting Loudspeaker Assemblies

### Bezels

The bezels may be painted before or after installation. Use conventional spray or roller equipment to paint the loudspeaker bezel when the rest of the ceiling is painted. Latex and oil based paints will adhere easily to the loudspeaker bezel, but can scratch if handled carelessly.

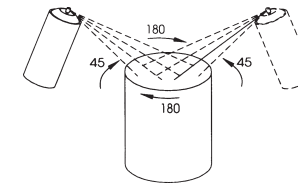

Figure G

### Grille/Loudspeaker Assemblies

Brushes or rollers may clog the grilles, interfering with the acoustic performance of the ceiling system. Additionally, a high-pressure spray system may penetrate through the cloth barrier, coming into contact with, and damaging, the paper cone. Instead, spray paint the grilles with lacquer or enamel paint in aerosol cans. (A professional, siphon feed spray gun may also be used, provided the pressure is sufficiently low to prevent cone damage). Place the grille/loudspeaker system on a flat surface, facing upwards. Clean the grilles first to remove all possible contaminants. Apply the paint at a 45 degree angle to the grille surface, (see Figure G). Rotate the grille 180 degrees and apply a second coat of paint. Alternatively, the grille can be removed from the loudspeaker enclosure by the removal of three self tapping screws in the vertical section of the grille (see Figure F).

### Safety Regulations

All Electro-Voice® EP Series of ceiling loudspeaker systems comply with the following standards:

- UL 1480 (general purpose category) [The UL category is ueay, the control number is 8682 and the file number is E121872]

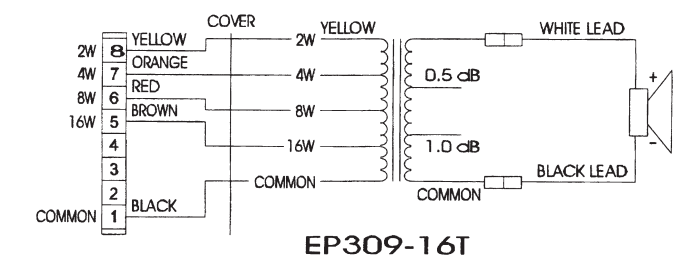
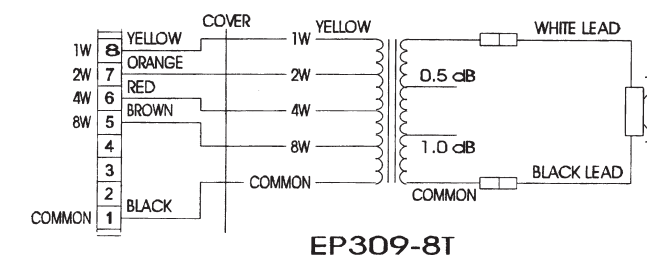

### Wiring Diagrams

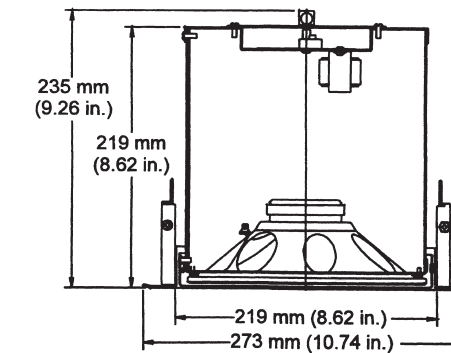
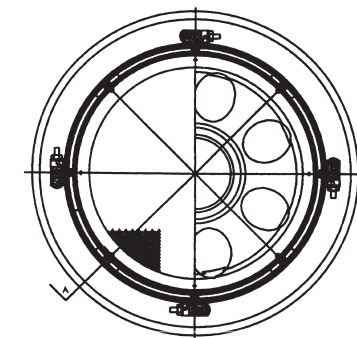

### Dimensions