



Paging/Background Music Systems

How to Design and Sell Paging and Background Music Systems from EV & Dynacord



DYNACORD®

DISCLAIMER & COPYRIGHT

The material and instructions covered in the document are subject to change without notice. Telex Communications, Inc. does not guarantee the suitability of the material contained herein for your particular application.

Table Of Contents

Table Of Contents.....	3
The Business Audio “Business”	5
EV HAS ALL THE PERFECTLY POSITIONED PRODUCTS!	5
EV Business Audio Product Guide	7
EVID Surface Mount Speaker Systems	7
Innovation in Design	7
Innovation in Functionality	7
Model Summary	7
Full Range Audio Performance	7
“Outdoor Ready” Construction	8
EVID Ceiling Mount Speaker Systems	8
The EVID Ceiling Speaker Solution – Why is it Different?	8
The EVID C8.2HC – Wide Spectrum Pattern Control in a Compact Package	8
The EVID 4.2, 8.2 and 8.2L – Full Range Models with Punch	9
The 10.1 - Finally a Compact True Ceiling Subwoofer	9
EV Raw Frame Ceiling Speakers.....	9
EV Amplification Products	10
MA Series Mixer Amplifiers	10
Primary Features.....	11
EV Commercial Power Amplifiers	11
CPS Series Power Amplifiers.....	11
Key CPS Amplifier Product Features.....	12
ProAnnounce Digital Routing System	12
Overview	12
Basic System Components	13
Audio Routing Made Easy.....	13
ProAnnounce DP Series Power Amplifiers	13
Basic Business Audio System Design Guide	14
The Basic System Components.....	14
Microphones.....	14
Signal Routing and Processing.....	14
Amplification.....	14
Speakers	14
What to Recommend?	14
Step 1 – Know the Job!.....	14
Step 2 – Determine the Acoustic Requirements.....	15
Step 3 – Conduct a Preliminary Layout and “Walk Through”	15
Step 4 – Assemble the Equipment List.....	16
Expect The Unexpected.....	16
Standardizing for Profitability	17
Speaker Selection	17
Ceiling vs. Surface Mount Systems	17
Selecting & Positioning Ceiling Loudspeakers	17
Ceiling Speaker Coverage	18
Converting Coverage Specs to A Layout.....	19
An Example of Coverage Pattern vs. Speaker Size	19
When Controlled Coverage is Needed	20
The Use of Subwoofers	20
Positioning Subwoofer Components.....	21
Choosing the Best Mixer/Amplifier	21

Analyzing the Application.....	21
When To Specify Mixer/Amplifiers.....	22
When the Job Calls For ProAnnounce!.....	23
The DRM4000 vs. the DPM4000.....	23
DPM4000 4x4 Matrix Router.....	23
DRM 4000 Mixer.....	23
Volume And Tone Controls / Delays.....	24
Signal Generators / Voice Message Memory.....	24
Control Inputs And Outputs.....	24
Clock / Calendar.....	25
Monitoring.....	25
Macros.....	25
Interfaces.....	25
Station Control Consoles.....	26
Understanding DCS Expansion Options.....	26
The DCS 400 Expansion Chassis.....	27
BGM and Paging System Designs.....	27
BGM Installations - System Examples.....	28
Retail Store – Single Zone.....	28
Office Building - 5 Zone - Simplified system.....	29
Bar-Restaurant - 2 Zone.....	30
Health Club - 4 Zone.....	31
Retail Clothing Store -2 Zone.....	32
Retail Book/Record Store -3 Zone.....	33
Large Department Store - 6 Zone.....	34
Basic Warehouse - 5 Zone.....	35
Multi-Use Warehouse, Factory & Office Facility - 15 Zone.....	36
Appendix A: Distributed Audio Systems – A Primer.....	37
Why Is It Called “Constant Voltage”?.....	37
What Are the Advantages to Constant Voltage Systems?.....	37
Amplifier Bridging.....	38
Single-Channel Direct Drive.....	38
Use of Autotransformers.....	39

The Business Audio “Business”

Business audio or “background music” has come a long way since the days of Muzak and “elevator music” systems of the 50’s – 80’s. Countless retail establishments such as clothing stores restaurants, department stores and even “drug stores” are spending money on better quality audio.

Many contractors and BGM integrators are rapidly discovering this fast growing source of business and several manufacturers have introduced products to meet these new demands. There are several at the low end of the market, some in the middle but virtually no one has ventured into the premium end of the market.

Some estimates put the size of the U.S. BGM market at over \$250 million dollars. The rate of growth has been over 10% in recent years primarily due to the increased cost per installation. Including installation labor the average high quality BGM install is now over \$7,500, up from less than \$3,000 just a decade ago.

EV is perfectly positioned to capture a major portion of the growing business. Over the last 3 years we have made major inroads in positioning our speaker products to fit into this market. The EVID line of speakers has grown to fill virtually every segment in the middle and upper BGM market segments.

Now however we are able to complete the entire system offering in nearly every segment. The breadth of the BGM offerings is quite amazing. We can now offer complete BGM systems with equipment costs from under \$1,000 to over \$20,000 at dealer. **NO ONE ELSE IN THE BUSINESS CAN DO THIS!** EV is the only source that can offer a complete solution for a department store, restaurant, or any other retail environment.

EV HAS ALL THE PERFECTLY POSITIONED PRODUCTS!

Category	Product Range	The EV Advantage
Microphones	Telex and EV Paging Mics	Over 50 years of proven performance.
Audio Routers	ProAnnounce Matrix Manager	Powerful and economical. No system can offer this level of flexibility for under \$1,000
System Integration	ProAnnounce Designer Software	The most flexible and sophisticated solution available
Speakers	EVID premium speakers and standard EV component ceiling speakers	Wide range of solutions with leading edge designs
Amplification	MA Series mixer amplifiers ProAnnounce and EV power amplifiers	Comprehensive and reliable product. Wide range of price points.

People are getting used to better quality sound in their homes, cars and entertainment spaces. Their expectations have grown for better quality sound in retail, office and other background music spaces. Using premium quality audio systems can help increase sales through improved customer perceptions of the business’s products or services. It has now been well established that the quality of music in commercial spaces greatly impacts the customer’s perceptions of the products or services of the establishment. The dollar payback is substantial. High quality music also increases the friendliness and job satisfaction of the employees.

How do you put together a top-quality business music system? It may seem easier than it really is. We can’t design systems the way we used to, using obsolete rules of thumb or just substituting a louder, low-quality sound for a quieter one and calling it a job well done.

We have to approach each design analytically. The first step is to determine what the customer wants and expects. The questions you ask up front help you decide what kind of sound system to propose.

As you start thinking about the design, you need to translate the client's requirements into terms of coverage, adequate sound levels and bandwidth. Once these requirements are identified, you can start thinking about loudspeaker and component selection, speaker layout patterns and speaker density.

Unless it's a simple "point-and-shoot" system using a single mixer/amplifier (which is often a good choice), you need to be able to correctly tune the system after it's installed, ensuring proper settings and optimal performance.

This guide is a comprehensive set of design tools and extensive product information to help you understand the world of Business Audio and the broad range of offerings EV/Dynacord makes available to you to service this dynamic and fast growing market.

EV Business Audio Product Guide

EVID Surface Mount Speaker Systems

The “ID” in EVID is for Innovative Design of high quality foreground/background speaker systems. EVID is not just another box, or trapezoidal system, EVID is different. It’s unique design concept combines style with acoustics for several benefits.

Innovation in Design

EVID is an aesthetic design using organic curves to fit into many decors and themes, it does not look like a traditional loudspeaker. This allows better integration for a more invisible sound system, while not distracting from a commercial or theme environment. In our desire to have them blend into the background we even eliminated an EV logo on the grille!

Innovation in Functionality

EVID’s mounting system provides greater range of aiming angles in both horizontal and vertical planes than other types. Coverage options are increased by the enclosure’s ability to be mounted either “vertically”, or “horizontally” while fitting into the environment without looking awkward. The bracket’s design compliments the enclosure while helping deterring theft. The grille follows the use of curvature with designed in weather resistance and a “hidden leash” for safety. All models all available in black or white, and can easily be painted the match the décor.

Model Summary

- EVID 3.2** Most compact of the EVID series, the EVID 3.2 consists of dual 3” LF drivers with a .75” Ti (titanium) direct radiator, providing high-fidelity full-range sound over an extremely wide coverage area. The EVID 3.2t includes a transformer for 70V or 100V systems.
- EVID 4.2** The EVID 4.2 uses dual 4” LF drivers and a 1” Ti /waveguide tweeter, able to deliver maximum sound level over a wide coverage area. The EVID 4.2t includes a multi-tap transformer for 70V or 100V line distribution systems.
- EVID 6.2** The EVID 6.2 contains dual 6.5” woofers and a 1” Ti /waveguide tweeter, designed for high performance audio over a wide coverage area. The EVID 6.2t includes a multi-tap transformer for a 70V or 100V line distribution system.
- EVID 12.1** The unique 12” dual voice coil woofer design and side/front angled port system allows for powerful low-frequency reinforcement from a flexible, compact wall or ceiling mount enclosure. The EVID 12.1 is an ideal addition to any EVID system, resulting in an amazing bottom end and fullness to any program material.

Full Range Audio Performance

EVID’s rounded enclosures coupled with dual low frequency transducers endows all three models with exceptional performance. The three dimensional elliptic baffle symmetrically locates the high frequency element in front of, and between the low frequency drivers. This careful shaping, location, and 10° splaying of the LF units provides coverage control by the resulting line array. Lobing is controlled by physically “shadowing” the LF transducers from each other over the bandwidth they would normally exhibit interference. The specially designed waveguide used in EVID 6.2 and 4.2 contributes to the controlled coverage without adding distortion. It’s size, shape and depth are optimized for crossover transition, linear response on and off axis, and even coverage over a 100° x 120°.

Dual L.F. elements extend bandwidth and increase power handling. A sophisticated network uses 2nd order filters for smooth, low distortion response, and overload protection for all transducers.

“Outdoor Ready” Construction

All EVID models except the 12.1 subwoofer are weather resistant. EVID 3.2, 4.2, and 6.2 meet IEC529 rating IP-x4 and MilSpec 810 for water and dust resistance. The attention to detail even includes weep holes to evacuate condensation. Outdoor installations should include an overhang or other protection from direct exposure.

Built-in transformer versions (3.2T, 4.2T, 6.2T) feature high quality, low distortion transformers for 70v and 100v constant voltage applications. They provide the same superior sound as the non-transformer models.

The 12.1 subwoofer uses a 12” transducer with dual voice coils to produce low frequencies to below 40Hz. Its built-in filters reduce coloration while providing a high pass output for satellites that further increases their potential output capability. The dual voice coils fully utilize a stereo amplifier for maximum sound and allow filtered stereo outputs.

All models are also available in “decorator” white

EVID Ceiling Mount Speaker Systems

The EVID ceiling system product line provides premium-level performance at a value price. Their wide coverage and high SPL capability allows the use of fewer speakers, resulting in lower system cost than the tight-spaced layout that low power narrow coverage speakers require. The overall price differential of the EVID units to commodity type speakers is actually quite small when the assembly and component costs of these standard ceiling speakers is taken into consideration. The EVID units are fully assembled and no additional installation components are generally needed. An EVID system “pays for itself” very quickly. Locations with the highest sales per square foot are the ones who are most careful about sound quality, music programming, and customer satisfaction.

The EVID Ceiling Speaker Solution – Why is it Different?

The design goal of the EVID line of ceiling speakers was to provide effective solutions to give the contractor the best range of options when specifying a job. Since the acoustic and design requirements can vary considerably from job to job, a comprehensive range of choices is needed to be a full service supplier.

The EVID C8.2HC – Wide Spectrum Pattern Control in a Compact Package

High ceilings and reverberant rooms have long been the downfall of many ceiling based distributed sound installations. The inherent desire for wide dispersion in smaller acoustically dead spaces works against the use of ceiling speakers in larger rooms with reverberant characteristics and higher ceilings. Until now there has not been a cost effective solution that combines good quality full range audio with useful pattern control. Some ceiling products attempted to have pattern control at the high frequencies but this proved largely ineffective at the critical voice spectrum of the audio range. The result was a speaker that had the same poor intelligibility problems when used in reverberant room as conventional ceiling speakers.

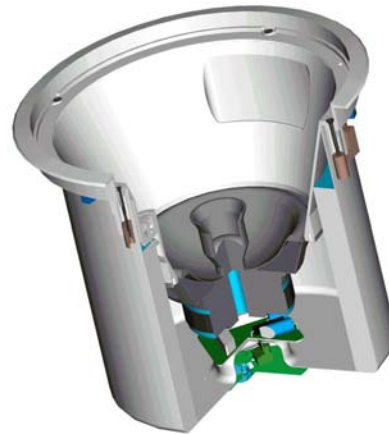

The real solution to the problem requires that directionality must exist for the critical mid frequencies as well as the upper end of the spectrum. For this to happen a new approach is needed. An effective answer to this problem is the EVID C8.2HC

The EVID C8.2HC is designed to provide directionality through the critical voice spectrum by employing a unique (patent pending) ported waveguide to the entire 8" driver. The resultant package is one that is compact, easy to install and provides far more intelligibility in reverberant or high ceiling environments than any other competitive model. The C8.2HC also is designed for higher power, high SPL applications with a 60watt 70/100v transformer standard. No other ceiling speaker available offers this unique solution.

The EVID 4.2, 8.2 and 8.2L – Full Range Models with Punch

EVID C4.2 Perfect for conventional rooms. It has excellent bandwidth in an esthetically very unobtrusive installation profile. It's compact design fits in tight areas. Fully rated for use in air handling spaces. It's 4" woofer and waveguide coupled titanium coated dome tweeter give smooth, wide frequency response. The enclosure is ported and tuned to provide surprising bass response in such a compact package. Features an easy 3-point mounting system for quick installations. Comes complete with mounting support ring and tile rails. No additional accessories needed for most installations. The C4.2 would be ideal for most office spaces along with smaller restaurants and retail space where lower volume levels are used. It fits in close spaces and has a wide 130-degree dispersion pattern for efficient coverage.



EVID C8.2 Unique in providing extremely high fidelity in a flush mount ceiling speaker. The secret is the optimally tuned enclosure coupled to a large 8" coaxial driver. The large enclosure ensures a full bottom end while the waveguide coupled tweeter gives uniform coverage for the high frequencies.

EVID C8.2L For tight fitting spaces the 8.2L is the ideal choice. It is very close to the performance of the C8.2 but with a shallow back can for an easier fit. The primary difference is at 50 Hz where the output level is 6db lower than the standard C8.2. In many installations however this is not noticeable and the performance of the C8.2L is still far beyond that of nearly any other 8" solution in the marketplace.

The 10.1 - Finally a Compact True Ceiling Subwoofer

So often ceiling systems had to rely on expensive surface mount subwoofers or inadequate ceiling/flush mount options. In designing the 10.1 we started with a mass optimized 10" woofer and a dual ported and tuned enclosure. The internal damping provides resonance free performance down to 45Hz. The system has a true crossover to eliminate any "localization" problems and provides the proper match to the full range EVID units.



The C10.1 is also an ideal companion to the EVID surface mount speakers. The C10.1 is an especially good match to the 3.2.

EV Raw Frame Ceiling Speakers

EV has provided a wide range of component ceiling speakers for many years. Contractors have come to expect value and performance for every EV model. Component ceiling speakers are often a good solution when specific requirements of the job dictate using an unconventional

solution. Situations where cost, tight physical spaces, audio response, local building or fire codes, etc... come into play may require a unique EV component speaker solution. The EV raw frame ceiling speaker line consists of 6 models listed below to address nearly every situation:

Model	Size	Acoustic Design
205	4"	Single Cone
405	4"	Single Cone
209	8"	Single Cone
309	8"	Coaxial
409	8"	Coaxial
Pro-8A	8"	Coaxial

Typically these speakers are installed with a transformer, grille and back box to complete the installation. Often times raw frame speakers are used when the installation calls for very unusual space constraints or where there is a desire to hold costs down to the lowest possible figure.

The installation of raw frame ceiling speakers does require more effort than the tuned sealed enclosures such as the EVID series. Keep in mind that the audio performance of even the best component models generally do not equal any of the EVID sealed units because the enclosures are not tuned and matched to the drivers used.

EV Amplification Products

MA Series Mixer Amplifiers

The MA-1200 series of professional rack mount mixer/amplifiers are designed for larger BGM/paging and public address system installations where expandability and flexibility is the ticket. These new units are exceptional values, loaded with features and are easy to install in a variety of system designs.



The MA-1206 provides a powerful 60 watts of output power into 70v/100v or 8 ohm loads. The MA-1212 has the same feature set but supplies twice the power at 120 watts. Both models have a variety of features to enable them to be customized to a wide range of background music and paging applications.

The units feature 12 separate input channels. Input channels 1-10 are designed to be used as either balanced or unbalanced low-Z microphone inputs or they can be switched to a line level signal. Phantom power is also available on any of the 10 inputs. A signal appearing at input 1 will automatically mute the other channels unless the mute function is defeated via a switch on the front panel. Inputs 11 and 12 are for auxiliary line-level sources such as tape or CD players. Mono or stereo signals may be applied to inputs 11 or 12. The left and right components of a stereo signal can be applied to the dual RCA phono jacks of these inputs and mixed together to drive the built-in monaural power amplifier. A rear panel paging input with gain control is provided for the paging output of a telephone system. An audio signal appearing at this input automatically mutes all other inputs.

A preamplifier output jack and power amplifier input jack permit the mixed output to be fed to an external signal processor (graphic EQ or compressor), and then returned to the built-in amplifier. The preamp output may be used to drive an additional power amp with its own set of speakers without interrupting the function of the built-in amplifier.

The speaker output is available at a barrier strip which includes terminals for driving low impedance loudspeaker loads, as well as 25, 70.7 or 100 volt distributed systems.

Primary Features

- 10 balanced mic or line inputs – All available with 24v phantom power!
- 2 Auxiliary stereo summing inputs with 4 level sensitivity adjustment.
- 60 or 120 watt models available
- Balanced line level output for adding additional power amplifiers.
- 24 volt powered operation available for emergency power requirements
- Adjustable level telephone paging input.
- Independently adjustable low power monitor output.
- Integrated ‘rack ears’ allow for rack mounting without additional accessories.

EV Commercial Power Amplifiers

The 1415, 1407 and the 7100 provide the extra power often needed for small to medium installations. All the units are convection cooled for extremely quiet operation. They are perfect companions to the MA series mixer amplifiers.

- 1407** Delivering 75 watts at 8ohms, the 1407 delivers clean power where a small number of additional speakers are needed. The 1407 also provides power at 70v or 100v as well. The chassis is 3 rack spaces high.
- 1415** Similar performance and size to the 1407, the 1415 provides 150 watts at 8 ohms. And also delivers power into 70 or 100v lines.
- 7100** The 7100 is a 8ohm stereo amplifier in a compact 1 RU chassis. It delivers 75 watts x 2 into 8 ohms.

CPS Series Power Amplifiers

CPS Series high-performance power amplifiers include innovative protection/safety features and unmatched dynamic range capability that exceeds the unique usage demands for fixed-installation applications. The exceptional reliability and five-way power protection on all CPS models provides exceptional performance over the long haul.

The five-way protection system protects both the amplifier and the speaker from damage resulting from line shorts, thermal overload, power surges, signal degradation and signal overload. The unique Nonlinear Signal monitor gives the CPS Series its outstanding dynamic range and eliminates "hard-edged" clipping which can destroy most speaker systems. CPS Series amplifiers have burst-signal output-capability headroom in excess of 130 percent over their average continuous rating. CPS amps won't run out of steam when they're pushed hard!

70v-capable models feature Transformer Saturation Protection (TSP) that monitors the current demands of the transformer and can protect against overload and distortion.

All models are equipped with extremely quiet fans providing front-to-rear air circulation, guaranteeing trouble-free operation even in smaller power amplifier rack systems.

Key CPS Amplifier Product Features

	Feature	Benefit
Protection and Safety	Over-temperature protection	Ensures that the amplifier will never reach a critical operating temperature thus preventing any thermal damage. (includes a probe at the transformer too)
	DC protection	Eliminates amplifier damage in case of direct shorts
	Excessive Back-EMF monitor	Eliminates amplifier damage from reverse current flow back into amplifier due to speaker failure
	Low ac line voltage monitor	Prevents amplifier performance problems and potential speaker damage in case of AC line "Brown Outs"
	Front-to-Rear-Cooling (3-step fans)	Draws "cold" air from outside the rack, fan is only active(audible) when amp's working heavy.
Audio Performance	Nonlinear signal monitor (Dynamic Limiter)	Limits amplifier distortion to under 1 percent to eliminate "hard edged" clipping and provide higher average volume level.
	Power Supply design specially made to deliver high peak signals	Live music and voice signals contain very high peak transients compared to the much lower average signal level. The CPS series have Burst signal outputs of: CPS1: 640W, CPS2: 880W
Reliability	Quality from Design to manufacturing	3 year warranty

ProAnnounce Digital Routing System

Overview

This extraordinarily flexible and versatile system allows the configuration of either small or complex installations. Most functions are realized through software modules, which - when compared to conventional PA-systems – not only reduces the amount of cabling but also the costs. Next to extensive audio signal generating and distribution functions, the ProAnnounce system provides ample control functions. On one hand, these functions offer the possibility to register and rate external events, as well as to control different external components, on the other hand. Boolean operations and relations to the internal state of the system can be programmed as well.

The digital ProAnnounce manager DPM 4000 represents the central unit of the system. It is used to control and monitor all connected components via several serial interfaces.

The kind and amount of connected audio sound sources, amplifiers, and relay board assemblies are extremely variable. This allows configuring the system to basically match any requirement. The system is capable of managing up to 16 paging stations and up to 100 output lines. More than 150 control inputs and outputs are available for controlling and monitoring purposes providing the possibility to generate and manage logic levels and analog levels as well.

Configuration and documentation of a ProAnnounce system installation is established through the use of the ProAnnounce Designer software – a comfortable graphical user interface that runs on a PC under Windows. This allows changing the system's setup at any time to meet new requirements, without the need to alter the actual installation. The PC has to be connected to the system only when loading or changing its configuration. During normal operation, PC-interaction is not necessary. Anyway, in most cases the permanent connection of a computer bears benefits, like displaying detailed status reports or the printing of protocols. It also offers the possibility for remote diagnosis and remote maintenance via modem.

Basic System Components

Shown below is a typical basic ProAnnounce equipment list of the ProAnnounce components for a 4 zone BGM installation. This list includes a basic paging station and the ability to connect any number of remote volume controls on the system. The design can accept up to 3 different BGM sources to assign to any zone. The total power amplification of this design example is 400 watts.

Model		Description
DPM4000PA		Central Unit Matrix System Processor
NRS90228	121680	Input Module: 2 Channel Aux (RCA Phono Connectors)
NRS90234	121736	Input Module: Combination Mic/Line + Paging Console
NRS90218	121668	2 Channel Output Line Module
DPC4510	121623	8 Function/10 Selection Key Paging Console, with Display
DCS400	121773	19" Mounting Frame for DCS Modules
DCS401R	121774	Controller Module
DCS412R	121780	Logic Input Module
DCS416R	121782	Analog I/O Module
DPA4410PA	121793	ProAnnounce Series 4 Channel Power Amplifier 4x100w

Audio Routing Made Easy

The DPM 4000 employs a digital audio matrix providing 4 inputs and 4 outputs. Additional matrix junctions for the integrated gong and alarm signal generators, the vocal recording/playback unit, and the lock-on of the pilot tone and its evaluation are incorporated. All input signals and internally generated signals can be freely mixed inside the matrix and outputted through the 4 amplifier channels. Routing speaker lines to these amplifier channels is achieved via the relay-matrix, which offers up to four separate audio buses simultaneously, while the DPM 4000 takes over the management of all these signals according to their priority.

Next to connecting paging stations, the audio inputs also serve for the connection of other audio sound sources, like microphones, mixers, CD-players, cassette decks and DAT-recorders, tuners, etc. Several different input modules are available to optimally adjust and match signal levels and connections.

Other additional features include the DMM4650 message manager for prerecorded announcements, digitally controlled paging stations for extensive system control, DCS monitoring and control system for external system control of many functions.

ProAnnounce DP Series Power Amplifiers

The DP series amplifiers includes four models, offering common features as listed below:

- 3 models: **DPA 4410** (4 x 100 W), **DPA 4411** (4 x 100 W) with remote control, **DPA 4260** (2 x 600 W).
- Floating 70V power outputs (internally configurable to 100v, 70v or 4 Ω)
- Outputs are protected against idling and short-circuit
- Operation at 115/230 V AC and 24 V DC (emergency power supply)
- AC and battery remote on/off
- Electronically balanced inputs, transformers are optionally available.
- Input level controls
- Monitor outputs
- Temperature-controlled operation
- Pilot tone and ground fault surveillance (optionally available)
- Fault indication and fault messaging via floating READY-contact

Basic Business Audio System Design Guide

The Basic System Components

Microphones

EV has a complete line of microphones for paging and announcing. The models range from simple single zone gooseneck paging models to microprocessor controlled stations designed to route announcements to one or more areas simultaneously.

Signal Routing and Processing

ProAnnounce Signal processing and routing components are extremely flexible to meet any business audio need. From the comprehensive software functionality to the digital message manager and easy system control the ProAnnounce components make the installation simple to specify and install.

Amplification

EV and Dynacord Amplifiers provide exception performance and reliability. The range of offerings is impressive as well. From the MA series of rack mount mixer amplifiers to the CPS and ProAnnounce series of power amplifiers any application can be covered.

Speakers

EV offers many installation options for speaker products. From the EVID Premium surface mount models to the low cost 205/405 series of raw frame ceiling speaker units, we have an option to fit any installation requirement.

What to Recommend?

In any business audio installation a key part of a well designed job is getting all the steps done right. Most of these steps must be done in order or the system may turn out to be poorly designed and won't meet customer expectations. Getting each step right however can lead to well done installations which will promote additional future business through positive referrals and satisfied customers.

Step 1 – Know the Job!

Every system specification begins with a survey of the site. The sales engineer, whose job is to ask the right questions and gather all the information necessary to complete an accurate bid, normally performs the survey.

At this stage, it is most important to form an accurate picture of the customer's needs. Will the system be used for paging, background music, or both? Do pages originate from a single location, or from multiple locations? Must the system be tied into the customer's telephone network? Should the system be divided into multiple zones with separate volume controls? If so, should pages be routed to all zones, or should zones be separately addressable? Should zone controls be located at the rack, or is local control required? The answers to questions like these will determine major aspects of the system design.

Talking to individual users of the proposed system will help to reveal important design details. Is the maitre d' hotel's station located directly under a speaker? If so, then an independent local volume control should be provided for that speaker, so that it can be adjusted to allow conversation with patrons. Will the person issuing pages be sitting under or near a speaker? If so, then consider equalization, or a separate muting circuit, to avoid feedback. Is light-switch height a comfortable location for zone volume controls, or does the user have another

preference? Getting this kind of information at the beginning will help to avoid confusion and delays at the installation stage.

Just as important as the human factors are the construction details of the site. How are the walls and ceilings constructed? What kinds of mounting surfaces will be encountered? Is the drop ceiling a lay-in type, or tongue-and-groove? Where must cabling be routed, and how accessible are those spaces? Do partition walls or bearing members extend above the drop ceiling, where they may obstruct cable runs? Is conduit or plenum cable required? All of these factors directly affect the price quote and the actual task of installation.

A key decision early on in evaluating the equipment requirements is what type of infrastructure the system should have. The decision will determine if a mixer amplifier is used for the installation or if the ProAnnounce digital matrix routing system is used. The key questions to ask consist of the following:

1. Are there more than 2 independent audio programs running simultaneously?
2. Are “zone specific” independent remote controls required for volume levels in each zone?
3. Is the ability to remotely switch program sources for a particular zone required in more than one zone?
4. Do voice pages and announcements need to be restricted to certain areas of the building?
5. Is remote off site control of the system a required feature?
6. Are the power requirements for the system greater than 600 watts?

If the answer to any one of these questions is yes there is a good possibility that the ProAnnounce digital matrix infrastructure is required. The additional cost for this system however is not that great. The typical premium for a ProAnnounce routing system is less than \$1,200 for most installations over that of a “discrete” system design. In many cases there is no other viable solution to accomplish what the client wants.

Step 2 – Determine the Acoustic Requirements

When the basic infrastructure is established then a system acoustic layout can be done. This would consist of the following basic steps:

- Establishing required coverage areas
- Setting the acoustic volume (SPL) levels desired
- Establishing any esthetic or design requirements for the speakers.
- Estimating background noise levels for each zone.
- Determining the program material content to be run through each zone.

All this is done while taking into account the expectations of the client and the environment in which the system will be run. Is it a loud sports bar or a quiet elegant restaurant? Or is it a large open area of a hotel lobby and ballroom? Any of these needs can sway the final equipment selections.

At this point you need to determine the number of speaker appliances needed for the installation. This can be done using computer design tools such as the free EV Excel speaker calculator when using ceiling speakers or EASE which is a full scale acoustic modeling package.

Step 3 – Conduct a Preliminary Layout and “Walk Through”

The third step is to assemble the system design on paper and review the signal paths, amplifier power requirements and establish the basic functionality of the overall system design. This can be done with the aid of the ProAnnounce designer software if a pro announce based system is being employed. If a simpler system is used then often a basic charting package such as Visio is adequate to lay out the system.

Step 4 – Assemble the Equipment List

At this point an equipment list needs to be assembled and the hardware portion of the job can be estimated. Also labor estimates can be done as well after a site inspection has been conducted and physical layouts to scale have been constructed.

Upon completion of a thorough site survey, the system may be specified and quoted. The sales engineer may also generate the design and quote, often at the same time as the site survey. Success at this stage depends upon experience and product knowledge.

To avoid ambiguity and confusion at the installation stage, the specifications need to be as explicit as possible. Of course, it should enumerate all of the equipment proposed to do the job, and should include both a block diagram and an accurate floor plan with annotations regarding construction. In addition, it should provide details such as local volume control locations and height, the desired location for amp racks, and even names of the employees who are expected to use the system. To forestall disputes and clarify responsibility if changes are required during or after installation, the customer should be asked to sign a written agreement governing the specification.

Many contracting companies simply communicate the sales engineer's design directly to their installation department, who are charged with putting the system in and making it work. There are potential problems with this approach. For example, the salesman's natural tendency is to over-design and oversell when he can; if the client is amenable, the result can be an excessively complicated (and problematic) system. Moreover, it is easy to make mistakes in the flush of a sale, and these may be compounded when the system goes in.

To address such pitfalls, it makes good sense to have each proposal reviewed by a second engineering employee whose approval should be required before the specification goes to installation. At this stage, design details can be fine-tuned and potential problems can be addressed to assure that the design is feasible, efficient and free of unnecessary redundancy.

Expect The Unexpected

The distributed sound system market is highly competitive and margins are small. It makes good sense to do everything you can to avoid problems at the installation stage and to be ready to handle callbacks or last minute changes smoothly. One way to do this is to anticipate problems before they occur and build contingency plans into your operation.

For example you should always have some inexpensive "fixes" at the ready. Say that the customer decides to change his floor plan at the last minute, requiring you to add another zone to the system. You can offer an additional MA series shelf-mount mixer/amplifier that enables you to offer a painless quote for the requested change, and come out a hero. You can even avoid the additional cost of installing a volume control in the new zone by putting the amplifier on a shelf in the zone.

Similarly, it may make sense to pull a couple of extra cable pairs (both speaker lines and mike lines) when making your home runs. That way, if there's a base that wasn't covered in the specification, you can make it up onsite. The practice also facilitates expanding the system at a later date.

Be sure that the floor plans you use are up-to-date, and keep communications open with the client. Particularly if you are limited to using existing wiring, you need to know if the client's plans for space usage will remain the same. Otherwise, you may end up with a real headache — like having the emergency room announcements directed to the pediatric ward

Finally, it is vitally important to be sure that you know who in the client's company is authorized to make decisions when questions arise on the job site. If the building manager tells your installers to put the amp racks in the basement you don't want the owners calling you and insisting that they should have been in the second floor office

Standardizing for Profitability

One of the best strategies that we can recommend for success in contracting is to standardize your operations wherever possible. Settle on a few basic system designs that can be modified to cover a wide variety of circumstances and then educate your sales staff about them. Develop standard pricing calculations, in cost per hour, for all of the basic labor items — putting in a can, pulling a cable pair, installing a plenum run, and so on. Rather than trying out a new, whiz-bang esoteric product on each installation, stock a carefully selected complement of proven performers and use them consistently. Often you can achieve significant savings by reducing the number of suppliers whose products you use. When you use several suppliers, you encounter differing lead times, minimum order quantity requirements, freight policies and payment terms that complicate your ability to respond quickly and consistently to demands from your customers. These are “hidden” overhead costs that affect your ability to generate a profit.

Speaker Selection

Distributed loudspeaker systems for paging and background music are among the most important “bread and butter jobs in sound contracting. In most cities, new restaurants, hotels, health clubs and clinics are continually sprouting up. Each one has needs that can be met by a distributed system, and each represents a potential client for the enterprising contractor.

The overwhelming majority of paging and background systems are relatively small, however. With the margin on many installations running in the \$400 to \$600 range, there’s not much room for error or misunderstanding, since the cost of a single callback can eat up most of the profits. To succeed with distributed sound systems, the professional contractor needs to be able to count on his jobs going in smoothly and efficiently.

In this article, we’ll explore some of the “nuts and bolts” issues that affect profitability in the distributed sound system market, and offer suggestions for improving your chances of success in the business.

Ceiling vs. Surface Mount Systems

Several factors will determine the choice of surface mount or flush mount (ceiling) speakers for a given job. The most common criteria are:

- Audio coverage requirements
- Audio performance needs
- Building structure design
- Esthetic requirements of the environment

Evaluating the choices among these primary criteria will often determine the format which is required for a listening area. It is important to note here that any installation may employ both types of products for different areas or to meet certain performance needs. For example to gain more control over sound coverage surface mount speakers may be employed but ceiling mount subwoofers may be utilized to keep the esthetic “footprint” or design impact of the speakers on the space relatively small.

Selecting & Positioning Ceiling Loudspeakers

In the traditional approach to overhead-distributed systems, loudspeakers are located in a grid arrangement whose dimensions are dictated by the room height and the directivity of the speaker elements. Two basic placement patterns prevail: square spacing, and hexagonal (or crisscross) spacing.

In addition to the spacing pattern, the designer must choose between three density types, designated respectively as edge-to-edge, minimum overlap and center-to-center (see Figure 1). The greater the overlap, the more uniform the coverage — and the higher the cost. Budgetary

constraints tend to favor sacrificing density, so the optimum center-to-center configuration is, in practice, the least common of the three.

Ceiling Speaker Coverage

The main objectives in deciding about the placement pattern and density of loudspeakers in a distributed system are covering the area effectively, providing sound that is audible and intelligible over the entire listening area, and making sure the system is capable of sustaining whatever average and peak sound pressure levels the application requires.

A misunderstanding about the coverage angle specification of loudspeakers can easily result in system design mistakes. It is very common to see a “polar coverage” spec and assume that the speaker will actually cover this angle. Loudspeakers actually cover less area than their spec sheets would imply. (Let me clarify that the coverage angle is typically the angle at which the sound level is 6 dB down from the on-axis sound level.)

Polar vs. Listening-Plane Coverage. There are two different types of coverage measurements that often get confused for one another. It is standard in the loudspeaker industry to state the coverage in a polar pattern — in a sphere that is 1 meter from the speaker in all directions. The angle where the sound level is down 6 dB from the on-axis level is called the edge of the polar coverage pattern. This is what appears on spec sheets.

It's a legitimate specification, but it does not represent what the coverage will be over a flat listening plane, as in any room, because it doesn't take into account the difference in distances that people are from the speaker. For speakers projecting from a ceiling onto a flat listening plane, the sound has to travel farther off-axis (to the sides) than it travels on-axis (directly below the speaker) resulting in a much greater drop-off of sound level off-axis. The result is that the actual coverage angle (at -6 dB) on the listening plane is more narrow than the polar spec. Some ceiling speaker manufacturers use their polar measurement to claim extraordinarily wide coverage. Do not use this specification to lay out coverage patterns of ceiling speakers!

To illustrate. Imagine a loudspeaker with a 180° polar spec. If you were to incorrectly interpret this as 180° coverage on the listening plane, then one speaker would be all you would ever need for any application. But imagine a single speaker trying to cover an entire department store or restaurant. In fact, you will see that unless a speaker can send more sound to the sides than it does directly on-axis, it never covers more than 120°.

The sound system designer needs to work with the actual coverage over a flat listening plane because that is the plane in which we live, listening at a height of 3 to 6 feet above the floor, depending on how tall we are and whether we're standing or seated. This is called the listening-plane coverage specification of the speaker. The listening-plane spec represents the reality of the speaker's coverage for the listeners. Laws of physics dictate that the listening-plane coverage is always more narrow than the polar coverage pattern.

Let's take a speaker that has a 140° polar coverage (i.e., its 6dB down points) as an example. It would be a mistake to assume that this speaker can cover 140° over the listening plane. In fact, the level at the edges of a 140° pattern is actually more than 15 dB down compared to on-axis — not 6 dB down. It's interesting to note that the same proportions hold true for any ceiling height: No matter how high the ceiling is, the off-axis distance is even farther away by the same proportion. So for the loudspeaker in this example, whether the ceiling height is 8 feet or 20 feet, the listener who is at the edge of the 140° pattern, who you might think is at the 6dB down point is really 15 dB down.

The actual listening-plane coverage depends on the polar plot of each speaker. On average, the coverage of the listening plane from a speaker with a 140° polar coverage is usually between 90° and 110° .

Converting Coverage Specs to A Layout

How do you convert polar coverage to listening-plane coverage as you design sound systems? There are two ways. One is to use the EV ceiling speaker layout program that does the conversion for you. For more elaborate analysis you can use EASE. EASE can determine intelligibility and map the SPL output of your entire installation. Usually that's not necessary however, as you can easily do a little bit of math and figure out what the real listening plane coverage angle of the speaker is.

The second way to compute the listening-plane coverage is to start with the exact polar plot of the speaker and use a conversion table. (Real polar plots directly from test equipment are more accurate than an artists' redrawing.) Polar plots are usually normalized to the on-axis value, which is usually labeled "0 dB." For every angle off-axis, there is a "difference-figure" between this normalized on-axis value and the volume at that angle.

To convert to listening-plane coverage, add the 3dB Correction Factor figure from Table 1 for that angle off-axis to the figure from the polar plot. If you're doing this correctly, the coverage pattern is getting more narrow than the original polar plot.

By using the actual polar plot of the speaker and applying these correction factors from the chart, the angle that results in a figure of -6 dB is the angle of coverage for the speaker. This angle is the real 6dB-down angle for that loudspeaker when it is projected onto the listening plane. Remember that this coverage angle is valid regardless of the ceiling height.

If we take the polar plot of a hypothetical speaker with 140° coverage, we see that at 70° off-axis (140° total for both sides) the level is down 6 dB compared to the on-axis level. By looking at the polar-to-listening-plane conversion chart, we need to add -9.3 dB to this -6dB figure to find the actual level on the listening plane at this off-axis angle. We find that the level of this 140° speaker (as specified by the polar coverage) is actually -15.3 dB, not -6 dB, down at 70° off-axis. Therefore, listeners located at this off-axis angle will hear sound that is more than 15 dB down from the level they hear when they pass directly underneath the speaker. This is a very large difference. Keep in mind that these coverage angles are averaged over the frequency spectrum and will generally not give the rated coverage at every specific frequency.

To find the actual 6dB down point of the speaker for the listening plane, take the actual polar plot of the speaker and at every increment of 5° off-axis, apply the correction factors from the polar-to-listening-plane conversion chart. The 6dB-down angle is that angle at which the new figure reads -6dB (polar dB down plus the additional dB down from the correction factor). While the final resulting angle depends on the actual polar plot of the speaker, it can generally be said that most speakers with a nominal polar coverage of 140° can be expected to reach -6dB between 45° and 55° off-axis, resulting in an actual listening-plane coverage between 90° and 110°.

Now let's take a speaker that has a 180° polar coverage. Let's further assume that it is a mythical "perfect" speaker where the volume doesn't go down at all at any angle. Its polar pattern when placed in a ceiling is a perfect half-circle. To find the real 6dB-down point, we apply the correction factors and find that at 60° off axis (120° coverage), the sound is 6 dB down. Therefore, the real listening-plane coverage of a perfect 180° speaker is only 120°. Now, let's realize that a speaker with a 180° polar coverage "spec" can actually be down 6 dB at full off-axis and still have a spec of 180°. In this case, its coverage is going to be even less than 120°.

An Example of Coverage Pattern vs. Speaker Size

For installations involving basic low level background music and paging, system designers often specify 8-inch cone loudspeakers for distributed overhead systems, at least in part because they represent the traditional choice. In many cases, however, you can achieve equal or better results — at a significant savings — by using specially designed 4-inch elements. Characterized by somewhat smoother frequency response and less susceptibility to feedback than 8-inch elements, 4-inch units are also generally less expensive and offer a real advantage in reduced directivity.

The EVID C4.2 is just such a 4" speaker. The effect of the C4.2's wider dispersion is indicated in the figure at the right. In applications where reverberation is not an issue, the C4.2 (shown with coverage pattern "A") offers greater overlap and, thus, more uniform coverage than an 8-inch unit (coverage pattern "B"). When specifying a new system, you can take advantage of the C4.2's wider dispersion to decrease the number of speakers required to cover a given area. This will result in even greater savings.

Of course, a 4-inch unit will typically be somewhat less sensitive than a comparable 8-inch: for equivalent motor assemblies, the difference is on the order of 3 dB. The 4-inch will also have slightly reduced low-frequency capabilities.

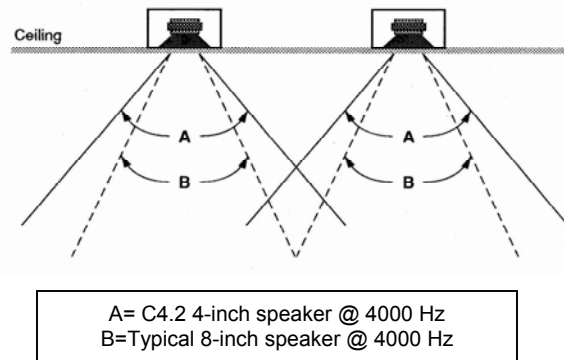

Neither of these factors is a significant problem in most distributed systems, however. The C4.2 is conservatively rated to handle far greater power than most standard 8-inch units so its continuous SPL output will be more than adequate. Moreover, its reduced output below 150 Hz actually gives it an edge in intelligibility, since low-frequency energy is most likely to excite ambient reverberation. For these reasons, the C4.2 represents a great way for you to improve the performance of your distributed systems while maintaining a competitive edge in price quotes.

When Controlled Coverage is Needed

In some installations coverage control is clearly essential to maintain intelligibility and listenability. In these cases a speaker which provides controlled coverage over as wide a bandwidth as possible is needed. In live room environments the reflection of sound off of walls can be a major cause of intelligibility problems. The two examples below illustrate the effect of speaker dispersion in a room. The first example is the EVID C8.2 speaker with it's 110 degree coverage pattern at 1kHz. The next illustration is the controlled coverage EVID C8.2HC unit with it's 75 degree spec. As you can see the effect of the controlled coverage in the C8.2HC has a dramatic effect on the energy spilled onto the walls. The result will be a more intelligible installation using the C8.2HC.

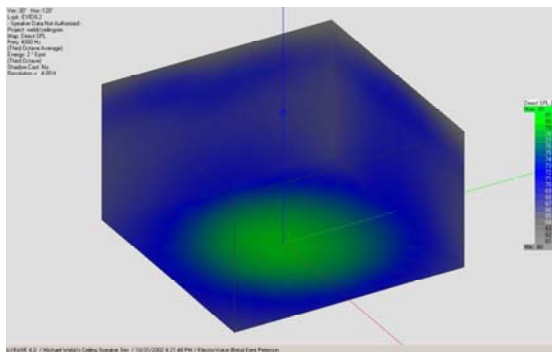

C8.2 Speaker Coverage at 2kHz

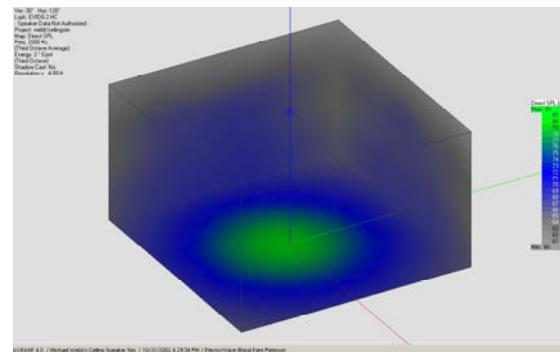

C8.2HC Speaker Coverage at 2kHz

The Use of Subwoofers

Subwoofers are an important part of an outstanding business music system. Light background or foreground music might not require subwoofers; however, even in systems where the bass doesn't need to be a dominant factor, having clear low frequencies can make a big difference in the customers' enjoyment of the music.

The number of subwoofers to use, where to position them, how to set the taps (on 70V/100V subs) and how loud to run them vary depending on the characteristics of each installation. Criteria

such as speaker placement, boundary loading (are speakers placed close to a wall or in a corner?), size of the room, coupling of multiple speakers/subwoofers, reverberance of the room, the type of music, the type of activity and the expectations of the listeners all come into play.

Positioning Subwoofer Components

Hanging a subwoofer in the middle of a room results in the lowest possible output from the subwoofer. Placing a subwoofer at the ceiling, wall or floor increases its output. Placing it within a few feet of a 2-boundary junction (like a ceiling/wall junction or a wall/wall junction) increases its output further. Placement within 3 feet of a corner increases its output still more. In these cases, there is both an increase in sensitivity (output per watt of input) and in maximum total SPL capability. This can help in getting as much sound as possible from a few subwoofers. However, there is a potential pitfall in placing a subwoofer in a corner: You can wind up with uneven bass coverage in the room.

Because there are often so few subwoofers, you can have a problem getting even coverage of the space. People sitting or standing very close to the subwoofer are going to hear excessive lows while people who are father away might not be getting enough.

To resolve this problem keep in mind that as you move farther from the sub, the volume drops off, typically at 6 dB per doubling of distance. Then, when you reach a certain distance, the subwoofer level stops dropping off at such a high rate. This is called the critical distance, which is where the reverberant field within the room equals the direct sound from the subwoofer. The critical distance depends on how reverberant the room is. As you get farther past critical distance, even though the level of the subwoofer doesn't drop off nearly as quickly, the quality of the subwoofer sound might not be as good. But even though this may happen, it's sometimes acceptable for subwoofers in business music applications.

One way to make the subwoofer coverage as even as possible is to use more than one. In many places, it's a good idea to add a second subwoofer, or more. Even if you don't need additional subwoofers for volume reasons, you might want to consider them just for evenness of subwoofer coverage. Generally, if you have to use just one subwoofer, it is best to sacrifice the sensitivity increase and place the subwoofer for most even coverage, as long as you can achieve the SPL goals.

Choosing the Best Mixer/Amplifier

Practical distributed sound system installations almost always require the ability to handle multiple signal inputs. Pages may originate from two or more sources, the telephone system and a hand-held microphone, for example. Background music from two selectable sources, with muting keyed to the paging input(s), may also be required. There may even be a need for a low-level noise-masking signal mixed in with the other signals at a consistent, adjustable level.

For these reasons, combined mixer/amplifiers are commonplace in sound contracting. Designed to handle several audio inputs at different signal levels and source impedances, such units incorporate mixing and automatic muting along with amplification. By efficiently consolidating often-used functions in a single enclosure, they greatly simplify routine installations, reducing costs and increasing reliability.

In this article, we examine the criteria for selecting mixer/amplifiers, describe the range of alternatives offered by ElectroVoice Sound, and suggest applications for each. Our aim is to encourage appropriate equipment choices to maximize both profitability and customer satisfaction.

Analyzing the Application

The first step in selecting a mixer/amplifier is to examine the demands of the application. What are the intended uses for the system? Will background or foreground music be required in addition to paging? If so, from what type of source: FM/AM radio, tape, or both? Where will pages

originate, and from what type of interface? The answers to questions such as these will help to determine the input configurations of the unit.

Similarly, take a look at the expected load requirements. For example, how many loudspeakers will be needed to adequately cover the space and assure good intelligibility? What type of loudspeakers will best serve the application: ceiling speakers, wall speakers, paging projectors, or a combination of different elements? Will 25V or 70.7V distribution be necessary, or is a direct voice coil connection sufficient? Must the system handle multiple independent zones? Such factors will determine the power output required of the unit.

Additional elements to consider include the level of ambient noise and reverberant characteristics of the space, along with the frequency response of the sources and loudspeaker elements; these will affect the audio quality of the system. Packaging also should play a part in your design. Must controls be user-adjustable, for example, or should they be tamper-proof? Will the mixer/amplifier be rack-mounted with other equipment? Must the system operate in a dusty or moist environment, or where users will have dirty hands or be inexperienced? Finally, remember the bottom line: what percentage of the cost of materials sold on the job is represented by the cost of the unit? Once you have initially specified the requirements of the system, you can narrow down your choice of mixer/amplifiers for the job.

ElectroVoice offers two mixer/amplifiers designed to suit a wide variety of sound contracting needs. The MA1212 or 1206 units are mixer/amplifiers with either 120 or 60-watt output capabilities. Mountable on a shelf or in a rack, these units accommodate up to 12 different input sources to permit larger complex configurations with off-the-shelf convenience. Tone controls are provided, along with outputs to drive supplementary systems such as booster amps or tape recorders.

When To Specify Mixer/Amplifiers

The performance of integrated Mixer/Amplifiers is more than adequate for the vast majority of distributed sound installations.

Consider, for example, the question of frequency response. The MA models exhibit a low-frequency limit of 50 Hz, and an upper-frequency limit between 15 and 20 kHz. Is this good enough? To answer this question, we need to examine the performance of other components in the signal chain.

Let's examine the response of a typical 8-inch ceiling speaker in a 1.8 ft³ sealed box. At the low end, the unit begins rolling off below about 150 Hz and is nearly 20 dB down by 50 Hz. Its response also rolls off above 5 kHz, and is nearly 10 dB down at 20 kHz. Paging projectors, used in a wide variety of industrial applications, will introduce even more severe response limitations, along with greater harmonic distortion.

Similar conditions apply at the system input. Background music players and FM stations, for example, are limited to the bandwidth from 50 Hz to 15 kHz, at best. Push-to-talk paging microphones, such as the ElectroVoice US600EL, are tailored for the voice range and thus feature far more limited frequency response. Telephone paging lines are further limited in response, and can introduce greater distortion.

Remember that using an amplifier with significantly wider bandwidth than the signal source and/or output devices will serve primarily to increase noise and distortion in the system. An amplifier which reproduces low frequencies below 200 Hz when driving a paging projector with a 300 Hz to 500 Hz lower cutoff will be wasting power (reducing headroom in the pass-band) and may cause intermodulation distortion if not premature failure in the paging projector. In this context, the audio specifications of the utility units in our example begin to look appealing. In fact, whenever the program source, paging mic or loudspeaker system exhibits limited bandwidth, there is a diminished need for an audiophile-quality mixer/amplifier system. The majority of practical installations fall within this category. In professional buildings, office structures, warehouse paging

systems and outdoor installations, a utility model will serve the client's needs just as well, and decrease the equipment costs.

Approached methodically and logically, the choosing of a mixer/ amplifier for a distributed sound system can be a painless and efficient process. Don't select a "pro spec" unit when all you need is a utility amp; you'll be wasting money and it won't do the job any better. As we have shown, by applying a little analytical thought and care, you can satisfy clients' needs while keeping costs in line. And that's what the sound contracting business is all about.

When the Job Calls For ProAnnounce!

When the system specification calls out for a routed zoned system then ProAnnounce is the best avenue. There are a few key decisions to make to determine the basic equipment makeup of the installation.

First, the design process and site survey should have established the basic signal structure of the installation. This will define if a DRM4000 8x2 unit is sufficient or if one or more of the powerful DPM4000 4x4 routers are called for. If the installation calls for a DPM4000 unit you must determine if more than a single DPM4000 is needed and what input cards are required. Second, if additional zones beyond the basic 4 are being used then the DCS 400 system is required. This allows for a large, extended, relay controlled routing network for paging. Third, if automatic messaging is desired then a DMM4650 may need to be added. This will provide additional flexibility for prerecorded announcements and signals. Finally, if any additional external controls are being added (remote audio volume or source switching for example) then the appropriate DCS control module will be needed.

The DRM4000 vs. the DPM4000

In order to determine which cpu is best for an installation the designer needs a good working understanding of each of the units capabilities. To better understand the difference between the DRM4000 and the DPM4000 an overview of each is provided below.

DPM4000 4x4 Matrix Router

The DPM4000 is essentially a 4 x 4 digital matrix with added DSP capabilities. Actually, when you factor in the internal alarm/chime functions, message stacking, and pre-recorded message functions it is more like a 7 x 4 matrix. Processing in the form of level and EQ is provided on each of the four external inputs to the system. In addition, level and optional delay is provided on each of the four outputs in the system. Analog compression is also available on certain input cards, as well as, the paging stations. The DPM 4000 can be configured to perform tasks based on a variety of control inputs. Likewise the DPM 4000 can provide a variety of control outputs. Examples of these inputs and outputs might be: a contact closure from a fire alarm results in an alarm and voice message automatically sent to the loudspeaker system, pressing a button on a paging station or wall control raises or lowers a video screen and turns on or off the video projector, a maintenance worker uses his cell phone to turn the lights on or off in a given area of a building, an amplifier failure is detected, a backup amplifier is switched into operation and maintenance personnel are notified of the failure. The possibilities are only limited by one's imagination and ingenuity. The DPM 4000 can be configured for a variety of audio routing tasks in addition to the normal paging applications. The unit is especially suited for background music applications in such venues as restaurants, shopping centers, and specialty stores. The DPM 4000 can even be used for very small room combining applications (up to four rooms).

DRM 4000 Mixer

Unlike the DPM4000, the DRM4000 can be used with very little preprogramming. Many of the functions are externally selectable or adjustable. The DRM4000 can be used either in a stand-alone mode or in conjunction with the DPM 4000. The DRM 4000 can be used to enhance the DPM 4000's input and output capabilities. The DRM 4000 features eight stereo RCA inputs, four

XLR mic/line inputs, eight GPI control inputs, two XLR outputs capable of either independent or stereo operation, and two VCA level inputs. In addition, two of the XLR mic/line inputs can be configured for paging with adjustable ducking. The DRM 4000 can be programmed to change its configuration through presets assigned to the GPI inputs, PC control (RS-232), or DPM 4000 control (RS-485). A good example of using the DRM 4000 stand-alone is in a typical restaurant/bar application. There may be multiple sources such as TV, tuner, CD player, music server, etc. . . and you may want a different source in the bar area such as the TV for the big game, while in the restaurant you might want some jazz playing in the background. In addition, you may want the hostess to be able to selectively page in the bar area for customers that are waiting for tables in the restaurant.

Volume And Tone Controls / Delays

The ProAnnounce system provides individual volume controls for each input, output, and paging station. Even the internal audio sources, like gong/alarm tone generators, voice message playback, and pilot tone generator employ individual level controls, each. Additionally, it is possible to set an attenuation that unanimously affects the inputs. This value determines the degree, by which the input signal is attenuated during the reproduction of messages or other signals with a higher priority setting. This allows to smoothly fade-out and fade-in background music during the transmission of important messages.

Besides, each of the four inputs embodies three fully parametric digital filters allowing for optimal tone control. The filters provide different filter types like Hi-/Lo pass filters, shelving filters, and peak-dip-filters providing the possibility for adjusting the sound within the entire audio transmission range. Factory-preset filter settings for the DPC 4000 Series paging stations are already provided.

Setting volume levels and filter parameters is accomplished via PC during the configuration procedure. Further, it is possible to alter any volume setting during the later operation of the system via special-function keys on the paging stations or through external controls that are connected to analog or digital control inputs.

All four outputs employ digital delays allowing signal delays of up to 330 ms per channel. Natural delays, resulting from loudspeaker positioning, which causes time differences in the arrival of sounds or environmental circumstances related to architectural characteristics of the location, can be equalized without additional effort.

Signal Generators / Voice Message Memory

The DPM 4000 provides a variety of tone generators for the generation of gong, alarm, and text signals. Signal generation is realized through DSP-algorithms, which are extremely flexible in use, so that they can be adjusted to match nearly any possible application. Factory presets include 6 different gong signals, 18 different alarm signals, plus sine cycle at any frequency. Other than in comparable equipment, the ProAnnounce signal generating DSP-algorithms do not take up any extra storage of the voice message memory.

In addition, a voice message recording/playback module providing CD-quality sound is optionally available. With a total recording time of approximately 6 minutes, 25 different messages are being managed. The DPM 4000 provides the possibility to install up to four optional FLASH-memory modules, depending on individual desires or requirements.

Control Inputs And Outputs

By using the control inputs, it is possible to link the ProAnnounce system to fire alert systems, burglary alert systems, or to a central operating desk. It is also possible to connect external switches, breakers, rotary controls or rotary encoders, respectively to query control outputs of external units (power supplies, power amplifiers).

The control outputs allow switching external devices ON or OFF, trigger signals and events, switch monitor sources, remote control doors, gates or shutters, generate analog signals for the control of multimedia systems, etc.

A total of 130 control inputs for logic levels, 128 control inputs for analog levels, 16 inputs for rotary encoders, 127 logic-control outputs, and 128 analog-control outputs are usable.

Clock / Calendar

The ProAnnounce manager DPM 4000 has an integrated quartz-controlled real-time clock which can be set for automatic operation. The system clock automatically recognizes leap years and, if in auto mode, automatically switches between daylight saving time and standard time.

The system clock provides the possibility to control up to 40 external slave clocks. For this purpose, the DPM 4000 employs a special, short-circuit-proof output for pole changing impulses. Slave clocks are automatically re-synchronized whenever a time difference to the system clock is detected; like for instance in cases of power outage or when time values were entered manually.

It is possible to activate pre-set functions like break-gong signals, background music, remotely controlled gates, switch lights ON/OFF, etc., when using system clock and calendar functions together. All the functions mentioned before can be programmed for specific days; but also hourly, daily, weekly, monthly, and yearly activation is possible. Up to 500 time-controlled events can be programmed.

Monitoring

The ProAnnounce manager DPM 4000 embodies a monitor amplifier with headphones/speaker output. The integrated logic-switching circuit provides the opportunity to listen to the signals of any internal input and output. Assigning external sound sources to the monitor bus is possible as well. This additionally allows monitoring amplifier outputs or pre-listen to the contents of external voice message memories and other audio devices.

The remote control's wiring already includes all the cabling necessary for the pre-/post-listen feature when using remote-controlled amplifiers. In addition, when using the DCS 420 ProAnnounce MONITOR MANAGER, additional programming operating flexibility is available.

Macros

Macro is defined as the combination of several commands, functions, and their parameters in an internal consecutive sequence. For example a gong signal with specific volume and priority settings has to be transmitted in different calling zones, while simultaneously activating a control output. In that case the macro consists of the functions "gong" and "control" with the parameters gong-type, volume setting, priority number, calling zone numbers, and the type and id-number of the control output.

It is possible to initiate a macro via the special function keys on the paging consoles or to trigger it via control input. It is also possible to combine a macro with the internal clock or calendar.

The ProAnnounce system provides a number of pre-programmed macros, where only individual parameters still have to be entered. Additionally, it is possible to combine several macros in a sequence. Using pre-defined macros and sequences lets you create new, user-specified and application-related macros, which basically are capable of managing any control function imaginable. A total of up to 250 user-macros can be programmed.

Interfaces

Besides its control inputs and control outputs, the ProAnnounce system provides additional interface ports. The connection of paging consoles to the ProAnnounce manager DPM 4000 is performed via serial RS-485 ports. This allows connecting up to four terminals at a single port.

Power amplifiers and the DCS 400 controller are connected to another independent RS-485 port, which allows direct management of up to 64 power amplifiers and 8 DCS 401.

Connecting a PC is established via serial RS-232 port on the rear panel of the DPM 4000. It is not necessary for the PC to be permanently connected to the DPM 4000.

An additional RS 485-interface offers the possibility to operate several DPM 4000 in a network.

Station Control Consoles

The ProAnnounce system includes 5 different models of DPC 4000 Series paging stations and one paging station extension. All microphone terminals employ gooseneck microphones, 6 or 8 function keys and a covered alarm key. An additional alarm key and a key-locked switch can be retrofitted. The paging stations are available with 10, 20, 30, or 50 selection keys. All models also employ LC-displays (2 lines with 16 characters each).

The following list provides you with an overview of available paging station models:

DPC 4106	6 function keys
DPC 4510	8 function keys + 10 selection keys + alarm key
DPC 4520	8 function keys + 20 selection keys + alarm key
DPC 4530	8 function keys + 30 selection keys + alarm key
DPC 4550	8 function keys + 50 selection keys + alarm key
DPC 4350	paging console extension with 50 selection keys

All consoles include the following common features:

- all functions are processor-controlled
- configuration data is stored in non-volatile FLASH RAM
- condenser microphone with pre-amplifier and compressor / limiter circuitry
- freely programmable key-assignment
- easy key-labeling through label-strips and MS WORD™ templates
- analog circuitry surveillance via integrated pilot tone generator
- processor surveillance via watchdog function
- line surveillance via pilot tone and polling functions
- covered alarm key (not with DPC 4106)
- additional alarm keys or key-locked switches can be optionally retrofitted
- connection of an external PTT-microphone or audio source
- piezo buzzer for acoustical alerts
- an optional loudspeaker can be retrofitted
- setup-mode allows direct parameter setting at the paging station
- two-line LC-display

All paging consoles are processor-controlled and extensive monitoring functions are provided. The watchdog function monitors the processor system while a switchable pilot tone generator monitors the audio section. Additionally, the internal supply voltage is constantly measured. When it falls below a critical threshold an alert message is being displayed. The line surveillance function recognizes any line-interruption and/or short-circuits in the audio and RS-485 control cabling. Upon the detection of failure a corresponding message is displayed.

Understanding DCS Expansion Options

The ProAnnounce™ DCS expansion system uses a variety of cards for control, monitoring, and routing purposes. These cards are available in two versions. The standard DCS 4xx versions are circuit cards or modules that mount on standoffs and interconnect via flat ribbon cables. The DCS 4xxR cards are identical in function to the standard cards, but use a card cage with a backplane for interconnection. The ProAnnounce™ Designer software only refers to the standard DCS 4xx cards, however they are interchangeable.

The DCS 400 Expansion Chassis

The DCS 400 expansion chassis uses essentially the same techniques for installing the cards/modules as is used when installing cards in the DPM 4000. The left-most card (as viewed from the rear) is always either a DCS 401R controller card, or a DCS 405R extension card. The DCS 405R cards are used to expand from one DCS 400 chassis to another. The way this works is that the DCS 405R is the last card in the first DCS 400 chassis (the one with a DCS 401R card in the left-most slot). The first card in the expansion DCS 400 chassis is a DCS 405R. Cables are attached between the two cards. While most installations do not require expansion chassis, there are times when the number of cards under the control of a single DCS 401R exceeds the ten card limit of a DCS 400 chassis. Relay Wiring DCS 408/409 and DCS 408R/409R relay cards are used for a variety of applications in the ProAnnounce™ system. One of the primary uses for them is the control of line or speaker level audio. The DCS 409/409R is used for low voltage and line level audio signal switching. The DCS 408/408R is used for high voltage and speaker level audio signal switching. Both cards ship with a number of wire jumpers installed to create a common buss. Depending on your needs the cards may work without the need to remove any of the jumpers, however some applications will require that you do so. Complete isolation of the relays is possible if all of the buss jumpers associated with that relay are removed.

BGM and Paging System Designs

The following pages show a variety of system examples using all of the components we have talked about in the preceding pages. These systems are practical, real world, examples you can adapt and use for your own installations.

BGM Installations - System Examples

Retail Store – Single Zone

This basic retail example illustrates a simple installation to control 3 sources within a single zone of audio in a 2,500 sq ft space. The system has one paging microphone at the cashiers desk and telephone paging can be implemented if necessary through the phone system. There is a background music source consisting of a CD player.

The C4.2's are tapped at 7.5 watts and the C10.1 is tapped at 30 watts.

System Layout

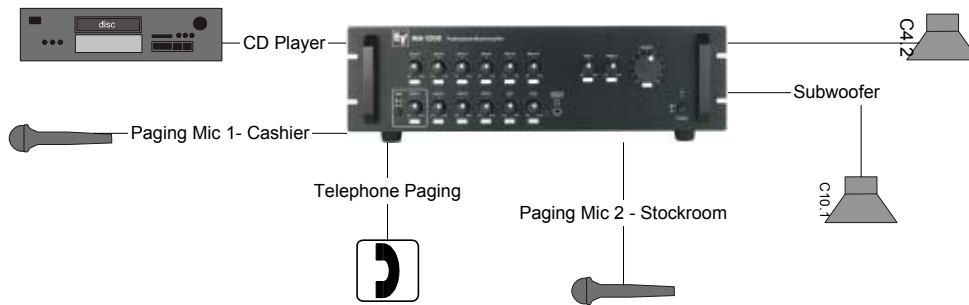

System Equipment List

Model	Location	Description	Quantity
SPEAKER SYSTEMS			
EVID C4.2	Main	Ceiling Speaker	3
EVID C4.2	Restrooms	Ceiling Speaker	1
EVID C10.1	Main	Subwoofer	1
Amplification			
MA1212	Office	Mixer/Amplifier	1
OTHER RELATED EQUIPMENT			
	Various	Rack/Misc	1
	Various	CD Player/Tuner	1
	Various	Wire	1

Office Building - 5 Zone - Simplified system

Layout Overview

This very basic office building example illustrates the interconnectivity and flexibility of these components. Here we take a stand-alone ProAnnounce DCS408 card and have it do the zone switching for a basic paging only system. The 408 card routes the signals to one of the 5 amplifier channels. The zone selection is controlled via the MP756 11 zone desk microphone.

A combination of C4.2's and PA430t's are used in this installation.

System Diagram

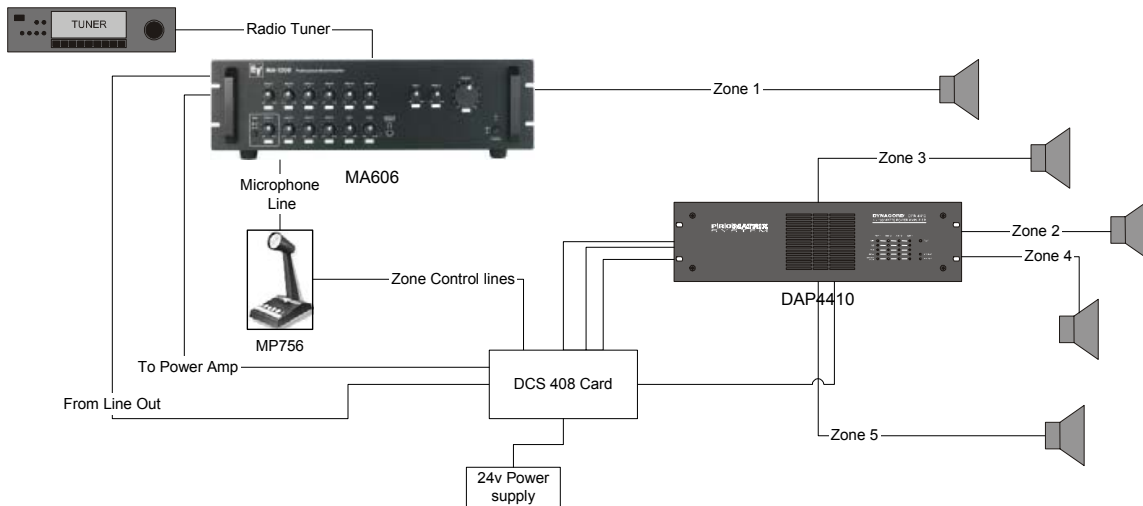

Equipment List

Model	Location	Description	Quantity
SPEAKER SYSTEMS			
PA430t	Various	Paging Horn	2
EVID C4.2	Various	Ceiling Speaker	5
PROANNOUNCE EQUIPMENT			
MA606	Office	60 watt mixer/amplifier	1
DPA4410	Office	4x100 power amplifier	1
MP756	Office	Paging Microphone	2
DCS408	Office	Relay card	1
DPP4002	Office	Power supply	1
OTHER RELATED EQUIPMENT			
	Various	Rack/Misc	1
	Various	CD Player/Tuner	1
	Various	Wire	1

Bar-Restaurant - 2 Zone

Layout Overview

This basic bar/restaurant example illustrates a simple installation to control 3 sources and 2 zones of audio within a 7,500 sq ft building. It demonstrates the effective use of the DRM4000 router for a basic 2 zone BGM system. The two zones consist of one for the bar area and the other for the main dining room. The system also has one paging station at the hostess stand. The three sources are for a music server, tuner and television audio.

The C4.2's are tapped at 7.5 watts, the 4.2t's at 15 watts and the C10.1 is set at 8 ohms.

System Diagram

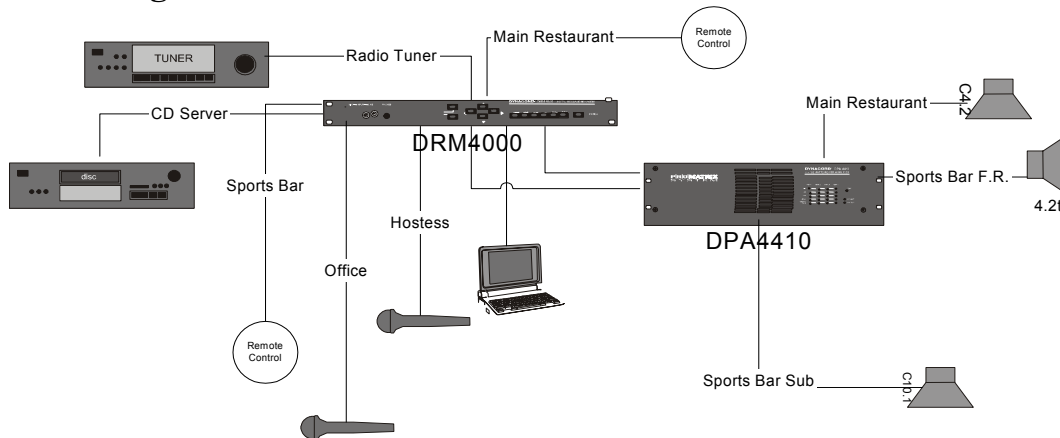

Equipment List

Model	Location	Description	Quantity
SPEAKER SYSTEMS			
EVID 4.2t	Bar	Surface Mount Speaker	2
EVID C4.2	Restaurant	Ceiling Speaker	5
EVID C10.1	Bar	Subwoofer	1
PROANNOUNCE EQUIPMENT			
DRM4000	Office	8x2 Matrix Router	1
DPA4410	Office	4 Channel Amplifier	1
253	Office	Paging Microphone	2
NRS90258	Office	PC Interface	1
TBA	Various	Wall Controls	2
NRS90257	Office	Power supply	1
OTHER RELATED EQUIPMENT			
	Various	Rack/Misc	1
	Various	CD Player/Tuner	2
	Various	Wire	1

Health Club - 4 Zone

Layout Overview

This example is a small to medium size health club with four separate listening zones and 6 sources. Also present are 3 separate paging areas.

The zones are laid out with 4 zones including a Snack Shop/Retail/Lobby Area, Pool Area, Exercise room and Spin Room.

The paging stations are located at the main front desk, the exercise room main desk, and the managers office. The six sources consist of television audio, CD player, digital satellite feed and 2 paging consoles. The DCS420 allows for monitoring of the system and all zones from the managers office. A DTI2000 is used to enable paging from any in house phone. The C4.2's are tapped at 7.5 watts, the 6.2t's at 60 watts, C10.1 and the 12.1's are set at 8 ohms.

System Diagram

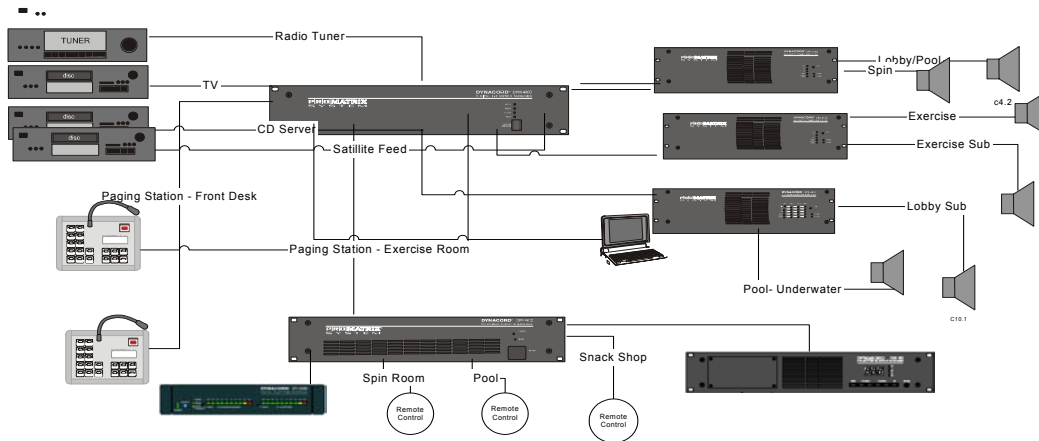

Equipment List

Model	Location	Description	Quantity
SPEAKER SYSTEMS			
EVID 6.2t	Exercise	Surface Mount Speaker	8
EVID C4.2	Pool/Lobby	Ceiling Speaker	16
UW30	Pool	Underwater Speaker	2
EVID 12.1	Spin/Exercise	Subwoofer	4
EVID C10.1	Lobby	Subwoofer	1
PROANNOUNCE EQUIPMENT			
DPM4000	Office	Matrix Manager	1
DPA4206	Office	2x600 Power Amplifier	2
DPA4411	Office	4x100 Power Amplifier	1
DTI2000	Office	Telephone Interface	1
DPC4510	Office	Paging Console	2
DPP1004	Office	Power supply	1
DCS401R	Office	Controller Board	1
DCS416R	Office	A/D Board	1
DCS400	Office	DCS Rack	1
DCS420	Office	Monitoring unit	1
NRS90218	Office	Output Card	1
NRS90216	Office	Input Card	1
NRS90234	Office	Input Card	1
NRS90240	Zones	Wall Control Module	3
OTHER RELATED EQUIPMENT			
		Rack/Misc	1
		CD Player/Tuner	2
		Wire	1

Retail Clothing Store -2 Zone

Layout Overview

This is an example of a typical retail clothing storefront with two separate merchandising areas for customers. One is the young women's clothing section tailored more for high school and college age customers and the other would serve the older 25 to 35 year old women's segment. Each of these groups shop differently and have different tastes in clothing, music, and personal interests. In this example, the music programming is divided into three sources and routes to two different zones. There is also separate message tracks for promotion announcements present for each zone geared to the clothing specific to that section. A standard 253 desk microphone provides the paging capability at the cashier station.

The C4.2's are tapped at 7.5 watts and the C10.1's are set at 30 watts.

System Diagram

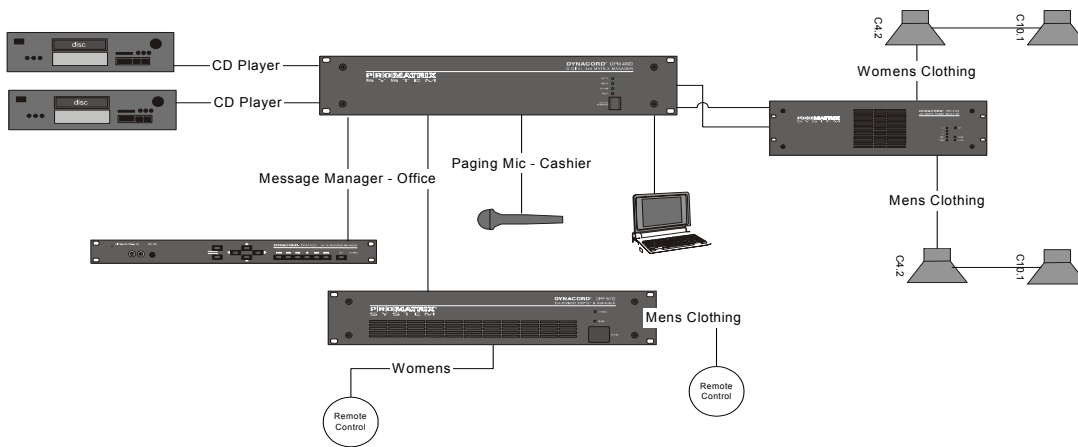

Equipment List

Model	Location	Description	Quantity
SPEAKER SYSTEMS			
EVID C4.2	Mens/Womens	Ceiling Speaker	16
EVID C10.1	Mens/Womens	Subwoofer	4
PROANNOUNCE EQUIPMENT			
DPM4000	Office	Matrix Manager	1
DMM4650	Office	Message Manager	1
DPA4260	Office	2x600 watt Power Amplifier	1
253	Cashier	Paging Microphone	1
DPP1004	Office	Power supply	1
DCS401R	Office	Controller Board	1
DCS416R	Office	A/D Board	1
DCS400	Office	DCS Rack	1
NRS90216	Office	Input Card	1
NRS90234	Office	Input Card	1
NRS90240	Various	Wall Control Module	2
OTHER RELATED EQUIPMENT			
		Rack/Misc	1
		CD Player	2
		Wire	1

Large Department Store - 6 Zone

Layout Overview

To extend the power of the ProAnnounce routing system the DCS control system can be used to page to different zones. This system shown here uses such an expansion. In a large department store many independent programs and zones are needed. This system can accommodate these requirements. This system has 3 music sources and 4 paging stations laid out over 6 zones. Each requires distinctly different paging needs. The 4 paging consoles used are located at the 3 main cashiers areas and one in the manager's office.

In this configuration the 3.2t's and C10.1's are run off of the 4410 amplifier with the C10.1's tapped at 15 watts. The C4.2's for the main floor are tapped at 7.5 watts and are run using the 4260 amplifier.

System Diagram

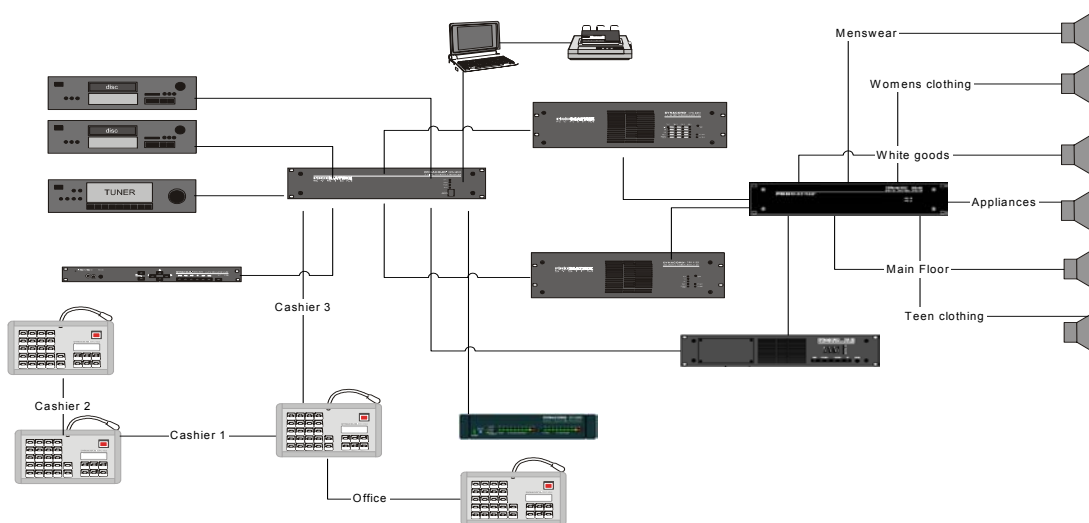

Equipment List

Model	Location	Description	Quantity
SPEAKER SYSTEMS			
EVID 3.2t		Speaker	7
EVID C4.2		Ceiling Speaker	15
EVID C10.1		Subwoofer	4
PROANNOUNCE EQUIPMENT			
DPM4000		Matrix Manager	1
DMM4650		Message Manager	1
DPA4260		2x600 watt Power Amplifier	1
DPA4410		4x100 watt Power Amplifier	1
DPP1004		Power supply	1
DCS401R		Controller Board	1
DCS408R		Relay Board	1
DCS416R		A/D Board	1
DCS400		DCS Rack	1
NRS90218		Output Card	1
NRS90216		Input Card	1
NRS90234		Input Card	1
NRS90240		Wall Control Module	4
OTHER RELATED EQUIPMENT			
		Rack/Misc	1
		CD Player	3
		Wire/Misc	1

Basic Warehouse - 5 Zone

Layout Overview

The ProAnnounce system can be extremely cost effective as illustrated in this example. This system allows for flexible paging into 5 different zones with a single dual channel amplifier. This maximizes flexibility while minimizing cost. This system has 1 BGM feed and 2 paging feeds laid out over 5 zones. Each requires distinctly different paging needs. The paging console is located at the main reception desk while the DTI2000 allows for paging through any phone system.

In this configuration the C4.2s are for the office feed while the PA430's are zoned for different areas of the warehouse. The system is run through one DPA4260 providing 1200 total watts

System Diagram

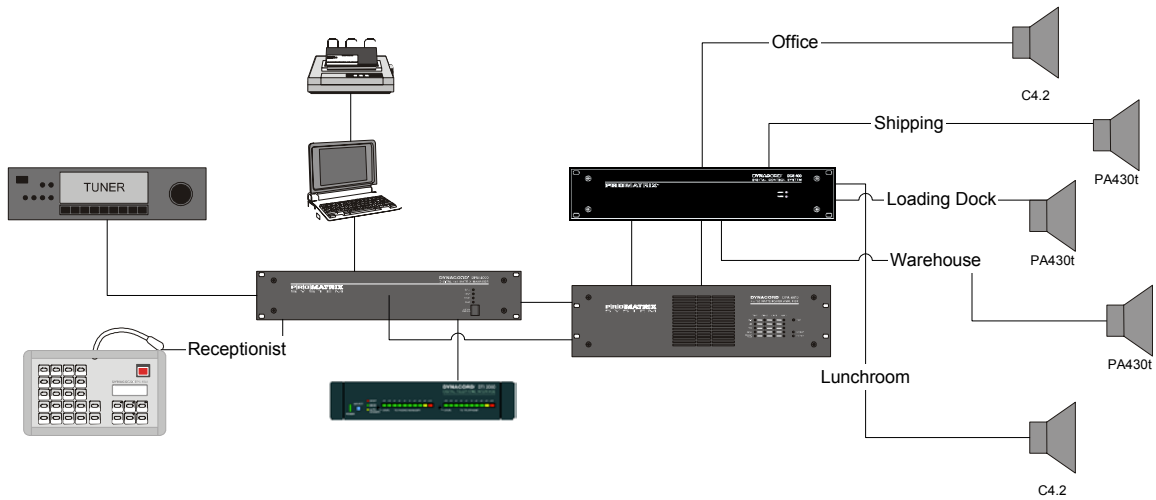

Equipment List

Model	Location	Description	Quantity
SPEAKER SYSTEMS			
EVID C4.2		Ceiling Speaker	20
PA430t		Paging Horn	15
PROANNOUNCE EQUIPMENT			
DPM4000		Matrix Manager	1
DPA4260		2x600 watt Power Amplifier	1
DPP1004		Power supply	1
DCS401R		Controller Board	1
DCS408R		Relay Board	1
DCS400		DCS Rack	1
NRS90216		Input Card	1
NRS90234		Input Card	1
OTHER RELATED EQUIPMENT			
		Rack/Misc	1
		Wire/Misc	1

Multi-Use Warehouse, Factory & Office Facility - 15 Zone

Layout Overview

This example shows how ProAnnounce can be used to control the audio routing for BGM and paging over a very large facility. The combination of 4 channels of amplification and DCS expansion components allow for this flexibility. The design calls for separate zoned signal paths for the warehouse, office, factory and lunchrooms while further zoning is provided in the factory and office for paging

The 4 paging consoles used are located at the main receptionist, building manger, shipping station along with the telephone interface to allow for building wide paging operation. In this configuration the C4.2 ceiling speakers for the office areas are run off of the 4411 amplifier. The other areas use a combination of Cobraflex IIB's or PA430t's for paging notification using the bridged 200 watt channel of the 4411 with one 4140 amplifier.

System Diagram

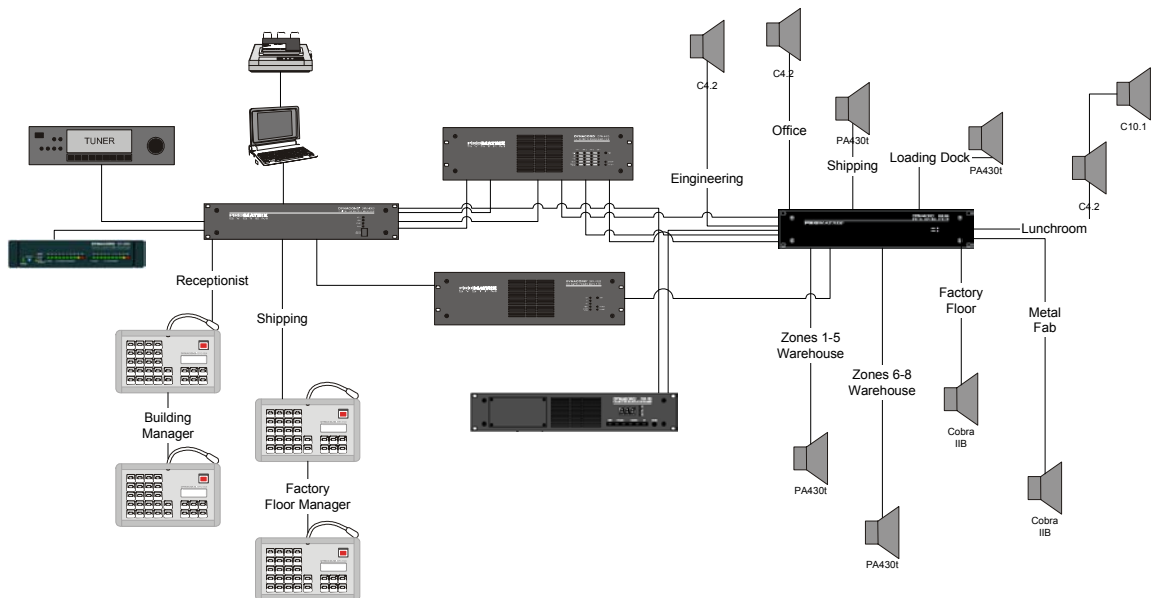

Equipment List

Model	Description	Quantity	Model	Description	Quantity
SPEAKER SYSTEMS			PROANNOUNCE EQUIPMENT		
PA430t	Paging Horn	16	DPM4000	Matrix Manager	1
Cobra IIB	Paging Horn w/ID60DT	4	DMM4650	Message Manager	1
EVID C4.2	Ceiling Speaker	30	DPA4140	2x600 watt Power Amplifier	1
EVID C10.1	Subwoofer	2	DPA4411	4x100 watt Power Amplifier	1
OTHER RELATED EQUIPMENT			DPP4004	Power supply	1
	Rack/Misc	1	DCS401R	Controller Board	1
	CD Player	3	DCS408R	Relay Board	3
	Wire/Misc	1	DCS400	DCS Rack	1
			DCS420	Monitor Station	1
			NRS90218	Output Card	1
			NRS90216	Input Card	1
			NRS90234	Input Card	1

Appendix A: Distributed Audio Systems – A Primer

The technique of constant-voltage (CV) loudspeaker distribution has been a standard audio practice since the earliest days of sound contracting.

Why Is It Called “Constant Voltage”?

You may have heard a distributed speaker system referred to as a “70-volt constant voltage system.” Does this mean that there is a constant AC or DC voltage of 70 volts always going through the speaker line? No, it doesn't.

I've heard that the term goes back to early telephone systems. Audio engineers of that time were concerned with how the voltage arriving at the receiving device varied from the voltage sent out by the sending device, and how the voltage transfer would vary in conjunction with changes in the impedance of the receiving device. In distributed speaker systems, where the impedance of the receiving device (in this case, the transformer) is very high relative to the impedance of the sending device (in this case, the power amplifier), then the receiving device receives the same voltage regardless of the impedance of the receiving device (within reason). For example, if the amplifier is putting out a sine wave of 70 volts RMS, then the full 70 volts goes across the primary of the transformer whether you've connected to a 5-watt tap (which is 1,000 ohms) or to a 50-watt tap (which is 100 ohms). So there is “constant voltage” transfer regardless of the impedance.

Does this mean that multiple low-impedance speakers (8 ohms) driven by an amplifier is not a “constant voltage” system? Driving a low-impedance speaker system (16 ohms, 8 ohms, 4 ohms) with a power amplifier is also a “constant voltage” system until you have too low of an impedance for the amplifier to drive. For example, a 10-volt sine wave from the amplifier driving a 16-ohm speaker will continue to be a 10-volt sine wave if you connect an 8-ohm speaker instead. The 8-ohm speaker will simply draw more current from the 10-volt signal, resulting in more power draw. The voltage stays the same but the current draw varies, which results in different power taps.

Developed specifically for distributed paging and public address systems, and adopted by the EIA, the CV method relies upon standardizing the RMS voltage level of distribution lines. The common CV voltage standards are 70-volt (technically 70.7-volt, selected because of electrical, insurance and/or building code regulations limiting the maximum voltage in unprotected speaker lines) and 25-volt.

What Are the Advantages to Constant Voltage Systems?

CV systems permit flexible connection of loudspeakers across the distribution line, much like connecting a light bulb across a power line. Transformers are utilized at each loudspeaker to regulate the proportion of the total amplifier power that the speaker “sees” (which determines the maximum sound pressure level in the corresponding zone). This results in a very reliable system, as long as the net power demanded by each branch does not exceed the rated power of the driving amplifier. Even if one or more speakers become disconnected or fail, the power applied to the others remains the same.

Constant-voltage distribution greatly simplifies the calculations involved in designing a background music or paging system. Within the amplifier's power limit, speakers can be freely added to (or subtracted from) the system without the relatively tedious recalculation of total load impedance. Moreover, the CV method allows a single amplifier to drive many speakers without resorting to series/parallel connection techniques: all connections are made in parallel with the line.

CV systems require that the output voltage be constant over a relatively wide range of load impedances, to a practical minimum limited by the output capability of the amplifier. Early direct-coupled tube amplifiers rarely met this requirement (or had output voltages that were far too high), and so tube amplifiers for CV systems once employed integral output transformers. Virtually all modern professional transistor amplifiers deliver an output voltage that is essentially independent of load, however, making contemporary CV systems much easier to implement.

One relic of the tube days, though, is the relatively common misconception that you must use an output transformer on any amplifier that drives a CV line. In fact, given the state of modern power amplifier technology, a transformer is not necessarily required. In this article, we will explore a number of alternative methods for driving constant-voltage distribution systems.

Amplifier Bridging

One of the primary reasons that output transformers are often employed is to boost an amplifier's output *voltage* to the CV line's standard operating level. To see why this would be necessary, let's consider what kind of amplifier we would need to develop 70 volts directly.

A derivative of Ohm's Law states that power equals voltage times current: $P = E \cdot I$

Substituting E/R for current (again in accordance with Ohm's Law), we get: $P = E^2/R$

To get the 8-ohm rating of a power amplifier capable of 70 volts RMS output:

$$P = (70 \text{ volts})^2/8 \text{ ohms} \approx 600 \text{ watts}$$

This is more power than most CV systems would require. Furthermore, an amp that is rated at 600 watts per channel would be expensive for a smaller distributed system installation.

The common solution has been, of course, to use dual-winding step-up transformers at the outputs of an amplifier with a more modest rating. Such transformers carry their own limitations, however. Especially with the advent of foreground music systems, the power requirements for CV systems have risen somewhat — but output transformers capable of significant power handling are large, expensive and heavy. They may also exhibit limited low-frequency response and might impose substantial insertion losses.

How, then, does one deliver 70 volts to the CV line? One way is to use bridging. Because a bridged power amplifier drives the load push-pull, the voltage across the load is effectively double that of each channel's individual output. If we need to develop a total of 70 volts across the line, then, we can use an amplifier, which delivers half of that, or 35 volts, for each channel.

Using the previous equation:

$$P = E^2/R = (35 \text{ volts})^2/8 \text{ ohms} \approx 150 \text{ watts}$$

Professional amplifiers of this power class are today quite common and relatively inexpensive. It is important to note that amplifier bridging should only be done when the amplifier is specifically designed for this purpose.

The manufacturer's instructions should be followed when using this technique. You must take the amplifier's bridged, 8-ohm power rating as the reference maximum power figure for loading calculations. Remember that the minimum load impedance for a bridged power amplifier is twice that of each individual channel. The bridging power figure will be specified accordingly, and may also be de-rated to reflect performance limitations of the amp's power supply circuitry. For this reason, a 200 watt per channel amplifier (or thereabouts) may actually be required, even though the 150-watt amplifier could develop sufficient voltage.

Single-Channel Direct Drive

As we have seen, the 70-volt line standard discourages direct drive from a single amplifier channel, if for no other reason than economy. But the same is not necessarily true of the 25-volt standard. As above, we can use the form of Ohm's Law that solves for power to ascertain what kind of amplifier we would need to develop 25 volts RMS across a CV line:

$$P = E^2/R = (25 \text{ volts})^2/8 \text{ ohms} \approx 75 \text{ watts}$$

Certainly, a 75 watt-per-channel professional power amplifier is well within the range of many CV system budgets. Given the state of contemporary amplifier technology, there is no reason why an amp of this power class could not drive two 25-volt branches directly.

The use of a 75 watt-per-channel amplifier can also bring added benefits in certain Installations. For instance, there is often a need to drive one or two full-range high-quality loudspeakers — say, for foreground music — in addition to a CV paging line. (One could imagine such a situation in a small airport terminal that included a restaurant or bar, for example.) In such situations, combining music and paging on a single branch may impose a compromise in sound quality that will frustrate the client. The solution here is to use one channel of a high-quality 75-watt amplifier to drive the CV line, and the other to drive the foreground music system.

Use of Autotransformers

Realistically speaking, many installations will present demands, which cannot be satisfied by the techniques that we've discussed thus far. One such case would be a moderate-sized 70-volt music-and-paging system which comprises two separate branches, each of which requires approximately 100 watts from the power amplifier.

In a small application such as this, which clearly does not demand anywhere near the power capability of two bridged 150-watt amplifiers, (one per 70-volt branch) must we go back to using dual-winding step-up transformers in order to match a lower-powered amplifier to the CV lines? Not necessarily.

Consider that the DC isolation afforded by a dual-winding transformer could easily be waived if we employ a professional solid-state amplifier, which incorporates protection against output offsets (as most do nowadays). This opens up the possibility of using an autotransformer to boost the output voltage of the amplifier.

Autotransformers offer a significant advantage over dual-winding transformers in that they impose far less insertion loss (chiefly because of tighter magnetic coupling and lower coil resistance). This translates into far more efficient power transfer.

Remember that insertion loss *must* be factored into all CV design calculations: power transfer is the name of the game here. An insertion loss of only 1dB corresponds to a power loss of over 20%, and an insertion loss of 3 dB cuts the available amplifier power in half!

Such losses directly affect the number of speakers that can be connected to a CV line. The ElectroVoice Model AT100 is a wide-range autotransformer designed specifically for use in high-quality distributed systems. The AT100 features multiple taps at specified impedance ratios, which were chosen, for maximum utility in CV system implementations. Rated at 100 watts long-term average power capacity, the AT100 can operate with very low distortion at peak levels far exceeding 100 watts, and may be used in CV applications either in step-up (amplifier output matching) or step-down (loudspeaker matching) mode.

Applying the AT100 to a typical installation, we could connect each output of a power amplifier with a 4-ohm power rating of 100 watts to the brown and black terminals of an AT100. The 70-volt lines would then be connected across the respective yellow and black terminals (common carries through). Operating the power amplifier at the equivalent of a 4-ohm load utilizes all of its available power, for further cost efficiency. The extremely low insertion loss of the AT100 allows virtually all of that power to be transferred to the line, maximizing the capabilities of the system.