

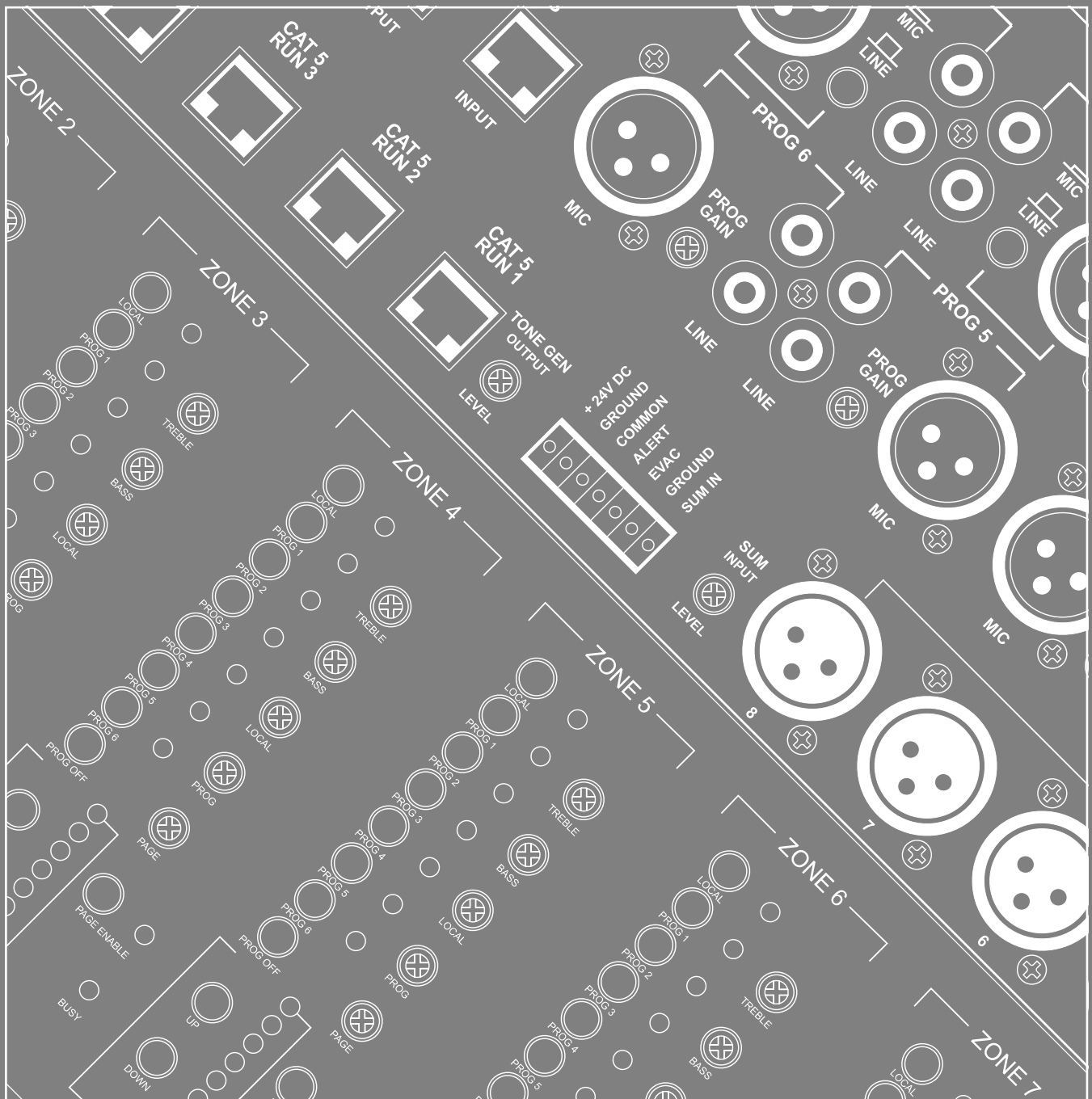

Australian Monitor
INSTALLATION SERIES

DigiPage

MULTIZONE PAGING AND SOURCE SELECTION SYSTEM
INSTALLATION AND OPERATION MANUAL





IMPORTANT SAFETY INFORMATION



1. Save the carton and packing material even if the equipment has arrived in good condition. Should you ever need to ship the unit, use only the original factory packing.
2. Read all documentation before operating your equipment. Retain all documentation for future reference.
3. Follow all instructions printed on unit chassis for proper operation.
4. Do not spill water or other liquids into or on the unit, or operate the unit while standing in liquid.
5. Make sure power outlets conform to the power requirements listed on the back of the unit.
6. Do not use the unit if the electrical power cord is frayed or broken. The power supply cords should be routed so that they are not likely to be walked on or pinched by items placed upon or against them, paying particular attention to cords and plugs, convenience receptacles, and the point where they exit from the appliance.
7. Always operate the unit with the AC ground wire connected to the electrical system ground. Precautions should be taken so that the means of grounding of a piece of equipment is not defeated.
8. Mains voltage must be correct and the same as that printed on the rear of the unit. Damage caused by connection to improper AC voltage is not covered by any warranty.
9. Have gain controls on amplifiers turned down during power-up to prevent speaker damage if there are high signal levels at the inputs.
10. Power down & disconnect units from mains voltage before making connections.
11. Never hold a power switch in the "ON" position if it won't stay there itself!
12. Do not use the unit near stoves, heat registers, radiators, or other heat producing devices
13. Do not block fan intake or exhaust ports. Do not operate equipment on a surface or in an environment which may impede the normal flow of air around the unit, such as a bed, rug, weathersheet, carpet, or completely enclosed rack. If the unit is used in an extremely dusty or smoky environment, the unit should be periodically "blown free" of foreign matter.
14. Do not remove the cover. Removing the cover will expose you to potentially dangerous voltages. There are no user serviceable parts inside.
15. Do not drive the inputs with a signal level greater than that required to drive equipment to full output.
16. Do not connect the inputs / outputs of amplifiers or consoles to any other voltage source, such as a battery, mains source, or power supply, regardless of whether the amplifier or console is turned on or off.
17. Do not run the output of any amplifier channel back into another channel's input. Do not parallel- or series-connect an amplifier output with any other amplifier output.

Australian Monitor Inc is not responsible for damage to loudspeakers for any reason.
18. Do not ground any red ("hot") terminal. Never connect a "hot" (red) output to ground or to another "hot" (red) output!
19. Non-use periods. The power cord of equipment should be unplugged from the outlet when left unused for a long period of time.
20. Service Information Equipment should be serviced by qualified service personnel when:
 - A. The power supply cord or the plug has been damaged.
 - B. Objects have fallen, or liquid has been spilled into the equipment
 - C. The equipment has been exposed to rain
 - D. The equipment does not appear to operate normally, or exhibits a marked change in performance
 - E. The equipment has been dropped, or the enclosure damaged.

THIS SAFETY INFORMATION IS OF A GENERAL NATURE AND MAY BE SUPERSEDED BY INSTRUCTIONS CONTAINED WITHIN THIS MANUAL

INTRODUCTION AND CONTENTS

The Australian Monitor Installation Series DigiPage is a 3 rack unit multizone paging and source selection system that offers unprecedented flexibility for multizone paging & source routing applications.

Six program inputs and one dedicated local mic/line input are available to each of eight zone outputs. With LED indication for program/local input selection, zone output level, paging enable/disable and network busy LED, the DigiPage provides extensive status indication to the user.

The DigiPage is also expandable to 16 zones via a simple link cable to a second unit. Paging stations are available in 8 zone and 16 Zone models allowing paging into any individual zone, any combination of zones or All Call. Remote control panels are also available, allowing source selection and volume control from within each remote zone. Both the Paging stations and remote control panels connect via an inexpensive and industry standard CAT5 cable network. An overall priority input is also provided for emergency or evacuation signals.

The DigiPage is powered by an (included) external plug-pack power supply or via 24VDC. The DigiPage is an incredibly versatile and well featured product that provides a simple solution to the complex applications of multizone paging and source routing.

We thank you for choosing Australian Monitor Installation Series and as with all our products, the DigiPage offers clever features and is contractor friendly.

| | |
|------------------------------|----|
| INTRODUCTION | 3 |
| FRONT PANEL | 4 |
| REAR PANEL | 6 |
| INSTALLATION | 8 |
| DIMENSIONS | 11 |
| SETUP | 12 |
| TROUBLESHOOTING | 13 |
| LINKING TWO DIGIPAGE SYSTEMS | 14 |
| OPERATION | 15 |
| PAGING STATION | 16 |
| REMOTE CONTROL PANEL | 18 |
| BLOCK DIAGRAM | 20 |
| ACCESSORIES | 21 |
| SPECIFICATIONS | 22 |

AUS, EUR, USA Rev A: 27th May 2003
Copyright 27th May 2003 Rev B: 11th Aug 2004
Rev C: 13th Jan 2006



WARNING !

TO REDUCE THE RISK OF FIRE OR ELECTRIC SHOCK.
DO NOT EXPOSE THIS EQUIPMENT TO RAIN OR MOISTURE.



This symbol is intended to alert the user to the presence of uninsulated "dangerous voltage" within the product's enclosure that may be of sufficient magnitude to constitute a risk of electric shock to persons.



This symbol is intended to alert the user to the presence of important operation and maintenance (servicing) instructions in the literature accompanying the appliance.

Caution:

To prevent electric shock do not use this (polarised) plug with an extension cord, receptacle or other outlet unless the blades can be fully inserted to prevent blade exposure. To prevent electric shock, match wide blade of plug to wide slot, fully insert.

FRONT PANEL

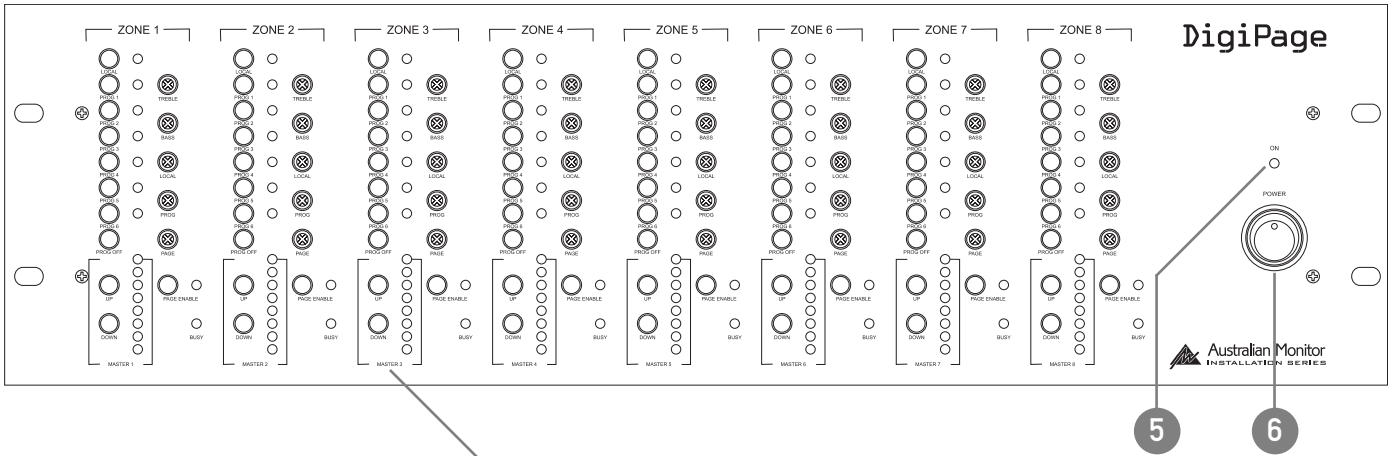

Expanded View

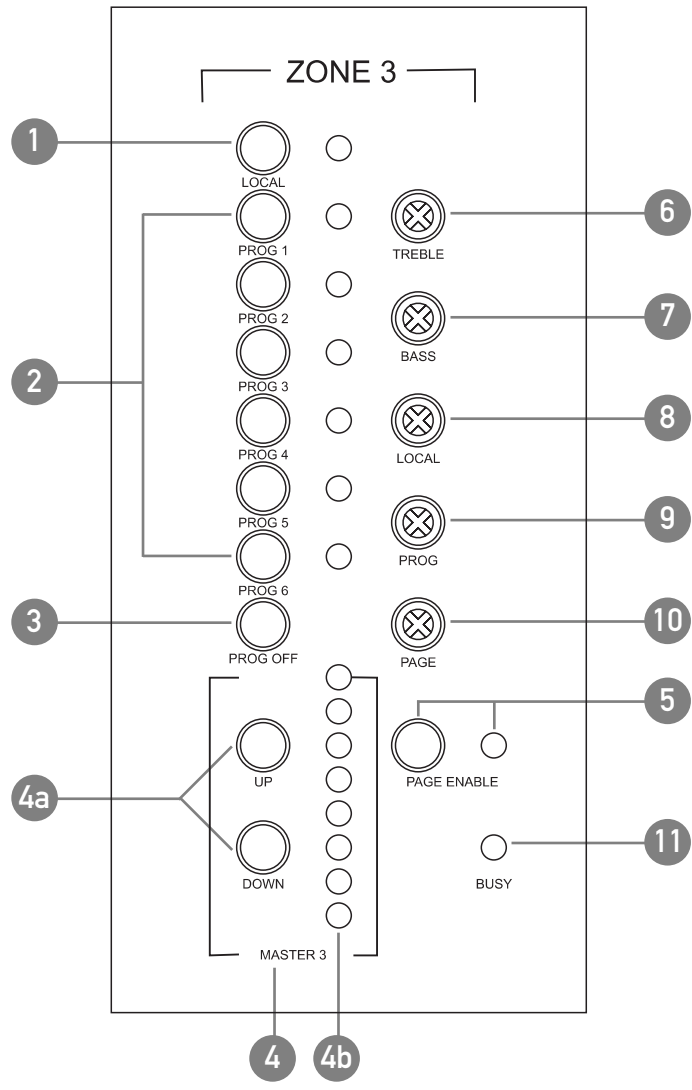

FRONT PANEL

The controls detailed below (1-12) apply to each output zone, as indicated by ZONE 1 to ZONE 8 on the front panel.

1 LOCAL

This switch will turn the local input on or off in the zone. The local input is for exclusive use in the zone (eg Local Input 3 to Zone 3). The Local switch operates independently of the program switches. The local input can be mic or line; see Rearpanel on page 6.

2 PROG 1-6

This series of program switches (PROG 1- PROG 6) allows the connected program sources to be switched to the desired zone. Program inputs may be mic or line, see Rearpanel on page 6. The program sources can be selected individually, or multiple program sources can be mixed together. Operation is as follows:

- Select one program source
- Press momentarily
- Add another program source
- Press and hold for 2 secs
- Deselect program source
- Press and hold for 2 secs
- Turn off all program sources
- Press Prog Off

3 PROG OFF

This switches program off in the desired zone.

4 MASTER 1-8

4a Up/Down

These buttons increase and decrease the zone output level.

4b

Master volume control position indication.

 **NOTE: This is NOT a signal level meter. It indicates relative volume position.**

5 PAGE ENABLE

This switch allows the zone to be included in or isolated from the paging stations. You may want to do this when a zone is for an area such as a function room that occasionally may need to be isolated from paging. When this button is pressed, the adjacent green indicator lights, indicating that the zone is able to receive paging.

6 TREBLE

The treble control has 9dB of cut or boost at 10kHz. The treble control affects the entire zone.

 **NOTE: That 'center' is to the left (9 o'clock), not the top (12 o'clock).**

7 BASS

The bass control has 12dB of cut or boost at 100Hz. The bass control affects the entire zone.

 **NOTE: That 'center' is to the left (9 o'clock), not the top (12 o'clock).**

8 LOCAL

This control adjusts the level of the local input into the zone.

9 PROG

This control adjusts the overall level of all program sources into the zone.

 **NOTE: To balance the differing levels of each program input, the program trim controls on the rear panel should be used (see rear panel and setup sections)**

10 PAGE

This control adjusts the paging mic level into the zone.

11 BUSY

This LED indicates that the control network is busy in this zone. The zone is currently being paged or adjusted.

Located at the right-hand end of the unit, these controls affect all zones.

12 ON

This LED indicates there is power to the unit.

 **NOTE: When 24VDC emergency power is supplied this LED will always be on.**

13 POWER

This switches power from the power supply (included).

 **NOTE: When 24VDC emergency power is supplied, the unit is on regardless of the switch position**

REAR PANEL

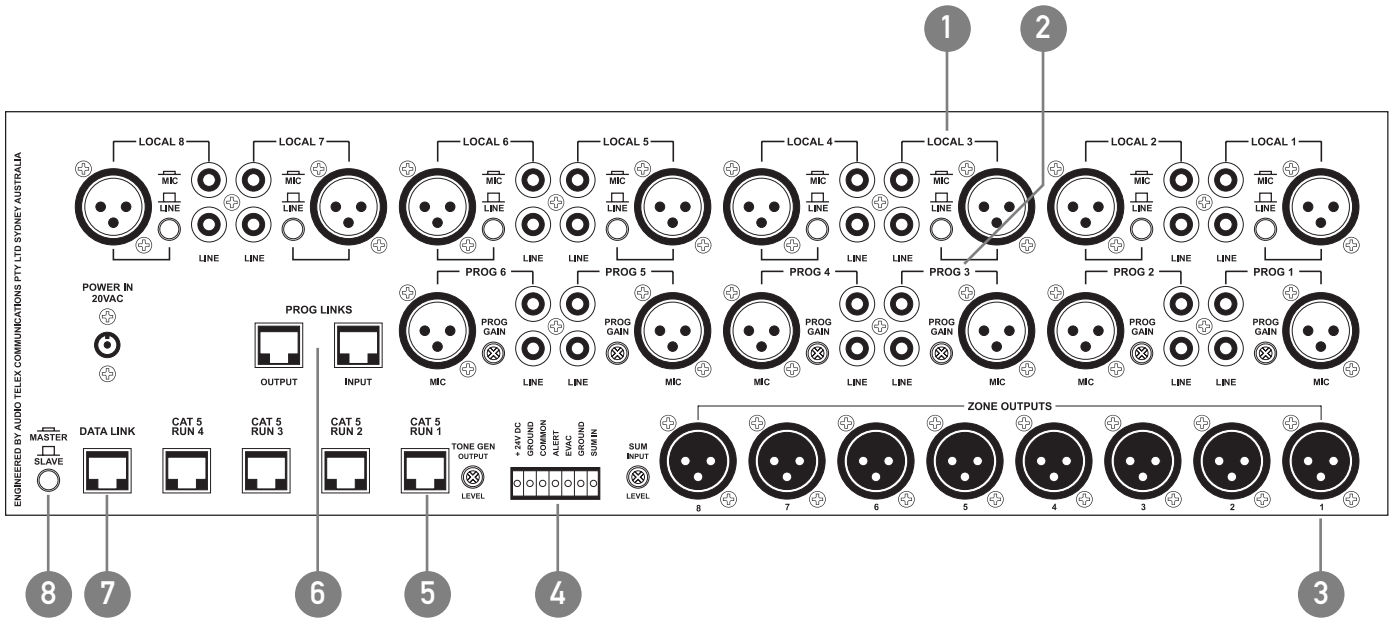

REAR PANEL

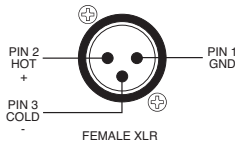
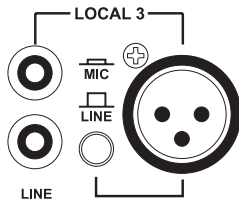

1 LOCAL 1-8 INPUT SECTION

LINE The pair of RCA sockets accepts unbalanced line level inputs. Stereo signals are internally summed to mono.

MIC/LINE The switch selects the sensitivity of the balanced XLR input ONLY.

Switch in: microphone level

Switch out: line level

The XLR socket accepts balanced microphone or line level signals.

NOTE: The Local Input is routed only to the same numbered zone output and is switched on or off via the front panel or remote control panel.

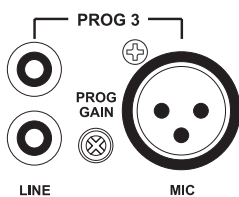

2 PROG 1-6 INPUT SECTION

LINE The pair of RCA sockets accepts unbalanced line level inputs. Stereo signals are internally summed to mono.

MIC The XLR socket accepts balanced microphone level signals.

PROG GAIN The trimpot controls the input gain of BOTH the balanced and unbalanced program inputs.

In a Master/Slave configuration, these also control program linked inputs. (see Linking Section)

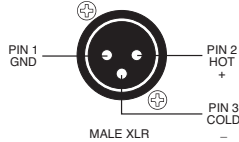

3 ZONE OUTPUTS

There is a balanced XLR line level output for each zone.

NOTE: If connecting to an unbalanced input, the negative pin (3) should not be connected to ground but left floating.

NOTE: When operating as a slave unit, outputs labelled 1 to 8 will correspond to zones 9 to 16, respectively. (see Linking Section)

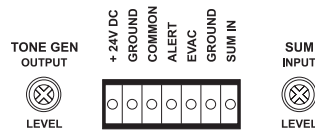

4 EUROBLOCK CONNECTOR

24V DC / GROUND This input pair is for connection to a 24VDC emergency power supply and is not switched by the front panel power switch.

NOTE: The 24V DC input does not provide a trickle-charge facility.

ALERT/EVAC/COMMON These connections are used to trigger the internal tones. Only one tone can be triggered at a time. Triggering occurs by connecting the ALERT or EVAC terminal to COMMON.

GROUND/SUM IN This is an unbalanced line level input which may be used for emergency priority signals. It feeds all outputs independent of output level settings and page enable status.

NOTE: Signal on the SUM IN will cause other signals to be muted.

SUM INPUT LEVEL This recessed trimpot sets the level of the sum input.

TONE GEN OUTPUT LEVEL This recessed trim pot controls the output level of the tones and the chime.

5 CAT 5 RUN 1-4

These RJ45 inputs accept the CAT5 cables coming from the paging microphone stations and the remote control panels. See page 10 for more information.

NOTE: These are NOT Ethernet connections.

NOTE: Connecting and disconnecting these inputs while the unit is on may cause the unit to lock up requiring system power to be cycled.

6 PROG LINKS

These RJ45 sockets allow linking of the program sources when using a Master/Slave configuration. (see Linking Section)

NOTE: These are NOT Ethernet connections.

7 DATA LINK

This socket is used to link two units in a Master/Slave configuration. (see Linking Section)

NOTE: These are NOT Ethernet connections.

8 MASTER/SLAVE

This switch is used when linking 2 units in Master/Slave configuration. (see Linking Section)



9 POWER IN VAC

This 2.1mmx5.5mm power socket accepts the 20VAC power supply provided with the unit.

INSTALLATION

OVERVIEW

The DigiPage features extensive flexibility in the range of input sources that it can accommodate. In addition, the zone outputs may be used to feed power (booster) amplifiers, mixers, mixer amplifiers etc. It is therefore important to think about the interfacing of the DigiPage with the other equipment if optimum performance is to be achieved. Use the Back Panel and Specifications sections of this manual to assist with system design.

NOTE: XLR CONFIGURATION

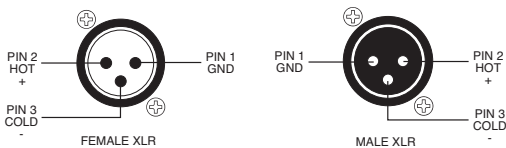

When wiring the outputs on the DigiPage as unbalanced, Pin2 should be used as hot and Pin1 as ground. Pin3 should be left open and NOT shorted to Pin1.

NOTE: If installing and terminating CAT5 cable is new to you, please take note of the various points that follow. As the CAT5 cabling for the DigiPage carries voltage, damage could occur if your pin-pin connections are not made correctly.

CABLE INSTALLATION FOR PAGING STATIONS AND REMOTE PANELS

Four RJ45 ports (labeled CAT 5 RUN 1-4) are provided for connection to the DigiPage Zone Paging Stations and Remote wall panels. The four ports allow for easy cable infrastructure, as CAT5 runs can be of differing lengths depending on the installation and the number of units connected.

In planning the installation, the following rules apply:

- Up to 4 Paging Stations, remote control panels or combinations of the two may be connected to each of the four CAT5 runs.
- Connections along the runs must be in a daisy-chain configuration. It is acceptable to create a short branch (eg, from a wall to a paging station). The maximum length of the branch is 10m.
- The following table indicates the maximum distance allowable for a CAT5 run on a single port.
- For greater distances or more units, see page 10
- The last unit on a run must be terminated. This is done by moving a jumper on the paging station or remote unit. See 'Paging Station' on pages 16-17 or 'Remote Control Panel' on pages 18-19.

NOTE: These are NOT Ethernet connections.

| COMBINATION OF DEVICES ON SINGLE CAT5 RUN | MAX DISTANCE TO END UNIT (M/FT) |
|---|---------------------------------|
| 1 x PAGING STATION | 250m/820ft |
| 2 x PAGING STATIONS | 125m/410ft |
| 3 x PAGING STATIONS | 80m/260ft |
| 4 x PAGING STATIONS | 62.5m/205ft |
| 1 x WALLPLATE | 500m/1640ft |
| 2 x WALLPLATES | 250m/820ft |
| 3 x WALLPLATES | 165m/540ft |
| 4 x WALLPLATES | 125m/410ft |
| 1 x PAGING STATION & 1 x WALLPLATE | 165m/540ft |
| 1 x PAGING STATION & 2 x WALLPLATES | 125m/410ft |
| 1 x PAGING STATION & 3 x WALLPLATES | 100m/330ft |
| 2 x PAGING STATIONS & 1 x WALLPLATES | 100m/330ft |
| 2 x PAGING STATIONS & 2 x WALLPLATES | 80m/260ft |
| 3 x PAGING STATIONS & 1 x WALLPLATE | 70m/230ft |

INSTALLATION

CAT5 CABLE

CAT5 cable is the blue cable commonly used for data installations (other colours do exist). It consists of four twisted pairs of wires: this is why it is referred to as UTP (Unshielded Twisted Pair). The most readily available cable uses solid conductors, like telephone wire. Cable with stranded conductors is available, and is more flexible.

CAT5 TERMINATION

Pre-wired CAT5 cable comes in two configuration standards, 568A and 568B. It is advisable to carry a good pre-wired cable for fault-finding. Both configurations will work with the DigiPage provided both ends have the same configuration. Be careful not to use a crossover cable which has one configuration at one end and the other configuration at the other end.

Ensure that the RJ45 connectors are suited to the cable used (solid or stranded) and that the correct crimp tool is used.

When wiring connectors, 568A standard wiring is recommended (see diagram). Note that this is only the recommended wiring and that you should check the configuration of any cables that you are using.

DIGIPAGE NETWORK CABLING

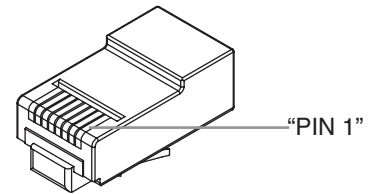

568A CONFIGURATION

| PIN | WIRE COLOUR | DP NETWORK |
|-----|--------------|------------|
| 1 | White/Green | Ground |
| 2 | Green | Power |
| 3 | White/Orange | Data+ |
| 4 | Blue | Busy- |
| 5 | White/Blue | Busy+ |
| 6 | Orange | Data+ |
| 7 | White/Brown | Voice+ |
| 8 | Brown | Voice- |

NOTE: CAT5 cable consists of four pairs of wires: it is not sufficient to simply wire the two ends pin for pin, ignoring pairing.

POWER REQUIREMENTS

The DigiPage can operate from the plug pack supplied and/or a separate 24V DC power supply.

A NOTE ABOUT GROUNDING: It may be necessary in some circumstances to ground the DigiPage to eliminate noise in the system. This can be done using the negative terminal of the 24VDC IN euro connector or by making sure that the chassis is electrically connected to the equipment rack (which should be grounded).

INSTALLATION

EXTENDING CAT5 CABLE RUN DISTANCES & ADDING MORE PAGING STATIONS & DPRMS

The maximum distances quoted in the Table #1 are due to DC current limitations, not data transmission limitations. If distances greater than these are required, the paging stations and DPRM's can be locally powered. This will extend the maximum distances to 1000m per CAT5 RUN. Alternatively, if more than 4 paging stations or DPRM's are required on a single run, local powering can be used. This will increase the maximum number of paging stations and DPRM's on a single CAT5 RUN. Use a regulated 12VDC supply connected as

- pin1 (white/green in CAT5)- GROUND
- pin2 (green in CAT5) - +12V

Disconnect incoming +V, but not ground. The 12V supply should be rated at 150mA per paging station being powered and 90mA per DPRM. For further information email techsupport@audiotelx.com.au.

TONE GENERATOR INPUTS

Tones may be triggered by closing a switch or relay contact between the selected tone trigger input and common. These trigger inputs are 5V TTL and may alternatively be triggered by pulling the desired input low referenced to the COMMON.

NOTE: The maximum voltage on these inputs must not exceed 5.5V

PRE-ANNOUNCE CHIME

The only internal setup that is available in the DigiPage is for the configuration of the chime tone that sounds in each zone. The unit comes shipped with the chime enabled in all zones.

A link can be found on each zone control board at the front of the unit (the longer board behind the zone section).

To disable the chime to a particular zone, move the link to the upper two pins on the relevant control board. To re-enable the chime, move the link to the lower two pins.

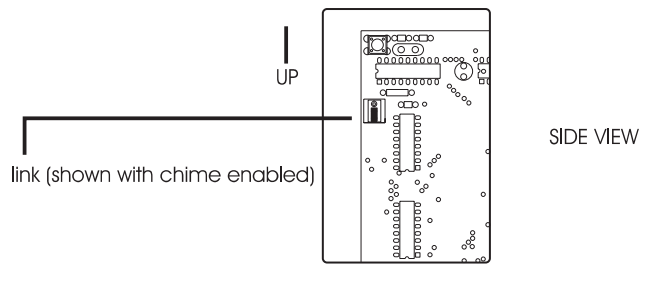

DIMENSIONS

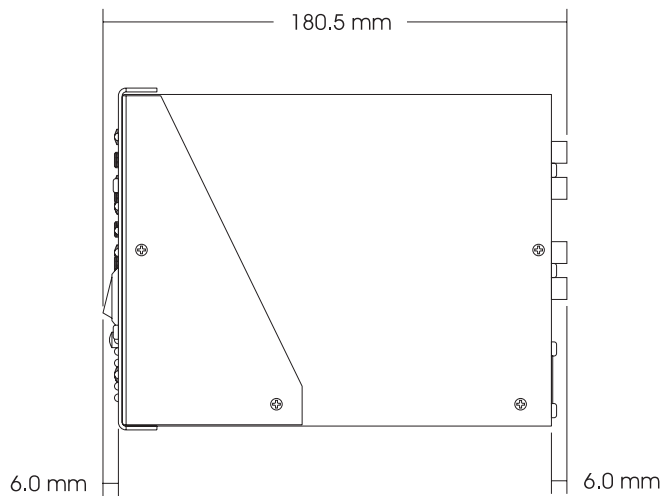
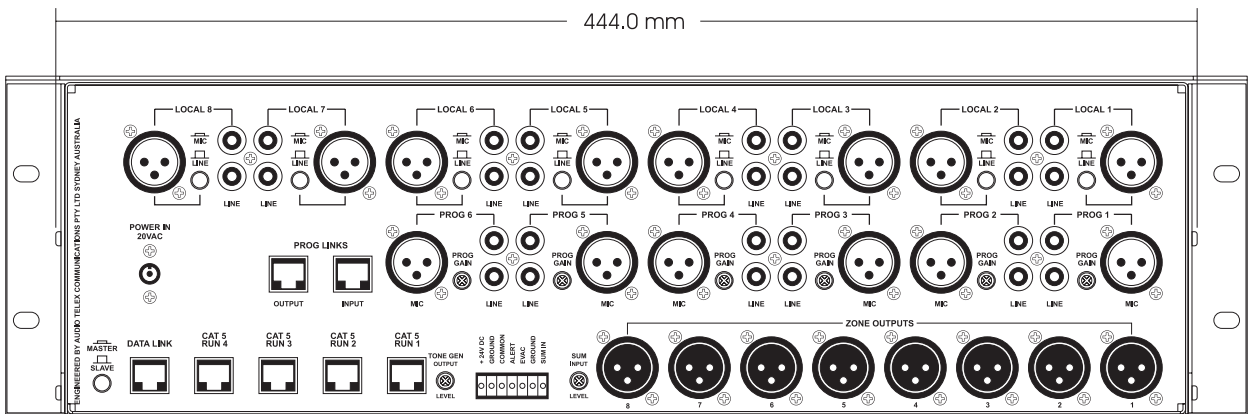
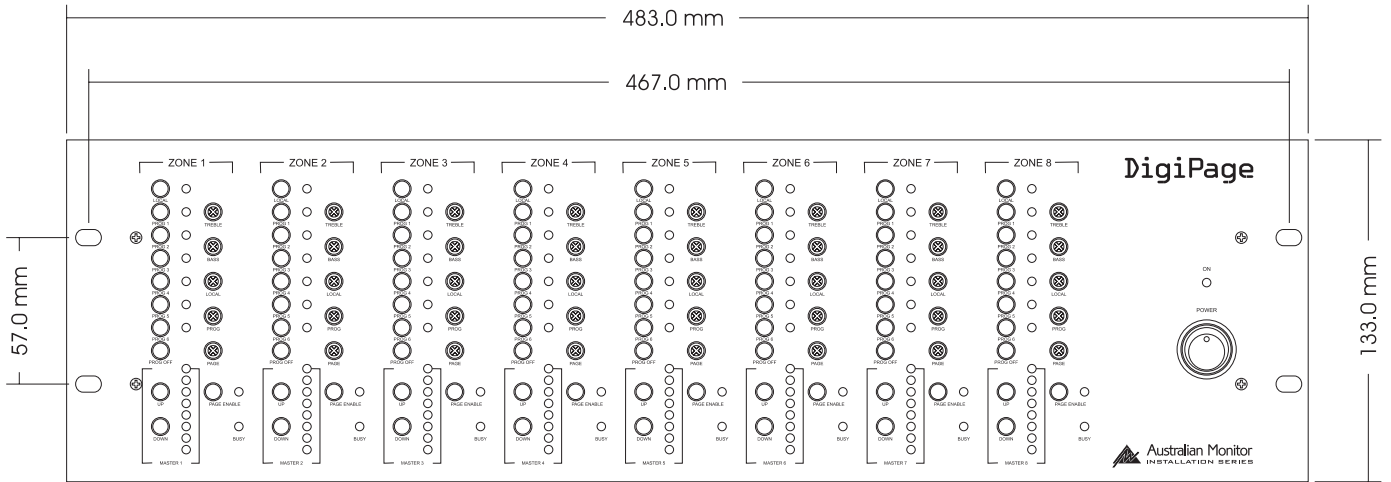

SETUP

The inputs of the DigiPage can accommodate a wide range of sources including active paging stations, dynamic microphones, DVD and CD players. The zone outputs may be used to drive power (booster) amplifiers, mixers, or mixer amplifiers.

Each installation will require setting the appropriate relative mix of levels between paging, program sources and local inputs for each zone and balancing between the zones.

Because of the variation in levels between the possible sources, DigiPage offers a number of gain stage adjustment so you can set the correct levels for your application.

Also consider what the outputs are driving ...

Setting up correct gain structure through the whole system is important to achieve optimal results.

The following step by step procedure has been devised to assist during the setup process.

When the DigiPage was shipped to you from the factory it was set up in a particular way. In the following procedure it is essential that you are starting from these initial settings.

- Program Input Gain Controls - half (12 o'clock)
- Local XLR Mic/Line switch - source dependant
- Master Volume - off
- Mic level - half (9 o'clock)
- Prog level - half (9 o'clock)
- Local level - half (9 o'clock)

12 o'clock



9 o'clock



STEP BY STEP SETUP

Confirm the initial settings of DigiPage.

Choose a zone that is conveniently located near to the DigiPage or further away if you feel you need the exercise. This will be referred to as "TEST ZONE".

Ensure that all amplifiers connected to the DigiPage are set to provide required sound levels with a line level input signal.

Choose a consistent program source, eg CD or tuner. This will be referred to as "TEST PROG".

- 1 Select TEST PROG in the TEST ZONE [front PROG 1-6]. Set the MASTER volume in the TEST ZONE to half way.
- 2 Adjust the rear PROG GAIN for the TEST PROG input to achieve the required sound level in the TEST ZONE.
- 3 Select PROG TEST in all other zones.
- 4 Bring up the MASTER volume in all other zones and check for required sound levels.
- 5 Do a test page in the TEST ZONE and check the level relative to the program level.
- 6 Adjust the page level as desired [front panel PAGE].
- 7 Set the input level type of any local inputs being used [rear panel LOCAL MIC/LINE].
- 8 Select and check the local inputs in each zone. Adjust the local level as desired [front panel LOCAL].
- 9 Balance the other program sources in the TEST ZONE [rear panel PROG GAIN].
- 10 Apply the front panel settings from TEST ZONE to all other zones.
- 11 Using the front panel controls only set the individual zones to your preferred settings
 - a. Set balance between local/program/page
 - b. Set Eq
 - c. Set final master level



NOTE: A full discussion of setting up a complex system with correct gain structure is beyond the scope of this manual. The procedure above assumes that the installer has correctly set up external equipment connected to DigiPage prior to initiating the set up procedure.

TROUBLESHOOTING

| TROUBLE | LIKELY CAUSE | REMEDY |
|---------------------------------------|---|---|
| DigiPage System | | |
| No response to controls | Mains brownouts or incorrect connection of devices may cause processor to lock-up | Cycle power on the DigiPage |
| Poor signal to noise ratio | Incorrect system gain structure | - Check settings of all equipment - Revisit Step-by-Step Setup Procedure |
| | Lack of system ground | See Grounding in Installation section |
| All Call works but Zone Page does not | Main unit set to slave | Set main unit master/slave switch to master (switch in) |
| Paging Station | | |
| LED's chase | Initialisation (boot) sequence | Normal operation when power is applied |
| Inconsistent operation | Cable too long | See Installation section |
| | Cable fault | - Check cable. - Check Paging Station with good cable at DigiPage |
| Emits high-pitch whine | Station lock-up due to connection while system is live | With all Paging Stations connected, cycle power on the DigiPage |
| Remote Control Panel | | |
| No effect:busy LED blinks | Actually controlling a different zone | Program correctly (factory setting is zone 1) |
| Busy LED never blinks | Cable fault | - Check cable - Check Remote Panel with good cable at DigiPage |
| Busy LED on | Another device has control of the zone | - Check other units - Cycle power if suspect system lock-up |

LINKING TWO DIGIPAGE SYSTEMS

DigiPage is fully expandable to form a 16 zone paging system by the simple linking of two units. One DigiPage is then designated the master unit, driving zones 1-8, with the slave unit driving zones 9-16. The following settings and connections are required to form a linked DigiPage system.

The DigiPageM16 paging station must be used to access all zones.

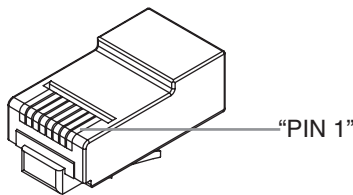

PROGRAM SOURCE WIRING 568A CONFIGURATION

| PIN | WIRE COLOUR | PROG WIRING |
|-----|--------------|-------------|
| 1 | White/Green | Prog 1 |
| 2 | Green | Prog 2 |
| 3 | White/Orange | Prog 3 |
| 4 | Blue | Prog 4 |
| 5 | White/Blue | Prog 5 |
| 6 | Orange | Prog 6 |
| 7 | White/Brown | Ground |
| 8 | Brown | Ground |

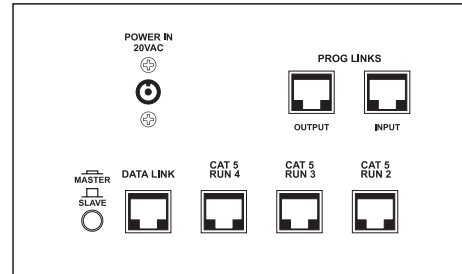

MASTER/SLAVE

This switches the unit from master (switch in) to slave (switch out). When set as master the unit acts as zones 1 to 8. When set as slave the unit acts as zones 9 to 16. This switch should only be operated when the unit is powered off.

DATA LINK

This link is essential. Use a pre-wired CAT5 patch lead. The maximum cable length for the data link cable is 10m, but note that PROG LINKS cable is limited to 0.5m (see below).

NOTE: Maximum data link cable length is 10m

NOTE: These are NOT Ethernet connections.

PROG LINKS

Program sources can be sent to the slave DigiPage by connecting the PROG LINKS OUTPUT on the Master unit to the PROG LINKS INPUT on the Slave unit. This simplifies connection of sources as all 6 sources can be sent from the master to the slave via 1 CAT5 cable avoiding the need for Y-cables

The PROG TRIM on the slave unit operates independently of the master unit. The PROG TRIM on the slave unit should be set to the same position as on the master.

Use a pre-wired CAT5 patch lead. The maximum cable length for the program source link cable is 0.5m however this cable should be kept as short as possible because it is carrying audio signal.

NOTE: If PROG LINKS is not used, it is possible to use completely different program sources in zones 1-8 to zones 9-16.

NOTE: Maximum prog link cable length is 0.5m

CHANGING VOLUME LEVELS

The output level is controlled by a digital up/down switch arrangement. There are 32 levels from off to maximum in a non linear audio configuration. The master LED's indicate this volume setting but because there are only 8 LED's, a change to the volume (pressing up or down) may not show a change in the LED's. The level must step 4 times before the LED indication changes.

 **NOTE: The LED's are an indication of master volume setting and not an indication of signal level or presence.**

CHANGING PROGRAM SOURCES OR LOCAL:

The program sources can be selected individually, or multiple program sources can be mixed together. Operation is as follows:

| | |
|------------------------------|---------------------------|
| Select one program source | Press momentarily |
| Add another program source | Press and hold for 2 secs |
| Deselect program source | Press and hold for 2 secs |
| Turn off all program sources | Press Prog Off |

Local is not affected and is controlled by toggling either on or off.

REMEMBERING SETTINGS / POWERING UP AND DOWN:

The DigiPage is designed to remember it's last setting when powering down. Due to the nature of memory storage, the unit should be left on for at least 15 seconds after a change is made to allow the unit to store the changes. The unit should also be allowed to stand for 15 seconds before turning back on to allow all voltages to discharge. This is not required if cycling the mains to clear a lockup but only to ensure that changes are stored.

BUSY SIGNAL:

When a zone is busy, the volume control and program source selection becomes inactive. Changes cannot be made while the zone is busy.

A zone is made busy when a peripheral device is accessing the zone. This can be in two forms:

1. When someone is paging to the zone. The busy led will then glow steady.
2. When someone is making changes using the remote wall panel. The busy led will then blink rapidly.

 **NOTE: The paging stations for the DigiPageJr are different to the DigiPage and cannot be mixed. The same applies to DPRM's which cannot be used with the DigiPageJr.**

PAGING STATION

INTRODUCTION

The Australian Monitor Installation Series DigiPage8M and DigiPage16M Paging Stations are 8 and 16 zone paging stations complete with a slimline gooseneck paging microphone. The Paging stations are designed to be used with the DigiPage Zone Paging & Source Selection System and will allow paging into any individual zone, any combination of zones or All Call to all zones. LED indicators provide the user with visual feedback of the zones being paged or if the zone selected is busy. Ample label space is provided on the Paging Station, which also provides a microphone gain control. Connection to the DigiPage is via low cost CAT 5 cable and as with all Australian Monitor installation products, the Paging Station provides an elegant solution at a contractor friendly price.

CONTROLS

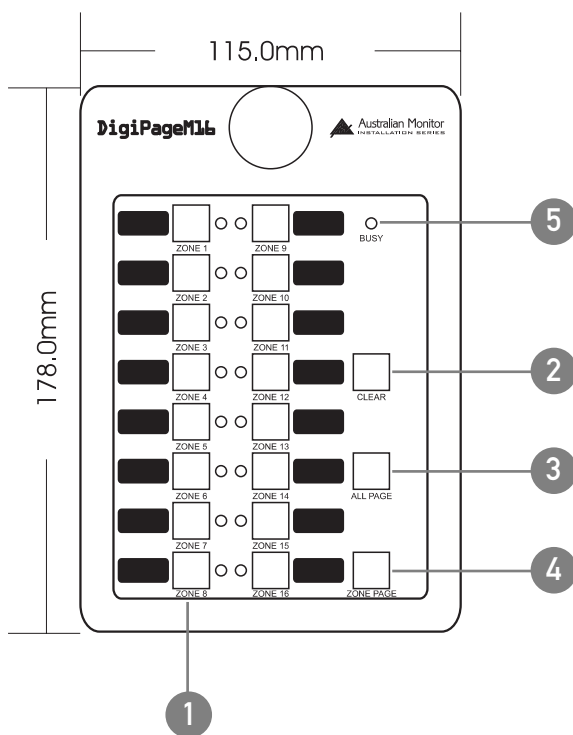

1 ZONE SELECT

These buttons allow selection of zones for paging. When selected, the adjacent LED glows green. Pressing the button again deselects the zone. The area next to the button is for labelling the zone. Selecting a zone does not instigate paging. See 4. ZONE PAGE.

2 CLEAR

This button clears all the selected zones.

3 ALL PAGE

This button pages to all zones. It is momentary so must be held while talking into the microphone. It activates the microphone and mutes the program sources. It does NOT clear the current zone selection configuration so the paging station will return to its previous state (selected zones) once the ALL PAGE button is released.

4 ZONE PAGE

This button pages to the current zone selection configuration as indicated by the ZONE select LEDs. The zones being paged have their program sources muted and the microphone becomes active. If no zones are selected the system will still show as busy when this button is pressed.

5 BUSY

This LED glows when the network or system is busy. This can be caused by the local paging station (you are making a page), another paging station, or a remote control panel being in use. Paging is not possible while the system is busy, however zone selections can still be made.

PAGING STATION

INSTALLATION AND SETUP

The CAT5 cable connects to the RJ45 socket on the rear panel of the paging station. This socket is a NEUTRIK™ connector designed to be used with the XLR style housing (model NE8MC) to improve reliability. Normal RJ45 connectors can also be used.

Plugging and unplugging the cable while the system is powered up may result in the system locking up and is not recommended. If this should happen, reset the DigiPage by switching off, then on.

6 GAIN

To accommodate different speech levels, there is a gain control on the base of the DigiPageM. This ships set to minimum and may be adjusted to suit. Increasing this control too far may cause the paging station to distort if loud or close speech levels are encountered.

7 TERMINATING

In an RS485 network (of which the DigiPage is part of) it is important to terminate the last device in each CAT5 RUN. Two jumpers are provided for the data transmission and the voice transmission to be terminated if that Paging Station is at the end of a CAT5 RUN (see diagram). Shipped as terminated.



When making changes be sure to power off the system and disconnect from the network.



NOTE: these stations are not compatible with the DigiPageJr network system.

BASE PLATE SECTION

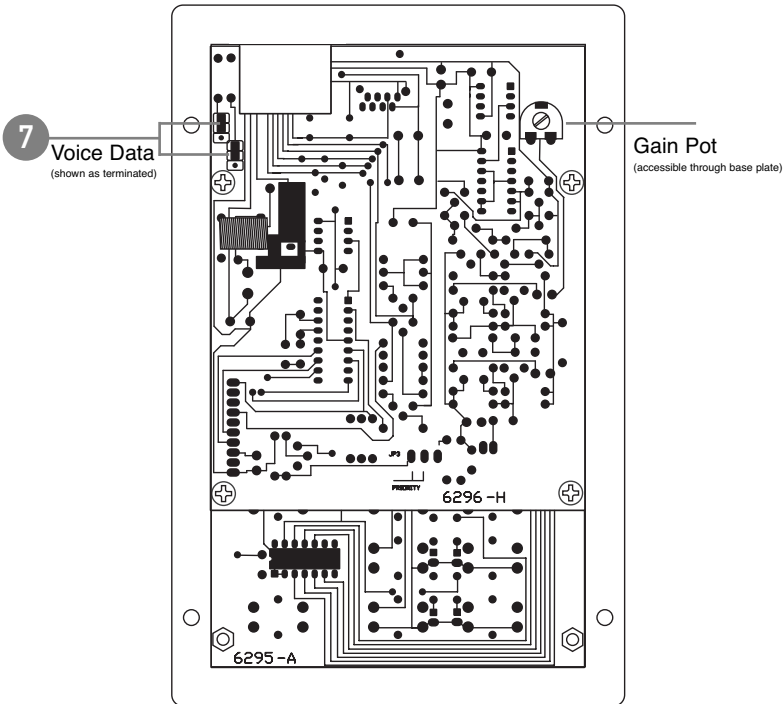
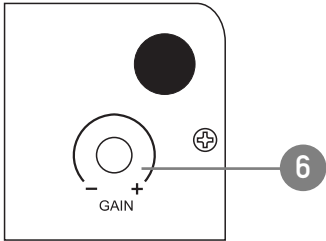

REMOTE CONTROL PANEL

INTRODUCTION

The Australian Monitor Installation Series DPRM Remote Control Panel is a control surface that is designed to be used with the DigiPage Zone Paging and Source Selection System. The DPRM allows control over program source selection, local input selection and volume control from a remote location. LED illumination provides the user with visual feed back if the system is busy. Connection to the DigiPage is via low cost CAT 5 cable and as with all Australian Monitor Installation products, the Remote Control Panel provides an elegant solution at a contractor friendly price.

CONTROLS

All the controls correspond only to the zone for which the panel is programmed by the installer. (see programming section)

1 **PROG 1-6**
This row of 6 buttons selects the numbered program source. They are electrically interlocking meaning that selecting one source will deselect the previously selected source.

2 **PROG OFF**
This button will turn off the program source that is currently selected .

3 **LOCAL ON/OFF**
This button toggles the local input on or off.

4 **BUSY**
This LED lights when the system network is busy. The remote control panel is disabled while the system is busy unless it is the panel in use generating the busy indication.

5 **VOLUME UP/DOWN**
These two buttons increase or decrease the volume within the zone.

6 **TERMINATING**
In an RS485 network (of which the DigiPage is part of) it is important to terminate the last device in the network CAT5 RUN. A jumper is provided for the data transmission to be terminated if that Remote Control Panel is at the end of a CAT5 RUN. Shipped as terminated.

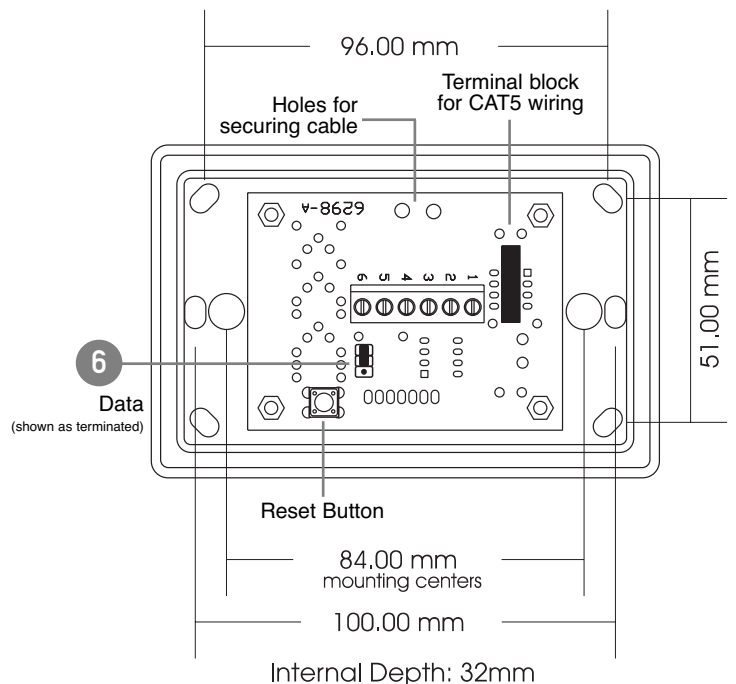
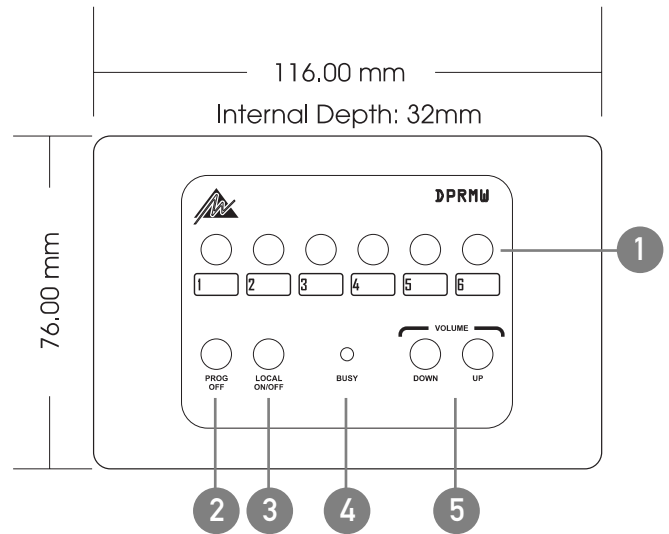

REMOTE CONTROL PANEL

INSTALLATION

The CAT5 cable connects to the screw terminals numbered 1-6. These numbers correspond to the pins of the RJ45 connector on the main unit. If following the 568A convention, the wire colours are wired as:

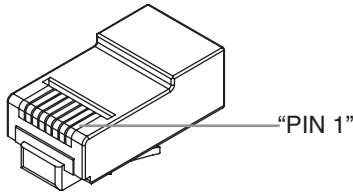

| PIN | WIRE COLOUR | DP NETWORK |
|-----|--------------|--------------|
| 1 | White/Green | Ground |
| 2 | Green | +18V |
| 3 | White/Orange | Data+ |
| 4 | Blue | Busy- |
| 5 | White/Blue | Busy+ (+18V) |
| 6 | Orange | Data- |
| 7 | White/Brown | Spare |
| 8 | Brown | Spare |

Ensure that the spare pair cannot short to anything.

 **NOTE: If the Remote Control Panel is NOT the last unit in the CAT5 RUN and there are paging stations connected further down the run it is important that the spare pair is continued to the next unit otherwise voice information from the paging stations will not get to the main DigiPage unit.**

There are two holes available adjacent to the terminal block for securing the CAT5 cable with a cable tie.

PROGRAMMING

The following steps are for programming the remote control panel for use in ZONE X:

- 1 Hold down the RESET button on the back.
- 2 While holding down the RESET button, hold down both the Up and Down volume buttons.
- 3 Release the RESET button.
- 4 The remote control panel will beep 3 times indicating it is in program mode. The BUSY LED will stay lit while in program mode.
- 5 Press the Up button X times (the unit will beep each time).
Eg. for ZONE 4, press 4 times
- 6 Press the Down button.
- 7 The BUSY LED will go out. The remote control panel is now programmed.
- 8 Confirm that the panel is controlling the correct zone.

 **NOTE: You have approx. 2 secs to begin the programming and between button presses else it will exit programming mode.**

BLOCK DIAGRAM

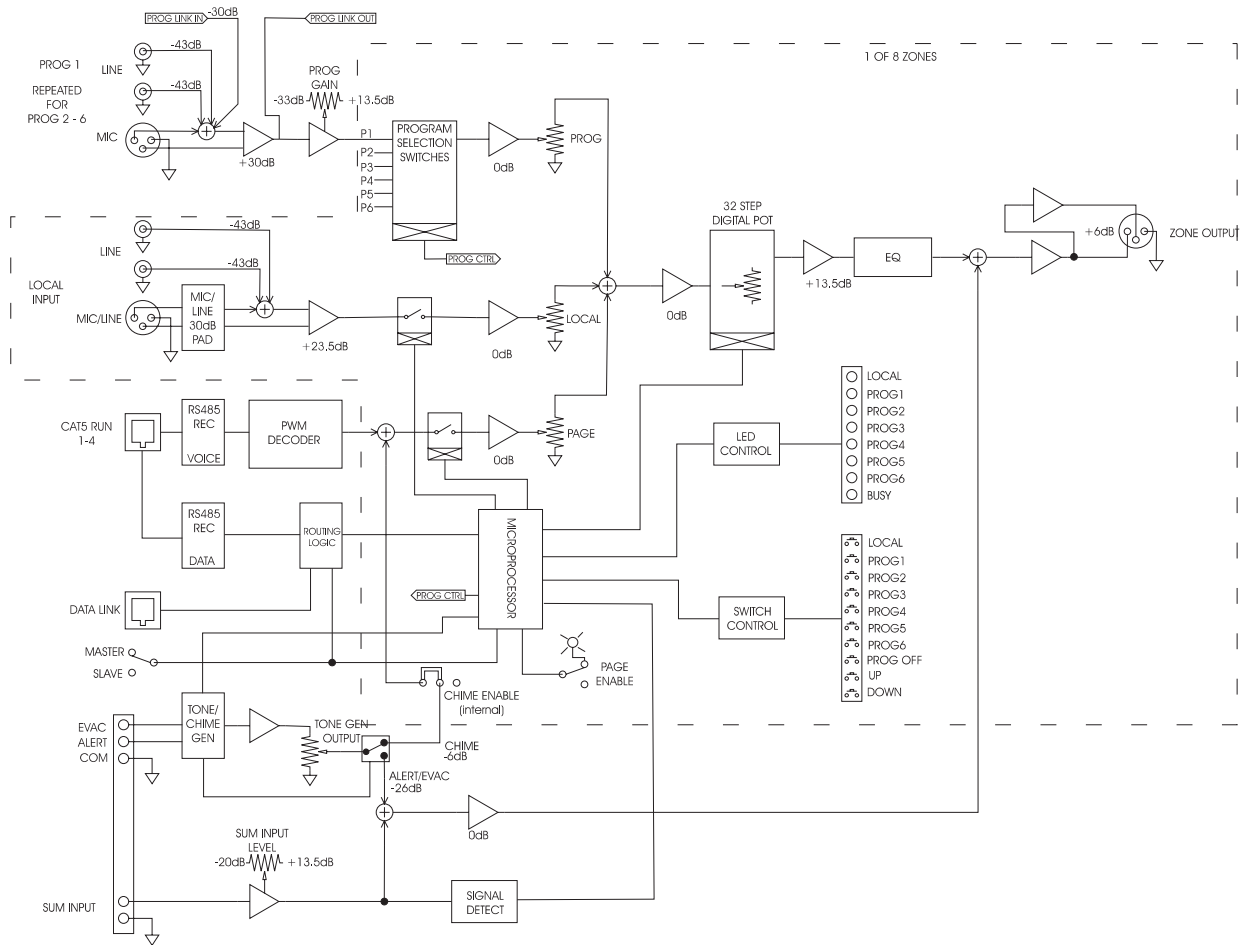

ACCESSORIES

PAGING STATIONS

8 ZONE Cat No. DP8M

16 ZONE Cat No. DP16M

REMOTE CONTROL PANELS

BLACK Cat No. DPRMB

WHITE Cat No. DPRMW

INPUT PLATE

BLACK Cat No. DPRIPB

WHITE Cat No. DPRIPW

STANDOFF SURFACE MOUNT BOX

BLACK Cat No. DPRMSMBB

WHITE Cat No. DPRMSMBW

SPECIFICATIONS

DIMENSIONS (h x w x d) 133.0 x 483.0 x 180.5 mm

WEIGHT Net 6.0kg Shipping 7.0kg
Net 13.2lb Shipping 15.4lb

POWER INPUT 20VAC
30VA max

PROGRAM SOURCES (trim max)

Unbalanced (RCA) Input Impedance:100kohm
Sensitivity: 150mV (-14dBu)

Balanced (XLR) Input Impedance: 1k3ohm
Sensitivity: 1mV (-57dBu)
Min Trim: -46dB

LOCAL SOURCE

Unbalanced (RCA) Input Impedance: 100kohm
Sensitivity: 1.55V (+6dBu)

Balanced (XLR)
MIC Input Impedance: 1k3ohm
Sensitivity: 11mV (-37dBu)

LINE Input Impedance: 45kohm
Sensitivity: 350mV (-7dBu)

SUM INPUT Input Sensitivity: 160mV (-13.5dBu)
Threshold: -46dBu (at output, indpt of input)

FREQUENCY RESPONSE (0DB/-3DB) 15Hz - 17kHz

THD 0.005%

NOISE Page Mic: -84d
BOther Inputs: -89dB

OUTPUT: 1.5Vrms 600ohm
Max: 9Vrms

All measurements are reference to 1.5V (+6dBu)

AUSTRALIA AND NEW ZEALAND

www.australianmonitor.com.au

SYDNEY

(NSW & ACT SALES)

149 Beaconsfield
Street Silverwater
NSW 2128
Private Bag 149
Silverwater NSW 1811
Phone: (02) 9647 1411
Fax: (02) 9648 3698
Email:
nsw@audiotellex.com.au

MELBOURNE

(VIC & TAS SALES)

22/277
Middleborough Road
Box Hill VIC 3128
PO Box 151 Blackburn
South VIC 3130
Phone: (03) 9890 7477
Fax: (03) 9890 7977
Email:
vic@audiotellex.com.au

BRISBANE

(QLD SALES)

42 Commercial Road
Fortitude Valley
QLD 4006
PO Box 871 Fortitude
Valley QLD 4006
Phone: (07) 3852 1312
Fax: (07) 3252 1237
Email:
qld@audiotellex.com.au

ADELAIDE

(SA & NT SALES)

31 Walsh Street
Thebarton
SA 5031
PO Box 157
Hindmarsh SA 5007
Phone: (08) 8352 4444
Fax: (08) 8352 4488
Email:
sa@audiotellex.com.au

PERTH

(WA SALES)

299 Fitzgerald Street
West Perth WA 6005
PO Box 404
North Perth
WA 6906
Phone: (08) 9228 4222
Fax: (08) 9228 4233
Email:
wa@audiotellex.com.au

AUCKLAND

(NZ SALES)

Unit B, 11 Piermark
Drive Albany 1331
New Zealand
PO Box 512
Albany 1331
Phone: (09) 415 9426
Fax: (09) 415 9864
Email:
sales@audiotellex.co.nz

EUROPE/ASIA/MIDDLE EAST

www.australianmonitor.com.au

INTERNATIONAL SALES

149 Beaconsfield Street Silverwater NSW 2128 Australia
Private Bag 149 Silverwater NSW 1811
Phone: 61 2 9647 1411
Fax: 61 2 9648 3698
Email: international@audiotellex.com.au

USA/SOUTH AMERICA

www.australianmonitor.com

SENNHEISER ELECTRONIC CORPORATION

1 Enterprise Drive
Old Lyme CT 06371 USA
Phone: 1 860 434 9190
Fax: 1 860 434 1759
Email: jalexander@sennheiserusa.com