

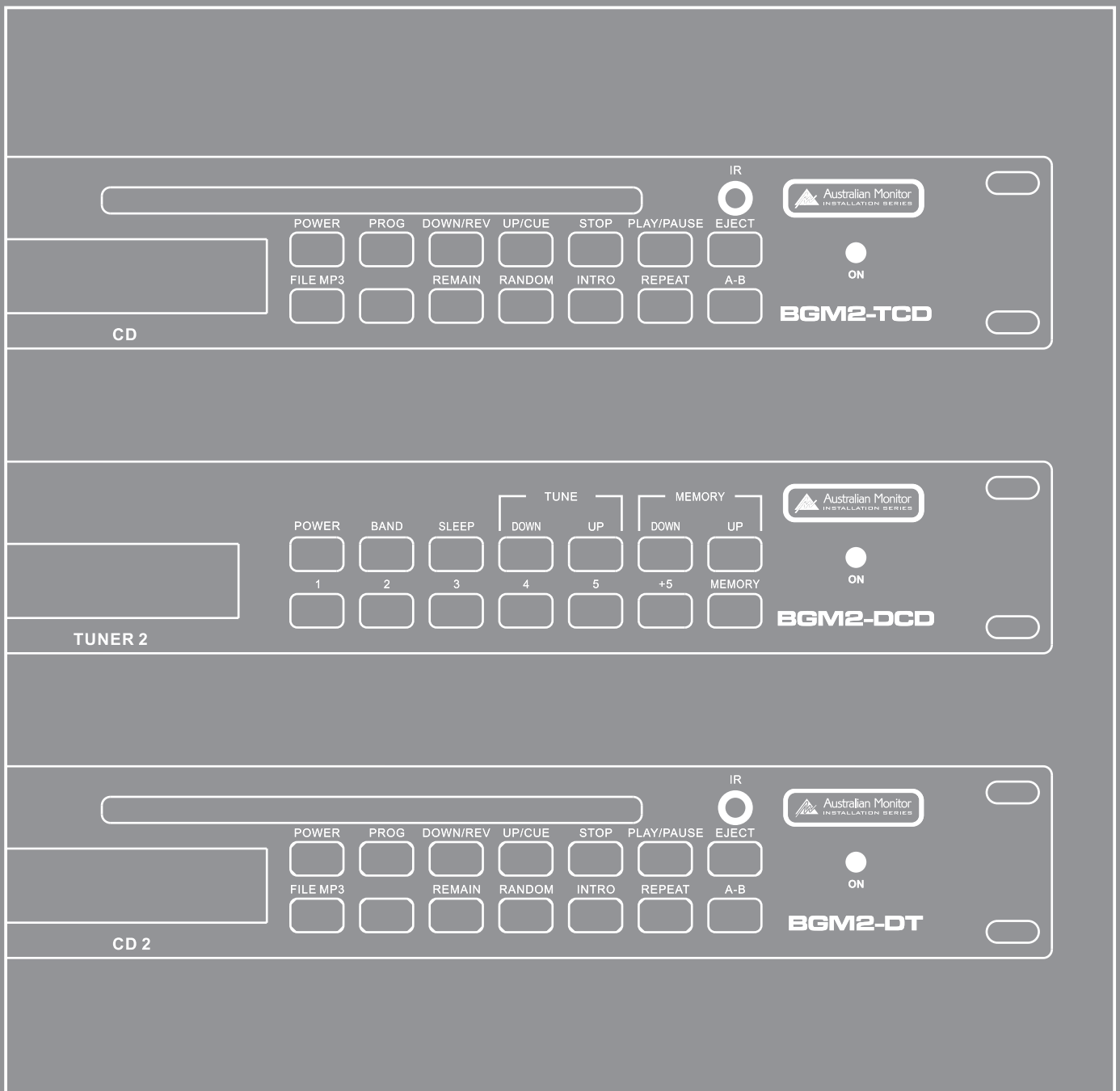

Australian Monitor
INSTALLATION SERIES

BGM2

PROGRAM SOURCE SERIES INSTALLATION AND OPERATION MANUAL





IMPORTANT SAFETY INFORMATION



1. Save the carton and packing material even if the equipment has arrived in good condition. Should you ever need to ship the unit, use only the original factory packing.
2. Read all documentation before operating your equipment. Retain all documentation for future reference.
3. Follow all instructions printed on unit chassis for proper operation.
4. Do not spill water or other liquids into or on the unit, or operate the unit while standing in liquid.
5. Make sure power outlets conform to the power requirements listed on the back of the unit.
6. Do not use the unit if the electrical power cord is frayed or broken. The power supply cords should be routed so that they are not likely to be walked on or pinched by items placed upon or against them, paying particular attention to cords and plugs, convenience receptacles, and the point where they exit from the appliance.
7. Always operate the unit with the AC ground wire connected to the electrical system ground. Precautions should be taken so that the means of grounding of a piece of equipment is not defeated.
8. Mains voltage must be correct and the same as that printed on the rear of the unit. Damage caused by connection to improper AC voltage is not covered by any warranty.
9. Have gain controls on amplifiers turned down during power-up to prevent speaker damage if there are high signal levels at the inputs.
10. Power down & disconnect units from mains voltage before making connections.
11. Never hold a power switch in the "ON" position if it won't stay there itself!
12. Do not use the unit near stoves, heat registers, radiators, or other heat producing devices
13. Do not block fan intake or exhaust ports. Do not operate equipment on a surface or in an environment which may impede the normal flow of air around the unit, such as a bed, rug, weathersheet, carpet, or completely enclosed rack. If the unit is used in an extremely dusty or smoky environment, the unit should be periodically "blown free" of foreign matter.
14. Do not remove the cover. Removing the cover will expose you to potentially dangerous voltages. There are no user serviceable parts inside.
15. Do not drive the inputs with a signal level greater than that required to drive equipment to full output.
16. Do not connect the inputs / outputs of amplifiers or consoles to any other voltage source, such as a battery, mains source, or power supply, regardless of whether the amplifier or console is turned on or off.
17. Do not run the output of any amplifier channel back into another channel's input. Do not parallel- or series-connect an amplifier output with any other amplifier output.

Australian Monitor is not responsible for damage to loudspeakers for any reason.
18. Do not ground any red ("hot") terminal. Never connect a "hot" (red) output to ground or to another "hot" (red) output!
19. Non-use periods. The power cord of equipment should be unplugged from the outlet when left unused for a long period of time.
20. Service Information Equipment should be serviced by qualified service personnel when:
 - A. The power supply cord or the plug has been damaged.
 - B. Objects have fallen, or liquid has been spilled into the equipment
 - C. The equipment has been exposed to rain
 - D. The equipment does not appear to operate normally, or exhibits a marked change in performance
 - E. The equipment has been dropped, or the enclosure damaged.

THIS SAFETY INFORMATION IS OF A GENERAL NATURE AND MAY BE SUPERSEDED BY INSTRUCTIONS CONTAINED WITHIN THIS MANUAL

INTRODUCTION AND CONTENTS

The Australian Monitor Installation Series BGM2 program source series are one rack unit, dual program source players that features either an AM/FM tuner & single disc CD/MP3 player (BGM2TCD), dual CD/MP3 players (BGM2DCD) or, dual AM/FM tuner modules (BGM2DT). The tuner module has one FM band & one AM band, with 10 user selectable preset stations, there is also a programmable sleep function for the tuner. The CD/MP3 player is fully programmable up to 20 tracks & includes Random track selection for CD's & Repeat single track or Repeat all track functions for both CD & MP3's. There is also an optional IR control available for the CD/MP3 player. The BGM2 is supplied with an IEC power lead & AM/FM antenna (on tuner models). The BGM2 also boasts individual stereo outputs from both the Tuner & CD player as well as a stereo priority output. The BGM2 series provides a high quality, rack space friendly & extremely well featured dual background music source at a contractor friendly price.

Your BGM2 will be one of these models:

BGM2-DCD : Dual CD/MP3 players

BGM2-DT : Dual AM/FM tuners

BGM2-TCD : 1 AM/FM Tuner and 1 CD/MP3 player

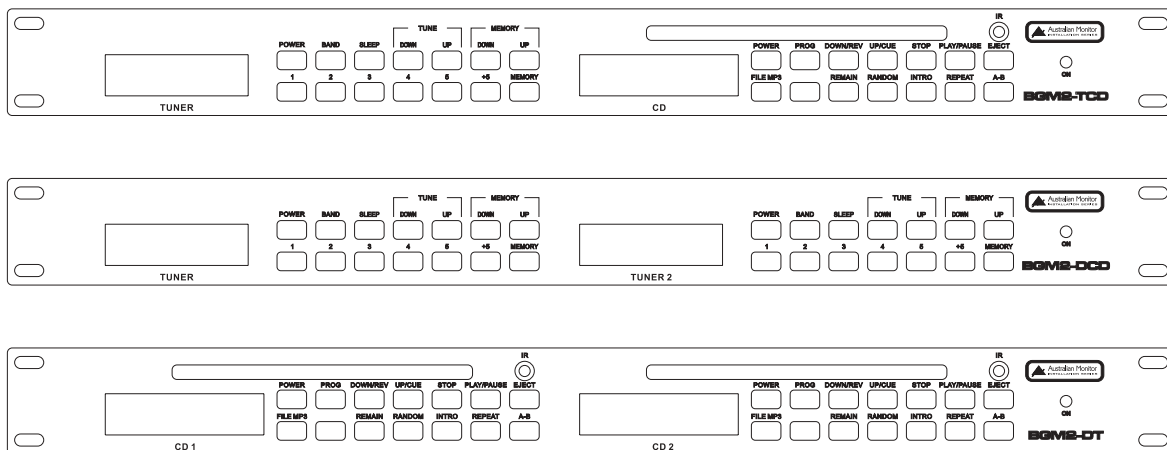

The following diagrams show a BGM2-TCD which has both module types for explanatory purpose.

AUS, EUR, USA

Copyright 13 Dec 2005

Rev A: 13 Dec 2005

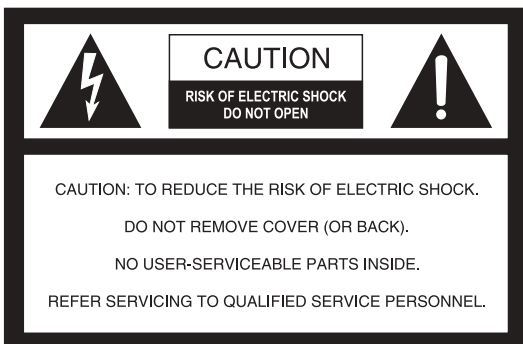

WARNING !

TO REDUCE THE RISK OF FIRE OR ELECTRIC SHOCK,
DO NOT EXPOSE THIS EQUIPMENT TO RAIN OR MOISTURE.



This symbol is intended to alert the user to the presence of uninsulated "dangerous voltage" within the product's enclosure that may be of sufficient magnitude to constitute a risk of electric shock to persons.



This symbol is intended to alert the user to the presence of important operation and maintenance (servicing) instructions in the literature accompanying the appliance.

Caution:

To prevent electric shock do not use this (polarised) plug with an extension cord, receptacle or other outlet unless the blades can be fully inserted to prevent blade exposure. To prevent electric shock, match wide blade of plug to wide slot, fully insert.

INTRODUCTION	3
FRONT PANEL	4
BACK PANEL	6
SPECIFICATIONS	7

FRONT PANEL - CD/MP3 PLAYER

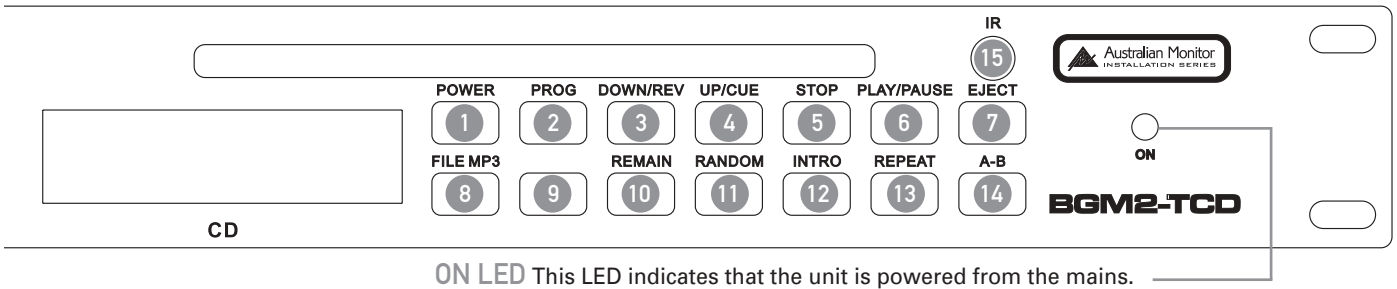

ON LED This LED indicates that the unit is powered from the mains.

CD/MP3 player

1 POWER

Turns only this CD/MP3 player on or off.

2 PROG

This works with conventional CD's only and does not apply to MP3 recorded disks. Allows you to program up to 20 tracks to play in the order you program. The program order is not saved and will be cleared when you press STOP. Use the UP/DOWN buttons to change track and press PROG to move to the next program slot. Press PLAY/PAUSE to start the program order. REPEAT ALL will repeat the order that has been programmed. While in program mode, "Pxx" on the LCD display indicates the program order position. While in program play mode, "Pxx" on the LCD display indicates the actual track number. An ordered program cannot be paused. Advance the program order using UP/DOWN. Once an order position ("Pxx" in program mode) has been entered it cannot be changed. Pressing PROG while the track indicator reads "-" cycles you through the program order. Selecting UP/DOWN changes the track number but pressing PROG again will put that track in the next program position.

3 DOWN/REV

4 UP/CUE

Pressing these buttons momentarily changes the track. Pressing and holding these buttons while a track is playing changes the position within a track. Note that audio is not audible while changing track position.

5 STOP

Stops the CD/MP3 playing and returns to the start of the disk. This button also clears the programmed track order.

6 PLAY/PAUSE

Plays and pauses the track.

7 EJECT

Ejects the disk. Pressing this button while a disk is ejecting returns the disk to the player.

8 FILE MP3

This works with MP3 recorded disks only and does not apply to conventional CD's. This button puts the UP/DOWN buttons into a folder scan mode. Pressing UP or DOWN moves the Track indicator on the LCD display up or down folders, if files had been copied to disk containing a tree or directory structure. Pressing play will advance to the first song in that folder/directory and change the track indicator to the number of that track. Pressing FILE MP3 while a track is playing will stop the track. The LCD display will indicate "ROOT" (as in ROOT directory) when in folder scan mode. Sub folders appear as sequential numbers at the parent folder number position. Adding folders and files to existing material gives unpredictable order results.

9 SPARE

This button is reserved for future use.

10 REMAIN

This works with conventional CD's only and does not apply to MP3 recorded disks. Pressing this button cycles through time information as indicated below. "REMAIN" is displayed on the LCD display when the time is indicating a remaining amount of time.

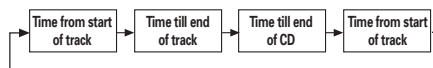

11 RANDOM

This works with conventional CD's only and does not apply to MP3 recorded disks. Pressing RANDOM starts the CD playing in a random track order. The CD will stop after it has played each song on the CD once. Pressing RANDOM while the CD is playing turns the random shuffle off and the CD continues playing as normal through sequential tracks. The time remaining on the CD will display a false reading.

12 INTRO

This works with conventional CD's only and does not apply to MP3 recorded disks. This button will start the CD playing the first 10 secs of each track. The track indicator will flash while playing. Pressing the INTRO button while the CD is playing in intro mode will allow the CD to continue playing as normal through the track.

13 REPEAT

Allows repeating of 1 track or ALL tracks.

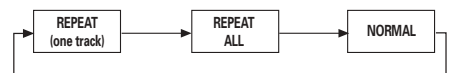

14 A-B

This works with conventional CD's only and does not apply to MP3 recorded disks. A-B allows you to set two markers which the CD will loop between. Setting markers across multiple tracks will produce unpredictable results.

15 IR

This sensor allows for remote control. Contact your local Australian Monitor dealer for more information.

FRONT PANEL - AM/FM TUNER

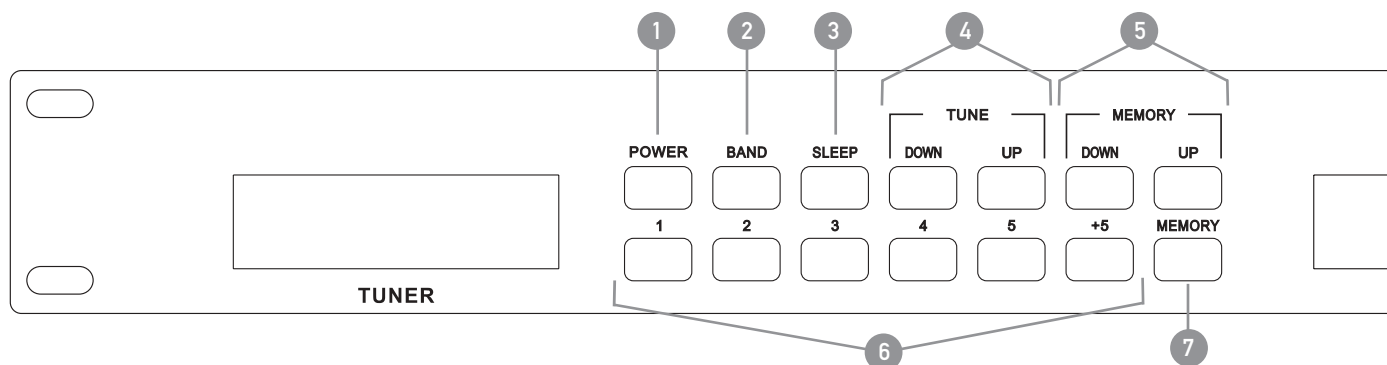

AM/FM Tuner

1 POWER

Turns only this AM/FM tuner on or off.

2 BAND

Changes between AM and FM bands.

3 SLEEP

This button allows you to set a countdown timer to switch the tuner module off. It is set in increments of 10mins from 90mins down to 10mins. Pressing this button while in sleep countdown mode turns off the sleep function.

4 TUNE (UP/DOWN)

Changes the tuner frequency.

5 MEMORY (UP/DOWN)

Changes the preset number.

6 1-5; +5

These buttons allow the immediate selection of a preset. Use +5 to select 6-10.

7 MEMORY

This button allows the memory setting to be programmed. To program a memory setting:

1. Tune to the frequency you want
2. Press MEMORY (MEMO flashes on LCD display),
3. Press a number from 1-5 (or +5 and a number for 6-10)
4. Press MEMORY again. This process must be completed within 4 secs or you will need to start again.

BACK PANEL

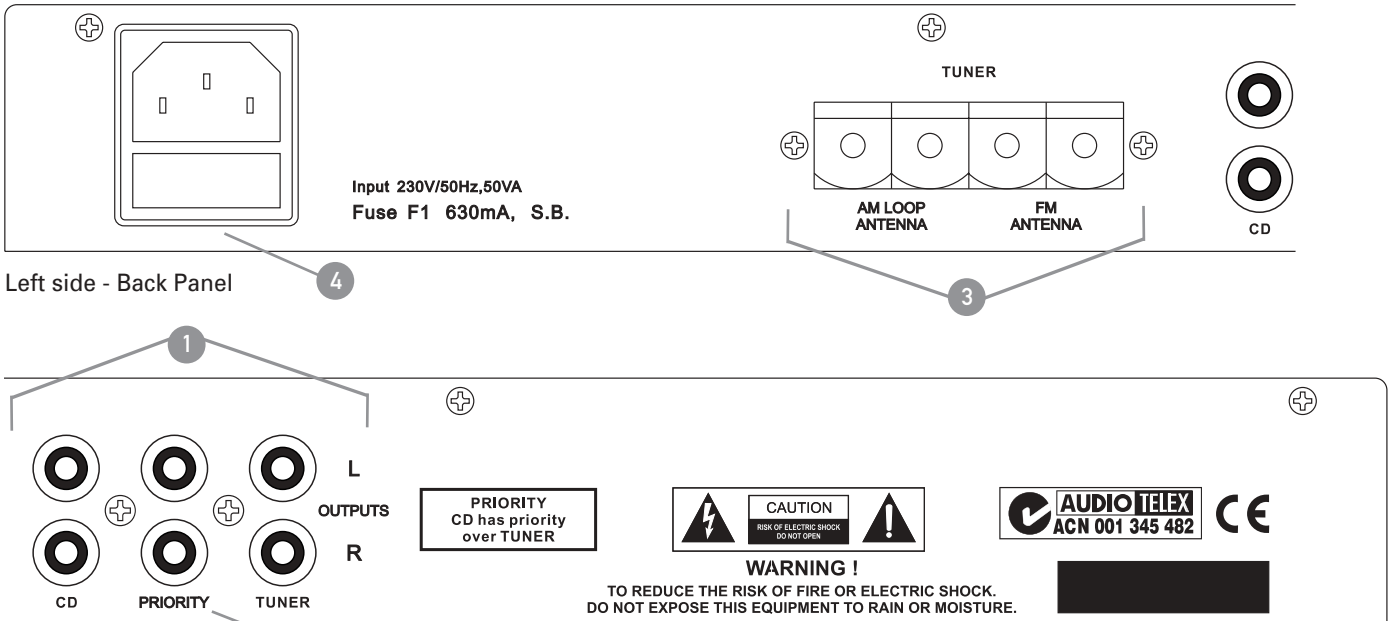

Left side - Back Panel

Right side - Back Panel

1 DIRECT STEREO OUTPUTS

These outputs provide direct signal from the modules.

2 PRIORITY

The BGM2 features a STEREO PRIORITY OUTPUT, in addition to the separate Direct Stereo outputs for the modules. The Priority Output will output the signal from the secondary module until signal appears on the primary module.

BGM2-DCD: CD2 has priority over CD1

BGM2-DT: TUNER2 has priority over TUNER1

BGM2-TCD: CD has priority over TUNER

Signal from the secondary module will return automatically, once the primary module falls silent.

This feature allows the user to utilize only one input on their mixer/amplifier for both modules.

3 ANTENNA

These terminals provide connections for the antenna of each band. There will be two strips of terminals on the BGM2-DT, one for each module.

4 IEC MAINS INPUT SOCKET

This is a standard IEC 3 pin socket. It accepts a standard IEC mains cable, provided. The fuse drawer contains the mains fuse and a spare. The mains fuse is a time lag (slow blow) HRC 20mm x 5mm ceramic type fuse.

The ratings are:

230V/240V model 630mA

115V model 1.2A

 Always replace the fuse with one of the same value and type.

 **NOTE: Always disconnect power to the amplifier before replacing fuses.**

SPECIFICATIONS

SPEC. OF CD/MP3 PLAYER

1. Output Level @ 1kHz, 0dB	1.2V +/- 0.3V
2. Frequency Response	20Hz-20kHz +/- 2dB
3. Separation 1kHz, 0dB	>60 dB
4. T.H.D+ Noise 1kHz, 0dB	<0.05%
5. S/N Ratio	>80 dB

SPEC. OF AM / FM TUNER

FM:

1. Tuning Range	87.5 MHz -108 MHz
2. IF Frequency & Rejection	10.7 MHz >80 dB
3. Image Rejection	>25 dB
4. S/N Ratio 1mV/M Input	46db
5. T.H.D 1mV	<1.0%
6. Auto Tuning Sens.	<50uV

AM:

1. Tuning Range	522kHz - 1620kHz
2. IF Frequency & Rejection	450 kHz >45dB
3. Image Rejection	>30dB
4. S/N Ratio 5mV/M Input	>35dB
5. Auto Tuning Sens.	<2mV

Dimensions: 482 (W) x 44 (H) x 250 (D) mm

AUSTRALIA AND NEW ZEALAND

www.australianmonitor.com.au

SYDNEY

(NSW & ACT SALES)

149 Beaconsfield
Street Silverwater
NSW 2128
Private Bag 149
Silverwater NSW 1811
Phone: (02) 9647 1411
Fax: (02) 9648 3698
Email:
nsw@audiotelx.com.au

MELBOURNE

(VIC & TAS SALES)

22/277
Middleborough Road
Box Hill VIC 3128
PO Box 151 Blackburn
South VIC 3130
Phone: (03) 9890 7477
Fax: (03) 9890 7977
Email:
vic@audiotelx.com.au

BRISBANE

(QLD SALES)

42 Commercial Road
Fortitude Valley
QLD 4006
PO Box 871 Fortitude
Valley QLD 4006
Phone: (07) 3852 1312
Fax: (07) 3252 1237
Email:
qld@audiotelx.com.au

ADELAIDE

(SA & NT SALES)

31 Walsh Street
Thebarton
SA 5031
PO Box 157
Hindmarsh SA 5007
Phone: (08) 8352 4444
Fax: (08) 8352 4488
Email:
sa@audiotelx.com.au

PERTH

(WA SALES)

299 Fitzgerald Street
West Perth WA 6005
PO Box 404
North Perth
WA 6906
Phone: (08) 9228 4222
Fax: (08) 9228 4233
Email:
wa@audiotelx.com.au

AUCKLAND

(NZ SALES)

Unit B, 11 Piermark
Drive Albany 1331
New Zealand
PO Box 512
Albany 1331
Phone: (09) 415 9426
Fax: (09) 415 9864
Email:
audiotlx@nznet.gen.nz

EUROPE/ASIA/MIDDLE EAST

www.australianmonitor.com.au

INTERNATIONAL SALES

149 Beaconsfield Street Silverwater NSW 2128 Australia
Private Bag 149 Silverwater NSW 1811
Phone: 61 2 9647 1411
Fax: 61 2 9648 3698
Email: international@audiotelx.com.au