

ALESIS LIMITED WARRANTY

ALESIS CORPORATION ("ALESIS") warrants this product to be free of defects in material and workmanship for a period of 90 days from the date of original retail purchase. This warranty is enforceable only by the original retail purchaser.

To be protected by this warranty, the purchaser must complete and return the enclosed warranty card within 14 days of purchase.

During the warranty period ALESIS shall, at its sole and absolute option, either repair or replace free of charge any product that proves to be defective on inspection by ALESIS or its authorized service representative.

To obtain warranty service, the purchaser must first call or write ALESIS at the address and telephone number printed below to obtain a Return Authorization Number and instructions concerning where to return the unit for service. All inquiries must be accompanied by a description of the problem. All authorized returns must be sent to ALESIS or an authorized ALESIS repair facility postage prepaid, insured and properly packaged. Proof of purchase must be presented in the form of a bill of sale, cancelled check or some other positive proof that the product is within the warranty period. ALESIS reserves the right to update any unit returned for repair. ALESIS reserves the right to change or improve design of the product at any time without prior notice.

This warranty does not cover claims for damage due to abuse, neglect, alteration or attempted repair by unauthorized personnel, and is limited to failures arising during normal use that are due to defects in material or workmanship in the product.

ANY IMPLIED WARRANTIES, INCLUDING IMPLIED WARRANTIES OF MERCHANTABILITY AND FITNESS FOR A PARTICULAR PURPOSE, ARE LIMITED IN DURATION TO THE LENGTH OF THIS LIMITED WARRANTY. Some states do not allow limitations on how long an implied warranty lasts, so the above limitation may not apply to you.

IN NO EVENT WILL ALESIS BE LIABLE FOR INCIDENTAL, CONSEQUENTIAL OR OTHER DAMAGES RESULTING FROM THE BREACH OF ANY EXPRESS OR IMPLIED WARRANTY, INCLUDING, AMONG OTHER THINGS, DAMAGE TO PROPERTY, DAMAGE BASED ON INCONVENIENCE OR ON LOSS OF USE OF THE PRODUCT, AND, TO THE EXTENT PERMITTED BY LAW, DAMAGES FOR PERSONAL INJURY. Some states do not allow the exclusion or limitation of incidental or consequential damages, so the above limitation or exclusion may not apply to you.

This warranty gives you specific legal rights, and you may also have other rights which vary from state to state.

This warranty only applies to products sold and used in the United States of America. For warranty information in all other countries please refer to your local distributor.

ALESIS
3630 Holdrege Avenue
Los Angeles, California 90016
1-(800)-5-ALESIS

**Your warranty will be in effect
and you will receive warranty information
ONLY IF YOU SEND IN YOUR WARRANTY CARD**

For Customer Service In Mexico call: 95-(800)-5-ALESIS

QUADRAVERB
20K BANDWIDTH SIMULTANEOUS DIGITAL EFFECTS PROCESSOR

Reference Manual



INSTRUCTIONS TO THE USER

This equipment has been tested and found to comply with the limits for a class B digital device, pursuant to Part 15 of the FCC Rules. These limits are designed to provide reasonable protection against harmful interference in a residential installation. This equipment generates, uses and can radiate radio frequency energy and, if not installed and used in accordance with the instructions, may cause harmful interference to radio communications. However, there is no guarantee that interference will not occur in a particular installation. If this equipment does cause harmful interference to radio or television reception, which can be determined by turning the equipment off and on, the user is encouraged to try to correct the interference by one or more of the following measures:

- Reorient or relocate the receiving antenna.
- Increase the separation between the equipment and receiver.
- Connect the equipment into an outlet on a circuit different from that to which the receiver is connected.
- Consult the dealer or an experienced radio/TV technician for help.

This equipment has been verified to comply with the limits for a class B computing device, pursuant to FCC Rules. In order to maintain compliance with FCC regulations, shielded cables must be used with this equipment. Operation with non-approved equipment or unshielded cables is likely to result in interference to radio and TV reception. The user is cautioned that changes and modifications made to the equipment without the approval of manufacturer could void the user's authority to operate this equipment.

NOTES

QUADRAVERB 20K BANDWIDTH SIMULTANEOUS DIGITAL EFFECTS PROCESSOR

Reference Manual

NOTES

NOTES

TABLE OF CONTENTS

INTRODUCTION	2
FEATURES	2
SECTION 1	
QuadraVerb QUICK START.....	3
FACTORY PROGRAMS	3
SELECTING PROGRAMS	4
EDITING PROGRAMS	4
SAVING (STORING) EDITED PROGRAMS	5
RECALLING FACTORY PROGRAMS	5
NAMING A STORED PROGRAM	6
SECTION 2	
DESCRIPTION OF CONTROLS.....	7
FRONT PANEL	7
HEADROOM INDICATOR	7
INPUT	7
OUTPUT	7
DISPLAY	7
PAGE	7
VALUE	7
PROGRAM	7
STORE	8
REVERB	8
DELAY	8
PITCH	8
EQ	8
MIDI	8
CONFIG	9
MIX	9
MOD	9
NAME	9
BYPASS	9
POWER	9
BACKPANEL	10
INPUT JACKS (Left & Right)	10
OUTPUT JACKS (Left & Right)	10
MIDI IN JACK	10
MIDI THRU JACK	10
BYPASS JACK	10
PROGRAM ADVANCE JACK	10
POWER	10
SECTION 3	
INTERFACING QuadraVerb.....	11
WITH INSTRUMENTS, MICROPHONES	11
TO MIXING CONSOLES	12

INTERFACING VIA AUX SENDS.....	12
INTERFACING VIA INSERT SEND AND RETURNS.....	13
CONNECTION TO THE MAIN OUTPUTS.....	14
SETUP.....	14
SECTION 4	
THEORY OF OPERATION.....	15
WHAT <i>QuadraVerb</i> CAN DO.....	15
REVERB.....	15
REVERB TYPES.....	15
PLATE.....	15
ROOM.....	16
CHAMBER.....	16
HALL.....	16
REVERSE.....	16
REVERB PARAMETERS.....	17
REVERB INPUT 1.....	17
REVERB INPUT 2.....	17
REVERB INPUT MIX.....	17
PRE-DELAY.....	18
PRE-DELAY MIX.....	18
REVERB DECAY.....	18
REVERB DIFFUSION.....	18
REVERB DENSITY.....	20
LOW FREQUENCY DECAY.....	22
HIGH FREQUENCY DECAY.....	22
REVERB GATE.....	22
REVERB GATE HOLD.....	22
REVERB GATE RELEASE.....	23
REVERB GATED LEVEL.....	23
DELAY.....	23
DELAY TYPES.....	23
PING PONG DELAY.....	23
STEREO DELAY.....	23
MONO DELAY.....	23
DELAY PARAMETERS.....	24
DELAY INPUT 1.....	24
DELAY INPUT MIX.....	24
DELAY FEEDBACK.....	24
PITCH CHANGE.....	24
TYPES OF PITCH CHANGE.....	24
CHORUS.....	25
FLANGING.....	26
PITCH DETUNE.....	28
PHASE SHIFTER.....	29
PITCH PARAMETERS.....	30
PITCH INPUT.....	30
LFO WAVESHAPE.....	30
LFO SPEED.....	30
LFO DEPTH.....	30
PITCH FEEDBACK.....	30
TRIGGER FLANGE.....	30

Q

QUADMODE™ 48, 93
 QuadMode™ (EQ>Pitch>Delay>Reverb) 41

R

Recalling Factory Programs 5
 Reverb 8, 15, 87, 96
 Editing the Reverb 49, 69, 80
 Hi and Low Frequency Decay 22, 53
 Reverb Decay 18, 52
 Reverb Density 20
 Reverb Diffusion 18, 52
 Reverb Gate 22, 54
 Reverb Gate Hold 22, 54
 Reverb Gate Release 23, 54
 Reverb Gated Level 23, 55
 Reverb Input 1 17, 49, 69
 Reverb Input 2 17, 50, 70
 Reverb Input Mix 17, 51
 Reverb Output Level 36, 66, 73, 78
 Reverb Pre-Delay 18, 51
 Pre-Delay Mix 18, 51
 Reverb Reverse Time 16, 18

S

Saving Edited Programs 5, 45
 Selecting Programs 4
 Send MIDI Program 40, 84
 Shelving 31
 Stereo Chorus 26, 89
 Stereo Delay 23, 55, 57
 Stereo Flange 27, 90
 Stereo Separation 30, 71
 System Exclusive 40, 83, 85

T

Trigger Flange 27, 30, 61

G	
Graphic Equalizer	32, 34, 74, 92, 94
11 Band Graphic	34
Graphic EQ>Delay	43, 74, 98
H	
Headroom	7
Hi and Low Frequency Decay	22, 53
High Rotor Level	35
L	
Leslie Configuration	98
High Rotor Level	35
Lezlie>Delay>Reverb	42, 69
Lezlie Speaker	35, 69, 72, 91, 92, 94
Lezlie Motor Control	31, 71
Lezlie Output Level	36, 72
Lezlie Speed	31, 71
Lezlie Stereo Separation	30, 71
LFO	25, 27
LFO Depth	30, 60, 80, 81
LFO Speed	30, 60, 80, 81
LFO Waveshape	30, 59, 79
Low Frequency Decay	22
M	
Master Effects Level	36, 65
MIDI	8, 92, 97
Editing the MIDI Parameters	81
MIDI Channel	39
MIDI Data Dump	84, 85
MIDI In Jack	10
MIDI Program Change	39, 82
MIDI Thru	40, 83
MIDI Thru Jack	10
Selecting a MIDI Channel	81
Send MIDI Program	40, 84
System Exclusive	40, 83, 85
Mix	9, 93, 98
Editing the Mix Levels	64, 72, 75, 78, 80

Mod	9, 93, 98
Mod 2 through 8	68, 76
Mod Amplitude	39, 68, 76
Mod Source	37, 67
Mod Target	38, 67, 73, 75, 78
Modulating the Parameters	36, 66, 73, 75, 78, 81
Mono Operation	10, 11
N	
Name	9
Naming a Program	6, 86
Noise Gate	22
O	
Omni Mode	39, 81
P	
Parametric EQ	
3 and 5 Band EQ	91
3 Band EQ>Reverb	44, 78, 94, 99
3 Band Parametric	33
5 Band EQ	94
5 Band EQ>Pitch>Delay	43, 76, 99
5 Band Parametric	34
Phase Shifter	29, 91
Editing the Phase Shifter	62
Ping Pong Delay	23, 55
Pitch	8, 89, 97
Pitch Change	24
Pitch Feedback	30, 60
Pitch Input	30, 59, 61
Pitch Modes	58
Pitch Output Level	36, 66, 80
Pitch Detune	28, 90
Editing the Pitch Detune	61
Pre-Delay	18
Pre-Delay Mix	18, 51
Program Advance Footswitch	41, 85
Program Advance Jack	10
Program Change	81
Program Table	39, 40, 82

DETUNE AMOUNT	30
LEZLIE STEREO SEPARATION	31
LEZLIE MOTOR CONTROL	31
LEZLIE SPEED	31
THE EQ	31
EQ TYPES IN THE <i>QuadraVerb</i>	33
3 BAND PARAMETRIC	33
5 BAND PARAMETRIC	34
11 BAND GRAPHIC	34
EQ PARAMETERS	34
LOW EQ FREQUENCY, LOW MID FREQUENCY, MID FREQUENCY, HIGH MID FREQUENCY, HIGH FREQUENCY	34
LOW EQ AMPLITUDE, LOW MID AMPLITUDE, MID AMPLITUDE, HIGH MID AMPLITUDE, HIGH AMPLITUDE	34
LOW MID BANDWIDTH, MID BANDWIDTH, HIGH MID BANDWIDTH	34
GRAPHIC	35
HIGH ROTOR LEVEL	35
THE MIX SECTION	35
MIX PARAMETERS	36
DIRECT SIGNAL SELECT	36
DIRECT SIGNAL LEVEL	36
MASTER EFFECTS LEVEL	36
EQ OUTPUT LEVEL	36
PITCH OUTPUT LEVEL	36
DELAY OUTPUT LEVEL	36
REVERB OUTPUT LEVEL	36
LEZLIE OUTPUT LEVEL	36
MODULATING <i>QuadraVerb</i> 's PARAMETERS	36
MOD PARAMETERS	37
MOD SOURCE	37
MOD TARGET	38
MOD AMPLITUDE	39
<i>QuadraVerb</i> 's MIDI SECTION	39
MIDI PARAMETERS	39
MIDI CHANNEL	39
MIDI PROGRAM CHANGE	39
PROGRAM TABLE	39
MIDI THRU	40
SYSTEM EXCLUSIVE	40
SEND MIDI PROGRAM	40
PROGRAM ADVANCE FOOTSWITCH RANGE	41
CONFIGURATIONS	41
<i>QuadMode</i> [™] (EQ>Pitch>Delay>Reverb)	41
LEZLIE>DELAY>REVERB	42
GRAPHIC EQ>DELAY	43
5 BAND EQ>PITCH>DELAY	43
3 BAND EQ>REVERB	44

SECTION 5

USING *QuadraVerb*.....45

CHANGING PROGRAMS.....45

STORING A PROGRAM.....45

COMPARING PROGRAMS.....47

EDITING PROGRAMS.....47

 SELECTING CONFIGURATIONS.....48

QuadMode™.....48

EDITING THE REVERB.....49

 TYPES OF REVERB.....49

 REVERB INPUT 1.....49

 REVERB INPUT 2.....50

 REVERB INPUT MIX.....51

 REVERB PRE-DELAY.....51

 PRE-DELAY MIX.....51

 REVERB DECAY.....52

 REVERB DIFFUSION.....52

 REVERB DENSITY.....53

HI and LOW FREQUENCY

 DECAY.....53

 REVERB GATE.....54

 REVERB GATE HOLD.....54

 REVERB GATE RELEASE.....54

 REVERB GATED LEVEL.....55

EDITING THE DELAY.....55

 DELAY TYPES.....55

 DELAY INPUT 1.....56

 DELAY INPUT MIX.....56

 DELAY TIME.....57

 DELAY FEEDBACK.....57

EDITING PITCH.....58

 PITCH MODES.....58

EDITING MONO CHORUS and

STEREO CHORUS.....59

 PITCH INPUT.....59

 LFO WAVESHAPe.....59

 LFO SPEED.....60

 LFO DEPTH.....60

 PITCH FEEDBACK.....60

EDITING THE MONO and

STEREO FLANGE.....61

 TRIGGER FLANGE.....61

EDITING THE PITCH DETUNE.....61

 PITCH INPUT.....61

 DETUNE AMOUNT.....62

EDITING THE PHASE

SHIFTER.....62

EDITING THE EQ.....62

 LOW EQ FREQUENCY.....62

 LOW EQ AMPLITUDE.....62

 MID EQ FREQUENCY.....63

 MID EQ BANDWIDTH.....63

 MID EQ AMPLITUDE.....63

INDEX

B

Bandwidth 33, 34

C

Changing Programs 45

Chorus 25, 44, 79

 Editing Mono and Stereo Chorus 59

 Mono Chorus 89

 Stereo Chorus 26, 89

Comparing Programs 47

Configurations 9, 41, 94

 Selecting Configurations 48

D

Delay 8, 23, 81, 88, 97

 Delay Feedback 24, 57, 58

 Delay Input 1 24, 56

 Delay Input Mix 24, 56

 Delay Output Level 36, 66, 72, 80

 Delay Time 57, 58

 Delay types 23, 55

 Editing the Delay 55, 70, 75, 77

 Mono Delay . 23, 55

 Ping Pong Delay. 23, 55

 Stereo Delay. 23, 55, 57

Detune Amount 30, 62

Direct Signal Level. 9, 10, 36, 64, 65

Direct Signal Select 36, 64, 65

E

Edit Buffer 84

Editing Pitch 58, 71, 77, 79

Editing Programs 4, 47

EQ 8, 31, 91, 97

 Editing the EQ 62, 72, 74, 76, 79

 EQ Output Level 36, 65

 Hi EQ Amplitude 34, 64

 Hi EQ Frequency 34, 63

 Low EQ Amplitude 34, 62

 Low Mid Amplitude 34, 62

 Low EQ Frequency 34, 62

 Mid Amplitude 34, 62

 Hi Mid Amplitude 34, 64

 Low Mid Frequency 34, 89

 Mid Frequency 34, 63

 Mid EQ Amplitude 34, 63

 Mid EQ Bandwidth 34, 63

 Shelving 31

 3 and 5 Band EQ 91

 3 Band EQ>Reverb 44, 78, 94, 99

 3 Band Parametric 33

 5 Band EQ 94

 5 Band EQ>Pitch>Delay 43, 76, 99

 5 Band Parametric 34

F

Factory Programs 3, 45, 46

 Recalling Factory Programs 5

Flanging 26

 Editing the Mono and Stereo Flange 61

 Mono Flange 90

 Stereo Flange 27, 90

 Trigger Flange 27, 30, 61

BOOKS ON MIDI

The preceding does not substitute for reading a good book on the subject of MIDI. For further information, refer to the following:

MIDI For Musicians and The Electronic Musician's Dictionary by Craig Anderton; AMSCO Publications. The former was written specifically for musicians with no background in MIDI, and the latter defines terms related to musical electronics.

Music Through MIDI by Michael Boom; Microsoft Press. An excellent text for those just getting started with MIDI, synthesis, and related topics.

The Murphy's Law MIDI Book by Jeff Burger; Alexander Publishing. Emphasizes applications and problem-solving.

Using MIDI by Helen Casabona and David Frederick; Alfred Publishing. A general guide to MIDI with an emphasis on applications.

Understanding MIDI and *Understanding MIDI 2* by various authors; Amordian Press. A collection of MIDI-oriented articles from *Musician* magazine.

Descubriendo MIDI by José Valenzuela; Alesis Publishing. A thorough overview of MIDI in Spanish, suitable for beginners and/or advanced users.

VIDEOS ON MIDI

The Basics Of MIDI featuring Craig Anderton with Steve Smyte; Alesis Publishing. An overview of the concepts and applications of the MIDI interface. Available through Alesis Command Performance Accessory Collection.

HI EQ FREQUENCY	63
HI EQ AMPLITUDE	64
EDITING THE MIX LEVELS	64
DIRECT SIGNAL SELECT	64
DIRECT SIGNAL LEVEL	64
MASTER EFFECTS LEVELS	65
EQ OUTPUT LEVEL	65
PITCH OUTPUT LEVEL	66
DELAY OUTPUT LEVEL	66
REVERB OUTPUT LEVEL	66
MODULATING THE PARAMETERS	66
MOD SOURCE	67
MOD TARGET	67
MOD AMPLITUDE	68
MOD 2 through 8	68
LEZLIE>DELAY>REVERB	69
EDITING THE REVERB	69
REVERB INPUT 1	69
REVERB INPUT 2	70
EDITING THE DELAY	70
EDITING THE PITCH	71
STEREO SEPARATION	71
LEZLIE MOTOR CONTROL	71
LEZLIE SPEED	71
EDITING THE EQ	72
EDITING THE MIX LEVELS	72
MASTER EFFECTS LEVEL	72
LEZLIE OUTPUT LEVEL	72
DELAY OUTPUT LEVEL	72
REVERB OUTPUT LEVEL	73
MODULATING THE PARAMETERS	73
MOD TARGET	73
GRAPHIC EQ>DELAY	74
EDITING THE EQ	74
GRAPHIC EQ	74
EDITING THE DELAY	75
EDITING THE MIX LEVELS	75
MODULATING THE PARAMETERS	75
MOD TARGET	75
MOD AMPLITUDE	76
MOD 2 through 8	76
5 BAND EQ>PITCH>DELAY	76
EDITING THE EQ	76
EDITING THE PITCH	77
EDITING THE DELAY	77
EDITING THE MIX LEVELS	78
MODULATING THE PARAMETERS	78
MOD TARGET	78
3 BAND EQ>REVERB	78
EDITING THE EQ	79
EDITING THE PITCH	79
EDITING THE REVERB	80
EDITING THE MIX LEVELS	80
MODULATING THE PARAMETERS	81

EDITING THE MIDI PARAMETERS81
 SELECTING A MIDI CHANNEL81
 PROGRAM CHANGE81
 PROGRAM TABLE82
 MIDI THRU.....83
 SYSTEM EXCLUSIVE.....83
 SEND MIDI PROGRAM84
 PROGRAM ADVANCE FOOTSWITCH RANGE85
 NAMING A PROGRAM.....86

SECTION 8
APPENDIX.....87
QuadraVerb PAGE CHART.....87
 MIDI CONTROLLER NUMBER CHART.....95
 PARAMETER DEFAULT CHART96
QuadraVerb SPECIFICATIONS99
 BOOKS AND VIDEOS ON MIDI.....100

Low Mid EQ Frequency	100Hz
Low Mid EQ Bandwidth	1.00 OCTAVES
Low Mid EQ Amplitude	+00.00dB
High Mid EQ Frequency	06000Hz
High Mid EQ Bandwidth	1.00 OCTAVES
High Mid EQ Amplitude	+00.00dB
Mod 1 Target	DELAY INPUT MIX
3 BAND EQ>REVERB	
Reverb Type	PLATE 2
Reverb Chorus	ON

***QuadraVerb* SPECIFICATIONS**

FREQUENCY RESPONSE: 16 Hz to 20KHz

DYNAMIC RANGE: 85dB

DISTORTION: 1% typical with 1KHz signal applied at 0dB

SIGNAL LEVELS: Nominal Input Level -10 to +4
 Peak Input Level +20dBv
 Peak Output Level/Wet +14dBV
 Peak Output Level/Dry +20dBV

INPUT IMPEDANCE: 1 Meg Ohm Per Channel in Stereo
 500K Ohm in Mono

PROCESSOR SPEED: 24 Million Instructions Per Second

CONVERSION SCHEME: 16 Bit Linear PCM

USER PROGRAMS (RAM): 100

FACTORY PROGRAMS (ROM): 90

SECTION 8

Sysex Enable	OFF
Send MIDI Program	ALL DATA
Footswitch Range	00 THROUGH 99
CONFIGURATION	EQ>PCH>DL>REVERB
MIX	
Direct Signal	PRE-EQ
Direct Signal Level	+50
Master Effects Level	+50
Pitch Output Level	+50
Delay Output Level	+50
Reverb Output Level	+99
MOD	
Mod 1 Source	PITCH BEND
Mod 1 Target	REVERB INPUT MIX
Mod 1 Amplitude	+00
ADDITIONAL DEFAULTS IN OTHER CONFIGURATIONS	
LEZLIE CONFIG	
Reverb Input 1	LEZLIE OUTPUT
Delay Input Mix	IN < 00 > LEZLIE
Lezlie Stereo Separation	99
Lezlie Motor Control	ON
Lezlie Speed	SLOW
High Rotor Level	+00dB
Lezlie Output Level	+50
GRAPHIC EQ>DELAY	
Left Delay Time	300 milliseconds
Right Delay Time	300 milliseconds
EQ Output Level	+99
Mod 1 Target	LEFT DELAY TIME
5 BAND EQ>PITCH>DELAY	

INTRODUCTION

The Alesis *QuadraVerb* is a full 20K bandwidth, stereo effects unit which allows up to 4 of the most popular digital effects (Reverb, Delay, Pitch Change, and EQ) to be used simultaneously. The signal path and order of the effects is highly flexible and programmable. All effects parameters are fully adjustable and programmable.

The *QuadraVerb* is also MIDI controllable, with many of its parameters accessible from any MIDI controller in real time.

FEATURES

16Hz to 20KHz Frequency Response
 Up to 4, excellent quality, simultaneous effects
 Touch sensitive, multi-speed contoured programming buttons with integral LED indicators
 Fully descriptive 32 character LCD display
 Stores up to 100 programs
 Full MIDI implementation
 Most parameters adjustable in real-time via external MIDI controllers
 Easy editing of all parameters
 All functions, parameters, and volume levels fully programmable
 Stereo in and out
 Extremely flexible effects routing and mixing
 Several choices of reverbs including: Plate, Room, Chamber, Hall, and Reverse
 Several choices of delay including: Ping Pong Delay, Mono Delay, and Stereo Delay
 Several choices of Pitch Shift, including: Mono Chorus, Stereo Chorus, Mono Flange, Stereo Flange, Pitch Detune, and Phase Shifter
 Several choices of Digital EQ, including: 3 band Parametric, 5 band Parametric, and 11 band Graphic
 Any or all Alesis presets can be recalled from ROM at any time

Reverb Gate Release Time	80
Reverb Gated Level	10%
DELAY	
Delay Type	STEREO DELAY
Delay Input 1	POST-EQ
Delay Input Mix	1 < 00 > PITCH
Left Delay Time	100 milliseconds
Delay Feedback Left	00%
Right Delay Time	100 milliseconds
Delay Feedback Right	00%
PITCH	
Pitch Mode	STEREO CHORUS
Pitch Input	POST-EQ
LFO Waveshape	TRIANGLE
LFO Speed	20
LFO Depth	50
Pitch Feedback	00%
EQ	
Low EQ Frequency	200Hz
Low EQ Amplitude	+00.00dB
Mid EQ Frequency	2000Hz
Mid EQ Bandwidth	1.00 OCTAVES
Mid EQ Amplitude	+00.00dB
Hi EQ Frequency	08000Hz
Hi EQ Amplitude	+00.00dB
MIDI	
MIDI Channel	
MIDI Program Change	ON
Program Table	000 - 00
MIDI Thru	

95	Phaser Depth
96	Data Increment
97	Data Increment
98	Non-Registered Parameter Number LSB
99	Non-Registered Parameter Number MSB
100	Registered Parameter Number LSB
101	Registered Parameter Number MSB
102 to 120	Undefined
121 to 127	Reserved for Channel Mode Messages

PARAMETER DEFAULT CHART

PARAMETER DEFAULT VALUE CHART	
REVERB	PLATE
Reverb Type	
Reverb Input 1	DELAY MIX INPUT
Reverb Input 2	DELAY OUTPUT
Reverb Input Mix	1 ←-00→ 2
Reverb PreDelay	040 milliseconds
PreDelay Mix	PRE 99→ POST
Reverb Decay	50
Reverb Diffusion Amount	8
Reverb Density	8
Low Frequency Decay	-00
High Frequency Decay	-20
Reverb Gate	OFF
Reverb Gate Hold Time	00

SECTION 1

QuadraVerb QUICK START

FACTORY PROGRAMS

The *QuadraVerb* contains 90 factory supplied programs which can be modified or erased as needed. At any time one or all of these programs can be recalled in their original form, even if they have been erased or modified, since they are resident in Read Only Memory onboard the unit (see Recalling Factory Programs below).

Factory Program 89 is a demo program that can be used to listen to the differences between the five effects configurations, which are variations of the signal flow path through the *QuadraVerb* (see Configurations - Section 4 and Section 5 for a more complete explanation). You can use the **CONFIG** and **VALUE** buttons to select and audition the five configurations, while listening to the differences in effects in each one.

PLEASE NOTE:

1. *One or all of these programs can be recalled in their original form at any time, even if they have been erased or modified. (see Recalling Factory Programs below).*
2. *It is possible to return to the factory default setting at any time by pressing both **VALUE** buttons simultaneously.*
3. *All pages of the page display examples contained in the manual are referenced to program 89.*

MIDI CONTROLLER NUMBER CHART

SELECTING PROGRAMS

1. Press the PROGRAM button. The LED in the middle of the button will light.
2. Press either VALUE button until the desired program is displayed. *The harder the VALUE button is pressed, the faster the Program numbers will scroll.*

EDITING PROGRAMS

1. Select the Effect (i.e. Reverb, Delay, Pitch, EQ) or function (i.e. MIDI, Config, Mix, Mod) that you wish to adjust. The LED in the middle of the button will light.
2. Press the PAGE button to select the desired parameter to be edited. *The harder the PAGE button is pressed, the faster the parameters will scroll.*
3. Press either VALUE button to adjust the desired parameter. *The harder the VALUE button is pressed, the faster the numbers (or options) will scroll.*
4. Select another Effect or function, if desired.

PLEASE NOTE:

1. Pressing both Value buttons at the same time will return the parameter to its default parameter value (See the Default Chart in the Appendix).

You may compare the edited program with the stored program at any time by pressing the PROG button, then the "up" PAGE button. Press any button to return to the edited program.

MIDI CONTROLLER NUMBER REFERENCE CHART	
0	Undefined
1	Modulation Wheel or Lever
2	Breath Controller
3	Undefined
4	Foot Controller
5	Portamento Time
6	Data Entry MSB
7	Main Volume
8	Balance
9	Undefined
10	Pan
11	Expression Controller
12 to 15	Undefined
16 to 19	General Purpose Controllers (#'s 1 through 4)
20 to 31	Undefined
32 to 63	LSB for Values 0 to 31
64	Damper Pedal (Sustain)
65	Portamento
66	Sostenuto
67	Soft Pedal
68	Undefined
69	Hold 2
70 to 79	Undefined
80 to 83	General Purpose Controllers (#'s 5 through 8)
84 to 90	Undefined
91	External Effects Depth
92	Tremolo Depth
93	Chorus Depth
94	Detune Depth

Leslie Stereo Leslie Speed Leslie Mix Level GRAPHIC 16Hz Boost/Cut 32Hz Boost/Cut 62Hz Boost/Cut 126Hz Boost/Cut 250Hz Boost/Cut 500Hz Boost/Cut 1KHz Boost/Cut 2KHz Boost/Cut 4KHz Boost/Cut 8KHz Boost/Cut 16KHz Boost/Cut 5 BAND EQ Low Mid EQ Freq Low Mid EQ Width Low Mid EQ Amp High Mid EQ Freq High Mid EQ Width High Mid EQ Amp 3 BAND EQ>REVERB Phaser Speed Phaser Depth	These parameters appear only in this configuration These parameters appear only in this configuration These parameters appear only in this configuration These parameters appear only in this configuration.
Mod 1 through Mod 8 Amplitude	-99 to +99 Selects the amount of modification by the controller.

SAVING (STORING) PROGRAMS

EDITED

- Once a program has been edited to your liking, press the **STORE** button. The LED in the middle of the button will light.
- Press either **VALUE** button until the desired program location is displayed. *The harder the VALUE button is pressed, the faster the Program numbers will scroll.*
- Press the **STORE** button a second time to save the program.

RECALLING FACTORY PROGRAMS

- Press the **STORE** button. The LED in the middle of the button will light.
- Press the "up" **PAGE** button to select the **RECALL** software page.
 - Press either **VALUE** button until the desired program location is displayed. *The harder the VALUE button is pressed, the faster the Program numbers will scroll.*
 - Press the "up" **PAGE** button again to move the cursor.
 - Press either **VALUE** button until the desired program location is displayed. *The harder the VALUE button is pressed, the faster the Program numbers will scroll.*
 - If desired, press the "up" **PAGE** button a third time to select the **RECALL ALL 90 ALESIS PROGRAMS** page.

At any time, press the **STORE** button a second time to make *QuadraVerb* execute the store instruction displayed on the LCD.

CONFIG		
Page	Options	Description
Configuration	EQ>PCH>DL>REVERB LEZLIE>DL>REVERB GRAPHIC EQ>DELAY 5BAND EQ>PCH>DLY 3 BAND EQ>REVERB	Selects the signal flow path and internal configuration of the four effects

NAMING A STORED PROGRAM

1. Press the NAME button. The LED in the middle of the button will light.
2. Press either VALUE button to scroll to the desired character. *The harder the VALUE button is pressed, the faster the characters will scroll. If no character is desired, press both Value buttons at the same time.*
3. Press the PAGE button to move the cursor to the next character location of the display.
4. Press either VALUE button to scroll to the desired character. *If no character is desired, press both Value buttons at the same time.*
5. Repeat steps 2 & 3 until the program is named.
6. Store the name by pressing the STORE button twice.
7. Press either the PROGRAM button or any of the Effect or function buttons to exit the NAME page.

MIX		
Page	Options	Description
Direct Signal Select	Pre-EQ Post-EQ	Selects the Direct Signal from either before (Pre-Eq) or after (Post-Eq) the equalizer section.
Direct Signal Level	+00 to +99	Adjusts the level of the Direct Signal only (Not active in Post-EQ mode).
Master Effects Level	+00 to +99	Adjusts the Master level for all effects.
EQ Output Level	+00 to +99	Adjusts the output of the EQ (Not active in Pre-EQ mode).
Pitch Output Level	+00 to +99	Adjusts only the Pitch level.
Delay Output Level	+00 to +99	Adjusts only the Delay level.
Reverb Output Level	+00 to +99	Adjusts only the Reverb level.
Lezlie Output Level	+00 to +99	Adjusts only the Lezlie level. <i>Available in Lezlie Configuration only.</i>

MOD		
Page	Options	Description
Mod 1 Source through Mod 8 Source	Pitch Bend After Touch Note Number Note Velocity Controller #	Selects the type of MIDI controller to be used as a modifier source.
Mod 1 Target through Mod 8 Target	QUAD	Selects the parameter that will be controlled by the source.
	Rev Input Mix Rev PreDelay	
	Rev PreDelay Mix Rev Decay	
	Rev Reverse Time Rev Diffusion	
	Rev Density Rev Lo Decay	
	Rev Hi Decay Delay Input Mix	
	Left Delay Time Left Delay Feedback	
	Right Delay Time Right Delay Feedback	
	LFO Speed LFO Depth	
	Pitch Feedback Lo EQ Freq	
	Lo EQ Boost/Cut Mid EQ Freq	
	Mid EQ BndWidth Mid EQ Boost/Cut	
	Hi EQ Freq Hi Eq Boost/Cut	
	Direct Mix Level Effect Mix Level	
	EQ Mix Level Pitch Mix Level	
	Delay Mix Level Reverb Mix Level	
	LEZLIE	

SECTION 6

Hi EQ Frequency	02000 to 18000Hz	Selects the High EQ Frequency.
Hi EQ Amplitude	+14 to -14dB	Controls the amount of High EQ Frequency boost or cut.
High Rotor Level	Leslie -20 to +06dB	Adjusts the output of the high frequency speaker in the Leslie Simulator.
18Hz 32Hz 62Hz 126Hz 250Hz 500Hz 1KHz 2KHz 4KHz 8KHz 16KHz	Graphic +14 to -14dB	Adjusts the amount of gain in selected frequency band

MIDI		
Page	Options	Description
MIDI Channel	1 through 16 Omni	Selects the receive channel for MIDI operation
MIDI Program Change	OFF ON TABLE	Enables remote change of program via MIDI
Program Table	000 = 00 127 = 99	Allows MIDI program numbers to be transposed to QuadraVerb program numbers
MIDI Echo	OFF ON	Retransmits MIDI information received by QuadraVerb out the THRU jack
SYSEX Enable	OFF ON	Enables QuadraVerb System Exclusive info to be transmitted or received.
MIDI Data Dump	00 to 99 ALL	Selects a program for offloading or saving
Footswitch Range	00 through 00 99 through 99	Selects the programs affected by the PROGRAM ADVANCE footswitch

SECTION 2

DESCRIPTION OF CONTROLS
FRONT PANEL

HEADROOM INDICATOR

The HEADROOM INDICATOR consists of four LED's which indicate both the presence and level of an input signal. Care should be taken so that the red "Clip" LED does not light since this indicates the onset of distortion.

INPUT

The INPUT control is a stereo control that determines the master volume level of the signal being fed into both inputs of the QuadraVerb.

OUTPUT

The OUTPUT control determines the output level of the QuadraVerb's stereo output jacks. Although this control is not programmable, it is possible to program the output levels internally via software (See Editing the Mix Levels).

DISPLAY

The QuadraVerb contains a 32 character, 2 line LCD display which indicates the current status of a program or parameter.

PAGE

When in the editing mode, pressing the PAGE button will allow access to various parameters for editing. The page selection does not loop past the last page to the first page so as not to cause confusion regarding the number of possible pages in each section.

VALUE

Once a desired section and page has been selected, the displayed parameter can be edited using the VALUE buttons. These buttons, as well as the PAGE buttons, are touch sensitive, so that the amount of pressure used will affect the speed at which the values will change.

PROGRAM

The PROGRAM button will display the name and number of the current program. A period appearing to the right of the program number indicates that a parameter or function has been edited and is different from its stored value.

STORE

The **STORE** button allows you to store an edited program or recall any or all of the Alesis factory presets into any available program location(s). To store a program to a specific memory location (00-99), press the **STORE** button once and select the location number by pressing and holding one of the **VALUE** buttons. Pressing the **PAGE** button at this point will give you a choice between recalling any or all of the Alesis factory programs. Pressing the **STORE** button a second time will save the edited program or recall the original factory program, depending on which function you have chosen.

REVERB

The **REVERB** button allows access to the various Reverb types and parameters for editing. The Reverb types available are: Plate, Room, Chamber, Hall, and Reverse. After pressing the **REVERB** button, pressing the **PAGE** buttons will select the parameters while the **VALUE** buttons will select any choices or levels available.

DELAY

The **DELAY** button allows access to three different Delay types as well as all of their parameters. The Delay types available are: Mono, Stereo, and Ping Pong. After pressing the **DELAY** button, pressing the **PAGE** buttons will select the parameters while the **VALUE** buttons will select any choices or levels available.

PITCH

The **PITCH** button allows access to 6 Pitch altering modes as well as all of their various parameters. The Pitch Modes available are: Mono Chorus, Stereo Chorus, Mono Flange, Stereo Flange, Pitch Detune, and Phase Shifter. After pressing the **PITCH** button, pressing the **PAGE** buttons will select the parameters while the **VALUE** buttons will select any choices or levels available.

EQ

The **EQ** button allows access to three different equalizer programs: 3 band parametric, 5 band parametric, or 11 band graphic, depending upon the Configuration selected. After pressing the **EQ** button, pressing the **PAGE** buttons will select the parameters while the **VALUE** buttons will select any choices or levels available.

MIDI

The **MIDI** button accesses the various MIDI parameters. After pressing the **MIDI** button, pressing the **PAGE** buttons

Phase Shift		
Pitch Input	Pre-EQ Post-EQ	Selects the signal from either before (Pre-EQ) or after (Post-EQ) the Equalizer section for input to the Pitch Section.
LFO Speed	00 to 99	Adjusts the speed of the Phase Shifting.
LFO Depth	00 to 99	Controls the amount of Phase Shifting.
Lezlie Stereo Separation	Lezlie 00 to 99	<i>Available in Lezlie Configuration only</i> Adjusts the spread of bass and treble across the stereo image.
Lezlie Motor Control	ON OFF	Selects the rotating speakers of the Lezlie simulator to turn on or off.
Lezlie Speed	SLOW FAST	Selects the rotating speakers of the Lezlie simulator to spin slow or fast.

EQ		
Page	Options	Description
3 and 5 Band EQ		
Low EQ Frequency	020 to 999Hz	Selects the Low EQ Frequency.
Low EQ Amplitude	+14 to -14dB	Controls the amount of Low EQ Frequency boost or cut.
Low Mid EQ Frequency	020 to 500Hz	Selects the Low-Mid EQ Frequency. <i>5 Band EQ only</i>
Low Mid EQ Bandwidth	.20 to 2.55 Octaves	Selects the number of Low-Mid EQ Frequencies acted upon. <i>5 Band EQ only</i>
Low Mid EQ Amplitude	+14 to -14dB	Controls the amount of Low-Mid EQ Frequency boost or cut. <i>5 Band EQ only</i>
Mid EQ Frequency	0200 to 9999Hz	Selects the Mid EQ Frequency.
Mid EQ Bandwidth	.20 to 2.55 Octaves	Selects the number of Mid EQ Frequencies acted upon.
Mid EQ Amplitude	+14 to -14dB	Controls the amount of Mid EQ Frequency boost or cut.
High Mid EQ Frequency	2000 to 18000Hz	Selects the High-Mid EQ Frequency. <i>5 Band EQ only</i>
High Mid EQ Bandwidth	.20 to 2.55 Octaves	Selects the number of High-Mid EQ Frequencies acted upon. <i>5 Band EQ only</i>
High Mid EQ Amplitude	+14 to -14dB	Controls the amount of High-Mid EQ Frequency boost or cut. <i>5 Band EQ only</i>

SECTION 6

LFO Speed	00 to 99	Adjusts the speed of the Chorus
LFO Depth	00 to 99	Controls how much the signal will be detuned
Pitch Feedback	00 to 99%	Causes the effect to be more pronounced and tonal.
Pitch Input	Mono Flange	Selects the signal from either before (Pre-EQ) or after (Post-EQ) the Equalizer section for input to the Pitch Section.
	Pre-EQ Post-EQ	
LFO Speed	00 to 99	Adjusts the speed of the Flanging.
LFO Depth	00 to 99	Controls the amount of Flanging.
Pitch Feedback	00 to 99%	Causes the Flange to become more pronounced and tonal.
Trigger Flange	ON OFF	Controls the Flange by the level of the input signal.
Pitch Input	Stereo Flange	Selects the signal from either before (Pre-EQ) or after (Post-EQ) the Equalizer section for input to the Pitch Section.
	Pre-EQ Post-EQ	
LFO Speed	00 to 99	Adjusts the speed of the Flanging.
LFO Depth	00 to 99	Controls the amount of Flanging.
Pitch Feedback	00 to 99%	
Trigger Flange	ON OFF	Controls the Flange by the level of the input signal.
Pitch Input	Pitch Detune	Selects the signal from either before (Pre-EQ) or after (Post-EQ) the Equalizer section for input to the Pitch Section.
	Pre-EQ Post-EQ	
Detune Amount	99 to +99	Controls the amount of Detuning. Negative is flat; positive is sharp.

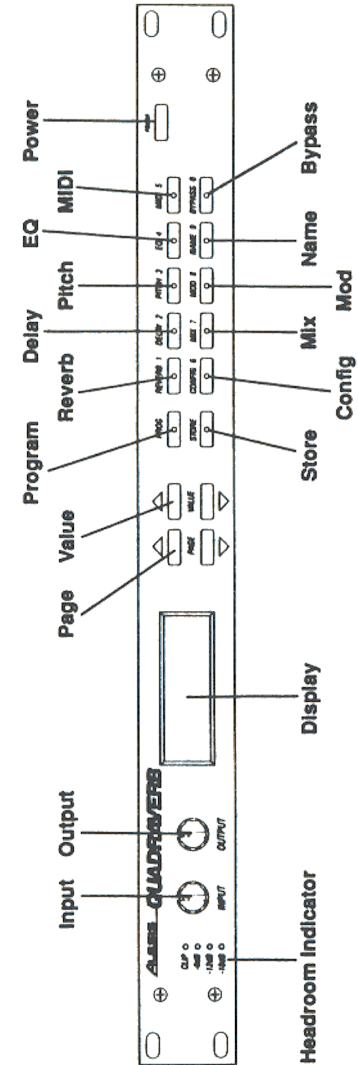

Reverb Diffusion	1 to 9	Controls the time between the Reverb reflections, causing the Reverb to become "thicker".
Reverb Density	1 to 9	Controls the time between the initial "First Reflection" of the reverb and subsequent reflections, causing the Reverb to become "smoother".
Low Frequency Decay	-00 to -60	Controls the amount of low frequencies heard in the Reverb
High Frequency Decay	-00 to -60	Controls the amount of high frequencies heard in the Reverb
Reverb Gate	ON OFF	Turns the Reverb Gate either ON or OFF.
Reverb Gate Hold Time	00 to 99	Controls how long the Reverb Gate stays open.
Reverb Gate Release	00 to 99	Controls the length of time that it takes the Reverb Gate to close
Reverb Gated Level	00 to 99%	Controls how low in level that the Reverb Gate falls to.

will select the parameters while the VALUE buttons will select any choices or levels available. *The MIDI functions are global functions and are not stored with an individual program.*

CONFIG

The CONFIG button selects the various signal flow possibilities of *QuadraVerb's* four Effects. After pressing the CONFIG button, pressing the VALUE buttons will select the available choices.

MIX

The MIX button accesses the various pages that allow mixing the signal levels of not only the Effects, but the dry signal as well. After pressing the MIX button, pressing the PAGE buttons will select the parameters while the VALUE buttons will select any choices or levels available.

MOD

The MOD button lets you control various *QuadraVerb* parameters in real time from a MIDI controller like the pitchwheel, aftertouch, or any other desired controller on a synthesizer or other MIDI device. After pressing the MOD button, pressing the PAGE buttons will select the parameters while the VALUE buttons select any choices or levels available. *It is possible to control up to 8 parameters simultaneously from 1 to 8 MIDI controllers.*

NAME

The NAME button allows you to rename a program with a name as long as 14 characters. After pressing the NAME button, pressing the PAGE buttons moves the cursor while the VALUE buttons selects the characters available. *Pressing both Value buttons at the same time will cause a blank space to appear.*

BYPASS

The BYPASS button bypasses the effects of the *QuadraVerb* and supplies only Direct Signal Level to the outputs when the Direct Signal Select page of the MIX button is selected Pre-EQ (*See Editing the Mix Levels*). If the Direct Signal is selected to be Post-EQ, the EQ output will become the direct, bypassed signal. If the Direct Signal Level or EQ level is set at +00, or the Direct Signal page of the MIX button is selected Post-EQ, then the BYPASS button will act as an effects mute. *BYPASS is also connected to the Bypass*

DELAY		
Page	Options	Description
DELAY TYPE	Ping Pong Delay	The output bounces from side to side (left to right) when in stereo with the speed determined by the delay time.
	Stereo Delay	Two separate delays which can be individually varied.
	Mono Delay	A single delay that has twice the available delay time as the above.
Delay Input 1	Pre-EQ	The input to the Delay section may be taken either from the output of the EQ section, if an equalized signal is desired, or from before the equalizer.
	Post-EQ	
Delay Input Mix	1 < 00 to 99 > Pitch In< 00 to 99 >Lezlie	Allows a mixed signal from either the output of the pitch section or the input of the previous page (Pre or Post EQ) to be applied to the input of the Delay section. <i>Appears in Lezlie Configuration only</i>
Delay Time (Left)	Mono 000 to 800 ms	Precisely adjusts the Delay Time in 1 millisecond increments. <i>QuadMode™ and Lezlie Configurations</i>

Jack on the rear panel and can be activated by a footswitch.

POWER

The POWER button turns the unit on or off.

BACK PANEL

INPUT JACKS (Left & Right)

Accepts instrument to line level input signals. Use the Right Input Jack for mono.

OUTPUT JACKS (Left & Right)

Stereo output of the *QuadraVerb*. Use the Right Output Jack for mono.

MIDI IN JACK

Receives all MIDI information.

MIDI THRU/OUT JACK

Retransmits MIDI information received by *QuadraVerb* to other MIDI units. Used as a MIDI OUT jack for MIDI data dumps.

BYPASS JACK

The BYPASS JACK bypasses the effects of the *QuadraVerb* and supplies only Direct Signal Level to the outputs when the Direct Signal Select page of the Mix button is selected Pre-EQ (See *Editing the Mix Levels*). If the Direct Signal is selected to be Post-EQ, output will become the direct, bypassed signal. If the Direct Signal Level or EQ level is set at +00, or the Direct Signal page of the Mix button is selected Post-EQ, then the BYPASS button will act as an effects mute.

PROGRAM ADVANCE JACK

Allows the programs to be advanced remotely from a footswitch. The program numbers to be affected can be selected by the *Footswitch Range* page of the MIDI button. Any momentary switch can be used.

POWER

Accepts the +9VAC power from the *QuadraVerb* Power Supply. This external supply keeps hum, noise, and ground loops to a minimum.

SECTION 6

APPENDIX

QuadraVerb PAGE CHART

REVERB		
Page	Options	Description
Type	Plate 1 Room 1 Chamber 1 Hall 1 Reverse 1 ----- Plate 2 Room 2 Chamber 2 Hall 2 Reverse 2	Selects the type of Reverb in QuadMode™ and Lezlie configurations Selects the type of Reverb in 3 Band EQ→Reverb configuration
Reverb Input 1	Pre-EQ Post-EQ Pitch Output Delay Mix Input ----- Pre-Lezlie Lezlie Output	Selects the signal source for Reverb Input #1. Appears in Lezlie Configuration only Appears in Lezlie Configuration only
Reverb Input 2	Delay Output Pitch Output ----- Lezlie Output	Selects either a delayed signal or a pitch shifted signal at Reverb Input #2 Appears in Lezlie Configuration only
Reverb Input Mix	1 <00 to 99> 2	Determines the Reverb input levels and balance of the 2 Reverb inputs.
Reverb PreDelay	000 to 140 milliseconds	Allows a slight delaying of the Reverb so that the Direct signal is more easily distinguished from the Reverb.
PreDelay Mix	Pre <00 to 99> Post	Allows an amount of Pre-Delay to be mixed into the Reverb signal path.
Reverb Decay Reverb Reverse Time	00 to 99	Determines the length of time before the Reverb dies. Appears instead of Decay when Reverse type Reverb is selected.

NAMING A PROGRAM

The **NAME** button allows you to rename a program. A program Name may be as long as 14 characters, which may include any of the characters listed in the chart below.

!	"	#	\$	%	&	'	()	*	+	,
-	.	/	0	1	2	3	4	5	6	7	8
9	:	;	<	=	>	?	@	A	B	C	D
E	F	G	H	I	J	K	L	M	N	O	P
Q	R	S	T	U	V	W	X	Y	Z	[\
]	^	_	`	a	b	c	d	e	f	g	h
i	l	k	l	m	n	o	p	q	r	s	t
u	v	w	x	y	z	{		}	->	<-	

To Name a program, first press the **NAME** button. The display will read:



Notice that the cursor lies under the first letter, which in this case is the "Q" of "QUADRAVERB". Now press the **VALUE** button to scroll through the various characters until the desired one is found. Pressing both *Value* buttons at the same time will result in a "space" or no character.

In order to move the cursor to the next character position, press the **PAGE** button until the cursor is in the desired place. In this case, if the **PAGE** button is pressed 2 times, then the cursor will reside under the "A" of "QUADRAVERB" and the display will look like this:



The new name will remain until changed, but is not stored in memory unless the **STORE** function is used. You may exit to another function by pressing another button.

SECTION 3

INTERFACING *QuadraVerb* INSTRUMENTS, MICROPHONES

The *Alesis QuadraVerb* has high impedance inputs that are ideally suited for use either with instruments or line level signals. Although microphones can be connected directly into the *QuadraVerb*, it is recommended that for quietest operation they be connected to a mixing console first and then connected to the *QuadraVerb* as described in Figures 2 or 3.

For mono operation of the *QuadraVerb*, use only the Right Input. This will result in a stereo output. If a mono output is required, only the Right Output should be used. See Figure 1

FIGURE 1A/1B

MONO CONNECTION TO INSTRUMENT OR MICROPHONE

A. MONO IN - MONO OUT

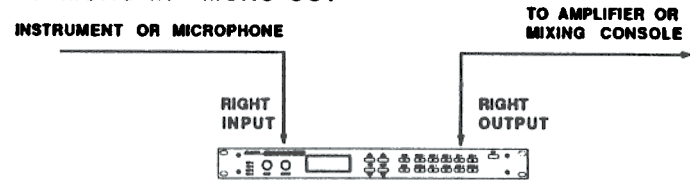

B. MONO IN - STEREO OUT

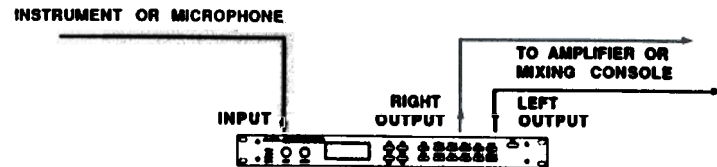

MIXING CONSOLES

INTERFACING VIA AUX SENDS

The QuadraVerb handles mono or stereo sends at all system levels. The input circuitry of the QuadraVerb can easily handle +4dBv levels (+20dBv peaks), while having enough input or output gain to interface with the extremely low signal levels of budget recording systems. The QuadraVerb may be connected to the mixing console in several ways. It can be used to effect several instruments at once by using the auxiliary send and return controls of the console. Simply connect an aux send of the mixing console to the Right Input of the QuadraVerb (or 2 aux sends connected to both left and right of the QuadraVerb for stereo) and then connect the output of the QuadraVerb back to either the aux returns or input channels. See Figure 2

FIGURE 2A/2B
STEREO CONNECTION TO MIXING CONSOLE VIA AUX SENDS

A. MONO IN - STEREO OUT

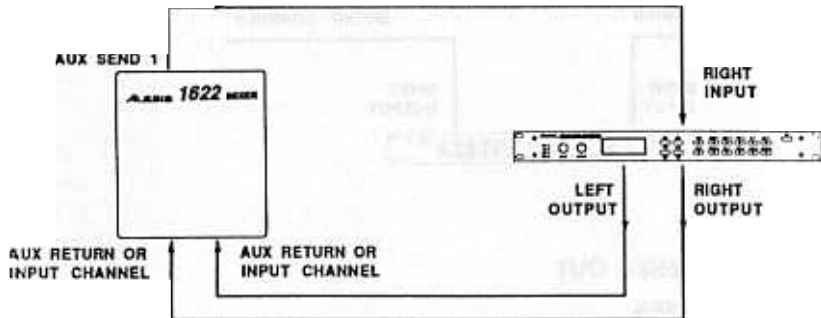

After a program has been selected, the MIDI Data Dump will be initiated when the Store button is depressed. The System Exclusive function must be enabled on the previous page for this function to operate.

PROGRAM ADVANCE
FOOTSWITCH RANGE

Pressing the up PAGE button again will access the last page which will read:

FOOTSWITCH RANGE
00 THROUGH 99

Pressing the up VALUE button selects the program desired. The Footswitch Range page selects the range of programs that the ADVANCE FOOTSWITCH on the back panel will affect. Therefore, if only a limited number of programs are to be used, for instance programs 49 through 53, the display will read as follows:

FOOTSWITCH RANGE
49 THROUGH 53

In this instance, the programs will continuously cycle from 49 to 53 whenever the ADVANCE FOOTSWITCH is triggered.

When the upper PAGE button is pressed, the cursor will switch to the right-hand number for selection. This will read as:

FOOTSWITCH RANGE
99 THROUGH 00

Pressing the up VALUE button selects the program desired.

SEND MIDI PROGRAM

Pressing the up PAGE button again will access the next page which will read:

SEND MIDI PROG:
89 TO 89

This will cause, in this case, *QuadraVerb* program 89 to be dumped into location number 89 of an external MIDI storage device or another *QuadraVerb*. Pressing the VALUE buttons will cause both numbers to increment or decrement simultaneously with the numbers scrolling from 00 to 99. After 99, the display will read:

SEND MIDI PROG:
89 TO EDIT

This means that the program that is currently being edited (including all of the edits) will be transferred via a MIDI Data Dump to a similar area (called an Edit Buffer) in the external storage unit or *QuadraVerb*.

It is also possible to select a memory location in the external unit that is different from the *QuadraVerb* number. To select a different location, press the "up" PAGE button. Notice that the cursor has moved from the left set of numbers to the right set of numbers and read:

SEND MIDI PROG:
89 TO 00

Pressing either VALUE button will select a new program location.

Continuously pressing the "up" VALUE button will cause the numbers to stop and a final Data Dump selection to appear. This will be displayed as:

SEND MIDI PROG:
ALL DATA

B. STEREO IN - STEREO OUT

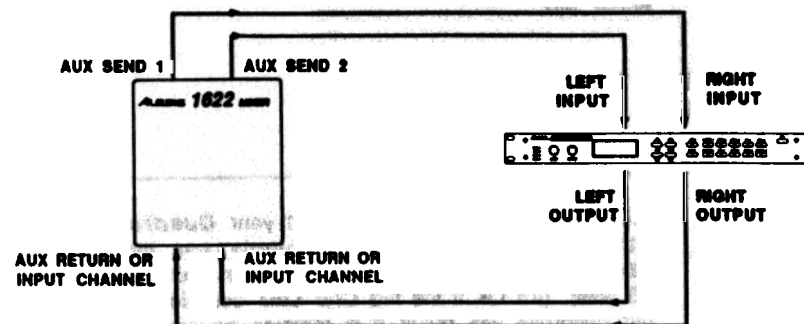

INTERFACING VIA INSERT SEND AND RETURNS

Another method of interfacing is to connect the unit directly to the insert send and return patch points of the channel that is to be effected. See *Figure 3*

**FIGURE 3
CONNECTION TO CONSOLE VIA INSERT PATCH POINTS**

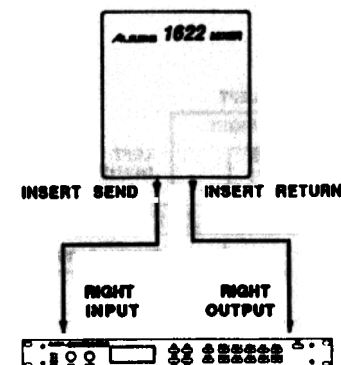

CONNECTION TO THE MAIN OUTPUTS

Still another way of interfacing the *QuadraVerb* to a mixer or recording console would be in-line across the output of your mixing console. See *Figure 4*. This setup would be used only if you needed to effect the entire mix.

**FIGURE 4
STEREO CONNECTION TO THE MAIN OUTPUTS
OF A MIXING CONSOLE**

SETUP

After you have properly interfaced your *QuadraVerb* to either an instrument or mixing console, turn the **INPUT LEVEL** control up until the Level Indicator LEDs show a -6 dB level (It's OK if the red *Clip* LED occasionally lights, but distortion will result if it remains on constantly). Now turn the **OUTPUT LEVEL** control up (clockwise) until there is sufficient level at the amplifier or mixer. Be careful not to turn the **OUTPUT LEVEL** control up too much as it may cause your amplifier or mixer to overload.

PLEASE NOTE:

For optimum signal-to-noise ratio (quietest operation), it is always best to have the **INPUT LEVEL** control turned up as high as possible but not so much that the *Clip* LED lights.

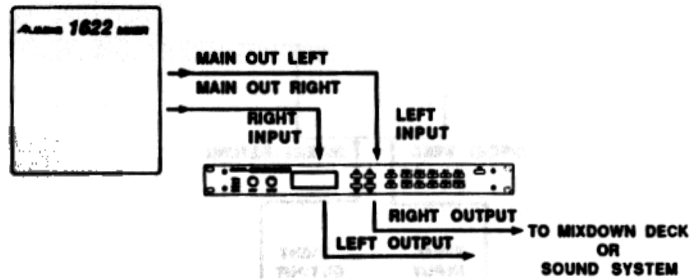

PROGRAM TABLE
101 - 33

PROGRAM TABLE
102 - 39

PROGRAM TABLE
103 - 25

Selecting program 101 on the MIDI controller would result in program 33 of the *QuadraVerb* being accessed, selecting program 102 would result in program 39 of the *QuadraVerb* being accessed, and selecting program 103 would result in program 25 of the *QuadraVerb* being accessed.

MIDI THRU

Pressing the up **PAGE** button takes us to the next page which will read:

MIDI THRU
OFF

Pressing the up **VALUE** button enables the MIDI Thru function and the display will read:

MIDI THRU
ON

MIDI Thru means that any MIDI information received by the *QuadraVerb* will be retransmitted back out the MIDI THRU jack.

SYSTEM EXCLUSIVE

Pressing the up **PAGE** button will access the next page which will read:

SYSEX ENABLE
OFF

Pressing the up **VALUE** button enables the System Exclusive function and the display will read:

SYSEX ENABLE
ON

The MIDI Program Change page allows the *QuadraVerb* to change programs remotely by a MIDI Program Change command if the "ON" option is selected. If the "TABLE" option is selected, the *QuadraVerb* transposes the program numbers of a MIDI controller (a synthesizer, for instance) to match those of the *QuadraVerb*. This is done on the following page, which again is accessed by the PAGE button, which will read:

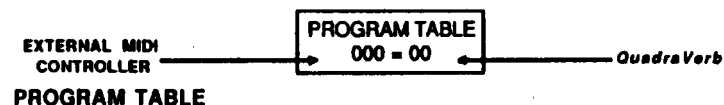

The left-hand set of numbers is the program numbers of the external MIDI controller, while the right-hand numbers are the internal numbers of the *QuadraVerb*. If the VALUE buttons are pressed, the numbers are incremented or decremented from 000 to 127 until the desired program number is reached.

When the upper PAGE button is pressed, the cursor will switch to the right-hand number (*QuadraVerb* program numbers) for selection. This will read as:

PROGRAM TABLE
000 = 00

If the VALUE buttons are pressed, the numbers are incremented or decremented from 00 to 99 until the desired internal program number is reached. Pressing the down PAGE button will switch the cursor back to the left numbers for entering a new program number. Pressing the up PAGE button will switch the cursor to the right side numbers to access the *QuadraVerb* numbers.

The value of the Program Table is that it makes it possible to transpose any MIDI controller program numbers to select the desired *QuadraVerb* program numbers for easy program changes. Also, because *QuadraVerb* has 100 program locations, but there are 127 MIDI program change numbers, the Program Table makes it possible to make use of all 127 program change numbers. For example, if the following displays were entered:

SECTION 4

THEORY OF OPERATION

WHAT *QuadraVerb* CAN DO

QuadraVerb is an extremely sophisticated digital signal processor which is capable of supplying up to 4 wide-bandwidth fully digital effects simultaneously. Each effect has a wide variety of types and parameters that are fully programmable. Let's examine each *QuadraVerb* effect as well as all of their parameters.

REVERB

Reverb can be thought of as a great number of distinct echos, called reflections, that occur so fast that our ear hears them blurred together as one. In nature, different size spaces give distinctly different sounding reverbs, depending upon the size and shape of the space, and the texture of the surfaces that the reflections bounce off of. The various parameters of the *QuadraVerb* make it possible to simulate nearly any natural reverberant space that can be imagined, and a few artificial ones as well.

REVERB TYPES

QuadraVerb has five different reverb types, all of which simulate a different space or produce a different effect. They are:

PLATE

The Plate program simulates an artificial reverb device known as a Plate. Large and heavy, a Plate was a 6 foot long by 4 foot high piece of steel plate (hence the name) with a small speaker strategically placed on one end, and either 1 or 2 transducers placed on the other to pick up the excitations through the steel. Because it is an electro-mechanical device, a Plate must be isolated from outside vibration and noise and constantly tuned to maintain the integrity of the reverb sound. In the early days of recording, Plates were extremely popular because they were almost the only way to

provide any sort of artificial ambience to a recording. The sound of a well-tuned Plate has become quite popular over the years especially when used on vocals or snare drums.

ROOM

The Room program simulates not only rooms of different sizes, but rooms with different surface material as well. A room with soft surfaces such as carpet will produce a reverberant sound with much less high end (treble) than a room with hard surfaces. The Room program of *QuadraVerb* can easily simulate both examples and many, many more.

CHAMBER

The Chamber program simulates another way that studios produce artificial reverberation, utilizing a device known as an Acoustic Chamber. The Chamber is a sealed, tiled room with a speaker at one end and a microphone on the other. Any changes in the resulting reverberation came from moving either the speaker or microphone until the desired sound was found. Chambers are not seen much these days since they are difficult to build correctly and take up a great deal of expensive real estate. Still, a great sounding chamber is a thing to behold. Check out any of Phil Spector's "Wall of Sound" recordings, which feature extensive use of the large acoustic chamber at the old Gold Star Studios.

HALL

Much larger than a Room, Halls are characterized by their high ceilings, irregular shapes, and generally uniform density of reflections.

REVERSE

The Reverse program is an inverted reverb program in which the volume envelope is reversed. This means that the signal begins softly but grows louder until it is cut off, rather than loud to soft as in the Gate program. The Reverse program is extremely programmable and can be used for some great special effects.

MODULATING THE PARAMETERS

All Mod pages appear the same as in the QuadMode™ Configuration except that the Delay and most of the Pitch targets are omitted. In this configuration, the only Pitch targets that are active are LFO Speed and LFO Depth.

EDITING THE MIDI PARAMETERS

The MIDI button accesses the various MIDI parameters of *QuadraVerb*. The MIDI functions are global functions and are not stored with an individual program.

SELECTING A MIDI CHANNEL

After pressing the MIDI button, the LED will light and the display will read:

```
MIDI CHANNEL:
  01
```

This indicates the MIDI channel on which the *QuadraVerb* will receive all MIDI information. Pressing the VALUE button will select channels 1 through 16, or Omni mode. Omni mode responds to MIDI commands received on all channels simultaneously, and transmits on channel 1.

PROGRAM CHANGE

Pressing the PAGE button a second time will access the next page which will read:

```
MIDI PROGRAM
CHANGE: OFF
```

Pressing the VALUE button will select these additional options:

```
MIDI PROGRAM
CHANGE: ON
```

```
MIDI PROGRAM
CHANGE: TABLE
```

Pressing the "up" PAGE button again will cause the display to read:

LFO SPEED:
20

Pressing the VALUE button will choose the speed.

Pressing the "up" PAGE button again will cause the display to read:

LFO DEPTH:
50

Pressing the VALUE button will choose the Chorus Depth.

EDITING THE REVERB

The pages and parameters are similar to those in the QuadMode™ Configuration except that a number "2" will appear behind the reverb type in the display. This is to signify that the Reverb in this configuration takes advantage of the increased processing power available when only two Effects are active.

For example, in the 3 Band>Reverb Configuration, the reverb type display will appear:

REVERB TYPE:
PLATE 2

In the QuadMode™ and Leslie Configurations, the Reverb type displays will read:

REVERB TYPE:
PLATE 1

EDITING THE MIX LEVELS

All Mix pages appear the same as in the QuadMode™ Configuration except that the Delay Output Level and the Pitch Output Level pages are omitted.

REVERB PARAMETERS

REVERB INPUT 1

There are two inputs to the Reverb section of the *QuadraVerb*. Reverb Inputs #1 and #2 can have their signal sent from several locations in the signal chain. Reverb Input #1 can select either the Pre-EQ, Post-EQ, Pitch Output, or Delay Mix Input signal. If the signal is taken from the Delay Mix, the Reverb will be sent a composite signal taken from the outputs of the Pitch and EQ sections, as selected by the Delay Input selections (*see the next section on Delay*). If the signal is taken from the output of the Pitch section (Pitch Output), then the Reverb will be chorused, flanged, detuned, or phase shifted, depending upon which option is selected in the Pitch section. If the signal is taken from the output of the EQ section (Post-EQ), then the reverb will be equalized. This is ideal to tonally shape the reverb as desired. If the signal is taken Pre-EQ, then the Reverb will receive direct, unaffected signal only.

REVERB INPUT 2

Reverb Input #2 can have as its source either the Pitch Output or the Delay Output. If the signal is taken from the Delay Output, the Reverb will be delayed by the amount of delay time set for the Delay (plus any Reverb Pre-Delay). If the signal is taken from the output of the Pitch section (Pitch Output), then the Reverb will be chorused, flanged, detuned, or phase shifted, depending upon which option is selected in the Pitch section.

REVERB INPUT MIX

It is possible to control the balance between Reverb Inputs 1 and 2 and therefore control the blend between the various input sources. This makes it possible to have the signal from the EQ, Pitch, or Delay sections, or the Direct Pre-EQ signal feed Reverb inputs in any combination or amount.

PRE-DELAY

Pre-Delay is the slight delaying of the Reverb itself so that the dry signal more easily stands out from the Reverb. A bit of Pre-Delay can sometimes make certain instruments (such as snare drums) sound bigger.

PRE-DELAY MIX

The Pre-Delay Mix allows you to mix the amount of Pre-Delay (the length of Time of the Pre-Delay is controlled by the Pre-Delay page) into the Reverb signal path. This gives you the ability to hear a bit of the Reverb before the loudest part of the Reverb (the Pre-Delayed Reverb) sounds. This makes for bigger and smoother sounding Reverb settings and is another unique feature of the *QuadraVerb*.

REVERB DECAY

The Reverb Decay determines how long the Reverb will sound before it dies away. When using the Reverse Reverb type, Reverb Decay will be displayed as REVERB REVERSE TIME.

REVERB DIFFUSION

As stated previously, Reverb can be thought of as a great number of distinct echos, called reflections, that occur so fast that our ear hears them blurred together as one. Diffusion is the space between these echos. On some Reverb programs of the *QuadraVerb*, you may actually hear the multiple echos repeating when the diffusion amount is set to 1. As you increase the diffusion amount, you will no longer perceive distinct echos and will observe the Reverb sounding "thicker". Therefore, the Reverb Diffusion Amount can be thought of as control over how thick the reverb will be.

Perhaps the best way of thinking about Diffusion is in the traditional acoustic sense. That is, diffusion is the uniform intensity of sound everywhere in a room. SEE **FIGURE 5**

EDITING THE EQ

The pages and parameters in the EQ mode are the same as in the QuadMode™ Configuration.

EDITING THE PITCH

Although not indicated on the Configuration display, the stereo chorus is active in this configuration. This is a very subtle addition to the reverb, causing it to "swim" (or be smoother) a bit more. *Depending upon the type of reverb and the parameters chosen, it is possible for this function to sound as if it sometimes has no apparent effect*

After pressing the PITCH button, the first display will read either of the following:

REVERB CHORUS:
ON

or

REVERB CHORUS:
OFF

Pressing the VALUE button will cause the Chorus function to toggle either ON or OFF.

Pressing the "up" PAGE button will cause the display to read:

LFO WAVESHAPe:
_ TRIANGLE

LFO WAVESHAPe:
_ SQUARE

Pressing the VALUE button will toggle between the two choices. *The Triangle Waveshape will sound smoother and less imposing while the Square Waveshape will be more dramatic.*

EDITING THE MIX LEVELS

All Mix pages appear the same as in the QuadMode™ Configuration except that the Reverb Output Level page is omitted.

MODULATING THE PARAMETERS

All Mod pages appear the same as in the QuadMode™ Configuration except for the addition of the following:

MOD TARGET

MOD 1 TARGET:
LOW MID EQ FREQ

MOD 1 TARGET:
LOW MID EQ WIDTH

MOD 1 TARGET:
LOW MID EQ AMP

MOD 1 TARGET:
HIGH MID EQ FREQ

MOD 1 TARGET:
HIGH MID EQ WIDTH

MOD 1 TARGET:
HIGH MID EQ AMP

The above additions also appear in Mod 2 through 8 pages as well.

3 BAND EQ>REVERB

Pressing the CONFIG button, then the up VALUE button again will cause the display to read:

CONFIGURATION:
3BAND EQ>REVERB

FIGURE 5

REVERB DIFFUSION

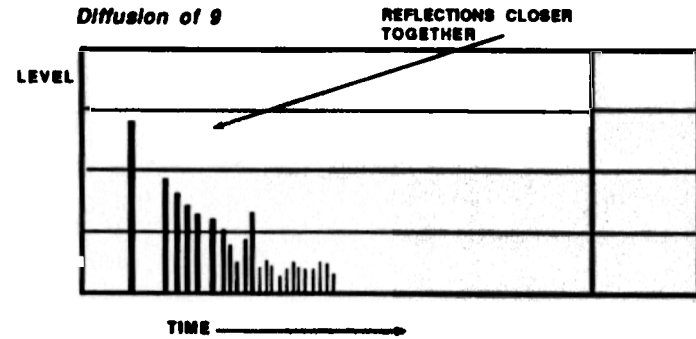
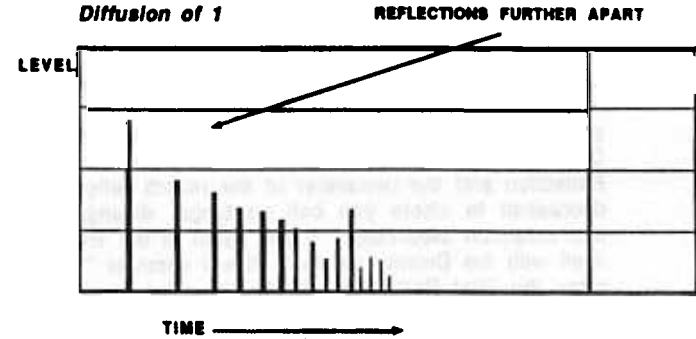

REVERB DENSITY

In order to explain exactly what Reverb Density is, we must refer to the previous explanation of Reverb Diffusion. We already know that reverb consists of distinct echos, called reflections that occur so fast that our ears usually can't distinguish them separately. The most important of these, and the loudest, is the First Reflection. Usually, in nature, there is a space of time between the First Reflection and all of the other reflections that make up the reverb sound field. If you listen to only the reverb with the Reverb Density set at 1, you will hear your source sound repeat, a short bit of silence, and then the onset of the reverb. As the Reverb Density is increased, the time between the First Reflection and the remainder of the reverb reflections is decreased to where you can no longer distinguish the first reflection separately. If you listen to the Reverb by itself with the Density set to 9, it will seem to "explode" since the First Reflection will no longer be perceived as a separate echo. This parameter can be quite useful with highly transient source material such as percussion, where the sound can sometimes become confused by the First Reflection seemingly causing an additional "hit".

SEE FIGURE 6

Pressing the VALUE button will increment or decrement the amount in 1Hz increments.

All other EQ pages remain the same as the QuadMode™ Configuration except for the addition of the following pages which can be accessed by pressing the PAGE button until the pages are displayed:

LOW MID EQ FREQ
100Hz

LOW MID EQ WIDTH
1.00 OCTAVES

LOW MID EQ AMP
+00.00dB

HIGH MID EQ FREQ
05000Hz

HIGH MID EQ WIDTH
1.00 OCTAVES

HIGH MID EQ AMP
+00.00dB

In each of these displays, as before, pressing the VALUE button will increase or decrease the value of each parameter.

EDITING THE PITCH

All Pitch pages appear the same as in the QuadMode™ Configuration.

EDITING THE DELAY

All Delay pages appear the same as in the QuadMode™ Configuration.

MOD 1 TARGET: DELAY FEEDBACK	MOD 1 TARGET: 16Hz BOOST/CUT	MOD 1 TARGET: 32Hz BOOST/CUT
MOD 1 TARGET: 62Hz BOOST/CUT	MOD 1 TARGET: 126Hz BOOST/CUT	MOD 1 TARGET: 250Hz BOOST/CUT
MOD 1 TARGET: 500Hz BOOST/CUT	MOD 1 TARGET: 1KHz BOOST/CUT	MOD 1 TARGET: 2KHz BOOST/CUT
MOD 1 TARGET: 4KHz BOOST/CUT	MOD 1 TARGET: 8KHz BOOST/CUT	MOD 1 TARGET: 16KHz BOOST/CUT
MOD 1 TARGET: EFFECT MIX LEVEL	MOD 1 TARGET: EQ MIX LEVEL	MOD 1 TARGET: DELAY MIX LEVEL

MOD AMPLITUDE

All Mod Amplitude pages, which are accessed by the VALUE button, are the same as in the QuadMode™ Configuration.

MOD 2 through 8

Mod Source, Target, and Amplitude for 2 through 8 have the same pages as above.

5 BAND EQ>PITCH>DELAY

Pressing the CONFIG button, then the up VALUE button again will cause the display to read:

CONFIGURATION:
5BAND EQ>PCH>DLY

EDITING THE EQ

Pressing the EQ button will access the first page of the EQ which will read:

LOW EQ FREQUENCY
200Hz

FIGURE 6

REVERB DENSITY

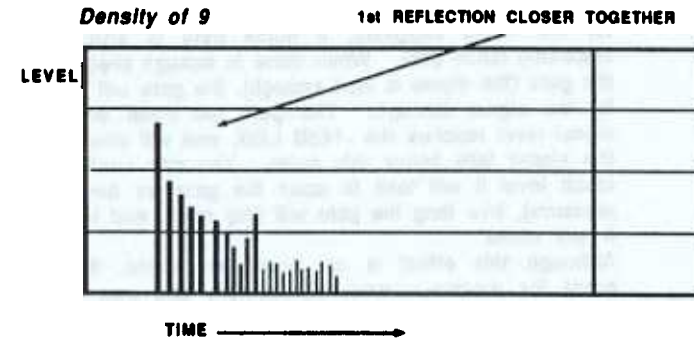
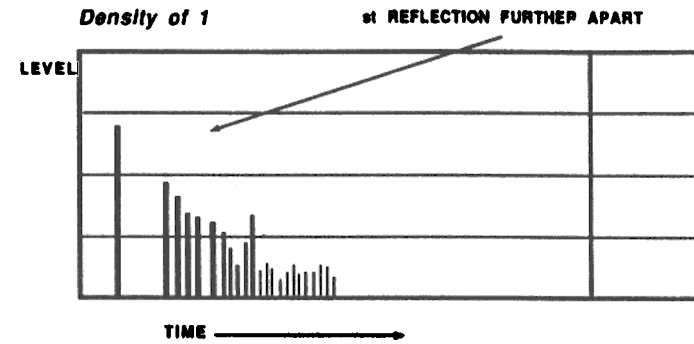

LOW FREQUENCY DECAY and HIGH FREQUENCY DECAY

These two parameters allow the decay time to be set separately for both the low and high frequencies of the Reverb. This means that you have control over the tonal shape of the Reverb itself, being able to make the high frequencies die faster if the reverb is too bright, and being able to make the lows die faster if the reverb is too boomy. This allows you to simulate different surfaces of a room or hall, with softer surfaces having more high frequency decay and smaller rooms having more low frequency decay.

REVERB GATE

Gated Reverb is a very popular effect on drums first found on English records in the early 1980's. The *QuadraVerb* can simulate applying a noise gate (a device that automatically decreases the volume once the signal falls below a certain level) across the output of the reverb thereby causing the initial attack of the reverb to sound very big, but the tail of the reverb to be cut off very quickly.

As the name suggests, a noise gate is sort of an electronic fence gate. When there is enough pressure on the gate (the signal is loud enough), the gate will open to let the signal through. The gate will open when the signal level reaches the -18dB LED, and will close when the signal falls below this point. You can control how much level it will take to open the gate (or how much pressure), how long the gate will stay open, and how fast it will close.

Although this effect is not found in nature, it works great for modern drums, percussion, and any quickly repeated, transient source. The Reverb Gate function is turned on or off by this page.

REVERB GATE HOLD

The Reverb Gate Hold parameter determines how long that the gate will be held open before it begins to turn off.

EDITING THE DELAY

In this configuration, all Delay pages are displayed as in the *QuadMode™* Configuration with the exception of the *Delay Input Mix* page, which is omitted.

EDITING THE MIX LEVELS

After pressing the MIX button, the display will read one of the following:

MASTER EFFECTS
LEVEL: +50

EQ OUTPUT
LEVEL: +50

DELAY OUTPUT
LEVEL: +50

Pressing the PAGE button will select one of these parameters for editing. Pressing the VALUE buttons will cause the display to increment or decrement.

MODULATING THE PARAMETERS

After pressing the MOD button, the display will read:

MOD 1 SOURCE:
PITCH BEND

All Mod sources, which are accessed by the VALUE button, are the same as in the *QuadMode™* Configuration.

MOD TARGET

Pressing the PAGE button will access the next display:

MOD 1 TARGET:
DELAY TIME

Pressing the VALUE button will access the following pages:

GRAPHIC EQ>DELAY

Pressing the CONFIG button, then the up VALUE button again will cause the display to read:

CONFIGURATION:
GRAPHIC EQ>DELAY

EDITING THE EQ

GRAPHIC EQ

In the Graphic EQ configuration, the 11 Band Graphic Equalizer is available. The display reads as follows:

GRAPH-.....
16Hz

As the VALUE button is pressed/held, the flashing line, which in this case indicates the level of 16Hz, will raise or lower, which indicates an increase or decrease in level. *The Graphic EQ is capable of a plus or minus 14 dB boost or cut, but the display only shows a 7 step resolution, or 2 dB per step. You must press the VALUE button twice to have the flashing line move 1 step.*

As you can see, the display resembles the actual frequency graph the same as a graphic equalizer.

Each time the PAGE button is pressed, the display will advance to the next octave, whose frequency will be displayed and corresponding line will flash. Once again, as the VALUE button is pressed/held, the flashing line, which represents that particular octave, will raise or lower. The octaves that are displayed are:

16Hz, 32Hz, 620000Hz, 126Hz, 250Hz, 500Hz, 1KHz, 2KHz, 4KHz, 8KHz, and 16KHz

REVERB GATE RELEASE

The Reverb Gate Release parameter determines how fast the gate will close.

REVERB GATED LEVEL

The Reverb Gated Level parameter controls the level of the reverb signal after the gate closes. In other words, if the Reverb Gated Level is set to 00% then no reverb will sound after the gate turns it off. If the Reverb Gated Level is set to , say 50%, then some reverb signal will still be present even after the gate turns off the main reverb signal.

DELAY

The *QuadraVerb* has three different Delay types available which are outlined below:

PING PONG DELAY

This is called a "Ping Pong Delay" because the output bounces from side to side (left to right) when in stereo with the speed determined by the delay time. The maximum delay time is 400 milliseconds in the QuadMode™ and Leslie Configurations, and 750 milliseconds in the Graphic>Delay and 5 Band EQ>Pitch> Delay Configurations.

STEREO DELAY

The Stereo Delay is actually two separate delays, which can be individually varied. The maximum delay time for each delay is 400 milliseconds in the QuadMode™ and Leslie Configurations, and 750 in the Graphic>Delay, and 5 Band EQ>Pitch>Delay Configurations.

MONO DELAY

The Mono Delay has the advantage of twice the available delay time, or 800 milliseconds in the QuadMode™ and Leslie Configurations, and 1500 in the Graphic>Delay, and 5 Band EQ>Pitch>Delay Configurations.

DELAY PARAMETERS

DELAY INPUT 1

After the Delay Type is selected, the Delay settings may be adjusted. The signal sent to Input 1 of the Delay section may be taken either from the output of the EQ section if an equalized signal is desired, or from before the equalizer.

DELAY INPUT MIX

This parameter allows a mixed signal from either the output of the pitch section or the input of the previous page (Pre or Post EQ) to be applied to the input of the Delay section. This signal can be adjusted so that either the Pre/Post signal or the Pitch output signal only are fed to the input of the Delay section, or any balance of the two.

DELAY TIME

This parameter determines the amount of time the input signal will be delayed.

DELAY FEEDBACK

Delay Feedback means that a portion of the delay signal output is "fed back" into the input. This results in the delay repeating itself. The more feedback, the more repeats.

PITCH CHANGE

TYPES OF PITCH CHANGE

The PITCH button allows access to 6 pitch altering modes as well as all of their various parameters. The Pitch Modes available are: Mono Chorus, Stereo Chorus, Mono Flange, Stereo Flange, Pitch Detune, and Phase Shifter. Although some of these effects can sound similar to one another depending on the parameter settings, each is achieved differently and can be quite dramatic under the right circumstances. Pitch effects are achieved by splitting the signal into at least two parts, effecting the pitch of one of the parts, then mixing them back together. This eventual mixing is essential since the overall sound of the effect is achieved by the actual difference between the normal, unaffected signal and the effected signal. *SEE FIGURE 7*

Pressing the VALUE button will cause the display to increment or decrement.

REVERB OUTPUT LEVEL

Pressing the "up" PAGE button will bring on the next display:

REVERB OUTPUT
LEVEL: +99

Pressing the VALUE button will cause the display to increment or decrement.

These are the only Mix pages available in this configuration.

MODULATING THE PARAMETERS

Most MOD parameters remain the same as in the QuadMode™ Configuration with the exception of the following, which are accessed by pressing the up MOD button once and then the VALUE button:

MOD TARGET

MOD 1 TARGET:
LEZLIE STEREO

MOD 1 TARGET:
LEZLIE MOTOR

MOD 1 TARGET:
LEZLIE SPEED

MOD 1 TARGET:
LEZLIE HI LEVEL

MOD 1 TARGET:
LEZLIE MIX LEVEL

EDITING THE EQ

Pressing the EQ button will cause the display to read:

HIGH ROTOR
LEVEL +00dB

Pressing the VALUE button will cause the display to increment or decrement. A Leslie speaker system has two rotating rotor speakers. Sometimes it is desirable to have the High (treble) Rotor louder or softer in volume.

EDITING THE MIX LEVELS

MASTER EFFECTS LEVEL

Pressing the MIX button will cause the display to read:

MASTER EFFECTS
LEVEL: +99

Pressing the VALUE button will cause the display to increment or decrement.

LEZLIE OUTPUT LEVEL

Pressing the "up" PAGE button will bring on the next display:

LEZLIE OUTPUT
LEVEL: +99

Pressing the VALUE button will cause the display to increment or decrement.

DELAY OUTPUT LEVEL

Pressing the "up" PAGE button will bring on the next display:

DELAY OUTPUT
LEVEL: +99

FIGURE 7

BASIC PITCH FLOW CHART

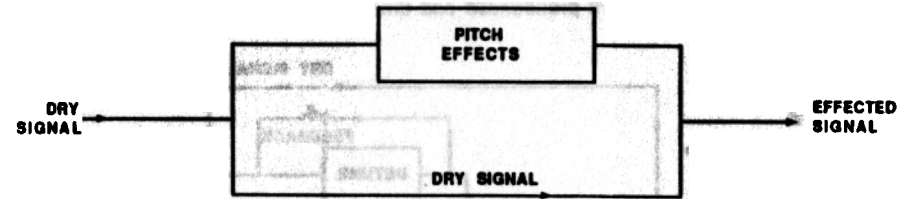

So that you can better understand the differences between all of the Pitch effects, and therefore better apply them to your music, here is a brief explanation of each.

CHORUS

The Chorus effect is achieved by taking part of the signal, slightly delaying it, and then slightly detuning it as well. The detuning is further effected by being modulated by a Low Frequency Oscillator (LFO) which causes the detuning to vary by a set amount. Many variables are available in this scheme. The LFO depth can be varied, the LFO speed can be varied, and a portion of the detuned signal can be fed back to the input to increase the effect. Finally, the waveshape of the LFO can be changed from a smooth triangle, to a more abrupt squarewave to make the pitch detuning more pronounced. *SEE FIGURE 8*

FIGURE 8

MONO CHORUS

Simplified Block Diagram

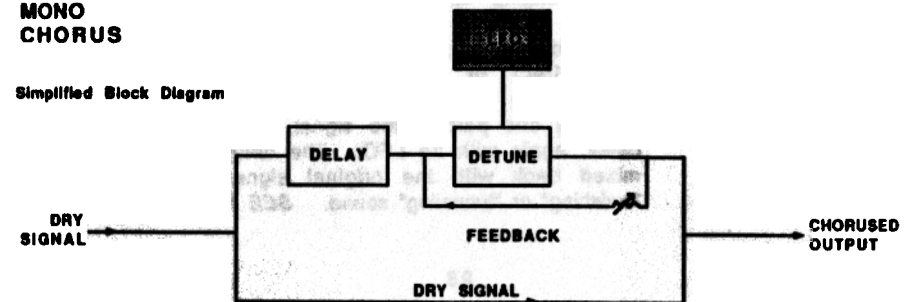

In the case of a Stereo Chorus, the signal is split into three parts with a dry signal and a separate Detuning section for both left and right channels. When the left channel is detuned sharp, the right is detuned flat, and vice versa. Once again, this causes the effect to become more pronounced and dramatic. *SEE FIGURE 9*

FIGURE 9

STEREO CHORUS
Simplified Block Diagram

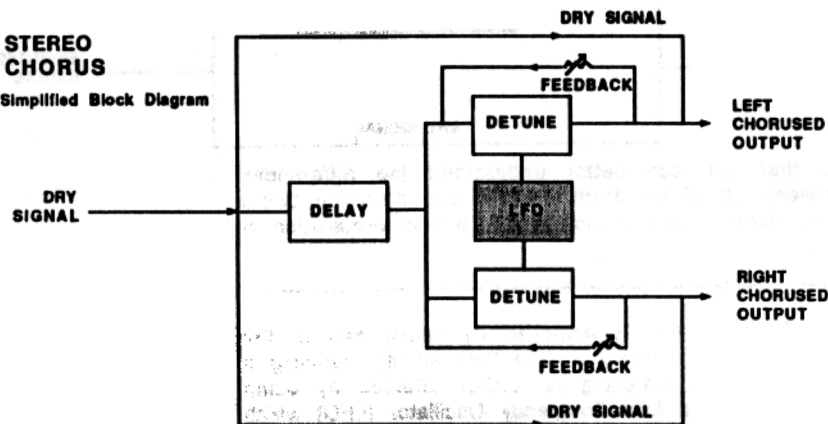

FLANGING

First used in the sixties, "Flanging" was achieved by the use of two tape recorders that would record and play back the same program in synchronization. By alternately slowing down one tape machine, and then the other, different phase cancellations would occur. Since the slowing down of the tape machines was done by hand pressure against the flanges of the tape supply reels, the term "Flanging" came into being.

Today, Flanging can be closely simulated by many outboard effects processors such as the *QuadraVerb*. The effect of Flanging, either electronically or mechanically done, is achieved by splitting and slightly delaying one part of the signal, then varying the time delay, again with an LFO. The delayed signal is then mixed back with the original signal to produce the "swishing" or "tunneling" sound. *SEE FIGURE 10*

EDITING THE PITCH STEREO SEPARATION

In this configuration, depressing the PITCH button will cause the display to read:

LEZLIE STEREO
SEPARATION: 80

Pressing the VALUE button will cause the display to increment or decrement. The Lezlie Stereo Separation page determines the spread of bass and treble across the stereo image.

LEZLIE MOTOR CONTR

Pressing the up PAGE button will cause the display to read:

LEZLIE MOTOR
CONTROL: OFF

Pressing the VALUE button will cause the display to read:

LEZLIE MOTOR
CONTROL: ON

The Lezlie Motor Control page selects a simulation of a Lezlie speaker system with its spinning rotor speakers turned off or on. When turned off, the rotors will seem gradually slow to a stop. When turned on, the rotors will gradually speed up.

LEZLIE SPEED

Pressing the up PAGE button will cause the display to read:

LEZLIE SPEED:
SLOW

Pressing the VALUE button will cause the display to read:

LEZLIE SPEED:
FAST

This page simulates the two rotating speeds of the Lezlie speaker.

REVERB INPUT 2

Pressing the "up" PAGE button will display the next page which will read:

REVERB INPUT 2:
LEZLIE OUTPUT

Pressing the VALUE button causes a new selection, which reads:

REVERB INPUT 2:
DELAY OUTPUT

This page selects the signal either from the output of the Lezlie simulator or from the Delay section of the *QuadraVerb*.

All other Reverb pages remain the same as in QuadMode™.

EDITING THE DELAY

All Delay pages remain the same as in QuadMode™ with the exception of the Delay Input Mix page, which is accessed after the Delay Type page and reads:

DELAY INPUT MIX:
IN < 00 > LEZLIE

This page provides a balance between the dry input signal and the Lezlie input signal to the Delay. The balance can be adjusted by pressing/holding either VALUE button. Either of the following displays will appear when the balance is adjusted fully to one source or the other:

DELAY INPUT MIX:
IN < 99 LEZLIE

DELAY INPUT MIX:
IN 99 > LEZLIE

All other Delay pages remain the same as in QuadMode™

FIGURE 10

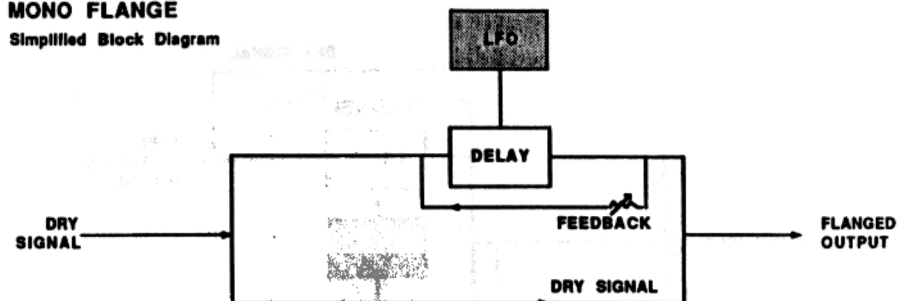
MONO FLANGE
 Simplified Block Diagram

Many variables are available, from varying the speed and depth of the LFO to feeding back part of the signal to make the effect stronger.

It is also possible to "trigger" the flange. This means that the delay time is reset to zero whenever the input signal passes a certain volume threshold. Triggering always starts the oscillator at the top of its cycle and produces a deep super flange controlled by the level of the input signal.

In the case of a Stereo Flange, the signal is split into three parts with a dry signal and a separate Delay section for both left and right channels with one channel flanging up while the other channel flanges down. Once again, this causes the effect to become more pronounced and dramatic. *SEE FIGURE 11*

FIGURE 11

STEREO
FLANGE

Simplified Block Diagram

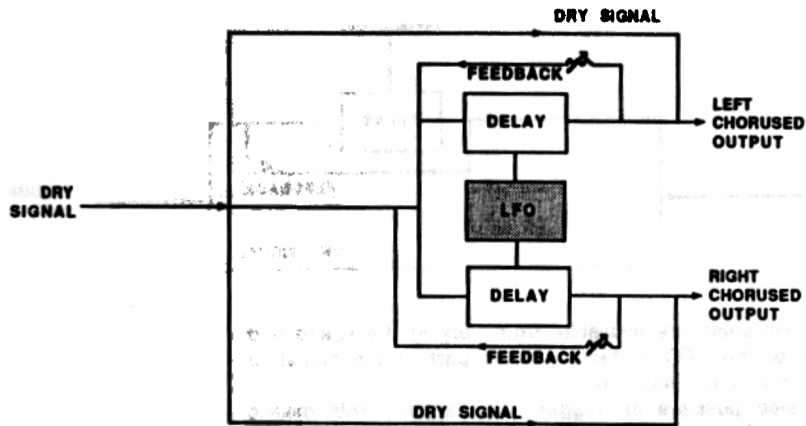

PITCH DETUNE

As the name implies, Pitch Detune takes a part of the signal and detunes it either sharp or flat. When mixed back with the original dry signal, the popular "12 string" effect is produced. SEE FIGURE 12

There are a total of 8 Mod Sources and Targets available on the *QuadraVerb*, which can be selected by further scrolling of the PAGE and VALUE buttons as in the examples above.

LEZLIE>DELAY>REVERB

Pressing the CONFIG button, then the up VALUE button selects the next configuration which reads:

CONFIGURATION:
LEZLIE >DL >REVERB

This configuration is a Leslie speaker (a rotating speaker usually used with Hammond Organs) simulator and causes some of the effects pages to display differently from the QuadMode™ Configuration.

EDITING THE REVERB

In this configuration, all Reverb pages will be displayed the same as in QuadMode™ except for the Reverb Input 1 and Reverb Input 2 pages. (see *Editing the Reverb, QuadMode™ Configuration*)

REVERB INPUT 1

After pressing the "up" PAGE button (after the Reverb Type page) the display will read one of the following choices:

REVERB INPUT 1:
PRE-LEZLIE

REVERB INPUT 1:
LEZLIE OUTPUT

REVERB INPUT 1
DELAY MIX INPUT

This page makes it possible to send either the pre-Lezlie signal, the signal from the Lezlie simulator, or the Delay Mix Input to Reverb Input 1. Pressing the VALUE button will make the selection.

SECTION 5

MOD 1 TARGET: REVERB INPUT MIX	MOD 1 TARGET: REVERB PREDELAY	MOD 1 TARGET: REV PREDELAY MIX	MOD 1 TARGET: REVERB DECAY
MOD 1 TARGET: REVERB DIFFUSION	MOD 1 TARGET: REVERB DENSITY	MOD 1 TARGET: REVERB LOW DECAY	MOD 1 TARGET: REVERB HI DECAY
MOD 1 TARGET: REVERB INPUT MIX	MOD 1 TARGET: DELAY TIME	MOD 1 TARGET: DELAY FEEDBACK	MOD 1 TARGET: LFO SPEED
MOD 1 TARGET: LFO DEPTH	MOD 1 TARGET: PITCH FEEDBACK	MOD 1 TARGET: LO EQ FREQUENCY	MOD 1 TARGET: LO EQ BOOST/CUT
MOD 1 TARGET: MID EQ FREQUENCY	MOD 1 TARGET: MID EQ BANDWIDTH	MOD 1 TARGET: MID EQ BOOST/CUT	MOD 1 TARGET: HI EQ FREQUENCY
MOD 1 TARGET: HI EQ BOOST/CUT	MOD 1 TARGET: DIRECT MIX LEVEL	MOD 1 TARGET: EFFECT MIX LEVEL	MOD 1 TARGET: PITCH MIX LEVEL
MOD 1 TARGET: DELAY MIX LEVEL	MOD 1 TARGET: REVERB MIX LEVEL		

MOD AMPLITUDE

Pressing the PAGE up button once again takes us to the next page which reads:

MOD 1 AMPLITUDE:
+00

The Mod Amplitude is the amount that the Target parameter will be affected by the Mod Source. Pressing/holding the VALUE button will cause the Mod 1 Amplitude to increment or decrement.

MOD 2 through 8

Pressing the PAGE button again takes us to the next page which reads:

MOD 2 SOURCE:
PITCH BEND

THEORY OF OPERATION

FIGURE 12

PITCH DETUNE
Simplified Block Diagram

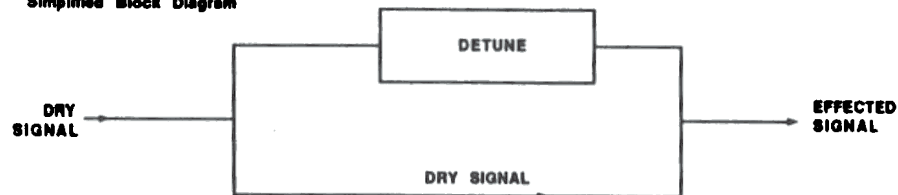

PHASE SHIFTER

Another popular effect is the Phase Shifter. Although similar in sound to Flanging, this effect is produced differently. Again, part of the signal is split from the original signal. The Phase Shifter shifts the phase of different frequencies in different amounts, resulting in a comb filter effect when combined with the dry signal. SEE FIGURE 13

FIGURE 13

PHASE SHIFTER
Simplified Block Diagram

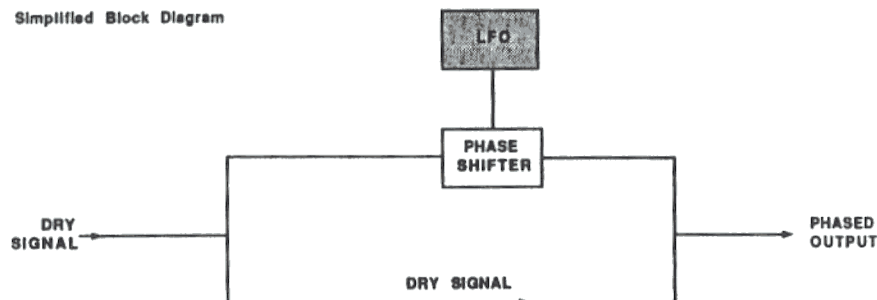

PITCH PARAMETERS

PITCH INPUT

Selects the input to the Pitch section from either before or after the EQ section.

LFO WAVESHape

This parameter only appears when the Mono or Stereo Chorus types are selected. The Waveshape of the Low Frequency Oscillator (LFO) can be changed from a triangle waveform, which provides a smoother, more even sound, to a squarewave, which makes the Chorus effect more pronounced.

LFO SPEED

The LFO Speed of all Pitch effects except Detuning can be adjusted to produce the desired effect.

LFO DEPTH

The LFO Depth, which is the amount of pitch alteration, can be adjusted to produce the desired effect. It is not available when the Detune type is selected.

PITCH FEEDBACK

A portion of the output of the Pitch section can be "fed back" into the input in order to make the effect more tonal or pronounced. This parameter is not available in the Pitch Detune or Phase Shifter mode.

TRIGGER FLANGE

This parameter selects the triggering function, which means that the Flange resets to the top of its modulation cycle whenever an input signal exceeds a preset threshold. This page appears only when Mono or Stereo Flange is selected.

DETUNE AMOUNT

This parameter controls the amount of Detuning performed by the *QuadraVerb*. A negative number means the the Detuning is flat; a positive number means that the Detuning is sharp.

on a synthesizer or other MIDI device. This is extremely useful when dynamic or real-time control is required in a live playing situation. *It is possible to control up to 8 parameters simultaneously from 1 to 8 MIDI controllers.*

MOD SOURCE

To adjust the MOD parameters, first press the MOD button. The display will indicate:

MOD 1 SOURCE:
PITCH BEND

Pressing the VALUE buttons will access the other possible sources. They will be displayed as:

MOD 1 SOURCE:
AFTER TOUCH

MOD 1 SOURCE:
NOTE NUMBER

MOD 1 SOURCE:
NOTE VELOCITY

MOD 1 SOURCE:
CONTROLLER 000

MOD TARGET

Pressing the PAGE button once again takes us to the next page which reads:

MOD 1 TARGET:
REVERB MIX LEVEL

The MOD 1 TARGET is the desired parameter that will be controlled by the selected MOD 1 SOURCE. Other targets can also be selected by pressing the VALUE button until the desired parameter is displayed. The possible target parameters are as follows:

PITCH OUTPUT LEVEL

Pressing the PAGE button once again takes us to the next page which reads:

PITCH OUTPUT
LEVEL: +50

Pressing/holding the VALUE button will cause the Pitch Output Level to increment or decrement. The Pitch Output Level is the level for the Pitch Section of the *QuadraVerb* and should be set as desired.

DELAY OUTPUT LEVEL

Pressing the PAGE button again takes us to the next page which reads:

DELAY OUTPUT
LEVEL: +50

Pressing/holding the VALUE button will cause the Delay Output Level to increment or decrement. The Delay Output Level is the level for the Delay Section of the *QuadraVerb* and should be set as desired.

REVERB OUTPUT LEVEL

Pressing the PAGE button once again takes us to the next page which reads:

REVERB OUTPUT
LEVEL: +99

Pressing/holding the VALUE button will cause the Reverb Output Level to increment or decrement. The Reverb Output Level is the level for the Reverb Section of the *QuadraVerb* and should be set as desired.

MODULATING THE PARAMETERS

The MOB button lets you control various *QuadraVerb* parameters from a MIDI controller such as the pitchwheel, aftertouch, or any other desired controller

LEZLIE STEREO SEPARATION

In the Lezlie Configuration, the Pitch section will display a different set of parameters, which are those of the Lezlie speaker simulator. (See the *Lezlie Configuration* for more information). The Lezlie Stereo Separation page determines the spread of bass and treble across the stereo image.

LEZLIE MOTOR CONTROL

The Lezlie Motor Control page selects a simulation of a Lezlie speaker system with its spinning rotor speakers turned off or on.

LEZLIE SPEED

The Lezlie Speed parameter page selects a simulation of the two rotating speeds of the Lezlie speaker.

THE EQ

The EQ section of the *QuadraVerb* provides a choice of 3 different types of EQ, which is selected by the configuration.

Equalization, or EQ, is the ability to control the harmonic balance, or timbre, of an instrument, and can be used to compensate for frequency deficiencies in either microphones or sound equipment. There are three different categories of equalizers, all of which you are probably familiar with.

The most common type of equalizer is the *Shelving* type. This is the simple bass and/or treble control normally found on stereo systems, guitar amplifiers, and the like. These are called shelving because the maximum boost or cut is at its maximum (usually 100hz for the bass and 10Khz for treble) and maintains this maximum amplitude "shelf" or plateau on all frequencies from this point (called the "turnover") to beyond the range of audibility. The frequencies below the turnover point of the shelf are also affected, but less and less so the further away from the turnover point. See *Figure 14*

FIGURE 14

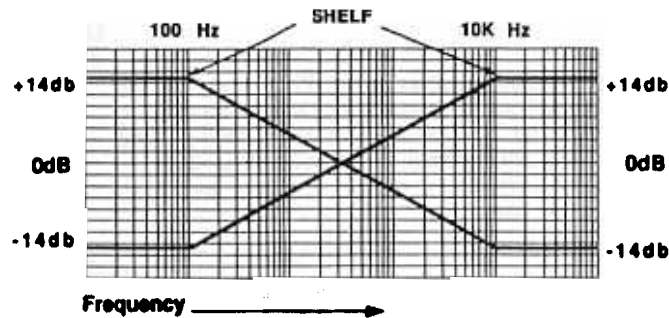

The second type of equalizer is the *Graphic Equalizer* which most people have seen on sound systems, some home stereos, and many guitar type amplifiers. This device gets its name from the fact that the control settings actually form a graph of the frequency spectrum. While shelving equalizers work on broad sections of the frequency bandwidth, a graphic equalizer is slightly more sophisticated than the Shelving equalizer as it divides the frequency spectrum into sections called bands. See Figure 15

FIGURE 15

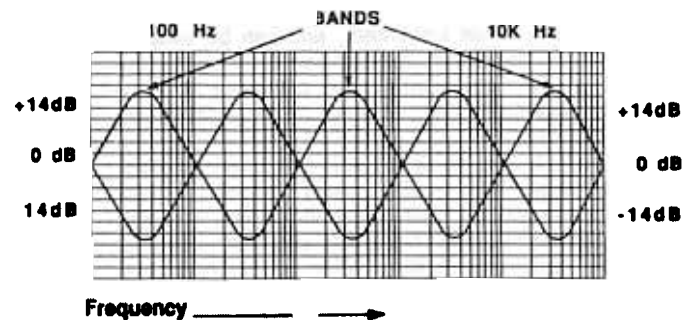

The Direct Signal Level is how much of the dry, unaffected signal that will appear at the output of the *QuadraVerb*. When used in applications where an instrument is connected directly into the *QuadraVerb*, the Direct Signal Level should be set at +50. When used with a mixing console as an outboard effect, the Direct Signal Level should be set to +00.

MASTER EFFECTS LEVELS

Pressing the PAGE button once again takes us to the next page which reads:

MASTER EFFECTS
LEVEL: +50

Pressing/holding the VALUE button will cause the Master Effects Level to increment or decrement.

The Master Effects Level is the overall master level of all the effects that will appear at the output of the *QuadraVerb*. When used in applications where an instrument is connected directly into the *QuadraVerb*, the Master Effects Level should be set at as desired. When used with a mixing console as an outboard effect, the Master Effects Level should be set to +50.

EQ OUTPUT LEVEL

If the "Post" option of the Direct Signal Select page is chosen, the EQ Section of the *QuadraVerb* is switched into the signal path of the direct signal for use if desired.

Pressing the PAGE button once again takes us to the next page which reads:

EQ OUTPUT
LEVEL: +50

Pressing/holding the VALUE button will cause the EQ Output Level to increment or decrement. This page will not appear if the Direct Signal Select page is in the "Pre" position.

HI EQ AMPLITUDE

Pressing the PAGE button displays the next page, which reads:

HI EQ AMPLITUDE
+00.00dB

The Hi Eq Amplitude can now be changed in .05dB increments to the desired level by pressing/holding the VALUE button.

EDITING THE MIX LEVELS

The MIX button accesses the various pages that allow mixing the signal levels of not only the effects, but the dry signal as well.

DIRECT SIGNAL SELECT

When the MIX button is first depressed, the first page to appear will read either:

DIRECT SIGNAL
SELECT: PRE-EQ

or

DIRECT SIGNAL
SELECT: POST-EQ

Pressing the VALUE button will toggle between these two options. By choosing the "Pre" option, the EQ Section of the *QuadraVerb* will not be heard directly, but can still be routed to other effects.

DIRECT SIGNAL LEVEL

By pressing the PAGE button again, the next page will be displayed. This will be the Direct Signal Level page, and will only read when the Pre-EQ selection of the Direct Signal Select has been chosen. The display will read:

DIRECT SIGNAL
LEVEL: +50

Pressing/holding the VALUE button will cause the Direct Signal Level to increment or decrement.

The number of frequencies acted upon in each band is called the *bandwidth*. This *bandwidth* is normally measured in musical octaves, so on a simple graphic equalizer containing only 5 bands, each band would have a 2 octave bandwidth, and a more sophisticated graphic equalizer with 31 bands would have a 1/3rd octave equalizer.

Generally speaking, a 1/3rd octave equalizer is normally used for room tuning and feedback control while a 1 or 2 octave equalizer is used for normal tonal shaping. See *Figure 16*

FIGURE 16

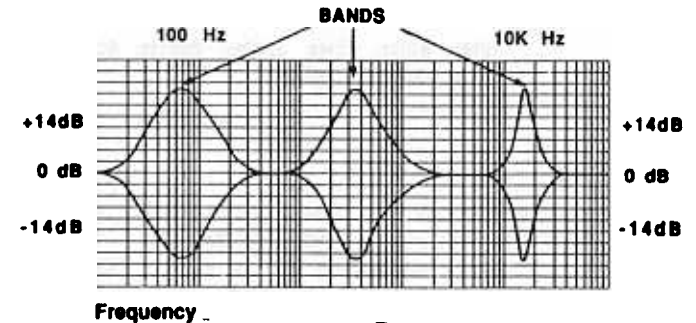

By far the most versatile equalizer is the *parametric* type. While the graphic EQ always has a bandwidth that is fixed, the parametric allows for the bandwidth to be varied. This means that far fewer equalizer sections are required for either tonal shaping or feedback suppression since the exact offending frequencies can be dialed in.

EQ TYPES IN THE *QuadraVerb***3 BAND PARAMETRIC**

The 3 Band Parametric EQ is selected in the QuadMode™ and the 3 BAND EQ>REVERB Configurations. In this equalizer setup, the high and low bands are shelving type equalizers, while the mid band is fully parametric with not only the frequency but bandwidth fully adjustable.

This setup provides the best of both worlds of a shelving and parametric EQ in terms of sound and ease of use.

5 BAND PARAMETRIC

The 5 Band Parametric EQ is selected in the 5 BAND>PITCH>DELAY Configuration. In this equalizer setup, the high and low bands are shelving type equalizers, while the 3 mid bands are fully parametric with not only the frequency but bandwidth fully adjustable. As with the 3 Band EQ, this setup provides the best of both worlds of a shelving and parametric EQ in terms of sound and ease of use.

11 BAND GRAPHIC

The 11 Band Graphic EQ is available in the GRAPHIC EQ>DELAY Configuration. The display resembles the actual frequency graph the same as a graphic equalizer. The octaves that are displayed are:

16Hz, 32Hz, 62Hz, 126Hz, 250Hz, 500Hz, 1KHz, 2KHz, 4KHz, 8KHz, and 16KHz

EQ PARAMETERS

LOW EQ FREQUENCY, LOW MID FREQUENCY, MID FREQUENCY, HIGH MID FREQUENCY, HIGH FREQUENCY

These parameters will change the EQ frequency in their related bands in 1Hz steps.

LOW EQ AMPLITUDE, LOW MID AMPLITUDE, MID AMPLITUDE, HIGH MID AMPLITUDE, HIGH AMPLITUDE

These parameters will change the EQ amplitude of the displayed frequency in their related bands in .05dB steps.

LOW MID BANDWIDTH, MID BANDWIDTH, HIGH MID BANDWIDTH

These parameters will change the EQ Bandwidth at the displayed frequency of their related bands in .01 octave steps.

The Low Eq Amplitude can now be changed in .05dB increments to the desired level by pressing/holding the VALUE button.

MID EQ FREQUENCY

Pressing the PAGE button displays the next page, which reads:

MID EQ FREQUENCY
2000Hz

The Frequency can now be changed in 1Hz increments to the one desired by pressing/holding the VALUE button.

MID EQ BANDWIDTH

Pressing the PAGE button displays the next page which reads:

MID EQ BANDWIDTH
1.00 OCTAVES

The Mid Eq Bandwidth can now be changed in .01 octave increments to the one desired by pressing/holding the VALUE button.

MID EQ AMPLITUDE

The next page that is displayed is shown as:

MID EQ AMPLITUDE
+00.00dB

The Mid Eq Amplitude can now be changed in .05dB increments to the desired level by pressing/holding the VALUE button.

HI EQ FREQUENCY

Pressing the PAGE button displays the next page, which reads:

HI EQ FREQUENCY
08000Hz

The Frequency can now be changed in 1Hz increments to the one desired by pressing/holding the VALUE button.

DETUNE AMOUNT

This page allows for an equalized signal to be sent to the Pitch section if desired. Pressing the VALUE button will toggle between the two choices.

Pressing the PAGE button once again will access the next page which will be displayed as:

DETUNE AMOUNT:
+05

The Detune Mode allows for the signal to be detuned either up or down in order to obtain a different type of chorus effect. This will cause the sound to "thicken" somewhat if used judiciously. Pressing the VALUE button will cause the Detune Amount to increment or decrement.

EDITING THE PHASE SHIFTER

The Phase Shifter Mode has identical pages to the Chorus Modes except that LFO Waveshape, and Pitch Feedback are omitted. (See Mono and Stereo Chorus).

EDITING THE EQ

LOW EQ FREQUENCY

The EQ button allows access to the 3 band parametric EQ in the QuadMode™ Configuration. The first page displayed reads:

LOW EQ FREQUENCY
200Hz

The Frequency can now be changed in 1Hz increments to the one desired by pressing/holding the VALUE button.

LOW EQ AMPLITUDE

Pressing the PAGE button displays the next page, which reads:

LOW EQ AMPLITUDE
+00.00dB

GRAPHIC

This parameter resembles the actual frequency graph the same as a graphic equalizer. The octaves that are adjustable are:

16Hz, 32Hz, 62Hz, 126Hz, 250Hz, 500Hz, 1KHz, 2KHz, 4KHz, 8KHz, and 16KHz

HIGH ROTOR LEVEL

This parameter is only available in the Leslie Configuration. A Leslie speaker system has two rotating rotor speakers. Sometimes it is desirable to adjust High (treble) Rotor Level. The range of adjustment is -20 to +6dB.

THE MIX SECTION

The *QuadraVerb* has an on-board digital mixer which allows all of the Effects to be mixed together into either a mono or stereo output. What's more, all signal levels of the Mix section are memorized and stored with the program. Below is a simple block diagram of the Mix section. SEE FIGURE 17

FIGURE 17

QuadraVerb MIX SECTION

Simplified Block Diagram

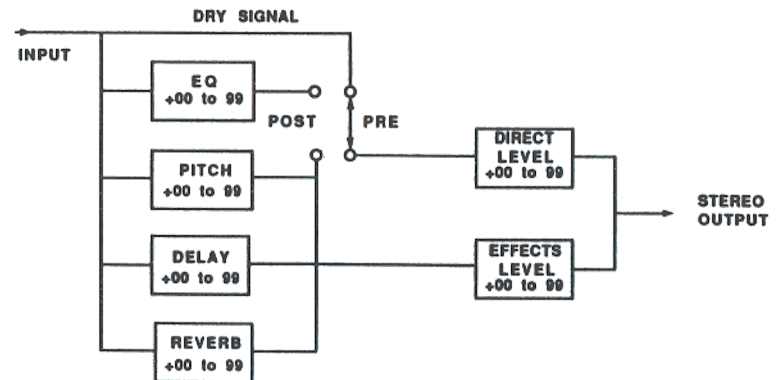

MIX PARAMETERS
DIRECT SIGNAL SELECT

This parameter selects whether the Direct Signal will be taken from before the EQ or after the EQ.

DIRECT SIGNAL LEVEL

This parameter is only available if the Direct Signal Select is in the "Pre" position. When the Direct Signal is switched to "Post" EQ, then the Direct Signal Level is adjusted on the EQ Output Level page.

MASTER EFFECTS LEVEL

The Master Effects Level adjusts the overall level of all of the Effects.

EQ OUTPUT LEVEL

The EQ Output Level adjusts the output level of the EQ section.

PITCH OUTPUT LEVEL

The Pitch Output Level adjusts the output level of the Pitch section.

DELAY OUTPUT LEVEL

The Delay Output Level adjusts the output level of the Delay section.

REVERB OUTPUT LEVEL

The Reverb Output Level adjusts the output level of the Reverb section.

LEZLIE OUTPUT LEVEL

Available in only the Leslie Configuration, the Leslie Output Level adjusts the level of the Leslie simulation.

MODULATING QuadraVerb's PARAMETERS

The mod section lets you control various *QuadraVerb* parameters from a MIDI controller such as the pitchwheel, aftertouch, or any other desired controller on a synthesizer or other MIDI device. This is extremely

EDITING THE MONO and STEREO FLANGE

The Mono and Stereo Flange Modes have identical pages to the Chorus Modes except that LFO Waveshape is omitted and the Trigger Flange page is added (See *Mono and Stereo Chorus*).

TRIGGER FLANGE

The last page after Pitch Feedback will read either:

TRIGGER FLANGE:
ON

or

TRIGGER FLANGE:
OFF

Pressing the VALUE buttons will select the Trigger Flange either On or Off.

PLEASE NOTE:

Triggered flanges lend themselves most readily to instruments with a sharp leading edge to their attack, like cymbal crashes or continuous percussive playing from drum kits or rhythm instruments (percussive electric rhythm guitar included). Instruments with a smooth, continuous decay (such as keyboards or lightly strummed guitar) might retrigger the flange during the sustain portion of their sound. This interrupts the smooth flow of sound and might cause a thumping or popping effect.

A SPECIAL NOTE ON FLANGING:

In order to hear the deepest flange effect, you must adjust the ratio of dry to effected signal to *50% dry and 50% effect*.

**EDITING THE PITCH DETUNE
PITCH INPUT**

The first page of the Pitch Detune Mode is the Pitch Input page. This is accessed by pressing the PAGE button, which will read either:

PITCH INPUT:
PRE-EQ

PITCH INPUT:
POST-EQ

Pressing the VALUE button will toggle between the two choices. *The Triangle Waveshape will sound smoother and less imposing while the Square Waveshape will be more dramatic.*

LFO SPEED

Pressing the PAGE button once again will access the next page which will be displayed as:

LFO SPEED:
20

Pressing the VALUE button will cause the speed to increment or decrement. Slower speeds are usually desired, but higher speeds can be used for great effect.

LFO DEPTH

The next page accessed in this mode is LFO Depth and will be displayed as:

LFO DEPTH:
50

Pressing the VALUE button will cause the LFO Depth to increment or decrement. LFO Depth will control how much the signal will be detuned. Shallow depths are subtle while bigger depths are more dramatic. *A good rule of thumb for set-up is: The higher the LFO Depth; the lower the LFO Speed.*

PITCH FEEDBACK

Pressing the PAGE button once again will access the last page which will be displayed as:

PITCH FEEDBACK:
00%

Pressing the VALUE button will cause the feedback to increment or decrement. Feedback will cause the effect to be much more obvious and tonal.

useful when dynamic or real-time control is required in a live playing situation. *It is possible to control up to 8 parameters simultaneously from 1 to 8 MIDI controllers. All mod assignments can be stored to their programs.*

MOD PARAMETERS**MOD SOURCE**

The Mod Source parameter selects the MIDI controller which will remotely cause a change (modulate) in one or several of the parameters of the *QuadraVerb*. Nearly every MIDI controller can become a Mod Source, with the most common controllers appearing as a direct option in the display. The options for the Mod Source are:

PITCH BEND - The pitch bend wheel or lever common on most synthesizers.

AFTER TOUCH - After a note is depressed, pressure on the key will cause a MIDI command. This ability is not available on all keyboards.

NOTE NUMBER - Any MIDI note from keyboard, sequencer, or drum machine.

NOTE VELOCITY - The target parameter will change in relation to how hard a key is struck.

CONTROLLER #XXX There can be anywhere from 0 to 127 MIDI controllers, any of which can be assigned as a Mod Source. For example, #1 would be a modulation wheel on a synthesizer while #64 would be the sustain pedal. *(See Controller Number Chart in Appendix)*

MOD TARGET

The MOD 1 TARGET is the desired parameter that will be controlled by the selected MOD 1 SOURCE. Other targets can also be selected by pressing the VALUE button until the desired parameter is displayed. The possible target parameters in the QuadMode™ Configuration are as follows:

Reverb Input Mix	Reverb PreDelay	Reverb PreDelay Mix
Reverb Decay	Reverb Diffusion	Reverb Density
Reverb Low Decay	Reverb High Decay	Delay Input Mix
Delay Time	Delay Feedback	LFO Speed
LFO Depth	Pitch Feedback	Low EQ Frequency
Low EQ Amplitude	Mid EQ Frequency	Mid EQ Bandwidth
Mid EQ Amplitude	Hi EQ Frequency	Hi EQ Amplitude
Direct Mix Level	Effect Mix Level	EQ Mix Level
Pitch Mix Level	Delay Mix Level	Reverb Mix Level

In addition to many of the above targets, the following parameters are available in the Leslie Configuration:

Leslie Stereo	Leslie Motor	Leslie Speed
Leslie Hi Level	Leslie Mix Level	

In addition to many of the targets available in QuadMode™ Configuration, the following parameters are available in the Graphic Configuration:

16Hz Boost/Cut	32Hz Boost/Cut	62Hz Boost/Cut
128Hz Boost/Cut	250Hz Boost/Cut	500Hz Boost/Cut
1KHz Boost/Cut	2KHz Boost/Cut	4KHz Boost/Cut
8KHz Boost/Cut	16KHz Boost/Cut	

In addition to many of the targets available in QuadMode™ Configuration, the following parameters are available in the 5 Band Configuration:

Low Mid EQ Frequency	Low Mid EQ Bandwidth	Low Mid EQ Amplitude
High Mid EQ Frequency	High Mid EQ Bandwidth	High Mid EQ Amplitude

PITCH MODE:
STEREO FLANGE

PITCH MODE:
PITCH DETUNE

PITCH MODE:
PHASE SHIFTER

Since each of these Pitch Modes have a few parameters that are not common to the other modes, we will discuss each mode individually. (Also see Section 4)

EDITING MONO CHORUS and STEREO CHORUS

PITCH INPUT

The first page of either the Mono or Stereo Chorus Mode is the Pitch Input page. This is accessed by pressing the PAGE button, which will read either:

PITCH INPUT:
PRE-EQ

PITCH INPUT:
POST-EQ

This page allows an for an equalized signal to be sent to the Pitch Section if desired. Pressing the VALUE button will toggle between the two choices.

LFO WAVESHAP

Pressing the PAGE button once again will access the next page which will be displayed as:

LFO WAVESHAP:
TRIANGLE

LFO WAVESHAP:
SQUARE

LEFT DELAY TIME:
300 milliseconds

DELAY FEEDBACK
LEFT: 40%

The two additional pages will be for the Right Delay Time and Delay Feedback and will read:

RIGHT DELAY TIME:
300 milliseconds

DELAY FEEDBACK
RIGHT: 40%

Once again, by pressing either VALUE button, the amount of either Delay Time or Delay Feedback can be selected as desired.

EDITING PITCH

PITCH MODES

In order to access the various Pitch Modes, press the PITCH button. The display will read:

PITCH MODE:
STEREO CHORUS

By pressing the VALUE buttons, the other modes can be accessed. These will be shown as:

PITCH MODE:
MONO CHORUS

PITCH MODE:
MONO FLANGE

MOD AMPLITUDE

The Mod Amplitude is the amount that the Target parameter will be affected by the Mod Source. It can be adjusted to affect the Target parameter by a positive or negative amount. In other words, if the Reverb Decay was selected as the Target with the pitch wheel of a keyboard as the Source, the pitch wheel could be programmed to cause the Reverb to increase the decay (positive) or decrease its decay (negative).

QuadraVerb's MIDI SECTION

The MIDI button accesses the various MIDI parameters of *QuadraVerb*. The MIDI functions are global functions and are not stored with an individual program.

MIDI PARAMETERS

MIDI CHANNEL

The *QuadraVerb* can receive MIDI information on channels 1 through 16, or Omni mode. Omni mode responds to MIDI commands received on all channels simultaneously, and transmits on channel 1.

MIDI PROGRAM CHANGE

The MIDI Program Change page allows the *QuadraVerb* to change programs remotely by a MIDI Program Change command if the "ON" option is selected. The *QuadraVerb* will also send Program Change commands when programs are selected from the front panel.

PROGRAM TABLE

If the "TABLE" option is selected, the *QuadraVerb* transposes the program numbers of a MIDI controller (a synthesizer, for instance) to match those of the *QuadraVerb*. To set the parameters of the Program Table, MIDI Program Change must be set to TABLE.

The value of the Program Table is that it makes it possible to transpose any MIDI controller program numbers to select the desired *QuadraVerb* program numbers for easy program changes. Also, because *QuadraVerb* has 100 program locations, but there are 127 MIDI program change numbers, the Program Table makes it possible to make use of all 127 program change numbers. For example, if the following program changes were desired:

- MIDI Controller Program 101 = *QuadraVerb* Program 33
- MIDI Controller Program 102 = *QuadraVerb* Program 39
- MIDI Controller Program 103 = *QuadraVerb* Program 25

Selecting program 101 on the MIDI controller would result in program 33 of the *QuadraVerb* being accessed, selecting program 102 would result in program 39 of the *QuadraVerb* being accessed, and selecting program 103 would result in program 25 of the *QuadraVerb* being accessed.

MIDI THRU

MIDI Thru means that any MIDI information received by *QuadraVerb* (with the exception of System Exclusive data) will be re-transmitted back out the MIDI THRU/OUT jack.

SYSTEM EXCLUSIVE

System Exclusive is a distinct software protocol specific to the *QuadraVerb*. This makes it possible to do such things as MIDI Data Dumps and retrievals, and communication via external computer.

SEND MIDI PROGRAM

Send MIDI Program makes it possible to save either a single or all *QuadraVerb* programs externally to a MIDI storage device, or swap programs with another *QuadraVerb*.

DELAY TIME

Press the PAGE button. The next page is the Delay Time page. By pressing/holding the VALUE buttons, the Delay Time can be precisely adjusted in 1 millisecond increments. The display will read:

DELAY TIME:
300 milliseconds

DELAY FEEDBACK

Press the PAGE button. The next page is the Delay Feedback page. Delay Feedback means that a portion of the delay signal output is "fed back" into the input. This results in the delay repeating itself. The more feedback, the more repeats. The display will read:

DELAY FEEDBACK:
40%

Below is a chart of the approximate number of audible repeats and their corresponding Delay Feedback percentages:

DELAY FEEDBACK	REPEATS
0 to 4%	1
4 to 8%	2
9 to 18%	3
19 to 28%	4
29 to 34%	5
35 to 42%	6
43 to 54%	7
55%	8
66%	9
77%	10
88%	11
99%	Infinite Repeat

For the Stereo Delay type, there are two additional pages and the previous two pages, Delay Time and Delay Feedback are slightly different. In this case they will read:

DELAY INPUT 1

After the Delay Type is selected, the Delay settings may be adjusted. These are accessed by pressing the PAGE button. The first page will read either of the following, depending on the program selected:

DELAY INPUT 1:
POST EQ

DELAY INPUT 1:
PRE-EQ

This means that the signal sent to Input 1 of the Delay section may be taken either from the output of the EQ section, if an equalized signal is desired, or from before the equalizer.

By pressing either VALUE button will select one of the two selections.

DELAY INPUT MIX

The next page is the Delay Input Mix which is displayed as:

DELAY INPUT MIX:
1 < 00 > PITCH

This page allows a mixed signal from either the output of the pitch section or the input of the previous page (Pre or Post EQ) to be applied to the input of the Delay section. This signal can be adjusted so that either the Pre/Post signal or the Pitch output signal only are fed to the input of the Delay section, or any balance of the two.

By pressing either VALUE button, the balance can be adjusted between inputs 1 and 2. The display will appear as follows if the input is adjusted fully to either Input 1 or Pitch output:

DELAY INPUT MIX:
1 99 > PITCH

DELAY INPUT MIX:
1 < 99 PITCH

PROGRAM ADVANCE
FOOTSWITCH RANGE

The Footswitch Range page selects the range of programs that the ADVANCE FOOTSWITCH on the back panel will affect. Therefore, if only a limited number of programs are to be used, for instance programs 49 through 53, the programs will continuously cycle from 49 to 53 whenever the ADVANCE FOOTSWITCH is triggered. If the range goes downward (i.e., 53 to 49), the footswitch will step backwards.

CONFIGURATIONS

At the heart of *QuadraVerb's* unique sophistication are its multiple configurations. A configuration is the order in which the internal digital Effects are placed. *QuadraVerb's* configurations are not just the placement of the Effects in simple series or parallel fashion, however. It is possible in each mode (configuration) to further adjust the signal path through a series of internal digital software switches and level controls. This allows many effects and sounds to become quickly and easily possible where previously it would have taken many expensive, external devices, lots of patching, and a few hours time to duplicate those same sounds.

QuadraVerb also has several special effect configurations, such as the Leslie and Graphic EQ, in which one or more of the internal Effects becomes substantially altered to perform a specialized application.

Let's look at the individual configurations more closely.

QuadMode™ (EQ>Pitch>Delay>Reverb)

The most sophisticated of the configurations, QuadMode™ allows all four effects to be used simultaneously in various signal flow combinations. What's more, each effect suffers no operational or sonic degradation, and is capable of full 20Hz to 20KHz bandwidth.

Configuration 1 QuadMode™ - EQ > PCH > DL > REVERB

USING QuadraVerb

SECTION 4

3 BAND PARAMETRIC EQ
 High 2k - 18k ± 14 dB
 Mid 200Hz - 10kHz ± 14dB
 Q - .2 octave to 2.55 octaves
 Low 20Hz - 1 kHz ± 14 dB

PITCH TYPES
 Stereo Chorus
 Mono Chorus
 Stereo Flange
 Mono Flange
 Phase Shifter
 Pitch Detune

DELAY TYPES
 Mono Delay - 800ms
 Stereo Delay - 400ms per side
 Ping-Pong Delay - 400ms

REVERB TYPES
 Plate 1
 Room 1
 Chamber 1
 Hall 1
 Gate 1
 Reverse 1

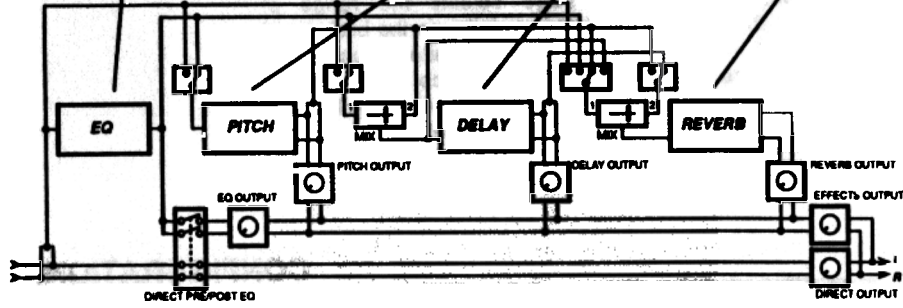

Lezlie → Delay → Reverb

This mode simulates the unique effect of the famous Leslie speaker system. This system uses 2 rotating speakers to produce a combination of both frequency and amplitude modulated sound. The Leslie speaker system is most often used with Hammond type organs, but is occasionally used for guitar amplification as well. This *QuadraVerb* configuration gives a close approximation of a miked Leslie cabinet in stereo, complete with 3 different speeds (Off, Slow, Fast) and variable stereo separation.

Configuration 2 - LEZLIE > DL > REVERB

LEZLIE PARAMETERS INCLUDE:

Stereo Separation
 Motor Control
 Leslie Speed
 High Rotor Level (Accessed as an EQ Parameter)

DELAY TYPES
 Mono Delay - 800ms
 Stereo Delay - 400ms per side
 Ping-Pong Delay - 400ms

REVERB TYPES
 Plate 1
 Room 1
 Chamber 1
 Hall 1
 Reverse 1

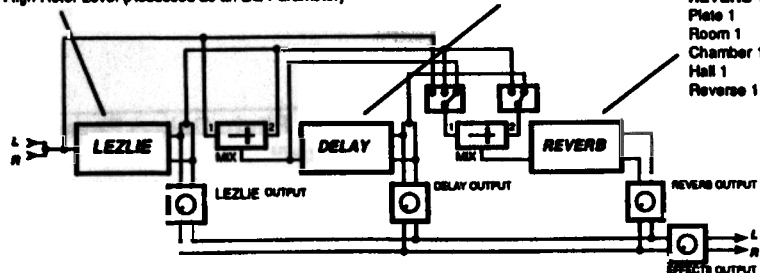

REVERB GATED LEVEL

Pressing the PAGE button again will display the last Reverb page which will read:

REVERB GATED
 LEVEL: 00%

Pressing the VALUE button will determine how low in level that the Reverb Gate falls to (see *THEORY OF OPERATION* for complete explanation).

EDITING THE DELAY

DELAY TYPES

The DELAY button allows access to the three Delay types as well as all of their parameters. The display will default to the following when the DELAY button is pressed:

DELAY TYPE:
 PING PONG DELAY

This is called a "Ping Pong Delay" because the output bounces from side to side (left to right) when in stereo with the speed determined by the delay time. *The maximum delay time is 400 milliseconds in the QuadMode™ Configuration.*

If the VALUE button is pressed, two additional delay types can be selected. They are:

DELAY TYPE:
 STEREO DELAY

DELAY TYPE:
 MONO DELAY

The Stereo Delay is actually two separate delays, which can be individually varied. *The maximum delay time for each delay is 400 milliseconds in the QuadMode™ Configuration. The Mono Delay has the advantage of twice the available delay time, or 800 milliseconds in the QuadMode™ Configuration.*

REVERB GATE

The Reverb Gate function will cause the reverb tail to be abruptly cut off by utilizing the software equivalent of a noise gate (see THEORY OF OPERATION for a complete explanation). Pressing the PAGE button will cause the display to read either of the following:

REVERB GATE:
OFF

REVERB GATE:
ON

Pressing the VALUE button will cause the Reverb Gate to toggle ON or OFF.

REVERB GATE HOLD

Pressing the PAGE button again will display the next page which will read:

REVERB GATE
HOLD TIME: 00

Pressing the VALUE button will select how long that the Reverb Gate stays open (see THEORY OF OPERATION for complete explanation).

REVERB GATE RELEASE

Pressing the PAGE button again will display the next page which will read:

REVERB GATE
RELEASE TIME: 00

Pressing the up or down VALUE buttons will select the length of time that it takes the Reverb Gate to close (see THEORY OF OPERATION for complete explanation).

Graphic EQ>Delay

Another specialized configuration, this mode combines an 11 band Graphic EQ with a full function Delay.

Configuration 3 - GRAPHIC EQ > DELAY

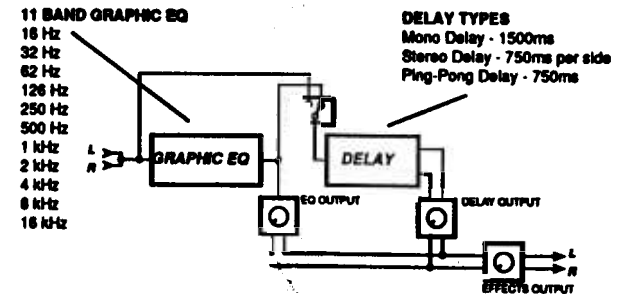

5 Band EQ>Pitch>Delay

Perfect for guitar players who need extra EQ facilities and no Reverb, this configuration utilizes a 5 Band Parametric EQ as well as the full function Pitch and Delay sections.

Configuration 4 - 5BAND EQ > PCH > DLY

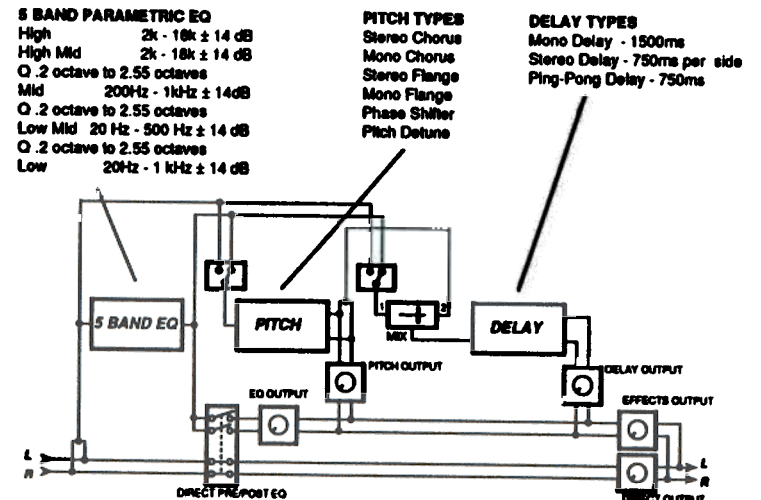

3 Band EQ>Reverb

This mode is the configuration of choice when Reverb is to be the primary effect. This is because the Reverb in this configuration takes advantage of the increased processing power available (since only two Effects are active) and operates in an enhanced mode.

Not only is the 3 Band Parametric EQ present for tonal shaping, but a Chorus function is also available in the Pitch section for additional Reverb effect.

Configuration 5 - EQ > REVERB

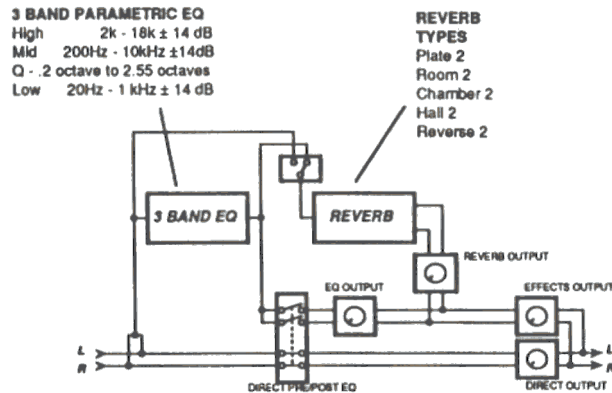

REVERB DENSITY

Some reverb types will include the Reverb Density page which will be displayed as follows:

REVERB DENSITY:
1

By pressing either VALUE button, the amount of Reverb Density can be selected as desired. (For more about these parameters and their effect on the reverb, refer to the Theory of Operation section.) The range is 1-9.

HI and LOW FREQUENCY DECAY

The following two pages allow you to set the decay time separately for both the low and high frequencies of the Reverb. The next page will read as follows:

LOW FREQUENCY
DECAY: -60

By pressing either VALUE button, the amount of Low Frequency Decay can be selected as desired. *The amount will always be in a negative direction since the overall decay time is selected by the Reverb Decay page.*

Pressing the PAGE button will cause the display to read:

HIGH FREQUENCY
DECAY: -40

By pressing either VALUE button, the amount of High Frequency Decay can be selected as desired. *The amount will always be in a negative direction since the overall decay time is selected by the Reverb Decay page.*

of the Pre-Delay is on the previous page) into the Reverb signal path. This gives you the ability to hear a bit of the Reverb before the loudest part of the Reverb (the Pre-Delayed Reverb) sounds. This makes for bigger and smoother sounding Reverb settings and is an exclusive feature of the *QuadraVerb*. The display will read as follows:

```
PREDELAY MIX:
PRE 80> POST
```

Once again, the balance can be adjusted with the use of either VALUE button. The displays will read as follows when either full Pre or full Post are selected:

```
PREDELAY MIX:
PRE <99 POST
```

```
PREDELAY MIX:
PRE 99> POST
```

REVERB DECAY

The next page is Reverb Decay. This will determine how long the Reverb will sound before it dies out. The display will show:

```
REVERB DECAY:
20
```

By pressing/holding either VALUE button, the overall Reverb Decay time can be selected as desired. *When using the Reverse Reverb type, Reverb Decay will be displayed as REVERB REVERSE TIME.*

REVERB DIFFUSION

The following page is entitled Reverb Diffusion. The display will read:

```
REVERB DIFFUSION
AMOUNT: 8
```

By pressing either VALUE button, the amount of Reverb Diffusion can be selected as desired. The range is 1 to 9.

SECTION 5

USING *QuadraVerb*

CHANGING PROGRAMS

Pressing the PROGRAM button will display the name and number of the current program. Different programs can be accessed in this mode by pressing one of the VALUE buttons, which will increment or decrement the programs until the desired program is accessed. Programs may also be accessed by holding down the PROGRAM button and entering the desired program number with the mode buttons (Note the numbers beside the button designations).

When a program is first accessed, it will be displayed as follows:

```
PROGRAM 89
" DEMO CONFIG "
```

Once a program has been edited, a period will appear behind the program number as below:

```
PROGRAM 89.
" DEMO CONFIG 1 "
```

STORING A PROGRAM

The STORE button allows you to store an edited program, or recall a factory program, in an available program location. When the STORE button is pressed once, the display will read:

```
STORE PROGRAM AT
LOCATION: 89
```

The desired location can now be accessed by pressing and holding either VALUE button.

Pressing the "up" PAGE button will access a second page that will read:

RECALL ALESIS
PROG 00 INTO 99

This page will recall the Alesis Factory program from the desired location. *Even though an edited program can be stored in any location, it will always be possible to recall the factory program in this manner. The factory program is never really erased, even though it might not be displayed.*

The desired location can now be accessed by pressing and holding either VALUE button.

Pressing the "up" PAGE button will move the cursor to the target location so that the display will read:

RECALL ALESIS
PROG 00 INTO 99

The desired location can now be accessed by pressing and holding either VALUE button.

Pressing the "up" PAGE button will access the next page which will read:

RECALL ALL 90
ALESIS PROGRAMS

This will allow all 90 Alesis Factory programs to be recalled. *Any edited programs from 00 to 99 will be deleted.* In any of the above selections, pressing the store button a second time will now save the program at the desired location, and yield a brief 2 second prompt which says:

PROGRAM STORED

Once again, this will enable the Reverb to receive either a delayed signal, or a pitch shifted signal, or a combination as determined by the next page.

REVERB INPUT MIX

The next page is the Reverb Input Mix which determines the balance between the 2 inputs. When accessed, the display will read:

REVERB INPUT
MIX 1 < 80 2

This display indicates that 80% of the input signal is being sent to Input 1, as indicated by the arrow. By now pressing either VALUE button, the relative level (or balance) can be varied. If only one input is desired, the display will read as follows after the VALUE button is held until it stops.

REVERB INPUT
MIX 1 < 99 2

REVERB INPUT
MIX 1 99 → 2

REVERB PRE-DELAY

The next page is Reverb Pre-Delay. Pre-Delay is the slight delaying of the Reverb itself so that the dry signal stands out from the Reverb more easily. A bit of Pre-Delay can sometimes make certain instruments (such as snare drums) sound bigger. This display will read as follows:

REVERB PREDELAY:
080 milliseconds

Once again, by pressing either VALUE button, the desired amount of Pre-Delay can be selected.

PRE-DELAY MIX

The following page is Pre-Delay Mix. This feature allows you to mix the amount of Pre-Delay (the length of Time

```
REVERB INPUT 1:
_PITCH OUTPUT
```

```
REVERB INPUT 1:
_POST-EQ
```

```
REVERB INPUT 1:
_PRE-EQ
```

Any of these options can be selected by again depressing the VALUE button. During editing, the default value can be returned simply by pressing both VALUE buttons at the same time.

There are two inputs to the Reverb section of the *QuadraVerb*. This page determines where the signal to Reverb Input #1 will come from. If the signal is taken from the Delay Mix, the Reverb will be sent a composite signal taken from the outputs of the Pitch and EQ sections, as selected by the Delay Input selections. If the signal is taken from the output of the Pitch section (Pitch Output), then the Reverb will be chorused, flanged, detuned, or phase shifted, depending upon which option is selected in the Pitch section. If the signal is taken from the output of the EQ section (Post-EQ), then the reverb will be equalized. This is ideal to tonally shape the reverb as desired. If the signal is taken Pre-EQ, then the Reverb will receive direct, unaffected signal only.

REVERB INPUT 2

The next page will gain access to the 2nd of the two inputs to the Reverb section. Depending upon the program, either of the following displays will be shown:

```
REVERB INPUT 2:
_DELAY OUTPUT
```

```
REVERB INPUT 2:
_PITCH OUTPUT
```

The display will then return to the one previously shown before the store was initiated.

COMPARING PROGRAMS

The Compare function makes it possible to quickly switch back and forth between the program being edited and one that is currently stored in the *QuadraVerb's* memory to instantly hear the difference.

To enter the Compare function, press the PROGRAM button any time during editing. The display will read:

```
PROGRAM g9.
"DEMO CONFIG 1"
```

Now press the "up" PAGE button. The display will read:

```
PROGRAM g9
• COMPARING •
```

Press any button to re-enter the edit mode. Repeat the above steps to Compare at any time.

EDITING PROGRAMS

Each *QuadraVerb* program has numerous routing possibilities for the 4 effects, and each effect has a variety of categories and parameters which can be adjusted and stored as desired. An Effect (like Delay, for instance) or a function (like Mix) can be easily modified through the use of *software pages*, which allow a tremendous number of parameters to become available for editing in an easy to use, orderly fashion.

To edit you need only to press an Effect or function button, press the PAGE button until the desired selection or parameter is displayed, then press a VALUE button to either select the desired choice or amount.

To help you get the most from your *QuadraVerb*, the following is a description of every page of the *QuadraVerb* in the order that they appear. An explanation, or reference to an explanation, for all functions or parameters is also given. Each page display example is the default setting to one of these programs. At any time it is possible to return to the factory default by pressing both *VALUE* buttons at the same time.

SELECTING CONFIGURATIONS

There are 5 Effect Configurations in the *QuadraVerb*. As explained in Section 4, a Configuration is the physical order in which the effects are placed. Also, in some configurations, certain effects are enhanced for special use while other effects are disabled.

The *CONFIG* button selects the various signal flow possibilities of *QuadraVerb*'s four effects. *CONFIG* will display the actual order of the Effects, and any special effects modes.

Factory Program 89 is a demo program that can be used to feature each different configuration. All pages of the page display examples are referenced to this program. At any time it is possible to return to the factory default by pressing both *VALUE* buttons at the same time.

QuadMode™

After pressing the *CONFIG* button, pressing the *VALUE* buttons will select the available choices. The first display will read:

CONFIGURATION:
EQ>PCH>DL>REVERB

This configuration displays the signal being sent through the EQ first, to the Pitch Change section, to the Delay section, and finally through the Reverb.

EDITING THE REVERB

TYPES OF REVERB

The *REVERB* button allows access to the various reverb types and parameters. After pressing *REVERB*, the display will read:

REVERB TYPE:
HALL 1

By pressing the *VALUE* buttons, the various types of reverbs can now be accessed. These will be shown as:

REVERB TYPE:
PLATE 1

REVERB TYPE:
ROOM 1

REVERB TYPE:
CHAMBER 1

REVERB TYPE:
REVERSE 1

REVERB INPUT 1

After the Reverb Type has been selected, it is now possible to selected any of the various reverb parameters for editing. This is done by pressing the *PAGE* button which will cause the display to read one of the following:

REVERB INPUT 1:
DELAY MIX INPUT