

TASCAM

TEAC Professional Division

D00892620A

CD-RW900

CD Rewritable Recorder

Professional

OWNER'S MANUAL

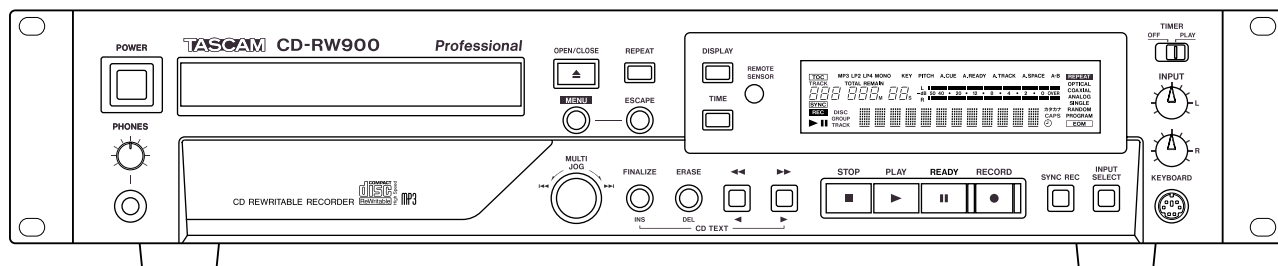

Important Safety Precautions



CAUTION: TO REDUCE THE RISK OF ELECTRIC SHOCK, DO NOT REMOVE COVER (OR BACK). NO USER-SERVICEABLE PARTS INSIDE. REFER SERVICING TO QUALIFIED SERVICE PERSONNEL.



The lightning flash with arrowhead symbol, within equilateral triangle, is intended to alert the user to the presence of uninsulated “dangerous voltage” within the product’s enclosure that may be of sufficient magnitude to constitute a risk of electric shock to persons.



The exclamation point within an equilateral triangle is intended to alert the user to the presence of important operating and maintenance (servicing) instructions in the literature accompanying the appliance.

This appliance has a serial number located on the rear panel. Please record the model number and serial number and retain them for your records.

Model number _____
Serial number _____

WARNING: TO PREVENT FIRE OR SHOCK HAZARD, DO NOT EXPOSE THIS APPLIANCE TO RAIN OR MOISTURE.

For U.S.A.

TO THE USER

This equipment has been tested and found to comply with the limits for a Class A digital device, pursuant to Part 15 of the FCC Rules. These limits are designed to provide reasonable protection against harmful interference when the equipment is operated in a commercial environment. This equipment generates, uses, and can radiate radio frequency energy and, if not installed and used in accordance with the instruction manual, may cause harmful interference to radio communications.

Operation of this equipment in a residential area is likely to cause harmful interference in which case the user will be required to correct the interference at his own expense.

CAUTION

Changes or modifications to this equipment not expressly approved by TEAC CORPORATION for compliance could void the user’s authority to operate this equipment.

For the customers in Europe

WARNING

This is a Class A product. In a domestic environment, this product may cause radio interference in which case the user may be required to take adequate measures.

Pour les utilisateurs en Europe

AVERTISSEMENT

Il s’agit d’un produit de Classe A. Dans un environnement domestique, cet appareil peut provoquer des interférences radio, dans ce cas l’utilisateur peut être amené à prendre des mesures appropriées.

Für Kunden in Europa

Warnung

Dies ist eine Einrichtung, welche die Funk-Entstörung nach Klasse A besitzt. Diese Einrichtung kann im Wohnbereich Funkstörungen verursachen; in diesem Fall kann vom Betreiber verlangt werden, angemessene Maßnahmen durchzuführen und dafür aufzukommen.

CE Marking Information

- a) Applicable electromagnetic environment: E4
- b) Peak inrush current: 12.5 A

Important Safety Instructions

- 1 Read these instructions.
 - 2 Keep these instructions.
 - 3 Heed all warnings.
 - 4 Follow all instructions.
 - 5 Do not use this apparatus near water.
 - 6 Clean only with dry cloth.
 - 7 Do not block any ventilation openings. Install in accordance with the manufacturer's instructions.
 - 8 Do not install near any heat sources such as radiators, heat registers, stoves, or other apparatus (including amplifiers) that produce heat.
 - 9 Do not defeat the safety purpose of the polarized or grounding-type plug. A polarized plug has two blades with one wider than the other. A grounding type plug has two blades and a third grounding prong. The wide blade or the third prong are provided for your safety. If the provided plug does not fit into your outlet, consult an electrician for replacement of the obsolete outlet.
 - 10 Protect the power cord from being walked on or pinched particularly at plugs, convenience receptacles, and the point where they exit from the apparatus.
 - 11 Only use attachments/accessories specified by the manufacturer.
 - 12 Use only with the cart, stand, tripod, bracket, or table specified by the manufacturer, or sold with the apparatus. When a cart is used, use caution when moving the cart/apparatus combination to avoid injury from tip-over.
- Do not expose this apparatus to drips or splashes.
 - Do not place any objects filled with liquids, such as vases, on the apparatus.
 - Do not install this apparatus in a confined space such as a book case or similar unit.
 - The apparatus draws nominal non-operating power from the AC outlet with its POWER switch in the off position.
 - The apparatus should be located close enough to the AC outlet so that you can easily grasp the power cord plug at any time.
 - An apparatus with Class I construction shall be connected to an AC outlet with a protective grounding connection.



- 13 Unplug this apparatus during lightning storms or when unused for long periods of time.
- 14 Refer all servicing to qualified service personnel. Servicing is required when the apparatus has been damaged in any way, such as power-supply cord or plug is damaged, liquid has been spilled or objects have fallen into the apparatus, the apparatus has been exposed to rain or moisture, does not operate normally, or has been dropped.

Safety Information

This product has been designed and manufactured according to FDA regulations "title 21, CFR, chapter 1, subchapter J, based on the Radiation Control for Health and Safety Act of 1968", and is classified as a class 1 laser product. There is no hazardous invisible laser radiation during operation because invisible laser radiation emitted inside of this product is completely confined in the protective housings. The label required in this regulation is shown ①.

CAUTION

- DO NOT REMOVE THE PROTECTIVE HOUSING USING A SCREWDRIVER.
- USE OF CONTROLS OR ADJUSTMENTS OR PERFORMANCE OF PROCEDURES OTHER THAN THOSE SPECIFIED HEREIN MAY RESULT IN HAZARDOUS RADIATION EXPOSURE.
- IF THIS PRODUCT DEVELOPS TROUBLE, CONTACT YOUR NEAREST QUALIFIED SERVICE PERSONNEL, AND DO NOT USE THE PRODUCT IN ITS DAMAGED STATE.

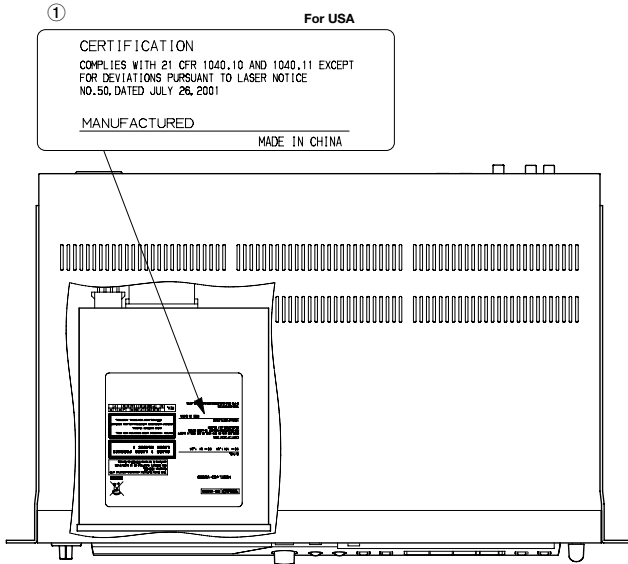

Optical pickup:

Type: SF-W37SFT
Manufacturer: Sanyo Electric Co,Ltd.
Laser output: Less than 0.7 mW on the objective
lens (record)
Wavelength: 760 to 800 nm

1 – Introduction

About this manual	6
Supplied accessories	6
Rack-mounting the unit	6
About CD-R and CD-RW discs	7
Finalizing	7
“Recordable” discs	7
Environmental considerations	8
Handling of compact discs	8
Never use a stabilizer or printable discs	9
Beware of condensation	9
Use of the remote control unit	9
Batteries	9
Inserting batteries	9
Connections	9

2 – Features of the CD-RW900

Front panel	10
Rear panel	11
RC-RW900 Remote control unit	12

3 – Menu operation

Menu configuration	13
Operation basics	13

4 – Playback operations

Discs for playback	15
Simple playback operations	15
Track selection	15
Using the skip function	15
Selecting by track number	16
Track search	16
Normal search	16
Direct search	16
Operation variations	16
Playback modes	17
Continuous playback	17
Single-track playback	17
Program playback	17
Random playback	18
Time display switching	18
Timer playback	18
Repeat playback	18
A to B repeat playback	19
Pitch control function	19
Key control function	19
Playback MP3 files	20
About MP3 track data	20
Directory playback setting	20

5 – Recording

Input selection	21
Input monitoring	21
Frequency conversion	21
Basic recording	22
Time display while recording	22
Full disc	22
Advanced recording	23
Fade-in and fade-out recording	23
Synchronized recording	23
Sync recording	23
Automatic track division	24
Manually divide track	25
Rec mute function	25

6 – After recording

Finalizing	26
Unfinalizing CD-RW discs	26
Erasing	27
Erasing tracks	27
Erasing a whole disc	27
Refreshing a disc	27

7 – Titling

Title input operation	28
Disc title input	28
Track title input	28
Keyboard type setting	29
Title input by keyboard	29
Other keyboard operations	29

8 – Reference and specifications

Error messages	30
Messages during operations	30
Troubleshooting	30
Specifications	31
Dimensional drawing	31

1 – Introduction

Thank you for your purchase of the TASCAM CD-RW900 CD rewritable recorder.

Before connecting and using the unit, please take time to read this manual thoroughly to ensure you understand how to properly set up and connect the CD-RW900, as well as the operation of its many useful and convenient functions. After you have finished reading this manual, please keep it in a safe place for future reference.

NOTE

This product is designed to help you record and reproduce sound works to which you own the copyright, or where you have obtained permission from the copyright holder or the rightful licensor. Unless you own the copyright, or have obtained the appropriate permission from the copyright holder or the rightful licensor, your unauthorized recording, reproduction or distribution thereof may result in severe criminal penalties under copyright laws and international copyright treaties. If you are uncertain about your rights, contact your legal advisor. Under no circumstances will TEAC Corporation be responsible for the consequences of any illegal copying performed using the CD-RW900.

About this manual

In this manual, we use the following conventions:

- The names of keys and controls are given in the following typeface: **ERASE**.
- When the alphanumeric portion of the display shows a message, this is shown in the following typeface: **Welcome**.

- If a preset indicator in the display (i.e. one which cannot change, but is either on or off) is shown, this is shown as follows: **RANDOM**.
- Selectable value (i.e. values of dB) or ON and OFF selection (i.e. SRC>XXX) is shown in the following typeface: **XXX**.

Supplied accessories

In addition to this manual, the CD-RW900 has been packed with the following:

- RC-RW900 remote control unit..... 1
- AC power cable 1

- AAA batteries for the remote control unit..... 2
- A rack-mounting screw kit (screws and washers)..... 1

Contact your TASCAM supplier if any of these items are missing.

Rack-mounting the unit

If you are mounting the unit in a rack, leave 1U of space above it and 4 inch (10cm) or more of space at the rear.

Use the rack-mounting kit to mount the unit in a standard 19-inch equipment rack, as shown in this section. Remove the feet of the unit before mounting.

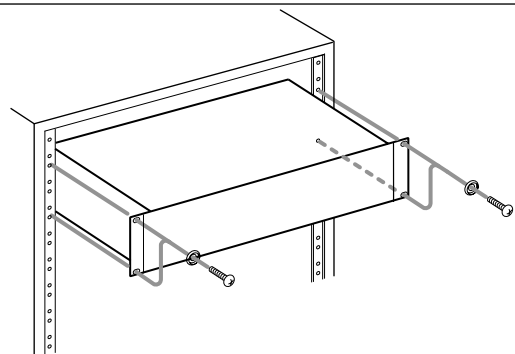

About CD-R and CD-RW discs

CD-R discs can be recorded once only. Once they have been used for recording, they cannot be erased or re-recorded. However, if space is available on the disc, additional material can be recorded. The pack-aging of CD-R discs will include one of the following logos:



By contrast, a CD-RW disc can be used in much the same way as a CD-R disc, but the last track or tracks recorded can be erased before the disc has been “finalized”, and the space on the disc can be re-used for other recordings. The packaging of CD-RW discs will include the logo one of the following logos:



However, you should note that an audio CD created using a CD-RW900 disc may not play back satisfactorily on every audio CD player. It will, naturally, be playable on the CD-RW900. This is in no way a limitation of the CD-RW900 itself, but of the difference between the different types of media and the methods used to read them.

There are precautions that you should take when handling CD-R and CD-RW discs.

- Avoid touching the recording (non-label) side of a disc on which you will be recording. Recording on a disc requires a cleaner surface than playing back, and fingerprints, grease, etc. can cause errors in the recording process.

Finalizing

Although audio data may be written on a CD-R or CD-RW disc, a standard CD player will not be able to read the data (i.e. play back the audio) until a final *TOC has been written at the start of the disc.

*TOC=Table of contents:
information of recorded data, which contains titles, starting and ending addresses, and etc..

The process of writing this table of contents is known as “finalizing”. Once this has been done, no further data can be written to the disc. See “Finalizing” on page 25 for details.

“Recordable” discs

In this manual, we use the term “recordable” disc to describe a CD-R or CD-RW disc that has not been finalized, i.e. further recording is possible on the disc.

- CD-R and CD-RW discs are sensitive to the effects of heat and ultraviolet rays. It is important that they are not stored in a location where direct sunlight will fall on them, and which is away from sources of heat such as radiators or heat-generating electrical devices.
- Always store CD-R and CD-RW discs in their cases to avoid dirt and dust accumulating on their surfaces.
- When labeling CD-R and CD-RW discs, always use a soft oil-based felt-tipped pen to write the information. Never use a ball-point or hard-tipped pen, as this may cause damage to the recorded side.
- Always keep the recording sides of the discs away from grime and dust to avoid a reduction in sound quality. To clean a disc, wipe gently with a soft dry cloth from the center towards the outside edge. Do not use thinner, gasoline, benzene or LP cleaning fluid, as these will damage the disc and cause the disc unplayable.
- Do not put labels or protective sheets on the discs and do not use any protective coating spray.
- If you are in any doubt as to the care and handling of a CD-R disc, read the precautions supplied with the disc, or contact the disc manufacturer directly.

In the case of a CD-RW disc which has been finalized, the whole of the disc may be erased, or the disc may be “refreshed”, and the disc re-used.

In addition, a CD-RW disc that has been finalized may be “unfinalized”, i.e. only the TOC is removed. This allows further tracks to be recorded to the disc, provided that there is space on the disc.

1 – Introduction

Environmental considerations

The CD-RW900 may be used in most areas, but to maintain top performance, and prolong operating life, observe the following environmental conditions:

- The nominal temperature should be between 5°C and 35°C (41°F and 95°F).
- Relative humidity should be 30 to 90 degrees non-condensing.
- As the unit may become hot during operation, always leave sufficient space above the unit for ventilation. Do not install this unit in a confined space such as a book case or similar product, and do not put any material goods on the unit.

- Avoid installing this apparatus on top of any heat-generating electrical device such as a power amplifier.
- Make sure that the unit is mounted in a level position for correct operation.

NOTE

The voltage supplied to the unit should match the voltage as printed on the rear panel. If you are in any doubt regarding this matter, consult an electrician.

Handling of compact discs

The CD-RW900 has been designed for the playback of CD-DA format discs and MP3 files recorded in ISO9660 format: In addition to ordinary 5-inch and 3-inch CDs, it can also play properly recorded CD-R and CD-RW discs.

- Always place the compact discs in the trays with their label facing upward.
- To remove a disc from its case, press down on the center of the disc holder, then lift the disc out, holding it carefully by the edges.

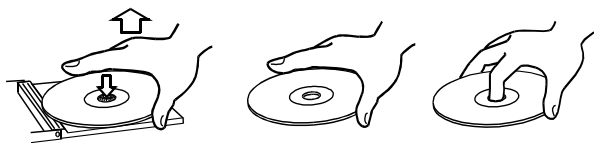

- Avoid getting fingerprints on the signal side (opposite the label side). Grime and dust may cause skipping, so keep discs clean and store them in their cases when not being played. To clean the signal side of a disc, wipe gently with a soft dry cloth from the center towards the outside edge.



- Do not use any record spray, anti-static solutions, benzene, paint thinner or other chemical agents to clean CDs as they could damage the delicate playing surface. It may cause CDs unplayable.
- Discs should be returned to their cases after use to avoid serious scratches that could cause the laser pickup to “skip”.
- Keep discs away from direct sunlight, and places of high heat and humidity. If left in such places, warping could result.

- Do not affix any labels or stickers to the label side of the disc. Do not write on the disc with a ballpoint pen.
- Do not insert discs that have adhesive remaining from tape or stickers that have been removed. If they are inserted into the player, they could stick to the internal mechanism, requiring removal by a technician.
- Do not use cracked discs.
- Only use circular compact discs. Avoid using non-circular promotional, etc. discs.

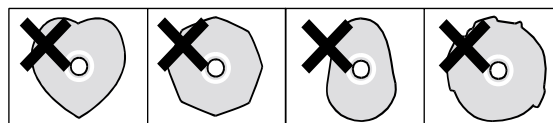

- The CD-RW900 cannot play unfinalized CD-R/RW discs.
- Music discs with copy control, a compact disc copy-protection system, have been released from several record companies aiming to protect the copyright. Since some of these discs do not comply with the CD specifications, they may not be playable on the CD-RW900.

1 – Introduction

Never use a stabilizer or printable discs

Using commercially available CD stabilizers or printable recordable discs with this player will damage the mechanism and cause it to malfunction.

NOTE

Never use a disc that has had a stabilizer mounted to it. The residual adhesive may cause the disc to stick to the turntable of the CD-RW900. If it sticks to the turntable, you will need a technician to get it out.

Beware of condensation

If the unit (or a compact disc) is moved from a cold to a warm place, or used after a sudden temperature change, there is a danger of condensation; vapor in the air could condense on the internal mechanism, making

correct operation impossible. To prevent this, or if this occurs, leave the player for one or two hours with the power turned on, then turn the power off and on again.

Use of the remote control unit

- Do not expose the light-receptive spot to the direct sunlight or intense lights of an illumination for extended periods. Long exposure to the lights may result a failure of the unit functions.
- When the remote control will not be used over one month, please remove the batteries to prevent the possibility of battery acid leakage which could damage the unit. Should leakage occur, remove and discard the batteries, and wipe the battery case thoroughly with a cloth. Avoid getting the battery liquid on the skin. After cleaning, replace with new batteries.
- The remote control functions by using an infrared light signal. When using the unit to control the CD-RW900, other devices that are turned on could be operated by its signal.
- If the range of remote operation becomes smaller, or commands do not always function properly, the batteries have become weak and should be replaced. Always replace both batteries with new batteries of the same type.
- Point the remote control to the remote sensor on the main unit. Do not obstruct the path between the remote control and the remote sensor.

Batteries

If batteries are used improperly, or if leakage or breakage occurs, the unit will not function. Please observe the cautions indicated on the batteries and their packaging to ensure proper usage.

- Confirm + and – polarity and follow the indications when inserting new batteries into the remote control.
- Do not use old and new batteries together.
- Even if the battery is the same size, the voltage may differ. Do not use batteries of different specifications together.
- Do not attempt to recharge batteries that are non-rechargeable.
- Do not open or disassemble batteries, throw them into a fire or put them in water.

Inserting batteries

1. Open the lid.
2. Confirm +/- polarity, and insert two AAA batteries.
3. Close the lid.

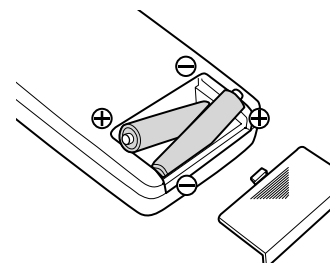

Connections

The following should be noted when you connect the unit to other equipment.

It is possible to connect the unit's **DIGITAL COAXIAL IN**, **DIGITAL OPTICAL IN** and **ANALOG UNBALANCED INs (L, R)** to other equipment at the same time. However, the unit can receive signals from only one digital input at a time.

Currently selected input jack is shown on the display.

Audio signals output from the unit are output from the analog **ANALOG OUT** jacks, as well as from the **DIGITAL COAXIAL OUT** jack and **DIGITAL OPTICAL OUT** connector simultaneously (but not from the digital outputs in stop mode).

2 – Features of the CD-RW900

Front panel

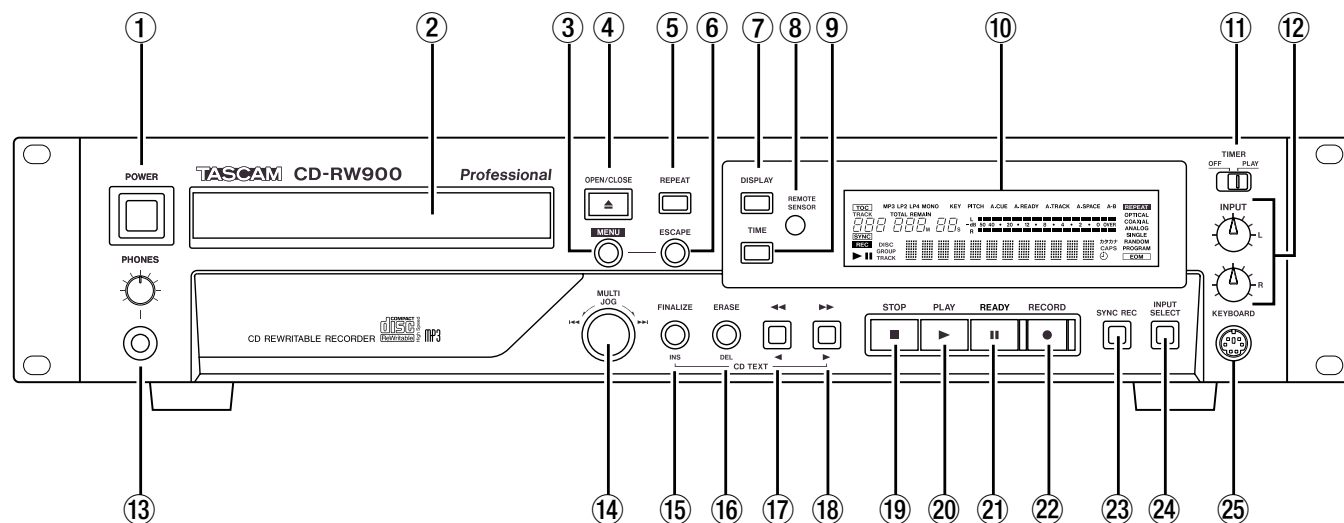

- ① **POWER switch** The power switch is used to switch the unit on and off.
- ② **Disc tray** Discs should be placed label side upwards in the disc tray. When a disc is loaded into the unit, the display period following the word **TOC Reading** as the unit determines the contents of the disc.
- ③ **MENU key** Use this key to call up the menu options (see “Operation basics” on page 14).
- ④ **OPEN/CLOSE key** Use this key to open and close the disc tray. The display shows **Open** when the tray is opening and **Close** when the tray is closing.
- ⑤ **REPEAT key** Use this key to set the repeat playback mode on and off.
- ⑥ **ESCAPE key** When in a menu mode, this key cancels the menu item selected.
- ⑦ **DISPLAY key** Use this key to see the current disc title when a disc is stopping. To display the current track title, press this key while playback or ready mode.
- ⑧ **REMOTE SENSOR** This is not a control, but the sensor for the remote control unit. When using the remote control unit, make sure that there is a clear path from the remote control unit to the sensor.
- ⑨ **TIME key** Use this key to cycle through the time modes appear on the display (see “Time display switching” on page 18).
- ⑩ **Display** The display is used to show the current status of the unit, as well as the current menu settings.
- ⑪ **TIMER switch (PLAY, OFF)** Using this key switches Timer play on and off. See “Timer playback” on page 18 for details.
- ⑫ **INPUT (L,R) controls** Use these concentric controls to adjust the level of the analog audio signals received at the **ANALOG IN** jacks.
- ⑬ **PHONES jack and the level control** Use a standard pair of stereo headphones, equipped with a 1/4-inch plug, with this jack. Adjust the volume from the jack with the level control (turn clockwise for higher volume).
- ⑭ **MULTI JOG dial** Use this dial to select tracks for playback, to set parameter values. In addition, pushing the dial acts like an **ENTER** key, i.e. the currently-displayed value or setting is confirmed.
- ⑮ **FINALIZE/INS key** Use this key to finalize recordable discs. (see “Finalizing” on page 25 for details). It also acts like a space key when entering TEXT data (see “Title input operation” on page 28).
- ⑯ **ERASE/DEL key** Use this key (with CD-RW discs only) to erase tracks, or a whole disc, or to refresh a “bad” disc, or to unfinalize a finalized disc. See “Erasing” on page 26 for details. It also acts like a delete key when entering TEXT data (see “Title input operation” on page 28).
- ⑰ **◀/▶ key** Use this key to operate review playback (search) while playback or ready mode. When Directory search is on, and when stop, using this key selects the directory. It also moves the cursor in the left direction when entering TEXT data.

2 – Features of the CD-RW900

- ⑱ **▶▶/▶ key** Use this key to operate cue playback (search) while playback or ready mode.

When Directoy search is on, and when stop, using this key selects the drectory.

It also moves the cursor in the right direction when entering TEXT data.

- ⑲ **STOP key** Use this key to stop playback or recording.
- ⑳ **PLAY key** Use this key to start or resume playback or recording.
- ㉑ **READY key** Use this key to stands by playback or recording.
- ㉒ **RECORD key** Use this key to enter record ready mode (see “Recording” on page 21 for details) and also to enter manual track divisions (see “Manual track division” on page 25).
- ㉓ **SYNC REC key** Use this key to turn synchronized

recording on and off before starting to record (see “Synchronized recording” on page 23 for details).

- ㉔ **INPUT SELECT** Use this key to select the different audio inputs and the input combinations (see “Input selection” on page 21 for full details).
- ㉕ **KEYBOARD jack** An IBM PC-compatible keyboard with PS/2 interface can be connected to this terminal to enable certain operations of the CD-RW900 with the keyboard. Title input operations, in particular, can be performed with greater efficiency.

Rear panel

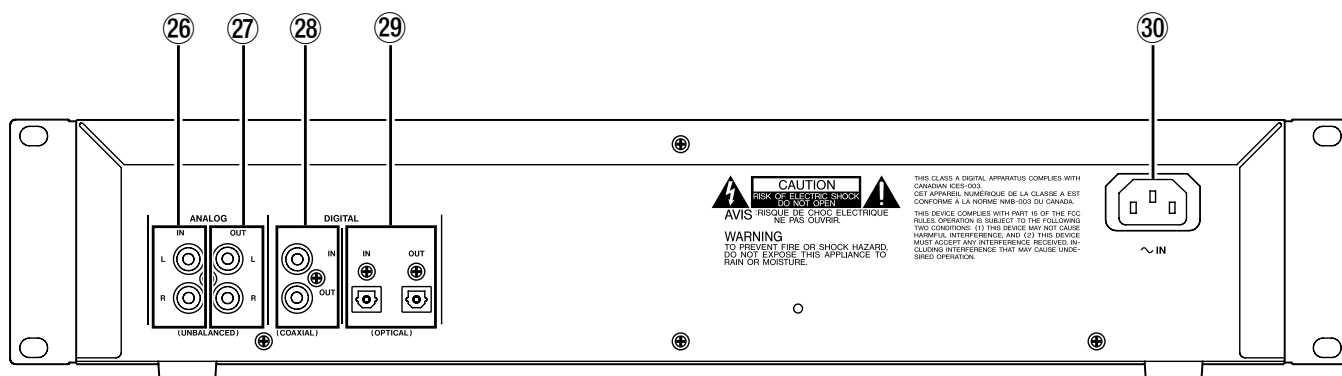

- ⑳ **ANALOG INPUT (L, R)** These RCA jacks accept analog audio signals from suitably-equipped units (–10 dBV, unbalanced).
- ㉑ **ANALOG OUT (L, R)** These RCA jacks output analog audio signals (at –10 dBV levels, unbalanced) to suitably-equipped units).
- ㉒ **DIGITAL COAXIAL (IN, OUT)** These two RCA jacks accept and output digital audio in standard consumer format (SPDIF).
- ㉓ **DIGITAL OPTICAL (IN, OUT)** These two TOSLINK optical connectors accept and output digital audio using optical fiber connectors.
- ㉔ **AC IN jack** Connects the power cable supplied.

2 – Features of the CD-RW900

RC-RW900 Remote control unit

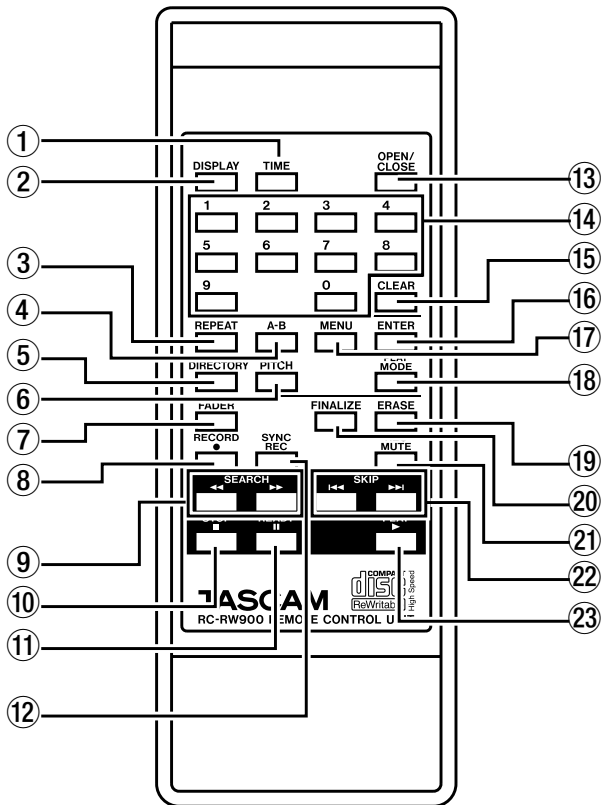

- ① **TIME key** Press this key to cycle through the time display modes.
- ② **DISPLAY key** Press this key to see the current disc tittle when a disc is stopping, or the current track tittle while playback or ready mode.

When entering TEXT data, using this key switches the text characters.
- ③ **REPEAT key** Changes between the various repeat modes when playing back (see “Repeat playback” on page 18).
- ④ **A-B key** Sets the A-B repeat points and playback mode (see “A-B repeat mode” on page 19).
- ⑤ **DIRECTORY key** Use this key to switch MP3 file directory playback on and off.
- ⑥ **PITCH key** Switches pitch control on and off.
- ⑦ **FADER key** Use this key to start fade-in recordings or to start a fade-out when recording (see “Fade-out and fade-in recording” on page 23 for details).
- ⑧ **RECORD key** Use this key to enter record ready mode.
- ⑨ **SEARCH keys (◀◀/▶▶)** Use these keys to move the playback position inside a track.

- ⑩ **STOP key** Use this key to stop playback or recording.
- ⑪ **READY key** Use this key to stands by playback or recording.
- ⑫ **SYNC REC key** Use this key to turn synchronized recording on and off (see “Synchronized recording” on page 23 for details).
- ⑬ **OPEN/CLOSE key** Opens and closes the disc tray.
- ⑭ **Number keys (0 through 9)** Use these keys for direct entry of track numbers when playing back, or making a programmed play list.
- ⑮ **CLEAR key** Clears a mistaken entry made with the number keys.

In the program mode, pressing this key cancels the program entered at the last.

It also acts like the **ESCAPE** key in the Menu mode.
- ⑯ **ENTER key** Pressing this key is equivalent to pressing the **MULTI JOG** dial to confirm an entry.
- ⑰ **MENU key** Switches the menu mode on or off.
- ⑱ **PLAY MODE key** Use this key to choose between the different playback modes (single play, continue play, etc.).
- ⑲ **ERASE key** Erases tracks (CD-RW discs only), or a whole disc, or to refresh a “bad” disc, or to unfinalize a finalized disc (see “Erasing” on page 26 for details).
- ⑳ **FINALIZE key** Finalizes recordable discs. See “Finalizing” on page 25 for details.
- ㉑ **REC MUTE key** Use this key when recording, to mute the input signal for about four seconds and then to enter record ready mode (see “Rec mute function” on page 25).
- ㉒ **SKIP (◀◀/▶▶) keys** Use these keys to move between tracks when playing back (equivalent to rotating the **MULTI JOG** dial).
- ㉓ **PLAY key** Use this key to start playback, or enter record mode from record ready mode.

3 – Menu operation

The various settings and editing operations possible with the CD-RW900 are performed through menu options shown on the display. Among the many menu set-

ting options, some may be made directly using the keys on the remote control.

Menu configuration

The menus are configured as shown below. Please see the reference page for more details of each menu.

Menu option	Sub-Menu option	Function	Reference page
PLAY	PLAY MODE	Playback mode settings	P17 (“Playback modes”)
	PITCH	Pitch control mode on/off	P19 (“Pitch control”)
	PITCH CONT	Pitch control setting	P19 (“Pitch control”)
	PITCH STEP	Pitch control variable pitch setting	P19 (“Pitch control”)
	KEY	Key control mode on/off	P19 (“Key control function”)
	KEY LEVEL	Key control level setting	P19 (“Key control function”)
	DIRECTORY	MP3 disc directory mode on/off	P20 (“Playback MP3 files”)
REC	VOLUME	Input level setting	P21 (“Input selection”)
	FADE IN	Fade-in operation time setting	P23 (“Fade-in and fade-out recording”)
	FADE OUT	Fade-out operation time setting	P23 (“Fade-in and fade-out recording”)
	SRC	Sampling rate converter on/off	P21 (“Frequency conversion”)
	SYNC LEVEL	Operation level of Sync recording	P23 (“Sync recording”)
	A_TRK	Auto track mode setting	P24 (“Automatic track division”)
	A_TRK LEVEL	Auto track operation level	P24 (“Automatic track division”)
TEXT	TEXT EDIT	Text setting	P28 (“Title input”)
SYSTEM	KEYBOARD	Setting for keyboard type	P29 (“Keyboard setting”)
	PLAY TIME	Confirming total playing time	P18 (“Time display switching”)
	REC TIME	Confirming total recording time	P22 (“Time display while recording”)

Operation basics

1 Select the desired menu option

Press the **MENU** key on the front panel or remote control to call up the desired menu. The PLAY option in the PLAY sub-menu will be shown on the display at first.

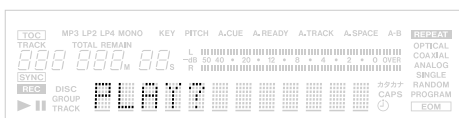

Front panel operation: Rotate the **MULTI JOG** dial to select the desired menu option, then push the dial to confirm.

Remote control operation: Use the **SKIP** key to cycle through the different menu options, then press the **ENTER** key to confirm.

The sub-menu option screen of the selected menu will be displayed.

If the PLAY option is selected, the sub-menu option shows up like this:

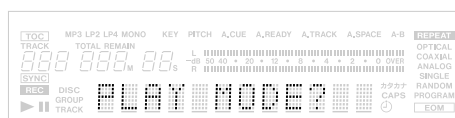

NOTE

Return to the menu option selection screen, press the **ESCAPE** key on the front panel or the **CLEAR** key on the remote control.

2 Select the desired sub-menu

Front panel operation: Rotate the **MULTI JOG** dial to select the desired sub-menu, then push the dial to enter the selection.

Remote control operation: Use the **SKIP** key to select, then press the **ENTER** key.

The menu item screen of the selected sub-menu will

3–Menu operation

appear. If the sub-menu PLAY MODE is selected, the menu item shows up like this:

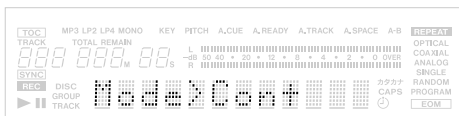

NOTE

Return to the sub-menu option selection screen, press the **ESCAPE** key on the front panel or the **CLEAR** key on the remote control.

3 Setting the desired menu item or value

Front panel operation: Use the **MULTI JOG** dial to select the desired menu item or value. Pushing the dial enters and exits menu mode.

Remote control operation: Use the **SKIP** key to select. Pressing the **ENTER** key confirms and exits menu mode.

NOTE

Some menu options exist for confirmation purposes only, and setting cannot be performed.

4 How to exit menu mode after setting (or confirmation), during menu option display.

As well as pushing the **MULTI JOG** dial or pressing the **ENTER** key, you can use the **MENU** key to exit menu mode.

NOTE

The selected menu mode remains after power is turned off, except the **TEXT** menu.

4-Playback operations

The CD-RW900 can be used to play back CDs (including CD-R and CD-RW discs that have been recorded and finalized on other types of recorder), as well as CD-R discs and CD-RW discs that have been recorded on the unit.

Audio files in MP3 format on CD-ROM, CD-R and CD-RW are also playable on the unit.

Discs for playback

The CD discs in the CD-RW900 can play back the types of discs listed below.

- Commercial pre-recorded CDs recorded in CD-DA format.
- CD-R and CD-RW discs that have been recorded in CD-DA format and finalized properly.

- MP3 files recorded in ISO9660 level 1 and level 2 format on CD-R and CD-RW discs, and properly finalized. MP3 files recorded in the format which adheres to Joliet, are also playable.

Simple playback operations

- 1 Press the **POWER** switch to turn on the unit.
- 2 Press the **OPEN/CLOSE** key to open the disc tray. The display shows **Open**. Insert a disc in the tray with the label side up.
- 3 Press the **OPEN/CLOSE** key to close the tray. The display shows **Close** when a disc is loaded into the unit, then **TOC Reading**. will appear, with the period flashing.

When the TOC has been read, the display shows the number of tracks and total running time of the disc.

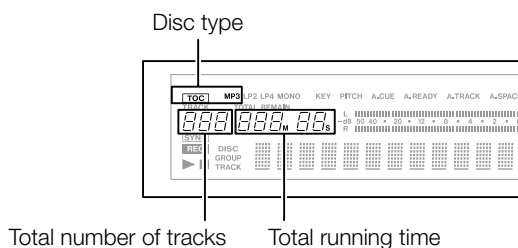

The CD-RW900 also shows one of the following:

- TOC** A disc finalized
- MP3** A disc contains MP3 files

Track selection

Using the skip function

Skipping track numbers backward or forward.

- 1 Select desired tracks for playback with the **MULTI JOG** dial on the front panel. Turning clockwise skips the track number backward and counterclockwise skips forward.
Or, press the **SKIP** key on the remote control. Pressing **▶▶** key skips the track number backward and **◀◀** key skips forward.

- 4 Press the **PLAY** key to start playback.
Adjust the connected monitor system, or the level control for the PHONES on the unit to set the listening level you desire.

WARNING

*If you monitoring using headphones, adjust the level control to low on the unit, then connect to the **PHONES** jack before playing back. This will prevent any possible damage for your hearing.*

- 5 To stop playback, press the **STOP** key.

Temporarily stop playback and enter playback standby mode, press the **READY** key. To resume playback, press the **PLAY** key again.

NOTE

The explanation in this manual will assume the user is starting from the normal Continuous mode.

4-Playback operations

Selecting by track number

Using the number keys on the remote control, the number of the desired track can be entered directly. Even numbers with two or three digits can be entered easily. For example:

Track 9: press '9' and 009 will be displayed.

Track 12: press '1' and '2' and 012 will be displayed.

Track 103: press '1' and '0' and '3' and 103 will be displayed.

After input, press the **PLAY** key to start playback. Or, the **READY** key to cue the track at its head position and enter playback standby mode.

You can also enter the track number and start playback by pushing the **MULTI JOG** dial or using the **ENTER** key.

NOTE

This function cannot be used in Program or Random mode.

Track search

Normal search

1 Press the ◀▶ / ▶▶ search key continuously on the front panel, or the **SEARCH** ◀▶ / ▶▶ key on the remote control.

2 To stop the search function, simply release the ◀▶ / ▶▶ or the **SEARCH** key.

NOTE

The search function does not operate with MP3 discs.

Direct search

By specifying time from the start of a certain track, you can start playback from a specified point of a specified track.

Basic operation

1 During stop, play or playback standby modes, use the number keys on the remote control to input the three-digit track number (such as 002 for track 2), then the desired elapsed time (**min **sec) from the start of that track.

Example: To specify 1 min 30 sec from the start of track 2, input "002 001 30".

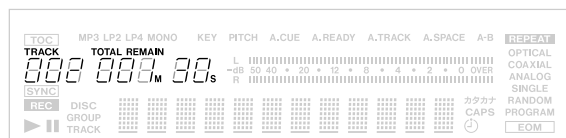

During input, the counter in the display will flash.

Pressing the **CLEAR** key cancels the input at any stage during input.

NOTE

Regardless of the time display mode (refer to "Time display switching on page 18), the time from the start of the specified track is displayed.

During stop or playback modes, when the final digit is entered, the desired position is automatically located and playback will begin from the desired point. During playback standby mode, at the desired point the unit will enter playback standby mode.

NOTE

• *If a point which does not exist is entered, setting operation will be cancelled.*

- *The direct search function cannot be used in program or random mode.*
- *For MP3 discs, time cannot be specified within a track. However, if you input the three-digit track number, playback will begin from the start of that track.*

Operation variations

Even if the final second is not input, playback will begin from the selected point after pressing the **ENTER** or **PLAY** key. Or, if you press the **READY** key, the unit will enter the playback standby mode at the selected point.

Specifying a track number only

After inputting the track number, press the **ENTER** or **PLAY** key to begin playback of that track, or the **READY** key to cue the track and enter playback standby mode.

NOTE

Instead of inputting the three-digit track number, you can input only the desired track number.

Example: To specify track 3, input only "3".

Specifying to the minute

After inputting the three-digit track number and the number of minutes after the start of the track, press the **ENTER** or **PLAY** key to begin playback of that track, or the **READY** key to cue the track and enter playback standby mode.

Example: To specify 1 min 00 sec from the start of track 2, input "002 001"

NOTE

Following the above example, if "0021" is input, the same position will be located.

4-Playback operations

Playback modes

There are four different playback modes. The selected mode will be indicated on the left of the display.

- Continuous playback mode (default setting): no indication lamp
- Single playback mode: **SINGLE** lamp is lit
- Program playback mode: **PROGRAM** red lamp is lit
- Random playback mode: **RANDOM** red lamp is lit

The playback mode can be selected using the **PLAY MODE** key on the remote control unit. Pressing the key changes the playback mode on the display in the following order:

Continue→**Single**→**Program**→**Random**

You can also select the playback mode using the **PLAY MODE** option in the **PLAY** sub-menu (refer to “Opera-

tion basics” on page 14). Turning the **MULTI JOG** dial clockwise changes the playback mode shown on the display in the following order:

Mode>**Cont**→**Mode**>**Single**→**Mode**>**Program**→**Mode**>**Random**

Pressing the **MENU** key or pushing the **MULTI JOG** dial returns to normal mode from the menu mode.

While the mode can be changed from any playback mode, the explanation in this manual will assume the user is starting from the Continuous mode.

NOTE

The selected playback mode remains after power is turned off. However, the setting of program playback mode will be deleted when power is turned off.

Continuous playback

Programing is cancelled, and playback continuous in the normal order.

- 1 During stop, set the **Continue** or the **Mode**>**Cont** mode.

- 2 Press the **PLAY** key to begin playback in order of the track number.

Single-track playback

This function enables playback of just a single track.

- 1 During stop, set the **Single** or the **Mode**>**Single** mode.
- 2 Use the **SKIP** key or the number keys (0~9) on the remote control to select the desired track.

The **MULTI JOG** dial can be used to select the track also.

- 3 Press the **PLAY** key to begin playback.

After the selected track finishes, playback stops.

Program playback

This function enables playback of selected tracks in any desired order. Up to 99 tracks can be selected for program playback.

- 1 During stop, set the **Program** or the **Mode**>**Program** mode.
- 2 Use the number keys (0~9) on the remote control unit to select each desired track for program playback, then press the **ENTER** key.

You can also rotate the **MULTI JOG** dial to select the track number and push to enter.

The track number will be entered into the program.

Repeat the above step 2 until the desired program is completed. As the program is being created, the program number and total program playing time is revised on the display.

NOTE

*If the **CLEAR** key is pressed, the programmed track will be deleted from the last.*

- 3 When program setting is completed, press the **PLAY** key to begin playback of the tracks in the programmed order.

NOTE

- *If the **STOP** key is pressed without first pressing the **PLAY** key, all the program data will be erased.*
- *During stop, if the playback mode is switched to another, all the program data will be erased.*
- *The programmed play order is not memorized when power is turned off.*
- *In this mode, if any track is not programmed, the CD-RW900 will not start playback.*
- *If an attempt is made to enter more than 100 program steps, the message **PGM Full!** appears on the display.*
- *If the total program playing time exceeds 999 min 59 sec, --- : -- appears on the display.*

4-Playback operations

Random playback

In this mode, the unit will play back all the tracks on the disc in completely random order, regardless of track number.

- 1 During stop, set the **Program** or the **Mode>Random** mode.
- 2 Press the **PLAY** key and random playback will begin.

NOTE

Even when power is turned off, the unit will remain in Random mode.

Time display switching

When the **TIME** key on the front panel or the remote control is pressed, the time display will switch through several modes on the display.

- Elapsed track time (no display light indication)
- Remaining track time (**REMAIN** is lit in the display)
- Elapsed disc time (**TOTAL** is lit in the display)
- Remaining disc time (**TOTAL** and **REMAIN** are lit in the display)

When stopped, the total recording time is shown, regardless of the status of the **TOTAL** and **REMAIN** indicators.

NOTE

- In program mode, pressing the **TIME** key displays the elapsed and the remaining time of the whole program.
- When playing an MP3 disc, elapsed track time is always displayed, and the **TIME** key cannot be used.
- For details on time display during recording, please refer to "Time display while recording" in "Recording" section on page 22.
- Even when power is turned off, the time display mode setting is retained.

Timer playback

By using an external timer, you can set the CD-RW900 to play the loaded disc automatically when the unit is turned on by the timer.

- 1 First, plug the power cord of the CD-RW900 into the power outlet of the timer.
- 2 Load a disc into the unit.
- 3 Switch the **TIMER** switch on **PLAY** to enable timer function on for the desired deck.

When Timer playback has been turned on, the timer icon lights up in the display.

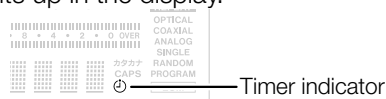

NOTE

The indicator flashes when a disc is not loaded into the unit.

- 4 Set the timer to the desired time. Consult the timer's operation manual for details. At the set time, the power to the CD-RW900 will be turned on, and playback will automatically begin.

Repeat playback

- 1 Press the **REPEAT** key to turn on the repeat mode. In this mode, all the tracks on the disc are played continuously. The display shows **Repeat ON** and the indicator lights up **REPEAT**.

During playback, if the repeat mode is turned on, playback continues as before, and when the last track finishes, playback resumes from the first track.

If the repeat mode is turned on when the deck is stopped, press the **PLAY** key to begin operation.

- 2 Press the **REPEAT** key again to turn off the repeat mode. **Repeat OFF** appears then **REPEAT** indicator turns off.

NOTE

- Combining the repeat mode with the program, Single-track playback and Random playback functions will enable Program repeat, Single-track repeat and Random repeat operations, respectively.
- Settings of the repeat playback mode remain after power is turned off, except the specified A-B section (see "A-B repeat playback" on page 19).

A to B repeat playback

If a specific portion between two points on the disc is specified, that portion can be played back repeatedly.

- 1 During playback, press the **A-B** key on the remote control at the beginning of the desired portion on the disc.

REPEAT indicator lights up in the display and the **A**-indicator will flashes.

- 2 At the end of the desired portion on the disc, press the **A-B** key again.

Then, **REPEAT** and **A-B** indicator light up in the display, and the desired A-B section will be played back repeatedly.

NOTE

You can also operate this function during playback standby.

- 3 To cancel the A-B repeat mode and resume normal playback, press the **A-B** key once again.

REPEAT and **A-B** indicator will turn off.

NOTE

- A-B repeat mode cannot function For MP3 discs.
- In Random and Program modes, A-B repeat cannot function when the specified A-B section spans more than one track, and does not function for MP3 discs.
- When the **STOP** key is pressed, the specified A-B section is cancelled.

Pitch control function

When playing back an audio CD, the pitch (or speed) of the playback can be varied. Pitch can be varied +/- 16%.

- 1 During stop, press the **PITCH** key on the remote control to turn on the Pitch control function.

Or, use the PITCH option in the PLAY sub-menu to turn on (refer to "Operation basics" on page 14)

The current pitch value appears on the display for seconds and the **PITCH** indicator will light up.

- 2 Press the **MENU** key and select the PITCH CONT option in the PLAY sub-menu to set the desired value and push the **MULTI JOG** dial to enter.

Pitch>XXX will appear on the display.

Then, rotate the **MULTI JOG** dial to set the desired value.

NOTE

Use the PITCH STEP option in the PLAY sub-menu to

adjust the pitch value steps from 0.1% to 1.0% in 0.1% increments (default: 0.1%)

- 3 Press the **MENU** key or push the **MULTI JOG** dial to enter and return to normal mode.

During playback, the pitch control playback can be off temporarily. Press the **PITCH** key on the remote control or use the PITCH option in the PLAY sub-menu to turn the function off.

Pitch>OFF appears on the display and the pitch control playback will be off temporarily, until the function is re-set again.

To resume the pitch control playback, press the **PITCH** key again or use the PITCH option.

NOTE

- When turning the pitch control on and off during playback, sound output is cut for a short instant.
- Pitch control cannot be applied for MP3 discs.

Key control function

The key of the music can be changed during stop, playback or playback standby mode. However, please note that this feature does not operate with MP3 discs.

- 1 Press the **MENU** key to select the KEY option in the PLAY sub-menu (refer to "Operation basics" on page 14) to enter the function.

The **KEY** indicator will light up.

- 2 Call up the KEY LEVEL option in the PLAY sub-menu to adjust the playback key level.

The playback key can be raised or lowered 1/2 octave in half-tone increments. Selection values: 0 (no change), ♭1 to ♭6, #1 to #6.

- 3 Rotate the **MULTI JOG** dial to select the desired key level and push to enter.

NOTE

- In this condition, when a CD is played back, the key of the music is changed while the speed of the music remains the same.
- Even when the power is turned off, the key change setting is retained.
- When the Key control function is on, even if the Pitch control function is used to change the playback speed, the key of playback will remain fixed at the preset key {even if the key level is 0 (zero)}, the Key control function can be turned on.
- When using the key control function, playback sound may occasionally sound as vibrating. This is a result of a special process applied to CD playback sound and is normal.

4-Playback operations

Playing back MP3 files

MP3 files recorded onto a CD are handled the same way as files are handled in an ordinary PC, with some MP3 files held within a directory. In addition, several directories can be combined into one directory. This results in multiple layers of directories and files.

When the Directory mode is on, only those files within a selected directory are available for playback.

When the directory mode is off, the directory configuration is ignored, and all MP3 files recorded on the disc are available for playback. Please note that Program playback and Repeat playback only function within directories.

NOTE

Each MP3 file is handled as a track.

Directories which do not contain MP3 files directly under them cannot be selected for playback. For example, in the diagram below, under directory A are directory B and directory C. If there are MP3 files in both directory B and C, directory A cannot be selected for playback, but directory B and C can be selected for playback.

The CD-RW900 can play back MP3 files recorded in formats which conform to ISO9660 level 1, level 2, formats which conform to ISO9660 level 1, level 2, or Joliet. Discs recorded in multiple sessions may also be played back.

For MP3 CDs to be played by the CD-RW900, the following limitations have been placed on the number of MP3 files and directories.

- Maximum number of directories: 255
- Maximum number of hierarchical structures: 8
- Maximum number of MP3 files: 999
- Maximum title size of MP3 files and directories: 255

MP3 files are played in the following order

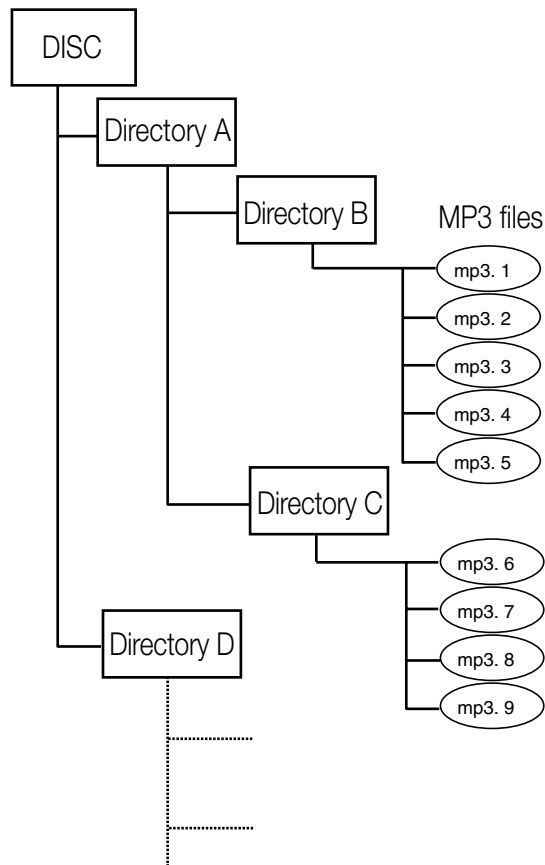

In this manner, playback is performed from the top level directories.

About MP3 track data

During playback, titles are displayed in the following order of priority:

ID3v2 > ID3v1 > file title

During stop mode, the file title is displayed.

Directory playback setting

- 1 Press the **DIRECTORY** key on the remote control.
Or, use the DIRECTORY option in the PLAY sub-menu to turn this mode on or off (refer to "Operation basics" on page 14).
Pressing the **MENU** key or pushing the **MULTI JOG** dial exits to normal mode.

NOTE

All MP3 files in a disc can be played back when directory playback mode is off. The indicator **MP3** lights up and only the total number of track will be shown.

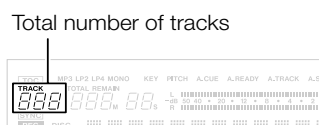

- 2 During stop, use the **MULTI JOG** dial or **SKIP** key to select desired directory for playback.
- 3 Press the **PLAY** key to start playback in the directory.
Program or Repeat playback can be operated in the selected directory also.

NOTE

- During stop, pressing the **ENTER** key shows current directory name.
- During playback or standby mode, pushing the **MULTI JOG** dial shows the MP3 file name currently played back.
- MP3 file formatted at 44,1 kHz sampling rate and 128 kbps or higher is required to play back, otherwise, MP3 file cannot be played back.

Before you start recording using the CD-RW900, make sure that you understand the following key points:

- Once you have recorded on a CD-R disc, the data cannot be erased from it.

- You can add tracks to an unfinalized recordable disc. Once finalized, a CD-R disc is “fixed” and behaves in the same way as a pre-recorded disc. Finalized CD-RW discs, however, can be erased, re-freshed and re-recorded.

Input selection

To select the input to be recorded, press the **INPUT SELECT** key on the main unit.

Repeated presses of the key cycle through the following options:

ANALOG	Analog
OPTICAL	Optical digital in
COAXIAL	Coaxial digital in

In the case of either the coaxial or optical inputs being selected, the appropriate indicator: **COAXIAL** or **OPTICAL**, lights on the right of the screen.

If the analog signal is selected, the **ANALOG** indicator lights on the right of the screen.

Analog recording level The level of the analog signals received at the **ANALOG IN** jacks are controlled with the **INPUT** controls.

When recording analog signals, set the digital volume to 0 dB.

Digital recording level The level of the digital signal may be controlled using the digital volume menu, as described below.

- 1 Call up the **VOLUME** option in the REC sub-menu (refer to “Operation basics” on page 14).
Push the **MULTI JOG** dial to enter the function on.
- 2 Rotate the **MULTI JOG** dial to adjust the input volume between -54dB and +18 dB (relative to the original input level).
There is also a $-\infty$ setting which represents a complete signal cut. The display shows **Vol> ---dB** for the $-\infty$ setting.
- 3 Press the **MENU** key or push the **MULTI JOG** dial to enter the setting and return to normal mode.

Input monitoring

When the unit is in record ready, or record mode, the input signal is output from the **OUT** jacks (digital and analog), allowing you to hear the input signal.

- 1 Press the **RECORD** key on the front panel or the remote control when a recordable disc is not inserted.

The word **Monitor** appears on the display to show that the output signal is an echo of the input signal(s).

- 2 Exit the monitor mode by using the **STOP** key.

Frequency conversion

The sampling frequency for CDs is 44.1 kHz. The CD-RW900 will always record (and play back) CDs at this frequency.

However, if recording through a digital connection (either coaxial or optical) and the source has been recorded at a frequency other than 44.1 kHz, or is being played back at a non-standard speed using a varispeed unit (more than 1% away from the standard), the CD-RW900's internal frequency converter: SRC (Sampling rate convertor) will automatically convert the incoming frequency to 44.1 kHz.

To set the SRC

Press the **MENU** key and select the SRC? option in the REC sub-menu (refer to “Operation basics” on

page 14).

Rotate the **MULTI JOG** dial and select ON.

Press the **MENU** key or push the **MULTI JOG** dial to enter and return to normal mode.

NOTE

When the SRC function is off, receiving digital signals, the display shows the REC indicator flashing while recording or recording standby mode.

*The digital signals other than 44.1kHz cannot be recorded when SRC is off. The error message **Not Fs44.1k!** will appear on the display.*

5-Recording

Basic recording

- 1 Load a recordable disc into the unit. As the disc loaded, the display shows **TOC Reading.**, with the period flashing.
- 2 Press the **INPUT SELECT** key to select a recording source (see “Input selection” on page 21).
If a digital source is selected, and the connection or the signal are improper, the error message **D-IN UNLOCK!** will appear on the display.
- 3 Press the **RECORD** key. The unit enters record ready mode, as shown by the **REC** and **READY** indicators on the display.

NOTE

As the unit enters record ready mode, the display shows the **Now OPC** (Optimum Power Control) occasionally, as the unit prepares to record on the disc.

To adjust the level of the source, following the guidelines in “Input selection” on page 21.

NOTE

The red **OVER** indicators on the meters should never light. Unlike analog equipment, digital audio units produce extremely unpleasant sounds when distorted, and there is no “headroom” after the 0 mark. If recording digitally from a commercially-produced CD, the volume set in the menu should be 0 dB. This will maintain all the dynamic range of the source CD without clipping. Only boost the signal if the source is exceptionally quiet.

An analog signal input at nominal level, with no cut or boost from the volume controls, is equivalent to a reading of -16 dB on the meters.

Time display while recording

When in record or record ready mode, repeated presses of the **TIME** key cycle through four different time modes:

- Elapsed track time (no display light indication)
- Remaining track time (**REMAIN** is lit in the display)

- 4 Press the **PLAY** key to start recording.
Pressing the **READY** key stands by recording temporarily. To restart recording, press the **READY** key or **PLAY** key again.
- 5 Press the **STOP** key to stop recording.
When recording stops, the display shows **PMA Writing** (Program Memory Area) flashing for a few seconds as the unit writes to the disc.

NOTE

- During the **PMA Writing** is shown, any key cannot be used.
- To confirm the total recording time, use the **REC TIME** option in the **SYSTEM** sub-menu (refer to “Operation basics” on page 14).

CAUTION

Do not vibrate the unit or turn off the power when the unit writes to the disc, otherwise, recording fails.

- Elapsed disc time (**TOTAL** is lit in the display)
- Remaining disc time (**TOTAL** and **REMAIN** are lit in the display)

Full disc

If recording a long program, when there is no space remaining on the disc for recording, as shown by the above time display, just before the end of the disc is reached, the unit starts a fade-out over four seconds (the display shows **Fade Out**).

When the fade-out has finished, the display shows **Disc Full!**. Press the **STOP** key to exit.

If the disc is a CD-RW, the final track can be erased, if required (see “Erasing” on page 26) and the disc then finalized. If the disc is a CD-R, it must be finalized prior to use (see “Finalizing” on page 25).

Advanced recording

Fade-in and fade-out recording

At the beginning and end of recording, fade-in and fade-out effects can be performed.

- 1 During stop or recording standby mode, set the operation using the following menu options on the REC sub-menu (refer to “Operation basics” on page 14).

FADE IN?

The length of the fade in to the normal level can be set between 1 and 30 seconds in 1-second increments (default setting: 3 seconds).

FADE OUT?

The length of the fade out into complete silence can be set between 1 and 30 seconds in 1-second increments (default setting: 3 seconds).

The display shows **Fade Out>XXs** or **Fade In>XXs**.

- 2 In recording standby mode, press the **FADER** key on the remote control.

Recording begins and the sound fades in. After the preset fade-in time, the sound is at normal level.

- 3 During recording, press the **FADER** key on the remote control when you wish to fade-out the sound.

Fade-out begins with **Fade Out** flashing on the display then the unit enters recording standby mode.

- 4 Press the **STOP** key and the PMA writing will begin.

NOTE

*Fade-in or fade-out function can be operated only pressing the **FADER** key on the remote control unit.*

Synchronized recording

Synchronized recording basically means that recording will begin automatically when a signal is received, and will stop when the signal ends.

Use the **SYNC REC** key to select the synchronization mode. The synchronization mode determines the automated start and stopping of recording when a signal is received.

During stop or recording standby mode, repeated presses of this key cycle through the following modes:

- **Sync ALL:** The **SYNC** indicator lights up.
- **Sync 1:** The unit stops when a selected track is finished and the **SYNC** indicator flashes
- **Sync OFF:** Turns Sync recording function off

After the synchronization mode is selected, the record ready mode must then be entered (you cannot reverse the order of these steps).

Starting playback of the source automatically starts recording on the CD-RW900 if Sync ALL or Sync 1 has been selected (see “Sync recording” below) and manual record start is disabled. If Sync OFF is selected, the recording must be started manually.

Sync recording

- 1 While recording standby mode, press the **SYNC REC** key repeatedly to select Sync ALL or Sync 1.
- 2 Set the signal detection threshold level. Use the **SYNC LEVEL** option in the REC sub-menu (refer to “Operation basics” on page 14).

Rotate the **MULTI JOG** dial to adjust the level. The level can be set from -72 dB to -24 dB in 6 dB increments. The default setting is -24 dB.

Press the **MENU** key or push the **MULTI JOG** dial to enter and return to recording standby mode.

- 3 Input the source signal.

Recording begins automatically when the source signal is detected. The source signal should be higher than the adjusted threshold level.

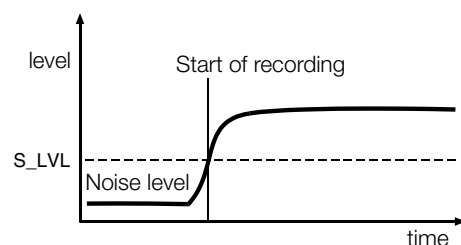

NOTE

- *After the mode is set, more than one second of signal under the adjusted threshold level is required to start recording automatically, otherwise, the unit does not begin recording even it detects the signals.*

5-Recording

When audio signal is not detected more than five seconds, the CD-RW900 automatically will stop recording and enters record standby mode.

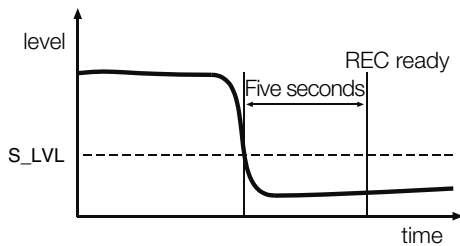

NOTE

In the Sync 1 mode, if the unit detects the signal which is under the adjusted level over five seconds, the Sync recording mode will be canceled.

- To cancel the Sync recording mode, press the **SYNC REC** key and select the Sync OFF. Recording returns to normal and continues till you press the **STOP** key or the source signal stops.

Pressing the **STOP** key stops recording. Once stopped, the selected mode will be canceled.

NOTE

- When the Sync 1 is on, and the **READY** key is pressed, Sync recording stops and the setting will be canceled.

- When the Sync ALL is on, and the **READY** key is pressed, the unit enters recording standby mode with remaining the Sync recording setting.
- If you set the value only high-level signals trigger recording, remember that this will not record the start of a piece:

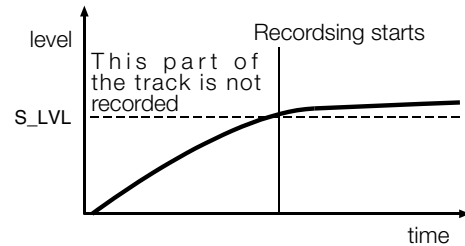

- Also remember that when recording from an analog source, the threshold should be set so that it is higher than the "noise floor". If the "noise floor" is higher than the threshold, a false start will occur:

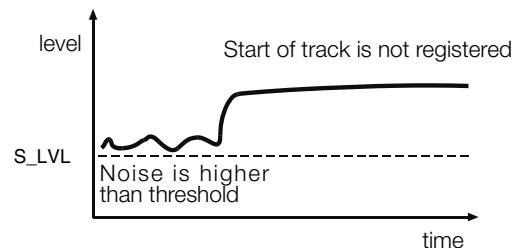

Automatic track division

The trigger level can also be used to divide tracks if the A_TRACK (auto track) function is enabled.

When this function is enabled, the unit automatically inserts a track division in the recorded material.

To enable or disable automatic track division:

- Use A_TRK option in the REC sub-menu to set the mode on. The **A.TRACK** indicator at the top right of the display lights.
- Rotate and push the **MULTI JOG** dial to select and enter the modes following:

- Level

When the sound level has dropped below the threshold for more than two seconds, and sound has re-started, the track will be divided.

Use A_TRK LEVEL option in the REC sub-menu. The trigger level is set to -24dB to -72 dB.

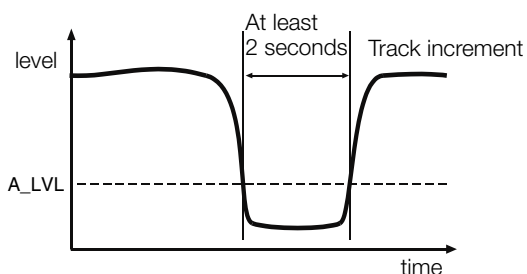

- DD (digital direct)

When recording digitally from MD, CD or DAT, this mode detects a track boundary and divides the track.

However, when the DD mode is on, and if the analog source or non-DAT/CD/MD digital connections are detected, the track number will be increased by the setting level that you set in the Level mode.

Manually divide track

While recording is taking place, press the **RECORD** key. The current track number is incremented by one.

For details of automatic track division while recording, see “Automatic track division” on page 24.

NOTE

- According to the “Red Book” (the specification for audio CDs), a track cannot be less than four seconds in length, and there can be a maximum of 99 tracks on an audio CD. Bear these limitations in mind when adding track divisions.
- This operation can not be applied during recording the track 99.

Rec mute function

The Rec mute function allows instant cut-off of the input signal, and records four seconds of silence on the disc.

While recording is in progress, press the **REC MUTE** key on the remote control.

The display shows the **Rec Mute** flashing, the meters stop displaying the current level and the monitored sound is cut.

After about four seconds, the unit enters record ready mode.

NOTE

This function is only available from the remote control unit.

6-After recording

This section deals with the actions taken after recording: finalizing for CD-R and CD-RW discs, and erase operations for CD-RW discs.

Once finalized, CD-R discs are truly final—no more can be recorded on them. By contrast, CD-RW discs

can be “unfinalized” using the CD-RW900, i.e. their TOC can be deleted, and if there is space, further material can be recorded on them. Even if the disc is full, tracks can be erased following the unfinalize process, and new material can be recorded.

Finalizing

As has been explained earlier (“Finalizing” on page 7), in order for a disc to become a standard CD, it must have a Table of Contents (TOC) written to it. This process is known as finalizing.

An unfinalized disc can always be distinguished on the CD-RW900 by the **TOC** indicator under the disc type on the display being un-lit when the disc is inserted.

To finalize a disc:

- 1 Load the unfinalized disc, and the unit in stop mode, press the **FINALIZE** key.

The display shows **FINALIZE?**

If you do not want to proceed with the finalizing process, press the **FINALIZE/INS** key on the front panel or the **FINALIZE** key on the remote control.

- 2 To start the finalizing process, push the **MULTI JOG** dial or press the **ENTER** key on the remote control.

The display shows **Sure?**

If you do not want to proceed with the finalizing process, press the **STOP** key.

- 3 When finalization has been chosen, the display shows the **TOC** flashing and the remaining time. The unit starts counting down from a time shown on the display.
- 4 When finalization has been finished successfully, **Complete** appears and the **TOC** will be lit on the display.

NOTE

During the process of finalizing, any key operation is not accepted.

Unfinalizing CD-RW discs

If a CD-RW disc has been finalized, it is possible to erase the Table of Contents in the following way:

- 1 With the finalized disc loaded and the unit in stop mode, press the **ERASE/DEL** key on the front panel or the **ERASE** key on the remote control.

Rotate the **MULTI JOG** dial or press the **SKIP** keys on the remote control to select **UNFINALIZE?**. Push the **MULTI JOG** dial or press the **ENTER** key to confirm.

If you do not want to proceed with the unfinalizing process, press the **ERASE/DEL** key on the front panel or the **SKIP** keys on the remote control.

- 2 The display shows **Sure?**

If you do not want to proceed with the unfinalizing process, press the **STOP** key.

- 3 To start the unfinalizing process, press the **MULTI JOG** dial or the **ENTER** key again.

When unfinalization has been chosen, the display shows the **Erase** flashing and the remaining time. The unit starts counting down from a time shown on the display.

- 4 When finalization has been finished successfully, **Complete** appears on the display, yet the **TOC** will go off.

Erasing

Erasing tracks

This operation erases the specified track and all subsequent tracks from a recorded CD-RW disc.

- 1 During stop, press the **ERASE/DEL** key on the front panel or the **ERASE** key on the remote control. Select the **ERASE TRACK?** rotating the **MULTI JOG** dial or pressing the **SKIP** keys on the remote control.

To cancel the operation at this point, press the **ERASE/DEL** or the **ERASE** key again.

- 2 Push the **MULTI JOG** dial or press the **ENTER** key to enter the function.

The display shows **Erase XX-XX** (the number of the first track and last track to be erased).

Rotate the **MULTI JOG** dial or press the **SKIP** key to change the track numbers you desire to erase.

To cancel the operation at this point, press the **ERASE/DEL** or the **ERASE** key again.

- 3 Push the **MULTI JOG** dial or press the **ENTER** key to operate the function.

The display shows **Sure?**

To cancel the operation at this point, press the **STOP** key.

- 4 Push the **MULTI JOG** dial or press the **ENTER** key again to proceed the operation.

The display shows the **Erase** flashing and the remaining time. The unit starts counting down from a time shown on the display.

NOTE

*Once the operation is proceeded, the **STOP** key cannot function. Please confirm before the operation.*

- 5 When the tracks have been erased, **Complete** will appear on the display.

Erasing a whole disc

When you want to erase a whole disc (all the tracks on a disc), follow the procedure below:

- 1 During stop, press the **ERASE/DEL** key on the front panel or the **ERASE** key on the remote control. Select the **ERASE DISC?** rotating the **MULTI JOG** dial or pressing the **SKIP** keys on the remote control.

To cancel the operation at this point, press the **ERASE/DEL** or the **ERASE** key again.

- 2 Push the **MULTI JOG** dial or press the **ENTER** key to enter the function.

The display shows **Sure?**

To cancel the operation at this point, press the **STOP** key.

- 3 Push the **MULTI JOG** dial or press the **ENTER** key again to proceed the operation.

The display shows the **Erase** flashing and the remaining time. The unit starts counting down from a time shown on the display.

NOTE

*Once the operation is proceeded, the **STOP** key cannot function. Please confirm before the operation.*

- 4 When the disc has been erased, **Complete** appears then **Blank Disc** will appear on the display.

Refreshing a disc

Refreshing the disc makes a disc usable again. This operation destroys all data on the disc.

- 1 Load the disc, and the unit in stop mode, press the **ERASE/DEL** key on the front panel or the **ERASE** key on the remote control. Select the **REFRESH?** rotating the **MULTI JOG** dial or pressing the **SKIP** keys on the remote control.

To cancel the operation at this point, press the **ERASE/DEL** or the **ERASE** key again.

- 2 Push the **MULTI JOG** dial or press the **ENTER** key on the remote control to enter the function.

The display shows **Sure?**

To cancel the operation at this point, press the **STOP** key.

- 3 Push the **MULTI JOG** dial or press the **ENTER** key again to proceed the operation.

The display shows the **Erase** flashing and the remaining time. The unit starts counting down from a time shown on the display.

- 4 When the disc has been refreshed, **Complete** will appear on the display, and **Blank disc** shows up.

7–Titling

Titles can be given to the disc and the tracks on the disc, using the TEXT EDIT option on the TEXT sub-menu.

NOTE

After the title is selected and entered on the disc, and TOC lights up on the display, if the power is turned off, the TOC will not be recorded onto the disc, and the titles will not be added.

Title input operation

Follow the guidelines below to input titles on the screen. Operate them when in the text edit mode.

It is more efficient to connect a keyboard for title input (refer to “Title input by keyboard” on page 29).

- **Select the type of character for input**

Press the **DISPLAY** key on the unit or the remote control to select from two different types of characters.

Lower case letters/code: no indication

Capital letters/code: CAPS

- **Input procedure**

Rotate the **MULTI JOG** dial or the **SKIP** keys on the remote control to get the desired characters on the display.

Push the **MULTI JOG** dial or press the **ENTER** key on the remote control to enter.

- **To move the cursor position**

Use the **◀◀/◀** key and the **▶▶/▶** key on the front panel, or the **SEARCH** key on the remote control.

- **To delete characters**

Place the cursor on the character, then press the **ERASE/DEL** key on the front pane, or the **ERASE** key on the remote control.

- **To insert characters**

Move the cursor to the location where you wish to insert a character, and press the **FINALIZE/INS** key on the front panel or the **FINALIZE** key on the remote control.

- **To change a character**

Place the cursor on the character to be changed, then input the desired character.

NOTE

- *As with the TEXT menu, after the name is set, if the disc is tried to eject without writing TOC on the disc, the display will show **Sure? Text!**. If you want to eject the disc without TOC writing, press **OPEN/CLOSE** key during the **Sure? Text!** is shown on the display. The text that have been edited or entered will be erased.*
- *The disc or track title of the finalized disc cannot be edited. Unfinalizing (CD-RW only) is needed to operate the title input function.*

Disc title input

- 1 During stop, select the TEXT EDIT option in the TEXT sub-menu (refer to “Operation basic” on page 14).

Text> Disc will appear.

- 2 Press the **MULTI JOG** dial or the **ENTER** key on the remote control.

Now, you can input or edit the disc title following the guidelines above.

- 3 Press the **MENU** key to enter.

If you want to cancel, press the **STOP** key.

Track title input

- 1 During stop, select the TEXT EDIT option in the TEXT sub-menu (refer to “Operation basic” on page 14).

- 2 Rotate the **MULTI JOG** dial or repeatedly press the **SKIP** keys on the remote control to select the track number you desire to title.

- 3 Push the **MULTI JOG** dial or press the **ENTER** key on the remote control.

Now, you can input or edit the track title following the guidelines above.

- 4 Press the **MENU** key to enter.

If you want to cancel, press the **STOP** key.

A computer keyboard can be connected to the IBM PC compatible PS/2 interface on the front panel to operate

certain functions of the CD-RW900. It is particularly efficient for title input.

Keyboard type setting

The CD-RW900 must be set for the type of keyboard being connected.

Set the type using the sub-menu **KEYBOARD** option

on the **SYSTEM** sub-menu. Select **US** for an English-language keyboard, or **JP** for a Japanese-language keyboard.

Title input by keyboard

Titles can be input just like typing on a PC.

- **To enter the Title Edit menu**
Press SHIFT + F8 to enter the Disc/Track Title Edit Menu.
- **To select the type of characters for input**
Press CAPS to select or cancel upper case letters
- **To input characters**
Character input is performed directly with the letter and number keys.
- **To move the cursor**
Use the cursor arrow keys

- **To delete characters**
Delete key: deletes the character in the cursor position
Back space key: deletes the character before the cursor position
- **To insert a character**
Use the Insert key.
- **To change a character**
Put the cursor on its position and input the desired character.

Other keyboard operations

The keyboard can be used not only for title input, but also to control the deck transports, perform editing functions and other operations. The list below shows the keys that perform various operations.

Keyboard key	Operation
F1	same as pressing the ◀◀ key
F2	same as pressing the ▶▶ key
F3	operates the Key control on or off
F4	same as pressing the STOP key
F5	same as pressing the PLAY key
F6	same as pressing the READY key
F7	
F8	same as pressing the RECORD key
F9	
F10	same as pressing the REPEAT key
F11	same as pressing the PLAY MODE key
F12	same as pressing the PITCH key
SHIFT + F1	direct to the “ERASE TRACK?”
SHIFT + F2	direct to the “ERASE DISC?”
SHIFT + F3	direct to the “REFRESH?”
SHIFT + F4	
SHIFT + F5	
SHIFT + F6	
SHIFT + F7	
SHIFT + F8	direct to the “TEXT EDIT?”
SHIFT + F9	
SHIFT + F10	
SHIFT + F11	direct to the “UNFINALIZE?”
SHIFT + F12	direct to the “FINALIZE?”

CTRL + F1	Direct track search TRACK 1
CTRL + F2	Direct track search TRACK 2
CTRL + F3	Direct track search TRACK 3
CTRL + F4	Direct track search TRACK 4
CTRL + F5	Direct track search TRACK 5
CTRL + F6	Direct track search TRACK 6
CTRL + F7	Direct track search TRACK 7
CTRL + F8	Direct track search TRACK 8
CTRL + F9	Direct track search TRACK 9
CTRL + F10	Direct track search TRACK 10
CTRL + F11	Direct track search TRACK 11
CTRL + F12	Direct track search TRACK 12
CAPS	select or cancel upper case letters
← / →	to move the cursor
Delete	Same as the DEL/CLR key
Back space	deletes the character before the cursor
Insert	same as the FINALIZE/INS key
ESC	cancel edit or title edit and finish Menu mode
Enter	same as the ENTER key

8-Reference and specifications

Error messages

Message	Details / response
Can't Rec!	Cannot record. Either erase the contents of the disc (for a CD-RW), or use a different recordable disc.
Disc Error!	The disc has malfunctioned. Please replace with a new disc.
Disc Full!	No recording time remaining, or no recordable track is left on the disc.
Text Full!	No space to input the letters.
Sure? Text!	The text data is not written on the disc yet. Open the tray to cancel the text you enter or operate finalization to write the data on the disc.
Drive Error!	There is a problem in the drive.
D-IN UNLOCK!	The digital input is not connected. Turn on the power of the equipment connected to DIGITAL IN.
Not Audio!	There is no audio signal from DIGITAL IN.
Erase Error!	An error occurred while erasing.
Not Fs44.1k!	The sampling frequency of the digital input is not 44.1 kHz. Please turn the SRC on.
PGM Empty!	There is no program.
PGM Full!	Now new programs can be created.
Can't Edit!	Editing cannot be performed due to operational restrictions.
Can't sel!	Menu selection cannot be performed due to selection prohibitions.
Rec Error!	There was an error during recording. Please re-record.
No DIR!	There is no directory that contains a file.
Decode Err!	The MP3 file cannot be played back.
Format Err!	The disc has been formatted that the CD-RW900 cannot read.

Messages during operations

Message	Statement
Blank Disc	A blank recordable disc has been inserted.
Complete	An operation such as finalize or erase has been successfully completed.
Now OPC (OPC=Optium power Control)	Calibration is being performed to operate recording properly.
Disc Repair	The disc failed to write PMA is being repaired, and this operation will be a long-running. Please do not turn off the power of the CD-RW900 during this operation.
PMA Writing (PMA=Program memory Area)	The recorded content is being written to the disc.
TOC reading	The table of contents data is being read.

Troubleshooting

Symptom	Possible cause and remedy
There is no power to the unit.	Please check the power cord is properly plugged in.
"Disc Error!" is displayed.	The disc may be dirty. Please replace the disc.
Playback is not possible.	This may be due to condensation. In this case, remove the disc, turn the power on and wait a few hours, then try again.
No sound is output.	Confirm the connections with the audio system. Check the volume level, and proper amplifier operation.
Recording is not possible.	Confirm the connections with the audio system. Adjust the recording level. The disc may be for playback only. Please replace with a recordable disc.
Noise or static can be heard.	Please re-position the unit away from strong source of magnetism such as a television.
The CD-RW900 does not retain settings.	While settings are retained each time they are made, in some cases they will not be retained when the power is turned off too soon. To prevent this from happening, do not turn off the power right after making a setting.

8-Reference and specifications

Specifications

Recordable discs	CD-R, CD-R-DA, CD-RW, CD-RW-DA (High speed CD-RW is supported)	
Quantization bit depth	16 bit	
Sampling frequency	44.1 kHz	
Frequency response	20 Hz~20 KHz	
S/N	95 dB 90 dB	
Dynamic range	95 dB 90 dB	
Distortion	0.006 % 0.008 %	
Channel separation	90 dB 80 dB	
Wow and flutter	(0.001 %)	
Analog inputs	Unbalanced input RCA pin level -10 dBV Minimum input level -19 dBV Input impedance 22 k Ω \pm 10 %	
Analog outputs	Unbalanced output RCA pin level -10 dBV Maximum output level +6 dBV 2 dB Output impedance 600 Ω \pm 10%	
Phones output	Stereo (6.3) 20 mW 32 Ω	
Digital input	Coaxial RCA pin jack (IEC-60958 Consumer use) Optical TOSLINK (IEC-60958 Consumer use)	
Digital output	Coaxial RCA pin jack (IEC-60958 Consumer use) Optical TOSLINK (IEC-60958 Consumer use)	
Keyboard	Mini DIN 6 pin	
Power	U.S.A./Canada	120VAC, 60Hz
	U.K./Erope	230VAC, 50Hz
	Australia	240VAC, 50Hz
Power consumption	16 W	
Dimensions	w x h x d 482.6 x 94 x 307.6 (mm)	
Weight	4.9 kg (10.8 lb)	

Dimensional drawing

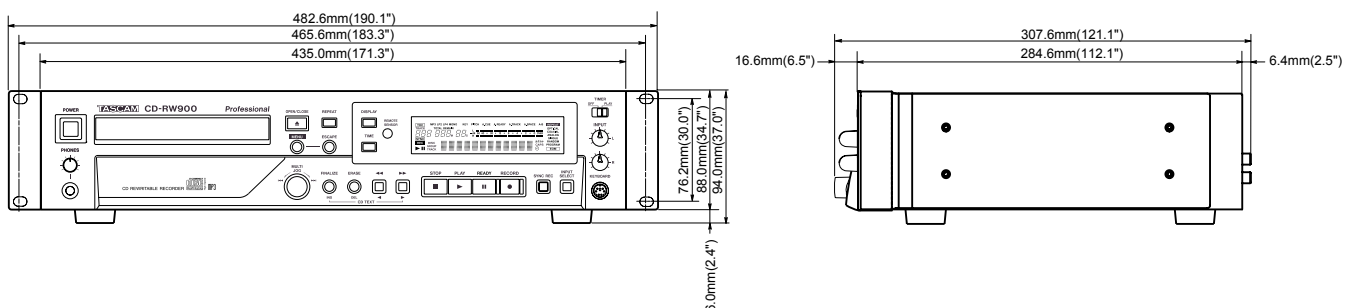

TASCAM

TEAC Professional Division

CD-RW900

TEAC CORPORATION

Phone: +81-422-52-5082

3-7-3, Nakacho, Musashino-shi, Tokyo 180-8550, Japan

www.tascam.com

TEAC AMERICA, INC.

Phone: +1-323-726-0303

7733 Telegraph Road, Montebello, California 90640

www.tascam.com

TEAC CANADA LTD.

Phone: +1905-890-8008 Facsimile: +1905-890-9888

5939 Wallace Street, Mississauga, Ontario L4Z 1Z8, Canada

www.tascam.com

TEAC MEXICO, S.A. De C.V

Phone: +52-555-581-5500

Campesinos No. 184, Colonia Granjes Esmeralda, Delegacion Iztapalapa CP 09810, Mexico DF

www.tascam.com

TEAC UK LIMITED

Phone: +44-8451-302511

Unit 19 & 20, The Courtyards Hatters Lane Watford, Hertfordshire. WD18 8TE, U.K.

www.tascam.co.uk

TEAC EUROPE GmbH

Phone: +49-611-71580

Bahnstrasse 12, 65205 Wiesbaden-Erbenheim, Germany

www.tascam.de

TEAC ITALIANA S.p.A.

Phone: +39-02-66010500

Via C. Cantu 11, 20092 Cinisello Balsamo, Milano, Italy

www.teac.it