

TASCAM

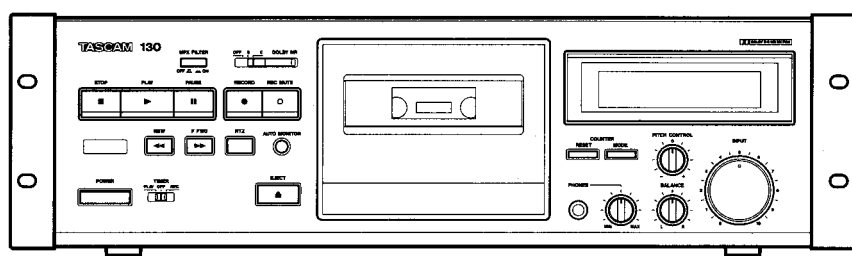

TEAC Professional Division

130

Stereo Cassette Deck



OWNER'S MANUAL

 **CAUTION**
RISK OF ELECTRIC SHOCK
DO NOT OPEN  **CAUTION: TO REDUCE THE RISK OF ELECTRIC SHOCK, DO NOT REMOVE COVER (OR BACK). NO USER-SERVICEABLE PARTS INSIDE. REFER SERVICING TO QUALIFIED SERVICE PERSONNEL.**

 The lightning flash with arrowhead symbol, within an equilateral triangle, is intended to alert the user to the presence of uninsulated "dangerous voltage" within the product's enclosure that may be of sufficient magnitude to constitute a risk of electric shock to persons.

 The exclamation point within an equilateral triangle is intended to alert the user to the presence of important operating and maintenance (servicing) instructions in the literature accompanying the appliance.

This appliance has a serial number located on the rear panel. Please record the model number and serial number and retain them for your records.
 Model number _____
 Serial number _____

WARNING: TO PREVENT FIRE OR SHOCK HAZARD, DO NOT EXPOSE THIS APPLIANCE TO RAIN OR MOISTURE.

IMPORTANT SAFETY INSTRUCTIONS

CAUTION:

- Read all of these Instructions.
- Save these Instructions for later use.
- Follow all Warnings and Instructions marked on the audio equipment.

- 1) **Read Instructions** — All the safety and operating instructions should be read before the product is operated.
- 2) **Retain Instructions** — The safety and operating instructions should be retained for future reference.
- 3) **Heed Warnings** — All warnings on the product and in the operating instructions should be adhered to.
- 4) **Follow Instructions** — All operating and use instructions should be followed.
- 5) **Cleaning** — Unplug this product from the wall outlet before cleaning. Do not use liquid cleaners or aerosol cleaners. Use a damp cloth for cleaning.
- 6) **Attachments** — Do not use attachments not recommended by the product manufacturer as they may cause hazards.
- 7) **Water and Moisture** — Do not use this product near water — for example, near a bath tub, wash bowl, kitchen sink, or laundry tub; in a wet basement; or near a swimming pool; and the like.
- 8) **Accessories** — Do not place this product on an unstable cart, stand, tripod, bracket, or table. The product may fall, causing serious injury to a child or adult, and serious damage to the product. Use only with a cart, stand, tripod, bracket, or table recommended by the manufacturer, or sold with the product. Any mounting of the product should follow the manufacturer's instructions, and should use a mounting accessory recommended by the manufacturer.
- 9) A product and cart combination should be moved with care. Quick stops, excessive force, and uneven surfaces may cause the product and cart combination to overturn.



- 10) **Ventilation** — Slots and openings in the cabinet are provided for ventilation and to ensure reliable operation of the product and to protect it from overheating, and these openings must not be blocked or covered. The openings should never be blocked by placing the product on a bed, sofa, rug, or other similar surface. This product should not be placed in a built-in installation such as a bookcase or rack unless proper ventilation is provided or the manufacturer's instructions have been adhered to.
- 11) **Power Sources** — This product should be operated only from the type of power source indicated on the marking label. If you are not sure of the type of power supply to your home, consult your product dealer or local power company. For products intended to operate from battery power, or other sources, refer to the operating instructions.
- 12) **Grounding or Polarization** — This product may be equipped with a polarized alternating-current line plug (a plug having one blade wider than the other). This plug will fit into the power outlet only one way. This is a safety feature. If you are unable to insert the plug fully into the outlet, try reversing the plug. If the plug should still fail to fit, contact your electrician to replace your obsolete outlet. Do not defeat the safety purpose of the polarized plug.
- 13) **Power-Cord Protection** — Power-supply cords should be routed so that they are not likely to be walked on or pinched by items placed upon or against them, paying particular attention to cords at plugs, convenience receptacles, and the point where they exit from the product.
- 14) **Outdoor Antenna Grounding** — If an outside antenna or cable system is connected to the product, be sure the antenna or cable system is grounded so as to provide some protection against voltage surges and built-up static charges. Article 810 of the National Electrical Code, ANSI/NFPA 70, provides information with regard to proper grounding of the mast and supporting structure, grounding of the lead-in wire to an antenna discharge unit, size of grounding conductors, location of antenna-discharge unit, connection to grounding electrodes, and requirements for the grounding electrode.

"Note to CATV system installer:

This reminder is provided to call the CATV system installer's attention to Section 820-40 of the NEC which provides guidelines for proper grounding and, in particular, specifies that the cable ground shall be connected to the grounding system of the building, as close to the point of cable entry as practical.

Example of Antenna Grounding as per National Electrical Code, ANSI/NFPA 70

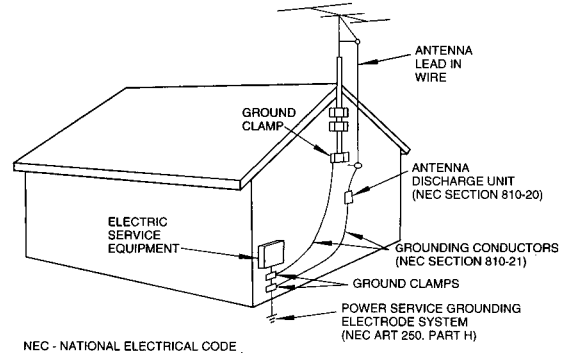

- 15) **Lightning** — For added protection for this product during a lightning storm, or when it is left unattended and unused for long periods of time, unplug it from the wall outlet and disconnect the antenna or cable system. This will prevent damage to the product due to lightning and power-line surges.
- 16) **Power Lines** — An outside antenna system should not be located in the vicinity of overhead power lines or other electric light or power circuits, or where it can fall into such power lines or circuits. When installing an outside antenna system, extreme care should be taken to keep from touching such power lines or circuits as contact with them might be fatal.
- 17) **Overloading** — Do not overload wall outlets, extension cords, or integral convenience receptacles as this can result in risk of fire or electric shock.
- 18) **Object and Liquid Entry** — Never push objects of any kind into this product through openings as they may touch dangerous voltage points or short-out parts that could result in a fire or electric shock. Never spill liquid of any kind on the product.
- 19) **Servicing** — Do not attempt to service this product yourself as opening or removing covers may expose you to dangerous voltage or other hazards. Refer all servicing to qualified service personnel.
- 20) **Damage Requiring Service** — Unplug this product from the wall outlet and refer servicing to qualified service personnel under the following conditions:
 - a) when the power-supply cord or plug is damaged.
 - b) if liquid has been spilled, or objects have fallen into the product.
 - c) if the product has been exposed to rain or water.
 - d) if the product does not operate normally by following the operating instructions. Adjust only those controls that are covered by the operating instructions as an improper adjustment of other controls may result in damage and will often require extensive work by a qualified technician to restore the product to its normal operation.
 - e) if the product has been dropped or damaged in any way.
 - f) when the product exhibits a distinct change in performance — this indicates a need for service.
- 21) **Replacement Parts** — When replacement parts are required, be sure the service technician has used replacement parts specified by the manufacturer or have the same characteristics as the original part. Unauthorized substitutions may result in fire, electric shock, or other hazards.
- 22) **Safety Check** — Upon completion of any service or repairs to this product, ask the service technician to perform safety checks to determine that the product is in proper operating condition.
- 23) **Wall or Ceiling Mounting** — The product should be mounted to a wall or ceiling only as recommended by the manufacturer.
- 24) **Heat** — The product should be situated away from heat sources such as radiators, heat registers, stoves, or other products (including amplifiers) that produce heat.

Reference Illustrations

Fig. 1
Front Panel

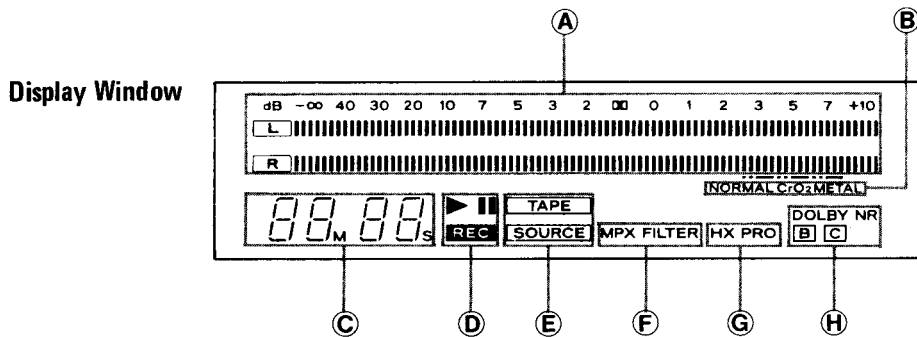
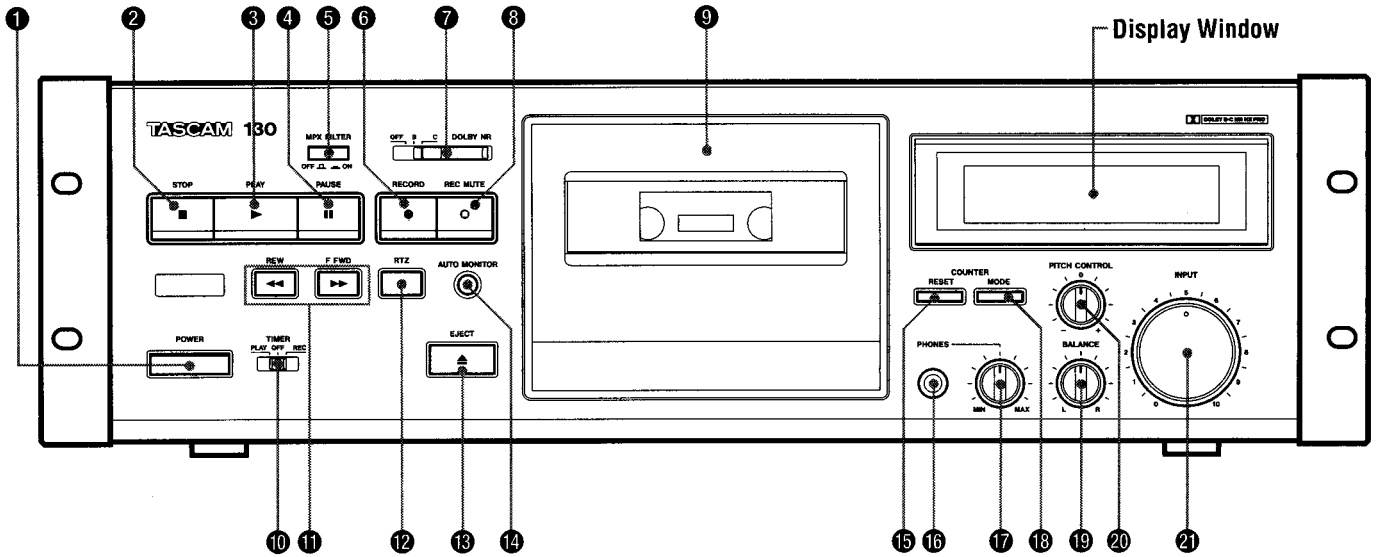

Rear Panel

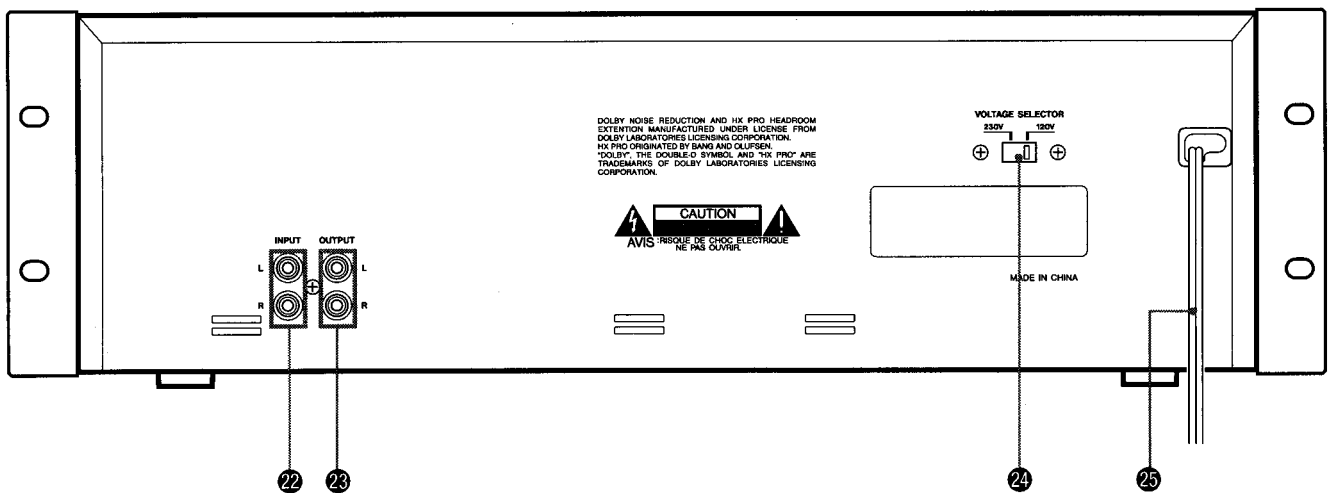

Fig. 2

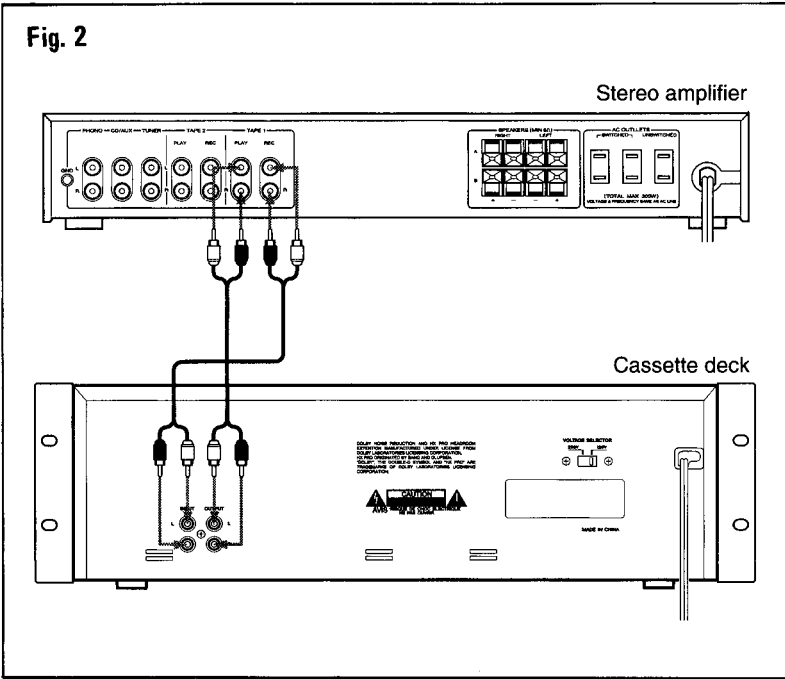

Fig. 3

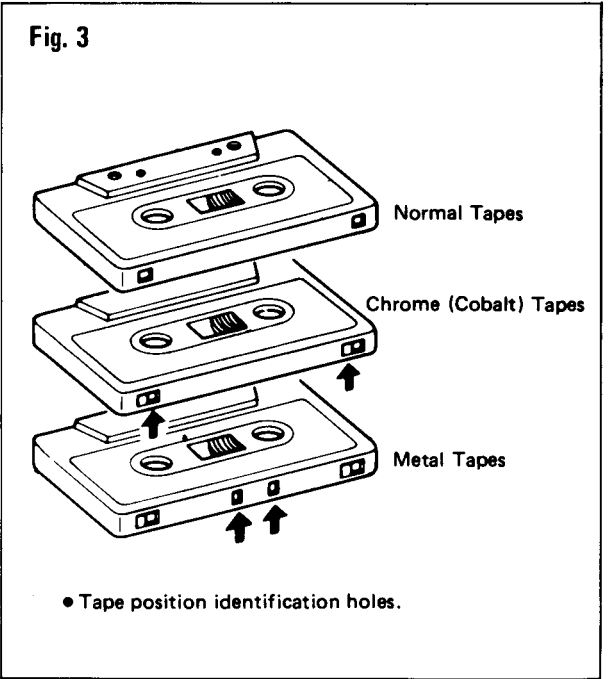

Fig. 4

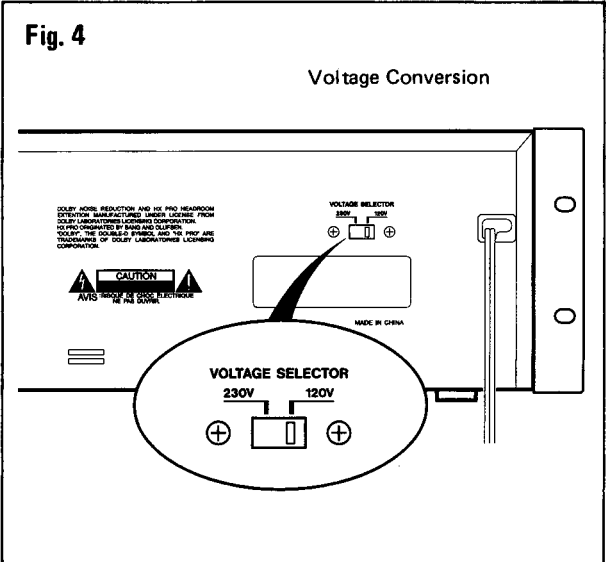

Fig. 5

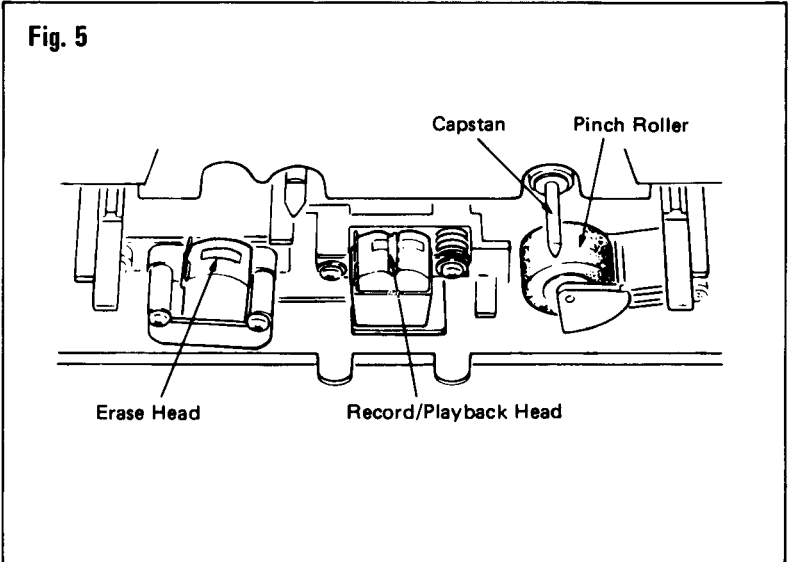
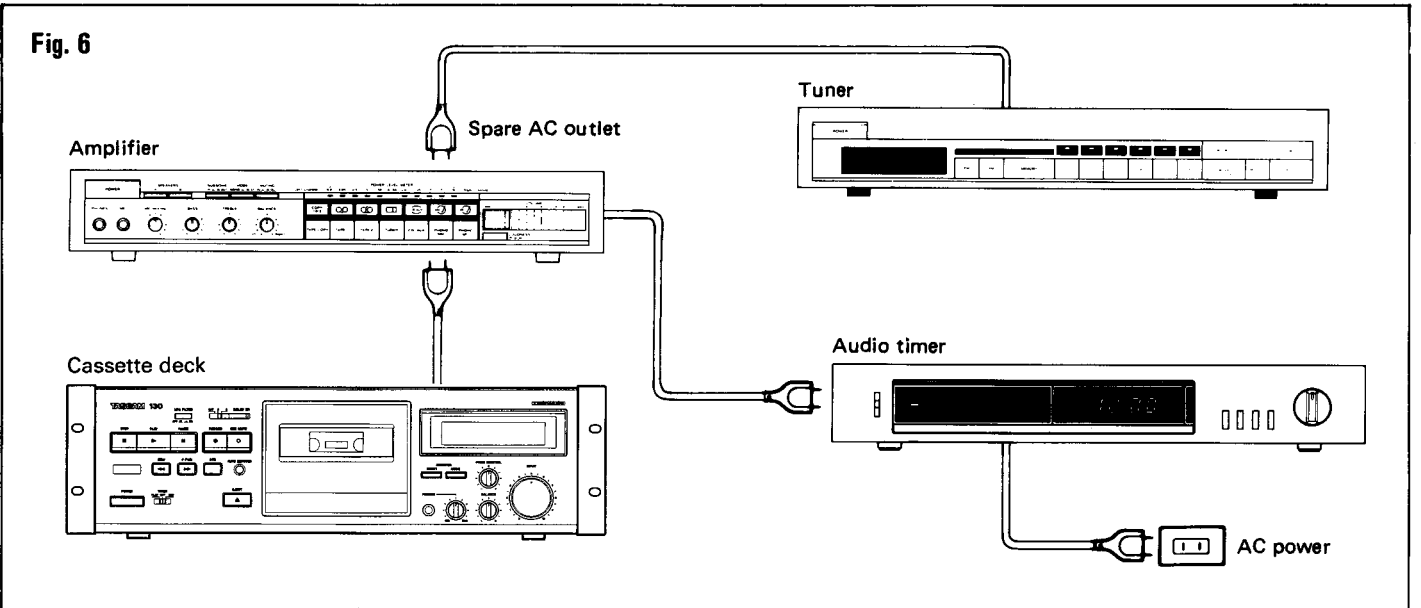

Fig. 6



Precautions

Environment

Avoid using the deck in the following circumstances:

- High temperature (such as heater, direct sunlight).
- Extremely low temperature.
- Excessive humidity.
- Dusty atmosphere.
- Where power line voltage fluctuation is severe (the use of a voltage regulator may be advisable).
- Be aware also that placing other units or any objects on the deck can leave marks depending on their weight.

Cassette Tape (Fig. 3)

Tape Selection:

For the automatic tape select function to work properly, metal and chrome (cobalt) formula tapes must have tape identification holes.

C-120 cassette tapes:

120-minute tapes are very thin, they tend to stretch and their magnetic layer is thin; they also tend to introduce wow & flutter. For these reasons, special attention is required when using them. If the pinch roller or capstan is dirty, tape might become wrapped around it and this could cause serious trouble. For this reason, it is recommended that you do not use C-120 tapes.

Tape Handling:

Do not store tape in the following places:

- On top of heaters, in direct sunlight or in any other high-temperature areas.
 - Near speakers, on TV sets or amplifiers or near any strong magnetic fields.
 - High-humidity areas or dirty, dusty areas.
- Avoid dropping or subjecting the cassettes to excessive shock.

Voltage Conversion (For general export models) (Fig. 4)

Be sure to remove the power cord from the AC outlet before repositioning the voltage converter switch.

1. Locate the voltage selector on the rear panel.
2. Using a flat-bladed screwdriver, set to the appropriate 230 V or 120 V position according to your area.

Connections (Fig. 2)

- Turn off power for all equipment before making connections.
- Read instructions for each component you intend to use with the deck.

IMPORTANT (for U.K. customers)

DO NOT cut off the mains plug from this equipment. If the plug fitted is not suitable for the power points in your home or the cable is too short to reach a power point, then obtain an appropriate safety approved extension lead or consult your dealer.

If nonetheless, the mains plug is cut off, remove the fuse and dispose of the plug immediately, to avoid a possible shock hazard by inadvertent connection to the mains supply.

If this product is not provided with a mains plug, or one has to be fitted, then follow the instructions given below:

IMPORTANT. DO NOT make any connection to the larger terminal which is marked with the letter E or by the safety earth symbol \perp or coloured GREEN or GREEN-and-YELLOW.

The wires in the mains lead on this product are coloured in accordance with the following code:

BLUE : NEUTRAL
BROWN : LIVE

As these colours may not correspond with the coloured markings identifying the terminals in your plug proceed as follows: The wire which is coloured BLUE must be connected to the terminal which is marked with the letter N or coloured BLACK. The wire which is coloured BROWN must be connected to the terminal which is marked with the letter L or coloured RED.

When replacing the fuse, only a correctly rated approved type should be used and be sure to re-fit the fuse cover.

IF IN DOUBT — CONSULT A COMPETENT ELECTRICIAN.

- * Dolby noise reduction and HX Pro headroom extension manufactured under license from Dolby Laboratories Licensing Corporation. HX Pro originated by Bang & Olufsen.
"DOLBY", the double-D symbol $\square\square$ and "HX PRO" are trademarks of Dolby Laboratories Licensing Corporation.

Features and Controls (Fig. 1)

Front Panel

① POWER Switch

Press to switch the deck on. The display window will be illuminated. Press again to turn the deck off.

Note: Be sure to wait more than 2 seconds after the power has been switched off before switching the power on again.

② STOP Button

Press to stop the tape travel and release any other mode.

③ PLAY Button

Pressing this button starts normal-speed playback.

④ PAUSE Button

Press to temporarily stop tape travel during recording or playback. In the pause mode, the PAUSE indicator in the display lights. Press the PLAY button or PAUSE button again to restart the tape (the indicator goes out).

⑤ MPX FILTER Switch

Press this switch when making a Dolby NR recording of an FM broadcast; the indicator lights. It eliminates the pilot tone (19 kHz) and subcarrier tone (38 kHz) of the FM broadcast which could affect operation of the Dolby noise reduction system. To release this function, press the MPX FILTER switch again.

⑥ RECORD Button

Press the RECORD button to set the deck to the record-pause mode. The REC and PAUSE indicators will light. To start recording, press the PLAY button or PAUSE button.

⑦ DOLBY NR Switch

OFF: Set to this position when you do not want to use any noise reduction system.

B: Set to this position when making a recording using the Dolby B noise reduction system, or playing back tapes recorded with Dolby B NR.

C: Set to this position when making a recording using the Dolby C noise reduction system, or playing back tapes recorded with Dolby C NR.

⑧ REC MUTE Button

Press this button during recording to leave a blank section between tunes (approx. 4 seconds). The deck will enter the record-pause mode. Press the PLAY button or PAUSE button to start recording again. (See page 7.)

⑨ Cassette Holder

Load the cassette here.

10 TIMER Switch

PLAY: For timer playback

OFF: Set to this position when not using a timer.

REC: For timer recording
(See page 8.)

11 ◀◀ REW (Rewind) Button / ▶▶ F FWD (Fast-Forward) Button

When these buttons are pressed, the tape is rewound or fast-forwarded.

12 RTZ (Return to Zero) Button

If this button is pressed, the tape is fast-forwarded or rewound until a tape counter reading of "0000" is reached, then the deck stops. (See page 8.)

13 EJECT Button

Press in the stop mode to open the cassette holder. Do not press this button when the deck is in the recording or playback mode.

14 AUTO MONITOR Button

This button allows you to select which signal is to be monitored with its level displayed on the meter. When power is applied to the deck, the monitor mode is set to TAPE, showing that the signal recorded on the tape is monitored with its level displayed by the meter. When the deck enters the record-pause mode, the monitor mode is automatically switched to SOURCE, showing the signal input to the deck (from the INPUT jacks on the rear panel) is monitored with its level displayed. And when the record-pause mode is released, it is automatically changed to TAPE. To manually change the monitor mode, press this button.

15 RESET Button

Pressing the RESET button resets the multi-counter to "0000".

16 PHONES Jack

Connect 8-ohm stereo headphones to this jack for private listening or monitoring.

17 PHONES level Control

Adjust the level of the signals output from the PHONES jack. This knob does not affect the level of the signals output from the OUTPUT jacks on the rear panel or the level indicated by the peak level meter.

18 MODE Button

When this button is pressed, the display alternates between the conventional tape counter and the TRT (tape-run-time) counter.

19 BALANCE Control

Adjust the balance of the left and right channels of the input signals to be recorded on tape.

20 PITCH CONTROL

You can change the tape speed during playback, allowing to change the pitch of the reproduced sound.

By turning the PITCH CONTROL to the right, the tape speed becomes faster, resulting in higher pitch. By turning it to the left, the tape speed becomes slower, resulting in lower pitch.

- At the fully clockwise position, the tape speed is approx. 10% faster.
- At the fully counterclockwise position, the tape speed is approx. 10% slower.

21 INPUT level Control

When recording, turn the INPUT level control clockwise to fade the input sound in or turn it counterclockwise to fade the sound out, for smooth tune-to-tune transitions.

Display Window

A Peak Level Meter

This meter shows the peak level of the input or playback signal. In the record mode, the meter indicates the level of the source signals which have been adjusted with the INPUT level and BALANCE controls. During playback, the meter indicates the level of signals recorded on the tape.

B Tape Type Indicator

The deck automatically detects the type of tape which has been loaded, and these indicators (NORMAL, CrO₂ and METAL) indicate the type of tape being used.

C Multi-Counter Tape Counter Mode

In this mode, the counter functions as a conventional tape counter, counting up when the tape is moving forward and down when the tape is being rewound. The display can be cleared by pressing the RESET button, which resets the counter index to "0000".

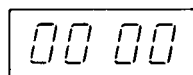

TRT (Tape-Run-Time) Counter Mode

In this mode, tape travel is measured in minutes and seconds up to a maximum of 99M59S (99 minutes 59 seconds). Since this counter only functions in the play and record modes, it will be interrupted when the tape is fast-forwarded or rewound (and, of course, in the stop mode); counting up will be resumed when playback or recording

restarts. The display can be cleared by pressing the RESET button which resets counter index to "00M00S".

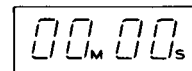

D Transport Mode Indicators

REC: Lights when the deck is in the record and record-standby modes, and flashes during record-muting.

▶ (PLAY): Lights when the deck is in the playback and record modes.

|| (PAUSE): Lights when the deck is standing by for playback or recording.

E Auto Monitor Indicators

TAPE: Lights when the tape signal is selected either in playback or record.

SOURCE: Lights when the source signal is selected.

The Auto Monitor indicators change automatically to the monitor mode so that the SOURCE indicator lights when the deck enters the record-pause mode. When recording starts, the SOURCE indicator automatically goes out and the TAPE indicator lights.

F MPX FILTER Indicator

Lights when the MPX FILTER switch is pressed in ().

G HX PRO Indicator

Lights when the deck enters the record mode, showing that the built-in Dolby HX Pro circuit has been activated. For details, refer to page 9.

H DOLBY NR B C Indicator

Lights when the DOLBY NR switch is set to the B or C position.

Rear Panel

22 INPUT Terminals

Connect the amplifier's REC OUT jacks to these jacks.

23 OUTPUT Terminals

Connect the amplifier's TAPE PLAY or LINE IN jacks to these jacks.

24 Voltage Selector (General Export Models Only)

See "Voltage Conversion" on page 5.

25 Power Supply Cord

Insert into an AC wall outlet, etc. The voltage required by this unit is shown on the rear panel.

Operations

Playback and Recording

Stereo Playback

1. Set the **TIMER** switch to **OFF**.
2. Press the **POWER** switch to **ON**.
3. Load a pre-recorded cassette.
4. Select the **NR** system with the **DOLBY NR** switch.
5. Press the **PLAY** button to start playback.
6. Adjust the volume with the amplifier's control.

Stereo Recording

1. Set the **TIMER** switch to **OFF**.
2. Press the **POWER** switch to **ON**.
3. Load a recordable cassette.
4. Select the required **NR** system with the **DOLBY NR** switch.
5. Press the **MPX FILTER** switch to **IN** when making a Dolby NR recording of an FM broadcast.
6. Press the **RECORD** button (both the **REC** and **PAUSE** indicators light). This enables you to adjust the recording level without actually recording on the tape.
7. Adjust the **INPUT** level and **BALANCE** controls so that the loudest peak briefly reaches the meter reference reading for the type of tape used for both channels.

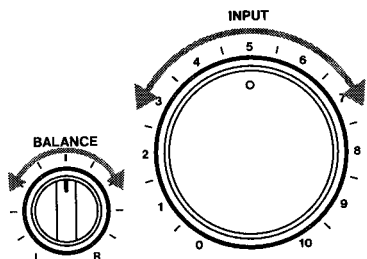

8. Press the **PLAY** button or **PAUSE** button to start recording. The **REC** and **PLAY** indicators light.

The **Auto Monitor** indicator is automatically changed to **TAPE** and the signal can be directly monitored immediately after it is recorded. To compare the recorded sound with the original source, press the **AUTO MONITOR** button to switch the signal being monitored between **TAPE** and **SOURCE**.

AUTO MONITOR



Notes:

- To stop recording, press the **STOP** button.
- To momentarily stop recording, press the **PAUSE** button. To resume recording, press the **PLAY** button or **PAUSE** button.

Note:

Recording prerecorded tapes, records, or other published or broadcast material may infringe copyright laws. Check these laws before recording.

Setting the Recording Level

Setting the recording level correctly is essential if you want to make top-quality recordings. If the level is too low, the recording will be noisy. If the level is set too high, the recording will be distorted. Generally speaking, the recording level should be set so that the loudest peak to be recorded makes the meters briefly indicate the meter reference reading for the type of tape used. If the meters peak over the reference reading, decrease the recording level by turning the **INPUT** level control counterclockwise. However, some program material or different tape formulations may require higher or lower recording levels. With a little time and practice you will be able to select the critical recording level that gives you the best hi-fi recordings. The optimum setting of the recording level will differ according to the type and condition of the tape, as well as the type of music you are recording.

Erasing

A previously recorded tape will be automatically erased when you make a new recording on it. Alternatively it can be erased by "recording" on it with the **INPUT** level control set to "0".

Record Muting Operation

The ability to leave blank unrecorded (erased) portions on a tape during recording is a real advantage in many recording situations. For instance, you may want to eliminate undesired portions of an FM broadcast that you are recording, such as commercials, station breaks or announcements. You may want to record a complete program with controlled spacing between each song. Such blank portions on a tape can be easily left using the **REC MUTE** function.

- **Automatic Spacing operation — for a 4-second blank — (during recording or record-pause mode)**

Press the **REC MUTE** button during the recording or record-pause mode. The tape continues to run, and a blank space of about 4 seconds is recorded (the **REC** indicator flashes).

The deck then switches automatically to the record-pause mode (both the **REC** and **PAUSE** indicators light). To start recording the next tune, press the **PLAY** button or **PAUSE** button (both the **REC** and **PLAY** indicators light).

- **For a Blank of More Than 4 Seconds**

During recording, keep the **REC MUTE** button pressed for a longer blank period. Release the button to enter the record-pause mode. To begin recording, press the **PLAY** button or **PAUSE** button.

- **For a Blank of Less Than 4 Seconds**

After pressing the **REC MUTE** button during recording, press the **PAUSE** button, before the 4-second interval has elapsed, to cancel the muting mode and engage the record-pause mode. To begin recording, press the **PLAY** button or **PAUSE** button.

Multi-Counter Function

With the multi-counter facilities incorporated in the unit, there are two different display modes available, depending on the setting of the **MODE** button.

Tape Counter Mode: The counter functions as a conventional tape counter.

TRT Counter mode: The counter functions as a tape-run-time counter, measuring tape travel in minutes and seconds.

Using as a Tape Counter

Using the **MODE** button, call up the tape counter mode; a 4-digit display will appear. Its function is identical to that of a conventional tape indexing counter. During recording (including record muting), playback and fast-forward, the counter counts up as the tape moves from left to right, and down during rewind as the tape moves from right to left. The indicated numerals are not related to elapsed time and are not compatible with the counter readings of other cassette decks. One typical example of using this display in the conventional tape counter mode is: First load a cassette and before recording, press the **RESET** button to reset the counter to "0000". Then note the counter reading at the beginning of each piece of music to facilitate locating that particular selection when you wish to play it back.

Using as a TRT Counter

Using the MODE button, call up the tape-run-time mode; "M" appears between the 2nd and 3rd digits and "S" at the end of the 4th digit. In this mode, tape travel is measured in minutes and seconds while the tape is running at normal speed during recording (including record muting) and playback. Counting stops during rewind and fast-forward. This function can be used to measure the approximate length of a recorded song or to make an estimate of how much tape is left.

"Visible" and "Invisible" Counters

Both counter modes are switchable at any time, with the one selected appearing on the display and the other functioning in memory. For example, when the conventional tape counter is selected with the MODE button, counting of the tape-run-time also takes place and its reading can be called up at any time by pressing the MODE button. Pressing the RESET button resets only the counter which is currently displayed. Both counters, "visible" and "invisible" are reset when power is switched off.

RTZ (Return To Zero) Function

To locate the position on the tape corresponding to a tape counter reading of "0000", press the RTZ button. The fast-forward or rewind of the tape starts. When a counter reading of "0000" is detected, the deck stops.

This function is handy to locate the beginning of tune to be played back.

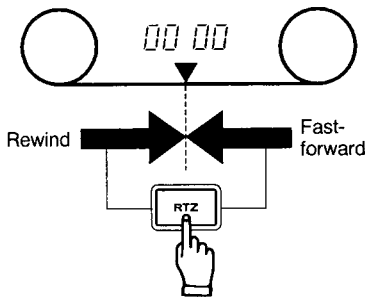

To start playback from "0000":

While the tape is running after the RTZ button is pressed, press the PLAY button. The deck temporarily stops at the "0000" counter reading, then playback starts.

To release the RTZ function:

Press the STOP button. If the ◀◀ (rewind) or ▶▶ (fast-forward) button is pressed while the tape is running after the RTZ button is pressed, the RTZ function is released, and the deck enters the normal rewind or fast-forward mode.

* The RTZ button cannot be used when the deck is in the recording mode or near the "0000" counter reading.

Timer-Controlled Operations (Fig. 6)

Timer-Controlled Recording

1. Connect your deck and stereo system to a commercially available audio timer as shown in the diagram.
2. Make all the preparations as for normal recording, but leave the deck in the stop mode.
3. Set the audio timer to the required start (power on) and stop (power off) times.
4. Set the TIMER switch on the deck to REC.

When the preset start time is reached, power will be supplied and recording will start.

Timer-Controlled Playback

1. Check that the deck is correctly connected to the amplifier for normal playback operation.
2. Connect the deck and amplifier to an audio timer as for timer-controlled recording (above).
3. Make all preparation as for normal playback, but leave the deck in the stop mode.
4. Set the audio timer to the required start (power on) and stop (power off) times.
5. Set the TIMER switch on the deck to PLAY.

When the preset start time is reached, power will be switched on and playback will start.

Note: Be sure to set the TIMER switch to OFF after timer-controlled recording or playback is over.

Maintenance (Fig. 5)

The heads and tape path should be cleaned and demagnetized periodically.

Cleaning Tape Path

● Apply head cleaning fluid* to special cotton swabs or a soft cloth, and lightly rub the heads, capstans and all metal parts in the tape path.

● Also clean the pinch rollers using rubber cleaning fluid*.

* Both are available in TEAC HC-2 and RC-2 in the U.S.A. or TEAC TZ-261 Tape Recorder Cleaning Kit in other areas.

Demagnetizing Heads

Be sure that the power is off, then demagnetize the heads using a TEAC E-3 demagnetizer or equivalent. For details of its use, read its instructions.

Troubleshooting

Basic troubleshooting of a cassette tape deck is similar to troubleshooting any other electrical or electronic equipment. Always check the most obvious possible causes first. To give you a few ideas of what to look for, check the following:

- No power: Is the power cord connected?
- Tape begins running when power is turned on: Is the TIMER function on?
- No audio output: Are all connections properly made?
- Degraded sound quality: Are the heads dirty or magnetized? Are you using good quality tape? Is the proper NR System select switch on?
- Unable to select record mode: Are the record protection tabs on the tape in place?

Rack mounting

Install this deck with the provided mounting screw kit as illustrated.

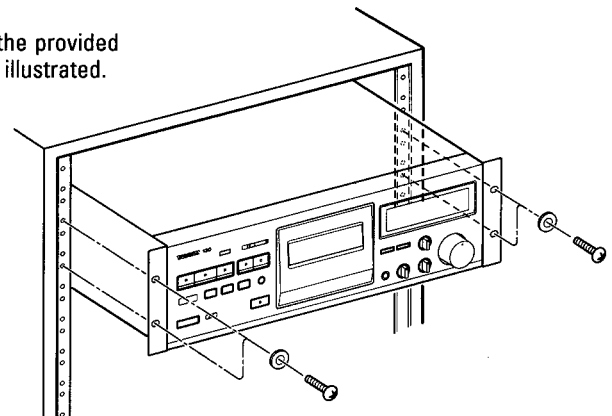

DOLBY HX PRO

Dolby HX Pro is an "active bias" technique that can improve the quality of audio tape recordings. High-level high frequencies can be recorded more accurately, without sacrificing signal-to-noise ratio, while such side effects of tape saturation as distortion are reduced.

What Is Bias?

Bias is a very high-frequency signal generated within a tape deck and recorded on the tape simultaneously with the program material. This inaudible signal allows a low noise, low distortion recording and flat frequency response. Different magnetic tape formulations require different amounts of bias for optimum performance. If the bias level is too high, high-frequency Maximum Output Level (MOL) decreases.

The Problem of Self-Bias

Unfortunately, bias level is often influenced by the signal being recorded. The high frequencies contained in some music act as bias. This unpredictable source of bias is added to the existing bias, resulting in a loss of high-frequency response. As the high-frequency content of the signal increases,

the ability of the recorder to record high frequencies (MOL) decreases. This phenomenon is called self-biasing.

The Dolby HX Pro Solution

The Dolby HX Pro monitors the high-frequency content of the program material and adjusts the recorder bias oscillator to maintain a constant total bias level. The result is improved high-frequency response and lower distortion. Depending on the type of tape, the improvement in headroom can be 6 dB or more.

The Benefits

With Dolby HX Pro, it is easier to make more accurate recordings of the kind of music which contains high-level high frequencies. The improvement is similar to that of high-performance tape over conventional tape, so regardless of the type of tape used, the results will sound better. Most important of all, Dolby HX Pro requires no decoding process. Once the tape is recorded with it, the improvements will be realized when playing the tape back on any machine.

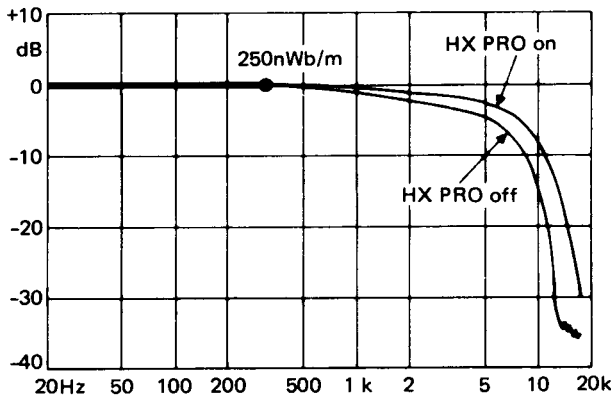

Example of improved frequency response using Dolby HX Pro function

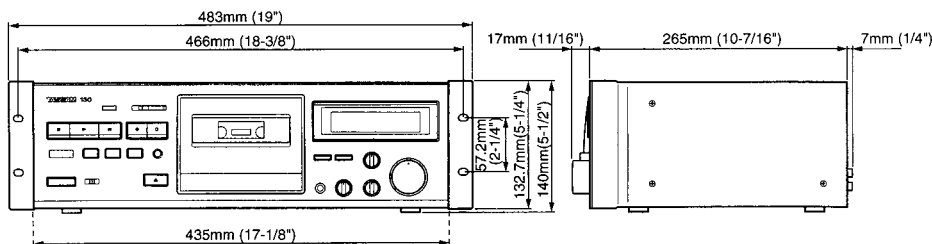

Specifications

- Track System** 4-Track, 2-Channel Stereo
- Heads** 3: 1 Erase, 1 Record and 1 Playback (Combination)
- Type of Tape** Cassette tape C-60 and C-90 (Philips type)
- Tape Speed** 4.8 cm/sec. (1-7/8 ips)
- Motors** 2: 1 DC Servo motor (for capstan drive)
1 DC motor (for reel drive)
- Wow and Flutter** 0.045 % (W. RMS)
- Frequency Response (Overall)** -20 dB
15 - 21,000 Hz ± 3 dB Metal Tape
15 - 20,000 Hz ± 3 dB CrO₂ Tape
15 - 18,000 Hz ± 3 dB Normal Tape
- Signal-to-Noise Ratio (Overall)**
60 dB (NR OFF, 3% THD Level, Weighted)
70 dB (Dolby B In, over 5 kHz)
80 dB (Dolby C In, over 1 kHz)
- Fast Winding Time** Approximately 90 seconds for C-60
- Inputs** Line: 97 mV, 50k ohms
- Outputs** Line: 0.58 V for load impedance of 50k ohms or more
Headphones: 1 mW/8-ohm load
- Power Requirements** 120/230 V AC, 50 - 60 Hz (General export models)
120 V AC, 60 Hz (U.S.A./Canada)
230 V AC, 50 Hz (Europe)
240 V AC, 50 Hz (Australia)
- Power Consumption** 15 W
- Dimensions (W x H x D)**
483 X 140 X 289 mm
(19" X 5-1/2" X 11-3/8")
- Weight** 4.5 kg (9.94 lbs.)
- Standard Accessories**
Rack mounting screw kit

- Specifications were determined using metal tape except as noted.
- Improvements may result in specifications or features changing without notice.
- Photos and illustrations may differ slightly from production models.

Since this unit incorporates micro-computers, it may not operate correctly because of external noise, etc. In such a case, confirm that the TIMER switch is in the OFF position, then switch off the power once for approx. one minute before restarting operation from the beginning.

For U.S.A.

TO THE USER

This equipment has been tested and found to comply with the limits for a Class B digital device, pursuant to Part 15 of the FCC Rules. These limits are designed to provide reasonable protection against interference in a residential area. This device generates and uses radio frequency energy and if not installed and used in accordance with the instructions, it may cause interference to radio or TV reception. If this unit does cause interference with TV or radio reception you can try to correct the interference by one or more of the following measures:

- a) Reorient or relocate the receiving antenna.
 - b) Increase the separation between the equipment and the receiver.
 - c) Plug the equipment into a different outlet so that it is not on the same circuit as the receiver.
- If necessary, consult the dealer or an experienced radio/TV technician for additional suggestions.

CAUTION:

Changes or modifications to this equipment not expressly approved by TEAC CORPORATION for compliance could void the user's authority to operate this equipment.

For CANADA

AC POWER CORD CONNECTION

CAUTION:
TO PREVENT ELECTRIC SHOCK, MATCH WIDE
BLADE OF PLUG TO WIDE SLOT, FULLY INSERT.

CORDE DE CONNEXION CA

ATTENTION:
POUR ÉVITER LES CHOCS ÉLECTRIQUES, INTRO-
DUIRE LA LAME LA PLUS LARGE DE LA FICHE
DANS LA BORNE CORRESPONDANTE DE
LA PRISE ET POUSSER JUSQU'AU FOND.

TEAC CORPORATION

3-7-3, Nakacho, Musashino-shi, Tokyo 180-8550, Japan Phone: (0422) 52-5082

TEAC AMERICA, INC.

7733 Telegraph Road, Montebello, California 90640 Phone: (213) 726-0303

TEAC CANADA LTD.

340 Brunel Road, Mississauga, Ontario L4Z 2C2, Canada Phone: 905-890-8008

TEAC MEXICO, S.A. De C.V

Privada De Corina, No.18, Colonia Del Carmen Coyoacan, Mexico DF 04100 Phone: 5-658-1943

TEAC UK LIMITED

5 Marlin House, Marlin's Meadow, The Croxley Centre, Watford, Herts. WD1 8YA, U.K. Phone: 01923-819699

TEAC DEUTSCHLAND GmbH

Bahnstrasse 12, 65205 Wiesbaden-Erbenheim, Germany Phone: 0611-71580

TEAC FRANCE S. A.

17 Rue Alexis-de-Tocqueville, CE 005 92182 Antony Cedex, France Phone: 01.42.37.01.02

TEAC BELGIUM NV/SA

P.A. TEAC Nederland BV, Perkinsbaan 11a, 3439 ND Nieuwegein, Netherlands Phone: 0031-30-6048115

TEAC NEDERLAND BV

Perkinsbaan 11a, 3439 ND Nieuwegein, Netherlands Phone: 030-6030229

TEAC AUSTRALIA PTY., LTD.
A.C.N. 005 408 462

106 Bay Street, Port Melbourne, Victoria 3207, Australia Phone: (03) 9644-2442

TEAC ITALIANA S.p.A.

Via C. Cantù 11, 20092 Cinisello Balsamo, Milano, Italy Phone: 02-66010500
