

Orphancameras.com

Posted 7-23-'04

This next page contains information on this camera.

This manual is for reference and historical purposes, all rights reserved.

Creation is copyright© by M. Butkus, NJ.

This page may not be sold or distributed without the expressed permission of the producer
I have no connection with any camera company

On-line camera manual library

This is the full text and images from the manual. Color images when needed

If you find this manual useful, how about a donation of \$3 to: M. Butkus, 29 Lake Ave.,
High Bridge, NJ 08829-1701 and send your e-mail address so I can thank you.

Most other places would charge you \$7.50 for a electronic copy or \$18.00 for a hard to
read Xerox copy.

This will allow me to continue to buy new manuals and pay their shipping costs.

It'll make you feel better, won't it?

If you use Pay Pal or wish to use your credit card, go back to the main page

a.k.a www.butkus.org/chinon

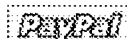

www.orphancameras.com 
PENTAX

P30_T

OPERATING MANUAL



www.butkus.org/chinon

Thank you most sincerely for choosing one of our Pentax 35mm SLR cameras.

Before starting to operate this camera, please be sure to read this operating manual very carefully to familiarize yourself with every detail of the features and functions it has to offer. We hope you will enjoy fine photography with this camera for many years to come.

Commercially available lenses and accessories produced by other manufacturers are not made to our precise specifications and therefore, may cause difficulties with — or actual damage to — your Pentax camera. We do not assume any responsibility or liability for difficulties resulting from the use of lenses and accessories made by other manufacturers.



TABLE OF CONTENTS

Features	2	ADVANCED OPERATION	
Nomenclature of working parts	4	Using Pentax dedicated auto flash units	27
PREPARATIONS		Using Programmed Auto Flash mode	28
Inserting batteries	6	Exposure-memory lock	30
Attaching and detaching lens	8	Self-timer	31
Film wind lever	9	Using 100 setting	32
Main switch, shutter release button, shutter dial	10	Using B (Bulb) setting	33
Film	11	Depth of field	34
Loading film	12	Depth-of-field preview	36
Unloading film	15	Infrared index mark	37
Strap and soft case	16	Warning displays	38
BASIC OPERATION		Programmed AE diagram, metering range and shutter/aperture coupling range	40
Viewfinder displays	17	Dioptr correction, mount adapter K, eyecup P	42
Focusing	18	Precautions on batteries	43
Holding camera	19	Specifications	44
Shooting in Programmed AE mode	20	Taking care of your camera	46
Shooting in Aperture-priority AE mode	22	Warranty policy	48
Shooting in Metered Manual mode	24		

When this camera is used with any SMC Pentax-A or SMC Pentax-F lens, it offers four exposure modes: Programmed AE, Aperture-priority AE, Metered Manual and Programmed Auto Flash. When the lens aperture is set to "A" position, the Programmed AE mode can be used. When the lens aperture is set to any f-stop other than the "A" setting, the Aperture-priority AE or Metered Manual modes can be used.

- When the conventional K-mount lens is used, the camera operates in the Aperture-priority AE or Metered Manual mode.

Programmed AE Mode

The camera automatically selects the most suitable combination of shutter speed and aperture to obtain correct exposure, simultaneously changing the combination according to the brightness of the subject. This mode is suitable for those who do not want to be bothered by setting exposure controls.

Aperture-priority AE Mode

When you set the aperture manually, the shutter speed is automatically adjusted according to the brightness of the subject to provide correct exposure.

This mode is suitable for taking pictures for which the control of the depth of field is desirable, such as portraits, etc.

Metered Manual Mode

The combination of shutter speed and aperture is completely up to you. Guided by the meter indication in the viewfinder, you can adjust both controls to obtain proper exposure. If necessary, deliberate over- or underexposure can be obtained.

Programmed Auto Flash Mode

When you use a Pentax dedicated auto flash on this camera in its Programmed AE mode, the camera automatically selects the proper aperture and shutter speed to control flash output for proper flash pictures.

- The camera does not operate unless the batteries are properly inserted. Be sure to check how they are inserted before operating it. Also check if the main meter switch is set to ON or OFF.
 - Most flashes made by others can be used on this camera, but Pentax dedicated flashes will offer more convenient functions.
- Even if you use a flash with TTL auto flash provision, this camera does not provide TTL auto flash operation.
- When you use the accessories such as Extension Tubes, Microscope Adapter, etc. that are mounted between the camera body and lens, this camera operates in the Aperture-priority AE or Metered Manual mode. The Programmed AE mode cannot be used.

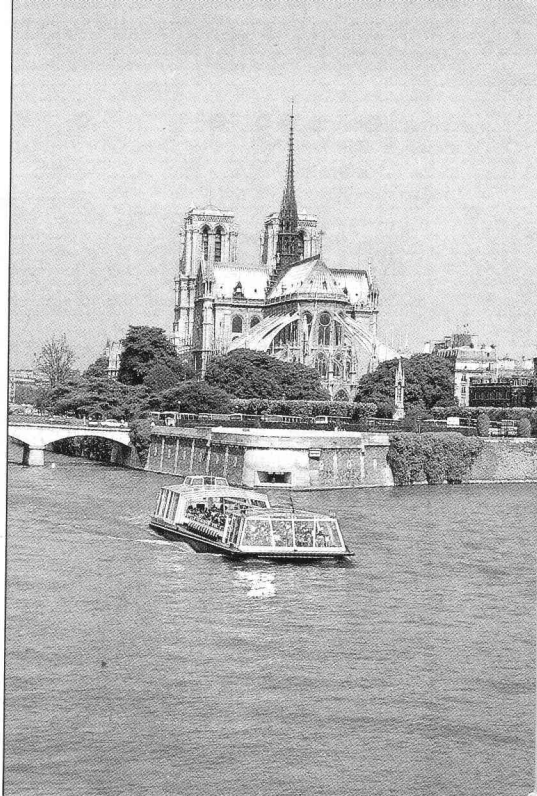

NOMENCLATURE OF WORKING PARTS

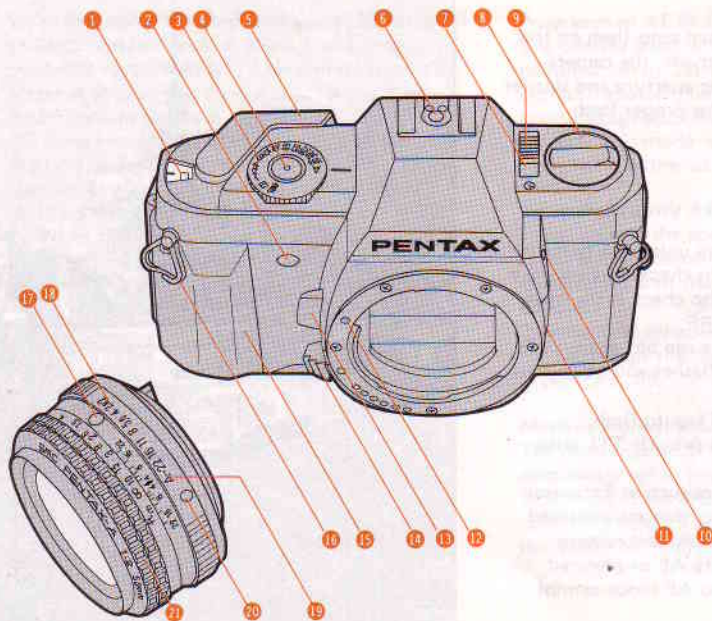

- ① Exposure counter
- ② Self-timer lamp
- ③ Shutter dial
- ④ Shutter-release button
- ⑤ Film-wind lever
- ⑥ Hot shoe
- ⑦ Self-timer lever
- ⑧ Main switch
- ⑨ Film-rewind/Back-cover-release knob
- ⑩ Exposure-memory-lock button
- ⑪ Cable-release socket
- ⑫ Mount index
- ⑬ Preview lever
- ⑭ Lens-lock-release lever
- ⑮ Grip
- ⑯ Strap-lug
- ⑰ Lens-alignment node
- ⑱ Aperture scale/ring
- ⑲ Aperture-"A" index
- ⑳ "A"-lock-release
- ㉑ Focusing ring

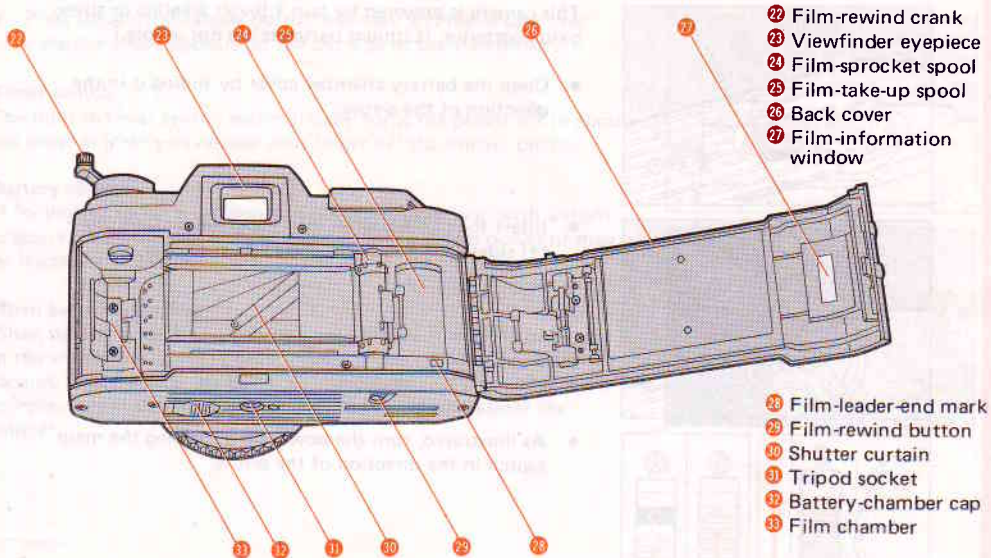

- 22 Film-rewind crank
- 23 Viewfinder eyepiece
- 24 Film-sprocket spool
- 25 Film-take-up spool
- 26 Back cover
- 27 Film-information window

- 28 Film-leader-end mark
- 29 Film-rewind button
- 30 Shutter curtain
- 31 Tripod socket
- 32 Battery-chamber cap
- 33 Film chamber

INSERTING BATTERIES

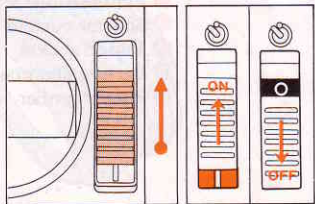
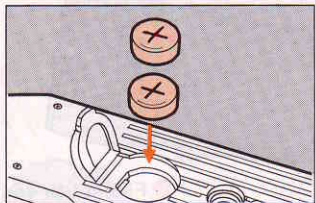
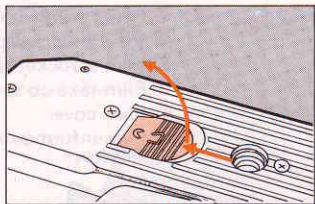

This camera is powered by two 1.5-volt alkaline or silver-oxide batteries. (Lithium batteries are not usable.)

- Open the battery chamber cover by sliding it in the direction of the arrow.
- Insert the two batteries into the chamber with their (+) sides facing upward, and close the cover.
- As illustrated, turn the power on by sliding the main switch in the direction of the arrow.

- Press the shutter release button half-way and make sure that a shutter speed appears on the left side of the viewfinder.

Timer switch

The built-in timer switch automatically turns the power off in about ten seconds after you release your finger off the shutter button.

Battery check

If no shutter speed is displayed in the viewfinder even with a slight pressure on the shutter button, the batteries have no power or may be improperly inserted.

When batteries weaken

When the batteries are becoming weak, the shutter speed displayed in the viewfinder starts to blink slowly at the speed of once per second. If so, replace the batteries immediately. If the batteries are completely exhausted, the shutter button does not release the shutter.

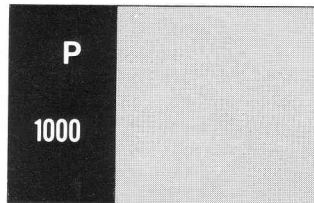
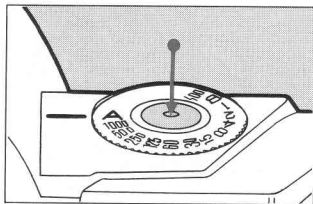

ATTACHING AND DETACHING LENS

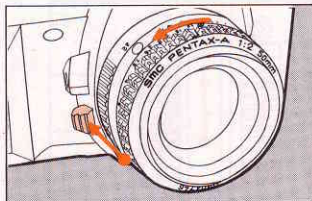
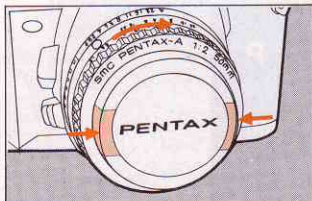
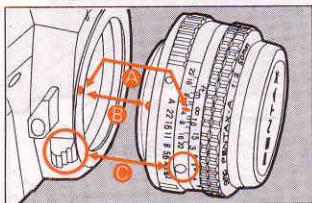

To mount or interchange Pentak K, KA and KAF mount lenses, follow the steps below.

- Remove the body mount cap and the rear lens cap. If the finder cap is still on the eyepiece, remove it.
 - Align the red dot on the camera body with the red dot on the lens (See A, B). Seat the lens in the body mount and turn it clockwise until the lens locks with a click. When mounting the lens in dim light, method (C) is recommended. This method allows lens mounting by touch.
- Align the raised node on lens barrel with the lens release by touch. Then turn and lock as above.
- To remove the lens cap, press in on the notches at both sides.
 - To remove the lens, turn the lens counter-clockwise while pressing the lens release lever.
 - After removing a lens from the camera body, put the front and rear lens caps to protect the lens from dust and stains.

Note: Don't damage or stain the electrical contact points on the mount face. When they become stained, wipe them with a clean, dry cloth.

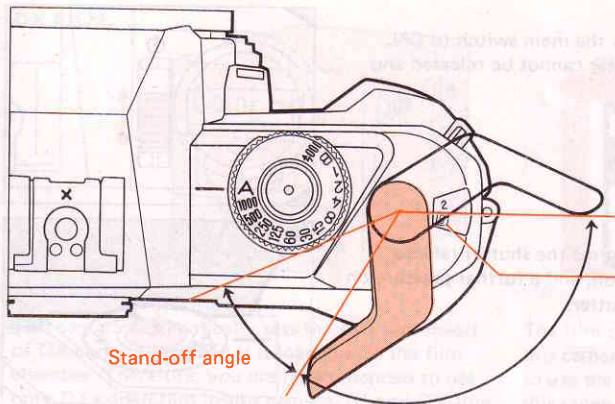

Exposure counter

The scale is indexed as follows:

S ● 0 ● 2 ● 4 ● ● 20 ●

24 ● . . . ● 36.

Interlocked with the film wind mechanism, this counter indicates the number of exposed frames.

Setting the wind lever for rapid shooting

The film wind lever can be set at the stand-off position for faster film advance. Even if you remove your thumb from the lever, it remains at the stand-off angle, ready for the next quick shot. After completing a series of pictures, the lever should be pushed in to the original position.

Film advance stroke

The film wind lever should be thrown as far as it goes.

Note: The wind lever may stop in the middle of a stroke when the film comes to its end. Do not force the lever and rewind the film leaving the lever as it is.

MAIN SWITCH, SHUTTER RELEASE BUTTON, SHUTTER DIAL

- **Main switch**

To release the shutter, be sure to turn the main switch to ON. When the main switch is off, the shutter cannot be released and the meter remains off.

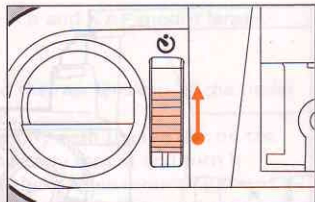

- **Shutter release button**

As you turn the main switch on and press the shutter release button half-way, the meter will turn on, and a further pressure on the shutter button will release the shutter.

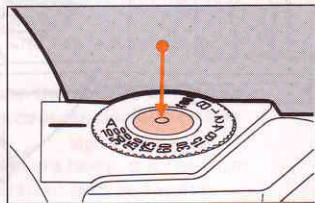

- **Shutter speed dial**

When shooting in the Aperture-priority AE or Metered Manual mode, turn the shutter speed dial until the desired shutter speed aligns with the index (red line).

A = Aperture-priority AE

1000 – **1** = 1/1000 - 1 sec. (Metered Manual)

B = Bulb (long-time exposure)

100 = 1/100 sec. (flash-sync speed)

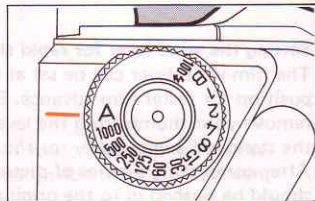

DX FILM

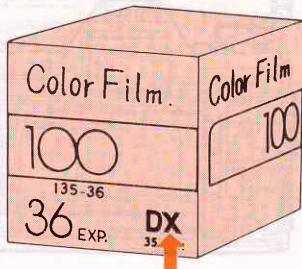

This camera automatically sets the ISO film speed of DX-coded film when it is loaded into the film chamber. Therefore, you are recommended to use only DX-coded film in this camera. (If non-DX film is loaded the camera will automatically set the film speed to 100, whatever film speed it may have; in other words, the only non-DX film usable for this camera is one with ISO 100.)

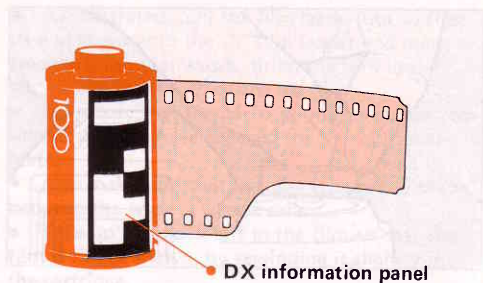

The film speeds which can be automatically set by this camera range from ISO 25 to 1600, so be sure to use the DX-coded film having a film speed within this range.

LOADING FILM

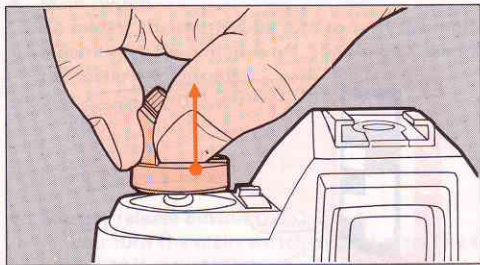

Always load or unload film in the camera in a shady spot, or shield it from direct sunlight with your body.

- As illustrated, unfold the rewind crank by pushing it with your finger-nail.
- Pull the rewind knob upwards until the back cover snaps open.
- Slide the film cartridge into the film chamber with the flat side up. Lock the cartridge in place by pushing the rewind knob down, rotating it slightly making sure that it grips the spool.

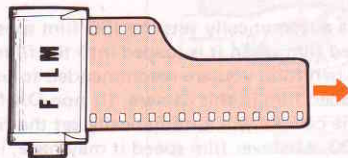
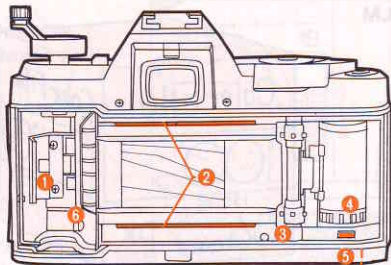

- | | |
|------------------|------------------------|
| 1 Film chamber | 4 Spool teeth |
| 2 Guide rails | 5 Film leader end mark |
| 3 Sprocket teeth | 6 DX-information pins |

Keep the DX-information pins free from scratches, dirt, dust, etc.

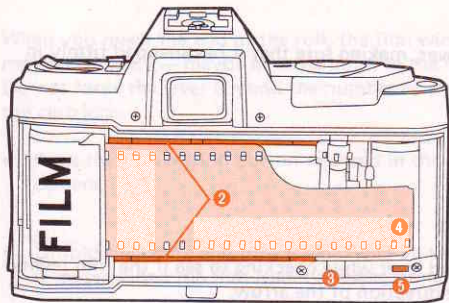

- As illustrated, pull the film leader out so that its end aligns with the **5** film leader end mark (red bar); in other words, bring the film leader end within the length of the bar.
- Make sure that the perforations on the bottom side of the film have engaged the **3** sprocket teeth.
- Also make sure that the film is properly placed between the two **2** guide rails.
- Take up any slack left in the film so that the film is flat as shown, by rewinding it slightly into the cartridge.
- When a film with a higher ISO number is loaded, do not leave the camera out of the case for a long time.

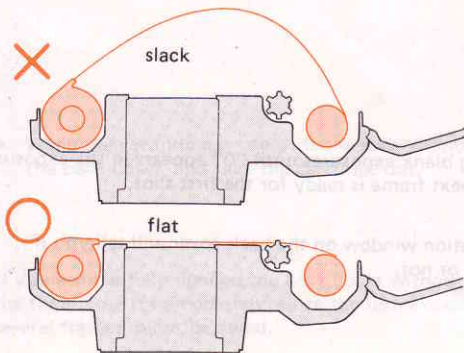

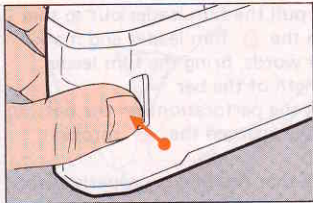

- Close the back cover, making sure that it has snapped firmly in place.

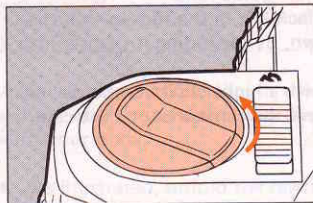

- Cock the film wind lever while checking to see if the film rewind knob turns in the direction of the arrow.

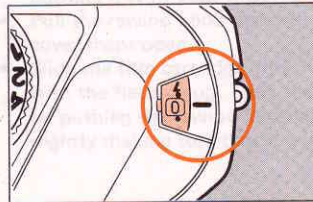

- Repeat making blank exposures until "0" appears in the exposure counter. The next frame is ready for the first shot.

The film-information window on the back cover will tell you if the film is loaded or not.

When you reach the end of the roll, the film wind lever will stop moving abruptly — maybe at some point in the middle of a stroke. Do not force the lever beyond the number of exposures shown on the cartridge.

- Press the film rewind button recessed in the bottom of the camera.
- Unfold the crank and turn it clockwise all the way until you feel it loosen when the film leader releases from the take-up spool.
- When the rewinding is over, lift the rewind knob lightly to open the back cover, and take the cartridge out.

If you accidentally opened the back cover without rewinding the film, close it immediately, since the film except the last several frames might be saved.

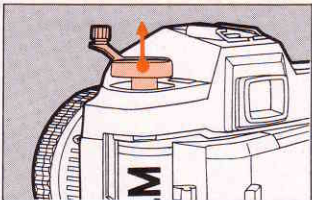
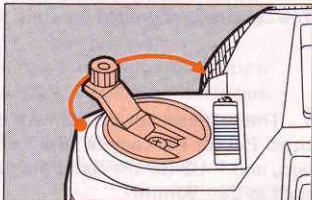
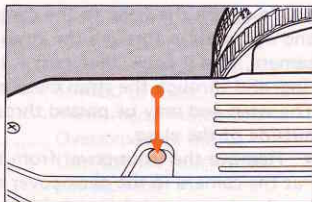

STRAP AND SOFT CASE

- To attach the strap to the camera, first pass the end of the strap through the strap lug on the camera, fold it back, then pass it through the strap ring, and through the strap clasp and the last ring. The strap end may be passed through the inside or outside of the clasp.
- Remove the front cover from the back cover. Put the camera in the back cover and put both case hooks around the camera's strap eyelets. The camera is now held securely in place.

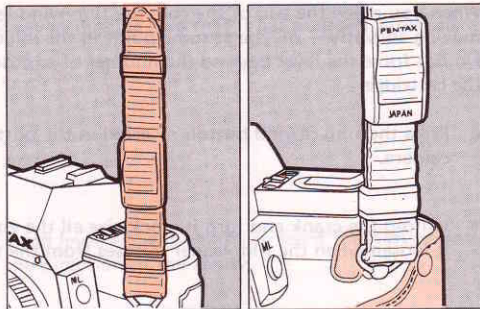

- The soft case for this camera is available in two sizes: P-S for the camera with a standard 50mm lens, and P-L2 for the camera with a zoom lens such as 28 - 80mm.

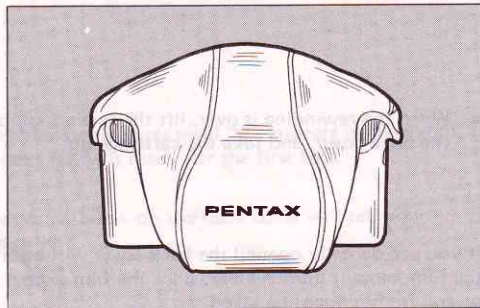

Various exposure data described at right are displayed by LED on the left side of the viewfinder.

LED = Light-Emitting Diode

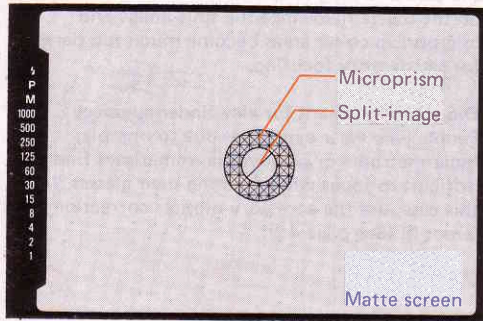

- P** Programmed AE mode
- M** Metered Manual mode
- 1000 ~ 1** Shutter speeds from 1/1000 to 1 sec.
- ⚡** Flash-ready indication
- Blinking "1000"** Overexposure indication (blinks four times per second)
- Blinking "1"** Underexposure indication (blinks four times per second)

(The above two indications also appear when the exposure combination is out of the shutter/aperture-coupling range or the metering range.)

- Camera-shake (slow-shutter-speed) warning** 30 ~ 1 appears in orange
- Shutter speed in use (blinks)** Memory lock

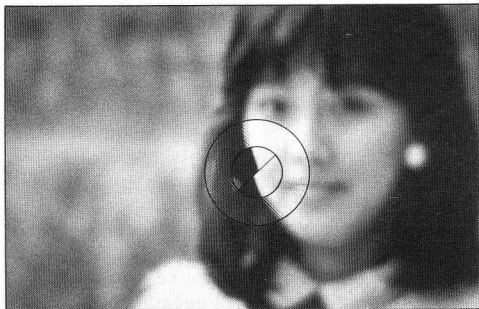

You can focus in three ways, with the split-image, microprism, and/or matte field. To focus using the split-image, turn the focusing ring until the two images in the split-image circle at the center of the focusing screen are perfectly aligned. When using the microprism collar, focus until the glitter disappears from inside the collar. With the matte field, focus until the image on the matte field appears sharp and crisp.

Note: If the maximum aperture of the attached lens is smaller than $f/5.6$ (for example, $f/8$ as in the case of a long telephoto), it is easier to focus on the matte field since the split-image and microprism collar areas become much too dark for satisfactory focusing.

Diopter adjustment for viewfinder eyepiece

People who wear eyeglasses due to myopia, hypermetropia or presbyopia, sometimes find it difficult to focus while wearing their glasses. In this case, use the accessory diopter correction lenses M (See page 42).

Proper holding of the camera is essential to minimize camera shake which causes blurred pictures. Practice holding and operating your camera before inserting your first film cartridge. Generally there are three basic ways to hold the camera. In any case, hold the camera tightly to your face with your hands. The grips on this camera will help you keep a steady hold on your camera. Release the shutter gently while holding your breath. Strong pressure on the shutter

release button may cause blurred photographs. Take a secure, well-balanced posture without straining yourself. The portion marked O in the illustration should be drawn to your body. It is a good idea to stabilize your body and the camera using a tree, building wall, table, etc. For long exposures or while using telephoto lenses, it is recommended to use a tripod in order to reduce camera shake to a minimum.

