

3

THE MAGAZINE

3.1 CONCEPT

The Aaton DX Magazine incorporates many features which add to the camera system's ease-of-use, efficiency and reliability. The magazine's coaxial design allows for separate feed and take-up chambers, which ensures that the bulk of the loading process is performed in daylight.

The DX Magazine is driven magnetically from an intermediate drive connected to the camera motor; a magnetic wheel on the inner side of the camera body couples with a similar wheel on the throat of the magazine to transport the film. This magnetic drive system decreases noise and power consumption, and prevents mechanical stress during mis-loads.

The magazine handles up to 400 ft (122m) loads of double or single perforated 16mm film stock. 400 feet of film is approximately 10.5 running minutes at 24 fps.

3.2 COMPATIBILITY

3.2.1 DX Magazines

Since the introduction of the XTR in 1984, only DX magazines have been manufactured by Aaton, all of which can be used on today's XTRprod (approximate ser #3500 and above). The DX code distinguishes this magazine from earlier designs. D refers to its emulsion-out Super16-safe coaxial roller (further explained below). X refers to its magnetic drive system.

3.2.2 Super16 Safe

All DX magazines are designed to safely transport either standard or Super16 stock. Capped rollers keep the running film from riding up and prevent any contact within the picture area. The mag's large coaxial roller, which transports the film from the feed into the take-up chamber, handles the film on its less-sensitive base side and facilitates a long and twistless film path. (Severe twisting of the more

sensitive high speed stocks, as is the case with the LTR and some other manufacturers' magazines, has been known to cause grain fracturing and a resulting abnormal exposure of the film in that area.)

3.3 PRESSURE PLATE SYSTEM

The DX magazine features two pressure plates which are located at the front of the nose of the magazine. When the loaded magazine is attached to the camera, these pressure plates provide the precise stabilization of the film during exposure and transport.

3.3.1 The Picture Plate

The upper four-stripped pressure plate, called the picture plate, is positioned at the camera's aperture opening and is designed to hold the film steady at the point of exposure. Proper setting and functioning of the picture plate assures the precise focus of each image.

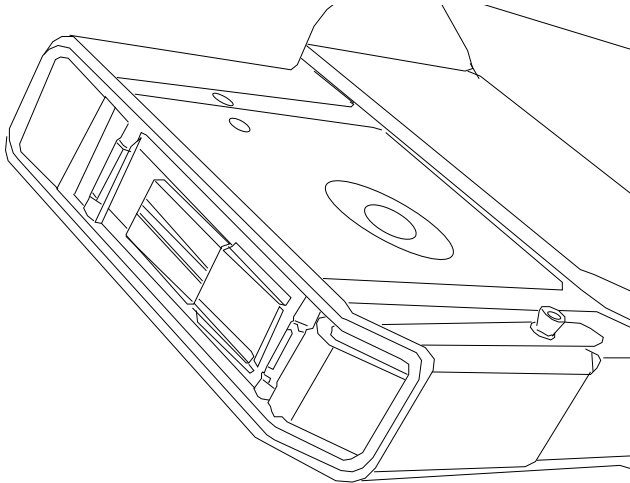



ID of Mags on XTRplus vs XTRprod

As mentioned, the XTRprod can distinguish seven magazines because its sensors can read all three receivers.

The XTRplus, however, can only distinguish three magazines, as its sensors will only detect the two upper receivers. Be aware of this fact when renting additional magazines. For example, a mag which is read as a G on an XTRprod will be read as a C on an XTRplus camera; as the lower receiver will not be detected.

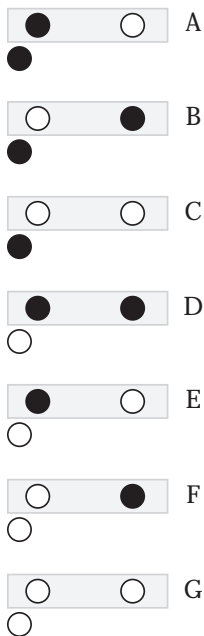

3.3.2 The Claw Plate

The lower plate, called the claw plate, is positioned at the pulldown claw and functions to stabilize the film as the claw engages the film perf between exposures. Proper tension and functioning of the claw plate contribute to reliable transport and quiet operation.

3.4 MAG IDENTIFICATION SYSTEM

3.4.1 Mag ID

Each DX magazine bears its own identification (ID) determined by the combination of magnets in receivers located above the drive wheel on the throat of the mag. This identification is used by the camera to recall the remaining footage of a mag removed from the body unfinished. The XTRprod can differentiate seven magazines (A through G) via electronic sensors located within the LCD control panel and recall the memorized footage for each. By comparison, the less sophisticated display of the XTRplus can identify only three magazines (A, B, C).

The chart to the right represents the seven IDs which can be read by the XTRplus and XTRprod cameras, with the corresponding magnet in receiver combination for each.

3.4.2 Changing the ID of a Magazine

The Mag ID of a particular magazine can be easily changed by the user. Determine the magnetic receiver(s) that need to be changed according to the chart above. Locate the small silver spanner tool located on the coaxial roller in the feed side of the mag. Using this tool, loosen and remove these receiver(s). A spare receiver is located at the base of the coaxial roller. Install the appropriate receivers as necessary. Remember to change the letter decal on the outside of the feed side door to match the new ID. For spare decals, contact your Aaton representative.

- magnet
- no magnet

3.5 LOADING

The straightforward design of the DX magazine allows for quick, easy loading and an absolute minimum amount of threading in the dark. The film does not need to be cut in preparation for loading.

3.5.1 Feed Side - In the Changing Bag

- Place the film can and the magazine, feed side up, in the changing bag and zip closed.
- Disable the mechanical footage counter, located on the feed door, by rotating counter clockwise until it locks in its recessed position.
- Unfasten the feed door lock by turning downward and open the feed door.
- Remove the film from its can and bag.
- On the feed core holder, squeeze the core lock mechanism on either side with thumb and forefinger to release core lock.
- Place the film on the feed spindle with its wind clockwise and press the center of the core lock to lock the core in place.
- Thread 4" of film around the outside of the lower guide roller and through large coaxial roller emulsion out. Make sure that the length of film feeds completely through to the take-up side.

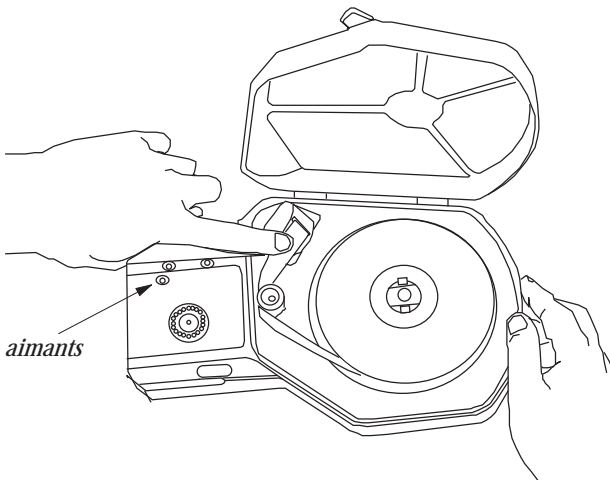

Care for your Changing Bag

A clean and light-tight changing bag is the only thing separating your precious footage from a veritable washout. Before using your changing bag each day, turn it inside out and shake it clean of dirt and debris. It is also a good practice to periodically inspect its edges for holes and tears. Hold it up to a strong light to check for any pin hole leaks.

-
- Close and lock the feed door and engage the footage counter by rotating clockwise.
 - Remove the magazine from the changing bag.

3.5.2 Take-up Side - In Daylight

- Unfasten the take-up door lock by rotating downward and open the door.
- Release the doors of the upper and lower pinch rollers by pressing

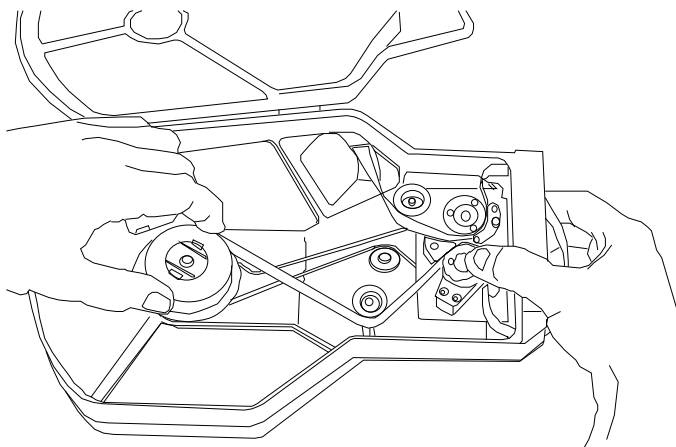

the white buttons and gently pulling open.

- Pull the length of film from the slot of the coaxial roller and pass below the first idler roller. Bypass the upper sprocket for the time being and push the film directly through the upper channel slot to the outside of the nose. Pull through about one foot in length.
- Reintroduce the film into the lower slot, back into the magazine.
- Place a plastic take-up core onto the take-up spindle, check that the core is seated properly, and press the center of the core lock to lock the core in place.
- Bypass the lower sprocket for now and pass the film underneath the lower roller. Fit the film end into a plastic take-up core and wind on a few turns counter-clockwise and emulsion in.
- Thread the film around the lower sprocket, making sure the film's

perforations engage the sprocket teeth. Close the lower pinch roller until it locks firmly in position and a noticeable click is heard.

- Hold the lower sprocket with your right thumb and rotate the take-up core counter-clockwise to remove any slack.
- Thread the film around the upper sprocket and adjust the loop until its taut length is 14 to 15 frames long outside of the nose. When the proper length is achieved, close the upper pinch roller until it locks firmly in position.
- Remove any slack, then close and lock the take-up door.



The Two-Finger Rule

When loading the take-up side of the magazine, the loop size can quickly be measured by inserting two fingers within the loop perpendicular to the mag's pressure plates.

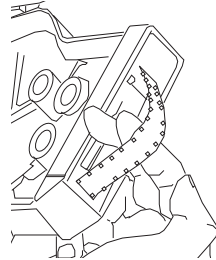

At first, determine proper loop size by pulling the looped film away from the mag, counting and adjusting for 15 to 16 visible perforations for a length 14 to 15 frames long. Then, insert two fingers and check how the spacing relates to the proper loop length. Of course, each person's finger-measured equivalent will be slightly different, but for most people, a tight two-finger length is approximately a 14 frame loop, a loose two fingers is about 15 frames. After you become familiar loading the mag, you should be able to use the two-finger method to save time setting your loop.

4

THE AATON SYSTEM

4.1 CAMERA CONFIGURATIONS

4.1.1 15mm Front Rods

The most versatile and popular configuration for accessorizing the XTRplus camera, the universal 15mm screw-in front rod system can instantly accept Aaton, Arri, Chrosziel, Petroff and other manufacturers' mattebox and follow focus systems. Utilizing the front rod system allows for quick conversion from tripod to shoulder operating modes without the need for recon-figuration. Aaton manufactures 60mm and 120mm length rods that screw directly into the front housing of XTRprod underneath the lens port.

The 15mm front rod system is recommended when standard size lenses and accessories are to be used or when quick conversion between tripod and handheld modes is necessary.

4.1.2 Sliding Bridgeplate

The XTRprod can also accept standard 15 and 19mm sliding bridgeplates for building the camera system for high-end studio work. The bridgeplate configuration can accept Aaton, Arri, Chrosziel and other manufacturers' mattebox, follow focus and

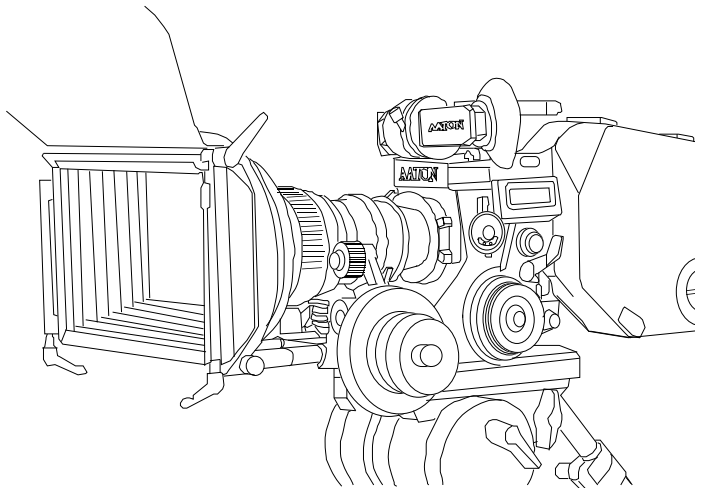

support equipment that is designed for bridgeplate use.

Standard bridgeplates from Aaton, Arri and other manufacturers can be attached to the XTRprod by means of the 3/8-16 tripod receptacle on the underside of the camera.

The sliding bridgeplate system is recommended when large 35mm lenses and accessories are to be used, when using a geared head or when the highest possible production value is necessary.

4.2 HANDGRIP

The XTRprod body includes a wooden handgrip, short 15mm rods, rod coupler and Lemo2 cable as standard. The handgrip, which is designed to be used for comfortable handheld operation, can also be used to provide on/off control on the battery side of the camera while on the tripod.

4.2.1 Mounting the Handgrip

Screw in one 15mm short rod into each of the two receptacles on the front housing of the camera below the lens port. Slide the coupler over the two rods to the desired location and fasten its center wing nut to secure the rods in position. Attach the handgrip to the coupler by mating the star plate on the coupler to that on the handgrip, adjusting to the desired position and fastening the T screw of the handgrip. Connect the Lemo2 cable between the handgrip and camera body to add on/off capability to the handgrip. The Lemo2 connector is located on the battery side of the camera at the front of the accessory box.

4.2.2 Handgrip On/Off Functions

Both camera run and test functions are available from the handgrip. While hand-holding the camera, pressing the rocker switch to the right provides camera run, pressing the switch to the left provides test. Unlike the body switch, the camera test position of the handgrip is a momentary switch. Pressing and holding the switch opens the shutter and advances the mechanism 1/2 frame. Pressing

and immediately releasing this switch advances the mechanism one full frame at a 1/4 sec exposure time. This function allows the use of the handgrip as a simple intervalometer.

4.2.3 Handgrip Adjustments

The handgrip rotation should be adjusted for maximum handheld operating comfort. Loosen the T screw and rotate the handgrip at the star plate until a more comfortable position is found.

If a more extreme repositioning is required, whether it be for reasons of comfort or clearance in certain studio rig configurations, this can be achieved with coupler extenders, spacers and intermediate arms which utilize the star plate system for adjustment. Ask your agent for a configuration that meets your needs.

4.3 TRIPOD USE

In order to use the XTRprod on a standard tripod, the tripod's quick release plate must be fastened to the underside of the camera body with its standard 3/8-16 screw. Make sure to use only a quick release plate screw provided by the manufacturer; non-standard screws longer than 8mm (1/3") can fracture the base casting and damage the camera's electronics.

4.4 SHOULDER OPERATION

One of the most attractive features of the Aaton system has always been its comfort and ease of use in handheld situations.

The XTR line does not require the use of shoulder braces or additional padding for handheld operation. The contour of the camera and magazine is designed to fit snugly around the operator's shoulder. The wooden handgrip is attached to the front rod coupler at a slight angle to bring the operator's elbow into his side and increase stability.

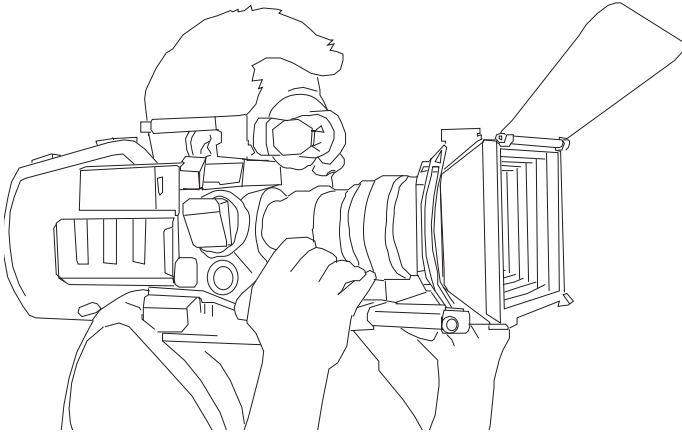

The system can be completely built off the 15mm front rods without the use of a bridgeplate to allow for quick changing from shoulder to tripod operating modes.

4.5 CARRYING HANDLE

The carrying handle of the XTRprod is reinforced to safely accommodate any carrying, operating or mounting situation.

4.5.1 3/8 Accessory Screw

The handle features a 3/8-16 insert to receive accessories such as french flags and lightweight monitors. Be sure not to use a 3/8 screw longer than 10mm (7/16"); longer screws can fracture the insert casting and damage the viewfinder's optics.

4.5.2 Mounting from the Carrying Handle

The 3/8 insert, along with a guide hole at the rear of the handle, can also be used to build a plate to undersling the camera or to configure the rig for Steadicam low mode use. For this reason, the handle features a long flat top surface that is parallel to the bottom of the camera.

4.5.3 Tape Measure Stud

The handle is also equipped with a hideaway tape measure stud, which is positioned between the rods directly behind the 3/8 insert. To use this stud, pull it up and fasten the ring of a standard assistant's tape measure around it; the stud holds the tape measure zero point precisely at the film plane.

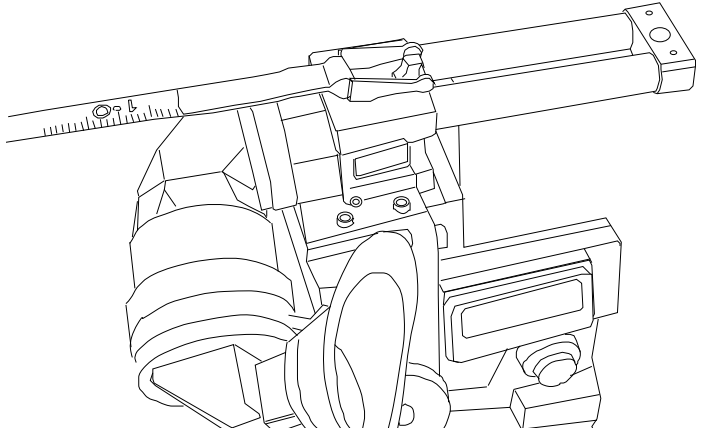

4.6 TRANSPORT

One often overlooked, yet vital factor in the proper functioning and longevity of your camera equipment is your transportation practices. A few good shipping habits can avert potential damage caused by careless messenger services and airport handling.

When shipping and carrying your equipment, it is always good practice to break down the package to its basic components whenever possible. Ship the body, mags and batteries unattached and individually padded. Never, under any circumstances, ship the camera with a lens attached (especially a zoom lens). Shocks transferred from the outside of a case could have disastrous effects to the ultra-critical back focus of a lens and flange focal distance of a camera if transported as one.

Make certain there is ample padding between individual components in a case and from the case's outer edges. Shipping case manufacturers suggest a minimum of 1 1/2" padding between high precision components such as the camera and lenses. 1" of padding is acceptable, however, between some of the more rugged components, such as magazines and batteries. Manufacturers also suggest to allow 2" of padding between the component and the outside of the case.

Choose a case design that, not only meets your shipping and travel requirements, but allows you maximum flexibility and comfort out in the field. Check with your Aaton agent to determine the case configuration that best suits your needs.

4.7 EXTREME CONDITIONS

Certain precautions should be taken in order to achieve maximum performance when operating the XTRprod in extreme or adverse conditions.

4.7.1 Cold weathers

The XTRprod features a built-in electronic heating element located in its base which is designed to automatically turn on when needed and maintain the claw mechanism at a temperature of 15° F. One of the cold, hard facts of cold weather shooting is the considerable reduction of battery life. Do whatever possible to conserve your batteries and always carry more than usual. Favor many small batteries, such as on-boards and lithium cells (which are easier to keep warm), over large block batteries. Use a powercable so that the on-board battery could be kept in a pocket close to the warmth of your body.

When filming outdoors, use a standard or heated barney to protect the camera body from direct contact with the wind and cold. To avoid condensation inside the mechanism, electronics and lens elements, do not take the equipment indoors or expose it to sudden

temperature changes. If and when the equipment must be moved inside, do so by first placing it in a sealed container and letting it thaw for a few hours before opening.

Always keep your raw stock and loaded magazines below freezing temperatures at all times during a cold weather shoot.

7.2 Warm Weather

To keep the temperature of the camera body down, avoid having the camera exposed to direct sunlight for long periods of time by using a barney, all-weather cover, or some form of shading, like an umbrella. Most importantly, keep raw stock and magazines in a dry cooler or in the coolest location available.

5

CLEANING



Lens Cleaning Tips

Avoid handling lens tissue on the surfaces which will contact the lens. Oil from your hands transferred to the lens surface will make an easy cleaning job tough. Furthermore, never clean a lens element without the aid of cleaning fluid. A good number of scratches on lens surfaces are caused by poor cleaning methods.

5.1 LENS

5.1.1 Lens Elements

The front and rear surfaces of your lenses should be inspected regularly and always kept clean of dust particles, smudges, fingerprints, etc. First, blow off any large particles of debris using an air syringe. Lens elements should then be cleaned using lens cleaning fluid with lens tissue. Apply a few drops of cleaning fluid to a fresh lens tissue or directly to the lens. Wipe the lens in a circular fashion, starting from the center and working towards the outer edge. Finish with a fresh dry tissue. If some streaking remains, repeat the procedure until the surface is sufficiently clean.

5.1.2 Lens Exterior

The exterior of your lenses such be cleaned of dirt and adhesives as necessary. Use a multi-purpose cleaner or degreaser such as De-Solv-It applied with a Q-tip, lens tissue or cotton cloth.

5.1.3 Mounting Surface

Always inspect and keep the surfaces of your lens mounts clean using alcohol or a multi-purpose cleaner with a Q-tip. Remember, any debris found on the surface which contacts the lens seat can directly affect the back focus of your lens. Make sure the Q-tip does not leave any cotton fibers behind.

5.2 BODY

5.2.1 Exterior

Keep the external body surfaces clean using a cotton cloth with alcohol or a multi-purpose cleaner. Use a utility brush with soft bristles to clean dirt from tight crevices.

5.2.2 Mounting Surfaces

Like the lens mount, extra care should be taken to keep the lens

port ring completely free of dirt and debris. Clean this surface, as well as the threads of the lens lock ring using alcohol or a multi-purpose cleaner applied to a Q-tip.

5.2.3 Camera Gate

The gate should be cleaned of film particles by means of a pointed wooden or plastic orange stick. The tool used should be of a soft and pliable enough material (like wood) to conform to the grooved side channels of the gate without breaking. Make sure to inspect and clean the left and right channels, the frame of the aperture opening, the lateral pressure plate, the tip of the claw and the timecode LEDs.

Afterwards, run your finger across the left and right rails of the gate, if your hands are clean. The oil from your finger will provide just enough lubricant for the film to pass these surfaces smoothly.

Inspect the gate; if the rails are still dirty or are carrying any debris (such as the adhesive from recanned rolls of film), with a Q-tip, use a cleaning fluid that will do the job. Alcohol and lens cleaner are safe to use on the surface of the gate. Make sure the Q-tip does not leave any cotton threads behind.

5.3 VIEWING SYSTEM

The following components of the viewing system should be cleaned whenever dirt particles are visible through the view-finder. Use lens fluid applied with a cotton or preferably a foam Q-tip for all areas.

By cleaning the viewing system in the order described below, you will clean the more dust-prone areas first, which may help you track down most dirt particles sooner.

5.3.1 Viewing Screen

Look through the lens port at the reflection of the viewing screen in the mirror and check for visible dust particles. Clear the mirror shutter so that it is rotated safely inside the body by rotating at the base of the shutter with your finger or by setting the camera to test



Warning !

Remember, the camera gate is a sensitive and high precision area directly responsible for the exact focus of the image; be careful not to use hard, damaging materials (like metal) on its surface. Under no circumstances should you perform any function within the aperture opening, lens port or near the claw with power attached to the camera. Accidentally running the camera while performing such tasks can cause serious damage to the shutter and mechanism



Cleaning the Mirror Shutter

Do not attempt to clean the surface of the mirror shutter; any small dust particles visible from the lens port will not come into focus in your viewfinder. If large particles of dirt must be removed, do so using an air syringe. Never use canned air on this surface. If the mirror is in need of a deeper cleaning, to remove smudges or oil, take your camera to a qualified technician to be cleaned.



Finding the dirt

There is a simple means of locating much of the dirt within your viewing system: Look through the viewfinder with no lens on the camera and adjust the diopter ring. If the dust particles remain in focus, they are most likely located on either side of the eyepiece. If the dust comes in and out of focus as the ring is moved, the dust is probably located on either surface of the viewing screen. Furthermore, if the dust appears to be on the same focus plane as the cross hairs of the viewing screen, it is most likely on the bottom surface of the screen and easily accessible.

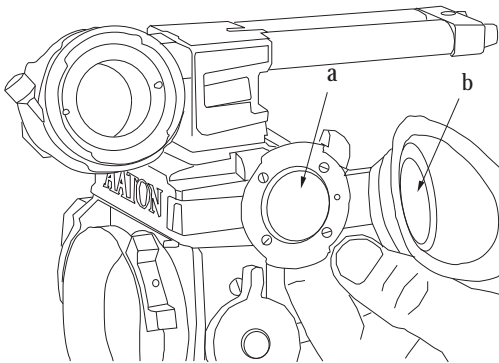

position, then removing the battery. Remove the viewing screen as described in section 2.8, Changing the Viewing Screen in the Camera Body chapter of the manual. Clean both upper and lower surfaces of the screen and reinstall.

5.3.2 Eyepiece

Clean the eye lens (A), which is the outermost element closest to your eye, by first blowing the surface with canned air, then cleaning with lens fluid and a Q-tip. Remove the eyepiece and clean the field lens (B), which is located on the inside of the eyepiece, in the same fashion.

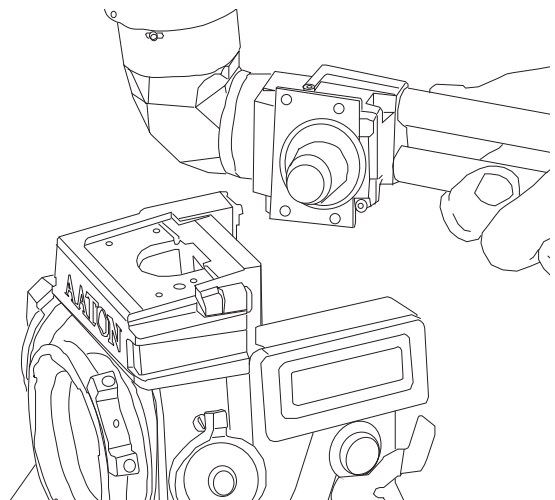

5.3.3 Viewfinder

With the eyepiece off, look into the remaining viewfinder and clean the exposed element of the pechan prism using canned air or an air syringe. If dirt particles are still present, remove the viewfinder assembly from the camera by removing the four allen screws that hold the base of the viewfinder to the front housing. Clean the exposed underside element of the viewfinder.

5.4 MAGAZINE

5.4.1 Exterior

Keep the external surface of the magazines clean by wiping down with a cotton cloth with alcohol or a multi-purpose cleaner. When a deeper cleaning is necessary, use De-Solv-It rubbed into the mag's surface with a cotton cloth. Finish with alcohol applied with a cloth to restore its original finish.

5.4.2 Pressure Plates

The magazine pressure plates should be cleaned of dirt and film particles by means of a dust-free cotton or chamois cloth. After cleaning, run your finger across their surface for a slight lubrication.

5.4.3 Interior / Film Path

qOpen the doors of the magazine and inspect all surfaces on which the film rides. If any film dust buildup is apparent in the sprocket or roller areas, use alcohol and a Q-tip to clean. Use a utility brush with soft bristles to clean particles from tight crevices.

Afterwards, use canned air and thoroughly blow out any remaining dust in the throat and main chambers.

6

SUPER16

6.1 SUPER16

6.1.1 The Format

Super16 is a means of utilizing the cost effectiveness of 16mm film for wide-screen applications. The 1.66 aspect of Super16 uses 20% more of the film surface by extending the picture into an area otherwise reserved for soundtrack or a second set of perforations. This increase in usable area results in significant improvements in image quality obtainable from 16mm film when used for any wide-screen application.



16mm standard

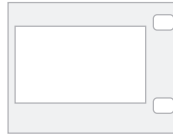

Super16

6.1.2 When to Shoot Super16

Generally speaking, Super16 can be a good choice of origination in the following instances:

- Any low-budget, theatrical production shot in 16mm for blow-up to 35mm.
- Any documentary or film that has the potential for future use in HDTV or some other widescreen aspect.
- Any 16mm production that has a long shelf life or would like to extend the shelf life of their film by making it wide-screen ready.
- Any 16mm commercial, music video or such that will be shown in the letterbox format.

6.2 GENERAL CONCERNS

6.2.1 Protecting the Negative

Specific precautions should be taken with any piece of equipment that handles the Super16 negative. The additional usable area of the

film must be free from contact with transportation surfaces in all instances, whether it be in the camera, at the lab or on the telecine. The Aaton XTR camera series, since its debut in 1984, has been built for safe and trouble-free Super16 operation.

On the other hand, equipment that has not been designed with Super16 in mind may cause rub, scratch or pressure marks within the area once occupied by a second set of perfs. In order to be sure that a certain device is compatible with Super16, it is always best to check with the manufacturer or the facility responsible for the equipment.

6.2.2 Maintaining High Quality

When Super16 is to be used for 35 blow-up, for future HDTV purposes, or for any other medium of greater resolution than today's standard television, it is of utmost importance to use the appropriate equipment and develop practices that will ensure the high quality of your images. Slight imperfections, which very often pass undetected on an NTSC or PAL screen, are greatly magnified when viewed in a more demanding format.

The XTRprod, with a registration tolerance of 1/2000 of the image dimension both laterally and horizontally, delivers the most stable and exact imaging of any 16mm camera available.

Your Super16 images, however, will only be as sharp as the lenses you use to capture those images. It is not enough to choose a lens that merely covers the wider aspect of Super16; just as important are the attributes of a lens such as sharpness, contrast and zoom curve, which affect overall image quality. See the list of recommended lenses for Super16 use, in the Technical Specifications chapter.

The critical adjustment of camera and lens and their relationship to one another insures that the lens is achieving its optimum focus point at precisely the same distance as to where the film plane lies.

With the stringent requirements of Super16, it is recommended that camera flange focal distance (FFD) and lens back focus be checked and precisely upheld by a qualified service facility.

6.2.3 Ordering Film

When ordering raw stock from your distributor, make sure to specify Super16 or single perf film. In the US, where 16mm double perf film is manufactured as standard, it is recommended to check stock of Super16 color negative 1-2 weeks prior to shooting. When ordering Super16 black & white stocks, it is advised to contact your distributor a month in advance when possible.

6.2.4 Film Processing

It is always recommended to choose a film lab that has a certain level of experience handling Super16. Make sure of the services they offer.

When preparing your film to be processed, be sure that your camera assistant has clearly indicated on the film cans and camera reports that the exposed film is Super16.

6.3 SHOOTING SUPER16

One of the most important aspects of shooting Super16 is achieving the full potential quality of the image. The best way to maximize image quality is to reduce the amount of perceptible grain within the picture. Factors such as film selection, exposure and processing techniques will affect the graininess of the resulting image.

6.3.1 Selecting a Film Stock

Relatively speaking, the faster the stock, the more grain there will be. Therefore, it is recommended to use stocks rated at 200 ASA and below whenever possible.

6.3.2 Lenses

The characteristics of any given zoom lens, those which determine image quality, contrast and sharpness, are most critical at wide angle and wide open aperture. In order to achieve the best image quality and the greatest depth of field, favor the longer focal lengths and T

stops of 4 and above, when possible.

6.3.3 Lighting

It is recommended not to cut corners with your lighting package for the sake of the budget. Those scenes which rely in the speed of the lens to compensate for minimal lighting will produce more grain than scenes which are amply lit and use a less critical lens aperture (T4 and higher).

6.3.4 Exposure

When shooting Super16 for blow-up, avoid underexposure and push-processing whenever possible. In fact, slight overexposure of the negative will produce a blow-up with less grain and increase color saturation and detail in shadowed areas. For best results, it is recommended to overexpose the negative anywhere from 1/3 to one stop, depending on the stock and the desired look.

When shooting Super16 for video transfer, slight overexposure is recommended for the same reasons, but care must be taken.

Overexposed negatives on a telecine require a higher gain, which increases video noise. The benefits of an overexposed negative, however, outweigh the additional noise introduced if the overexposure is kept within one stop or less.

6.3.5 Camera Moves

If a Super16 film is to be viewed on a large screen, any camera movement becomes intensified. Therefore, it is best to keep camera moves subtle and handheld activity more controlled than when shooting in 35mm.

6.4 SUPER16 FIELD CONVERSIONS

All XTR cameras, including the XTRprod are capable of both 16mm and Super16 operation. These cameras are designed to be field convertible; switchable between formats by the user in a few

simple steps. The following section offers detailed instructions on this procedure.

- For easier identification, the Super16 position of all adjustments will be marked with red dots, standard 16 position will be unmarked.
- All references to alignment in these instructions are made looking at the port of the camera from its front, unless otherwise noted.

6.4.1 Before You Begin

Before attempting a field conversion, make sure you have the following tools on hand:

- 1 small slotted screwdriver
- 1 loupe - approximately 5x magnification.
- 1 standard metric Allen L-wrench set - sizes delivered with camera
- 1 orange stick
- 1 Port Alignment Tool * - part #09-100-62 for Aaton Port, #09-100-61 for PL Port

You'll also need the following equipment:

- 1 Battery, preferably with XLR4 powercable
- 1 Zoom lens

The conversion should be performed on a clean workbench or table

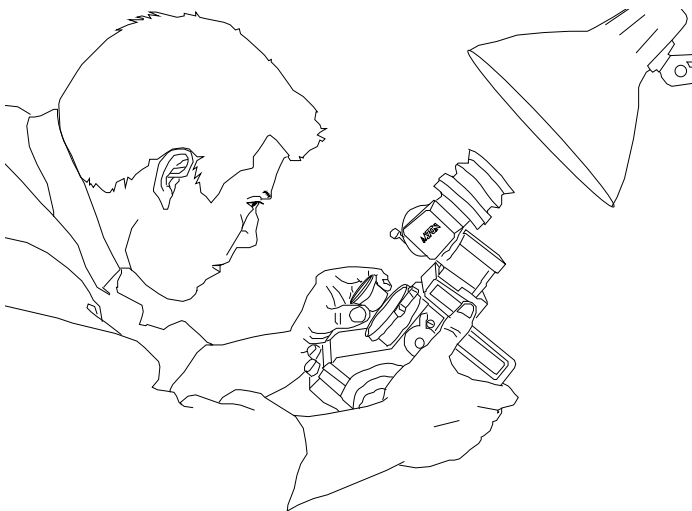

by an individual who is somewhat mechanically inclined.

4.2 Procedure

• 1. Changing the Viewing Screen

The XTRprod features an interchangeable viewing screen which allows the user to install a screen with the 16 or Super16 aspect markings of his choice. See section Chnaging the viewing screen to proceed.

• 2. Checking Screen Centering

It is advisable to check that the newly-installed screen is properly centered to the aperture opening.

Remove both the port cap and the aperture cover. Power the camera, preferably using a powercable so that a battery is not onboard.

Open the eyepiece shutter and direct light into the eyepiece by

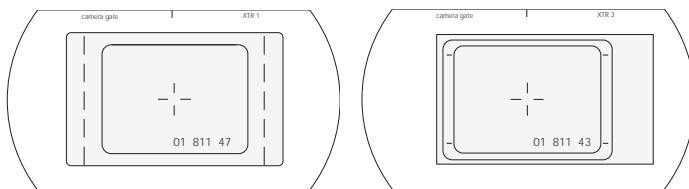

pointing its opening at a desk lamp or an overhead light source.

Situate the body so that the lens port is angled to face you. Run the camera at normal speed; the opening of the aperture plate should be easy to detect. If this is not the case, place a white piece of paper behind the camera in your field of view.

With a loupe, closely inspect the frame area. If the light through the eyepiece is strong enough, you should be able to see the reflection of the viewing screen superimposed over the aperture opening when the camera is running. If this is not the case, adjust the amount of light through the finder by moving the eyepiece in or out of the light.

When both the viewing screen and aperture opening can be distinguished, check that the viewing screen image is properly

aligned to the aperture opening (indicated below in grey).

Regardless of the screen or format, the entire full frame indicated on all screens, should be centered to the entire aperture opening of the camera gate.

The tolerance for this alignment is approximately the thickness of a line of the screen. If the viewing screen does not seem to be aligned properly, check its seating by pressing against the threaded hole with your thumb.

• 3. Shifting the Viewfinder

The viewing optics of the camera need to be set to the new optical center of the shifted viewing screen.

Remove the viewfinder assembly from the camera by removing the four allen screws and spacer that hold the base of the viewfinder to the front housing. Take note of the side on which the spacer has been removed. The spacer is used to fill the gap that is created when shifting the viewfinder between formats. Replace the viewfinder assembly accordingly:

Secure the viewfinder by installing the spacer on the appropriate side and installing the four screws loosely. After all four screws are in place, tighten each screw until it is snug.

• 4. (a) Shifting the PL Lens Port

The PL lens port needs to be reset to the new optical center of the shifted viewing screen and viewfinder.

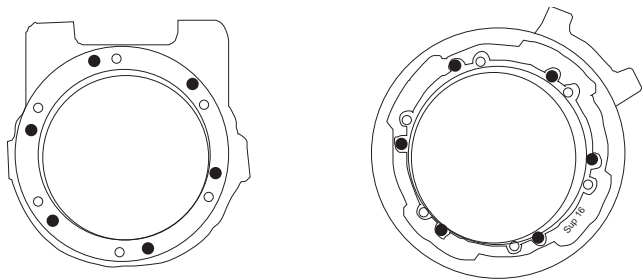

- *Super 16*
- *16 Standard*

If the port cap is on, remove it. Notice that there are six slotted screws which lock the lens port ring to the lens holder, each with an unoccupied hole alongside it. Also note that one of each pair of holes will be marked with a red dot indicating Super16 positioning. Remove the six screws and carefully lift off the lens port ring and its accompanying shims and place on a clean surface with the shim side face up. Take note of the screw holes from which the six screws have been removed. Also note an unoccupied hole alongside each. Shift the lens port by refastening the lens port ring utilizing the second set of screw holes on both the lens port ring and the lens holder. The clockwise-side holes on both are for standard 16 positioning, the counter-clockwise holes are for Super16. Carefully replace the lens port ring and its shims, and install the six screws in the appropriate holes as detailed in the diagram below. Be sure not to damage the shims; take extra care to align their cutouts around the holes to be used. Fasten the screws, then loosen each 1/2 a turn in preparation for fine centering.

- 4. (b) Shifting the Aaton Lens Port

Follow the procedure below if your camera is equipped with an Aaton lens port.

If the port cap is on, remove it. Remove the lens stop knob by loosening the single slotted or allen screw which secures it to the lens lock ring.

Remove the lens lock ring by unscrewing it off the lens port ring. Take a look at the lens port ring. Notice that there are three allen head screws which lock the lens port ring to the lens holder, each with an unoccupied hole alongside it. Also note that one of each pair of holes will be marked with a red dot indicating Super16 positioning.

Remove the three allen screws and carefully lift off the lens port ring and its accompanying shims and place on a clean surface with the shim side face up. Take note of the screw holes from which the three screws have been removed. Also note an unoccupied hole alongside each.

Shift the lens port by refastening the lens port ring utilizing the second set of screw holes on both the lens port ring and the lens holder. The clockwise-side holes on both are for standard 16 positioning, the counter-clockwise holes are for Super16. Carefully replace the lens port ring and its shims, and install the three allen screws in the appropriate holes as detailed in the diagram. Be sure not to damage the shims; take extra care to align their cutouts around the holes to be used. Fasten the three screws, then loosen each 1/2 a turn in preparation for fine centering.

- 5. Fine-Centering of the Lens Port.

There are two methods by which to set the exact centering of the lens to the viewing screen. Both methods are equally acceptable.

Method 1 - via the Port Alignment Tool

The port alignment tool consists of the alignment jig and the centering rod.

Check that the screws of the lens port ring are loose enough that the ring can move independently of the lens holder.

Clear the mirror shutter as described in Step 1 so that it is rotated safely inside the body and the aperture opening could be seen from the lens port opening. Make sure that the battery is removed from the body before proceeding further.

Remove the centering rod from the alignment jig and position the jig over the lens port ring with the jig's engravings facing out. Make sure the alignment jig is flush against the surface of the lens port ring.

While holding the jig in place and looking at the aperture plate, carefully slide the appropriate side (16 / Super16) of the centering rod through the jig and into the port until it peeks through the outside of the aperture plate. If the centering rod is not centered to the aperture plate and cannot slide through its opening, gently move the lens port ring until it can do so.

For 16 centering, you'll notice that the 16 end of the centering rod is narrower than the aperture and can easily fit in place. In this case,

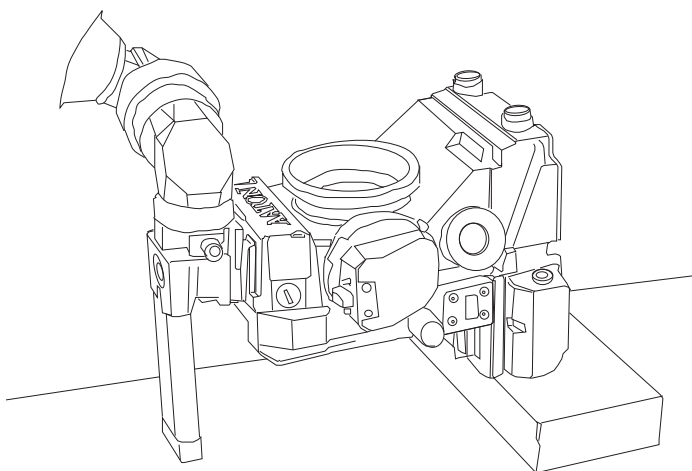

make sure that the right edge of the centering rod is flush against the right edge of the aperture opening.

For Super16 centering, make sure the Super16 end of the centering rod fits evenly through the aperture opening.

When the centering rod is aligned accordingly, firmly secure the screws of the lens port ring.

On Aaton lens ports, replace the lens lock ring by screwing it onto the lens port ring until it stops, then backing it off until the lock stop knob screw hole is at the 2 o'clock position. Install the lock stop knob and secure its screw.

Install the port cap to check that the lens lock ring functions properly.

Method 2 - via Lens Tracking

Replace the lens lock ring and lock stop knob as described immediately above.

Check that the three allen screws of the lens port ring are just loose enough that the ring can move independently of the lens holder.

On a piece of paper, draw a + mark in the center of the page that extends out to its edges so that the page is divided into four equal quadrants. Tape or pin the paper to the ceiling directly above your working surface.

Position the camera body underneath the paper target with the lens port facing up towards the target. Use a block of wood or a spacer of sorts to position the camera so that the lens port is approximately parallel to the ceiling.

Select the zoom lens that will be used most frequently with the camera; preferably the lens in your kit with the longest zoom ratio. Mount the lens on the camera and tighten the lens lock ring moderately.

Look through the viewfinder and set the zoom of the lens to its full telephoto position. Focus the lens on the target and reposition the camera body so that the center of the viewing screen cross-hair exactly matches the center of the target.

Set the zoom to complete wide-angle position and notice that the center of the target with relation to the viewing screen cross-hair will track off in one direction. Without moving the camera steady, reposition the lens and lens port ring until the target is centered. Using an allen L wrench, carefully tighten the screws enough to secure the lens port ring.

Set the zoom lens to telephoto position and check that the crosses remain centered. If this is not the case, reposition the body, loosen the screws slightly and repeat the above procedure. You will find that, with each adjustment, you will come closer to the correct lens centering.

When the cross on the target matches and holds its center through the entire zoom range, firmly secure the screws. The target cross should keep within the inside edges of the viewing screen cross-hair to be considered in tolerance through the range.

- 6. Realigning the CCD Assist Target

The CCD assist needs to be repositioned and refocused to be properly aligned to the new optical center. See section 12.4 of the Camera Body chapter to proceed.

7

AATONCODE

7.1 CONCEPT

AatonCode, Aaton's proprietary in-camera timecode system, is recorded in the XTRprod on the edge of the film between the perforations in both matrix and man-readable form. As recorded in the camera, AatonCode contains a six digit production ID, a SMPTE-compatible real time address (full date and time), a camera equipment ID and the running speed of the body.

Timecode is exposed onto the film by means of seven micro-diodes, which flash rapidly to form the code as the film rolls through the gate. The intensity of the diodes is adjusted to the film's sensitivity by means of the camera's ASA selection.

The XTRprod can accept timecode information in both ASCII and SMPTE form, and work with all standard timecode devices.

Because the same time address is running in both the camera and the sound recorder, a slate is no longer needed for syncing purposes; synchronization becomes fully automatic during the film/tape transfer or later post-production stages.

An Aaton device called Keylink, which consists of CCD reader heads and a PC, and which is owned by the telecine house, is designed to read Keycode and Aatoncode off the film during transfer and correlate this to the continuous video timecode and all other colorist entries for storage on its hard drive. Keylink can also ingest scene/take information and notes from the set recorded by means of Aaton's Script Supervisor software.

The facility can then supply all correlated information in VITC (vertical interval timecode) and/or burn-in windows on the transferred tape, and also on floppy disk for direct use with non-linear editing systems, audio workstations and logging programs.

7.2 THE INTERNAL CLOCK

The XTRprod contains an internal clock designed to be initialized from an outside source and keep accurate time (within a half a

frame) for 8 hours. After 8 hours of keeping time, the yellow diode on the base of the XTRprod will flash once every four seconds, indicating that accurate time is no longer guaranteed.

In order for the internal clock to operate, the camera must be powered before initialization. The camera is also equipped with an instantly charged supercapacitor buffer that is designed to keep time between battery changes. Keep in mind that a battery which is too low to run the camera has enough energy to drive the internal clock for hours. Get into the habit of leaving an exhausted battery on-board the camera until you have a fresh battery close by. The supercapacitor allows a full minute for battery replacement before timecode is lost.

7.3 ORIGINPLUS

For the most efficient and foolproof means of working with AatonCode, it is highly recommended that an Aaton device called OriginCplus is used. OriginCplus can be quickly programmed with a production ID, full date and time of day, then initialize timecode devices in either ASCII or SMPTE form.

OriginCplus is TCXO-controlled and will run for 150 hours with an internal 9V lithium cell; it is designed to be left on during the shoot day and used as a comparator to monitor timecode drift between devices.

OriginCplus can also be used as a SMPTE generator to supply accurate timecode for slates and inserters, or to record timecode on one audio channel of a non-timecode audio recorder.

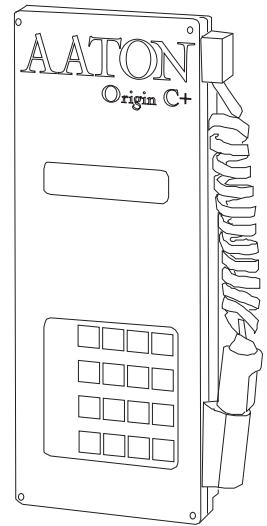

7.4 INITIALIZING AATONCODE IN THE CAMERA

There are two ways in which AatonCode can be initialized in the

XTRprod camera. The preferred method is by means of the OriginCplus, which inputs timecode in ASCII form. It is also possible for the camera to receive information in SMPTE form directly from a SMPTE timecode device such as an TC audio recorder. Both methods are detailed below.

7.4.1 Using the OriginCplus - Recommended Method• •

Program the OriginCplus by inputting Prod ID, accurate date and time of day. Press the # key to scroll through each field; after all fields are set as desired, Press * to start the clock.

- Make sure the camera has a battery attached.
- Plug the Lemo5 cable of the OriginCplus into Lemo5 chassis mount on the base of the camera. On the XTRprod, the Lemo5 connector is located on the motor side to the lower left of the motor.
- Press * on the OriginCplus to send the timecode information. The

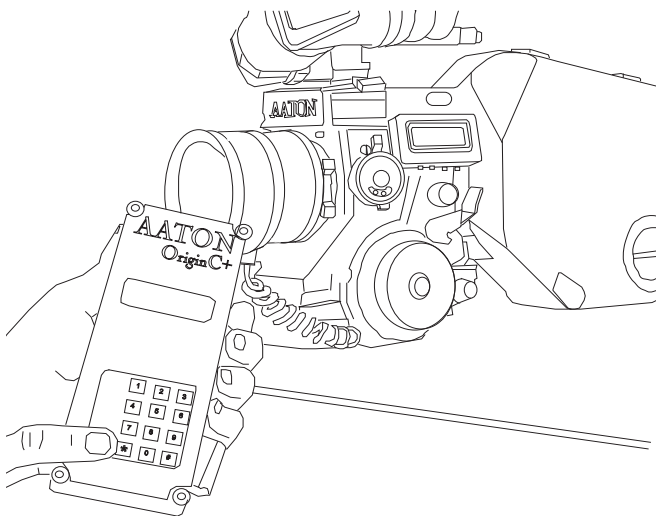

OriginCplus will display Good 00.0 after the timecode has been accepted by the camera. Likewise, the small yellow diode on the

camera base will blink to indicate running timecode. Also, the control panel of the XTRprod will display hours/minutes/seconds when the button marked time is selected. Toggling this button will also display year/month/day, then the production ID, then the equipment #.

- Make sure to adjust the ASA selection to the exposure index of the film stock being used.
- Disconnect the OriginCplus from the body and proceed to the next device.

For further details on the OriginCplus, please refer to the publication entitled OriginCplus - Initializing and Monitoring Aaton Timecode.

7.4.2 Using an External SMPTE Device

- Make sure the XTRprod has a battery attached and is not running.
- Choose the SMPTE timecode device that will be supplying the timecode (such as a Fostex PD2 or a Nagra IVS-TC). Set the time of day and date, and set its clock to free run mode.
- Connect a cable from the SMPTE output of the timecode device to the Lemo5 chassis mount on the base of the camera.
- Set the on/off switch on the camera to run or test position, then off again; this will send the timecode information to the camera body. The small yellow diode on the camera base will blink to indicate running timecode. Also, the XTRprod will display hours/minutes/seconds when the button marked time is pressed. Toggling this button will also display year/month/day and the camera's equipment #. No production ID will be recorded.
- Disconnect the cable from the body and proceed to the next device.

7.5 MONITORING AND MAINTAINING AATONCODE

AAfter initialization, the OriginCplus should be left on during

production to act as a visual reference and for quick drift monitoring. Once timecode has been initialized into the camera(s) and sound recorder, accurate time will be individually maintained in each machine for six hours. It is suggested, however, that new timecode be re-initialized after four hours or so as a precautionary measure. Get into the habit of using the OriginCplus to monitor timecode drift in each device when possible; every 2-3 hours or so is recommended.

7.5.1 Monitoring AatonCode with OriginCplus

Assuming that the OriginCplus has been left on during the production, follow the simple procedure below to monitor drift in the camera.

- Plug the Lemo5 cable of the OriginCplus into the Lemo5 chassis mount connector at the base of the camera.
- Press * to monitor AatonCode drift. OriginCplus will compare its own timecode to that of XTRprod. OriginCplus will display Good, fair, bad or dif-time (different time) followed by the amount of drift in tenths of a frame.
- Follow the same procedure for each camera or sound recorder on the set running AatonCode. When initializing or monitoring timecode in a SMPTE device, press *0 on the OriginCplus.

7.5.2 Maintaining AatonCode without OriginCplus

If the OriginCplus has not been used and timecode has been set in the camera directly from the TC audio recorder, there is no way to monitor timecode drift between the two devices. In this case, it is recommended to simply re-jam the camera every two to three hours. Follow the procedure detailed in section 4.2 Using an External SMPTE Device

Make sure that the camera on/off is switched to run or test position for it to accept the newly fed code.

7.6 GMT1

Because more and more cineasts are using sound recorders not

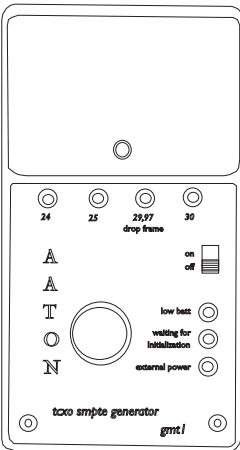

specifically designed for cinema, which means with no integrated timecode, Aaton needed to modify its OriginCplus: now, OriginCplus is able to serve as a SMPTE generator, which you can connect to any sound recorder.

But OriginCplus may be too big and too powerful for such an usage. So Aaton decided to built the GMT1, a mini SMPTE generator also designed to provide a timecode track for any sound recorder. The GMT1 is smaller than the OriginCplus, and it can work continuously for 150 hours with just a standard 9V battery. Its timecode informations (time and date) can be initialized with any SMPTE generator as with OriginCplus.

To choose the timcode frequency you need (according to the speed of your camera), remove the battery cover and turn the small white cross, beside the 9V battery, with a screwdriver. You can choose between 24, 25, 29.97 and 30 fps. To each choosen frequency correspond one LED, which flash every second.

You can also use the GMT1 as an OriginCplus supplier: if one day, by mistake, you have forgotten to take your OriginCplus with you, then use the GMT1 to initialize timecode in your camera. The GMT1, with no timecode initialized inside, is still able to generate a SMPTE code, starting at 1h 00mn 00s.

7.7 THE CAMERA ASSISTANT'S DUTIES

Although timecode-related practices on the set are very straightforward and uncomplicated, there are a few duties which should be handled by the camera assistant as part of his / her routine.

7.7.1 Checking the Diodes

In order to inspect and clean the gate between magazine rolls, the camera must be set to test position. Not only will test position rotate the shutter 180°, but the seven timecode LEDs in the gate will illuminate in a three/four sequence. Use this pattern to occasionally check that all diodes are operational and evenly

illuminated. As part of the normal gate cleaning procedure, clean this area with a Q-tip and lens cleaning fluid to assure that no dust particles cover the LED array.

The seven diodes will illuminate in test position whether or not timecode is running in the camera.

8.7.2 Setting the ASA

When changing magazines, make sure the ASA/ISO setting of the camera matches the film stock being used. To check the current ASA selection on the LCD control panel, press the button marked ISO twice . To adjust the ASA setting, press SET, then this button. Make your selection between 25 and 1000 ISO by toggling the button or by rotating the jog wheel.

7.7.3 Checking for Running Time

The yellow LED located to the right of the motor, will flash once per second on the second when timecode is running in the camera. Get into the habit of looking for this flash as an additional peace of mind check. If more than one camera is counting time on the set, check that all flashes occur simultaneously.

8

TECHNICAL SPECIFICATIONS

TECHNICAL SPECIFICATIONS

Weight 6kg / 13 lbs with 400 ft load and 12V on-board battery.

Power 10-14 V, 600 mA, with film à 25°C / 77°F.

Temperature range -20°C / +4°F to +40°C / +104°F.

Noise level 20 dB -1/+2.

Speeds preset speeds of 6, 12, 18, 20, 23.98, 24, 25, 29.97, 30, 36, 40, 48, 60 and 75 fps. Built-in variable crystal control from 3 to 75 fps in 0.001 increments.

Image stability Co-planar claw and lateral pressure. Vertical and lateral steadiness to 1/2000 of image dimensions.

Viewing screen Interchangeable fiber optical screens available in 1.33, 1.66, 1.78 (16/9) and 1.85 aspect ratios and combinations thereof. Aatonite illuminated markings.

Lens port Interchangeable hard fronts: ArriPL as standard. Aaton universal and Panavision on option.

Shutter Reflex mirror - multi-position 180°, 172.8°, 150°, 144°.

Formats 16 / Super16 operation. Field-convertible quick centering of lens axis, viewfinder and CCD target between formats.

Time recording AatonCode; in-camera, at-the-gate matrix recording of man-readable figures and machine readable data. TCXO control for 1/2 frame accuracy over 8 hours internal clock. SMPTE and ASCII-RS232 in.

Accessory inputs Amph9 (video sync), Lemo6 (power zoom), Lemo8 (phase controllers), Lemo14 (CCD assist), Lemo5 (Smpete and RS232 time input) and Lemo2 (camera on/off).

Video assist (option) Black & white - low power (170mA) high sensitivity, integrated CCD assist with manual iris. PAL or NTSC formats. Color - high sensitivity, flicker-free (frame-store in NTSC), integrated CCD assist with timecode windows, video generated adjustable frame and Vitc insertion. PAL or NTSC formats.

Magazine 400 ft, coaxial instant DX magazine, quick loading, magnetic drive, no timecode-related parts.

LCD control panel Illuminated display. Pre-set and variable speed selection, ASA selection, battery voltage monitoring, remaining footage, short end reset, elapsed footage, mag ID, full timecode readout.

Warnings Low speed, problem with the magazine, low battery, end of film coming soon.

8.2 CONNECTOR - PIN ATTRIBUTIONS

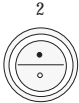
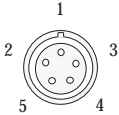
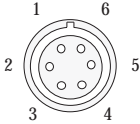
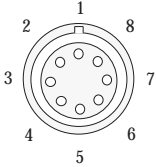
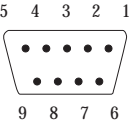
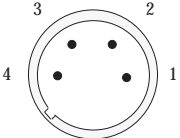
Type	Fonctions	Diagram	Localisation	Pin Attributions
Lemo2	On/Off/Test		<i>Between the two motors. Looking down.</i>	1 Ground 2 Start
Lemo5	TimeCode Interface		<i>Under jog wheel.</i>	1 Ground 2 Smpte In 3 ASCII In/Out 4 et 5 <i>Not used</i>
Lemo6	Power Zoom		<i>Above the right motor.</i>	1 -Batt 4 +Batt 6 Start 2, 3 & 5 <i>Not used</i>
Lemo8	Speed Controllers		<i>Above and to the right of the left motor.</i>	1 -Batt 2 TV Sync 3 ASCII In/Out 4 +Batt 5 100 PFF Out 6 Start 7 100 PFF In 8 Ground
Amph9	Video Sync		<i>Above the left motor.</i>	1 -Batt 2 TV Sync 3 2400 Hz 4 ASCII In/Out 5 +Batt 6 -Batt 7 Strobe 8 Start 9 +Batt
XLR4	Power In		<i>Above the jog wheel.</i>	1 -Batt 4 +Batt 2 et 3 <i>Not used</i>

● pin ○ socket

*Do not hook accessoires consommant more than 2 amps

AVAILABLE VIEWING SCREENS

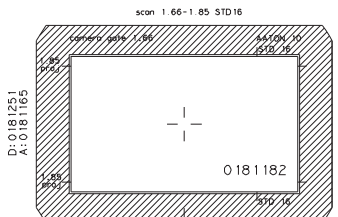
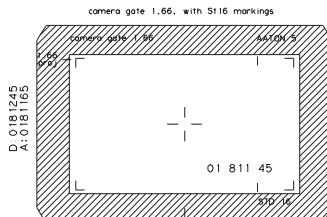
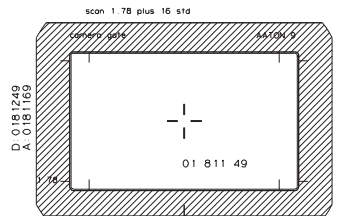
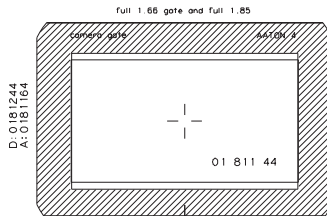
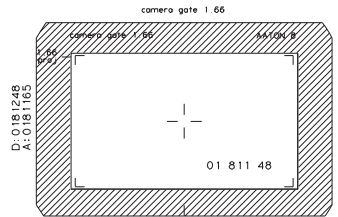
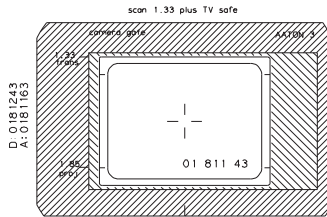
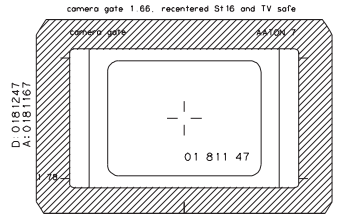
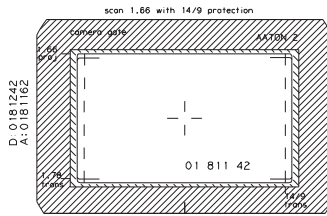
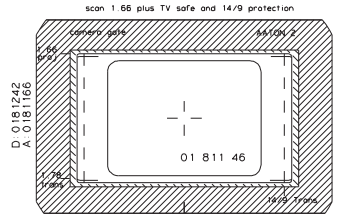
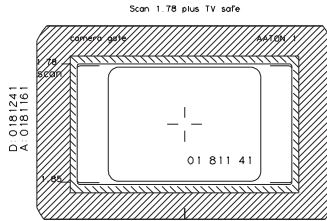

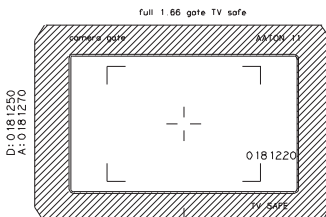
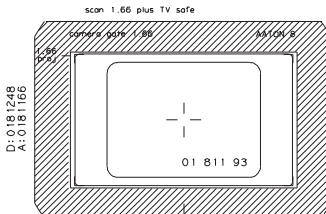
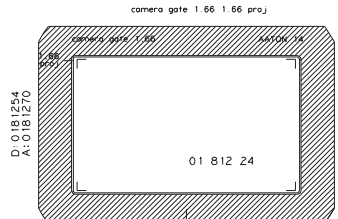
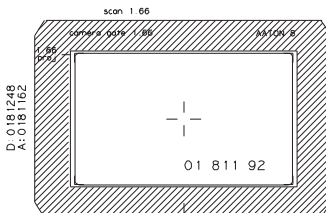
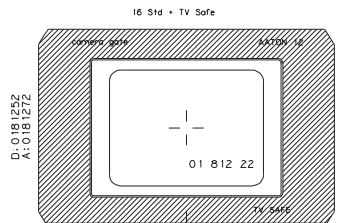
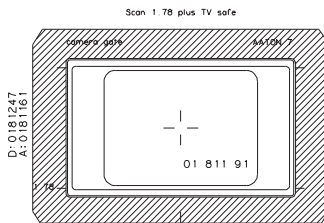
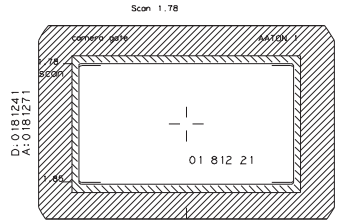
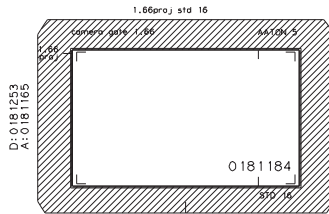

9

WORLDWIDE SUPPORT

Australia

LEMAC FILM

277 Highett Street

Victoria 3121 RICHMOND

Contact: John Bowring

Tel : 61 3429 8588

Fax : 61 3428 3336

Belgium

COLOR BY DEJONGHE

Diskmuidekaai 4

B 8500 KORTRIJE

Contact: Dirk Dejonghe

Tel : 32 56 350 710

Fax : 32 56 350 780

Brazil

HAGA DE

Rua Sergipe 475 cj. 711

Cep 01234-001 SAO PAULO

Contact: Hugo Kowenski

Tel : 55 11 258 5752

Fax : 55 11 258 5752

Canada

OLE CANADA

3981 Boul St. Laurent

Mezzanine 2

H2W 1Y5 Montréal Québec

Contact: René Daigle

Tel : 1 514 844 8555

Fax : 1 514 844 3777

Denmark

ZIMMERMANN

H.C. Orstedesvej 11B

DK-1879 FRDERIKSBERG

Contact: Poul Zimmerman

Tel :45 33 25 85 25

Fax :45 33 25 85 23

France

AATON S.A.

2, rue de la Paix

38000 Grenoble

Contact: Danys Bruyère

Tel : 4 76 42 95 50

Fax : 4 76 51 34 91

Germany

DEDO WEIGERT FILM

Karl-Weinmair Strasse 10

8000 MUNCHEN 40

Contact: Dedo Weigert

Tel : 49 89 35616 01

Fax : 49 89 35660 56

Great Britain

ICE FILM EQUIPMENT

The Robert Elliot Center

1 Old Nichol Street

Shoreditch LONDON E2 7HR

Contact: Peter Bryant

Tel : 44 71 739 4800

Fax : 44 71 729 2554

Greece

CHASSAPIS

Olymbou St 55

152 34 HALANDRI ATHEN

Contact: Stravos Chassapis

Tel : 30 1 6821 237

Fax : 30 1 6846 584

Holland

HOLLAND EQUIPMENT

HJE Wenkebachweg 49

1090 AK AMSTERDAM

Contact: Nico Van Den Boogard

Tel: 31 206 943 575

Fax : 31 206 685 381

Japan

SUZUKI ENTERPRISE

Dai Ichi Nishiya Bldg 2F 1-3-7

Hatagaya Shibuya-Ku

Tel : 81 3 5350 8235

151 TOKYO

Fax : 81 3 5350 8237

Contact: Sadaaki Suzuki

Portugal

ANIMATOGRAFO

Rua da Rosa 252-2

Tel : 351 1 347 4593/5372

1200 LISBOA

Fax : 351 1 347 3252

Contact: Antonio Cunha Telles

Spain

EPC

Nieremberg 29

Tel : (341) 519 4221

28002 MADRID

Fax : (341) 519 2198

Contact: Oscar Perez

Suède

RE FILM SERVICE AB

Strindbergsgatan 58

Tel : 46 8 662 25 35

115 53 STOCKHOLM

Fax : 46 8 662 25 03

Contact: Lars Wedberg

Switzerland

GH team

15 Chemin de la Rochette

Tel : 41 22 733 0638

1202 GENEVE

Fax : 41 22 734 4489

Contact: Georges Hofer

USA

AATON DES AUTRES

4110 West Magnolia Blvd

Burbank, CA 91505

Contact: Pierre Michoud

Tel : 1 (818) 972 9078

Fax : 1 (818) 972 2673

ABEL CINE TECH

66 Willow Avenue

Staten Island, NY 10305

Contact: Peter & Rich Abel

Tel : 1 (718) 273 8108

Fax : 1 (718) 273 8137

Eastern Countries

INTERLAB

5 rue Jacques Grevin

78540 VERNUILLET

Contact: Erik & David Stein

Tel : 33 1 3971 7337

Fax : 33 1 3971 0566