

Nikon

En

The **Nikon** Guide to Digital Photography
with the

D100

DIGITAL CAMERA



CE

Product Documentation

The documentation for this product includes the manuals listed below. Please be sure to read all instructions thoroughly to get the most from your camera.

Quick Start Guide

The *Quick Start Guide* takes you through the process of unpacking and setting up your Nikon digital camera, taking your first photographs, and transferring them to your computer.

Guide to Digital Photography

The *Guide to Digital Photography* (this manual) provides complete operating instructions for your camera.

Nikon View 5 Reference Manual

The *Nikon View 5 Reference Manual* can be found in electronic format on the reference CD provided with your camera. For information on viewing the *Reference Manual*, see the *Quick Start Guide* .

CAUTION: Foreign Matter on the CCD

Nikon takes every possible precaution to prevent foreign matter from coming into contact with the CCD during production and shipping. The D100, however, is designed to be used with interchangeable lenses, and foreign matter may enter the camera when lenses are removed or exchanged. Once inside the camera, this foreign matter may adhere to the CCD, where it may appear in photographs taken under certain conditions. To prevent foreign matter from entering the camera, do not exchange lenses in dusty environments. To protect the camera when no lens is in place, be sure to replace the body cap provided with the camera, being careful to first remove all dust and other foreign matter that may be adhering to the body cap.

Should foreign matter find its way onto the CCD, clean the CCD as instructed on pages 186–187 of this manual, or have the CCD cleaned by authorized Nikon service personnel. Photographs affected by the presence of foreign matter on the CCD can be retouched using the clean image options available in some third-party imaging software.

How to Read This Manual

First, be aware of the warnings, cautions, and notices on pages ii–vii.

Next, read “Overview” and “Getting to Know the Camera” to familiarize yourself with the conventions used in this manual and the names of camera parts, then set up your camera as described in “First Steps.”

Now you are ready to take photographs and play them back.

Once you have mastered the basics of digital photography, you can read these sections for complete information on when and how to use camera controls.

Read this chapter for more on thumbnail playback, playback zoom, and photo information.

Refer to these chapters for information on camera menus and custom settings...

...on connecting your camera to a television or computer...

...and on optional accessories, camera care, and troubleshooting.

Overview



Getting to Know the Camera



First Steps



Basic Photography



Basic Playback



Choosing a Shooting Mode



Image Quality and Size



Sensitivity (ISO Equivalency)

ISO

White Balance



Image Adjustment



Focus



Exposure



Flash Photography



Self-Timer Mode



More About Playback



Menu Guide



Connections



Technical Notes



For Your Safety

To prevent damage to your Nikon product or injury to yourself or to others, read the following safety precautions in their entirety before using this equipment. Keep these safety instructions where all those who use the product will read them.

The consequences that could result from failure to observe the precautions listed in this section are indicated by the following symbol:



This icon marks warnings, information that should be read before using your Nikon product to prevent possible injury.

WARNINGS



Do not look at the sun through the viewfinder

Viewing the sun or other strong light source through the viewfinder could cause permanent visual impairment.



Turn off immediately in the event of malfunction

Should you notice smoke or an unusual smell coming from the equipment or from the AC adapter (available separately), unplug the AC adapter and remove the battery immediately, taking care to avoid burns. Continued operation could result in injury. After removing the battery, take the equipment to a Nikon-authorized service center for inspection.



Do not use in the presence of flammable gas

Do not use electronic equipment in the presence of flammable gas, as this could result in explosion or fire.



Do not place strap around neck

Placing the camera strap around your neck could result in strangulation. Special care should be taken to avoid placing the strap around the neck of an infant or child.



Do not disassemble

Touching the product's internal parts could result in injury. In the event of a malfunction, the product should be repaired only by a qualified technician. Should the product break open as the result of a fall or other accident, remove the battery and/or AC adapter and then take the product to a Nikon-authorized service center for inspection.



Observe proper precautions when handling batteries

Batteries may leak or explode if improperly handled. Observe the following precautions when handling batteries for use in this product:

- Be sure the product is off before replacing the battery. If you are using an AC adapter, be sure it is unplugged.
- Use only batteries approved for use in this equipment.
- Do not attempt to insert the battery upside down or backwards.
- Do not short or disassemble the battery.
- Do not expose the battery to flame or to excessive heat.
- Do not immerse in or expose to water.
- Do not transport or store with metal objects such as necklaces or hairpins.

- Batteries are prone to leakage when fully discharged. To avoid damage to the product, be sure to remove the battery when no charge remains.
- When the battery is not in use, attach the terminal cover and store in a cool place.
- Immediately after use, or when the product is used on battery power for an extended period, the battery may become hot. Before removing the battery, turn the camera off and allow the battery to cool.
- Discontinue use immediately should you notice any changes in the battery, such as discoloration or deformation.

 **Use appropriate cables**

When connecting cables to the input and output jacks, use only the cables provided or sold by Nikon for the purpose, to maintain compliance with product regulations.

 **Keep out of reach of children**

Particular care should be taken to prevent infants from putting the battery or other small parts into their mouths.

 **Removing memory cards**

Memory cards may become hot during use. Observe due caution when removing memory cards from the camera.

 **CD-ROMs**

The CD-ROMs on which the software and manuals are distributed should not be played back on audio CD equipment. Playing CD-ROMs on an audio CD player could cause hearing loss or damage the equipment.

 **Observe caution when operating the flash**

Using the flash close to your subject's eyes could cause temporary visual impairment. Particular care should be observed if photographing infants, when the flash should be no less than one meter (39") from the subject.

 **When using the viewfinder**

When operating the diopter adjustment control with your eye to the viewfinder, care should be taken not to put your finger in your eye accidentally.

 **Avoid contact with liquid crystal**

Should the monitor break, care should be taken to avoid injury due to broken glass and to prevent liquid crystal from the monitor touching the skin or entering the eyes or mouth.

Caring for the Camera and Battery

Do not drop

The product may malfunction if subjected to strong shocks or vibration.

Keep dry

This product is not waterproof, and may malfunction if immersed in water or exposed to high levels of humidity. Rusting of the internal mechanism can cause irreparable damage.

Avoid sudden changes in temperature

Sudden changes in temperature, such as occur when entering or leaving a heated building on a cold day, can cause condensation inside the device. To prevent condensation, place the device in a carrying case or a plastic bag before exposing it to sudden changes in temperature.

Keep away from strong magnetic fields

Do not use or store this device in the vicinity of equipment that generates strong electromagnetic radiation or magnetic fields. Strong static charges or the magnetic fields produced by equipment such as radio transmitters could interfere with the monitor, damage data stored on the memory card, or affect the product's internal circuitry.

Do not touch the shutter curtain

The shutter curtain is extremely thin and easily damaged. Under no circumstances should you exert pressure on the curtain, poke it with cleaning tools, or subject it to powerful air currents from a blower. These actions could scratch, deform, or tear the curtain.

Handle all moving parts with care

Do not apply force to the battery-chamber, card-slot, or connector covers. These parts are especially susceptible to damage.

Cleaning

- When cleaning the camera body, use a blower to remove dust and lint, then wipe gently with a soft, dry cloth. After using your camera at the beach or seaside, wipe off any sand or salt using a cloth lightly dampened with pure water and then dry your camera thoroughly. In rare instances, static electricity produced by a brush or cloth may cause the LCD displays to light up or darken. This does not indicate a malfunction, and the display will shortly return to normal.
- When cleaning the lens and mirror, remember that these elements are easily damaged. Dust and lint should be gently removed with a blower. When using an aerosol blower, keep the can vertical (tilting the can could result in liquid being sprayed on the mirror). If you do get a fingerprint or other stain on the lens, apply a small amount of lens cleaner to a soft cloth and wipe the lens carefully.
- See "Technical Notes: Caring for Your Camera" for information on cleaning the CCD.

Storage

- To prevent mold or mildew, store the camera in a dry, well-ventilated area. If you will not be using the product for long periods, remove the battery to prevent leakage and store the camera in a plastic bag containing a desiccant. Do not, however, store the camera case in a plastic bag, as this may cause the material to deteriorate. Note that desiccant gradually loses its capacity to absorb moisture and should be replaced at regular intervals.
- Do not store the camera with naphtha or camphor moth balls, close to equipment that produces strong magnetic fields, or in areas subject to extremes of temperature, for example near a space heater or in a closed vehicle on a hot day.

- To prevent mold or mildew, take the camera out of storage at least once a month. Turn the camera on and release the shutter a few times before putting the camera away again.
- Store the battery in a cool, dry place. Replace the terminal cover before putting the battery away.

Notes on the monitor

- The monitor may contain a few pixels that are always lit or that do not light. This is a characteristic common to all TFT LCD monitors and does not indicate a malfunction. Images recorded with the product will not be affected.
- Images in the monitor may be difficult to see in a bright light.
- Do not apply pressure to the monitor; this could cause damage or malfunction. Dust or lint on the monitor can be removed with a blower. Stains can be removed by rubbing the surface lightly with a soft cloth or chamois leather.
- Should the monitor break, care should be taken to avoid injury due to broken glass and to prevent the liquid crystal from the monitor touching the skin or entering the eyes or mouth.
- Replace the monitor cover when transporting the camera or leaving it unattended.

Turn the product off before removing or disconnecting the power source

Do not unplug the product or remove the battery while the product is on, or while images are being recorded or deleted. Forcibly cutting power to the product in these circumstances could result in loss of data or in damage to product memory or internal circuitry. To prevent an accidental interruption of power, avoid carrying the product from one location to another while the AC adapter is connected.

Batteries

- When you turn the device on, check the battery-level displayed in the control panel to determine whether the battery needs to be replaced. The battery needs to be replaced when the battery-level indicator is flashing.
- Ready a spare battery and keep it fully charged when taking photographs on important occasions. Depending on your location, you may find it difficult to purchase replacement batteries on short notice.
- On cold days, the capacity of batteries tends to decrease. Be sure the battery is fully charged before taking photographs outside in cold weather. Keep a spare battery in a warm place and exchange the two as necessary. Once warmed, a cold battery may recover some of its charge.
- Should the battery terminals become dirty, wipe them off with a clean, dry cloth before use.
- After removing the battery from the camera, be sure to replace the terminal cover.

Memory cards

- Turn the power off before inserting or removing memory cards. Inserting or removing cards with the power on could render them unusable.
- Insert memory cards as shown in the illustration at right. Inserting cards upside down or backwards could damage the camera or the card.

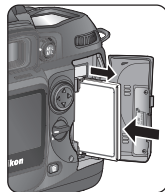

Notices

- No part of the manuals included with this product may be reproduced, transmitted, transcribed, stored in a retrieval system, or translated into any language in any form, by any means, without Nikon's prior written permission.
- Nikon reserves the right to change the specifications of the hardware and software described in these manuals at any time and without prior notice.
- Nikon will not be held liable for any damages resulting from the use of this product.
- While every effort has been made to ensure that the information in these manuals is accurate and complete, we would appreciate it were you to bring any errors or omissions to the attention of the Nikon representative in your area (address provided separately).

Notice for customers in the U.S.A.

Federal Communications Commission (FCC) Radio Frequency Interference Statement

This equipment has been tested and found to comply with the limits for a Class B digital device, pursuant to Part 15 of the FCC rules. These limits are designed to provide reasonable protection against harmful interference in a residential installation. This equipment generates, uses, and can radiate radio frequency energy and, if not installed and used in accordance with the instructions, may cause harmful interference to radio communications. However, there is no guarantee that interference will not occur in a particular installation. If this equipment does cause harmful interference to radio or television reception, which can be determined by turning the equipment off and on, the user is encouraged to try to correct the interference by one or more of the following measures:

- Reorient or relocate the receiving antenna.
- Increase the separation between the equipment and receiver.
- Connect the equipment into an outlet on a circuit different from that to which the receiver is connected.
- Consult the dealer or an experienced radio/television technician for help.

Nikon	D100
FC	Tested To Comply With FCC Standards
FOR HOME OR OFFICE USE	

CAUTIONS

Modifications

The FCC requires the user to be notified that any changes or modifications made to this device that are not expressly approved by Nikon Corporation may void the user's authority to operate the equipment.

Interface Cables

Use the interface cables sold or provided by Nikon for your equipment. Using other interface cables may exceed the limits of Class B Part 15 of the FCC rules.

Nikon Inc.,
1300 Walt Whitman Road,
Melville, New York
11747-3064, U.S.A.
Tel.: 631-547-4200

Notice for customers in Canada

CAUTION

This class B digital apparatus meets all requirements of the Canadian Interference Causing Equipment Regulations.

ATTENTION

Cet appareil numérique de la classe B respecte toutes les exigences du Règlement sur le matériel brouilleur du Canada.

Notice Concerning Prohibition of Copying or Reproduction

Note that simply being in possession of material that has been digitally copied or reproduced by means of a scanner, digital camera or other device may be punishable by law.

• Items prohibited by law from being copied or reproduced

Do not copy or reproduce paper money, coins, securities, government bonds, or local government bonds, even if such copies or reproductions are stamped "Sample."

The copying or reproduction of paper money, coins, or securities which are circulated in a foreign country is prohibited.

Unless the prior permission of the government has been obtained, the copying or reproduction of unused postage stamps or post cards issued by the government is prohibited.

The copying or reproduction of stamps issued by the government and of certified documents stipulated by law is prohibited.

• Cautions on certain copies and reproductions

The government has issued cautions on copies or reproductions of securities issued by private companies (shares, bills, checks, gift certificates, etc.), commuter passes, or coupon tickets, except when a minimum of necessary copies are to be provided for business use by a company. Also, do not copy or reproduce passports issued by the government, licenses issued by public agencies and private groups, ID cards, and tickets, such as passes and meal coupons.

• Comply with copyright notices

The copying or reproduction of copyrighted creative works such as books, music, paintings, woodcut prints, maps, drawings, movies, and photographs is prohibited except when it is done for personal use at home or for similar restricted and non-commercial use.

Trademark Information

Apple, the Apple logo, Macintosh, Mac OS, Power Macintosh, and PowerBook are registered trademarks of Apple Computer, Inc. Power Mac, iMac, and iBook are trademarks of Apple Computer, Inc. IBM and Microdrive are registered trademarks of International Business Machines Corporation. Microsoft and Windows are registered trademarks of Microsoft Corporation. MMX and Pentium are trademarks of Intel Corporation. CompactFlash is a trademark of SanDisk Corporation. Lexar Media is a trademark of Lexar Media Corporation. Zip is a registered trademark of Iomega Corporation in the U.S. and other countries. All other trade names mentioned in this manual or the other documentation provided with your Nikon product are trademarks or registered trademarks of their respective holders.

Table of Contents

For Your Safety	ii
Caring for the Camera and Battery	iv
Notices	vi
Introduction: Getting Started	1
Overview: About This Manual	2
Getting to Know the Camera: Camera Controls and Displays	4
First Steps: Getting the Camera Ready for Use	14
Step 1—Attach the Camera Strap	15
Step 2—Insert the Battery	16
Step 3—Choose a Language	18
Step 4—Set the Time and Date	19
Step 5—Attach a Lens	20
Step 6—Insert a Memory Card	22
Tutorial: Basic Photography and Playback	25
Basic Photography: Taking Your First Photographs	26
Step 1—Ready the Camera	27
Step 2—Adjust Camera Settings	28
Step 3—Frame a Photograph	30
Step 4—Focus	31
Step 5—Check Exposure	32
Step 6—Take the Photograph	34
Basic Playback: Viewing Photographs	35
Taking Photographs: The Details	37
The Shooting Menu	39
Choosing a Shooting Mode: Single Frame, Continuous, or Self-Timer	41
Image Quality and Size: Making Effective Use of Memory	43
Image Quality	44
Image Size	46
Sensitivity (ISO Equivalency): Reacting Faster to Light	48
White Balance: Keeping Colors True	50
Fine-Tuning White Balance	53
Preset White Balance	55
Image Adjustment: Shooting Menu Settings	58
Making Edges More Distinct: <i>Image Sharpening</i>	58
Adjusting Contrast: <i>Tone Compensation</i>	59
Suiting Colors to Your Workflow: <i>Color Mode</i>	60
Controlling Color: <i>Hue Adjustment</i>	62

Focus: Controlling How the Camera Focuses	63
Focus Mode	63
Focus Area Selection	64
Autofocus	65
Manual Focus	74
Exposure; Controlling How the Camera Sets Exposure	75
Metering	75
Exposure Mode	76
Autoexposure Lock	84
Exposure Compensation	86
Bracketing	87
Flash Photography: Using Built-in and Optional Speedlights	94
Flash Sync Modes	96
Using the Built-in Speedlight	98
Flash Exposure Compensation	102
Using an Optional Speedlight	103
Self-Timer Mode: Delaying Shutter Release	108
Two-Button Reset: Restoring Default Settings	110
More About Playback: Playback Options	111
Single-Image Playback	112
Photo Information	114
Viewing Multiple Images: Thumbnail Playback	116
Taking a Closer Look: Playback Zoom	118
Protecting Photographs from Deletion	119
Deleting Individual Photographs	120
Menu Guide: Index to Menu Options	121
Using Camera Menus: Basic Menu Operations	122
The Playback Menu: Managing Images	124
Deleting Photographs: <i>Delete</i>	124
Folder Options: <i>Folder Designate</i>	126
Automated Playback: <i>Slide Show</i>	128
Hiding Images During Playback: <i>Hide Image</i>	130
Ordering Prints: <i>Print Set</i>	131
Controlling Photo Info: <i>Display Mode</i>	134

The Shooting Menu: Shooting Options	135
Choosing a Settings Bank: <i>Bank Select</i>	135
File Type and Compression: <i>Image Quality</i>	136
Choosing an Image Size: <i>Resolution</i>	137
Keeping Colors True: <i>White Balance</i>	138
Setting Sensitivity: <i>ISO</i>	139
Making Edges More Distinct: <i>Image Sharpening</i>	140
Adjusting Contrast: <i>Tone Compensation</i>	141
Setting Colors Based on Workflow: <i>Color Mode</i>	142
Controlling Color: <i>Hue Adjustment</i>	143
Custom Settings: Fine-Tuning Camera Settings	144
The Setup Menu: Camera Setup	161
Formatting Memory Cards: <i>Format</i>	162
Adjusting Monitor Brightness: <i>LCD Brightness</i>	163
Readying the CCD for Inspection: <i>Mirror Lock-up</i>	163
Choosing a Video Standard: <i>Video Mode</i>	164
Adding Comments to Photographs: <i>Image Comment</i>	164
Connections: Connecting to External Devices	167
Television Playback: Connecting Your Camera to a Video Device	168
Connecting to a Computer: Data Transfer and Camera Control	169
Software for the D100	169
Direct USB Connection	172
Technical Notes: Camera Care, Options, and Resources	175
Optional Accessories: Lenses and Other Accessories	176
Lenses for the D100	176
Other Accessories	180
Approved Memory Cards	183
Caring for Your Camera: Storage and Maintenance	184
Storage	184
Cleaning	185
Troubleshooting: Understanding Error Messages and Displays	188
Web Resources: On-Line Resources for Nikon Users	192
Specifications	193
Index	198

Introduction

Getting Started

Overview



2–3



Getting to Know the Camera



4–13



First Steps



14–24



This chapter is divided into the following sections:

Overview

Read this section for a description of how this manual is organized and for an explanation of the symbols and conventions used.

Getting to Know the Camera

Bookmark this section and refer to it as you read through the manual for information on the names and functions of camera parts.

First Steps

This section details the steps you will take when using your camera for the first time: inserting the battery and memory card, attaching a lens and camera strap, and setting the date, time, and language.

This manual is designed to help you enjoy taking photographs with the advanced Nikon D100 single-lens reflex (SLR) digital camera. First-time users who can't wait to experience the simplicity and immediacy of digital photography can follow the step-by-step instructions in the *Quick Start Guide* or read "First Steps" and "Tutorial" in this manual, referring to "Getting to Know the Camera" for information on the location of camera controls and displays. Once you have mastered the basics, detailed information on when and how to use the various camera settings can be found in "Taking Photographs" and "Menu Guide." Information on what to do with your pictures once you have finished shooting is available in "Connections," which describes how to connect your camera to a television, video-cassette recorder, or computer.

Principal Features

- The D100 is equipped with a large (23.7 × 15.6 mm/0.9" × 0.6") CCD with 6.1 million effective pixels capable of producing photographs in three different sizes (3008 × 2000, 2240 × 1488, and 1504 × 1000 pixels).
- Proven elements of the D1-series' 3D digital matrix image control, including precise exposure control based on 3D matrix metering and TTL white balance for optimum color temperature measurements, have been further improved for unerring color reproduction and smooth tonal transitions.
- Three color modes, adapted to sRGB or Adobe color spaces, are available for different work flows.
- Photographs are stored in a temporary memory buffer during shooting, allowing up to six photographs (or four RAW images) to be recorded at a rate of approximately three frames per second.
- Noise reduction is available to reduce the occurrence of randomly-spaced, brightly-colored pixels at shutter speeds of around 1/2 s or slower.
- The D100's built-in Speedlight ensures that you will never miss the chance for that perfect shot, even when lighting is poor.
- The camera is equipped with an automatic sensitivity adjustment function that helps ensure optimal exposure when correct exposure can not be achieved at current settings.
- Twelve-bit output from the camera's CCD can be saved without modification as high-quality RAW data.
- The optional MB-D100 multi function battery pack can expand your camera's potential with voice-memo recording and a shutter-release button and command dials for taking photographs in vertical (portrait) orientation.

To make it easier to find the information you need, the following symbols and conventions are used:



This icon marks cautions, information that you should read before use to prevent damage to your camera.



This icon marks tips, additional information you may find helpful when using your camera.



This icon marks notes, information that you should read before using your camera.



This icon indicates that more information is available elsewhere in this manual.



This icon marks settings that can be adjusted using camera menus.



This icon marks settings that can be fine-tuned from the Custom Settings menu.



Take Test Shots

Before taking pictures on important occasions (for example, at weddings or before taking the camera with you on a trip), take a test shot to ensure that the camera is functioning normally. Nikon will not be held liable for damages or lost profits that may result from product malfunction.



Life-Long Learning

As part of Nikon's "Life-Long Learning" commitment to ongoing product support and education, continually-updated information is available on-line at the following sites:

- For users in the U.S.A.: <http://www.nikonusa.com/>
 - For users in Europe: <http://www.nikon-euro.com/>
 - For users in Asia, Oceania, the Middle East, and Africa: <http://www.nikon-asia.com/>
- Visit these sites to keep up-to-date with the latest product information, tips, answers to frequently-asked questions (FAQs), and general advice on digital imaging and photography. Additional information may be available from the Nikon representative in your area. See the URL below for contact information:
<http://www.nikon-image.com/lengl>



Replacing This Manual

Should you lose this manual, replacements can be ordered, for a fee, from any authorized Nikon service representative.





Getting to Know the Camera

Camera Controls and Displays

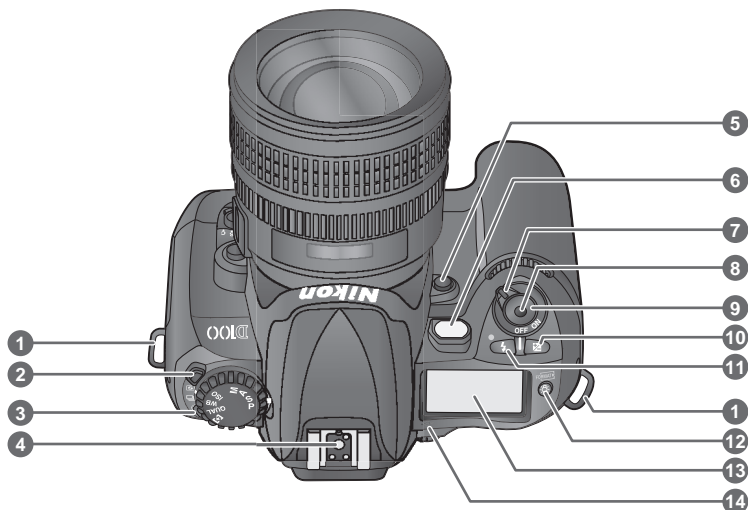
Take a few moments to familiarize yourself with camera controls and displays. You may find it helpful to bookmark this section and refer to it as you read through the rest of the manual.

Camera Body



- | | | | |
|---------------------------------------|-----|---|-----------|
| 1 Eyelet for camera strap | 15 | 8 Release terminal | 182 |
| 2 Shooting-mode dial lock release ... | 41 | 9 Shutter-release button | 31–34, 72 |
| 3 Shooting mode dial | 41 | 10 Exposure compensation () button | 86 |
| 4 Accessory shoe | 104 | 11 Flash sync mode () button | 98 |
| 5 Depth-of-field preview button | 76 | 12 LCD illuminator () button (press to illuminate control panel) | 155 |
| 6 AF-assist illuminator | 72 | Format () button | 23 |
| Self-timer lamp | 108 | 13 Control panel | 8 |
| Red-eye reduction lamp | 97 | 14 Focal plane mark () | 74 |
| 7 Power switch | 27 | | |

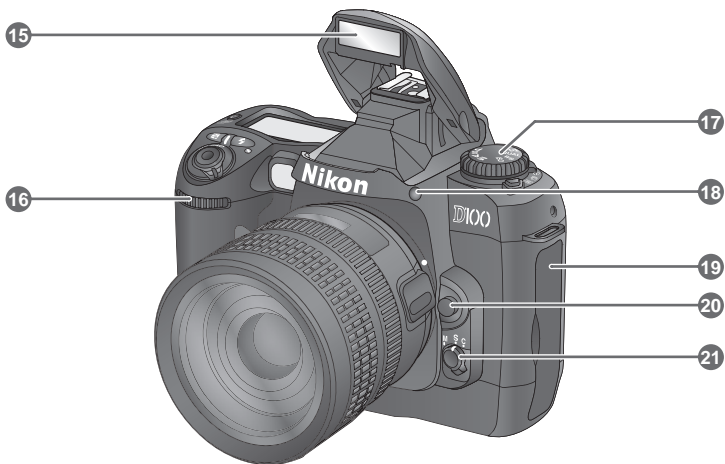

- | | | | | | |
|----|-------------------------------------|--------|----|-------------------------------|---------------|
| 15 | Built-in Speedlight | 94, 98 | 18 | Speedlight lock release | 98 |
| 16 | Sub-command dial | 12 | 19 | Connector cover | 168, 172, 191 |
| 17 | Function dial | 12 | 20 | Lens release button | 21 |
| | See also: | | 21 | Focus-mode selector | 63 |
| | Exposure mode | 76 | | | |
| | Sensitivity (ISO equivalency) | 48 | | | |
| | White balance | 50 | | | |
| | Image quality | 44 | | | |
| | Image size | 46 | | | |
| | AF-area mode | 65 | | | |







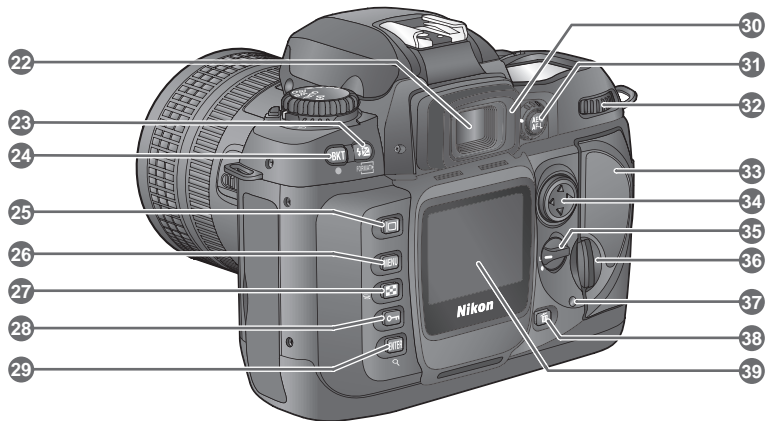

The LCD Illuminator



The control panel backlight (LCD illuminator) will light when the LCD illuminator button  is pressed, allowing you to confirm camera settings in the dark. The illuminator will remain lit while the camera exposure meters are active or until the shutter is released.



Camera Body (continued)



22	Viewfinder eyepiece	30
23	Flash exposure compensation () button	102
	Format () button	23
24	Bracketing () button	88
25	Monitor () button	35, 112
26	MENU () button	39, 122
27	Thumbnail () button	116
28	Protect () button	119
29	ENTER () button	40, 125
	Playback zoom (Q) button	118

30	Viewfinder eyepiece cup	30
31	AE/AF lock () button ..	70, 84, 154
32	Main command dial	12
33	Memory card slot cover	22
34	Multi selector	35, 39, 64, 114
35	Focus area lock switch	64
36	Memory card slot cover latch	22
37	Memory card access lamp	34
38	Delete () button	35, 120
39	Monitor	15, 35



- | | |
|---|--|
| <p>40 Tripod socket</p> <p>41 Connectors for MB-D100 180</p> <p>42 Metering selector 75</p> | <p>43 Diopter adjustment control 30</p> <p>44 Battery-chamber cover latch 16</p> <p>45 Battery-chamber cover 16, 180</p> |
|---|--|



Control Panel

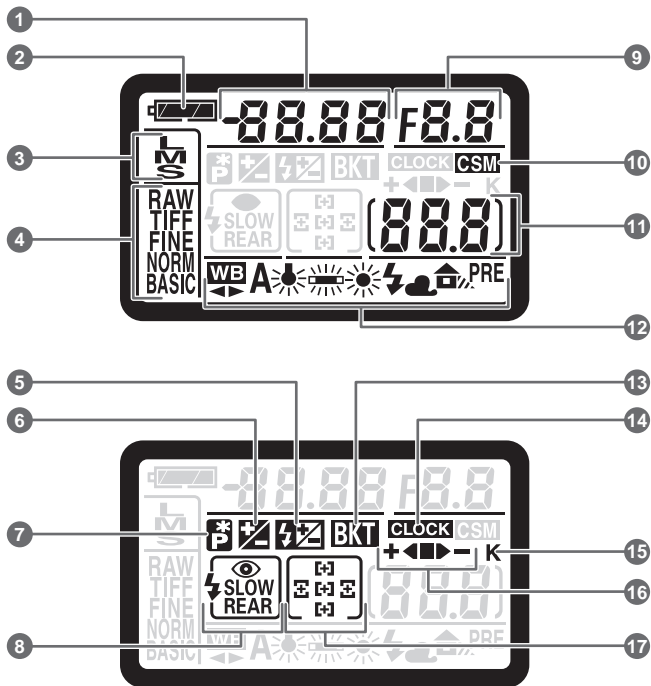

- | | | |
|----|---|-------|
| 1 | Shutter speed | 79–80 |
| | Sensitivity | 48 |
| | Exposure compensation value | 86 |
| | Flash compensation value | 102 |
| | Number of shots in bracketing
sequence | 88 |
| | White balance adjustment | 90 |
| 2 | Battery indicator | 17 |
| 3 | Image size | 46 |
| 4 | Image quality | 44 |
| 5 | Flash compensation indicator | 102 |
| 6 | Exposure compensation indicator .. | 86 |
| 7 | Flexible program indicator | 78 |
| 8 | Flash sync mode | 96 |
| 9 | Aperture | 81 |
| | Bracketing increment | 88 |
| | Image transfer mode indicator | 173 |
| 10 | Custom-settings indicator | 146 |
| 11 | Number of exposures remaining ... | 27 |
| | Number of shots remaining before
memory buffer fills | 41 |
| | Remote control mode indicator .. | 173 |
| 12 | White balance mode | 50 |
| 13 | Bracketing indicator | 88 |
| 14 | Clock battery indicator | 19 |
| 15 | “K” (appears when memory remains
for over 1,000 exposures) | 42 |
| 16 | Bracketing progress indicator | 89 |
| 17 | Focus area | 64–69 |



The Control Panel Display

The control panel display tends to darken and exhibit slower response times at high temperatures. The display will return to normal at room temperature.



The Viewfinder Display

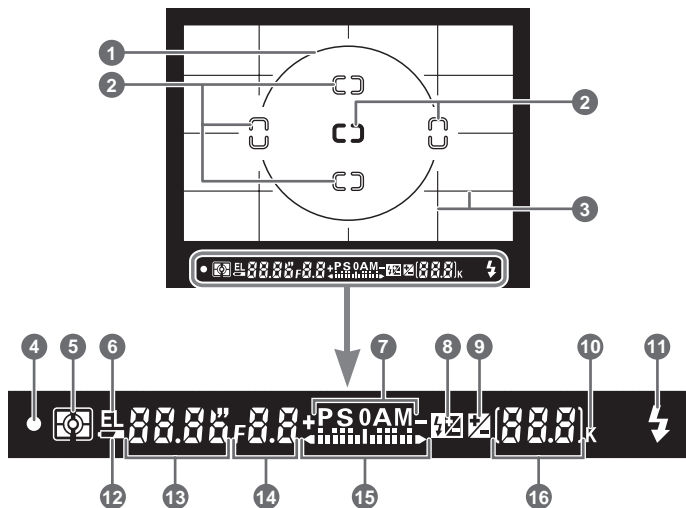

No Battery

When the battery is totally exhausted or no battery is inserted, the display in the viewfinder will dim. This is normal and does not indicate a malfunction. The viewfinder display will return to normal when a fully-charged battery is inserted.





The Viewfinder Display

The focus-area and grid-line displays in the viewfinder (advanced focusing screen display) tend to brighten at high temperatures and to darken and exhibit slower response times at low temperatures. The other displays in the viewfinder tend to darken and exhibit slower response times at high temperatures. All displays will return to normal at room temperature.

- | | |
|--|---|
| <ul style="list-style-type: none"> 1 12-mm (0.47") reference circle for center-weighted metering 75 2 Focus brackets (focus areas) ... 64–69
Spot-metering targets 75 3 Reference grid (displayed when ON is selected for Custom Setting 19) .. 157 4 Focus indicator 31, 70 5 Metering 75 6 Auto-exposure lock 84 7 Exposure mode 76 8 Flash compensation indicator 102 9 Exposure compensation indicator .. 86 10 "K" (appears when memory remains for over 1,000 exposures) 42 | <ul style="list-style-type: none"> 11 Flash-ready indicator 99 12 Battery indicator 17 13 Shutter speed 80, 82 14 Aperture 81–82 15 Electronic analog exposure display 83
Exposure compensation 86 16 Number of exposures remaining ... 27
Number of shots remaining before memory buffer fills 41
Exposure compensation value 86
Flash exposure compensation value 102 |
|--|---|



Advanced Focusing Screen Display

When the background is bright, the active focus area ( 64) is highlighted in black. When the background is dark, the active focus area is highlighted briefly in red as needed to establish contrast with the background ("**Vari-Brite**" focus areas), making it easier to identify the selected focus area. The viewfinder is also equipped with on-demand grid lines. When **ON** is selected for Custom Setting 19 (**Grid Display**;  157), a reference grid is superimposed over the display in the viewfinder. This grid is a useful aid when composing landscape shots or when tilting or shifting a PC Nikkor lens.

Owing to the characteristics of this type of viewfinder display, you may notice fine lines radiating outwards from the selected focus area, or that the display in the viewfinder turns red when the selected focus area is highlighted. These phenomena are normal and do not indicate a malfunction.

The Command Dials

The main- and sub-command dials are used alone or in combination with other controls to adjust a variety of settings.

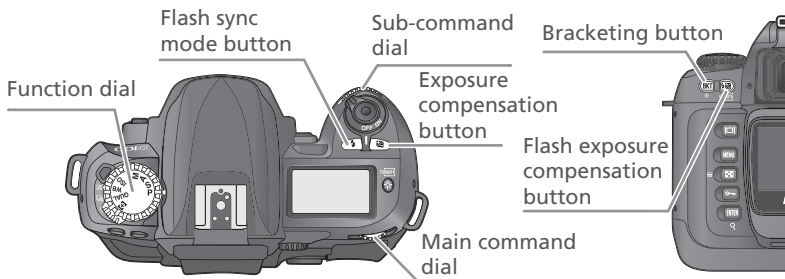

Image quality and size



+



Set image quality (46)

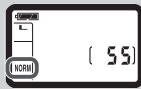

+



Choose an image size (47)



White balance



+



Choose a white balance setting (52)



+



Fine-tune white balance (53–54)/measure a value for preset white balance (56)

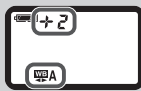

Sensitivity (ISO equivalency)



+



Set sensitivity (ISO equivalency; 49)



AF-area mode



+



Choose a setting for AF-area mode (p. 65)



Exposure



+



Choose a combination of aperture and shutter speed (exposure mode P (p. 78))



+



Choose a shutter speed (exposure mode S or M; p. 80)



+



Choose an aperture (exposure mode A or M; p. 81–82)

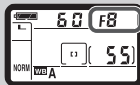

+



Set exposure compensation (when function dial set to P, S, A, or M; p. 86)



+



Activate or cancel bracketing (when function dial set to P, S, A, or M; p. 88)



+



Change bracketing settings (when function dial set to P, S, A, or M; p. 88)



Flash settings



+



Choose a flash sync mode (when function dial set to P, S, A, or M; p. 98)



+













Set flash compensation (when function dial set to P, S, A, or M; p. 102)



First Steps

Getting the Camera Ready for Use

Before using your camera for the first time, complete the following steps:

- | | | | |
|---------------|--|---|---------|
| STEP 1 | Attach the Camera Strap |  | 15 |
| STEP 2 | Insert the Battery |  | 16–17 |
| | <i>To learn more about batteries and alternative power sources, see:</i> | | |
| | • Technical Notes: Optional Accessories |  | 176–183 |
| | • Caring for the Camera and Battery |  | iv–v |
| STEP 3 | Choose a Language |  | 18 |
| STEP 4 | Set the Time and Date |  | 19 |
| STEP 5 | Attach a Lens |  | 20–21 |
| | <i>To learn more about the lenses available for the D100, see:</i> | | |
| | • Technical Notes: Optional Accessories |  | 176–183 |
| STEP 6 | Insert a Memory Card |  | 22–23 |
| | <i>To learn more about compatible memory cards, see:</i> | | |
| | • Technical Notes: Approved Memory Cards |  | 183 |
| | <i>For more information on formatting memory cards, see:</i> | | |
| | • The Setup Menu: Formatting Memory Cards |  | 162 |

Step 1—Attach the Camera Strap

Attach the camera strap securely to the two eyelets on the camera body as shown below.

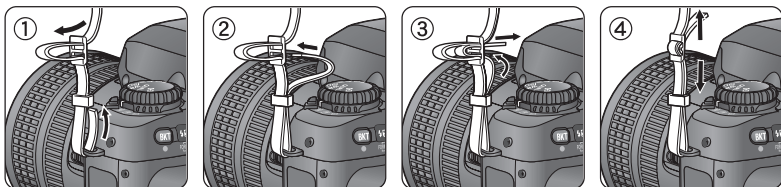

The Monitor Cover

A clear plastic cover (the BM-2 LCD monitor cover) is provided with the camera to keep the monitor clean, and to protect the monitor when the camera is not in use or when you are transporting the camera. To remove the monitor cover, hold the camera firmly and pull the bottom of the cover gently outwards as shown at right (1). Once the cover is unlatched, you can move it slightly away from the monitor (2) and then remove it as shown (3).



Do not lift bottom of cover past point shown



To replace the cover for shooting or storage, insert the two projections on the top of the cover into the matching indentations above the camera monitor (1), then press the bottom of the cover until you hear it click into place (2).



Step 2—Insert the Battery

Your camera is powered by a single rechargeable Nikon EN-EL3 lithium-ion battery (provided).

2.1 Charge the battery

The EN-EL3 battery supplied with your camera is not fully charged at shipment. To maximize shooting time, batteries should be fully charged before use. The battery will recharge in about two hours when inserted in the MH-18 quick charger provided with your camera; instructions for use may be found in the documentation provided with the charger.

2.2 Turn the camera off

Turn the camera off before inserting or removing batteries.

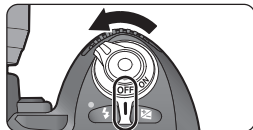

2.3 Open the battery-chamber cover

Slide the battery-chamber cover latch to the open position (c); and open the battery-chamber cover (b).

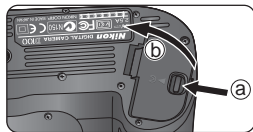

2.4 Insert the battery pack

Insert a fully charged battery with the contacts oriented as shown at right.

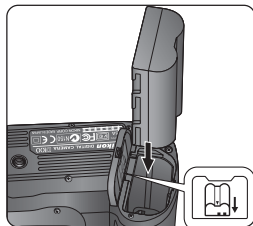

2.5 Close the battery-chamber cover

To prevent the battery from being dislodged during operation, be sure the cover is securely latched.

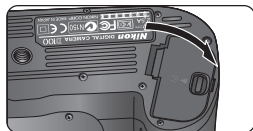

2.6 Check the battery level

Turn the camera on and check the battery level in the control panel or viewfinder.

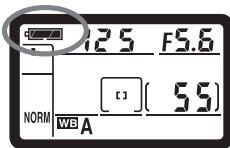
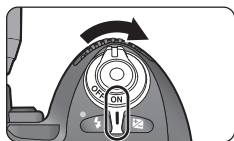

Icon*		Status	Notes
Control Panel	Viewfinder		
	—	Battery fully charged	To save power, aperture and shutter-speed indicators in the control panel and all indicators in viewfinder turn off if no operations are performed for six seconds (auto meter off). Press shutter-release button halfway to reactivate display.
	—	Battery partially discharged	
		Low battery	Ready a fully-charged spare battery.
(Flashes)	(Flashes)	Battery exhausted	Shutter-release disabled. No pictures can be taken until battery has been replaced.

* No icon displayed when camera powered by optional AC adapter.

Removing the Battery

To remove the battery, turn the camera off, open the battery chamber cover as described above, and slide the battery out.

Camera Off Display

When the camera is off and the main battery is inserted or the camera is powered by an optional EH-5 AC adapter, the control panel will show only the number of exposures remaining. If no memory card is inserted, [-E-] will be displayed.



7—Auto Meter Off 151

The length of the auto meter off delay can be adjusted using Custom Setting 7.

Step 3—Choose a Language

Camera menus and messages can be displayed in your choice of German, English, French, Japanese, and Spanish.

3.1

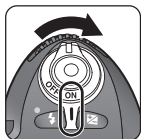

Turn camera on

3.2



Display camera menus

3.3

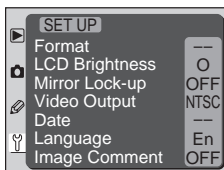

Display SET UP menu

3.4

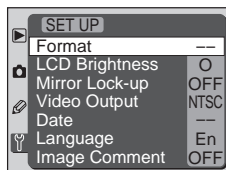

Position cursor in SET UP menu

3.5

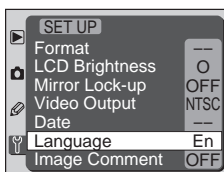

Highlight Language

3.6



Display options

3.7

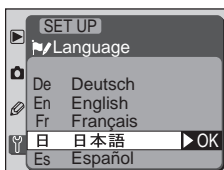

Highlight option

3.8

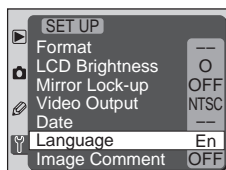

Make selection and return to SET UP menu

Step 4—Set the Time and Date

The time and date of recording is included with all pictures. To ensure that your pictures are stamped with the correct time and date, display the setup menu as described opposite, then set the time and date as described below.

4.1

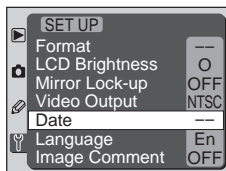

Highlight Date

4.2

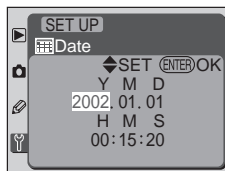

Display Date menu

4.3

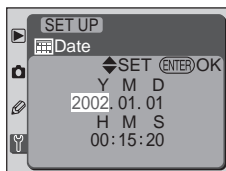

Edit Year

4.4

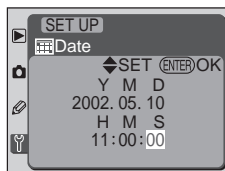

Select next item. Repeat Steps 4.3–4.4 to set Month, Day, Hour, Minute, and Second

4.5

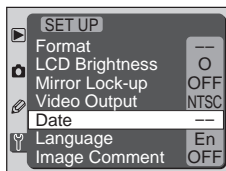

Save changes to settings and return to SET UP menu

- The camera clock is less accurate than most battery-powered time-pieces, and should be regularly checked and reset as necessary.

The Clock Battery

The clock-calendar is powered by an independent, rechargeable power source, which is charged as necessary when a charged EN-EL3 battery is installed or the camera is powered by an optional EH-5 AC adapter. Three days of charging is sufficient to provide about five months of back-up power. If the **CLOCK** icon in the control panel flashes, the clock battery is exhausted and the clock has been reset to 2002.01.01 00:00:00. Set the clock to the correct date and time as described above.

Step 5—Attach a Lens

We recommend that you use a type G or type D CPU lens to take full advantage of the features your camera offers.

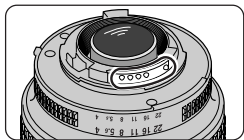

CPU lenses have CPU contacts

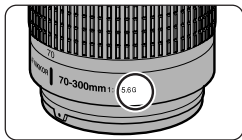

Type G lens



Type D lens

5.1 Turn the camera off

Turn the camera off before attaching or removing lenses.

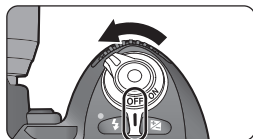

5.2 Attach a lens

Keeping the mounting mark on the lens aligned with the mounting mark on the camera body, position the lens in the camera's bayonet mount. Being careful not to press the lens-release button, rotate the lens counter-clockwise until it clicks into place.

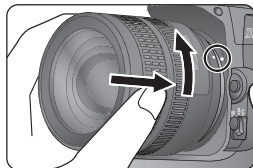

✓ Protect the Camera from Dirt and Dust

Any dust, dirt, or other foreign matter inside your camera could show up as specks or blotches in your photographs or the viewfinder display. When no lens is in place, keep the lens mount covered with the BF-1A body cap supplied with your camera. When exchanging lens or replacing the body cap, keep the lens mount pointed down.

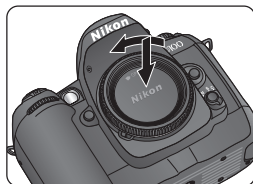

5.3 Lock aperture at the minimum setting

This step is not necessary if you are using a type G lens (type G lenses are not equipped with an aperture ring). If you are using a lens of another type, lock aperture at the minimum setting (highest f/-number).

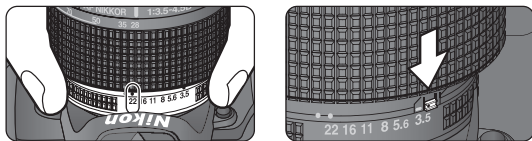

If you do not perform this step when using a CPU lens, the aperture displays in the control panel and viewfinder will show a blinking FE when the camera is turned on. Photographs can not be taken until you have turned the camera off and locked aperture at the highest f/-number.

Detaching the Lens

Be sure the camera is off when removing or exchanging lenses. To remove the lens, press and hold the lens-release button while turning the lens clockwise.

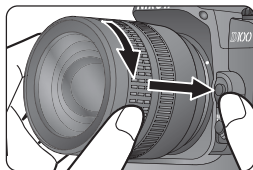

Non-CPU Lenses

Non-CPU lenses can only be used when the function dial is set to **M** (manual exposure mode). In other exposure modes, the shutter release will be disabled. When a non-CPU lens is attached, the camera exposure meters will not function, and the aperture displays in the control panel and viewfinder will show **F-** to indicate that aperture can only be set using the lens aperture ring.

For more information on:

176 Lenses for the D100

Step 6—Insert a Memory Card

In place of film, your Nikon digital camera uses CompactFlash™ memory cards or IBM Microdrive® cards to store photographs. For a list of approved memory cards, see “Technical Notes: Approved Memory Cards” (183).

6.1 Turn the camera off

Turn the camera off before inserting or removing memory cards.

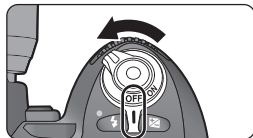

6.2 Open the card slot cover

Open the card slot cover as shown at right.

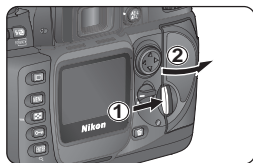

6.3 Insert a memory card

Insert the memory card with the rear label toward the monitor, sliding the card in until it is fully seated in the contacts at the back of the slot (1) and the eject button pops up (2). Close the card slot cover.

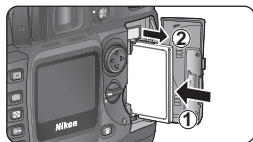
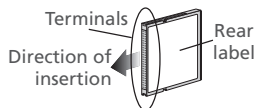

✓ Inserting Memory Cards

Insert the memory card in the orientation shown above; do not use force. *Do not attempt to insert cards in another orientation, as this could damage the camera or card.*

The memory card slot is on a slight angle (see illustration at right). Match the angle of the memory card slot when inserting memory cards.

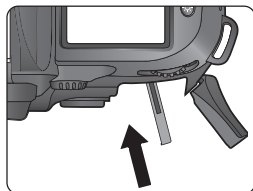

6.4 Format the memory card

Memory cards must be formatted before first use. *Note that formatting memory cards permanently deletes any data they may contain.* Be sure to copy any photographs and other data you wish to keep to a computer before proceeding (📄 169).

To format the card, turn the camera on and hold the **FORMAT** (🔍) and **DISP** (📄) buttons down simultaneously for approximately two seconds. A blinking **F o r** will appear in the shutter-speed display and the frame count will blink. Pressing both buttons together a second time will format the memory card. Press any other button to exit without formatting.

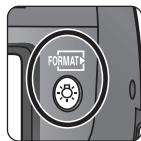
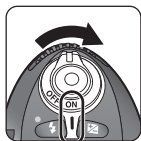

During formatting, the letters **F o r** will be appear in the frame-count display. *Do not remove the card or battery or unplug the AC adapter (available separately) during formatting.* When formatting is complete, the frame-count display will show the number of photographs that can be recorded at current settings.



No Memory Card

If no memory card is inserted in the camera when a charged EN-EL3 battery is inserted or the camera is powered by an AC adapter, **(-E-)** will appear control panel exposure-count display. When the camera is on and indicators are displayed in the viewfinder, the exposure-count display in the viewfinder will also show **(-E-)**.



Format (📄 162)

Memory cards can also be formatted using the **Format** option in the setup menu.



✓ Removing Memory Cards

Memory cards may be hot after use. Observe due caution when removing memory cards from the camera.

✍ Removing Memory Cards

Memory cards can be removed without loss of data when the camera is off. Before removing the memory card, wait for the green card access lamp next to the card slot cover to go out and then turn the camera off. Pressing the memory card slot cover latch, open the card slot cover and press the eject button to partially eject the card (1). You can then remove the card by hand (2). *Do NOT attempt to remove the card while the access lamp is on.* Failure to observe this precaution could result in loss of data or in damage to the camera or card.

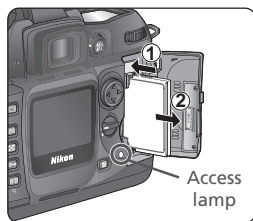

Tutorial

Basic Photography and Playback

Basic Photography



26–34



Basic Playback



35–36



This chapter takes you step-by-step through the process of taking your first photographs and playing them back.

Basic Photography

This section describes how to use autofocus and auto multi program autoexposure for simple, “point-and-shoot” photography that will produce optimal results in most situations.

Basic Playback

Read this section for information on viewing photographs in the monitor.

There are six basic steps to taking photographs:

STEP 1

Ready the Camera



27

To learn more about the battery level display, see:

- Introduction: First Steps 16–17

To learn how to restore settings to their default values, see:

- Taking Photographs: Two-Button Reset 110
- Menu Guide: The Custom Settings Menu 144–160

STEP 2

Adjust Camera Settings



28–29

To learn more about the following camera settings, see:

- Taking Photographs: Choosing a Shooting Mode 41–42
- Taking Photographs: Image Quality and Size 43–47
- Taking Photographs: Sensitivity (ISO Equivalency) 48–49
- Taking Photographs: White Balance 50–57
- Taking Photographs: Focus 63–74
- Taking Photographs: Exposure 75–93

STEP 3

Frame the Photograph



30

To learn how to preview the effects of aperture, see:

- Taking Photographs: Exposure 75–93

To learn about optional viewfinder accessories, see:

- Technical Notes: Optional Accessories 180–183

STEP 4

Focus



31

To learn more about focus options, see:

- Taking Photographs: Focus 63–74

STEP 5

Check Exposure



32

To learn how to change the composition after setting exposure, see:

- Taking Photographs: Exposure 75–93

To learn more about flash photography, see:

- Taking Photographs: Flash Photography 94–106

STEP 6

Take the Photograph



34

To learn how to delay shutter release, see:

- Taking Photographs: Self-Timer Mode 108–109

Step 1—Ready the Camera

Before taking photographs, ready the camera as described below.

1.1 Turn the camera on

The control panel will turn on and the display in the viewfinder will light.

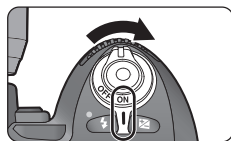

1.2 Check the battery level

If the low-battery icon (🔋) appears in the control panel or flashes in the viewfinder, recharge the battery or replace it with a fully-charged spare battery before proceeding.

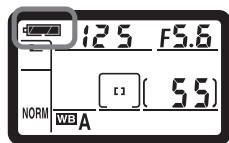

1.3 Check the number of exposures remaining

The exposure-count displays in the control panel and viewfinder show the number of photographs that can be taken at current settings. When this number reaches zero, the shutter-speed display in the control panel will show a blinking **FULL**, the viewfinder shutter-speed display, **FuL**. You will need to delete pictures, insert a new memory card, or adjust image quality and size settings before you will be able to take additional photographs.

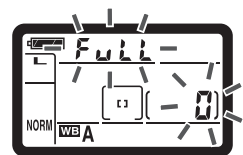
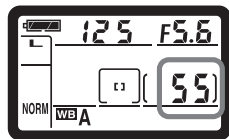

Step 2—Adjust Camera Settings

This Tutorial describes how take photographs at default settings. Information on when and how to change settings from their default values is provided in “Taking Photographs” (📷 37).

2.1 Restore default settings

To restore the settings listed in the table below to their default values, hold down both buttons labeled with a green dot (🔋 and 📷) for about two seconds (two-button reset; 📷 110). The display in the control panel will turn off briefly when settings are reset.

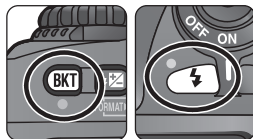

Option	Default	Description	📷
Image quality	NORM (JPEG Normal)	Pictures are compressed for a balance between image quality and file size that is ideal for snapshots.	43–46
Image size	L (Large)	Images are 3,008 × 2,000 pixels in size.	46–47
Sensitivity	200	Sensitivity (the digital equivalent of film speed) is set to a value roughly equivalent to ISO 200.	48–49
White balance	A (Auto)	White balance is adjusted automatically for natural colors under most types of lighting.	50–57
AF-area mode	[□] (Single Area AF)	Pressing shutter-release button halfway locks focus at distance to subject in selected focus area.	65–66
Focus area	Center focus area	Camera focuses on subject in center focus area.	64

2.2 Set the shooting mode to single frame (📷 41)

Hold the mode-dial lock release down (1) and turn the shooting mode dial (2) to **S** (single frame). This sets the camera to take one photograph each time the shutter-release button is pressed.

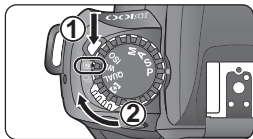
**2.3 Set the focus mode to single-servo autofocus** (📷 63)

Turn the focus-mode selector until it clicks into place pointing to **S** (single-servo autofocus). At this setting, the camera will automatically focus on the subject in the selected focus area when the shutter-release button is pressed halfway. Pictures can only be taken when the camera is in focus.

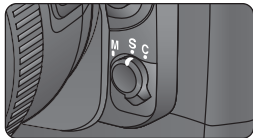
**2.4 Choose matrix as the metering method** (📷 75)

Rotate the metering selector to **M** (matrix metering). Matrix metering uses information from all areas of the frame to determine exposure, ensuring optimal results for the entire frame.

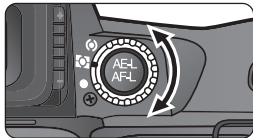
**2.5 Set the function dial to P (auto multi program)** (📷 77)

Before shooting, rotate the function dial to **P** (auto multi program). At this setting, the camera will automatically adjust shutter-speed and aperture according to a built-in exposure program, producing optimal exposure in most situations.

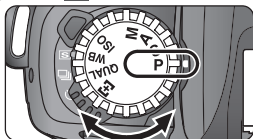
**📷 Non-CPU Lenses**

Exposure mode P (auto multi program) is only available when the lens mounted on the camera is a CPU lens. When a non-CPU lens is used, **F-** will flash in the aperture displays in the control panel and viewfinder and the shutter can not be released. Non-CPU lenses can only be used in manual exposure mode (exposure mode M).

Step 3—Frame a Photograph

To prevent blurred photographs caused by unsteady hands (camera shake), hold the camera steadily in both hands, with your elbows propped lightly against your torso for support. Hold the handgrip in your right hand and cradle the camera body or lens with your left.



The optional MB-D100 multi function battery pack is equipped with a shutter-release button for taking photographs in portrait (tall) orientation.

The recommended stance for taking photographs is with one foot a half pace in front of the other and your upper body stable.

✓ Using the Diopter Control

When operating the diopter control with your eye to the viewfinder, care should be taken to avoid accidentally putting your fingers or fingernails in your eye.

🔍 Viewfinder Focus

The viewfinder is equipped with diopter adjustment to accommodate individual differences in vision. To adjust viewfinder focus, slide the diopter adjustment control up and down until the focus brackets in the viewfinder are in sharp focus. If necessary, you can remove the rubber viewfinder eyepiece cup when adjusting diopter; when replacing the cup, the lettered face should be down.

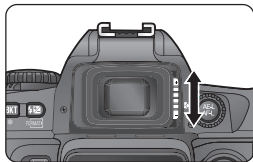

Diopter can be adjusted in the range -2 m^{-1} to $+1\text{ m}^{-1}$. Corrective lenses (available separately; 📷 180) allow diopters of -5 m^{-1} to $+3\text{ m}^{-1}$. The rubber viewfinder eyepiece cup must be removed when using diopter adjustment lenses.

Step 4—Focus

In single-servo AF, the camera focuses on the subject in the selected focus area when the shutter-release button is pressed halfway. After centering the focus brackets on your subject, press the shutter-release button halfway and check focus in the viewfinder. If the subject is dark, the AF-assist illuminator will light automatically to assist with the autofocus operation.

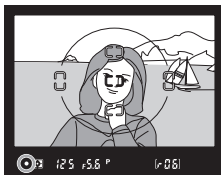
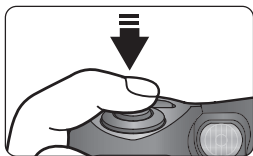

Viewfinder Display	Meaning
●	Subject in focus.
● (flashes)	Camera unable to focus on subject in focus brackets using autofocus.

If the camera is unable to focus using autofocus, use manual focus (🔧 74), or use focus lock to focus on another subject at the same distance, then recompose your photograph (🔒 64). To focus on an off-center subject, use focus lock (🔒 70) or select the focus area containing your subject using the multi-selector.

🔧 The Function Dial

Pictures can only be taken when the function dial is set to P, S, A, or M. At other settings, the shutter release will be disabled.

🔧 Viewfinder Frame Coverage

Approximately 95% of the image exposed on the CCD is visible through the viewfinder. The view through the viewfinder shows slightly less than appears in the final photograph.

Step 5—Check Exposure

With the shutter-release button pressed halfway, check the shutter-speed and aperture indicators in the viewfinder. If the photo would be under- or over-exposed at current settings, one of the following indicators will appear in either the shutter-speed or aperture display.

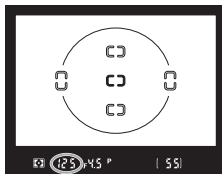

Indicator	Meaning
HI	Photo will be overexposed. Use a Neutral Density (ND) filter.
L	Photo will be underexposed. Use the built-in Speedlight (see opposite) or choose a higher sensitivity (ISO equivalency).



Shutter Speed and Camera Shake

To prevent blurring caused by camera shake, the shutter speed should be faster than the inverse of the focal length of the lens, in seconds (for example, if a lens has a focal length of 50 mm, shutter speed should be faster than $\frac{1}{50}$ s). Use of a tripod is recommended when shooting at slower shutter speeds. To prevent blur, try raising the built-in Speedlight (see following page) or increasing sensitivity (48).



3—ISO Auto (148)

When **ON** is selected for Custom Setting 3 (**ISO Auto**), the camera will automatically vary sensitivity from the value selected by the user to help ensure optimum exposure.



9—EV Step (151)

By default, shutter speed and aperture are shown in increments equivalent to $\frac{1}{3}$ EV. Using Custom Setting 9, you can change the increment to $\frac{1}{2}$ EV.

When Lighting Is Poor



When lighting is poor, shutter speed slows and photographs may be blurred. At shutter speeds slower than $\frac{1}{60}$ s, you can use the built-in Speedlight to prevent blur. A flash can also be used to “fill in” (illuminate) shadows and back-lit subjects ( 94). To use the built-in Speedlight:

a Raise the Speedlight

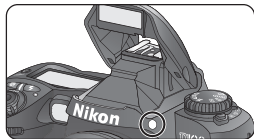
Press the Speedlight lock release. The Speedlight will pop up and begin charging.



b Set the flash-sync mode to front-curtain sync

Press the  button and rotate the main command dial until  is displayed in the control panel.



c Check the flash-ready indicator in the viewfinder

Press the shutter-release button halfway and check the flash-ready indicator in the viewfinder. When the built-in Speedlight is raised, photographs can only be taken when the flash-ready indicator is displayed. If the flash-ready indicator is not displayed, remove your finger briefly from the shutter-release button and try again.

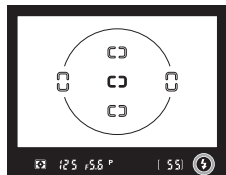

When the Speedlight Is Not in Use

To save battery power when the Speedlight is not in use, return it to the closed position by pressing it lightly downward until you hear the latch click into place.

Step 6—Take the Photograph

Smoothly press the shutter-release button the rest of the way down.

While the photograph is being recorded to the memory card after shooting, the access lamp next to the card slot cover will light. *Do not eject the memory card, turn the camera off, or remove or disconnect the power source until the lamp has gone out.* Removing the memory card or cutting power in these circumstances could result in loss of data.

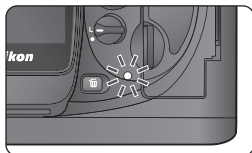
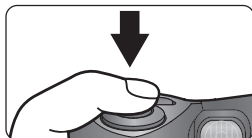

✓ Do Not Photograph Strong Light Sources

Avoid taking pictures with the camera focused on the sun or other strong light source. Intense light may cause deterioration in the charge-coupled device (CCD) that the camera uses in place of film. It may also produce a white blur effect in the final photograph.

CSM 1—Image Review (147)

Photographs can be displayed at any time during or after recording by pressing the  button. When **ON** is selected for **Image Review** (Custom Setting 1), photographs are automatically displayed in the monitor immediately after shooting.

To play photographs back, press the  button. The most recent photograph will be displayed in the monitor.

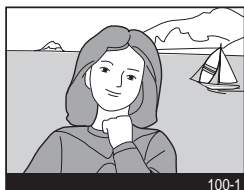
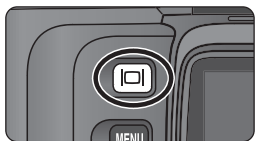



Viewing Additional Photographs

To page through photographs in the order recorded, press the multi selector down. Press the multi selector up to view photographs in reverse order. To scroll rapidly through the images on the memory card, press and hold the up or down buttons on the multi selector.

When the last photograph on the memory card is displayed, you can return to the first photograph by pressing the multi selector down. When the first photograph in memory is displayed, you can view the last photograph by pressing the multi selector up.

Deleting Unwanted Photographs

To delete the photograph currently displayed in the monitor, press the  button. A confirmation dialog will be displayed. Press the multi selector down to highlight **YES**, then press  to delete the image and return to playback. To exit without deleting the picture, highlight **NO** and press .

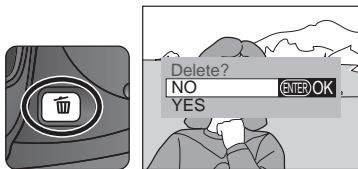

Delete 124

To delete multiple images, use the **Delete** option in the playback menu.

Take Additional Photographs

To end playback and return to shooting mode, press the  button or press the shutter-release button halfway.



















6—Monitor Off (151)

The monitor will turn off automatically to save power if no operations are performed for the time specified in Custom Setting 6 (**Monitor Off**). Press the  button again to return to playback mode.

Taking Photographs

The Details

In “Tutorial: Taking Photographs,” you learned the basic order of operations for taking photographs at the most commonly-used settings. This chapter explains how and when you can adjust camera settings for different shooting conditions.

- Choosing a Shooting Mode  41–42 
- Image Quality and Size  43–47 
- Sensitivity (ISO Equivalency)  48–49 **ISO**
- White Balance  50–57 
- Image Adjustment  58–62 
- Focus  63–74 
- Exposure  75–93 
- Flash Photography  94–107 
- Self-Timer Mode  108–109 
- Two-Button Reset  110 

The chart below shows the basic order for adjusting settings when taking photographs.

Will this be a single photo, or a series of photos?

➔ Choosing a Shooting Mode 41–42

How will I use the photo?

➔ Image Quality and Size 43–47

➔ Image Adjustment 58–62

What lighting is available?

➔ Sensitivity (ISO Equivalency) 48–49

➔ White Balance 50–57

What is my subject, and how will I compose the photograph?

➔ Focus 63–74

How important is background lighting to my photograph?

➔ Exposure: Metering 75

What is my priority for this subject, shutter speed or aperture?

➔ Exposure: Exposure Mode 76–83

Is my subject very bright, very dark, or high contrast?

➔ Exposure: Exposure Compensation 86

➔ Exposure: Bracketing 87–93

Will I need the flash?

➔ Flash Photography 94–107

Do I need to delay shutter release?

➔ Self-Timer Mode 108–109

The Shooting Menu

Changes to some camera settings (shooting mode, focus, metering, exposure mode, exposure compensation, flash sync mode, and flash exposure compensation) are made using the buttons and dials on the camera body. Others (image sharpening, tone compensation, color mode, and hue adjustment) are made from the shooting menu, while still others (image quality and size, sensitivity, and white balance) can be made either from the shooting menu or using the buttons and dials on the camera body. To make a selection from the shooting menu:



Press MENU button. Active menu will be displayed in monitor. If menu displayed is shooting menu, go to Step 5.

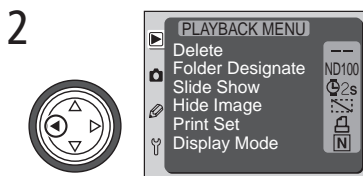

If other menu is displayed, press multi selector left until icon at left of menu is highlighted



Highlight  to select shooting menu



Position cursor in shooting menu



Highlight menu item. Current selection for item is displayed to right of menu.

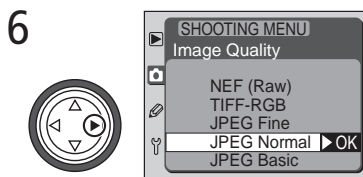

Display options

7



Highlight option

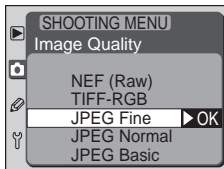

8

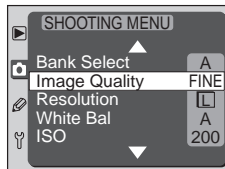
Make selection and
return to main menu

- To return to the previous menu without making a selection, press the multi selector to the left.
- The selection for some options is made from a sub-menu. Repeat steps 7 and 8 to make a selection from a sub-menu.
- The **Bank Select**, **Image Quality**, **Resolution**, **White Bal**, and **ISO** options are not available when the function dial is set to **QUAL**, **WB**, or **ISO**.
- Some menu items are not available while images are being recorded to the memory card.
- The **ENTER** button performs the same function as pressing the multi selector to the right. In some cases, a selection can only be made using the **ENTER** button.

Exiting the Menus

To exit the menus, press the **MENU** button (if a menu option is highlighted, press the **MENU** button twice). You can also exit the menus by pressing the **OFF** button to turn the monitor off or by turning the camera off. To exit the menus and focus the camera for the next shot, press the shutter-release button halfway.



Using the Multi Selector

The multi selector can be used at any time when the monitor is on. The focus selector lock switch only takes effect when the monitor is off.



Choosing a Shooting Mode

Single Frame, Continuous, or Self-Timer

Your choice of shooting mode determines how the camera takes photographs: one at a time, in a continuous sequence, or with a delay after the shutter-release button is pressed.

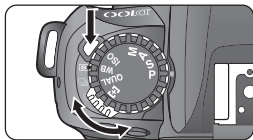
To choose a shooting mode, press the shooting mode dial lock button and turn the shooting mode dial to the desired setting. The following modes are available:



Mode	Description
 Single frame	The camera takes one photograph each time the shutter release button is pressed all the way down.
 Continuous	Camera records photographs at a rate of about three frames per second* while the shutter-release button is held down. Up to six frames (four frames in RAW mode) can be recorded before temporary memory buffer (📷 42) fills. When noise reduction (📷 149) is on, memory buffer holds up to three photographs (two photographs in RAW mode). Additional photographs can be taken as soon as enough memory is available in buffer. This setting can be used to capture a fleeting expression on a portrait subject, or to photograph a subject that is moving unpredictably.
 Self-timer	Use the self-timer to reduce blurring caused by camera shake or to appear in photographs you take yourself (📷 108).

* Average obtained at 20 °C (68 °F) with manual focus, manual exposure, a shutter speed of $1/250$ s or faster, and memory remaining in the buffer.

Buffer Size

During shooting, or while the shutter-release button is pressed halfway, the number of images that can be stored in the memory buffer at current settings is shown in the exposure-count displays in the control panel and viewfinder.

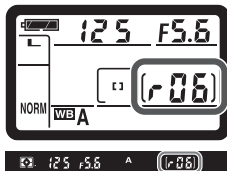

The Memory Buffer

The camera is equipped with a memory buffer for temporary storage of photos during shooting, allowing you to take several photographs in succession without waiting for the images to be transferred to the memory card. The buffer can hold up to six frames (four in RAW mode), or three frames (two RAW images) when noise reduction (📷 149) is on. When the buffer is full, the shutter will be disabled until enough data have been transferred to the memory card to make room for another photograph. In continuous mode, you can continue to take photographs as long as the shutter-release button is held down, although the rate at which photographs are taken will drop once the buffer has filled.

While photographs are recorded to the memory card, the access lamp next to the memory card slot will light. Depending on the number of the images in the buffer, recording may take from a few seconds to a few minutes. *Do not turn the camera off, remove the memory card, or remove or disconnect the power source until the access lamp has gone out.* If the camera is turned off while data remain in the buffer, only the image currently being transferred to the memory card will be saved. *All other images in the buffer will be lost.* If the battery is exhausted while images remain in the buffer, the shutter release will be disabled and all images will be transferred to the memory card.

Large-Capacity Memory Cards

When enough memory remains on the memory card to record a thousand or more pictures at current settings, the number of exposures remaining will be shown in thousands, rounded down to the nearest hundred (e.g., if there is room for approximately 1,260 exposures, the exposure count display will show 1.2 K).

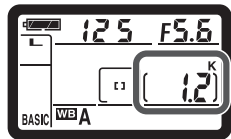

Number of Exposures Remaining

The number of exposures remaining shown in the exposure count displays in the control panel and viewfinder is only an approximation. The number of compressed NEF or JPEG images that can be stored on a memory card depends on the subject and composition of each photograph. In general, the more detailed the image, the larger the resulting file and the fewer the images that can be stored.

Image Quality and Size

Making Effective Use of Memory

Together, image quality and size determine how much space each photograph occupies on the memory card. This in turn determines the total number of photographs that can be stored. For an understanding of how the various size and quality options affect the number of images that can be stored, view the following table, which shows the approximate number of images that can be stored on a 96 MB card at different combinations of quality and size.

		File size*	No. of images*	Recording time†	
NEF** (Raw)	NEF (Raw) (uncompressed)	9.4 MB	9	66 s (4 frames)	
	Comp. NEF (compressed)	††	***	178 s (4 frames)	
RGB-TIFF	Large (3,008 × 2,000)	17.3 MB	5	217 s (5 frames)	
	Medium (2,240 × 1,488)	9.5 MB	9	147 s (6 frames)	
	Small (1,504 × 1,000)	4.3 MB	20	67 s (6 frames)	
JPEG	Fine	Large (3,008 × 2,000)	2.9 MB	28	30 s (6 frames)
		Medium (2,240 × 1,488)	1.6 MB	50	18 s (6 frames)
		Small (1,504 × 1,000)	770 KB	106	9 s (6 frames)
	Normal	Large (3,008 × 2,000)	1.5 MB	55	21 s (6 frames)
		Medium (2,240 × 1,488)	850 KB	97	11 s (6 frames)
		Small (1,504 × 1,000)	410 KB	198	6 s (6 frames)
	Basic	Large (3,008 × 2,000)	770 KB	106	10 s (6 frames)
		Medium (2,240 × 1,488)	440 KB	181	8 s (6 frames)
		Small (1,504 × 1,000)	220 KB	349	5 s (6 frames)

* All figures are approximate.

† Approximate time needed to record all images once the memory buffer has filled. Actual time required varies with make of card.

** When opened in Nikon View 5 or Nikon Capture 3, NEF images are 3,008 × 2,000 pixels in size.

†† File size of compressed NEF (RAW) images is approximately fifty to sixty percent of uncompressed NEF images.

*** Number of exposures remaining shown in control and viewfinder is the same as in the case of uncompressed NEF (RAW) images. The actual number of images that can be stored on the memory card is higher than shown.

Image Quality

The image quality setting determines the file type and compression ratio used to store photographs. The following options are available:

Option	Description
NEF (Raw)	<p>Raw 12-bit data from the CCD are saved directly to the memory card in Nikon Electronic Image Format (NEF). NEF files can only be viewed in Nikon View 5 or Nikon Capture 3 (☞ 169). Two NEF modes are available:</p> <ul style="list-style-type: none"> • NEF (Raw) In this mode, NEF images are not compressed, reducing the time needed to process images before they are saved to the memory card but increasing file size. • Comp. NEF (Raw) In this mode, NEF images are compressed using a virtually “loss-less” algorithm that reduces file size by approximately fifty to sixty percent without affecting image quality. More time is required to process images before they are saved to the memory card.
TIFF-RGB	Images are saved in uncompressed TIFF-RGB at a color depth of eight bits per channel (24-bit color).
JPEG Fine	Images are saved in JPEG format at a compression ratio of roughly 1 : 4.
JPEG Normal	Images are saved in JPEG format at a compression ratio of roughly 1 : 8.
JPEG Basic	Images are saved in JPEG format at a compression ratio of roughly 1 : 16.



File Names

Photographs taken with the D100 are stored as image files with names of the form “DSC_####.xxx,” where #### is a four-digit number between 0001 and 9999 assigned automatically in ascending order by the camera, and xxx is one of the following three letter extensions: “.NEF” for NEF images, “.TIF” for TIFF-RGB, and “.JPG” for JPEG images.

Image quality can be set using the function dial, or using the **Image Quality** option in the shooting menu.

The Image Quality Menu

Highlight **Image Quality** in the shooting menu (🔑 136) and press the multi selector to the right.

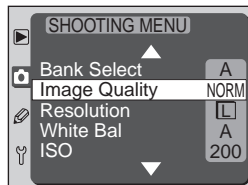

The menu shown at right will be displayed. After pressing the multi selector up or down to highlight the desired option, press the multi selector to the right to put your choice into effect and return to the shooting menu.

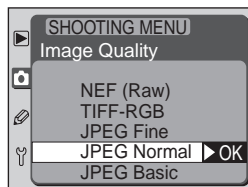

Selecting **NEF (Raw)** from the image quality menu displays the menu of NEF mode options shown at right. Highlight the desired NEF mode and press the multi selector to the right.

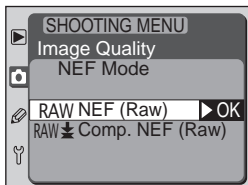

The Function Dial

Pictures can only be taken when the function dial is set to **P**, **S**, **A**, or **M**. When the function dial set to **QUAL**, the shutter release will be disabled. At settings of **QUAL**, **WB**, and **ISO**, **Image Quality** can not be selected in the shooting menu.

NEF (Raw) and White Balance Bracketing

White balance bracketing can not be used with an image quality of **NEF (Raw)** or **Comp. NEF (Raw)**. Selecting either option cancels white balance bracketing. White balance for NEF (RAW) images can be adjusted using Nikon Capture 3 (available separately; 🔑 170).

The Function Dial

With the function dial set to **QUAL**, rotate the main command dial to cycle through image-quality settings as shown below.

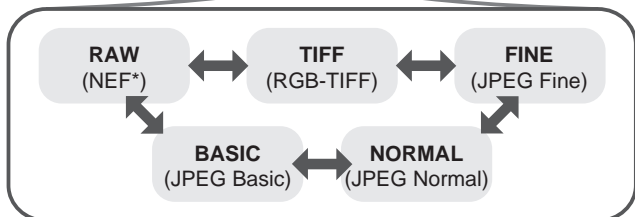

* You cannot choose between uncompressed and compressed NEF modes using the function dial. Use the **Image Quality** option to choose the NEF mode.

Image Size

Image size is measured in pixels. Smaller sizes produce smaller files, making them suited to distribution via e-mail or inclusion in web pages. Conversely, the larger the image, the larger the size at which it can be printed without becoming noticeably “grainy.” Choose image size according to the space available on the memory card and the task at hand.

Option	Size (pixels)	Size when printed at 200 dpi (approx.)
Large	3,008 × 2,000	38 × 25 cm (15" × 10')
Medium	2,240 × 1,488	28 × 19 cm (11" × 7.5')
Small	1,504 × 1,000	19 × 13 cm (7.5" × 5')

Image size can be set using the function dial, or using the **Resolution** option in the shooting menu. Image size can not be adjusted when image quality is set to **NEF (Raw)** or **Comp. NEF (Raw)**. When opened in Nikon View 5 or Nikon Capture 3, NEF images are 3,008 × 2,000 pixels in size.

The Resolution Menu

Highlight **Resolution** in the shooting menu (▶ 137) and press the multi selector to the right.

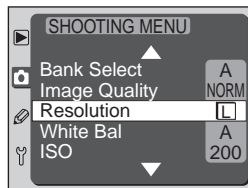

The menu shown at right will be displayed. After pressing the multi selector up or down to highlight the desired option, press the multi selector to the right to put your choice into effect and return to the shooting menu.

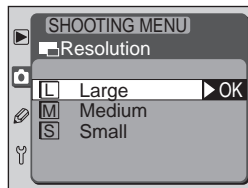

The Function Dial

With the function dial set to **QUAL**, rotate the sub-command dial to cycle through image-size settings as shown below.

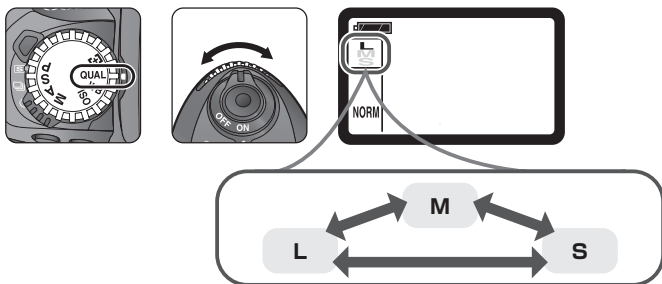

The Function Dial

Pictures can only be taken when the function dial is set to **P**, **S**, **A**, or **M**. When the function dial set to **QUAL**, the shutter release will be disabled. At settings of **QUAL**, **WB**, and **ISO**, **Resolution** can not be selected in the shooting menu.

Sensitivity (ISO Equivalency)

Reacting Faster to Light

“Sensitivity” is the digital equivalent of film speed. The higher the sensitivity, the less light needed to make an exposure, allowing higher shutter speeds or smaller apertures.

Sensitivity can be set between values roughly equivalent to ISO 200 and ISO 1600 in steps equivalent to $\frac{1}{3}$ EV. Higher values of **HI-1** (approximately equivalent to ISO 3200) and **HI-2** (approximately equivalent to ISO 6400) are also available for situations in which high sensitivity is a priority. Sensitivity can be adjusted using the function dial, or using the **ISO** option in the shooting menu.

The ISO Menu

Highlight **ISO** in the shooting menu (📷 139) and press the multi selector to the right.

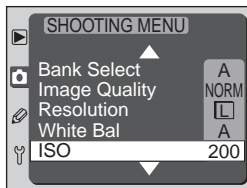

The menu shown at right will be displayed. After pressing the multi selector up or down to highlight the desired option, press the multi selector to the right to put your choice into effect and return to the shooting menu.

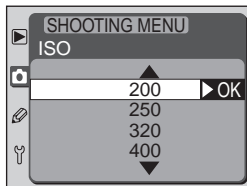

🔧 HI-1/HI-2

The higher the sensitivity, the more likely pictures are to be subject to “noise” in the form of randomly-spaced, brightly-colored pixels. Photos taken at settings of **HI-1** and **HI-2** will likely contain appreciable amounts of noise. Use only to capture natural lighting under low light conditions or when a fast shutter speed is required to prevent blurring. We recommend that image sharpening (📷 58) be turned off at these settings to avoid heightening the effects of noise.

The Function Dial

With the function dial set to **ISO**, rotate the main command dial to cycle through sensitivity settings as shown below.

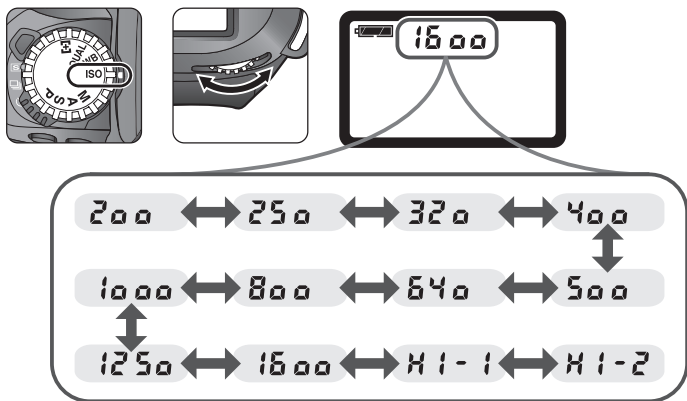

The Function Dial

Pictures can only be taken when the function dial is set to **P**, **S**, **A**, or **M**. When the function dial is set to **ISO**, the shutter release will be disabled. At settings of **QUAL**, **WB**, and **ISO**, **ISO** can not be selected in the shooting menu.







3—ISO Auto 148

When **ON** is selected for Custom Setting 3 (**ISO Auto**), the camera will automatically vary sensitivity from the value selected by the user to help ensure optimum exposure. Sensitivity can not be set to **HI-1** or **HI-2** while **ISO Auto** is on, and **ON** can not be selected for **ISO Auto** is when ISO is set to **HI-1** or **HI-2**. If a flash is used when **ISO Auto** is on, ISO will be fixed at the value selected by the user.

White Balance

Keeping Colors True

The color of light reflected from an object varies with the color of the light source. The human brain is able to adapt to changes in the color of the light source, with the result that white objects appear white whether seen in the shade, direct sunlight, or under incandescent lighting. Unlike the film used in film cameras, digital cameras can mimic this adjustment by processing information from the camera's image sensor (CCD) according to the color of the light source. This is known as "white balance." For natural coloration, choose a white balance setting that matches the light source before shooting. The following options are available:

Option	Approximate Color Temperature*	Description
 Auto	4,200–8,000 K	Camera measures color temperature and adjusts white balance automatically. For best results, use type G or D lens.
 Incandescent	3,000 K	Use under incandescent lighting.
 Fluorescent	4,200 K	Use under fluorescent lighting.
 Direct Sunlight	5,200 K	Use with subjects lit by direct sunlight.
 Flash	5,400 K	Use with Nikon Speedlights, including the built-in Speedlight.
 Cloudy	6,000 K	Use in daylight under overcast skies.
 Shade	8,000 K	Use in daylight with subjects in the shade.
PRE Preset	—	Use to match white balance to the light source when shooting under mixed lighting or lighting with a strong color cast.

Auto white balance is recommended with most light sources. If you are unable to achieve the desired results, choose a white balance option from the table above or use preset white balance. In auto and preset modes, the camera uses "through-the-lens" (TTL) white balance measurement to ensure that white balance is set correctly even when the camera and subject are under different lighting.

White balance can be chosen using the function dial, or using the **White Bal** option in the shooting menu. The current white-balance setting is indicated by an icon in the control panel.

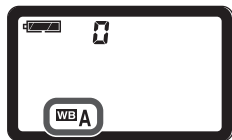

The White Bal Menu

Highlight **White Bal** in the shooting menu (📷 138) and press the multi selector to the right.



The menu shown at right will be displayed. After pressing the multi selector up or down to highlight the desired option, press the multi selector to the right. If **Preset** is selected, a menu of exposure mode options will be displayed (📷 55). In other cases a white-balance fine-tuning dialog (📷 53) will be displayed. Pressing the multi selector to the right in the fine-tuning dialog sets a value for fine tuning and puts your selection into effect.

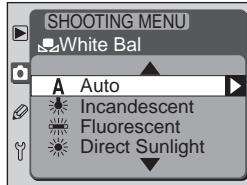

🔧 Speedlights Connected via a Sync Cable

When the AS-15 accessory shoe adapter is used to connect optional Speedlights via a sync cable, the camera may not be able to set white balance appropriately in A (auto) mode. Set white balance to ⚡ (flash) and use fine tuning to adjust white balance, or use preset white balance.

📷 Color Temperature

The perceived color of a light source varies with the viewer and other conditions. Color temperature is an objective measure of the color of a light source, defined with reference to the temperature to which an object would have to be heated to radiate light in the same wavelengths. While light sources with a color temperature in the neighborhood of 5,000–5,500 °K appear white, light sources with a lower color temperature, such as incandescent light bulbs, appear slightly yellow or red. Light sources with a higher color temperature appear tinged with blue.

The Function Dial

With the function dial set to **WB**, rotate the main command dial to cycle through white-balance settings as shown below.

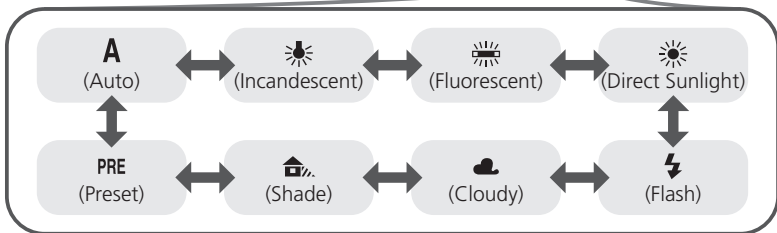

The Function Dial

Pictures can only be taken when the function dial is set to **P**, **S**, **A**, or **M**. When the function dial set to **ISO**, the shutter release will be disabled. At settings of **QUAL**, **WB**, and **ISO**, **White Bal** can not be selected in the shooting menu.

"Mired"

Any given change in color temperature produces a greater difference in color at low color temperatures than it would at higher color temperatures. For example, at a color temperature of 6000 K, a change of 100 K produces almost no change in color, while a change of the same amount at 3000 K would produce a large difference in color. Mired, calculated by multiplying the inverse of the color temperature by 10^6 , is a measure of color temperature that takes such variation into account, and as such is the unit used in color-temperature compensation filters.

Change in Color Temp.	Mired
4000 K – 3000 K = 1000 K	83 mired
7000 K – 6000 K = 1000 K	23 mired

Fine-Tuning White Balance

At settings other than **PRE** (preset), white balance can be “fine tuned” to compensate for variations in the color of the light source or to introduce a deliberate “warm” or “cold” cast into an image. Higher settings can be used to lend images a bluish tinge or to compensate for light sources with a yellow or red cast, while lowering white balance can make photographs appear slightly more yellow or red or compensate for light sources with a blue cast.

Adjustments can be made in the range +3 to -3 in increments of one. In **Auto** mode, each increment is equivalent to about 10 mired. At other settings, white balance is adjusted as shown below:

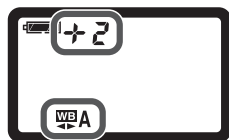

	Approximate Color Temperature*					
	Incandescent	Fluorescent†	Sunlight Direct	Flash	Cloudy (daylight)	Shade (daylight)
+3	2,700 K	2,700 K	4,800 K	4,800 K	5,400 K	6,700 K
+2	2,800 K	3,000 K	4,900 K	5,000 K	5,600 K	7,100 K
+1	2,900 K	3,700 K	5,000 K	5,200 K	5,800 K	7,500 K
±0	3,000 K	4,200 K	5,200 K	5,400 K	6,000 K	8,000 K
-1	3,100 K	5,000 K	5,300 K	5,600 K	6,200 K	8,400 K
-2	3,200 K	6,500 K	5,400 K	5,800 K	6,400 K	8,800 K
-3	3,300 K	7,200 K	5,600 K	6,000 K	6,600 K	9,200 K

* The camera color temperature setting may differ from the value for color temperature measured with a photo color meter.

† The size of the increments for **Fluorescent** reflects the wide variations in color temperature among the many different types of fluorescent light source, ranging from low-temperature stadium lighting to high-temperature mercury-vapor lamps.

White balance can be fine-tuned using the function dial, or from the shooting menu. At settings other than ± 0 , $\blacktriangleleft \blacktriangleright$ icon appears in the control panel.

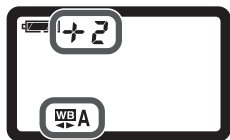

The White Bal Menu

Selecting an option other than **Preset** in the **White Bal** menu (87) displays the menu shown at right. Press the multi selector up or down to choose a setting, then press the multi selector to the right to put your choice into effect and return to the shooting menu.



The Function Dial

With the function dial set to **WB**, rotate the sub-command dial.

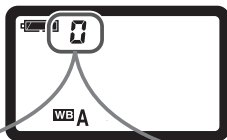
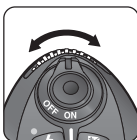
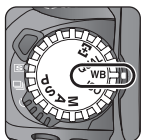

CSM 11—BKT Set (87) 153

When **WB Bracketing** is selected for Custom Setting 11 (**BKT Set**; 87) 153), the camera will create from two to three images each time the shutter is released. White balance will be varied for each image, “bracketing” the value selected using the **White Bal** menu or function dial. See “Bracketing” (87).

Preset White Balance

Preset white balance is used to adjust white balance when shooting under mixed lighting or to compensate for light sources with a strong color cast.

Choosing an Exposure Mode

Before measuring a value for preset white balance, choose an exposure mode. Highlight **Preset** in the **White Bal** menu and press the multi selector to the right to display the menu shown at right.



Highlight **Exposure Mode** and press the multi selector to the right.

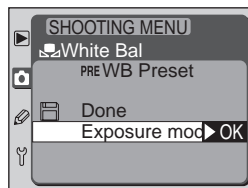

Choose the exposure mode you will use when measuring a value for white balance from **P** (auto multi program), **S** (shutter-priority auto), **A** (aperture-priority auto), or **M** (manual), and press the multi selector to the right.

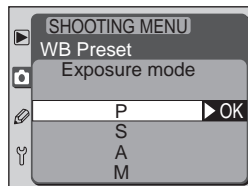

Highlight **Done** and press the multi selector to the right to return to the shooting menu.



Manual Exposure Mode

To ensure accurate white balance, the amount of light entering the camera is increased. In exposure mode **M**, use the electronic analog exposure display to set exposure.

Measuring Preset White Balance

To measure a value for preset white balance:

- 1 Place a neutral gray or white object under the lighting that will be used in the final photograph.
- 2 Set the function dial to **WB**. If preset white balance is not selected, rotate the main command dial until **PRE** appears in the control panel.

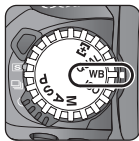

- 3 Rotate the sub-command dial. A flashing **PrE** will appear in the exposure-count displays, and the **PRE** icon in the control panel will flash.

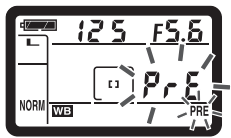
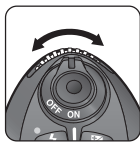

- 4 The camera will be set to the exposure mode chosen in the **WB Preset > Exposure Mode** menu; adjust focus, exposure, and flash settings. Note that settings that would result in extreme under- or over-exposure could prevent the camera from measuring a value for white balance. Under studio lighting, use an 18% diffusion panel to make the reference object appear gray. If you are using a white object as the reference for setting white balance, exposure should be set to a value that would cause the reference object to appear gray.



Use Manual Focus

When measuring preset white balance the focus-mode selector to **M** (manual focus; 74) and focus manually. At a setting of single-servo autofocus, lack of contrast may prevent the camera focusing on a neutral gray reference object, and the shutter-release will be disabled.

- 5 Frame the reference object so that it fills the viewfinder and press the shutter-release button all the way down to measure a value for white balance (the shutter will be released, but no photograph will be taken). If the camera is able to measure a value for white balance, the letters **Good** will flash for two seconds in the control panel shutter-speed display, and the viewfinder shutter-speed display will show a flashing **Good**. The new value will be recorded when the shutter-release button is pressed halfway or when the exposure meter turns off (auto meter off;  151). Until white balance is measured again, this value will be used in all subsequent photographs taken at a setting of **Preset (PRE)**.

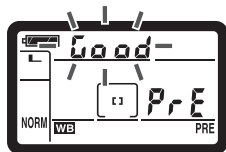
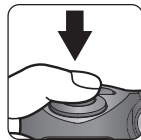

If the camera is unable to measure a value for white balance, the shutter-speed/aperture displays in the control panel and viewfinder will show a flashing **no Gd**. Press the shutter-release button halfway while this indicator is flashing to return to Step 4. Repeat Steps 4 and 5, taking care to adjust settings to avoid extreme under- or over-exposure.

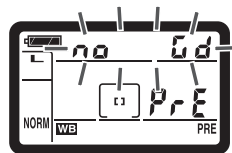

If white balance is not measured before the exposure meters turn off automatically, the camera will revert to the last measured preset white balance setting. To set a new value for white balance, repeat Steps 3–5.

Note that the camera can store only one value for preset white balance at a time. Measuring a new value will delete the previous value from memory.

During Recording

If preset white balance is measured while images are being recorded to the memory card ( 34), the result (**Good/Gd** or **no Gd**) will not appear in the viewfinder and control panel until recording is complete. We recommend that you wait until recording is complete before measuring preset white balance.

This section describes settings that can only be adjusted from the shooting menu (📷 135).

Making Edges More Distinct: *Image Sharpening*

When you take a photograph, the camera automatically processes the image to increase the distinction between light and dark areas, making the picture appear sharper. The options in the **Image Sharpening** menu give you control over the amount of sharpening performed.

Option	Description
A Auto (default)	The camera automatically adjusts sharpening according to the subject and how other camera settings are adjusted. Amount of sharpening performed varies from shot to shot. For best results, use a type G or D lens.
◊ Normal	Camera performs same standard level of sharpening on all images.
◊ Low	Sharpening performed, but edges are not sharpened as much as they are in Normal mode.
◊ High	Images processed for increased sharpness.
✂ None	No sharpening performed.

To choose an image sharpening option, highlight **Image Sharpening** in the shooting menu and press the multi selector to the right.

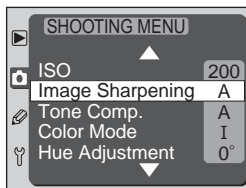

The menu shown at right will be displayed. After pressing the multi selector up or down to highlight the desired option, press the multi selector to the right to put your choice into effect and return to the shooting menu.



Adjusting Contrast: *Tone Compensation*

As photographs are saved to the memory card, they are processed to adjust the distribution of tones in the image, enhancing contrast. Tone compensation is performed by means of tone curves that define the relationship between the distribution of tones in the original image and the compensated result. The options in the **Tone Comp.** menu give you control over the type of tone curve used.

Option	Description
A Auto (default)	Camera automatically optimizes contrast by selecting the appropriate curve. Curve selected varies from image to image. For best results, use a type G or D lens.
0 Normal	Camera uses same standard curve for all images. This option is suited to most types of scene, whether dark or bright.
- Less Contrast	This curve produces “softer” images. If you are shooting a portrait in direct sunlight, this option can be used to prevent bright areas of the image from being “washed out” by glare.
+ More Contrast	Choose this curve to preserve detail when taking shots of misty landscapes and other low-contrast subjects.
Custom	If you have Nikon Capture 3* (N 170), you can define your own tone curve and download it to the camera. Custom is used to select this user-defined curve. If no curve has been downloaded to the camera, this option is equivalent to Normal .

* This feature is not available when the D100 is used with the Macintosh version of Nikon Capture 3.

Auto

Even when shooting the same type scene, the curve chosen by the camera in **A (Auto)** mode may vary with exposure, the position of your subject, or the amount of the frame it occupies. To shoot several shots with the same tone compensation, choose one of the other tone curves.

To choose a tone curve, highlight **Tone Comp.** in the shooting menu and press the multi selector to the right.

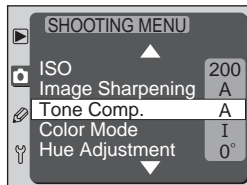

The menu shown at right will be displayed. After pressing the multi selector up or down to highlight the desired option, press the multi selector to the right to put your choice into effect and return to the shooting menu.

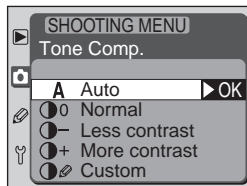

Suiting Colors to Your Workflow: *Color Mode*

Your Nikon digital camera offers a choice of color modes, which determine the gamut of colors available for color reproduction. How you choose a color mode depends on how the final photograph will be processed once it leaves the camera.

Option	Description
I I (sRGB) (default)	Choose for portrait shots that will be printed or used “as is,” with no further modification. Photographs are adapted to the sRGB color space.
II II (Adobe RGB)	Photographs taken at this setting are adapted to the Adobe RGB color space. This color space is capable of expressing a wider gamut of colors than sRGB, making it the preferred choice for studio photography or images that will be modified as part of a commercial production work flow.
III III (sRGB)	Choose for nature or landscape shots that will be printed or used “as is,” with no further modification. Photographs are adapted to the sRGB color space.

To choose a color mode, highlight **Color Mode** in the shooting menu and press the multi selector to the right.

The menu shown at right will be displayed. After pressing the multi selector up or down to highlight the desired option, press the multi selector to the right to put your choice into effect and return to the shooting menu.

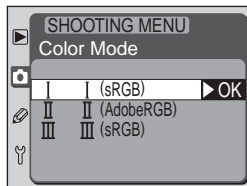
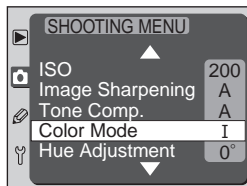

Color Management

When opening images in an application that supports color management, select a profile that matches the color mode in effect when the photograph was taken. If the image is converted to a different color space, colors may not be reproduced accurately. If the image is converted to a color space with that supports a narrower gamut of colors, you may notice tonal discontinuities (colors changing abruptly instead of progressing gradually from one tone to the next).

When photographs created with the D100 are opened in Nikon View 5 or Nikon Capture 3, the appropriate color space will be selected automatically.

Controlling Color: Hue Adjustment

Hue can be adjusted in the range about -9° to 9° in increments of 3° . If red is taken as the starting color, raising hue above 0° (the default setting) would introduce a yellow cast, making colors that would be red at a setting of 0° appear increasingly orange. Lowering hue below 0° would introduce a blue cast, making colors that would be red at a setting of 0° appear increasingly purple.

To choose a hue adjustment, highlight **Hue Adjustment** in the shooting menu and press the multi selector to the right.

The dialog shown at right will be displayed. After pressing the multi selector up or down to select a value for hue, press the multi selector to the right to put your choice into effect and return to the shooting menu.

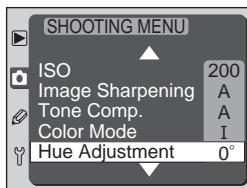

Hue

The RGB color model used in digital photographs reproduces colors using differing amounts of red, green, and blue light. By mixing two colors of light, a variety of different colors can be produced. For example, red combined with a small amount of green light produces orange. If red and green are mixed in equal amounts, yellow results, while a smaller amount of red produces a yellow green. Mixing different amounts of red and blue light produces colors ranging from a reddish purple through purple to navy, while mixing different amounts of green and blue light produces colors ranging from emerald to turquoise. (Adding a third color of light results in lighter hues; if all three mixed in equal amounts, the results range from white through gray.) When this progression of hues is arranged in a circle, the result is known as a color wheel.

This section describes the options that control how your camera focuses: focus mode, focus-area selection, and AF-area mode.

Focus Mode

Focus mode is controlled by the focus mode selector on the front of the camera. You can choose from two *autofocus* (AF) modes, in which the camera focuses automatically when the shutter-release button is pressed halfway, and one *manual* focus mode, in which focus must be adjusted manually using the focusing ring on the lens:

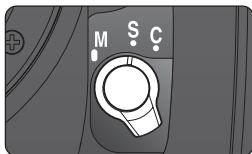

Mode	Description
S Single-servo AF	The camera focuses when the shutter-release button is pressed halfway. Focus locks when the in-focus indicator (●) appears in the viewfinder, and remains locked until you remove your finger from the shutter-release button (<i>focus lock</i>). The shutter can only be released when the in-focus indicator is displayed (<i>focus priority</i>). If your subject was moving when the shutter-release button was pressed halfway, the camera will track the subject until focusing is complete and the shutter can be released (<i>predictive focus tracking</i> ; 66). If the subject stops moving before the shutter is released, the in-focus indicator will appear in the viewfinder and focus will lock at this distance.
C Continuous- servo AF	The camera adjusts focus continuously while the shutter-release button is pressed halfway. If your subject moves, focus will be adjusted to compensate (<i>predictive focus tracking</i> ; 66). Photographs can be taken whether or not the camera is in focus (<i>release priority</i>).
M Manual	The camera does not focus automatically; focus must be adjusted manually using the lens focusing ring. If the lens has a maximum aperture of $f/5.6$ or faster, the viewfinder focus indicator can be used to confirm focus (<i>electronic range finding</i>), but photographs can be taken at any time, whether or not the camera is in focus.

Choosing single-servo AF ensures a sharp, focused image. Continuous-servo AF may be a better choice with erratically-moving subjects. Manual focus is recommended when the camera is unable to focus using autofocus.

Focus Area Selection

The D100 offers a choice of five focus areas that together cover a wide area of the frame. Except when closest subject priority (👁 67) is in effect, you can select the focus area manually, allowing you to compose your photograph with the main subject positioned almost anywhere in the frame (to compose a photograph in which the main subject is not in any of the five focus areas, use focus lock; 📷 70).

To select the focus area, rotate the focus selector lock switch to release the lock. The multi selector can then be used to select the focus area. The selected focus area will be displayed in the viewfinder, highlighted in red if necessary to establish contrast with the background (“Vari-Brite” focus areas; 👁 11). The selected focus area is also shown in the control panel.

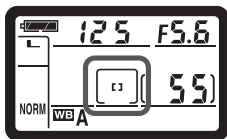

If you rotate the focus selection lock switch to the locked position after selecting the focus area, the selected focus area will not change even when the multi selector is pressed.

Playback

The focus area can not be selected during playback and menu operations.

17—Focus Area (👁 156)

This option can be used to set focus area selection to “wrap around.”

18—AF Area Illum (👁 156)



By default, the selected focus area is briefly highlighted in red to improve contrast as needed (“Vari-Brite” focus area). Using Custom Setting 18, you can set the focus area to be highlighted in red at all times, or turn highlighting off altogether.

Autofocus

When the focus mode selector is set to **S** (single-servo autofocus) or **C** (continuous-servo autofocus), the camera focuses automatically when the shutter-release button is pressed halfway. This section describes focus options that are only available in single- and continuous-servo AF.

AF-Area Mode

Pressing the shutter-release button halfway initiates autofocus. AF-area mode determines what happens if the subject moves out of the selected focus area while the camera is still focusing. Two options are available:

Mode	Description
 Single-area AF	The camera will focus on the subject in the selected focus area only. Choose this option when your composition is relatively static and you can predict that your subject will stay in the selected focus area.
 Dynamic-area AF	Camera uses information from multiple focus areas to determine focus. If the subject leaves the selected focus area even briefly, the camera will still be able to focus based on information from other focus areas (the focus area selected in the viewfinder does not change). Choose this option when you are following an erratically moving subjects and in other cases in which it is difficult to keep your subject in the selected focus area.

* Focus brackets are not displayed when closest subject priority ( 67) is in effect; only  icon is displayed.

CSM 14—AE-L/AF-L (154)

If **AF-ON** is selected for Custom Setting 14 (**AE-L/AF-L**), the camera can also be focused by pressing the **AE-L/AF-L** button.

To select the AF-area mode, set the function dial to **[+]** and rotate the main command dial. The current AF-area mode is indicated by the focus-area display in the control panel:

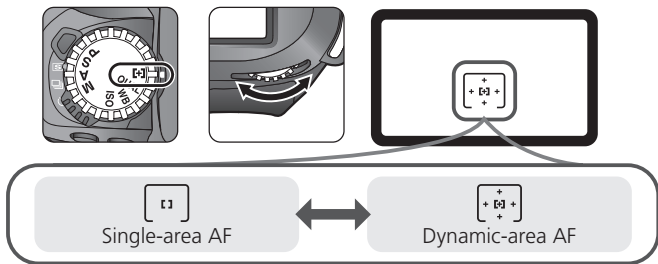

Predictive Focus Tracking

If the camera autofocus system detects that the subject is moving when the shutter-release button is pressed halfway, it will automatically initiate predictive focus tracking. If the subject is moving toward or away from the camera, the camera will track focus while attempting to predict where the subject will be when the shutter is released. In single-servo autofocus, the camera will initiate predictive focus tracking if the subject was moving when the shutter-release button was pressed halfway. Focus will lock when the subject stops moving. In continuous-servo AF, the camera will also initiate predictive focus tracking if the subject starts moving after the shutter-release button is pressed halfway. Focus will not lock when the subject stops moving.

If **AF-ON** is selected for Custom Setting 14 (**AE-L/AF-L**), predictive focus tracking will also take effect when the **AE-L/AF-L** button is pressed.

Predictive focus tracking is not available in manual focus mode.

Closest Subject Priority (Dynamic Area AF)

Dynamic-area AF can be combined with *closest subject priority*. When this option is in effect, the focus area can not be selected manually, and no focus-area indicators are shown in the viewfinder or control panel. Instead, the camera automatically chooses the focus area containing the subject closest to the camera and focuses on this subject when the shutter-release button is pressed halfway. Note that the camera may be unable to select the focus area containing the subject closest to the camera when a telephoto lens is used or your subject is poorly lit. Single-area AF is recommended in these cases.







CSM 20—Dyn. AF AF-S 157

To enable closest-subject priority when dynamic area AF is selected in single-servo AF, select **Select AF Area** for Custom Setting 20 (**Dyn AF AF-S**).

CSM 21—Dyn. AF AF-C 157

To enable closest-subject priority when dynamic area AF is selected in continuous-servo AF, select **Select AF Area** for Custom Setting 21 (**Dyn AF AF-C**).

 Summary of Autofocus Options

Focus mode	AF-area mode	Closest subject priority	Control panel display	Active focus area	Focus-area selection
AF-S	Single-area AF	—		Shown in viewfinder and control panel	Manual
	Dynamic-area AF	Off (default)		Shown in viewfinder and control panel	Manual
		On (Custom Setting 20 set to Closest Subject)		Not shown	Automatic
AF-C	Single-area AF	—		Shown in viewfinder and control panel	Manual
	Dynamic-area AF	Off (default)		Shown in viewfinder and control panel	Manual
		On (Custom Setting 21 set to Closest Subject)		Not shown	Automatic

How it works	When to use it
Camera focuses on subject in selected focus area. Focus will remain locked while shutter-release button is pressed halfway.	Use with static subjects when time is available to compose photo.
Camera focuses on subject in selected focus area. If subject moves before camera has focused, camera will focus based on information from other focus areas. Focus will remain locked while shutter-release button is pressed halfway.	Use with static subjects when time is available to compose photo.
As above, except that camera focuses on subject in focus area containing subject closest to camera.	Use when you know your subject will be closest object to camera but you are unsure where it will appear in final composition.
Camera continues to focus on subject in selected focus area while shutter-release button is pressed halfway.	Use with subjects that are moving towards or away from you.
Camera focuses on subject in selected focus area. While shutter-release button is pressed halfway, camera tracks subject as it moves from one focus area to the next.	Use with subjects that are moving unpredictably.
As above, except that camera focuses on subject in focus area containing subject closest to camera.	Use with erratically moving subjects when you know your subject will be closest object to camera.

Focus Lock

Focus lock can be used to change the composition after focusing, allowing you to focus on a subject that will not be in one of the five focus areas in the final composition. You can also use it when the autofocus system is unable to focus (📷 73), by first locking focus on another object at the same distance, then recomposing your photograph with the intended subject in the frame.

In single-servo AF, focus locks automatically when the in-focus indicator (●) appears in the viewfinder. In continuous-servo AF, focus must be locked manually using the **AE-L/AF-L** button. To recompose a photograph using focus lock:

- 1 Position the subject in the selected focus area and press the shutter-release button halfway to initiate focus.

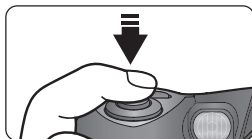

- 2 Check that the in-focus indicator (●) appears in the viewfinder.

Single-servo AF

Focus will lock automatically when the in-focus indicator appears, and remain locked until you remove your finger from the shutter-release button. Focus can also be locked by pressing the **AE-L/AF-L** button (see below).

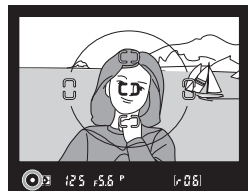

Continuous-servo AF

Press the **AE-L/AF-L** button to lock both focus and exposure. Focus will remain locked while the **AE-L/AF-L** button is pressed, even if you later remove your finger from the shutter-release button.

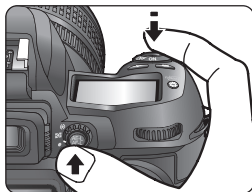

3 Recompose the photograph and shoot.

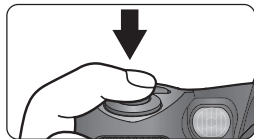
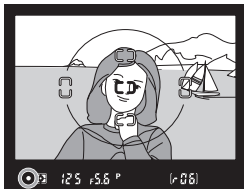

In single-servo AF, focus will remain locked between shots as long as you keep the shutter-release button pressed halfway, allowing you to take several photographs in succession at the same focus setting. Focus will also remain locked between shots as long as the **AE-L/AF-L** button is pressed.

Do not change the distance between the camera and the subject while focus lock is in effect. If your subject moves, focus again at the new distance.

CSM 14—AE-L/AF-L (154)

The AE-L/AF-L button can be set to lock only focus.

For more information on:

84 Autoexposure lock

The AF-Assist Illuminator

The built-in AF assist illuminator enables the camera to focus even when the subject is poorly lit. To use the illuminator, the camera must be in single-servo AF with an AF-Nikkor lens attached, and the center focus area must be selected or closest subject priority in effect. If these conditions are met and the subject is poorly lit, the illuminator will light automatically to assist the autofocus operation when the shutter-release button is pressed halfway.

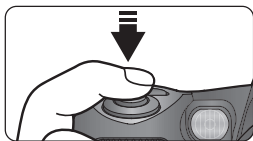

For the AF-assist illuminator to function correctly, the lens must have a focal length of 24–200 mm and the subject must be in range of the illuminator. With most lenses, the illuminator has a range of about 0.5–3 m (1'8"–9'10"). With the following lenses, the illuminator can not be used at ranges of under 1 m (3'3"):

- AF Micro ED 200 mm f/4
- AF-S ED 17–35 mm f/2.8
- AF ED 18–35 mm f/3.5–4.5
- AF 20–35 mm f/2.8
- AF 24–85 mm f/2.8–4.0
- AF 24–120 mm f/3.5–5.6
- AF-S ED 28–70 mm f/2.8
- AF Micro ED 70–180 mm f/4.5–5.6

The built-in illuminator will not light when used with the AF and AF-S ED 80–200 mm f/2.8 and AF VR ED 80–400 mm f/4.5–5.0.

If an optional SB-series 80DX, 50DX, 28DX, 28, 27, 26, 25, or 24 Speedlight is used, the camera's built-in AF-assist illuminator will turn off and the Speedlight illuminator will be used instead. With other Speedlights, the camera's built-in AF assist illuminator will be used.



Continuous Use of the AF-Assist Illuminator

After the AF-assist illuminator has been used for several consecutive shots, it may turn off briefly to protect the lamp. The illuminator can be used again after a short pause. Note that the illuminator may become hot with continuous use.



22—AF Assist (☑ 158)

This option can be used to turn the AF-assist illuminator off.

Getting Good Results with Autofocus

Autofocus does not perform well under the following conditions:

There is little or no contrast between the subject and the background

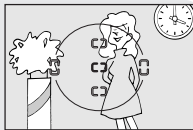

An example would be a subject the same color as the background. Use focus lock (📷 70) to focus on another subject at the same distance, then recompose the photo.

The focus area contains objects at different distances from the camera



An example would be a subject inside a cage. Use focus lock (📷 70) to focus on another subject at the same distance, then recompose the photo.

The subject is dominated by regular geometric patterns

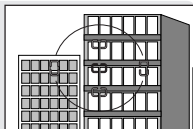

An example would be a row of windows in a skyscraper. Use manual focus (📷 74).

The focus area contains areas of sharply contrasting brightness

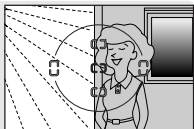

An example would be a subject that is half in the shade. Use manual focus (📷 74).

Manual Focus

Manual focus is available for lenses that do not support autofocus (non-AF Nikkor lenses) or when the autofocus does not produce the desired results (73). To focus manually, set the focus-mode selector to **M** and adjust the lens focusing ring until the image displayed on the clear matte field in the viewfinder is in focus. Photographs can be taken at any time, even when the image is not in focus.

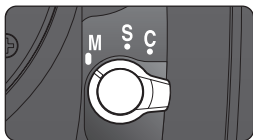

The Electronic Range Finder

If the lens has a maximum aperture of $f/5.6$ or faster, the viewfinder focus indicator can be used to confirm whether the subject in the selected focus area is in focus. After positioning your subject in the active focus area, press the shutter-release button halfway and rotate the lens focusing ring until the in-focus indicator (●) is displayed.

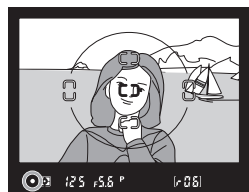
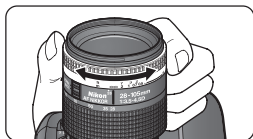

A-M Selection/Autofocus with Manual Priority

When using a lens that offers A-M selection, select M when focusing manually. With lenses that support M/A (autofocus with manual priority), focus can be adjusted manually with the lens set to M or M/A. See the documentation provided with your lens for details.







Focal Plane Position

To determine the distance between your subject and the camera, measure from the focal plane mark on the camera body. The distance between the lens mounting flange and the focal plane is 46.5 mm (1.83").

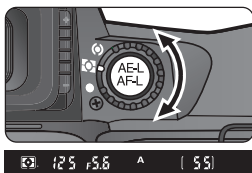
Metering

The metering method determines how the camera sets exposure. Before shooting, rotate the metering selector to choose a method suited to the composition and lighting conditions and confirm your selection in the viewfinder. Three methods are available (the type of metering performed may vary with the lens used):



Method	Description
 3D ten-segment matrix/ Ten-segment matrix	In <i>ten-segment matrix metering</i> , optimal exposure is determined on the basis of information from ten areas of the frame, each of which is metered independently. <i>3D ten-segment matrix metering</i> , which is activated automatically whenever a type G or D lens is mounted on the camera, makes use of information on maximum brightness, contrast, and the distance for the subject for still more accurate exposure control.
 Center-weighted	The camera meters the entire frame but assigns the greatest weight to an area in the center of the frame 8 mm (0.31") in diameter (use the 12-mm/0.47" circle in the center of the viewfinder as a reference when metering your subject at this setting).
 Spot	The camera meters a circle 3 mm (0.12") in diameter centered on the current focus area and occupying approximately two percent of the frame. When closest subject priority (67) is in effect, the center focus area will be used. Otherwise the metering is linked to the focus area, allowing you to meter an off-center subject.

Matrix metering will not produce the desired results with autoexposure lock (84) or exposure compensation (86), but is recommended in most other circumstances. Center-weighted metering is the classic meter for portraits, preserving background details while letting lighting conditions at the center of the frame determine exposure. Spot metering ensures that your subject will be correctly exposed, even when the background is much brighter or darker.

Metering is not available with non-CPU lenses.

Exposure Mode

Your choice of exposure mode determines how the camera sets shutter speed and aperture when adjusting exposure. Four modes are available: auto multi program (**P**), shutter-priority auto (**S**), aperture-priority auto (**A**), and manual (**M**).



CPU Lenses (All Exposure Modes)

If you are using a CPU lens equipped with an aperture ring, the aperture ring must be set to the minimum aperture (highest f/-number). At other settings, the shutter release will be disabled and a blinking **f/∞** will appear in the aperture displays in the control panel and viewfinder. Type G lenses are not equipped with an aperture ring.



Depth-of-Field Preview (All Exposure Modes)

To get an idea of how your photograph will look at the current aperture setting, press and hold the depth-of-field preview button. The lens will be stopped down to the aperture value selected by the camera in auto multi program or shutter-priority auto, or the value chosen by the user in aperture-priority auto or manual exposure mode, allowing you to preview depth of field in the viewfinder.



3—ISO Auto (148)

When **ON** is selected for Custom Setting 3 (**ISO Auto**), the camera automatically varies sensitivity in the range 200–1600 (ISO equivalent) to help ensure optimum exposure when the limits of the camera exposure metering system are exceeded at the sensitivity selected by the user. In programmed auto, this helps ensure that the correct exposure can be achieved with subjects that would otherwise be too bright or too dark. In other exposure modes, it helps ensure correct exposure at the shutter speed and/or aperture selected by the user. When sensitivity is altered from the value selected by the user, the viewfinder exposure-mode indicator (**P**, **S**, **A**, or **M**) will flash and the sensitivity indicator in the viewfinder (**ISO**) will be displayed in red. In the camera photo information display for pictures taken at altered sensitivities, the ISO value will also be displayed in red. Note that noise is more likely to appear in photographs taken at higher sensitivities.

ON can not be selected for **ISO Auto** when sensitivity is set to **H 1 - 1** or **H 1 - 2**; similarly, **H 1 - 1** or **H 1 - 2** can not be selected when **ISO Auto** is on. If a flash is used when **ISO Auto** is on, ISO will be fixed at the value selected by the user.

P: Auto Multi Program

In this mode, the camera automatically adjusts shutter speed and aperture according to a built-in program (see below) for optimal exposure in most situations. This mode is recommended for snapshots and other situations in which you want to leave the camera in charge of shutter speed and aperture. Adjustments can be made using flexible program, exposure compensation (86), and auto exposure bracketing (88). Auto multi program is only available with CPU lenses.

Non-CPU Lenses (Exposure Modes P, S, and A)

Non-CPU lenses can only be used in manual exposure mode (82), when aperture can be adjusted manually using the lens aperture ring. If another exposure mode is selected when a non-CPU lens is attached, the shutter release will be disabled and a blinking **F-** will appear in the aperture displays in the control panel and viewfinder.

Exposure Program

The exposure program for auto multi program is shown in the following graph (ISO 200):

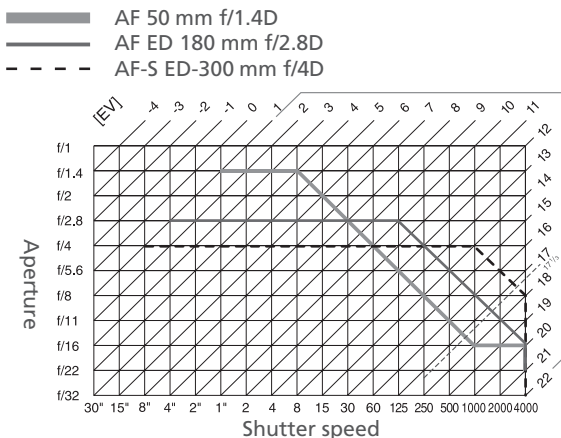

The maximum and minimum values for EV vary with sensitivity (ISO equivalency); the above graph assumes a sensitivity of ISO 200 equivalent. When matrix metering is used, values over $17\frac{1}{3}$ EV are reduced to $17\frac{1}{3}$ EV.

To take photographs in auto multi program, simply:

- 1 Rotate the function dial to **P**.
- 2 Frame a photograph and shoot.

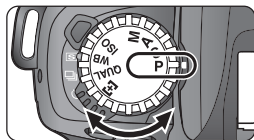

Exposure Warning

If the limits of the exposure metering system are exceeded, one of the following indicators will be displayed in the control panel and viewfinder:

Indicator	Description
	Subject too bright. Use a Neutral Density (ND) filter or lower sensitivity (ISO equivalency; 48).
	Subject too dark. Use the flash (98) or raise sensitivity (ISO equivalency).

Flexible Program

In auto multi program, you can rotate the main command dial to choose different combinations of shutter speed and aperture (“flexible program”), each of which will produce the same exposure. While flexible program is in effect, **P** appears in the control panel. To restore default shutter speed and aperture settings, rotate the main command dial until the indicator is no longer displayed. Default settings can also be restored by turning the camera off, selecting another exposure mode, raising the built-in Speedlight (98), or performing a two-button reset (110).

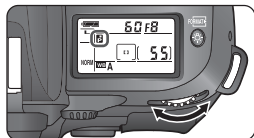
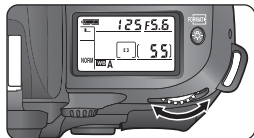

S: Shutter-Priority Auto

In shutter-priority auto, you choose the shutter speed while the camera automatically selects the aperture that will produce the optimal exposure. Shutter speed can be set to values between 30 s and $\frac{1}{4,000}$ s. Use slow shutter speeds to suggest motion by blurring moving objects, high shutter speeds to “freeze” motion. Shutter-priority auto is only available with CPU lenses.

Changing from Manual to Shutter-Priority Auto

If you select a shutter speed of **b u l b** in manual exposure mode and then turn the function dial to **S** (shutter-priority auto) without changing the shutter speed, the **b u l b** indicator in the shutter-speed display will flash and the shutter can not be released. Rotate the main command dial to select a different shutter speed before shooting.

4—Long Exp. NR 149

To reduce noise at shutter speeds of about $\frac{1}{2}$ s or slower, select **ON** for Custom Setting 4. Note that this will increase the time needed to process photographs before they are saved to the memory card.



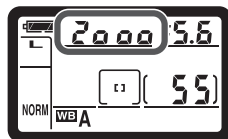
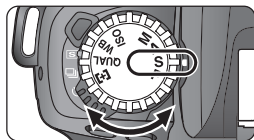

To take photographs in shutter-priority auto:

- 1 Rotate the function dial to **S**.
- 2 Rotate the main command dial to choose the desired shutter speed.
- 3 Frame a photograph and shoot.



Exposure Warning

If the camera is unable to produce the correct exposure at the selected shutter speed, the electronic analog exposure display ( 83) in the viewfinder will show the amount of under- or over-exposure and one of the following indicators will be displayed in the control panel and viewfinder aperture displays:

Indicator	Description
	Subject too bright. Choose faster shutter speed, lower sensitivity (ISO equivalency;  48), or use Neutral Density (ND) filter.
	Subject too dark. Choose slower shutter speed, raise sensitivity (ISO equivalency), or use flash ( 98).

9—EV Step (151)

This option controls whether changes to shutter speed and aperture are made in increments equivalent to $\frac{1}{3}$ EV (the default setting) or $\frac{1}{2}$ EV.

13—Command Dial (154)

This option can be used to reverse the roles of the command dials so that the sub-command dial controls shutter speed, while the main command dial controls aperture.

A: Aperture-Priority Auto

In aperture-priority auto, you choose the aperture while the camera automatically selects the shutter speed that will produce the optimal exposure. Small apertures (high *f*-numbers) increase depth of field, bringing both the main subject and background into focus. Large apertures (low *f*-numbers) soften background details and let more light into the camera, increasing the range of the flash and making photographs less susceptible to blurring. Aperture-priority auto is only available with CPU lenses.

To take photographs in aperture-priority auto:

1 Rotate the function dial to **A**.

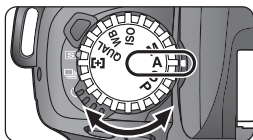

2 Rotate the sub-command dial to choose the desired aperture. The minimum and maximum values for aperture are determined by the lens currently in use.

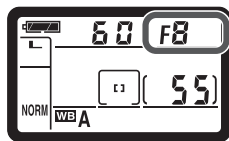

3 Frame a photograph and shoot.

Exposure Warning

If the camera is unable to produce the correct exposure at the selected aperture, the electronic analog exposure display (83) in the viewfinder will show the amount of under- or over-exposure and one of the following indicators will be displayed in the control panel and viewfinder shutter-speed displays:

Indicator	Description
Hi	Subject too bright. Choose smaller aperture (larger <i>f</i> -number), lower sensitivity (ISO equivalency), or use Neutral Density (ND) filter.
Lo	Subject too dark. Choose larger aperture (smaller <i>f</i> -number), raise sensitivity (ISO equivalency), or use flash (98).

M: Manual

In manual exposure mode, you control both shutter speed and aperture. Shutter speed can be set to values between 30 s and $\frac{1}{4,000}$ s, or the shutter can be held open indefinitely for a long time-exposure (**bulb**). Aperture can be set to values between the minimum and maximum values for the lens. Using the electronic analog exposure display in the viewfinder, you can adjust exposure according to shooting conditions and the task at hand.

To take photographs in manual exposure mode:

- 1 Rotate the function dial to **M**.

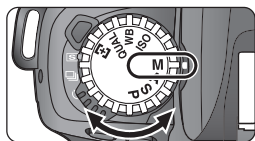

- 2 Rotate the main command dial to choose a shutter speed, and the sub-command dial to set aperture. Check exposure in the electronic analog exposure display (see opposite), and continue to adjust shutter speed and aperture until the desired exposure is achieved.

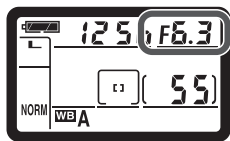
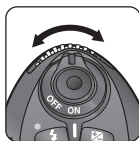
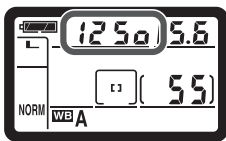

- 3 Frame a photograph and shoot. If shutter speed is set to **bulb**, the shutter will remain open while the shutter-release button is held down.



Non-CPU Lenses

If a non-CPU lens is attached in manual exposure mode, **F-** will appear in the aperture displays in the control panel and viewfinder. Aperture must be adjusted manually using the lens aperture ring. The camera exposure meter can not be used, and exposure will not be displayed in the electronic analog exposure display.

 Long Time-Exposures

At a shutter speed of **b u l b**, the shutter will remain open while the shutter-release button is held down. Note that if the shutter is open for more than approximately $\frac{1}{2}$ s at any setting, “noise” in the form of randomly-spaced, brightly-colored pixels may appear in the final photograph.

 Electronic Analog Exposure Display

The electronic analog exposure display shows whether the photograph would be under- or over-exposed at current settings. Depending on the option chosen for Custom Setting 9 (**EV Step**), the amount of under- or over-exposure is shown in increments of $\frac{1}{3}$ EV or $\frac{1}{2}$ EV. If the limits of the exposure metering system are exceeded, the electronic analog exposure display will flash.

Custom Setting 9 set to “1/3 Step”	Custom Setting 9 set to “1/2 Step”
Optimal exposure + . . 0 . . -	Optimal exposure + . . . 0 . . . -
Underexposed by $\frac{1}{3}$ EV + . . 0 . . -	Underexposed by $\frac{1}{2}$ EV + . . . 0 . . . -
Overexposed by more than 2 EV + ■■■■ 0 . . -	Overexposed by more than 3 EV + ■■■■ 0 . . . -

The electronic analog exposure display is not shown when shutter speed is set to **b u l b**.

 4—Long Exp. NR  149

To reduce noise at shutter speeds of about $\frac{1}{2}$ s or slower, select **ON** for Custom Setting 5. Note that this increases the time needed to save photographs to the memory card.

 9—EV Step  151

This option controls whether changes to shutter speed and aperture are made in increments equivalent to $\frac{1}{3}$ EV (the default setting) or $\frac{1}{2}$ EV.

 13—Command Dial  154

This option can be used to reverse the roles of the command dials so that the sub-command dial controls shutter speed, while the main command dial controls aperture.

Autoexposure Lock

When center-weighted metering is used, an area in the center of the frame is assigned the greatest weight when determining exposure. Similarly, when spot metering is used, exposure is based upon lighting conditions in the currently selected focus area. If your subject is not in the metered area when the picture is taken, exposure will be based on lighting conditions in the background, and your main subject may be under- or over-exposed. To prevent this, use autoexposure lock:

- 1 Select center-weighted or spot metering. If using center-weighted metering, select the center focus area with the multi selector (64).

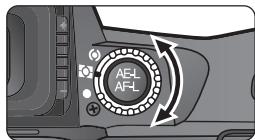

- 2 Position the subject in the selected focus area and press the shutter-release button halfway. Keeping the shutter-release button pressed halfway and your subject positioned in the focus area, press the **AE-L/AF-L** button to lock exposure (and focus, except in manual focus mode). Confirm that the in-focus indicator (●) appears in the viewfinder.

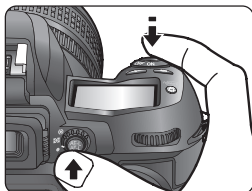
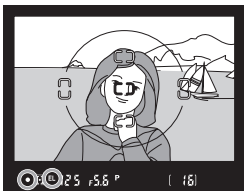

While exposure lock is in effect, an **EL** indicator will appear in the viewfinder.

- 3 Keeping the **AE-L/AF-L** button pressed, recompose your photograph and shoot.

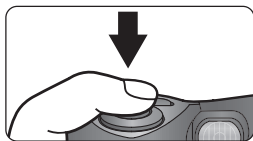
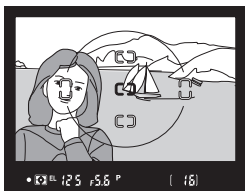

Metered Area

In spot metering, exposure will be locked at the value metered in a 3-mm (0.12") circle centered on the selected focus area. If closest subject priority ( 67) is in effect, the center focus area will be used to set exposure. In center-weighted metering, exposure will be locked at the value metered in an 8-mm (0.31") circle at the center of the viewfinder.

Adjusting Shutter Speed and Aperture

While exposure lock is in effect, you can change the following settings without changing the metered value for exposure:

Exposure mode	Settings
Auto multi program	Shutter speed and aperture (flexible program;  78)
Shutter-priority auto	Shutter speed
Aperture-priority auto	Aperture

The new values can be confirmed in the viewfinder and control panel.

14—AE-L/AF-L (154)

Depending on the option selected, the AE-L/AF-L button locks both focus and exposure (the default setting), only focus, or only exposure. If you choose **AE Lock Hold**, exposure will lock when the button is pressed and remain locked until it is pressed again.



15—AE-Lock (155)

If **+Shutter Button** is selected for **AE Lock**, exposure will lock when the shutter-release button is pressed halfway.

Exposure Compensation

To obtain the desired results with certain subject compositions, it may be necessary to use exposure compensation to alter exposure from the value suggested by the camera. As a rule of thumb, positive compensation may be needed when the main subject is darker than the background, negative values when the main subject is brighter than the background.

- Pressing the  button, rotate the main command dial and confirm exposure compensation in the control panel or viewfinder. Exposure compensation can be set to values between -5 EV (underexposure) and $+5$ EV (overexposure) in increments of $1/3$ EV.

At values other than ± 0 , a  icon will be displayed in the control panel and viewfinder after you release the  button, and the “0” at the center of the electronic analog exposure display will blink. The current value for exposure compensation can be confirmed in the electronic analog exposure display or by pressing the  button.



-0.3 EV

- Frame the photograph, focus, and shoot.

Normal exposure can be restored by setting exposure compensation to ± 0 or performing a two button reset ( 109). Exposure compensation is not reset when the camera is turned off.

9—EV Step (151)

This option can be used to set the increments for exposure compensation to $1/2$ EV.

10—Exposure Comp. (152)

If desired, exposure compensation can be set without pressing the  button.

For more information on:

102 Flash exposure compensation.



Bracketing

The D100 offers three types of bracketing: exposure bracketing, flash bracketing, and white balance bracketing. In exposure bracketing, the camera varies exposure compensation with each shot, while in the case of flash bracketing, flash exposure compensation (flash level;  102) is varied with each shot. In both cases, only one photograph is produced each time the shutter-release button is pressed. Several shots (from two to three) are therefore required to complete the bracketing sequence. Exposure compensation and flash bracketing are recommended in situations in which you find it difficult to set exposure and yet do not have time to check the results and adjust settings with each shot.



In white balance bracketing, the camera creates multiple images each time the shutter is released, each with a different white balance adjustment ( 50). Only one shot is required to complete the bracketing sequence. White balance bracketing is recommended when shooting under mixed lighting or when you want to experiment with different white balance settings. White balance bracketing is not available at image qualities of **NEF (Raw)** or **Comp. NEF (Raw)**.



Using the Self-Timer

If exposure or flash bracketing is used in self-timer mode, one picture will be taken each time the shutter is released. If white-balance bracketing is used, the camera will create the number of copies specified in the bracketing program with each shot.

Exposure and Flash Bracketing

1 Select the type of bracketing to be performed using Custom Setting 11 (**BKT Set**;  153). Choose **AE & Flash** to vary both exposure and flash level (the default setting), **AE Only** to vary only exposure, or **Flash Only** to vary only flash level. For more information on adjusting custom settings, see “Menu Guide” ( 121).

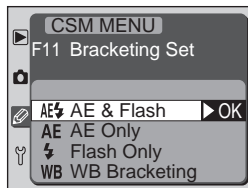

2 Pressing the **BKT** button, rotate the main command dial until **BKT** is displayed in the control panel.

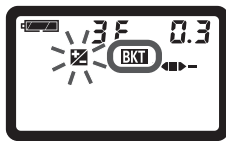

3 Pressing the **BKT** button, rotate the sub-command dial to choose a bracketing program ( 92).

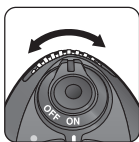

Continuous Shooting Mode

In continuous shooting mode, shooting will pause after the number of shots specified in the bracketing program have been taken. Shooting will resume the next time the shutter-release button is pressed.

Resuming Exposure or Flash Bracketing

If the memory card fills before all shots in the sequence have been taken, shooting can be resumed from the next shot in the sequence after the memory card has been replaced or shots have been deleted to make room on the memory card. If the camera is turned off before all shots in the sequence have been taken, bracketing will resume from the next shot in the sequence when the camera is turned on.

- 4 Compose a photograph, focus, and shoot. The camera will vary exposure and/or flash level shot-by-shot according to the bracketing program selected. Modifications to exposure and flash level are added to those made with exposure compensation (📷 86) and flash exposure compensation (📷 102).

When exposure or flash bracketing is in effect, the 📷 icons in the control panel and viewfinder will flash. A segment will disappear from the bracketing indicator after each shot. When the unmodified shot is taken, the middle segment will disappear (+◀▶-/+◀▶-). The right segment will disappear when a shot with negative modification is taken (▶-), the left segment when a shot with positive modification is taken (+▶). Bracketing begins again when all shots in the sequence are taken.

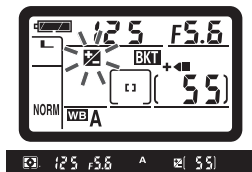

To cancel bracketing, press the **BKT** button and rotate the main command dial until **BKT** is no longer displayed in the control panel on top of the camera. The program last in effect will be restored the next time bracketing is activated. Bracketing can also be cancelled by performing a two-button reset (📷 110), although in this case the bracketing program will not be restored the next time bracketing is activated.



📷 Exposure Bracketing

When **AE & Flash** or **AE Only** is selected for Custom Setting 11, the camera will modify exposure by varying shutter speed and/or aperture. What settings are affected depends on the exposure mode:

Exposure mode	Camera sets exposure by varying
Programmed auto	Shutter speed and aperture
Shutter-priority auto	Aperture
Aperture-priority auto	Shutter speed
Manual	Shutter speed

The modified values for shutter speed and aperture are displayed during shooting.

White Balance Bracketing

- 1 Choose **WB Bracketing** for Custom Setting 11 (**BKT Set**;  153). For more information on adjusting custom settings, see “Menu Guide” ( 121).

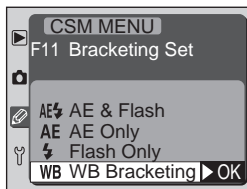

- 2 Pressing the **BKT** button, rotate the main command dial until **BKT** is displayed in the control panel.

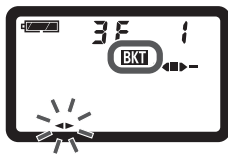

- 3 Pressing the **BKT** button, rotate the sub-command dial to choose a bracketing program ( 92).

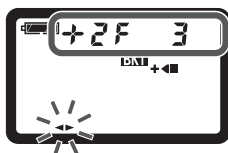
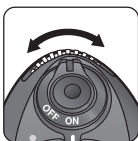

If the number of shots in the bracketing program is greater than the number of exposures remaining, the bracketing indicator will flash.



Continuous Shooting Mode

Even if continuous shooting mode is selected when white-balance bracketing is in effect, the shutter will be released only once each time the shutter-release button is pressed. Each shot will be processed to create the number of copies specified in the bracketing program.

- 4 Compose a photograph, focus, and shoot. Each shot will be processed to create the number of copies specified in the bracketing program, and each copy will have a different white balance. Modifications to white balance are added to the white balance adjustment made with white balance fine-tuning (🔍 53).

When white balance bracketing is in effect, the white balance adjustment indicator (◀▶) will flash.

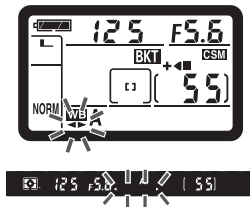

To cancel bracketing, press the **BKT** button and rotate the main command dial until **BKT** is no longer displayed in the control panel on top of the camera. The program last in effect will be restored the next time bracketing is activated. Bracketing can also be cancelled by performing a two-button reset (🔍 110), although in this case the bracketing program will not be restored the next time bracketing is activated.

🔍 NEF (Raw) and White Balance Bracketing

White balance bracketing can not be used with an image quality of **NEF (Raw)** or **Comp. NEF (Raw)**. Selecting either option cancels white balance bracketing. White balance for NEF (RAW) images can be adjusted using Nikon Capture 3 (available separately; 🔍 170).

🔍 Resuming White Balance Bracketing

If there is not enough memory remaining on the memory card to record all shots in a white-balance bracketing sequence, the shutter-speed display will show **FULL**, the number of exposures remaining will blink, and the shutter release will be disabled.

If the camera is turned off while the camera before all photographs in a white-balance bracketing sequence have been recorded, the camera will power off only after all photographs in the sequence have been recorded.

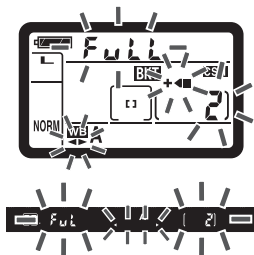

The bracketing programs available depend on the option selected for Custom Setting 11 and, in the cases of exposure and flash bracketing, on the size of the exposure increment selected for Custom Setting 9 (**EV Step**).

Exposure/Flash Bracketing

(Custom Setting 11 set to **AE & Flash**, **AE Only**, or **Flash Only**)

Custom Setting 9	Control panel display	Number of shots	Exposure increment	Bracketing order (EVs)
1/3 Step (default)	3F 0.3 +◀▶	3	$\pm 1/3$ EV	0, -0.3, +0.3
	3F 0.7 +◀▶	3	$\pm 2/3$ EV	0, -0.7, +0.7
	3F 1.0 +◀▶	3	± 1 EV	0, -1.0, +1.0
	3F 1.3 +◀▶	3	$\pm 1 1/3$ EV	0, -1.3, +1.3
	3F 1.7 +◀▶	3	$+ 1 2/3$ EV	0, -1.7, +1.7
	3F 2.0 +◀▶	3	± 2 EV	0, -2.0, +2.0
	+2F 0.3 +◀	2	$+ 1/3$ EV	0, +0.3
	+2F 0.7 +◀	2	$+ 2/3$ EV	0, +0.7
	+2F 1.0 +◀	2	+1 EV	0, +1.0
	+2F 1.3 +◀	2	$+ 1 1/3$ EV	0, +1.3
	+2F 1.7 +◀	2	$+ 1 2/3$ EV	0, +1.7
	+2F 2.0 +◀	2	+2 EV	0, +2.0
	--2F 0.3 ▶	2	$- 1/3$ EV	0, -0.3
	--2F 0.7 ▶	2	$- 2/3$ EV	0, -0.7
	--2F 1.0 ▶	2	-1 EV	0, -1.0
--2F 1.3 ▶	2	$- 1 1/3$ EV	0, -1.3	
--2F 1.7 ▶	2	$- 1 2/3$ EV	0, -1.7	
--2F 2.0 ▶	2	-2 EV	0, -2.0	
1/2 Step	3F 0.5 +◀▶	3	$\pm 1/2$ EV	0, -0.5, +0.5
	3F 1.0 +◀▶	3	± 1 EV	0, -1.0, +1.0
	3F 1.5 +◀▶	3	$\pm 1 1/2$ EV	0, -1.5, +1.5
	3F 2.0 +◀▶	3	± 2 EV	0, -2.0, +2.0

Custom Setting 9	Control panel display	Number of shots	Exposure increment	Bracketing order (EVs)
1/2 Step	+2F 0.5 +◀	2	+1/2 EV	0, +0.5
	+2F 1.0 +◀	2	+1 EV	0, +1.0
	+2F 1.5 +◀	2	+1 1/2 EV	0, +1.5
	+2F 2.0 +◀	2	+2 EV	0, +2.0
	--2F 0.5 ▶-	2	-1/2 EV	0, -0.5
	--2F 1.0 ▶-	2	-1 EV	0, -1.0
	--2F 1.5 ▶-	2	-1 1/2 EV	0, -1.5
--2F 2.0 ▶-	2	-2 EV	0, -2.0	

White Balance Bracketing

(Custom Setting 11 set to **WB Bracketing**)

Control panel display	Number of shots	White balance adjustment	Bracketing order
3F 1 +◀▶-	3	±1	0, -1, +1
3F 2 +◀▶-	3	±2	0, -2, +2
3F 3 +◀▶-	3	±3	0, -3, +3
+2F 1 +◀	2	+1	0, +1
+2F 2 +◀	2	+2	0, +2
+2F 3 +◀	2	+3	0, +3
--2F 1 ▶-	2	-1	0, -1
--2F 2 ▶-	2	-2	0, -2
--2F 3 ▶-	2	-3	0, -3

CSM 9—EV Step (👁️ 151)

This option controls the size of the increments for exposure and flash bracketing.

CSM 12—BKT Order (👁️ 153)

This option can be used to change the bracketing order.

Flash Photography

Using Built-in and Optional Speedlights

The D100 is equipped with a Guide Number 17/56 (ISO 200, m/ft; Guide Number at ISO 100 is 12/39) Speedlight with a flash angle wide enough to cover the field of view of a 20-mm lens. With a CPU lens, the built-in Speedlight supports D-TTL flash control for flash photographs with a natural balance. The built-in Speedlight can be used not only when natural lighting is inadequate, but to fill in shadows and backlit subjects or to add a catch light to your subject's eyes.

Flash Angle

While the built-in Speedlight can cover the field of view of a 20-mm lens, it may not be able to light the entire subject with some lenses or at some aperture settings.

ISO Auto

If a Speedlight is used when Custom Setting 3 (**ISO Auto**) is on, sensitivity (ISO equivalence) will be fixed at the value selected by the user.

Using an Optional Speedlight

If an optional Speedlight is used with spot metering, Standard TTL flash for digital SLR will be used. If the built-in Speedlight is raised when an optional Speedlight other than the SB-50DX is attached, the optional Speedlight will not fire. If an SB-50DX is set to manual in the bounce flash position, both the built-in Speedlight and the SB-50DX will fire.

D-TTL Flash Control

The type of D-TTL flash control available varies with the type of lens used:







Lens	Flash control for built-in Speedlight
Type G or D CPU lens	3D Multi-Sensor Balanced Fill-Flash for Digital SLR: Based on information from the matrix metering system, flash output is adjusted for a natural balance between the main subject and ambient background lighting. The Speedlight emits a series of nearly invisible preflashes (monitor preflashes) immediately before the main flash. Preflashes reflected from objects in all areas of the frame are picked up by the camera's through-the-lens (TTL) multi sensor, where they are analyzed instantaneously in combination with data on the current sensitivity (ISO equivalency) setting, aperture, lens focal length, exposure compensation, and distance information provided by the lens. The results of this analysis are used to balance flash output with natural light. 3D multi-sensor balanced fill-flash for digital SLR is not available in manual exposure mode or when spot metering is used.
Other CPU lens	Multi-Sensor Balanced Fill-Flash for Digital SLR: As above, except that distance information is not included in regulating flash output. Not available in manual exposure mode or when spot metering is used.
All types	Standard TTL Flash for Digital SLR: Flash output is adjusted to ensure that the main subject is correctly exposed, without taking the background into account. It is recommended for shots in which the main subject is emphasized at the expense of background details, or when exposure compensation is used. Standard TTL flash for digital SLR is activated automatically when: <ul style="list-style-type: none"> • Built-in Speedlight: the function dial is set to M (manual exposure mode) or spot metering is selected • Optional Speedlight: spot metering is selected

23—Flash Mode 158

D-TTL flash control is only available when Custom Setting 23 (**Flash Mode**) is set to **D-TTL**. When Custom Setting 23 is set to **Manual**, the built-in Speedlight will fire at full power (GN at ISO 200 18/59, at ISO 100 12.7/42, m/ft) with every shot with no monitor pre-flashes.

Flash Sync Modes

The D100 supports the following flash sync modes:

Flash sync mode	Flash control
 Front-curtain sync	This mode is recommended for most situations. In auto multi program and aperture-priority auto modes, shutter speed will automatically be set to values between $\frac{1}{60}$ s and $\frac{1}{180}$ s.
 Red-eye reduction	AF-assist illuminator lights for approximately one second before main flash fires, causing pupils in subject's eyes to contract and reducing the "red-eye" effect a flash can sometimes cause. Best when subject is well within range of flash and fully facing camera. Because shutter is not released until about one second after shutter-release button is pressed all the way down, this mode is not recommended for subjects that are moving erratically or on other occasions when you want the camera to respond quickly to shutter-release button. After pressing shutter-release button, do not move camera until photo has been taken.
 Red-eye reduction with slow sync	Combines red-eye reduction with slow sync. This mode is only available in auto multi program and aperture-priority auto exposure modes. Use of a tripod is recommended to prevent blurring caused by camera shake.
 Slow sync	Flash is combined with speeds as slow as 30 s to capture both subject and background at night or under dim light. This mode is only available in auto multi program and aperture-priority auto exposure modes. Use of a tripod is recommended to prevent blurring caused by camera shake.
 Rear-curtain sync	In shutter-priority auto or manual exposure mode, the flash fires just before the shutter closes, creating the effect of a stream of light behind moving objects. In auto multi program and aperture-priority auto, slow rear-curtain sync is used to capture both subject and background. Use of a tripod is recommended to prevent blurring caused by camera shake.
 Slow rear-curtain sync	

 **Red-Eye Reduction**

Depending on the lens used and the position of your subject, the AF-assist illuminator (red-eye reduction lamp) may not be visible to your subject, with the result that red-eye reduction may not have the desired effect.

 **Studio Flash Systems**

Rear-curtain sync can not be used with studio flash systems, as the correct synchronization can not be obtained.

 **Flash Sync Modes for Optional Speedlights**

Front- and rear-curtain sync modes for SB-series 26, 25, and 24 Speedlights is set using the sync mode selector on the optional Speedlight. If red-eye reduction or slow-sync with red-eye reduction is selected with an SB-series 80DX, 28DX, 28, 27, or 26 Speedlight attached, the Speedlight red-eye reduction lamp will be used.

Using the Built-in Speedlight

Follow the steps below to take photographs with the built-in Speedlight and a type G or D lens.



1 To enjoy the benefits of 3D multi-sensor balanced fill-flash for digital SLR, choose matrix or center-weighted metering (75).

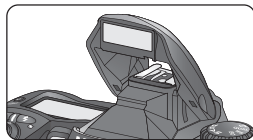

2 Press the Speedlight lock release. The built-in Speedlight will pop up and begin charging.

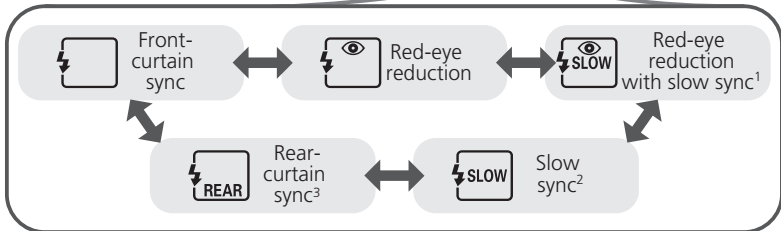
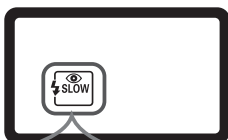
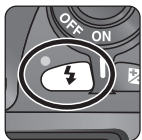



3 Press the  button and rotate the main command dial until the desired flash sync mode is selected in the control panel.



¹ Red-eye reduction with slow sync is available only in auto multi program and aperture-priority auto exposure modes. In shutter-priority auto and manual exposure modes,  (red-eye reduction) will be selected when you release the  button.

² Slow sync is available only in auto multi program and aperture-priority auto exposure modes. In shutter-priority auto and manual exposure modes,  (front-curtain sync) will be selected when you release the  button.

³ In auto multi program and aperture-priority auto exposure modes, flash-sync mode will be set to  (slow rear-curtain sync)³ when you release the  button.

- 4 Choose an exposure mode (📷 76). Note that if manual exposure is selected, standard TTL flash for digital SLR will be used.
- 5 Set shutter speed and aperture. The values that can be chosen for shutter speed and aperture when the built-in Speedlight is raised are shown below.

Exposure mode	Shutter speed	Aperture	
Auto multi program	Set automatically by camera*	Set automatically by camera	77
Shutter-priority auto	$\frac{1}{180}$ s–30 s†		79
Aperture-priority auto	Set automatically by camera*	Value chosen by user**	81
Manual	$\frac{1}{180}$ s–30 s, b u l b †		82

* Shutter speeds are set automatically in the range $\frac{1}{180}$ s– $\frac{1}{60}$ s, or $\frac{1}{180}$ s–30 s at flash sync settings of slow sync, slow rear-curtain sync, and red-eye reduction with slow sync.

† Speeds faster than $\frac{1}{180}$ s will be reduced to $\frac{1}{180}$ s while the built-in Speedlight is raised. The viewfinder shutter-speed display will show the modified value; the original value will blink on and off in the control panel display.

** Flash range varies with aperture. When setting aperture in aperture-priority auto and manual exposure modes, consult the table of flash ranges on the following page.

- 6 Check that the flash-ready indicator appears in the viewfinder. If the built-in Speedlight is raised, photographs can only be taken when the flash-ready lamp is displayed.



- 7 Compose your photograph, making sure that your subject is within range of the flash (📷 100), then focus and shoot. If the flash-ready light blinks for about three seconds after the photograph is taken, the flash has fired at full output and the photograph may be underexposed. Check the results in the monitor. If the photograph is underexposed, adjust settings and try again.



When the Speedlight Is Not in Use

To save battery power when the Speedlight is not in use, return it to the closed position by pressing it lightly downward until you hear the latch click into place.



Flash Range, Aperture, and Sensitivity

Flash range varies with sensitivity (ISO equivalency) and aperture.

Aperture at an ISO equivalent of											Range	
200	250	320	400	500	640	800	1000	1250	1600		m	ft
2	2.2	2.5	2.8	3.2	3.5	4	4.5	5	5.6		2–8.5	6'7"–27'11"
2.8	3.2	3.5	4	4.5	5	5.6	6.3	7.1	8		1.4–6	4'7"–19'8"
4	4.5	5	5.6	6.3	7.1	8	9	10	11		1–4.2	3'3"–13'9"
5.6	6.3	7.1	8	9	10	11	13	14	16		0.7–3	2'4"–9'10"
8	9	10	11	13	14	16	18	20	22		0.6–2.1	2'–6'11"
11	13	14	16	18	20	22	25	29	32		0.6–1.5	2'–4'11"
16	18	20	22	25.4	29	32	—	—	—		0.6–1.1	2'–3'7"
22	25	29	32	—	—	—	—	—	—		0.6–0.8	2'–2'7"

The minimum range at which the built-in Speedlight will be able to light the entire subject is 0.6 m (2').

In auto multi program, the maximum aperture (minimum f/-number) is limited according to sensitivity (ISO equivalency), as shown below:

Maximum aperture at an ISO equivalent of										
200	250	320	400	500	640	800	1000	1250	1600	
3.3	3.5	3.8	4	4.2	4.5	4.8	5	5.3	5.6	

For each one-step increase in sensitivity (e.g., from 200 to 400), aperture is stopped down by half an f/-stop. If the maximum aperture of the lens is smaller than given above, the maximum value for aperture will be the maximum aperture of the lens.

D-TTL flash control can be used to adjust flash output at sensitivity (ISO equivalency) settings between 200 and 1600. At settings of HI-1 and HI-2, the desired results may not be achieved at some ranges or aperture settings.



Using the Built-in Speedlight

If the built-in Speedlight is raised in continuous shooting mode, only one photograph will be taken each time the shutter-release button is pressed.

Vibration reduction (available with VR lenses) will not take effect if the shutter-release button is press halfway while the built-in Speedlight is charging.

Compatible Lenses

The built-in Speedlight can be used with any CPU lens having a focal length of 20–300 mm (35-mm equivalent). Note, however, that if the following zoom lenses are not used at the zoom positions and ranges given below, the built-in Speedlight may be unable to light the entire subject:

Lens	Restrictions
AF-S ED 17–35 mm f/2.8	At 24 mm, can be used at ranges of 0.8 m (2'7") or more.
AF 20–35 mm f/2.8	At 20 mm, use at ranges of 1 m (3'3") or more.
AF-S ED 28–70 mm f/2.8	At 28 mm, use at ranges of 2 m (6'7") or more. At 35 mm, use at ranges of 0.7 m (2'4") or more.

The built-in Speedlight can not be used in the macro range of macro zoom lenses.

The built-in Speedlight can also be used with Ai-S, AI, and AI-modified non-CPU lenses having a focal length of 20–200 mm (35-mm equivalent). Note, however, that if the following zoom lenses are not used at the zoom positions and ranges given below, the built-in Speedlight may be unable to light the entire subject:

Lens	Restrictions
Ai-modified 50–300 mm f/4.5 Ai 50–300 mm f/4.5	Use at 200 mm.
Ai-modified 85–250 mm f/4 Ai ED 50–300 mm f/4.5 Ai-S ED 50–300 mm f/4.5	Can be used at 135 mm and above.

Remove lens hoods when using the built-in Speedlight.



23—Flash Mode 158)

D-TTL flash control is only available when Custom Setting 23 (**Flash Mode**) is set to **D-TTL**. When Custom Setting 23 is set to **Manual**, the built-in Speedlight will fire at full power (GN at ISO 200 18/59, at ISO 100 12.7/42, m/ft) with every shot with no monitor pre-flashes.

Flash Exposure Compensation

Flash exposure compensation is used to increase or reduce flash output from the level chosen by the camera's flash control system. Flash output can be increased to make the main subject appear brighter, or reduced to prevent unwanted highlights or reflections. As a rule of thumb, positive compensation may be needed when the main subject is darker than the background, negative compensation when the main subject is brighter than the background.

- Pressing the  button, rotate the main command dial and confirm flash exposure compensation in the control panel or viewfinder. Flash exposure compensation can be set to values between -3 EV (darker) and $+1$ EV (brighter) in increments of $1/3$ EV.

At values other than ± 0 , a  icon will be displayed in the control panel and viewfinder after you release the  button. The current value for flash exposure compensation can be confirmed by pressing the  button.

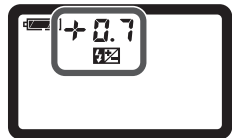
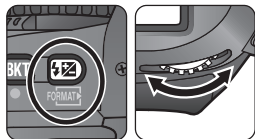

- Take a picture as instructed in the preceding section, "Using the Built-in Speedlight" ( 98).

Normal flash output can be restored by setting flash exposure compensation to ± 0 or performing a two button reset ( 110). Flash exposure compensation is not reset when the camera is turned off.

Using an Optional Speedlight

Flash exposure compensation can also be used with optional Speedlights

9—EV Step (151)

This option can be used to set the increments for flash compensation to $1/2$ EV.



Using an Optional Speedlight

Optional Speedlights with D-TTL Flash Control

SB-series 80DX, 50DX, and 28DX Speedlights support D-TTL flash control when mounted on the camera accessory shoe (📷 104). D-TTL flash control is not available with other optional Speedlights (📷 106).

The type of flash control available with SB-series 80DX, 50DX, and 28DX Speedlights depends on the type of lens attached:

Lens	Flash control
Type G or D CPU lens	3D Multi-Sensor Balanced Fill-Flash for Digital SLR
Other CPU lens	Multi-Sensor Balanced Fill-Flash for Digital SLR
All types	Standard TTL Flash for Digital SLR

The SB-80DX and SB-50DX Speedlights

The SB-80DX and SB-50DX support D-TTL flash control (📷 95). When used in combination with a type G or D lens, they support 3D multi sensor balanced fill flash for digital SLR for natural, balanced light, even when the scene contains highly reflective objects or the background is very far from the camera. Both models offer AF-assist illumination, and are equipped with auto power zoom that adjusts the flash angle according to the focal length of the lens.

Nikon SB-80DX Speedlight

The SB-80DX is a high-performance Speedlight with a guide number of 53/174 (m/ft, manual mode, 35-mm zoom-head position, ISO 200, 20 °C/68 °F; GN at ISO 100 is 38/125). It can be powered by four LR6 (AA) alkaline batteries or by SD-7, SD-8A, and SK-6 power sources (all available separately). For bounce-flash or close-up photography, the flash head can be rotated through 90 ° up, 7 ° down, 180 ° left, and 90 ° right. Light from the flash can be diffused for wide-angle photography by using the SB-80DX in combination with a wide panel or bounce adapter, producing soft lighting that balances the foreground subject with the background in close-ups and bounce-flash photography. The SB-80DX is equipped with an illuminator to assist in adjusting settings in the dark. Custom settings allow you to fine-tune all aspects of flash operation.

Nikon SB-50DX Speedlight

The SB-50DX has a guide number of 32/105 (m/ft, manual mode, 35-mm zoom-head position, ISO 200, 20 °C/68 °F; GN at ISO 100 is 22/72) and is powered by two CR123A (DL123A) three-volt lithium batteries. In addition to auto power zoom, it has a tilt position of +90 ° to -18 °, allowing the flash to be used both for bounce-flash photography and at ranges as close as 30 cm (1'). The SB-50DX supports the following flash modes: slow sync, rear-curtain sync, and manual. If the built-in Speedlight is raised when the SB-50DX is set to manual in the bounce-flash position, both Speedlights will fire.



The Accessory Shoe

The D100 is equipped with an accessory shoe that allows SB-series Speedlights, including the SB-80DX, 50DX, 30, 29s, 27, 26, 25, 24, 23, and 22s, to be mounted directly on the camera without a sync cable. The accessory shoe is equipped with a safety lock for Speedlights with a locking pin (SB-series 29s, 27, 26, 25, and 22s). An AS-15 accessory shoe adapter (available separately) can be attached to the shoe, allowing flash accessories to be attached via a sync cable.



Compatible Speedlights

The following Speedlights support D-TTL flash control:

Flash mode Speedlight	D-TTL	AA	A	M		REAR	
	D-TTL ¹	Auto aperture	Non-TTL auto	Manual	Repeating flash	Rear-curtain sync	Red-eye reduction
SB-80DX/SB-28DX	✓	✓ ²	✓	✓	✓	✓	✓
SB-50DX	✓	—	—	✓	—	✓	—

1 Standard TTL Flash for Digital SLR is used when spot metering is selected. With matrix and center-weighted metering, flash control depends on lens type:

- Type G or D Nikkor (excluding IX Nikkor): 3D Multi Sensor Balanced Fill Flash for Digital SLR.
- Other CPU Nikkor (excluding AF Nikkor lenses for F3AF): Multi Sensor Balanced Fill Flash for Digital SLR.
- Other Nikkor: Standard TTL Flash for Digital SLR.

2 Available with CPU lenses only (IX Nikkor and AF Nikkor lenses for F3AF excluded). Use spot metering.

Use Only Nikon Flash Accessories

Use only Nikon Speedlights. Negative voltages or voltages over 250 V applied to the accessory shoe could not only prevent normal operation, but damage the sync circuitry of the camera or flash. Before using a Nikon Speedlight not included in the list on the previous page, contact a Nikon-authorized service representative for more information.

Read the Speedlight Manual

For complete information on using optional Speedlights, refer to the Speedlight manual. If your Speedlight supports D-TTL flash control, read the section on digital single-lens reflex cameras in the Speedlight manual (note that the D100 does not support FP high-speed sync).



The following Speedlights can be used in non-TTL auto and manual modes. If they are set to TTL, the camera shutter-release button will lock and no photographs can be taken.

Flash mode Speedlight	A	M		REAR	
	Non-TTL auto	Manual	Repeating flash	Rear-curtain sync	Red-eye reduction
SB-28/SB-26 ¹	✓	✓	✓	✓	✓
SB-27 ²	✓	✓	—	✓	✓
SB-25/SB-24	✓	✓	✓	✓	—
SB-23 ³ /SB-29 (SB-29s) ⁴ /SB-21B ^{3,4}	—	✓	—	✓	—
SB-30/SB-22S/ SB-22/SB-20/ SB-16B/SB-15	✓	✓	—	✓	—
SB-11 ⁵ /SB-14 ⁵	✓	✓	—	✓	—

1 The SB-26 can be set to slave mode for wireless slave flash photography. When the wireless slave selector is set to D, shutter speed will be set to under $\frac{1}{125}$ s.

2 When an SB-27 is mounted on the D100, the flash mode is automatically set to TTL, and the shutter-release will be disabled. Set the SB-27 to A (non-TTL auto flash).

3 Manual mode only. Use is not recommended.

4 Autofocus is only available with AF-Micro lenses (60 mm, 105 mm, 200 mm, or 70–180 mm).

5 When using the SB-11 or SB-14 in A or M mode, use the SU-2 with an SC-13 sync cable. Although SC-11 and SC-15 sync cables can be used, the flash-ready indicator will not appear in the viewfinder and shutter speed will not be adjusted automatically.



Notes on Optional Speedlights

The shutter will synchronize with an external flash at speeds of $\frac{1}{180}$ s or slower.

D-TTL flash control can be used to adjust flash output at sensitivity (ISO equivalency) settings between 200 and 1600. At settings of HI-1 and HI-2, the desired results may not be achieved at some ranges or aperture settings.

If rear-curtain sync is selected with SB-series 26, 25, or 24 Speedlights, this setting takes priority over the flash-sync mode selected with the camera, except in the cases of red-eye reduction and slow sync with red-eye reduction.

Notes on Optional Speedlights (Continued)

If an optional Speedlight with red-eye reduction is attached when the camera flash sync mode is set to red-eye reduction or auto with red-eye reduction, the red-eye reduction lamp on the optional Speedlight will be used.

On Speedlights with a built-in AF assist illuminator (SB-series 80DX, 28DX, 28, 27, and 26), the AF-assist illuminator will only light if all of the following conditions are met: focus mode is set to single-servo auto, an AF-Nikkor lens is used, the subject is poorly lit, and the center focus area is selected or dynamic-area AF is used in combination with closest-subject priority. When the SB-24 is used with the SK-6 power bracket, neither the AF-assist illuminator on the Speedlight nor the camera AF-assist illuminator will light.

In auto multi program, the maximum aperture (minimum f/-number) is limited according to sensitivity (ISO equivalency), as shown below:

Maximum aperture at an ISO equivalent of									
200	250	320	400	500	640	800	1000	1250	1600
4.8	5	5.3	5.6	6	6.3	6.7	7.1	7.6	8

For each one-step increase in sensitivity (e.g., from 200 to 400), aperture is stopped down by half an f/-stop. If the maximum aperture of the lens is smaller than given above, the maximum value for aperture will be the maximum aperture of the lens.

Use the AS-15 accessory shoe adapter (available separately) when attaching flash accessories via a sync cable.

If flash compensation is performed with an optional Speedlight, the flash compensation indicator will appear in the viewfinder, but the amount of flash compensation will not be displayed.

When an SC-17 sync cable is used for off-camera flash photography, correct exposure may not be achieved in D-TTL mode. We recommend that you choose spot metering to select Standard TTL Flash for Digital SLR. Take a test shot and view the results in the monitor.



TTL flash control can not be used for multi-flash photography.

In D-TTL mode, use the flash panel provided with your Speedlight. Do not use other panels such as diffusion panels, as this may produce incorrect exposure.

Self-Timer Mode

Delaying Shutter Release

The self-timer can be used to reduce camera shake or for self-portraits. To use the self-timer:

- 1 Mount the camera on a tripod (recommended) or place the camera on a stable, level surface.
- 2 Press the shooting mode dial lock release and rotate the shooting mode dial to select  (self-timer mode).
- 3 Frame the photograph and press the shutter-release button halfway to focus. In single-servo autofocus ( 63), photographs can only be taken if the in-focus () indicator appears in the viewfinder.

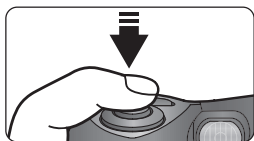
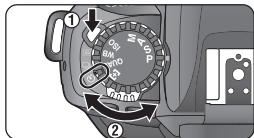

bulb

In self-timer mode, a shutter speed of **bulb** is equivalent to approximately $\frac{1}{4}$ s.

8—Self-timer **151**

Self-timer delay can be set to 2 s, 5 s, 10 s (the default setting), or 20 s.

- 4 Press the shutter-release button all the way down to start the self-timer. The self-timer lamp (AF-assist illuminator) will start to blink, stopping two seconds before the photograph is taken.

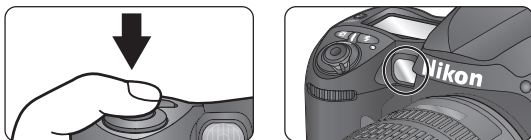

To turn the self-timer off before a photograph is taken, turn the mode dial to another setting.

Autofocus





When autofocus is in effect, the camera focuses when the shutter-release button is pressed. Do not stand in front of the camera when activating the self-timer.

Cover the Viewfinder

To ensure correct exposure in exposure modes other than manual, cover the viewfinder eyepiece with the supplied DK-5 eyepiece cap or with your hand before pressing the shutter-release button. This will prevent light entering via the viewfinder from interfering with the autoexposure operation.

Two-Button Reset

Restoring Default Settings

The camera settings listed below can be restored to default values by holding the  and  buttons down together for more than two seconds (the  and  buttons are marked with a green dot). Custom Settings are not affected.

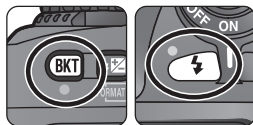

Option	Default
Focus area	Center
AF-area mode	Single-area AF
Flexible program	Off
Exposure compensation	±0.0

Option	Default
Autoexposure lock	Off
Bracketing	Off
Flash sync mode	Front-curtain sync
Flash compensation	±0.0

The following shooting-menu options will also be reset. Only settings in the bank currently selected using the shooting menu **Bank Select** option will be reset ( 135). Settings in the remaining bank are unaffected.

Option	Default
Image Quality	JPEG-Normal
Resolution	Large
White Bal	Auto

Option	Default
White balance adjustment	±0
ISO	200

Two-Button Reset

A two-button reset can only be performed when the function dial is set to P, S, A, or M.

R—MENU Reset (145)

Custom Settings can be restored to default values by selecting **ON** for Custom Setting R (**MENU Reset**).



More About Playback

Playback Options

This section details the operations that can be performed during playback, including thumbnail playback, playback zoom, and photo information display.

Single-Image Playback

To play photographs back, press the  button. The most recent photograph will be displayed in the monitor.

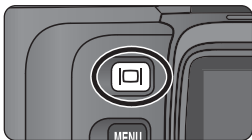

To end playback and return to shooting mode, press the  button or press the shutter-release button halfway.

Using the Multi Selector

The multi selector can be used at any time when the monitor is on. The focus selector lock switch only takes effect when the monitor is off.

1—Image Review 147

When **ON** is selected for **Image Review** (Custom Setting 1), photographs are automatically displayed in the monitor as they are being recorded to the memory card. In single-frame and self-timer modes, photographs are displayed one at a time as they are taken. In continuous shooting mode, display begins when shooting ends, with the first photograph in the current series displayed. Playback will be interrupted when the shutter-release button is pressed, and resume when the button is released after shooting.

6—Monitor Off 151

The monitor will turn off automatically to save power if no operations are performed for the time specified in Custom Setting 6 (**Monitor Off**). Press the  button again to return to playback mode.

Photo Information

Photo information is superimposed on images displayed in single-image playback. Depending on the option selected for **Display Mode** in the playback menu (134), there are up to six pages of information for each photo. Press the multi-selector left or right to cycle through photo information as follows: Page 1 ↔ Page 2 ↔ Page 3 ↔ Page 4 ↔ (Page 5) ↔ (Page 6) ↔ no info ↔ Page 1.

Page 1

- | | |
|----------------------------|-----------------------|
| 1 Voice memo icon... 180 | 3 Folder number-frame |
| 2 Protect status 119 | number 126 |



Page 2

- | | |
|----------------------------|----------------------------|
| 1 Voice memo icon... 180 | 6 File format 44 |
| 2 Protect status 119 | 7 Image quality 44 |
| 3 Frame number/total | 8 Date of recording ... 19 |
| number of frames .. 23 | 9 Time of recording ... 19 |
| 4 Folder name 126 | 10 Image size 46 |
| 5 File name 44 | |

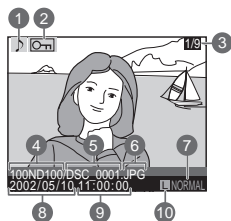

Page 3

- | | |
|----------------------------|---------------------------|
| 1 Voice memo icon... 180 | 6 Shutter speed ... 76–83 |
| 2 Protect status 119 | 7 Aperture 81–83 |
| 3 Camera type | 8 Exposure mode 76 |
| 4 Camera firmware | 9 Exposure |
| version | compensation 86 |
| 5 Metering method ... 75 | 10 Focal length |

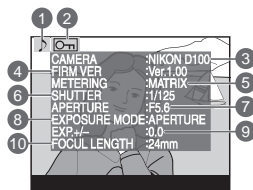

Page 4

- | | | |
|--|---------------------------|-----|
| 1 Voice memo icon .. 180 | 6 Tone compensation | 59 |
| 2 Protect status | 7 Sharpening | 58 |
| 3 Sensitivity (ISO
equivalency) | 8 Color mode | 60 |
| 4 White balance | 9 Flash mode | 95 |
| 5 White balance
adjustment | 10 Comment | 164 |

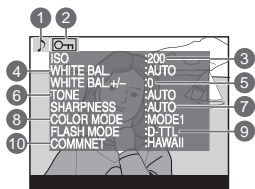

Page 5 (Histogram)

- 1 Voice memo icon .. 180
- 2 Protect status
- 3 Histogram showing the distribution of tones in the image. The horizontal axis corresponds to pixel brightness, with dark tones to the left and bright tones to the right. The vertical axis shows the number of pixels of each brightness in the image.

This page is only displayed if **Histogram** or **Both** is selected using the **Display Mode** option in the playback menu (📄 134).

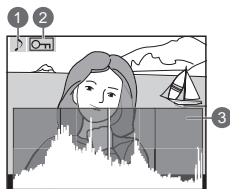

Page 6 (Highlights)

- 1 Voice memo icon .. 180
- 2 Protect status
- 3 Image highlights (brightest areas of image) are marked by a flashing border.

This page is only displayed if **Highlights** or **Both** is selected using the **Display Mode** option in the playback menu (📄 134).



No info









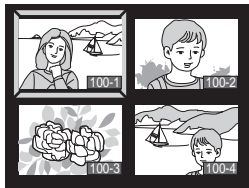



- 1 Voice memo icon .. 180
- 2 Protect status





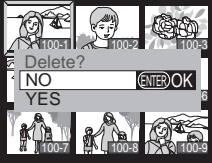





Viewing Multiple Images: Thumbnail Playback

By pressing the  button and rotating the command dial, you can display images in “contact sheets” of four or nine images. The following operations can be performed while thumbnails are displayed:



To	Press and/or rotate	Description
Change number of images displayed	 + 	Pressing the  button, rotate the main command dial to change the number of images displayed as follows: single image ↔ four thumbnails ↔ nine thumbnails ↔ single image.
Page through images	 + 	Pressing the  button, rotate the sub-command dial to scroll through images a page at a time.
Highlight images		Press the multi selector up, down, left, or right to highlight thumbnails.
Delete highlighted photo		A confirmation dialog will be displayed. Press multi selector up or down to highlight option, press  to select: <div data-bbox="464 873 718 1055" style="border: 1px solid black; padding: 5px; margin: 10px 0;">  </div> <ul style="list-style-type: none"> • Select NO to exit without deleting photo • Select YES to delete photo
Zoom highlighted photo in		Press  for an enlarged view of the photo currently highlighted in the monitor ( 118).

To	Press and/or rotate	Description
Change protected status of highlighted photo		Images marked by a  icon can not be deleted using the  button or the Delete option in the playback menu (note that protected images <i>will</i> be deleted when the memory card is formatted). To protect an image, or to remove protection from a protected image, press the  .
Display menus		Press the  button to display camera menus ( 122).
Return to shooting mode	Shutter release/ 	To end playback and return to shooting mode, press the  button or press the shutter-release button halfway.

Using the Multi Selector

The multi selector can be used at any time when the monitor is on. The focus selector lock switch only takes effect when the monitor is off.

1—Image Review (147)

When **ON** is selected for **Image Review** (Custom Setting 1), photographs are automatically displayed in the monitor as they are being recorded to the memory card. In single-frame and self-timer modes, photographs are displayed one at a time as they are taken. In continuous shooting mode, display begins from the first photograph in the current series when shooting ends, and thumbnail playback can be used. Playback will be interrupted when the shutter-release button is pressed, and resume when the button is released after shooting.













6—Monitor Off (151)

The monitor will turn off automatically to save power if no operations are performed for the time specified in Custom Setting 6 (**Monitor Off**). Press the  button again to return to playback mode.

Taking a Closer Look: Playback Zoom

Press the **ENTER** button to zoom in on the image displayed in single-image playback or on the image currently selected in thumbnail playback. The following operations can be performed while zoom is in effect:



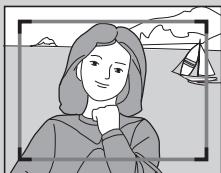

To	Press	Description
Cancel/resume zoom	 	Press ENTER to cancel zoom and return to single-image or thumbnail playback. Press again to zoom image in.
Change zoom ratio	 + 	Pressing the  button, rotate the main command dial to the right to zoom in on the image. Press the  button and rotate the command dial to the left to zoom out.
Zoom in on a different area of image	 + 	Pressing the  button, rotate the sub-command dial. The photo will be displayed with a frame showing the area that is currently zoomed in. Use the multi selector to move the frame to another location, or press the  button and rotate the main command dial to change the size of the area selected. Press the  button and rotate the sub-command dial to magnify the selected area to fill the monitor.
View other areas of the image		Use the multi selector to view areas of the image not visible in the monitor. Hold the multi selector down to scroll rapidly to other areas of the frame.





Using the Multi Selector

The multi selector can be used at any time when the monitor is on. The focus selector lock switch only takes effect when the monitor is off.

Protecting Photographs from Deletion

In full-frame and thumbnail playback, the  button can be used to protect photographs from accidental deletion. Protected files can not be deleted using the  button or the **Delete** option in the playback menu, and have DOS “read-only” status when viewed on a Windows computer. Note that protected images *will* be deleted when the memory card is formatted.

To protect a photograph:

- 1 Display the image in full-frame playback or highlight it in the thumbnail list.
- 2 Press the  button. The photograph will be marked with a  icon.





To remove protection from the photograph so that it can be deleted, display the photograph in full-frame playback or highlight it in the thumbnail list and then press the  button.

Deleting Individual Photographs

To delete a photograph displayed in single-image playback, or the photograph highlighted in thumbnail playback, press the  button. Once deleted, photographs can not be recovered.

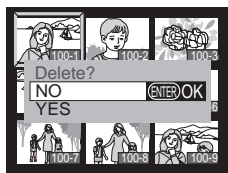
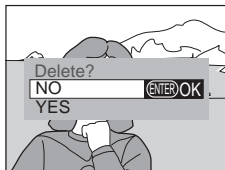
- 1 Display the image in full-frame playback or highlight it in the thumbnail list.
- 2 Press the  button. A confirmation dialog will be displayed.



- 3 To delete the photograph, press the multi selector up or down to highlight **YES** and then press the  button. To exit without deleting the image, press the multi selector to the left or highlight **NO** and press the  button.



Protected and Hidden Images

Images marked with a  icon are protected and can not be deleted. Hidden images are not displayed in single-image or thumbnail playback and can not be selected for deletion.



Delete 124

To delete multiple images, use the **Delete** option in the playback menu.

Menu Guide

Index to Menu Options

Changes to a variety of camera settings are made with the help of menus that appear in the camera monitor. This chapter covers:

Using Camera Menus

This section describes basic menu operations.

The Playback Menu

The playback menu contains options for managing the images stored on memory cards, and for playing pictures back in automated slide shows.

The Shooting Menu

The shooting menu contains advanced shooting options, such as image sharpening and tone compensation.

Custom Settings

The CSM (Custom Settings) menu controls fine details of camera operation.

The Setup Menu

This menu is used for basic camera setup operations, including formatting memory cards and setting the time and date.

Using Camera Menus



122–123



The Playback Menu



124–134



The Shooting Menu



135–143



Custom Settings



144–160



The Setup Menu



161–166



Viewing Camera Menus

Camera menu can be activated by pressing the **MENU** button at any time when the camera is on.

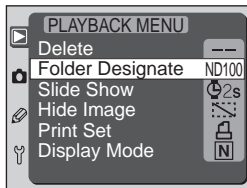

Choosing a menu

When you exit the menus, the camera “remembers” the last menu displayed. This menu is displayed the next time you press the **MENU** button. To change menus:

1



If menu option is highlighted, press **MENU** button

2



Select menu

3



Position cursor in selected menu

Using the Multi Selector

The multi selector can be used at any time when the monitor is on. The focus selector lock switch only takes effect when the monitor is off.

Making a Selection

To modify settings for an item in the current menu:

- 

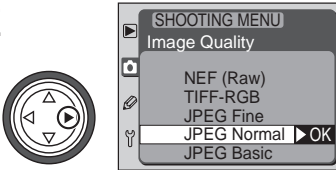
Highlight menu item
- 

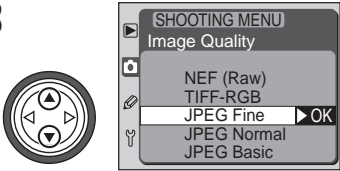
Display options
- 

Highlight option
- 

Make selection and return to main menu

- Some menu items are not available when images are being recorded to the memory card or when the function dial is set to **QUAL**, **WB**, or **ISO**.
- To return to the previous menu without making a selection, press the multi selector to the left.
- The **ENTER** button performs the same function as pressing the multi selector to the right. In some cases, a selection can only be made using the **ENTER** button.
- The selection for some options is made from a sub-menu. Repeat steps 3 and 4 to make a selection from a sub-menu.

Exiting the Menus

To exit the menus, press the **MENU** button (if a menu option is highlighted, press the **MENU** button twice). You can also exit the menus by pressing the **OFF** button to turn the monitor off or by turning the camera off. To exit the menus and focus the camera for the next shot, press the shutter-release button half-way.

The playback menu contains the following options:



Option	
Delete	124–125
Folder Designate	126–127
Slide Show	128–129
Hide Image	130
Print Set	131–133
Display Mode	134

Deleting Photographs: *Delete*

The **Delete** menu contains the following options:

Option	Description
Selected	Delete selected photographs.
All	Delete all photographs.

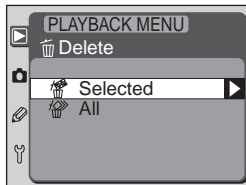

Deleting Selected Photographs: *Selected*

Choosing **Selected** from the delete menu displays the photographs in the folder or folders selected in the **Folder Designate** menu (126) as small thumbnail images. To choose pictures for deletion:

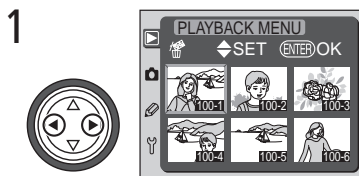

Highlight image

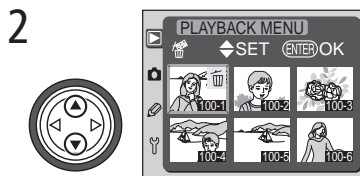

Select highlighted image for deletion. Selected images are marked by icon. Repeat steps 1–2 to select additional images for deletion. To deselect image, highlight and press multi-selector up or down. To exit without deleting images, press MENU button.

3

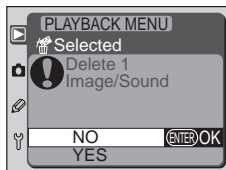

Confirmation dialog displayed. Press multi selector up or down to highlight option, press **ENTER** button to select.

- Select **NO** or press **MENU** button to exit without deleting images
- Select **YES** to delete selected images (and associated voice memos, if applicable) and return to playback menu

Deleting All Photographs: All

Selecting **All** from the delete menu displays the confirmation dialog shown at right. Select the desired option with the multi selector.

- Select **NO** or press the **MENU** button to exit without deleting images.
- Select **YES** to delete all images in the folder or folders selected in the **Folder Designate** menu (126) that are neither hidden nor protected, together with any associated voice memos.

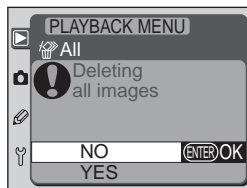

High-Capacity Memory Cards

If the memory card contains a large number of files or folders and the number of pictures to be deleted is very large, deletion can sometimes take more than half an hour.

Hidden and Protected Images

Images marked with a  icon are protected and can not be selected for deletion. Images hidden with **Hide Image** (130) are not displayed in the **Delete > Selected** menu and can only be deleted by formatting the memory card.

Using the Multi Selector

The multi selector can be used at any time when the monitor is on. The focus selector lock switch only takes effect when the monitor is off.

Folder Options: *Folder Designate*

The camera stores photographs in folders named *nnnND100*, where “*nnn*” is a three-digit folder number. By default, photographs in all folders created with the D100 are visible during playback, while images in folders created by other cameras will not be played back. The **Folder Designate** menu is used to create new folders with a user-specified folder number and to select the folders from which images will be played back. The following options are available:



Option	Description
New	Select this item to create a new folder with a user-specified folder number. The dialog at right will be displayed; press the multi-selector up or down to choose a folder number (only numbers higher than the number of the last folder created can be selected), then press to the right to create the new folder and return to the Folder Designate menu. Subsequent photographs will be stored in the new folder.
Folder Select	Select this item to choose the folder or folders from which images will be played back (see opposite).



To exit the **Folder Designate** menu and return to the playback menu, press the **MENU** button.

Creating a Folder at Startup

If the  button is pressed when the camera is turned on, a new folder will be created if no empty folders are present on the memory card. Note that if the most recent folder is numbered 999, attempting to create a new folder at start up will cause an error, and the letters **ERR** will flash in the control panel.

Choosing a Folder for Playback: *Folder Select*

The **Folder Designate** option is used to select folders for playback (it can not be used to select the folder to which pictures will be recorded). Choosing **Folder Select** from the **Folder Designate** menu displays the menu shown at right. Highlight the desired option and press the multi-selector to the right to make your selection and return to the **Folder Designate** menu.

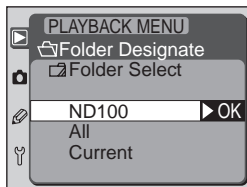

Option	Description
ND100	Images in all folders created by the D100 will be visible during playback.
All	Images in all folders created by cameras that conform to the Design Rule for Camera File Systems (DCF)—all Nikon digital cameras and most other makes of digital camera—will be visible during playback.
Current	Only images in the current folder will be visible during playback.

"Current"

Folders created before the current folder can not be selected for playback individually. If, for example, you create the three folders 101ND100, 102ND100, and 103ND100 using the **Folder Designate > New** option and then select **Current** in the **Folder Select** sub-menu, only photographs in the most recent folder, 103ND100, will be played back. To view photographs in other folders, select **ND100** or **All**.

Number of Folders





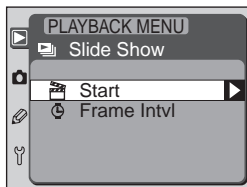

A search is performed to detect existing folders when the camera is turned on. If the memory card contains a very large number of folders, the additional time required to complete this search will delay the start of shooting or playback.

Automated Playback: Slide Show
Use this option to play images back one after the other in an automated "slide show."



Starting the Slide Show: Start

To start the slide show, select **Start** from the slide-show menu. All photos in the folder or folders selected in the **Folder Designate** menu (📁 126) will be displayed in the order recorded, with a pause between each image. Photographs hidden using **Hide Image** (🔒 130) will not be played back. The following operations can be performed while the show is in progress:

To	Press	Description
Return to previous frame		Press multi selector up to return to previous frame.
Skip to next frame		Press multi selector down to skip to next frame.
View photo info		Press multi selector left or right to change photo information displayed during slide show.
Pause slide show		Press ENTER button to pause slide show.
Exit and display playback menu		Press MENU button to end slide show and return to playback menu.
Exit to playback mode		Press  button to end slide show and return to playback mode with current image displayed in monitor.
Exit to shooting mode	Shutter release	Press shutter-release button halfway to end slide show, turn monitor off, and return to shooting mode.

When the last image in the current folder has been displayed, or the **ENTER** button is pressed to pause playback, the menu at right will be displayed. Press the multi selector up or down to highlight the desired option and then press the multi selector to the right.

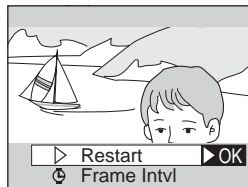

Option	Description
Restart	Resume slide show.
Frame Intvl	Change length of time each image is displayed.

To exit the slide show and return to the playback menu, press the **MENU** button or press the multi selector to the left.

Changing the Display Interval: *Frame Intvl*

Selecting **Frame Intvl** from the **Slide Show** menu or the pause menu shown above will display the menu shown at right. To change the length of time each image is displayed, press the multi selector up or down to highlight the appropriate option and then press the multi selector to the right to return to the slide-show menu.

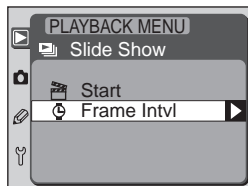

Hiding Images During Playback: *Hide Image*

When creating a slide show or showing photos to an audience, you may want to use the **Hide Image** option to hide selected images. Hidden images are visible only in the **Hide Image** menu. They can not be deleted using the  button or the **Delete** option in the playback menu, and have “hidden” and “read-only” status when viewed on a Windows computer. Like protected images, hidden images *will* be deleted when the memory card is formatted.

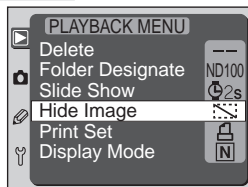

Choosing **Hide Image** from the playback menu displays the photographs in the folder or folders selected in the **Folder Designate** menu ( 126) as small thumbnail images. To select the images that will be hidden:

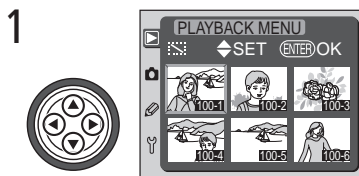

Highlight image

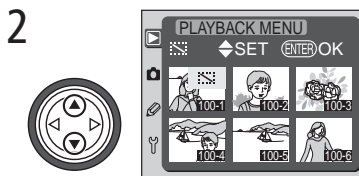

Select image. Hidden images are marked by  icon. Repeat steps 1–2 to select more images. To deselect image, highlight and press multi selector up or down. To exit without changing status of images, press MENU button.

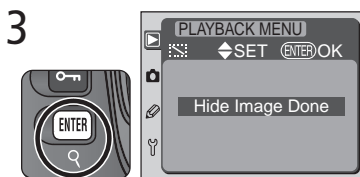

Press **ENTER** button to complete operation and return to playback menu.

Frame Numbering and Hidden Images

Although hidden images are visible only in the **Hide Image** menu, their presence can be ascertained from discontinuities in the frame number sequence during playback.

Ordering Prints: *Print Set*

The **Print Set** option is used to create a digital “print order” that specifies the photographs to be printed, the number of prints, and the information to be included on each print. This information is stored on the memory card in **Digital Print Order Format (DPOF)**. Once a print order has been created, the memory card can be removed from the camera and inserted in a DPOF-compatible device—be it a personal photo printer or a photofinisher’s print system—and images printed directly from the card.

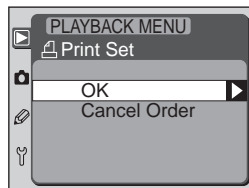

Option	Description
OK	Select photographs for printing.
Cancel Order	Cancel print order.

Taking Pictures for Direct Printing

When taking images to be printed without modification, set the **Color Mode** option in the shooting menu to **I (sRGB)** or **III (sRGB)** (60, 142).

DPOF

DPOF is an industry-wide standard that allows pictures to be printed from print orders stored on the memory card. Before printing the images, check that the printer or print service supports DPOF. Even without access to a DPOF-compatible device, you can still print images using Nikon View 5 if your computer is connected to a color printer. If your photofinisher does not offer support for DPOF, they may accept photographs for printing by e-mail, upload to a web site, or on removable media such as Zip disks. Contact your photofinisher for information on delivery and the file formats accepted.

Exif version 2.2

The D100 supports Exif (Exchangeable Image File Format for Digital Still Cameras) version 2.2, a standard that allows information stored with photographs to be used for optimal color reproduction when images are output on Exif-compliant printers.

Modifying the Print Order: OK

To order prints or modify the current print order, select **OK** in the print set menu. Photographs in the folder or folders selected in the **Folder Designate** menu (📁 126) will be displayed as small thumbnail images. Images hidden using **Hide Image** (🔒 130) will not be displayed. To modify the print order:

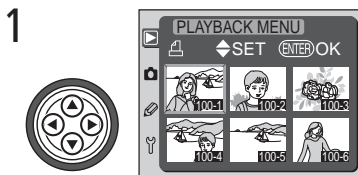

Highlight image

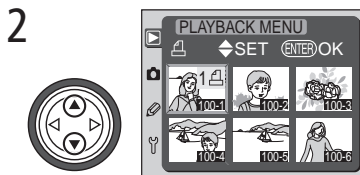

Select image and set number of prints to 1. Selected images are marked by 1 🖨️ icon. Press multi selector up to increase number of prints, down to decrease. To deselect image, press multi selector down when number of prints is 1. Repeat Steps 1–2 to select additional images. To exit without altering print order, press MENU button.

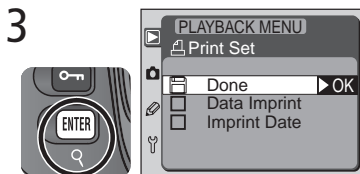

Press **ENTER** button to complete operation and display menu of print options.

- To print shutter speed and aperture on all images in order, highlight **Data Imprint** and press multi selector to right. Check will appear in box next to item.
- To print the date of recording all images in the print order, highlight **Imprint Date** and press multi selector to right. Check will appear in box next to item.
- To deselect checked item, highlight and press multi selector to right.
- Highlight **Done** and press multi selector to right to save modified print order and return to playback menu. To return to playback menu without modifying print order, press MENU button.

Canceling the Print Order: *Cancel Order*

To cancel the print order so that no images are selected for printing, select **Cancel Order** in the print set menu.

NEF Images

Photographs taken at an image quality of **NEF (Raw)** or **Comp. NEF (Raw)** (📷 44) can not be selected in the **Print Set** menu and can not be printed using this option. NEF images can be printed directly from Nikon Capture 3 (📷 170) or saved in another format and printed from a third-party imaging application.

After Creating a Print Order

After creating a print order, do not delete images from the memory card using another device, such as a computer, or change the hidden status of images in the print order. Either action could cause problems when you attempt to print the images in the order.

Controlling Photo Info: *Display Mode*

The option selected in the **Display Mode** option determines whether a histogram and/or highlights are included in the photo-information display (114).

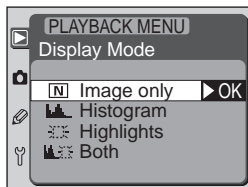

The following options are available.

Option	Description
Image Only	Histogram and highlights are not included in photo-information display.
Histogram	A histogram page is added to the photo-information display showing the distribution of tones in the image.
Highlights	A page is added to the photo-information display showing image highlights. Highlights (brighter areas of the image) are indicated by a flashing border.
Both	Two pages are added to the photo-information display, one showing a histogram and the other highlights.



Bank Select

If a bank in which ISO has been set to **H 1 - 1** or **H 1 - 2** is chosen after **ON** is selected for Custom Setting 3 (**ISO Auto**; 148), sensitivity (ISO equivalency) will **NOT** be adjusted automatically.



Using the Multi Selector

The multi selector can be used at any time when the monitor is on. The focus selector lock switch only takes effect when the monitor is off.

The shooting menu contains two pages of options:



Option	Eye Icon
Bank Select	135
Image Quality	136
Resolution	137
White Bal	138
ISO	139
Image Sharpening	140
Tone Comp.	141
Color Mode	142
Hue Adjustment	143

To display the second page of options, highlight **ISO** and press the multi selector down, or highlight **Bank Select** and press the multi selector up. To return to the first page, highlight **ISO** and press the multi selector up, or highlight **Hue Adjustment** and press the multi selector down.

Choosing a Settings Bank: *Bank Select*

Shooting menu settings are stored in one of two “banks,” Bank A or Bank B. Changes to settings in one bank have no effect on the other. If there is a particular combination of settings you use frequently, you can select Bank A and set the camera to these settings. The camera will “remember” these settings even when turned off, and restore them the next time Bank A is selected. You can create another combination of settings using Bank B and switch instantly from one combination to the other by selecting the appropriate bank from the **Bank Select** menu.

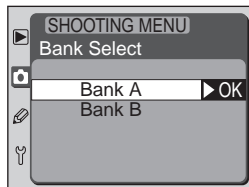

Any changes to settings in the shooting menu are automatically stored in the bank currently selected in the **Bank Select** menu. The default bank is Bank A.

File Type and Compression: *Image Quality*

The **Image Quality** menu controls the file type and compression ratio used as photographs are saved to the memory card. The following options are available:

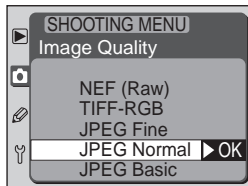

Option	Description
NEF (Raw)	<p>Raw 12-bit data from the CCD are saved directly to the memory card in Nikon Electronic Image Format (NEF). NEF files can only be viewed in Nikon View 5 or Nikon Capture 3 (📷 169). Two NEF modes are available:</p> <ul style="list-style-type: none"> • NEF (Raw) In this mode, NEF images are not compressed, reducing the time needed to process images before they are saved to the memory card but increasing file size. • Comp. NEF (Raw) In this mode, NEF images are compressed using a virtually “loss-less” algorithm that reduces file size by approximately fifty to sixty percent without affecting image quality. More time is required to process images before they are saved to the memory card (📷 43).
TIFF-RGB	Images are saved in uncompressed TIFF RGB at a color depth of eight bits per channel (24-bit color).
JPEG Fine	Images are saved in JPEG format at a compression ratio of roughly 1 : 4.
JPEG Normal	Images are saved in JPEG format at a compression ratio of roughly 1 : 8.
JPEG Basic	Images are saved in JPEG format at a compression ratio of roughly 1 : 16.

 **For more information on:**

44 Image quality

Choosing an Image Size: *Resolution*

The **Resolution** menu controls the size of photographs, measured in pixels. Smaller sizes produce smaller files, making them suited to distribution via e-mail or inclusion in web pages. Conversely, the larger the image, the larger the size at which it can be printed without becoming noticeably “grainy.” Choose image size according to the space available on the memory card and the task at hand.

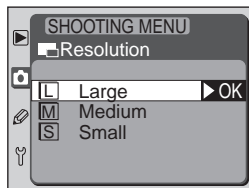

Option	Size (pixels)
Large	3,008 × 2,000
Medium	2,240 × 1,488
Small	1,504 × 1,000

NEF (Raw) and White Balance Bracketing

White balance bracketing can not be used with an image quality of **NEF (Raw)** or **Comp. NEF (Raw)**. Selecting either option cancels white balance bracketing. White balance for NEF (RAW) images can be adjusted using Nikon Capture 3 (available separately;  170).





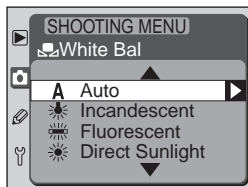

For more information on:

46 Image size

Keeping Colors True: *White Balance*

The White Balance menu allows you to match white balance to the color of the light source. The following options are available:



Option	Approximate Color Temperature*	Description
A Auto	4,200–8,000 K	Camera measures color temperature and adjusts white balance automatically. For best results, use type G or D lens.
 Incandescent	3,000 K	Use under incandescent lighting.
 Fluorescent	4,200 K	Use under fluorescent lighting.
 Direct Sunlight	5,200 K	Use with subjects lit by direct sunlight.
 Flash	5,400 K	Use with Nikon Speedlights, including the built-in Speedlight.
 Cloudy	6,000 K	Use in daylight under overcast skies.
 Shade	8,000 K	Use in daylight with subjects in the shade.
PRE Preset	—	Use to match white balance to the light source when shooting under mixed lighting or lighting with a strong color cast.

 **For more information on:**

50 White balance

Setting Sensitivity: *ISO*

The **ISO** menu controls sensitivity, the digital equivalent of film speed. Options range from **ISO 200** (roughly equivalent to a film speed of ISO 200) to **ISO 1600** (ISO 1600 equivalent) in steps equivalent to $\frac{1}{3}$ EV. Higher values of **HI-1** (approximately equivalent to ISO 3200) and **HI-2** (approximately equivalent to ISO 6400) are also available for situations in which high sensitivity is a priority. **HI-1** and **HI-2** are not available when **ON** is selected for Custom Setting 3 (**ISO Auto**).

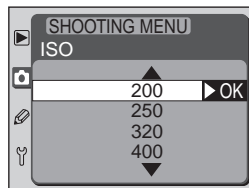

HI-1/HI-2

Photos taken at settings of **HI-1** and **HI-2** will likely contain appreciable amounts of noise. Use only to capture natural lighting under low light conditions or when a fast shutter speed is required to prevent blurring. We recommend that image sharpening ( 140) be turned off at these settings to avoid heightening the effects of noise. Noise can be reduced at shutter speeds of $\frac{1}{2}$ s or slower by selecting **ON** for Custom Setting 4 (**Long Exp. NR**).

For more information on:

48 Sensitivity (ISO equivalency)

Making Edges More Distinct: *Image Sharpening*

When you take a photograph, the camera automatically processes the image to increase the distinction between light and dark areas, making the picture appear sharper. The options in the **Image Sharpening** menu give you control over the amount of sharpening performed.



Option	Description
A Auto (default)	The camera automatically adjusts sharpening according to the subject and how other camera settings are adjusted. Amount of sharpening performed varies from shot to shot. For best results, use a type G or D lens.
Normal	Camera performs same standard level of sharpening on all images.
Low	Sharpening performed, but edges are not sharpened as much as they are in Normal mode.
High	Images processed for increased sharpness.
None	No sharpening performed.

Adjusting Contrast: *Tone Compensation*

As photographs are saved to the memory card, they are processed to adjust the distribution of tones in the image, enhancing contrast. The options in the **Tone Comp.** menu give you control over the type of processing performed.

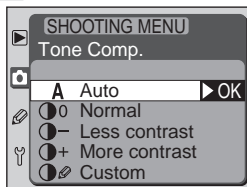

Option	Description
A Auto (default)	Camera automatically optimizes contrast by selecting the appropriate curve. Curve selected varies from image to image. For best results, use a type G or D lens.
0 Normal	Camera uses same standard curve for all images. This option is suited to most types of scene, whether dark or bright.
- Less Contrast	This curve produces “softer” images. If you are shooting a portrait in direct sunlight, this option can be used to prevent bright areas of the image from being “washed out” by glare.
+ More Contrast	Choose this curve to preserve detail when taking shots of misty landscapes and other low-contrast subjects.
Custom	If you have Nikon Capture 3* (N 170), you can define your own tone curve and download it to the camera. Custom is used to select this user-defined curve. If no curve has been downloaded to the camera, this option is equivalent to Normal .

* This feature is not available when the D100 is used with the Macintosh version of Nikon Capture 3.

Auto

Even when shooting the same type scene, the curve chosen by the camera in **A (Auto)** mode may vary with the position of your subject or the amount of the frame it occupies. To shoot several shots with the same tone compensation, choose one of the other tone curves.

Setting Colors Based on Workflow: Color Mode

Your Nikon digital camera offers a choice of color modes. How you choose a color mode depends on how the final photograph will be processed once it leaves the camera.

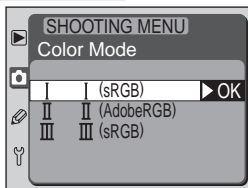

Option	Description
I I (sRGB) (default)	Choose for portrait shots that will be printed or used “as is,” with no further modification. Photographs are adapted to the sRGB color space.
II II (Adobe RGB)	Photographs taken at this setting are adapted to the Adobe RGB color space. This color space is capable of expressing a wider gamut of colors than sRGB, making it the preferred choice for studio photography or images that will be modified as part of a commercial production work flow.
III III (sRGB)	Choose for nature or landscape shots that will be printed or used “as is,” with no further modification. Photographs are adapted to the sRGB color space.

Color Management

When opening images in an application that supports color management, select a profile that matches the color mode in effect when the photograph was taken. If the image is converted to a different color space, colors may not be reproduced accurately. If the image is converted to a color space with that supports a narrower gamut of colors, you may notice tonal discontinuities (colors changing abruptly instead of progressing gradually from one tone to the next).

When photographs created with the D100 are opened in Nikon View 5 or Nikon Capture 3, the appropriate color space will be selected automatically.

Controlling Color: *Hue Adjustment*

This option is used to adjust the hue of photographs as they are taken. Hue can be adjusted in the range -9° to 9° in increments of 3° . If red is taken as the starting color, raising hue above 0° (the default setting) would introduce a yellow cast, making colors that would be red at a setting of 0° appear increasingly orange. Lowering hue below 0° would introduce a blue cast, making colors that would be red at a setting of 0° appear increasingly purple.

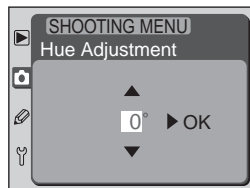

Hue

The RGB color model used in digital photographs reproduces colors using differing amounts of red, green, and blue light. By mixing two colors of light, a variety of different colors can be produced. For example, red combined with a small amount of green light produces orange. If red and green are mixed in equal amounts, yellow results, while a smaller amount of red produces a yellow green. Mixing different amounts of red and blue light produces colors ranging from a reddish purple through purple to navy, while mixing different amounts of green and blue light produces colors ranging from emerald to turquoise. (Adding a third color of light results in lighter hues; if all three mixed in equal amounts, the results range from white through gray.) When this progression of hues is arranged in a circle, the result is known as a color wheel.

Custom Settings

Fine-Tuning Camera Settings

Custom settings are used to fine-tune a variety of camera settings to suit your personal preferences, creating combinations of settings that differ from the factory defaults in effect at the time your camera was purchased. The CSM (Custom Settings) menu contains six pages of options. To scroll between pages, press the multi selector up or down until the next page is displayed. The first and last pages are linked.

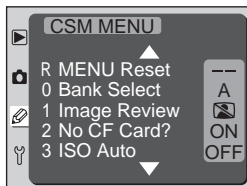

	Option	
R	MENU Reset	Reset CSM Menu 145
0	Bank Select	Custom Setting Bank 146
1	Image Review	Image Review 147
2	No CF Card?	Disable Shutter if no CF Card 147
3	ISO Auto	ISO Auto Control 148
4	Long Exp. NR	Long Exposure Noise Reduction 149
5	File No. Seq.	File Number Sequence 150
6	Monitor Off	Monitor Off Delay 151
7	Auto Meter-Off	Auto Meter-Off Delay 151
8	Self-timer	Self-timer Delay 151
9	EV Step	EV Steps for Exposure Control 151
10	Exposure Comp.	Easy Exposure Compensation 152
11	BKT Set	Bracketing Set 153
12	BKT Order	Bracketing Order 153
13	Command Dial	Assign Command Dial 154
14	AE-L/AF-L	Assignment of AE-L/AF-L Button 154
15	AE Lock	AE Lock Button 155
16	Illumination	LCD Illumination 155
17	Focus Area	Focus Area Select 156
18	AF Area Illum	Focus Area Illumination 156
19	Grid Display	Grid lines display in Viewfinder 157
20	Dyn. AF AF-S	Dynamic AF, Single-Servo 157
21	Dyn. AF AF-C	Dynamic AF, Continuous-Servo 157
22	AF Assist	AF Assist Illuminator 158
23	Flash Mode	Built-in Flash Mode 158
24	Anti-shock	Anti-mirror-shock mode 159
25*	Batt PK AF Btn	Assign Battery Pack AF-ON Button 160
26*	Batt PK Volume	Adjust Playback Volume 160

* Available only when MB-D100 multi-function battery pack (available separately; ) is in place.

Custom Setting R: *Menu Reset*

MENU Reset is used to restore custom settings to their default values. To exit without changing settings, press the **MENU** button or highlight **OFF** and press the multi selector to the right. To restore custom settings to the default values shown below, highlight **ON** and press the multi selector to the right. Only the settings in the bank currently selected in the **Bank Select** menu (see opposite) will be reset; settings in the other bank are unaffected.

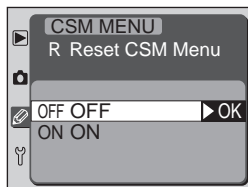

Option	Default
1 Image Review	OFF
2 No CF Card?	ON
3 ISO Auto	OFF
4 Long Exp. NR	OFF
5 File No. Seq.	OFF
6 Monitor Off	20 s
7 Auto Meter-Off	6 s
8 Self-timer	10 s
9 EV Step	1/3 Step
10 Exposure Comp.	[+/-] & CMD Dial
11 BKT Set	AE & Flash
12 BKT Order	MTR > Under > Over
13 Command Dial	Main=S, Sub=A

Option	Default
14 AE-L/AF-L	AE/AF Lock
15 AE Lock	AE-L/AF-L Button
16 Illumination	Lamp On Switch
17 Focus Area	No Wrap
18 AF Area Illum	Auto
19 Grid Display	OFF
20 Dyn. AF AF-S	Select AF Area
21 Dyn. AF AF-C	Select AF Area
22 AF Assist	ON
23 Flash Mode	D-TTL auto flash
24 Anti-shock	OFF
25 Batt PK AF Btn	AF-ON
26 Batt PK Volume	3

Two-Button Reset

Custom settings are not reset when a two-button reset is performed (🔑 110).

Custom Setting 0: Bank Select

Custom settings are stored in one of two “banks,” Bank A or Bank B, which are independent of the banks used to store shooting menu settings. Changes to settings in one bank have no effect on the other. If there is a particular combination of settings you use frequently, you can select Bank A and set the camera to these settings. The camera will “remember” these settings even when turned off, and restore them the next time Bank A is selected. You can create another combination of settings using Bank B and switch instantly from one combination to the other by selecting the appropriate bank from the **Bank Select** menu.

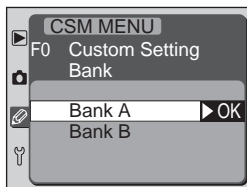

Any changes to settings in the custom settings menu are automatically stored in the bank currently selected in the **Bank Select** menu. The default bank is Bank A.

Bank Select

If a bank in which **ON** is selected for Custom Setting 3 (**ISO Auto**;  148) is chosen after ISO has been set to **M 1 - 1** or **M 1 - 2**, sensitivity (ISO equivalency) will not be adjusted automatically.

“CSM”

CSM is displayed in the control panel when settings in the current bank are modified from default values.

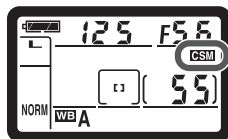

Using the Multi Selector

The multi selector can be used at any time when the monitor is on. The focus selector lock switch only takes effect when the monitor is off.

Custom Setting 1: Image Review

The setting chosen for **Image Review** controls whether or not photographs are automatically displayed in the monitor immediately after shooting.

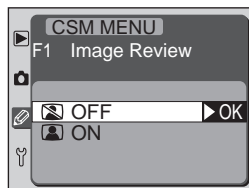

Option	Description
OFF (default)	Photographs are not automatically displayed in the monitor after shooting.
ON	When you remove the finger from the shutter-release button after shooting, the photograph or photographs you have taken will be displayed automatically in the monitor (🔑 112).

Custom Setting 2: No CF Card?

This option can be used to enable the shutter release when no memory card is inserted in the camera. Note that when photographs are being captured to a computer using Nikon Capture 3 Camera Control, photographs are not recorded to the camera memory card and the shutter release will be enabled regardless of the setting chosen for this option.

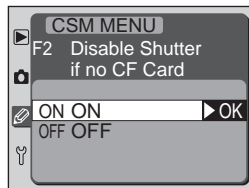

Option	Description
ON (default)	Shutter-release button locks when no memory card is inserted in the camera.
OFF	Shutter-release button is enabled even when no memory card is inserted in the camera.

Custom Setting 3: ISO Auto

If **ON** is selected for this option, the camera will automatically adjust sensitivity (ISO equivalency) when optimal exposure can not be achieved at current exposure settings. If sensitivity is set to **HI-1** (approximately equivalent to ISO 3200) or **HI-2** (approximately equivalent to ISO 6400), this option is automatically set to **OFF** and can not be adjusted.

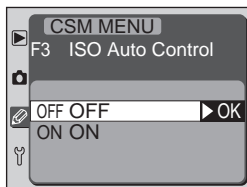

Option	Description
OFF (default)	Sensitivity remains fixed at value selected by user, regardless of whether optimal exposure can be achieved at current exposure settings.
ON	When optimal exposure can not be achieved at the sensitivity selected by the user, sensitivity is adjusted to compensate, to a minimum approximately equivalent to ISO 200 and a maximum approximately equivalent to ISO 1600 (76). Sensitivity can not be set to HI-1 or HI-2 while this option is in effect.

Bank Select

If a shooting menu bank in which ISO has been set to **HI-1** or **HI-2** is chosen after **ON** is selected for Custom Setting 3 (**ISO Auto**), sensitivity (ISO equivalency) will not be adjusted automatically. Sensitivity will also not be adjusted automatically if a Custom Settings bank in which **ON** is selected for Custom Setting 3 (**ISO Auto**) is chosen after ISO has been set to **HI-1** or **HI-2**.

ISO Auto

If a Speedlight is used when **ISO Auto** is on, sensitivity (ISO equivalency) will be fixed at the value selected by the user.

Noise

Noise is more likely to appear in photographs taken at higher sensitivities.

Custom Setting 4: Long Exp. NR

At shutter speeds slower than about $\frac{1}{2}$ s, “noise” in the form of randomly-spaced, brightly-colored pixels may appear in photographs, particularly in shadows. Custom Setting 4 can be used to reduce noise at slow shutter speeds.

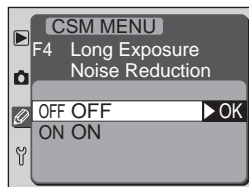

Option	Description
OFF (default)	Noise reduction off; camera functions normally.
ON	Noise reduction takes effect at shutter speeds of about $\frac{1}{2}$ s or slower. Time required to process images more than doubles. During processing, <i>Job nr</i> blinks in shutter-speed and aperture displays. Next photo can be taken when <i>Job nr</i> is no longer displayed.

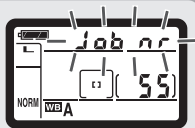

Playback

If photographs are played back while they are being processed to reduce noise, the image that is displayed in the monitor may not show the effects of noise reduction.

The Memory Buffer

When noise reduction is on, the memory buffer ( 42) can store a maximum of three images (two in RAW mode).

Custom Setting 5: File No. Seq.

To ensure that the images in each folder have unique names, the camera assigns each image a file name containing a four digit number, starting from 0001, and adds one to the file number with each shot. Custom Setting 5 controls whether the camera “remembers” the current file number when a new memory card is inserted or the user creates a new folder.

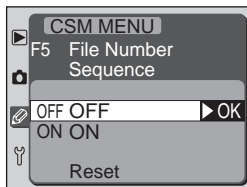

Option	Description
OFF (default)	File numbering starts over from 0001 when the user creates a new folder (126). If a new memory card is inserted, a new folder numbered 100 will be created with the first photograph taken and file numbering will begin from 0001. Until a new memory card is inserted or the user creates a new folder, file and folder numbering will continue from the last numbers used.
ON	When the user creates a new folder (126), file numbering will continue from the last number used. When a new memory card is inserted, both file and folder numbering will continue from the last numbers used.
Reset	The current file and folder numbers are cleared from memory. A new folder will be created with the next photograph taken and file numbering will begin again from 0001.

File Numbering

If a photograph is taken when the current folder contains 999 photographs or a photograph numbered 9999, a new folder will be created automatically by adding one to the current folder number and file numbering will begin again from 0001, regardless of the option chosen for Custom Setting 5.

The EH-5 AC Adapter

When the camera is powered by an optional EH-5 AC adapter, the monitor will power off automatically after ten minutes, regardless of the setting chosen for Custom Setting 6 (**Monitor Off**). The camera exposure meter will not turn off while the AC adapter is connected, regardless of the setting chosen for Custom Setting 7 (**Auto Meter-Off**).

Custom Setting 6: Monitor Off

This option controls whether the monitor stays on for ten seconds (**10 s**), twenty seconds (**20 s**), one minute (**1 min.**), five minutes (**5 min.**), or ten minutes (**10 min.**) when no operations are performed. The default setting is **20 s**. Note that the longer the monitor remains on, the more often you will need to recharge the battery.

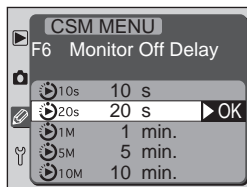

Custom Setting 7: Auto Meter-Off

This option controls how long the camera continues to meter exposure when no operations are performed. The exposure meter can be set to turn off automatically after approximately four seconds (**4 s**), six seconds (**6 s**), eight seconds (**8 s**), sixteen seconds (**16 s**), or thirty minutes (**30 min.**). The default setting is **6 s**. Choose a shorter meter off delay for longer battery life.

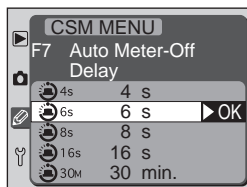

Custom Setting 8: Self-Timer

This option controls length of the delay from the time the shutter release button is pressed to the time the shutter is released in self-timer mode (108). Shutter release can be delayed by approximately two (**2 s**), five (**5 s**), ten (**10 s**), or twenty seconds (**20 s**). The default setting is **10 s**.

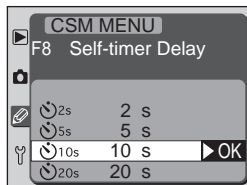

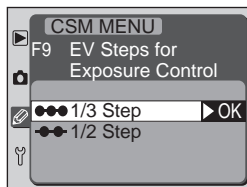

Custom Setting 9: EV Step

Adjustments to exposure settings (shutter speed, aperture, exposure compensation, flash compensation, and exposure and flash bracketing) can be made in increments equivalent to $\frac{1}{3}$ EV (**1/3 Step**) or $\frac{1}{2}$ EV (**1/2 Step**). The default setting is **1/3 Step**. Any changes to this setting are reflected in the exposure displays in the viewfinder and control panel.



Custom Setting 10: *Exposure Comp.*

This option controls whether the  button is needed to set exposure compensation ( 86).

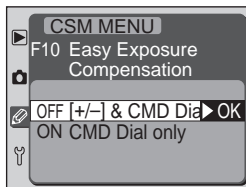

Option	Description		
[+/-] & CMD Dial (default)	Exposure compensation is set by rotating the main command dial while pressing the  button.		
CMD Dial only	Exposure compensation is set using one of the command dials. Which dial is used depends on the exposure mode and the option chosen for Custom Setting 13.		
	Custom Setting 13		
		Main=S, Sub=A	
		Main=A, Sub=S	
	Exposure mode		
	P	Sub-command dial	Sub-command dial
	S	Sub-command dial	Main command dial
	A	Main command dial	Sub-command dial

Custom Setting 11: *BKT Set*

This option controls what settings are affected when bracketing (87) is in effect.

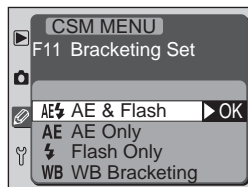

Option	Description
AE & Flash (default)	Both exposure and flash level are bracketed.
AE Only	Only exposure is bracketed.
Flash Only	Only flash level is bracketed.
WB Bracketing	White balance is bracketed.

Custom Setting 12: *BKT Order*

This option controls the order in which bracketing (87) is performed.

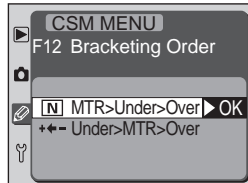

Option	Description
MTR>Under>Over (default)	Bracketing is performed in the order described in "Bracketing" (87).
Under>MTR>Over	Bracketing proceeds from negative through positive values.

NEF (Raw) and White Balance Bracketing

White balance bracketing will not take effect at image qualities of **NEF (Raw)** or **Comp. NEF (Raw)**, even if **WB Bracketing** is selected in for Custom Setting 11 (**BKT Set**).

Custom Setting 13: *Command Dial*

By default, the main command dial controls shutter speed (shutter-priority auto and manual exposure modes), the sub-command dial aperture (aperture-priority auto and manual exposure modes). These functions can be reversed using Custom Setting 13. The setting selected also applies to the optional MB-D100 multi-function battery pack.

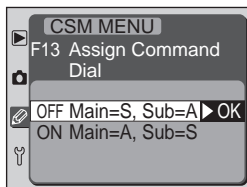

Option	Description
Main=S, Sub=A (default)	Main command dial controls shutter speed, sub-command dial aperture.
Main=A, Sub=S	Main command dial controls aperture, sub-command dial shutter speed.

Custom Setting 14: *AE-L/AF-L*

This option controls the behavior of the AE-L/AF-L button.

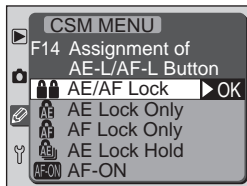

Option	Description
AE/AF Lock (default)	Both focus and exposure are locked while the AE-L/AF-L button is pressed.
AE Lock only	Exposure is locked while the AE-L/AF-L button is pressed. Focus is unaffected.
AF Lock only	Focus is locked while the AE-L/AF-L button is pressed. Exposure is unaffected.
AE Lock hold	Pressing the AE-L/AF-L button locks exposure. Exposure remains locked until the button is pressed again.
AF-ON	The camera focuses when the AE-L/AF-L button is pressed. While this setting is in effect, the camera will not focus when the shutter-release button is pressed halfway.

Custom Setting 15: *AE Lock*

This option controls whether exposure will lock while the shutter-release button is pressed halfway.

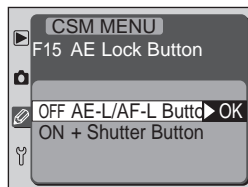

Option	Description
AE-L/AF-L Button (default)	Exposure can only be locked with the AE-L/AF-L button.
+ Shutter Button	Exposure can also be locked by pressing the shutter-release button halfway.

Custom Setting 16: *Illumination*

The control panel backlight (LCD illuminator) lights when the LCD illuminator button is pressed. This option controls whether the LCD illuminator will light when any button is pressed.



Option	Description
Lamp On Switch (default)	Control panel is illuminated only when LCD illuminator button is pressed.
Any Button	The control panel is illuminated when any button is pressed.

 **For more information on:**

Custom Setting 17: Focus Area

By default, the focus-area display is bounded by the four outer focus areas so that, for example, pressing the multi selector up when the top focus area is selected will have no effect. This can be changed so that focus-area selection “wraps around” from top to bottom, bottom to top, right to left, and left to right.



Option	Description
No Wrap (default)	Wrap-around disabled.
Wrap	Wrap-around in effect.

Custom Setting 18: AF Area Illum

This option controls whether or not the active focus area is highlighted in red in the viewfinder.

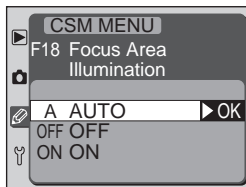

Option	Description
Auto (default)	The selected focus area is automatically highlighted as needed to provide contrast with the background.
OFF	Selected focus area is not highlighted.
ON	Selected focus area is always highlighted, regardless of the brightness of the background. Depending on the brightness of the background, the focus brackets may be difficult to see.

For more information on:

65 Focus area selection

Custom Setting 19: Grid Display (On-Demand Grid Lines)

Using this option, on-demand grid lines (📏 10) can be displayed in the viewfinder for reference when composing photographs, taking landscape shots, or shifting or tilting a PC Nikkor lens. To display the grid, select **ON**. The default setting is **OFF** (no grid displayed).

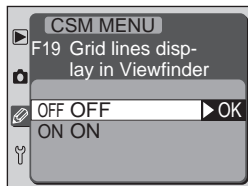
**Custom Setting 20: Dyn. AF AF-S**

This option can be used to enable closest-subject priority when dynamic-area AF is used with single-servo autofocus (👁 63).

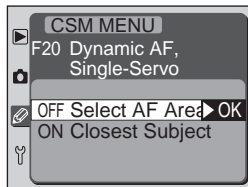

Option	Description
Select AF Area (default)	Closest-subject priority disabled.
Closest Subject	Closest-subject priority enabled.

Custom Setting 21: Dyn. AF AF-C

This option can be used to enable closest-subject priority when dynamic-area AF is used with continuous-servo autofocus (👁 63).

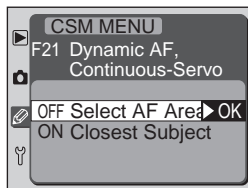

Option	Description
Select AF Area (default)	Closest-subject priority disabled.
Closest Subject	Closest-subject priority enabled.

Custom Setting 22: AF Assist

This option controls whether the AF-assist illuminator lights to help with the autofocus operation when the subject is poorly lit (👁️ 72).

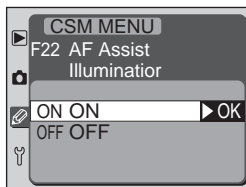

Option	Description
ON (default)	AF-assist illuminator lights automatically when subject is poorly lit.
OFF	AF-assist illuminator off.

Custom Setting 23: Flash Mode

By default, the amount of light produced by the built-in Speedlight is controlled automatically using D-TTL flash control (👁️ 95). Using this option, you can set the built-in Speedlight to fire at full output with every photograph (manual mode).

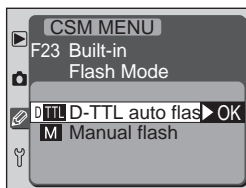

Option	Description
D-TTL auto flash (default)	When built-in Speedlight is raised, flash output is adjusted automatically in response to shooting conditions (👁️ 99). Flash output can be adjusted using flash exposure compensation (👁️ 102).
Manual flash	When built-in Speedlight is raised, flash fires at full output with every shot (GN at ISO 200 18/59, at ISO 100 12.7/42, m/ft). Flash exposure compensation indicators (👁️) in control panel and viewfinder blink on and off. No monitor pre-flash is emitted, allowing the built-in Speedlight to function as a master flash to drive optional slave flash units.

Custom Setting 24: *Anti-shock*

Normally, the mirror is raised out of the way of the CCD immediately before the shutter opens to create an exposure. To minimize camera shake in situations in which the least camera movement can blur photographs (for example, microscope photography), the exposure can be delayed until after the vibrations created by the mirror being raised have had a chance to subside.

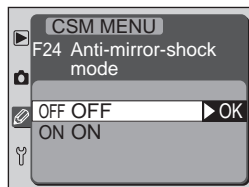

Option	Description
OFF (default)	The shutter is released when the mirror is raised.
ON	Exposure is delayed until after the mirror is raised.

Custom Setting 25: *Batt PK AF Btn*

This option controls the function performed by the **AF-ON** button on the optional MB-D100 multi-function battery pack (🔋 180), and is only available when the MB-D100 is connected. See the instruction manual provided with the battery pack for details.

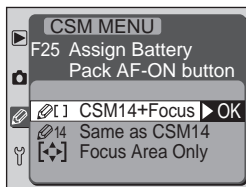

Option	Description
CSM 14 + Focus Area	The AF-ON button performs the same function as the AE-L/AF-L button on the camera body. In addition, the focus area can be selected by pressing the AF-ON button and rotating the sub-command dial on the battery pack.
Same as CSM 14 (default)	When an MB-D100 battery pack is attached, the AF-ON button performs the same function as the AE-L/AF-L button on the camera body, as determined by Custom Setting 14 (🔋 154).
Focus Area Only	When an MB-D100 battery pack is attached, the focus area can be selected by pressing the AF-ON button and rotating the sub-command dial on the battery pack. The battery-pack AF-ON button does not perform the same function as the camera AE-L/AF-L button.

Custom Setting 26: *Batt PK Volume*

The optional MB-D100 multi-function battery pack (🔋 180) is equipped with a microphone, allowing brief voice memos to be added to photographs. Custom Setting 26 (available only when the MB-D100 is connected) controls the level of the battery pack's speaker when these recordings are played back. Settings range from 0 (mute) to 5 (maximum volume) in increments of 1. The default setting is 3.



The setup menu contains the following options:

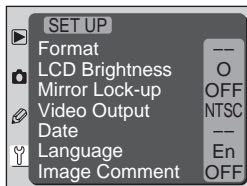

Option	
Format	162
LCD Brightness	163
Mirror Lock-up	163
Video Output	164
Date	19
Language	18
Image Comment	164

Date and Language

The **Date** option is described in “First Steps: Setting the Time and Date” (19). **Language** is described in “First Steps: Choosing a Language” (18).

Using the Multi Selector

The multi selector can be used at any time when the monitor is on. The focus selector lock switch only takes effect when the monitor is off.

Formatting Memory Cards: *Format*

Memory cards must be formatted before first use. Formatting memory cards is also an effective way of deleting all pictures on the card. To format a memory card:

1



Highlight **Format**

(to exit without formatting card, press MENU button or highlight **No** and press multi selector to right)

2

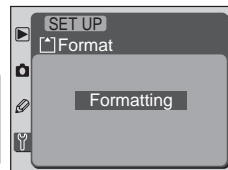

Press **ENTER** button to start formatting. *Formatting begins immediately.* While formatting is in progress, the message shown above will be displayed.

✓ During Formatting

Do not remove the memory card, remove the battery, or unplug the AC adapter (available separately) while formatting is in progress.

✍ Before Formatting

Formatting memory cards permanently deletes all data they contain, including hidden and protected pictures and any other data that may be on the card. Before formatting, be sure to transfer to a computer any pictures you would like to keep.

👉 Two-Button Format

Memory cards can also be formatted using the **FORMAT** (🔑) and (🔑) buttons (🔑 23).

Adjusting Monitor Brightness: *LCD Brightness*

This option controls monitor brightness. Press the multi selector up to increase brightness, down to decrease. The number to the right of the display indicates the current brightness level, with 2 the brightest setting and -2 the darkest. Press the multi selector to the right to put your choice into effect and return to the setup menu.



Readying the CCD for Inspection: *Mirror Lock-up*

This option is used to lock the mirror in the up position so that you can inspect or clean the low-pass filter that protects the CCD. See “Technical Notes: Caring for the Camera and Battery”.

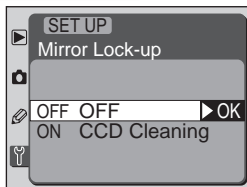

Option	Description
OFF	Mirror functions normally.
CCD Cleaning	Mirror will be locked in up position when shutter is released. To ensure that power is available to lower the mirror when the camera is turned off, this option is only available when the camera is powered by an EH-5 AC adapter (available separately).

Choosing a Video Standard: *Video Output*

This option is used to select the standard for video output. Adjust this setting to match the standard used in any video device to which you connect the camera.

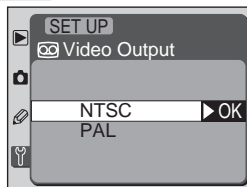

Option	Description
NTSC	Use when connecting the camera to NTSC devices.
PAL	Use when connecting the camera to PAL devices. The number of pixels in the output will be selectively reduced, with the result that a drop in resolution will occur when images are displayed on a PAL-compliant video device.

Adding Comments to Photographs: *Image Comment*

Using this option, you can add a brief text comment to photographs as they are taken. Comments can be viewed when the photographs are displayed using Nikon View 5 or Nikon Capture 3. The first twelve letters of the comment are also visible on the fourth page of the photo information display (114).

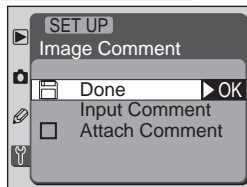

Video Output

The default video output varies with the country or region of purchase.

Entering a Comment: *Input Comment*

Selecting **Input Comment** displays the dialog shown below, where you can enter a comment up to thirty-six characters in length (if you attempt to input additional characters, any characters after the thirty-sixth will be deleted).

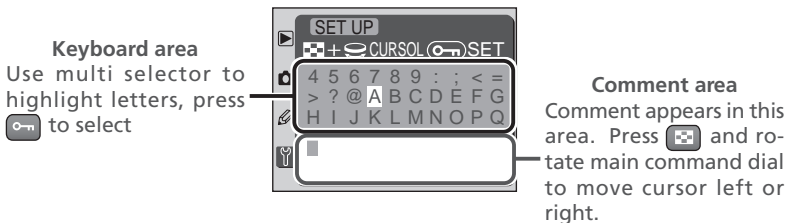

To move the cursor in the comment area left or right, press the button and rotate the main command dial. To enter a new letter at the current cursor position, use the multi selector to highlight the desired character in the keyboard area and press the button to enter the highlighted character. To delete the character at the current cursor position, press the button. To return to the setup menu without changing the comment, press the button.

When you have finished editing the comment, press the button to save the changes and return to the image comment menu.

Adding the Comment to Photographs: *Attach Comment*

Once you have entered a comment as described above, you can choose whether or not to add the comment to subsequent photographs. To add the comment to subsequent photographs, highlight **Attach Comment** in the image comment menu and press the multi selector to the right to enter a check in the box next to this item, then highlight **Done** and press the multi selector to the right to return to the setup menu. All photographs taken while the **Attach Comment** check box is checked will contain last comment entered.

To prevent the comment from being added to photographs, return to the image comment menu and remove the check from the **Attach Comment** check box by highlighting **Attach Comment** and pressing the multi selector to the right, then highlight **Done** and press the multi selector to the right to return to the setup menu.



Viewing Comments

The first twelve letters of the comment are visible in the fourth page of the photo information display (📷 115).

Connections

Connecting to External Devices

Television Playback



168

Connecting to a Computer



169–174

Using the EG-D1 video cable (provided), you can display photographs and camera menus on a television screen, or connect the camera to a video cassette recorder and record photographs to video tape. Once you have installed Nikon View 5, you can connect the camera to a computer via the UC-E4 USB cable (provided) and copy photographs to disk for editing, viewing, printing, or long-term storage.

Television Playback

Read this section for information on connecting the camera to a television or VCR and playing images back on the television screen.

Connecting to a Computer

This section describes the software available for the D100, how to connect the camera to a computer

Television Playback

Connecting Your Camera to a Video Device

Using the EG-D1 video cable provided, you can connect the D100 to a television or VCR for playback or recording.

1 Turn the camera off. Be sure to turn the camera off before connecting or disconnecting the video cable.

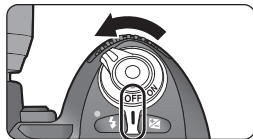

2 Open the cover protecting the camera's interface connectors.

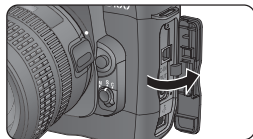

3 Connect the camera to the video device as shown.

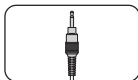

Connect to camera

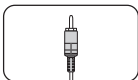

Connect to video device

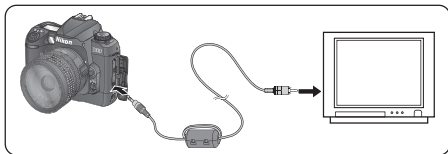

4 Tune the television to the video channel.

5 Turn the camera on. When the  button is pressed to play pictures back or the  button pressed to display camera menus, photographs and camera menus will be displayed on the television screen or recorded to video tape. The camera monitor will remain blank, but the camera will function normally in all other respects.



Use an AC Adapter

To minimize the drain on the battery, use an EH-5 AC adapter (available separately) during television playback.



Video Output 164

The default setting for **Video Output** is **NTSC**. Choose **PAL** when connecting to a PAL device. Note that resolution will drop when images are output on a PAL device.

Connecting to a Computer

Data Transfer and Camera Control

This section describes how to use the UC-E4 USB cable provided with your camera to connect your camera to a computer running Nikon View 5 or Nikon Capture 3.

Software for the D100

Two applications are available for the D100: Nikon View 5 (provided) and Nikon Capture 3 (available separately).

Nikon View 5

Using the Nikon View 5 software provided with your camera, you can transfer images from the camera or the camera memory card to your computer hard disk. Once transferred, your pictures can be viewed, printed, or saved to removable media for delivery to a photofinisher.

System Requirements

	Windows	Macintosh
OS	Pre-installed versions of Windows XP Home Edition, Windows XP Professional, Windows 2000 Professional, Windows Millennium Edition (Me), Windows 98 Second Edition (SE)	Mac OS 9.0, 9.1, 9.2, Mac OS X (10.1.2 or later)
CPU/Model	300 MHz Pentium or better	iMac, iMac DV, Power Macintosh G3 (Blue & White), Power Mac G4 or later, iBook, PowerBook G3 or later
RAM	64 MB (128 MB with RAW images) or more recommended	
Hard-disk space	25 MB required for installation, with additional free disk space of 10 MB plus an amount equal to double the capacity of camera memory card available on system disk when Nikon View 5 is running.	
Video resolution	800 × 600 pixels or more with 16-bit color (High Color/thousands of colors). 24-bit color (True Color/millions of colors) recommended.	
Other	<ul style="list-style-type: none">• Only computers with built-in USB ports supported.• CD-ROM drive required for installation.• Internet connection required for upload to the Web; e-mail program required when sending pictures by e-mail	



Nikon Capture 3

Using Nikon Capture 3 (available separately), you can control the camera from your computer. Photographs can be recorded directly to the computer hard disk via a USB connection, or captured into Nikon Capture 3 and processed before being saved to disk. Nikon Capture 3 supports **Nikon Electronic Image Format (NEF)**, allowing you to save photographs taken at image-quality settings of **NEF (Raw)** or **Comp. NEF (Raw)** to the computer hard disk, process them for use in another applications, and save them in a third-party format under a different name. Nikon Capture 3 also supports batch processing, simplifying studio photography.

System Requirements

	Windows	Macintosh*
OS	Pre-installed versions of Windows XP Home Edition, Windows XP Professional, Windows 2000 Professional, Windows Millennium Edition (Me), Windows 98 Second Edition (SE)	Mac OS 9.0.4†, 9.1, 9.2, Mac OS X (version 10.1.3 or later)
CPU/Model	300 MHz Pentium or better	iMac, iMac DV, Power Macintosh G3 (Blue & White), Power Mac G4 or later, iBook, PowerBook G3 or later
RAM (Nikon Capture 3)	<ul style="list-style-type: none"> • Windows XP, Mac OS X: 128 MB (256 MB or more recommended) • Mac OS 9: allocation of 32 MB or more recommended for Nikon Capture 3 Camera Control, 128 MB or more for Nikon Capture 3 Editor • Other platforms: 64 MB or more recommended (128 MB or more recommended when handling RAW images) 	
RAM (Nikon View 5)	64 MB (128 MB with RAW images) or more recommended	
Hard-disk space	200 MB required for installation, with additional free disk space of 10 MB plus an amount equal to double the capacity of camera memory card available on system disk when Nikon Capture 3 is running.	
Video resolution	800 × 600 pixels or more with 16-bit color (High Color/thousands of colors). 24-bit color (True Color/millions of colors) recommended.	
Other	<ul style="list-style-type: none"> • Only models with built-in USB ports supported. • CD-ROM drive required for installation. • Internet connection required for upload to the Web; e-mail program required when sending pictures by e-mail 	

* Camera control function is not available when the D100 is used with the Macintosh version of Nikon Capture 3.

† With Carbon Lib version 1.5 or later.

Requirements subject to change without notice. More recent information and upgrades may be available on-line at the sites listed in "Technical Notes: Web Resources" (192).

Direct USB Connection

Before connecting the camera to your computer via the UC-E4 USB cable included with your camera, you must install Nikon View 5 (provided) or Nikon Capture 3 (available separately). Installation instructions for Nikon View 5 are provided in the *Quick Start Guide*. Once you have installed the necessary software, you can connect the camera and computer as detailed below.

- 1 Turn the computer on and wait for the operating system to start up.
- 2 Turn the camera off.

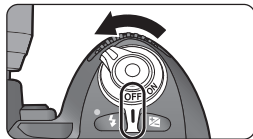

- 3 Connect the UC-E4 cable directly to the computer using the flat connector. Connect the other end of the cable to the camera's USB connector. Do not connect the cable to a USB hub or keyboard.

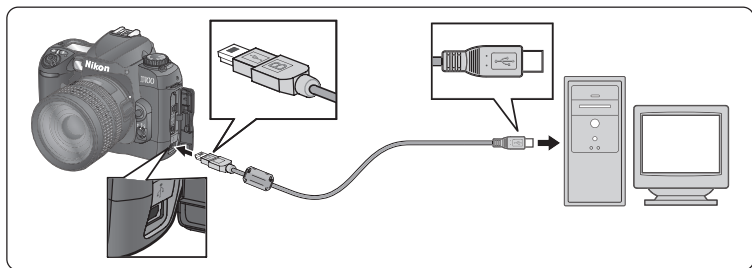

Use an AC Adapter

To ensure that data transfer is not interrupted, be sure that the battery is fully charged. If in doubt, charge the battery before use or use an EH-5 AC adapter (available separately;  180).

4 Turn the camera on.

If installed, Nikon View 5 will start automatically when the camera is connected and turned on. While Nikon View 5 is running, the control panel and viewfinder will show **PC**; if the monitor is on, it will turn off. No camera controls apart from the power switch will function until the camera is disconnected. For more information on Nikon View 5, see the *Nikon View 5 Reference Manual* (on CD).

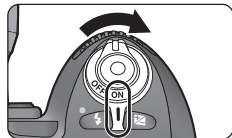

If the Nikon Capture 3 camera control component is running, the exposure count displays in the control panel and viewfinder will show **PC**. All camera controls function normally, but any shots taken will be recorded to the computer hard disk rather than the camera memory card (Windows only; the Macintosh version of Nikon Capture does not support camera control with the D100). For details on operation, see the user's manual provided with Nikon Capture 3.

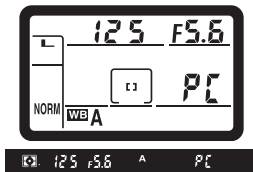

5 Before disconnecting the camera, you will need to remove it from the system as described on the following page.

Low Battery

If the battery level is low and the camera battery-level indicator is flashing when the camera is connected to a computer, the camera will not be able to communicate with the computer, and **PC** will not be displayed in the control panel or viewfinder.

"Hot Plug"

The USB interface supports "hot plug" connection of peripheral devices. This means that the camera can be on or off when you connect it to the computer. The camera can also be on when the cable is disconnected; when disconnecting the cable, however, be sure to follow the instructions given in Step 5, above.

Windows XP Home Edition/Windows XP Professional

Click the “Safely Remove Hardware” icon  in the taskbar and select **Safely remove USB Mass Storage Device** from the menu that appears.

*Windows 2000 Professional*

Click the “Unplug or Eject Hardware” icon  in the taskbar and select **Stop USB Mass Storage Device** from the menu that appears.

*Windows Millennium Edition (Me)*

Click the “Unplug or Eject Hardware” icon  in the taskbar and select **Stop USB Disk** from the menu that appears.

*Windows 98 Second Edition (SE)*

In My Computer, click with the right mouse button on the removable disk corresponding to the camera and select **Eject** from the menu that appears.

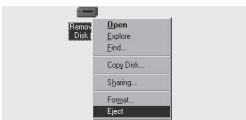
*Mac OS X*

Drag the “Nikon_D100” camera volume into the Trash.

Mac OS 9

Drag the “Nikon D100” camera volume into the Trash.

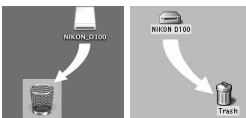

Mac OS X

Mac OS 9

- 6 Check that **P**  is no longer displayed in the control panel or viewfinder. You can now disconnect the cable or turn the camera off.

Disconnecting the Camera

Before turning the camera off or disconnecting the interface cable, be sure that transfer is complete and that **P**  is no longer displayed in the control panel or viewfinder. While transfer is in progress, do not turn the camera off, disconnect the USB cable, or remove the memory card from the camera.

Technical Notes

Camera Care, Options, and Resources

This chapter covers the following topics:

Optional Accessories (📖 176–183)

A list of the lenses and other accessories available for the D100.

Caring for Your Camera (📖 184–187)

Information on storage and maintenance.

Troubleshooting (📖 188–191)

A list of the error messages displayed by your camera and how to deal with them.

Web Resources (📖 192)

Where to find help on-line.

Specifications (📖 193–197)

Principal specifications for the D100.

Lenses for the D100



The D100 is compatible with a variety of AF Nikkor lenses for 35-mm film cameras, including wide-angle, telephoto, zoom, micro, defocus image control (DC), and regular lenses with focal lengths of 14–600 mm (📷 179). Note that IX Nikkor CPU lenses can not be used with the D100.

❌ Incompatible Accessories and Non-CPU Lenses



The following accessories and non-CPU lenses can not be used with the D100:

- TC-16AS AF Teleconverter
- Non-AI lenses
- Lenses that require the AU-1 focusing unit (400 mm f/4.5, 600 mm f/5.6, 800 mm f/8, 1200 mm f/11)
- Fisheye (6 mm f/5.6, 8 mm f/8, OP 10 mm f/5.6)
- 21 mm f/4 (old type)
- K1 and K2 rings, PK-1 and PK-11 auto extension rings, BR-2 and BR-4 auto rings
- ED 180–600 mm f/8 (serial numbers 174041–174180)
- ED 360–120 mm f/11 (serial numbers 174031–174127)
- 280–600 mm f/9.5 (serial numbers 280001–300490)
- Lenses for the F3AF (80 mm f/2.8, 200 mm f/3.5, TC-16S Teleconverter)
- PC 28 mm f/4 (serial number 180900 or earlier)
- PC 35 mm f/2.8 (serial numbers 851001–906200)
- PC 35 mm f/3.5 (old type)
- 1000 mm f/6.3 Reflex (old type)
- 1000 mm f/11 Reflex (serial numbers 142361–143000)
- 2000 mm f/11 Reflex (serial numbers 200111–200310)

📎 Compatible Non-CPU Lenses

Non-CPU lenses not listed above can be used, but only in manual exposure mode (📷 82). Aperture must be adjusted manually using the lens aperture ring and the camera's exposure meter can not be used. If another exposure mode is selected when a non-CPU lens is attached, the shutter release will be disabled and a blinking **F-** will appear in the aperture displays in the control panel and viewfinder.

The lenses that can be used with the D100 are listed below.

Camera setting Lens/accessory		Focus mode			Exposure mode		Metering system		
		S C	M (with electronic range finder)	M	P S A	M			 
							3D	Ten-segment	
CPU lenses ²	Type G or D AF Nikkor ³ AF-S, AF-I Nikkor	✓	✓	✓	✓	✓	✓	—	✓
	PC Micro Nikkor 85 mm F2.8D ⁴	—	✓ ⁵	✓	—	✓	✓	—	✓
	AF-I Teleconverter ⁶	✓ ⁷	✓ ⁷	✓	✓	✓	✓	—	✓
	Other AF Nikkor (except lenses for F3AF)	✓ ⁸	✓ ⁸	✓	✓	✓	—	✓	✓
	AI-P Nikkor	—	✓ ⁹	✓	✓	✓	—	✓	✓
Non-CPU lenses ¹⁰	AI-, AI-S, or AI-modified Nikkor Series E Nikkor	—	✓ ⁹	✓	—	✓ ¹¹	—	—	—
	Medical Nikkor 120 mm f/4	—	✓	✓	—	✓ ¹²	—	—	—
	Reflex-Nikkor	—	—	✓	—	✓ ¹¹	—	—	—
	PC-Nikkor	—	✓ ⁵	✓	—	✓ ¹¹	—	—	—
	AI-type Teleconverter	—	✓ ⁷	✓	—	✓ ¹¹	—	—	—
	PB-6 Bellows Focusing Attach- ment ¹³	—	✓ ⁷	✓	—	✓ ¹¹	—	—	—
	Auto extension rings (PK series 11A, 12, or 13; PN-11)	—	✓ ⁷	✓	—	✓ ¹¹	—	—	—

1 Spot metering meters selected focus area.

2 IX-Nikkor lenses can not be used.

3 Vibration Reduction (VR) supported with VR lenses.

4 The camera's exposure metering and flash control systems do not work properly when shifting and/or tilting the lens, or when an aperture other than the maximum aperture is used.

5 Electronic range finder can not be used with shifting or tilting.

6 Compatible with all AF-S and AF-I Nikkor lenses except the AF-S 17–35 mm f/2.8D IF-ED and AF-S 28–70 mm f/2.8 IS ED.

7 With maximum effective aperture of f/5.6 or faster.

8 If an AF-80–200 mm f/2.8S, AF 35–70 mm f/2.8S, new-model AF 28–85 mm f/3.5–4.5S, or AF 28–85 mm f/3.5–4.5S lens is used, the image on the matte screen in the viewfinder may not be in focus when the in-focus indicator is displayed. Focus manually using the image in the viewfinder as a guide.

9 With maximum aperture of f/5.6 or faster.

10 Some lenses can not be used (see previous page).

11 Camera exposure meter can not be used.

12 Can be used at shutter speeds slower than 1/180 s, but camera exposure meter can not be used.

13 Attach in vertical orientation. PB-6 can be set to horizontal orientation once attached.

- Medical Nikkor 200 mm f/5.6 requires AS-15 for flash control.

- PF-4 Reprocopy Outfit requires PA-4 Camera Holder.

For the D100, Nikon recommends CPU lenses, particularly types G and D, as it is only with type G and D lenses that you can use such features as 3D-matrix metering and 3D multi sensor balanced fill flash for digital SLR. CPU lenses can be identified by the presence of CPU contacts. Type G lenses are marked with a "G" on the lens barrel, type D lenses with a "D."

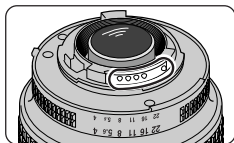

CPU lens

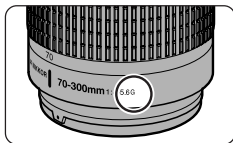

Type G lens

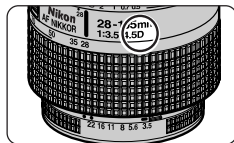

Type D lens

Type G lenses are not equipped with a lens aperture ring. Unlike other CPU lenses, there is no need to lock the aperture ring at the minimum aperture setting (maximum f -number) when using a type G lens.

Picture Angle and Focal Length

A 35-mm camera has a diagonal picture angle approximately one-and-a-half times that of the D100. When calculating the focal length of the lenses for the D100 in 35-mm format, you will therefore need to multiply the focal length of the lens by 1.5, as shown in the following table:

Picture angle	Approximate focal length (mm) in 35-mm format (modified for picture angle)							
	35-mm film camera	17	20	24	28	35	50	60
D100	25.5	30	36	42	52.5	75	90	127.5
35-mm film camera	105	135	180	200	300	400	500	600
D100	157.5	202.5	270	300	450	600	750	900

Calculating Picture Angle

The size of the area exposed by a 35-mm camera is 24×36 mm. The size of the area exposed by the D100, in contrast, is 15.6×23.7 mm. As a result, the picture angle of photographs taken with the D100 differs from the picture angle for 35-mm cameras, even when the focal length of the lens and the distance to the subject are the same.

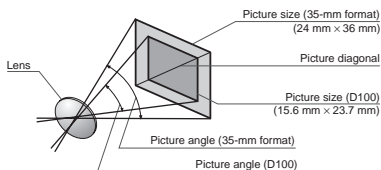

Other Accessories

At the time of writing, the following accessories were available for the D100. Contact your retailer or local Nikon representative for details.

Battery packs/ AC adapters

■ *EN-EL3 Rechargeable Battery*

Additional rechargeable Nikon EN-EL3 lithium-ion batteries are available from your retailer or local Nikon representative.

■ *MB-D100 Multi-Function Battery Pack*

The MB-D100 takes one or two rechargeable Nikon EN-EL3 lithium-ion batteries or six 1.5-volt LR6 (AA) alkaline or lithium batteries for extended shooting or playback. It is equipped with a shutter-release button and main- and sub-command dials for improved operation when taking photographs in portrait (tall) orientation. A built-in microphone allows voice memos to be added to photographs during playback. These recordings are played back over the battery-pack's built in speaker when the photos are displayed in slide shows or single-image playback. The MB-D100 also incorporates a ten-pin remote terminal for connection to other devices. When attaching the MB-D100, you will need to remove the battery-chamber cover and the MB-D100 terminal cover from the camera. The camera battery-chamber cover can be removed as shown below.

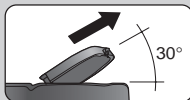

■ *EH-5 AC Adapter*

The EH-5 AC adapter can be used with AC power sources of 50–60 Hz and 100–120 V or 200–240 V. Separate power cables are available for use in North America, the United Kingdom, Europe, Australia, and Japan.

Viewfinder eyepiece accessories

■ *DG-2 Magnifier*

The DG-2 magnifies the scene displayed in the viewfinder. Use for close-up photography, copying, telephoto lenses, and on other occasions on which added precision is required. Eyepiece adapter (available separately) required.

■ *Dioptric-Adjustment Viewfinder Lenses*

To accommodate individual differences in vision, viewfinder lenses are available with diopters of -5 , -4 , -3 , -2 , 0 , $+0.5$, $+1$, $+2$, and $+3$.



Filters

- Nikon filters can be divided into three types: screw-in, drop-in, and rear-interchange. With the exception of the R60, exposure compensation need not be adjusted when a Nikon filter is attached (in the case of the R60, set exposure compensation to +1). Filters manufactured by other makers may interfere with autofocus or electronic range finding.
- The D100 can not be used with linear polarizing filters. Use the C-PL circular polarizing filter instead.
- The NC and L37C filters are recommended for protecting the lens.
- To prevent moiré, use of a filter is not recommended when the subject is framed against a bright light, or when a bright light source is in the frame.

Optional Speedlights

■ Nikon SB-80DX Speedlight

This high-performance Speedlight has a Guide Number of 53/174 (m/ft, manual mode, 35-mm zoom-head position, ISO 200, 20 °C/68 °F; GN at ISO 100 is 38/125) and accepts four LR6 (AA) alkaline batteries or SD-7, SD-8A, and SK-6 power sources (all available separately). For bounce-flash or close-up photography, the flash head can be rotated through 90 ° up, 7 ° down, 180 ° left, and 90 ° right. Light from the flash can be diffused for wide-angle photography by using the SB-80DX in combination with a wide panel or bounce adapter, producing soft lighting that balances the foreground subject with the background in close-ups and bounce-flash photography. The SB-80DX is equipped with an illuminator to assist in adjusting settings in the dark. Custom settings allow you to fine-tune all aspects of flash operation.

■ Nikon SB-50DX Speedlight

This Guide Number 32/105 Speedlight (m/ft, manual mode, 35-mm zoom-head position, ISO 200, 20 °C/68 °F; GN at ISO 100 is 22/72) is powered by two CR123A (DL123A) three-volt lithium batteries. In addition to auto power zoom, it has a tilt position of +90 ° to -18 °, allowing it to be used both for bounce-flash photography and at ranges as close as 30 cm (1'). The following sync modes are supported: slow sync, rear-curtain sync, and manual. If the built-in Speedlight is raised when the SB-50DX is set to manual in the bounce-flash position, both Speedlights will fire.

PC card adapters

■ EC-AD1 PC Card Adapter

The EC-AD1 PC card adapter allows Type I CompactFlash™ memory cards to be inserted in PCMCIA card slots.

Cable release■ **AR-3 Cable Release**

The AR-3 can be attached to the camera release terminal to reduce camera shake in situations that demand slow shutter speeds, such as night landscape, astronomical, and close-up photography.

Remote terminal accessories

The MB-D100 multi-function battery pack is equipped with a ten-pin remote terminal for remote-control and automatic photography. The following accessories can be used with the MB-D100:

Accessory	Description	Length*
MC-20 Remote Cord	Remote shutter release; can be used to reduce camera shake. Equipped with time-exposure and timer features, emitting a beep once a second while the shutter is open.	80 cm/ 2'7"
MC-21 Extension Cord	Can be connected to MC-series 20, 22, 25, or 30.	3 m/ 9'10"
MC-22 Remote Cord	Remote shutter release with blue, yellow, and black terminals for connection to a remote shutter-triggering device, allowing control via sound or electronic signals.	1 m/3'3"
MC-23 Connecting Cord	Connects two D-100 cameras (both with MB-D100 multi-function battery packs) for simultaneous operation.	40 cm/ 1'4"
MC-25 Adapter Cord	Ten-pin to two-pin adapter cord for connection to devices with two-pin terminals, including the MW-2 radio control set, MT-2 intervalometer, and ML-2 modulite control set.	20 cm/ 8"
MC-30 Remote Cord	Remote shutter release; can be used to reduce camera shake or keep the shutter open during a time exposure.	80 cm/ 2'7"
ML-2 Modulite Remote Control Set	Allows infrared remote control at ranges of up to 100 m (328'). Use multiple units for remote control over greater distances. Requires MC-25 adapter cord.	—
ML-3 Modulite Remote Control Set	Allows infrared remote control at ranges of up to 8 m (26').	—

* All figures are approximate.

Software■ **Nikon Capture 3**

Use Nikon Capture 3 to capture photos to a computer and to edit and save RAW images in a different format.



Approved Memory Cards

The following cards have been tested and approved for use in the D100:

<i>CompactFlash™</i>	SanDisk	SDCFB series	16, 32, 48, 64, 96, and 128 MB
	Lexar Media	4× USB series	8, 16, 32, 48, 64, and 80 MB
		8× USB series	8, 16, 32, 48, 64, and 80 MB
		10× USB series	128 and 160 MB
<i>Microdrive®</i>	IBM	DSCM series	10512 (512 MB) and 11000 (1 GB)

Operation is not guaranteed with other makes of card. For more details on the above cards, please contact the manufacturer.

Memory Cards

- Memory cards may be hot after use. Observe due caution when removing memory cards from the camera.
- Format memory cards before first use.
- Turn the power off before inserting or removing memory cards. Do not remove memory cards from the camera, turn the camera off, or remove or disconnect the power source during formatting or while data are being recorded, deleted, or copied to a computer. Failure to observe these precautions could result in loss of data or in damage to the camera or card.
- Do not touch the card terminals with your fingers or metal objects.
- Do not apply force to the card casing. Failure to observe this precaution could damage the card.
- Do not bend, drop, or subject to strong physical shocks.
- Do not expose to water, high levels of humidity, or direct sunlight.

Use Only Nikon Brand Electronic Accessories

Your Nikon D100 digital camera is designed to the highest standards and includes complex electronic circuitry. Only Nikon brand electronic accessories (including battery chargers, batteries, and AC adapters) certified by Nikon specifically for use with your Nikon digital camera are engineered and proven to operate within the operational and safety requirements of this electronic circuitry.

THE USE OF NON-NIKON ELECTRONIC ACCESSORIES COULD DAMAGE YOUR CAMERA AND MAY VOID YOUR NIKON WARRANTY.

For more information about Nikon brand accessories, contact your local authorized Nikon dealer.

Storage

When the camera will not be used for an extended period, replace the monitor cover, remove the battery, and store the battery in a cool, dry area with the terminal cover in place. To prevent mold or mildew, store the camera in a dry, well-ventilated area. For long-term storage, place the camera in a plastic bag containing a desiccant (note that desiccant gradually loses its capacity to absorb moisture and should be replaced at regular intervals). Do not store your camera with naphtha or camphor moth balls or in locations that:

- are poorly ventilated or damp
- are next to equipment that produces strong electromagnetic fields, such as televisions or radios
- are exposed to temperatures above 50 °C/122 °F (for example, near a space heater or in a closed vehicle on a hot day) or below -10 °C (14 °F)
- are subject to humidities of over 60%

To prevent mold or mildew, take the camera out of storage at least once a month. Turn the camera on and release the shutter a few times before putting the camera away again.

✓ Servicing the Camera and Accessories

Your camera is a precision device and requires regular servicing. We recommend that you have your camera inspected by your retailer or Nikon service representative once every one to two years, and that you have it serviced once every three to five years (note that fees apply to these services). Frequent inspection and servicing are particularly recommended if you use your camera professionally. When having your camera inspected or serviced, we recommend that you bring any accessories regularly used with the camera, such as lenses or optional Speedlights.

Cleaning

Camera body

Use a blower to remove dust and lint, then wipe gently with a soft, dry cloth. After using the camera at the beach or seaside, wipe off sand or salt with a cloth lightly dampened in distilled water and dry thoroughly.

Lens, mirror, and viewfinder

These elements are made of glass and are easily damaged. Remove dust and lint with a blower. If using an aerosol blower, keep the can vertical to prevent the discharge of liquid. To remove fingerprints and other stains, apply a small amount of lens cleaner to a soft cloth and clean with care.

Monitor

Remove dust and lint with a blower. When removing fingerprints and other stains, wipe the surface lightly with a soft cloth or chamois leather. Do not apply pressure, as this could result in damage or malfunction.

The Monitor

Should the monitor break, care should be taken to avoid injury caused by broken glass and to prevent liquid crystal from entering your eyes and mouth.

The Shutter Curtain

The shutter curtain is extremely thin and easily damaged. Under no circumstances should you exert pressure on the curtain, poke it with cleaning tools, or subject it to powerful air currents from a blower. These actions could scratch, deform, or tear the curtain.

The Control Panel

Rarely, static electricity may cause the control panel to brighten or darken. This does not indicate a malfunction; the display will shortly return to normal.

The Low-Pass Filter

The charge-coupled device (CCD) that acts as the camera's picture element is fitted with a low-pass filter to prevent moiré. Although this filter prevents foreign objects from adhering directly to the CCD, under certain conditions dirt or dust on the filter may appear in photographs. If you suspect that dirt or dust inside the camera is affecting your photographs, you can check for the presence of foreign objects on the low-pass filter as described below.

- 1 Turn the camera off and connect an EH-5 AC adapter (available separately). If you do not have access to an EH-5 AC adapter, take the camera to a Nikon-authorized service center.
- 2 Remove the lens and turn the camera on.
- 3 Press the **MENU** button and select **Mirror Lock-up** from the setup menu (▶ 163). Highlight **CCD Cleaning** and press the multi selector to the right. The message, "Press shutter-release button" will be displayed in the camera monitor, and a row of dashes will be displayed in the control panel and viewfinder.

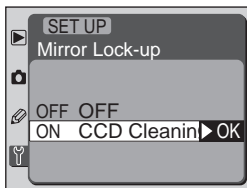

- 4 Press the shutter-release button all the way down. The mirror will be raised and the shutter curtain will open, revealing the low-pass filter, and the row of dashes in the control panel will blink.
- 5 Holding the camera so that light falls on the low-pass filter, examine the filter for dust or lint. If you find a foreign object on the filter, you will need to have it cleaned. See the following section.

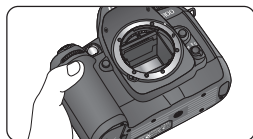
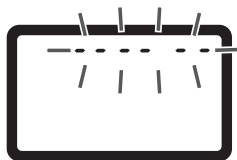

- 6 Turn the camera off. The mirror will return to the down position and the shutter curtain will close. Replace the lens or body cap and disconnect the AC adapter.

Cleaning the Low-Pass Filter

The low-pass filter is extremely delicate and easily damaged. We recommend that the filter only be cleaned by Nikon-authorized service personnel. Should you choose to clean the filter yourself, follow the steps below.

- 1 Raise the mirror as described in steps 1–4 on the preceding page.

- 2 Remove dust and lint from the filter with a blower. Do not use a blower-brush, as the bristles could damage the filter. If using an aerosol blower, hold the can upright to prevent liquid from falling on the filter. Dirt that can not be removed with a blower can only be removed by Nikon-authorized service personnel. Under no circumstances should you touch or wipe the filter.

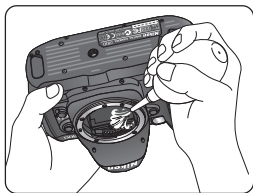

- 3 Turn the camera off. The mirror will return to the down position and the shutter curtain will close. Replace the lens or body cap and disconnect the AC adapter.











Troubleshooting

Understanding Error Messages and Displays

This section lists the indicators and error messages that appear in the viewfinder, control panel, and monitor when there is a problem with the camera. Consult the list below before contacting your retailer or Nikon representative.

Shooting Errors



If a problem occurs during shooting, indicators will be displayed in the control panel or viewfinder.

Indicator		Problem	Solution	
Control panel	Viewfinder			
 (blinks)		Lens aperture ring is not set to minimum aperture.	Set ring to minimum aperture (largest f/-number).	21
 (blinks)		Speedlight that does not support D-TTL flash control attached and set to TTL.	Set external Speedlight flash mode to another setting.	106
		Low battery.	Ready a fully-charged spare battery.	17
 (blinks)	 (blinks)	Battery exhausted.	Replace battery.	17
 (blinks)		No lens attached, or non-CPU lens attached.	Attach a CPU lens (IX Nikkor excluded) or set function dial to M and use lens aperture ring to set aperture.	20, 76, 82
	 (blinks)	Camera can not focus using autofocus.	Focus manually.	74
		Subject too bright; photo will be overexposed.	<ul style="list-style-type: none">Choose a lower sensitivity (ISO equivalency)In exposure mode:<ul style="list-style-type: none">P Use ND filterS Increase shutter speed or use ND filterA Choose a smaller aperture (larger f/-number) or use ND filter.	48 78 80 81

Indicator		Problem	Solution	
Control panel	Viewfinder			
Lo		Subject too dark; photo will be underexposed.	<ul style="list-style-type: none"> Choose a higher sensitivity (ISO equivalency) In exposure mode: <ul style="list-style-type: none"> P Use the flash S Lower shutter speed or use the flash A Choose a larger aperture (smaller f/-number) or use the flash 	48 78 80 81
	Exposure display blinks	Exposure exceeds limits of metering system.	If subject too bright, use ND filter; if too dark, use the flash.	83
bulb (blinks)		bulb selected in shutter-priority auto.	Choose another shutter speed or set function dial to M .	79, 83
	⚡ (blinks)	If indicator blinks for 3 s after flash fires, photo may be underexposed.	Check photo in monitor; if underexposed, adjust settings and try again.	99
Full 0 (blinks)	Full 0 (blinks)	Memory insufficient to record further photos at current settings, or camera has run out of file or folder numbers.	<ul style="list-style-type: none"> Reduce quality or size. Delete photographs. Insert new memory card. 	44, 46 120, 124 22
Err (blinks)		Camera malfunction.	Release shutter. If error persists or appears frequently, consult with Nikon-authorized service representative.	192

Playback Errors

During playback, error messages are displayed in the monitor. Indicators may also appear in the control panel.

Message	Control panel	Problem	Solution	
No card present	(-E-)	Camera cannot detect memory card.	Turn camera off and confirm that card is correctly inserted.	17, 23
This card cannot be used	 (blinks)	<ul style="list-style-type: none"> • Error accessing memory card. • Unable to create new folder • Memory card has not been formatted for use in D100. 	<ul style="list-style-type: none"> • Use Nikon-approved card. • Check that contacts are clean. If card is damaged, contact retailer or Nikon representative. • Delete files or insert new memory card. • Format memory card. 	183 — 120, 124, 22, 23, 162
Card is not formatted	(For)	Memory card has not been formatted for use in D100.	Format memory card.	23, 162
No images in current folder		Memory card is empty or folder(s) selected for playback contain no images.	Insert memory card containing images or select folder containing images from Folder Designate menu.	22 126
All images are hidden		All photos in current folder are hidden.	No images can be played back until another folder has been selected or Hide Image used to allow at least one image to be displayed.	127 130
File does not contain image data		File has been created or modified using a computer or different make of camera, or file is corrupt.	Delete file or reformat memory card.	120, 124, 23, 162

A Note on Electronically-Controlled Cameras

In extremely rare instances, unusual characters may appear in the control panel and the camera may stop functioning. In most cases, this phenomenon is caused by a strong external static charge. Turn the camera off, remove and replace the battery, and turn the camera on again, or, if you are using an AC adapter (available separately), disconnect and reconnect the adapter and turn the camera on again. If the problem persists, open the interface connector cover and use a fine-tipped object, such as a mechanical pencil, to press the tab in the small square hole located above the interface connectors (this will also reset the camera clock; for instructions on setting the clock to the correct date and time, see page 19). In the event of continued malfunction, contact your retailer or Nikon representative. Note that disconnecting the power source as described above may result in loss of any data not recorded to the memory card at the time the problem occurred. Data already recorded to the card will not be affected.

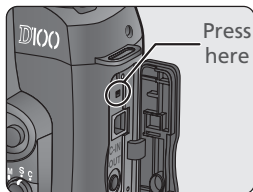

At the time of writing, the following on-line resources were available for users of Nikon digital imaging equipment.



For Product Information and Tips

- For users in the U.S.A.: <http://www.nikonusa.com>
- For users in Europe: <http://www.nikon-euro.com/>
- For users in Asia, Oceania, the Middle East, and Africa:
<http://www.nikon-asia.com/>

For Contact Information

Contact information for the Nikon representative in your area may be found at:
<http://www.nikon-image.com/eng/>

Specifications

Type	Single-lens reflex digital camera with interchangeable lenses
Effective pixels	6.1 million
CCD	23.7 × 15.6 mm, 12-bit RGB CCD Total pixels: 6.31 million
Image size (pixels)	• 3008 × 2000 (Large) • 2240 × 1488 (Medium) • 1504 × 1000 (Small)
Lens mount	Nikon F mount (with AF coupling and AF contacts)
Compatible lenses	
Type G or D AF Nikkor	All functions supported
PC Micro Nikkor 85 mm F2.8D	All functions except autofocus supported
Other AF Nikkor (IX Nikkor excluded)	All functions except 3D multi-sensor balanced fill flash for digital SLR supported
AI-P Nikkor	All functions except autofocus, 3D matrix metering, and 3D multi-sensor balanced fill flash for digital SLR supported
Other	Can be used in exposure mode M, but exposure meter does not function; electronic range finder can be used if lens has a maximum aperture of f/5.6 or faster
Picture angle	Equivalent in 35-mm format is approximately 1.5 times lens focal length
Viewfinder	Optical fixed pentaprism
Diopter adjustment	-2.0 – +1.0 m ⁻¹
Eye point	24 mm (-1.0 m ⁻¹)
Focusing screen	Type B BriteView clear matte screen Mark II with superimposed focus brackets and On-Demand grid lines
Frame coverage	Approximately 95% of lens (vertical and horizontal)
Approximate magnification	0.8 × with 50-mm lens set to infinity and -1.0 m ⁻¹
Reflex mirror	Quick-return
Lens aperture	Instant return with depth-of-field preview
Focus-area selection	Can be selected from five focus areas



Lens servo	Instant single-servo AF (S), continuous servo AF (C), manual (M); predictive focus tracking automatically activated according to subject status in single-servo and continuous-servo AF
Autofocus	TTL phase detection by means of Nikon Multi-CAM900 autofocus module with AF-assist illuminator (range approximately 0.5 – 3 m/1'8"–9'10")
Detection range	–1 – +19 EV (ISO 100, room temperature)
AF-area mode	Single-area AF, dynamic-area AF (supports closest-subject priority)
Focus lock	Focus can be locked by pressing shutter-release button halfway (single-servo AF) or pressing AE-L/AF-L button
Exposure	
Metering	Three-mode through-the-lens (TTL) exposure metering
Matrix	3D matrix metering supported with type G and D lenses; matrix metering available with other lens types
Center-weighted	Weight of 60% given to 8-mm circle in center of frame
Spot	Meters 3-mm circle in center of frame; with CPU lens, metered area linked to selected focus area
Range (ISO 100 equivalent, f/1.4 lens, 20 °C/68 °F)	0 – 21 EV (3D matrix or center-weighted metering) 3 – 21 EV (spot metering)
Exposure meter coupling	CPU coupling
Exposure control	Programmed auto with flexible program; shutter-priority auto; aperture-priority auto; manual; exposure compensation (–5 – +5 EV in increments of $\frac{1}{3}$ EV); exposure and flash bracketing (2 or 3 exposures in steps of $\frac{1}{3}$ or $\frac{1}{2}$ EV)
Exposure lock	Locked at detected value with AE-L/AF-L button
Shutter	Electronically controlled vertical-travel focal-plane shutter
Speed	30 – $\frac{1}{4000}$ in $\frac{1}{3}$ or $\frac{1}{2}$ EV steps, long time-exposure (bulb)
Sensitivity	200 – 1600 (ISO equivalent) in steps of $\frac{1}{3}$ EV; auto gain to ISO 1600 equivalent



White balance	TTL white balance control with white balance bracketing
Built-in Speedlight	Pop-up Speedlight with button release
Guide number (m/ft)	
D-TTL	17/56 (ISO 200); 12/39 (ISO 100)
Manual	18/59 (ISO 200); 12.7/42 (ISO 100)
Illuminating angle	Same as 20-mm lens
Flash	
Sync contact	X-contact only; flash synchronization at up to $\frac{1}{180}$ s
Flash control	<ul style="list-style-type: none"> • Automatic balanced fill flash controlled by five-segment TTL multi sensor with single-component IC. Supports 3D multi-sensor balanced fill flash for digital SLR (built in Speedlight or SB-series 80DX/50DX/28DX with type G or D lens) and multi-sensor balanced fill flash for digital SLR (built in Speedlight or SB-series 80DX/50DX/28DX with other CPU Nikkor lens) • Non-TTL auto • Aperture-linked auto flash control available with CPU lenses and SB-series 80DX/50DX/28DX • Flash exposure compensation (-3 – +1 EV in increments of $\frac{1}{3}$ or $\frac{1}{2}$ EV)
Flash sync modes	Front-curtain sync (normal), red-eye reduction, red-eye reduction with slow sync, slow sync, rear curtain
Flash-ready indicator	Lights when built-in Speedlight or SB-series 80DX, 50DX, 28DX, 28, 27, or 22s is fully charged; blinks for three seconds after flash is fired at full output
Accessory shoe	Standard ISO hot-shoe contact with safety lock
Storage	
Media	Type I and II CompactFlash™ cards; Microdrives®
File system	Compliant with Design Rule for Camera File Systems (DCF) and Digital Print Order Format (DPOF)
Compression	<ul style="list-style-type: none"> • Compressed NEF (raw): 12-bit lossless compression • JPEG: JPEG baseline compliant

Specifications

Self-timer	Electronically controlled; duration 2 – 20 s
Depth-of-field preview button	Lens aperture stopped down when button is pressed
Monitor	1.8", approximately 120,000-dot, low temperature polysilicon TFT LCD with brightness adjustment
Video output	Can be selected from NTSC and PAL
External interface	USB 1.1
Tripod socket	1/4" (ISO)
Power source	<ul style="list-style-type: none">• One rechargeable Nikon EN-EL3 lithium-ion battery• MB-D100 multi-function battery pack (available separately) with one or two rechargeable Nikon EN-EL3 lithium-ion batteries or six LR6 (AA) alkaline or lithium batteries• EH-5 AC adapter (available separately)
Approximate dimensions (W × H × D)	144 × 116 × 80.5 mm (5.7" × 4.6" × 3.2")
Approximate weight	700 g (25 oz) without battery or memory card
Operating Environment	
Temperature	0 – 40 °C (32 – 104 °F)
Humidity	Less than 85% (no condensation)

* Unless otherwise stated, all figures are for a camera with a fully-charged battery operating at an ambient temperature of 20 °C (68 °F).

* Nikon reserves the right to change the specifications of the hardware and software described in this manual at any time and without prior notice. Nikon will not be held liable for damages that may result from any mistakes that this manual may contain.

Battery Life

The number of shots that can be taken with an EN-EL3 battery varies with the condition of the battery, temperature, and how the camera is used.

Case 1

At room temperature (20 °C/68 °F), approximately 1600 shots can be taken with a fully-charged (1400 mAh) EN-EL3 battery and an AF-S 24–85 mm f/3.5–4.5 G lens under the following standard Nikon test conditions: continuous shooting mode; continuous-servo autofocus; image quality set to JPEG Basic; image size set to Medium; shutter speed $\frac{1}{250}$ s; shutter-release pressed halfway for three seconds and focus cycled from infinity to minimum range three times with each shot; after six shots, monitor turned on for five seconds and then turned off; cycle repeated once exposure meters have turned off.

Case 2

At room temperature (20 °C/68 °F), approximately 370 shots can be taken with a fully-charged (1400 mAh) EN-EL3 battery and an AF-S 24–85 mm f/3.5–4.5 G lens under the following standard Nikon test conditions: single-frame shooting mode; single-servo autofocus; image quality set to JPEG Normal; image size set to Large; shutter speed $\frac{1}{250}$ s; shutter-release pressed halfway for five seconds and focus cycled from infinity to minimum range once with each shot; next shot taken after exposure meters have turned off; built-in Speedlight fired at full power with every other shot; AF-assist illuminator lights when flash is used; camera turned off for one minute after every ten shots.

The following can reduce battery life:

- Using the monitor
- Keeping the shutter-release button pressed halfway
- Repeated autofocus operations
- Taking NEF (raw) or TIFF-RGB photographs
- Slow shutter speeds

To ensure that you get the most from rechargeable Nikon EN-EL3 batteries:

- Keep the battery contacts clean. Soiled contacts can reduce battery performance.
- Use batteries immediately after charging. Batteries will lose their charge if left unused.

Symbols

3D Multi Sensor Balanced Fill-Flash for Digital SLR, 95

A

AF area mode, 65–69
 AF assist illuminator, 72
 Aperture, 76–93, 107
 adjusting, 76–83
 lock, 84–85, 154
 maximum, 81
 minimum, 21, 81, 178
 Auto meter off, 157
 Autoexposure lock, 84–85
 Autofocus, 63–73
 dynamic-area AF, 65–69
 continuous-servo, 63–69
 focus tracking, 66
 single-area AF, 65–69
 single-servo, 63–69

B

Backlight, control panel, 155
 BASIC. *See* **Image Quality**
 Battery, 16–17, 180
 inserting, 16–17
 life, 197
 storage, v
 Blur, reducing, 30. *See also* mirror shock
 Bulb. *See* long time exposures
 Bracketing, 87–93. *See also* exposure compensation; flash exposure compensation; bracketing; white balance; bracketing
 Brightness. *See* **LCD Brightness**

C

CCD, 2, 186–187
 cleaning, 186–187
 Clock-calendar, 19
 Closest subject priority, 67–69
Color Mode, 142
 Color space. *See* **Color Mode**

Color temperature. *See* white balance
 CompactFlash. *See* memory card
 Computer, 169–174
 Continuous shooting mode, 41–42
 Contrast. *See* **Tone Comp.**
 CPU lenses, 20–21, 176–178
 Custom Settings, 144–160
 defaults, 145
 menu banks, 146
 CSM. *See* Custom Settings; CSM menu
 CSM menu, 144–160

D

Date, 19
Delete, 124–125
 Deleting, 35, 116, 124–125.
 See also memory card, formatting
 all images, 125
 playback menu, 124–125
 selected images, 124–125
 single-frame playback, 35
 Depth-of-field preview, 76
 Digital Print Order Format, 131
 Dipoter, 30
 DPOF. *See* Digital Printer Order Format
 D-TTL flash control, 94–95, 158

E

Electronic analog exposure display, 82–83
 Electronic range finder, 74
 Exif version2.2, 131
 Exposure bracketing, 87–93
 Exposure compensation, 86
 Exposure meter, 75. *See also* auto meter off
 Exposure mode, 76–83
 aperture-priority auto, 81
 auto multi program, 77–78
 manual, 82–83
 shutter-priority auto, 79–80

F

FINE. *See* **Image Quality**
 Flash, 94–107
 range, 100
 Flash exposure compensation, 102
 bracketing, 87–93
 Flash-ready indicator, 99
 Flash sync mode, 96–99
 front-curtain sync, 96
 rear-curtain sync, 96
 red-eye reduction, 96–97
 slow sync, 96
 Flexible program, 78. *See also* exposure mode, auto multi program
 Focal plane mark, 4, 74
 Focus. *See* autofocus; focus mode; manual focus
 Focus area (focus brackets), 64–96
 Focus lock, 70–71
 Focus mode, 63–69
 Focusing screen display, 10–11
Folder Designate, 126–127
 Folders, 114, 126–127
Format, 162. *See also* memory card, formatting

G

Grid. *See* on-demand grid lines

H

High Image, 130
 Highlight display, 115, 134
 Histogram, 115, 134
Hue Adjustment, 143

I

Illuminator. *See* backlight, control panel
 Image files, 43–47
 Image size. *See* **Resolution**
Image Quality, 43–46
Image Sharpening, 58
ISO, 48–49. *See also* sensitivity
 ISO auto, 148

- J**
JPEG, 44
- L**
L. See **Resolution**
Language, 18
LCD Brightness, 163
Lens, 176–179
 attaching, 20–21
 compatible, 176–178
 CPU, 20–21, 176–178
 non-CPU, 21, 176–177
 type D, 20, 177–178
 type G, 20–21, 177–178
Long time-exposures, 83
- M**
M. See exposure mode, manual;
 manual focus; **Resolution**
Manual focus, 74
Memory buffer, 41–42
Memory card, 22–24
 approved, 183
 formatting, 23, 162
Metering, 75
 3D matrix, 75
 centerweighted, 75
 matrix, 75
 spot, 75
 ten-segment, 75
Microdrive. See memory card
Mirror shock, 159
Monitor, v, 135, 185
 auto off, 151
 cover, 15
Monitor pre-flashes, 95
Multi Sensor Balanced Fill-Flash
 for Digital SLR, 95
- N**
NEF, 44–46
Nikon Capture 3, 170–171
Nikon View 5, 169
Noise, 83, 149
 Noise reduction, 149
NORMAL. See **Image Quality**
- O**
On-demand grid lines, 11, 157
- P**
Playback, 35–36, 112–120
Playback menu, 124–134
PRE. See white balance, preset
Predictive focus tracking, 66
Print Set, 131
Protecting images, 191
- R**
RAW, 44–46. See also **Image Quality**; NEF
Red-eye reduction, 96
Resolution, 46–47, 137
RGB-TIFF. See **Image Quality**
- S**
S. See autofocus, single-servo;
 exposure mode, shutter-pri-
 ority auto; **Resolution**
Self-portraits. See self-timer
Self-timer, 108–109
Sensitivity, 48–49. See also **ISO**
Sequential file numbering, 150
Setup menu, 161–166
Shutter speed, 76–83
 and flash synchronization, 99
Shooting menu, 135–143
 banks, 35
Shooting mode, 41–42
Single-frame playback, 35–36,
 112–115
Single-frame shooting mode,
 41
Size. See **Resolution**
Slide Show, 128–129
Speedlight, 94–107. See also
 flash
 built-in, 98–101
 optional, 103–107
sRGB. See **Color Mode**
- T**
Television, 168
TIFF, 44
Time. See **Date**
Time exposures. See long time-
 exposures
Thumbnail playback, 116–117
Tone Comp., 141
Two-button reset, 110
- V**
Vari-Brite focus areas, 11
Video-cassette recorder, 168
VIDEO OUT, 168
Video Output, 164
Viewfinder, 30–31
 focus. See diopter
- W**
White balance, 50–57
 bracketing, 90–93
 fine-tuning, 53–54
 preset, 55–57

Nikon

NIKON CORPORATION
Fuji Bldg., 2-3 Marunouchi 3-chome,
Chiyoda-ku, Tokyo 100-8331, Japan

Printed in Japan
S2F01000201(11)
6MBA0111-02