

SECTION **LAN**  
LAN SYSTEM

A  
B  
C  
D  
E  
F  
G  
H  
I  
J  
L  
M

CONTENTS

<b>CAN FUNDAMENTAL</b>	<b>CAN</b>
<b>PRECAUTIONS</b> .....	<b>INDEX FOR DTC</b> .....
Precautions When Using CONSULT-II .....	DTC No. Index .....
Precautions for Trouble Diagnosis .....	<b>HOW TO USE THIS SECTION</b> .....
Precautions for Harness Repair .....	Caution .....
<b>SYSTEM DESCRIPTION</b> .....	Abbreviation List .....
CAN Communication System .....	<b>PRECAUTIONS</b> .....
SYSTEM DIAGRAM .....	Precautions for Supplemental Restraint System
CAN COMMUNICATION CONTROL CIRCUIT.....	(SRS) "AIR BAG" and "SEAT BELT PRE-TEN-
Diag on CAN .....	SIONER" .....
DESCRIPTION .....	Precautions When Using CONSULT-II .....
SYSTEM DIAGRAM .....	Precautions for Trouble Diagnosis .....
<b>TROUBLE DIAGNOSIS</b> .....	Precautions for Harness Repair .....
Condition of Error Detection .....	<b>TROUBLE DIAGNOSIS</b> .....
CAN COMMUNICATION SYSTEM ERROR .....	CAN Diagnostic Support Monitor .....
WHEN INDICATED "U1000" OR "U1001" IS INDI-	MONITOR ITEM LIST (CONSULT-II) .....
CATED EVEN THOUGH CAN COMMUNICA-	CAN System Specification Chart .....
TION SYSTEM IS NORMAL .....	VEHICLE EQUIPMENT IDENTIFICATION
Symptom When Error Occurs in CAN Communi-	INFORMATION .....
cation System .....	CAN Communication Signal Chart .....
ERROR EXAMPLE .....	TYPE 1 .....
Self-Diagnosis .....	TYPE 2 .....
CAN Diagnostic Support Monitor .....	TYPE 3/TYPE 4 .....
MONITOR ITEM (CONSULT-II) .....	TYPE 5/TYPE 6 .....
MONITOR ITEM (ON-BOARD DIAGNOSIS) .....	Schematic .....
<b>TROUBLE DIAGNOSES WORK FLOW</b> .....	Wiring Diagram — CAN — .....
Information Needed for Trouble Diagnosis .....	Interview Sheet .....
How to Use CAN Communication Signal Chart ....	Data Sheet .....
Trouble Diagnosis Flow Chart .....	CONSULT-II DATA ATTACHMENT SHEET .....
Trouble Diagnosis Procedure .....	CAN System (Type 1) .....
INTERVIEW WITH CUSTOMER .....	DIAGNOSIS SHEET .....
INSPECTION OF VEHICLE CONDITION .....	CAN System (Type 2) .....
CHECK OF CAN SYSTEM TYPE (HOW TO USE	DIAGNOSIS SHEET .....
CAN SYSTEM TYPE SPECIFICATION CHART)..	CAN System (Type 3) .....
CREATE INTERVIEW SHEET .....	DIAGNOSIS SHEET .....
CREATE DATA SHEET .....	CAN System (Type 4) .....
CREATE DIAGNOSIS SHEET .....	DIAGNOSIS SHEET .....
DETECT THE ROOT CAUSE .....	CAN System (Type 5) .....
	DIAGNOSIS SHEET .....
	CAN System (Type 6) .....
	DIAGNOSIS SHEET .....

LAN

DIAGNOSIS SHEET .....	67	TCM Branch Line Circuit .....	73
Component Parts Location .....	68	Transfer Control Unit Branch Line Circuit .....	73
Harness Layout .....	68	BCM Branch Line Circuit .....	74
Malfunction Area Chart .....	69	Differential Lock Control Unit Branch Line Circuit ...	75
MAIN LINE .....	69	Data Link Connector Branch Line Circuit .....	75
BRANCH LINE .....	69	Combination Meter Branch Line Circuit .....	76
SHORT CIRCUIT .....	69	Steering Angle Sensor Branch Line Circuit .....	77
Main Line Between TCM and Data Link Connector..	70	ABS Actuator and Electric Unit (Control Unit) Branch	
Main Line Between Data Link Connector and ABS		Line Circuit .....	77
Actuator and Electric Unit .....	71	IPDM E/R Branch Line Circuit .....	78
ECM Branch Line Circuit .....	72	CAN Communication Circuit .....	79

**PRECAUTIONS**

PFP:00001

**Precautions When Using CONSULT-II**

UKS006FG

Use CONSULT-II CONVERTER when connecting CONSULT-II to data link connector.

**CAUTION:**

CAN communication does not function properly if CONSULT-II is used without connecting CONSULT-II CONVERTER.

**Precautions for Trouble Diagnosis**

UKS006FH

**CAUTION:**

- Never apply 7.0 V or more to the measurement terminal.
- Use a tester with open terminal voltage of 7.0 V or less.
- Turn the ignition switch OFF and disconnect the battery cable from the negative terminal when checking the harness.

**Precautions for Harness Repair**

UKS006FI

- Solder the repaired area and wrap tape around the soldered area.

**NOTE:**

A fray of twisted lines must be within 110 mm (4.33 in).

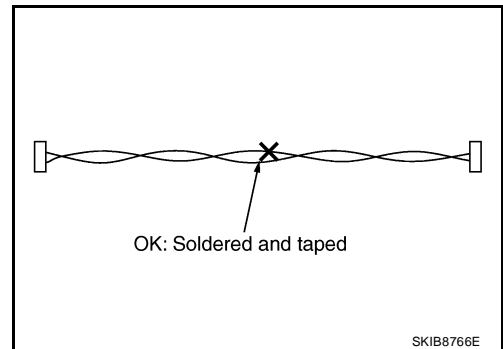

- Bypass connection is never allowed at the repaired area.

**NOTE:**

Bypass connection may cause CAN communication error. The spliced wire becomes separated and the characteristics of twisted line are lost.

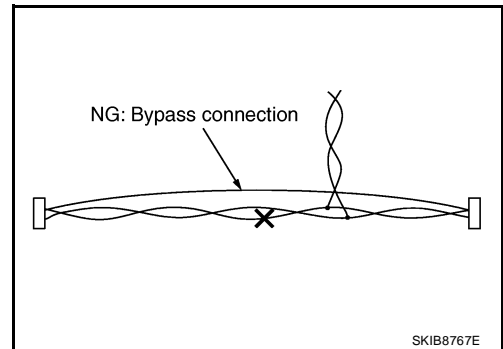

- Replace the applicable harness as an assembly if error is detected on the shield lines of CAN communication line.

A  
B  
C  
D  
E  
F  
G  
H  
I  
J  
LAN  
L  
M

### SYSTEM DESCRIPTION

PFP:00000

### CAN Communication System

UKS006FJ

- CAN communication is a multiplex communication system. This enables the system to transmit and receive large quantities of data at high speed by connecting control units with two communication lines (CAN-H and CAN-L).
- Control units on the CAN network transmit signals using the CAN communication control circuit. They receive only necessary signals from other control units to operate various functions.
- CAN communication lines adopt twisted-pair line style (two lines twisted) for noise immunity.

### SYSTEM DIAGRAM

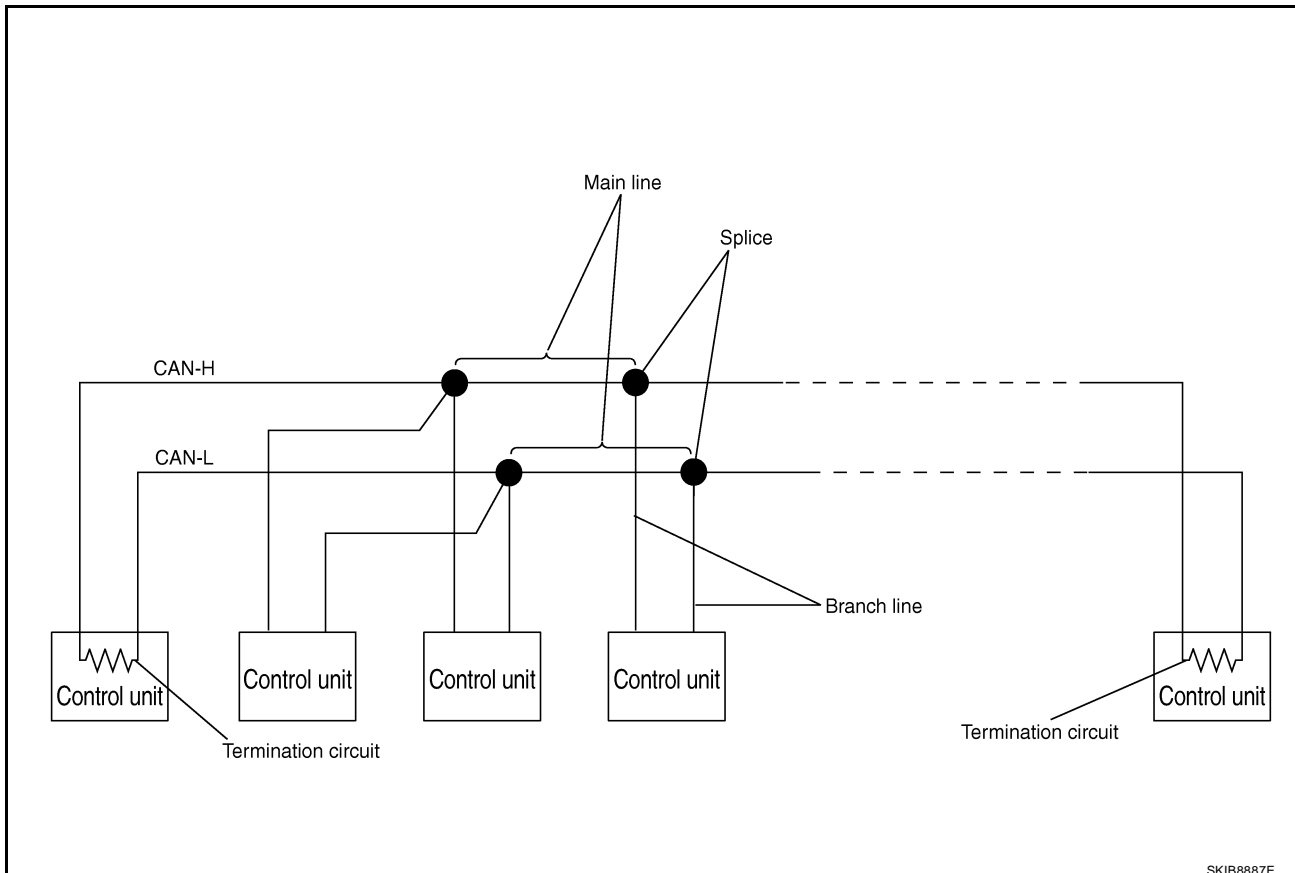

Each control unit passes an electric current to the termination circuits when transmitting CAN communication signal. The termination circuits produce an electrical potential difference between CAN-H and CAN-L. CAN communication system transmits and receives CAN communication signals by the potential difference.

Component	Description
Main line	CAN communication line between splices
Branch line	CAN communication line between splice and a control unit
Splice	A point connecting a branch line with a main line
Termination circuit	Refer to <a href="#">LAN-5, "CAN COMMUNICATION CONTROL CIRCUIT"</a> .

CAN COMMUNICATION CONTROL CIRCUIT

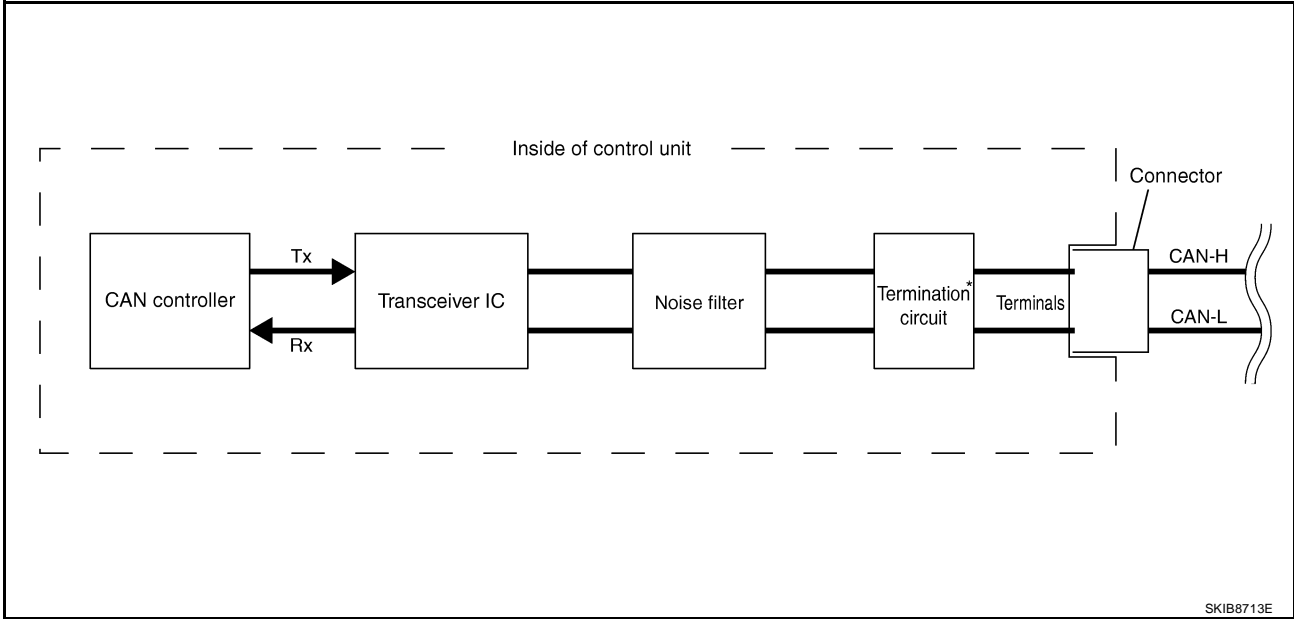

Component	System description
CAN controller	It controls CAN communication signal transmission and reception, error detection, etc.
Transceiver IC	It converts digital signal into CAN communication signal, and CAN communication signal into digital signal.
Noise filter	It eliminates noise of CAN communication signal.
Termination circuit* (Resistance of approx. 120 Ω)	It produces potential difference.

\*: These are the only control units wired with both ends of CAN communication system.

A  
B  
C  
D  
E  
F  
G  
H  
I  
J  
L  
M

LAN

### Diag on CAN DESCRIPTION

“Diag on CAN” is a diagnosis using CAN communication instead of previous DDL1 and DDL2 communication line, between control unit and diagnosis unit.

### SYSTEM DIAGRAM

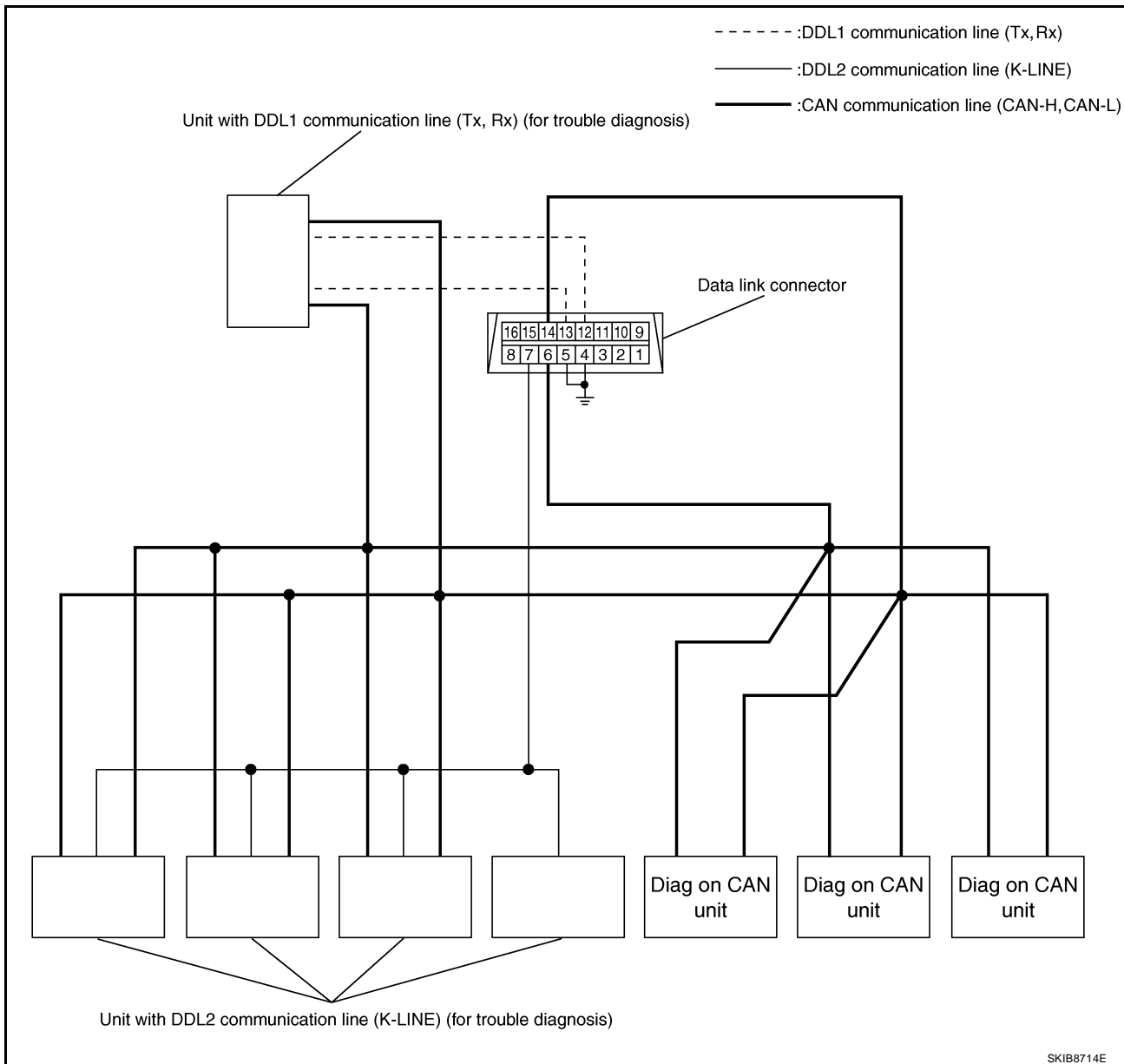

Name	Harness	Description
DDL1	Tx Rx	It is used for trouble diagnosis. (CAN-H and CAN-L are used for controlling)
DDL2	K-LINE	It is used for trouble diagnosis. (CAN-H and CAN-L are used for controlling)
Diag on CAN	CAN-H CAN-L	It is used for trouble diagnosis and control.

**TROUBLE DIAGNOSIS**

PFP:00004

**Condition of Error Detection**

UKS006FL

“U1000” or “U1001” is indicated on SELF-DIAG RESULTS on CONSULT-II if CAN communication signal is not transmitted or received between units for 2 seconds or more.

**CAN COMMUNICATION SYSTEM ERROR**

- CAN communication line open (CAN-H, CAN-L, or both)
- CAN communication line short (ground, between CAN communication lines, other harnesses)
- Error of CAN communication control circuit of the unit connected to CAN communication line

**WHEN INDICATED “U1000” OR “U1001” IS INDICATED EVEN THOUGH CAN COMMUNICATION SYSTEM IS NORMAL**

- CONSULT-II CONVERTER not connected: Error may be detected by the self-diagnosis when not using CONSULT-II CONVERTER (Depending on the control unit which carries out CAN communication).
- Removal/installation of parts: Error may be detected when removing and installing CAN communication unit and related parts while turning the ignition switch ON. (A DTC except for CAN communication may be detected.)
- Fuse blown out (removed): CAN communication of the unit may cease.
- Voltage drop: Error may be detected if voltage drops due to discharged battery when turning the ignition switch ON (Depending on the control unit which carries out CAN communication).
- Error may be detected if the power supply circuit of the control unit, which carries out CAN communication, malfunctions (Depending on the control unit which carries out CAN communication).
- Error may be detected if reprogramming is not completed normally.

**NOTE:**

CAN communication system is normal if “U1000” or “U1001” is indicated on SELF-DIAG RESULTS of CONSULT-II under the above conditions. Erase the memory of the self-diagnosis of each unit.

A

B

C

D

E

F

G

H

I

J

LAN

L

M

### Symptom When Error Occurs in CAN Communication System

In CAN communication system, multiple units mutually transmit and receive signals. Each unit cannot transmit and receive signals if any error occurs on CAN communication line. Under this condition, multiple control units related to the root cause malfunction or go into fail-safe mode.

#### ERROR EXAMPLE

##### NOTE:

- Each vehicle differs in symptom of each unit under fail-safe mode and CAN communication line wiring.
- Refer to [LAN-41, "Abbreviation List"](#) for the unit abbreviation.

#### Example: TCM branch line open circuit

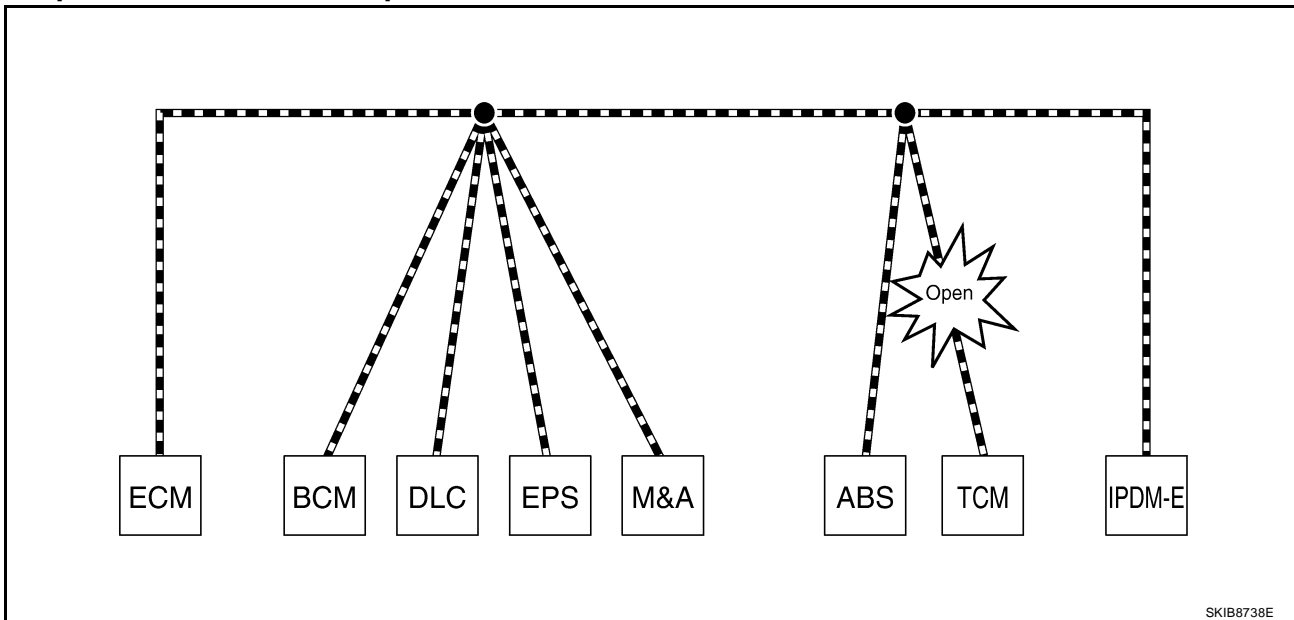

Unit name	Symptom
ECM	Engine torque limiting is affected, and shift harshness increases.
BCM	Reverse warning chime does not sound.
EPS control unit	Normal operation.
Combination meter	<ul style="list-style-type: none"> <li>● Shift position indicator and OD OFF indicator turn OFF.</li> <li>● Warning lamps turn ON.</li> </ul>
ABS actuator and electric unit (control unit)	Normal operation.
TCM	No impact on operation.
IPDM E/R	Normal operation.



### Example: Data link connector branch line open circuit

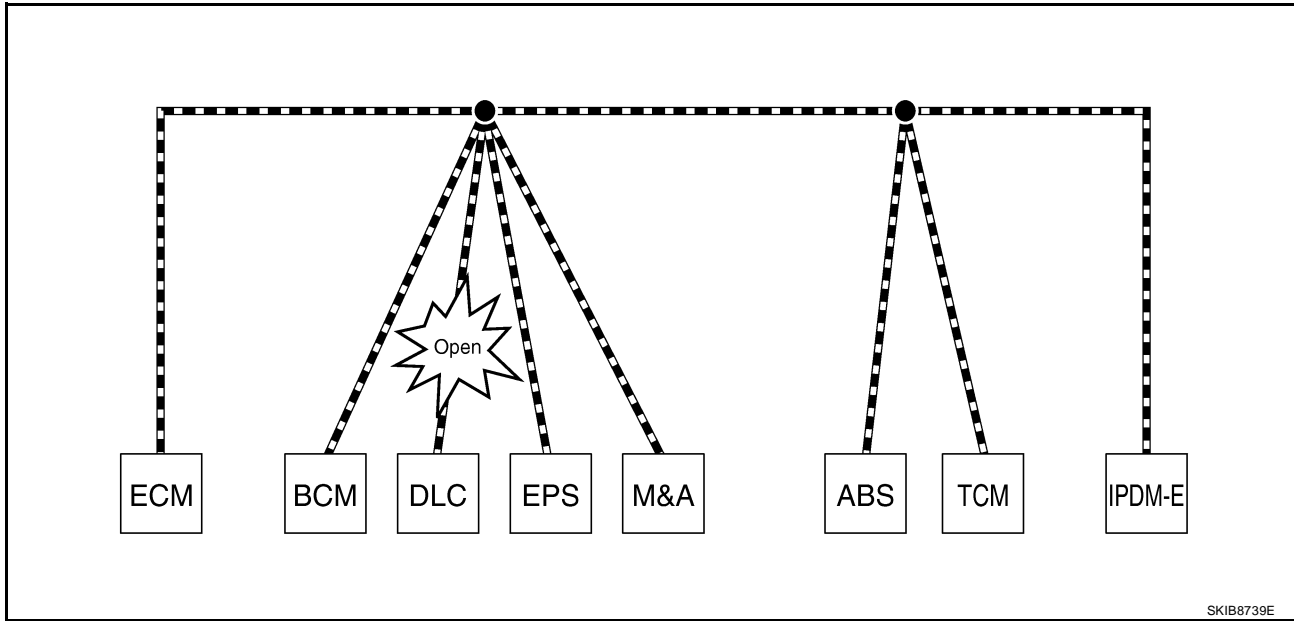

Unit name	Symptom
ECM	Normal operation.
BCM	
EPS control unit	
Combination meter	
ABS actuator and electric unit (control unit)	
TCM	
IPDM E/R	

**NOTE:**

- When data link connector branch line is open, transmission and reception of CAN communication signals is not affected. Therefore, no symptoms occur. However, be sure to repair malfunctioning circuit.
- When data link connector branch line is open, the screen-display of the CONSULT-II "SELECT SYSTEM" screen may be the same as when the CAN communication line has short-circuit. However, symptoms differ depending on the case. See below chart for the differences.

	SELECT SYSTEM (CONSULT-II)	Difference of symptom
Data link connector branch line open circuit	All Diag on CAN units are not indicated.	Normal operation.
CAN-H, CAN-L harness short-circuit		Most the units which are connected to the CAN communication system enter fail-safe mode or are deactivated.

A  
B  
C  
D  
E  
F  
G  
H  
I  
J  
L  
M

LAN

# TROUBLE DIAGNOSIS

[CAN FUNDAMENTAL]

**Example: Main Line Between Data Link Connector and ABS Actuator and Electric Unit (Control Unit) Open Circuit**

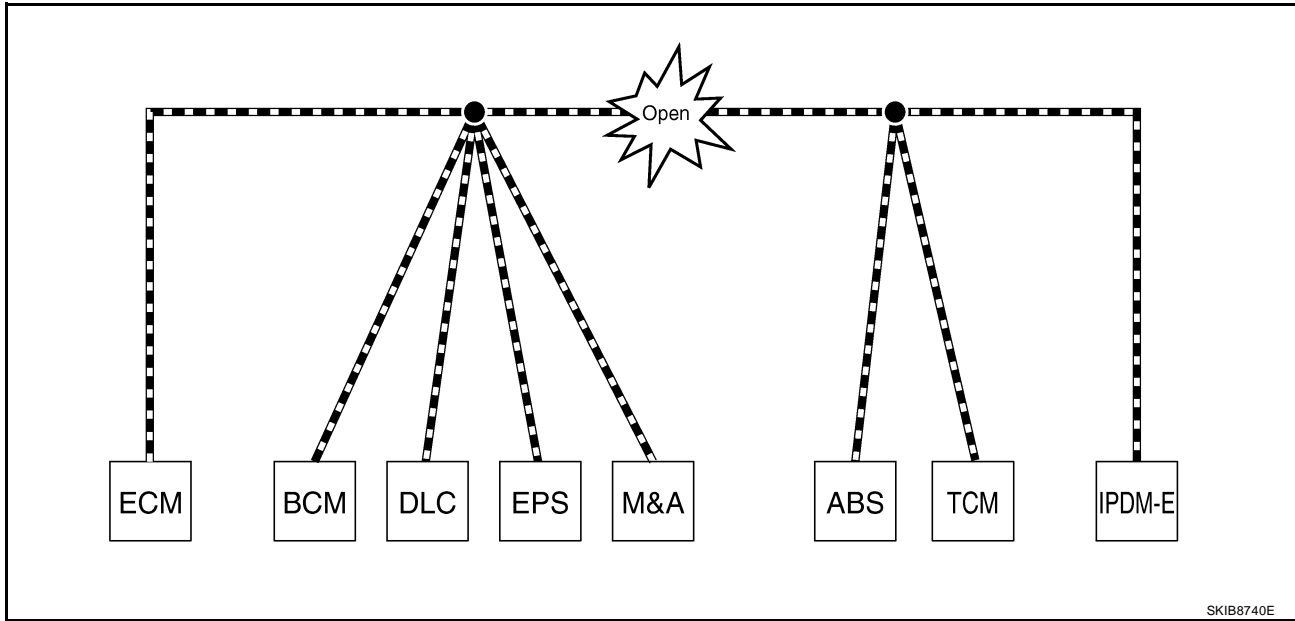

Unit name	Symptom
ECM	Engine torque limiting is affected, and shift harshness increases.
BCM	<ul style="list-style-type: none"> <li>● Reverse warning chime does not sound.</li> <li>● The front wiper moves under continuous operation mode even though the front wiper switch being in the intermittent position.</li> </ul>
EPS control unit	The steering effort increases.
Combination meter	<ul style="list-style-type: none"> <li>● The shift position indicator and OD OFF indicator turn OFF.</li> <li>● The speedometer is inoperative.</li> <li>● The odo/trip meter stops.</li> </ul>
ABS actuator and electric unit (control unit)	Normal operation.
TCM	No impact on operation.
IPDM E/R	When the ignition switch is ON, <ul style="list-style-type: none"> <li>● The headlamps (Lo) turn ON.</li> <li>● The cooling fan continues to rotate.</li> </ul>

# TROUBLE DIAGNOSIS

[CAN FUNDAMENTAL]

## Example: CAN-H, CAN-L Harness Short Circuit

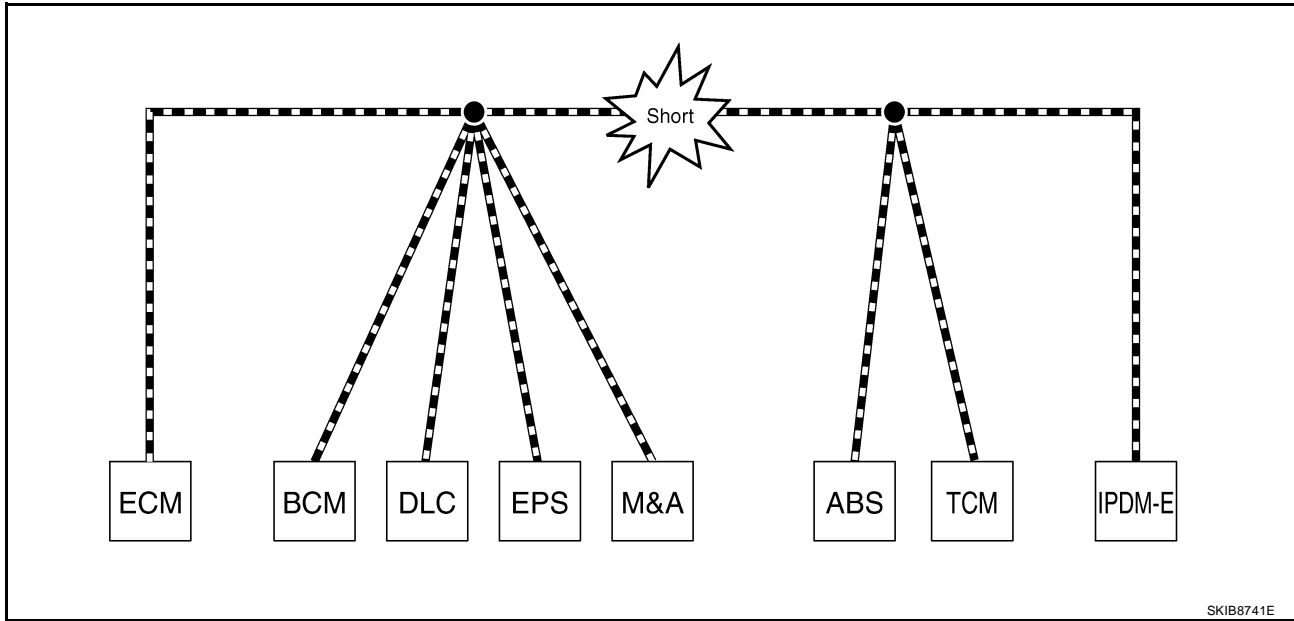

SKIB8741E

Unit name	Symptom
ECM	<ul style="list-style-type: none"> <li>● Engine torque limiting is affected, and shift harshness increases.</li> <li>● Engine speed drops.</li> </ul>
BCM	<ul style="list-style-type: none"> <li>● Reverse warning chime does not sound.</li> <li>● The front wiper moves under continuous operation mode even though the front wiper switch being in the intermittent position.</li> <li>● The room lamp does not turn ON.</li> <li>● The engine does not start (if an error or malfunction occurs while turning the ignition switch is OFF.)</li> <li>● The steering lock does not release (if an error or malfunction occurs while turning the ignition switch is OFF.)</li> </ul>
EPS control unit	The steering effort increases.
Combination meter	<ul style="list-style-type: none"> <li>● The tachometer and the speedometer do not move.</li> <li>● Warning lamps turn ON.</li> <li>● Indicator lamps do not turn ON.</li> </ul>
ABS actuator and electric unit (control unit)	Normal operation.
TCM	No impact on operation.
IPDM E/R	When the ignition switch is ON, <ul style="list-style-type: none"> <li>● The headlamps (Lo) turn ON.</li> <li>● The cooling fan continues to rotate.</li> </ul>

A  
B  
C  
D  
E  
F  
G  
H  
I  
J  
L  
M

LAN

# TROUBLE DIAGNOSIS

[CAN FUNDAMENTAL]

## Self-Diagnosis

UKS006FN

DTC	Self-diagnosis item (CONSULT-II indication)	DTC detection condition	Inspection/Action
U1000	CAN COMM CIRCUIT	When ECM is not transmitting or receiving CAN communication signal of OBD (emission-related diagnosis) for 2 seconds or more.	Refer to <a href="#">LAN-15</a> . <a href="#">"TROUBLE DIAG- NOSES WORK FLOW"</a> .
		When a control unit (except for ECM) is not transmitting or receiving CAN communication signal for 2 seconds or more.	
U1001	CAN COMM CIRCUIT	When ECM is not transmitting or receiving CAN communication signal other than OBD (emission-related diagnosis) for 2 seconds or more.	
U1002	SYSTEM COMM	When a control unit is not transmitting or receiving CAN communication signal for 2 seconds or less.	Start the inspection. Refer to the applicable section of the indicated control unit.
U1010	CONTROL UNIT [CAN]	When an error is detected during the initial diagnosis for CAN controller of each control unit.	Replace the control unit indicating "U1010".

**CAN Diagnostic Support Monitor**

CONSULT-II and CAN diagnostic support monitor (on-board diagnosis function) are used for detecting root cause.

**MONITOR ITEM (CONSULT-II)**

**Example: CAN DIAG SUPPORT MNTR indication**

Without PAST			With PAST		
SYSTEM	ENGINE		SYSTEM	ENGINE	
DATE			DATE		
P/#			P/#		
	PRSNT			PRSNT	PAST
INITIAL DIAG	OK		TRANSMIT DIAG	OK	OK
TRANSMIT DIAG	OK		VDC/TCS/ABS	-	-
TCM	OK		METER/M&A	OK	OK
VDC/TCS/ABS	UNKWN		BCM/SEC	OK	OK
METER/M&A	OK		ICC	-	-
ICC	UNKWN		HVAC	-	-
BCM/SEC	OK		TCM	OK	OK
IPDM E/R	OK		EPS	-	-
			IPDM E/R	OK	OK
			e4WD	-	-
			AWD/4WD	OK	OK

SKIB8742E

**Without PAST**

Item	PRSNT	Description
Initial diagnosis	OK	Normal at present
	NG	Control unit error (Except for some control units)
Transmission diagnosis	OK	Normal at present
	UNKWN	Unable to transmit signals for 2 seconds or more. Diagnosis not performed
Control unit name (Reception diagnosis)	OK	Normal at present
	UNKWN	Unable to receive signals for 2 seconds or more. Diagnosis not performed
		No control unit for receiving signals. (No applicable optional parts)

**With PAST**

Item	PRSNT	PAST	Description
Transmission diagnosis	OK	OK	Normal at present and in the past
		1 – 39	Normal at present, but unable to transmit signals for 2 seconds or more in the past. (The number indicates the number of ignition switch cycles from OFF to ON.)
	UNKWN	0	Unable to transmit signals for 2 seconds or more at present.
Control unit name (Reception diagnosis)	OK	OK	Normal at present and in the past
		1 – 39	Normal at present, but unable to receive signals for 2 seconds or more in the past. (The number indicates the number of ignition switch cycles from OFF to ON.)
	UNKWN	0	Unable to receive signals for 2 seconds or more at present
	-	-	Diagnosis not performed. No control unit for receiving signals. (No applicable optional parts)

# TROUBLE DIAGNOSIS

**[CAN FUNDAMENTAL]**

## MONITOR ITEM (ON-BOARD DIAGNOSIS)

**NOTE:**

For some models, CAN communication diagnosis result is received from the vehicle monitor. (CONSULT-II is not available.)

**Example: Vehicle Display**

Item	Result indicated	Error counter	Description
CAN_COMM (Initial diagnosis)	OK	0	Normal at present
	NG	1 – 50	Control unit error (The number indicates how many times diagnosis has been run.)
CAN_CIRC_1 (Transmission diagnosis)	OK	0	Normal at present
	UNKWN	1 – 50	Unable to transmit for 2 seconds or more at present. (The number indicates how many times diagnosis has been run.)
CAN_CIRC_2 – 9 (Reception diagnosis of each unit)	OK	0	Normal at present
	UNKWN	1 – 50	Unable to transmit for 2 seconds or more at present. (The number indicates how many times diagnosis has been run.)
			Diagnosis not performed.
			No control unit for receiving signals. (No applicable optional parts)

### TROUBLE DIAGNOSES WORK FLOW

PFP:00004

#### Information Needed for Trouble Diagnosis

UKS006FP

CAN communication system performs trouble diagnosis with the following tools.

Tool	Usage
Interview sheet	For filling in vehicle information and interview with customer.
Data sheet	For attaching CONSULT-II data or on-board diagnosis data.
Diagnosis sheet	For detecting the root cause. (Diagnosis sheet includes system diagram for every CAN system type)
SELECT SYSTEM (CONSULT-II)	For checking the condition of control units and the status of CAN communication.
SELF-DIAG RESULTS (CONSULT-II)	
CAN DIAG SUPPORT MNTR (CONSULT-II)	
CAN communication signal chart	For converting information received from a customer into CAN communication signal transmission and reception. This information can be used to judge whether a circuit between control units is normal or abnormal.
Abbreviation list	For checking abbreviations in CAN communication signal chart and diagnosis sheet.

#### How to Use CAN Communication Signal Chart

UKS006FQ

The CAN communication signal chart lists the signals needed for trouble diagnosis. It is useful for detecting the root cause by finding a signal related to the symptom, and by checking transmission and reception unit.

Example: Tachometer does not move even though the engine rotates.

T: Transmit R: Receive

Signal name/Connecting unit	ECM	BCM	M&A	STRG	ABS	IPDM-E
A/C compressor feedback signal	T		R			
A/C compressor request signal	T					R
Accelerator pedal position signal	T				R	
Cooling fan motor operation signal	T					R
Engine coolant temperature signal	T		R			
Engine speed signal	T		R		R	
Fuel consumption monitor signal	T		R			
Malfunction indicator lamp signal	T		R			
A/C switch signal	R	T				
Ignition switch signal		T				R
Sleep/wake up signal		T	R			R

It indicates that an error occurs between ECM and M&A (Shaded area).

SKIB8715E

### Trouble Diagnosis Flow Chart

UKS006FR

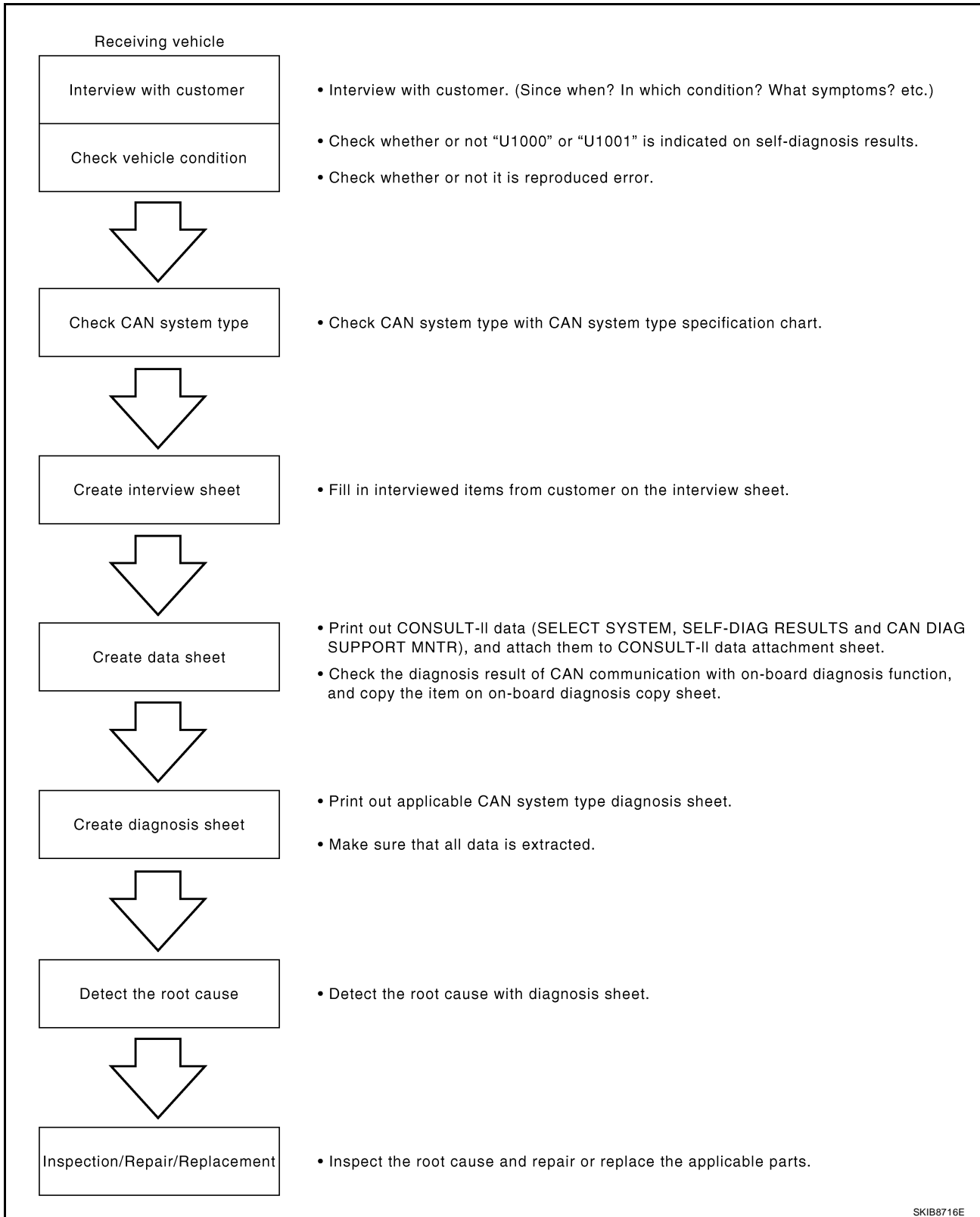

SKIB8716E



## Trouble Diagnosis Procedure

### INTERVIEW WITH CUSTOMER

Interview with the customer is important to detect the root cause of CAN communication system errors and to understand vehicle condition and symptoms for proper trouble diagnosis.

Points in interview

- What: Parts name, system name
- When: Date, Frequency
- Where: Road condition, Place
- In what condition: Driving condition/environment
- Result: Symptom

#### NOTE:

- Check normal units as well as error symptoms.
- Example: Circuit between ECM and the combination meter is judged normal if the customer indicates tachometer functions normally.
- When a CAN communication system error is present, multiple control units may malfunction or go into fail-safe mode.
- Indication of the combination meter is important to detect the root cause because it is the most obvious from the customer, and it performs CAN communication with many units.

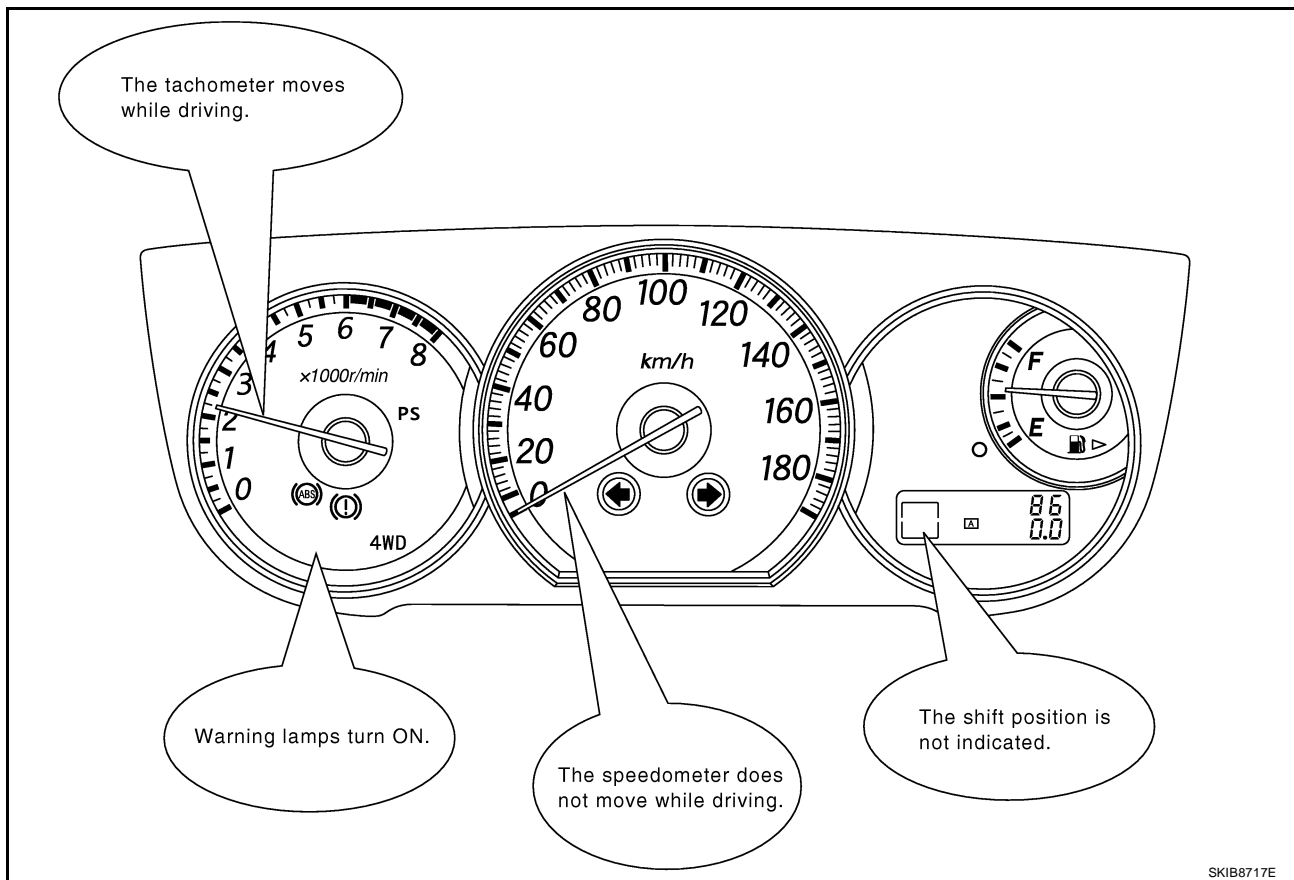

### INSPECTION OF VEHICLE CONDITION

- Check whether or not “U1000” or “U1001” is indicated on “SELF-DIAG RESULTS” by CONSULT-II.

**NOTE:**

Root cause cannot be detected using the procedure in this section if “U1000” or “U1001” is not indicated.

- Check whether the symptom is reproduced or not.

**NOTE:**

- Never turn the ignition switch OFF or disconnect the battery cable while the reproducing the error. The error may temporarily correct itself, making it difficult to determine the root cause.
- The procedures for present errors differ from the procedures for past errors. Refer to [LAN-25](#).  
"DETECT THE ROOT CAUSE".

# TROUBLE DIAGNOSES WORK FLOW

[CAN FUNDAMENTAL]

## CHECK OF CAN SYSTEM TYPE (HOW TO USE CAN SYSTEM TYPE SPECIFICATION CHART)

Determine CAN system type based on vehicle equipment. Then choose the correct diagnosis sheet.

**NOTE:**

There are two styles for CAN system type specification charts. Depending on the number of available system types, either style A or style B may be used.

### CAN System Type Specification Chart (Style A)

**NOTE:**

CAN system type is easily checked with the vehicle equipment identification information shown in the chart.

Example:

Vehicle is equipped as follows: Wagon, AWD, VQ35DE, CVT, VDC, and Intelligent Key system. (○ shows an example of CAN system type.)

**CAN System Specification Chart**

Determine CAN system type from the following specification chart. Then choose the correct diagnosis sheet.

Body type	Wagon					
Axle	2WD			AWD		
Engine	QR25DE		VQ35DE			
Transmission	A/T		CVT			
Brake control	ABS			VDC		
Intelligent Key system		X		X		X
CAN system type	1	2	3	4	5	6
Diagnosis sheet	(XX-XX)	(XX-XX)	(XX-XX)	(XX-XX)	(XX-XX)	(XX-XX)
CAN communication signal chart	XX-XX. "TYPE 1/TYPE 2"		XX-XX. "TYPE 3/TYPE 4"		XX-XX. "TYPE 5/TYPE 6"	

X : Applicable

Check the vehicle equipment with the vehicle identification number plate.

Check the vehicle equipment.

The number indicates the CAN system type of the vehicle.

**VEHICLE EQUIPMENT IDENTIFICATION INFORMATION**

**NOTE:**

Check CAN system type from the vehicle shape and equipment.

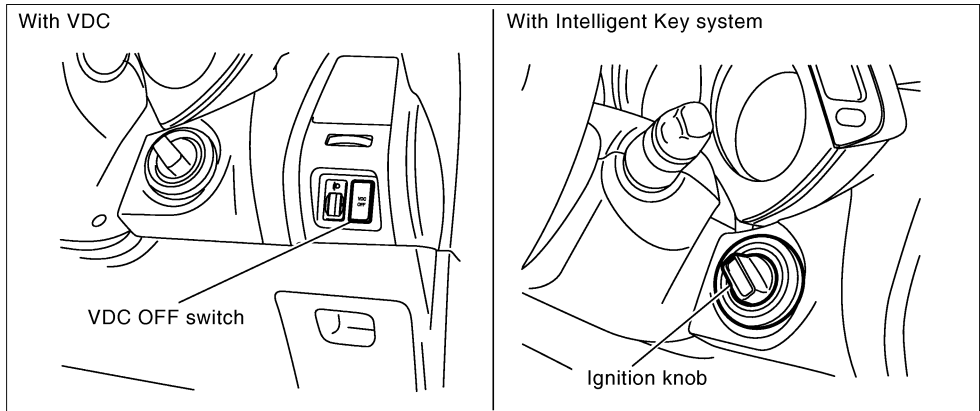

- In the above example,
  - Checking VDC OFF switch leads to judge whether or not VDC is equipped.
  - Checking the ignition knob leads to judge whether or not Intelligent Key system is equipped.

For the above case, CAN system type is "6".

SKIB8888E

### CAN System Type Specification Chart (Style B)

**NOTE:**

CAN system type is easily checked with the vehicle equipment identification information shown in the chart.

Example:

Vehicle is equipped as follows: Sedan, 2WD, MR20DE, CVT, ABS, Active AFS, Intelligent Key system, Navigation system and Automatic drive positioner. (○ shows an example of CAN system type.)

**CAN System Specification Chart**

Refer to the specification as shown in the chart.

Body type	Sedan		
Axle	2WD		AWD
Engine	HR15DE	MR20DE	HR15DE
Transmission	A/T	CVT	A/T
Brake control	ABS		
Specification chart	AAA SPECIFICATION CHART A	YYY SPECIFICATION CHART B	AAA SPECIFICATION CHART C

Check the vehicle equipment with the vehicle identification number plate.

Check the vehicle equipment.

Select the applicable vehicle equipment. Refer to the specification chart.

x: Applicable

**SPECIFICATION CHART B**

Determine CAN system type from the following specification chart. Then choose the correct diagnosis sheet.

Body type	Sedan												
Axle	2WD												
Engine	MR20DE												
Transmission	CVT												
Brake control	ABS												
Active AFS		x			x	x			x	x	x	x	x
Intelligent Key system			x		x		x	x	x	x	x	x	x
Navigation system				x		x	x		x			x	
Automatic drive positioner								x			x	x	
CAN system type	9	10	11	12	13	14	15	16	17	18	19	20	
Diagnosis sheet	AA: XX	AA: XX	AA: XX	AA: XX	AA: XX	AA: XX	AA: XX	AA: XX	AA: XX	AA: XX	AA: XX	AA: XX	AA: XX
CAN communication signal chart	XX:XX TYPE 9TYPE 10TYPE 11TYPE 12TYPE 13TYPE 14TYPE 15TYPE 16TYPE 17TYPE 18TYPE 19TYPE 20												

Check the vehicle equipment.

The number indicates the CAN system type of the vehicle.

x: Applicable

**VEHICLE EQUIPMENT IDENTIFICATION INFORMATION**

**NOTE:**

Check CAN system type from the vehicle shape and equipment.

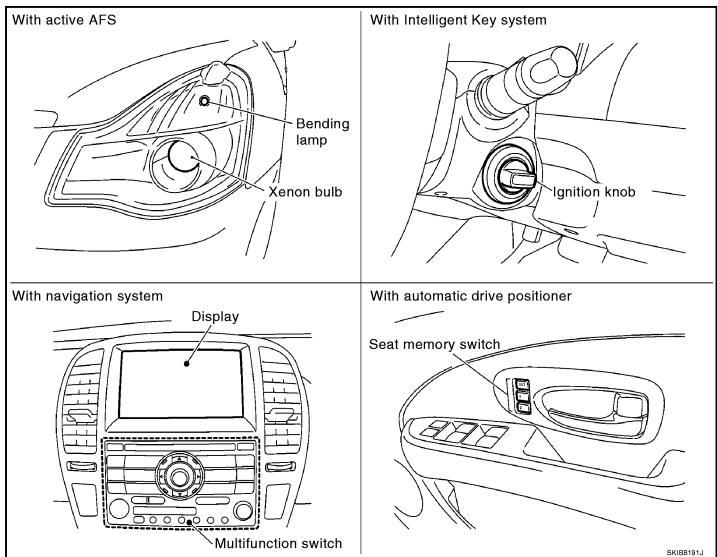

In the above example,

- Checking Xenon bulb and bending lamp lead to judge whether or not Active AFS is equipped.
- Checking the ignition knob leads to judge whether or not Intelligent Key system is equipped.
- Checking display and multifunction switch lead to judge whether or not Navigation system is equipped.
- Checking seat memory switch leads to judge whether or not Automatic drive positioner is equipped.

For the above case, CAN system type is "20".

SKIB8889E

# TROUBLE DIAGNOSES WORK FLOW

[CAN FUNDAMENTAL]

## CREATE INTERVIEW SHEET

Fill out the symptom described by the customer, vehicle condition, and CAN system type on the interview sheet.

### Interview Sheet (Example)

CAN Communication System Diagnosis Interview Sheet			
Date received:	3, Feb. 2005		
Type:	DBA-KG11	VIN No.:	KG11-005040
Model:	BDRARGZ397EDA-E-J-		
First registration:	10, Jan. 2005	Mileage:	952 km
CAN system type:	Type 19		
Symptom (Results from interview with customer)			
<ul style="list-style-type: none"><li>• Headlamps suddenly turn ON while driving the vehicle.</li><li>• The engine does not restart after stopping the vehicle and turning the ignition switch OFF.</li><li>• The cooling fan continues rotating while turning the ignition switch ON.</li></ul>			
Condition at inspection			
Error Symptom: <u>Present</u> / Past			
The engine does not start. While turning the ignition switch ON, <ul style="list-style-type: none"><li>• The headlamps (Lo) turn ON, and the cooling fan continues rotating.</li><li>• The interior lamp does not turn ON.</li></ul> On CONSULT-II screen, <ul style="list-style-type: none"><li>• IPDM E/R is not indicated on SELECT SYSTEM.</li><li>• ENGINE: U1001</li><li>• BCM, ADAPTIVE LIGHT: U1000</li></ul>			

SKIB8890E

A  
B  
C  
D  
E  
F  
G  
H  
I  
J  
LAN  
L  
M

# TROUBLE DIAGNOSES WORK FLOW

[CAN FUNDAMENTAL]

## CREATE DATA SHEET

### Create CONSULT-II Data Attachment Sheet

Print out the following CONSULT-II screens, and attach them to the CONSULT-II data attachment sheet.

- SELECT SYSTEM
- SELF-DIAG RESULTS
- CAN DIAG SUPPORT MNTR

**NOTE:**

Some items may not be needed depending on CAN system type of vehicle.

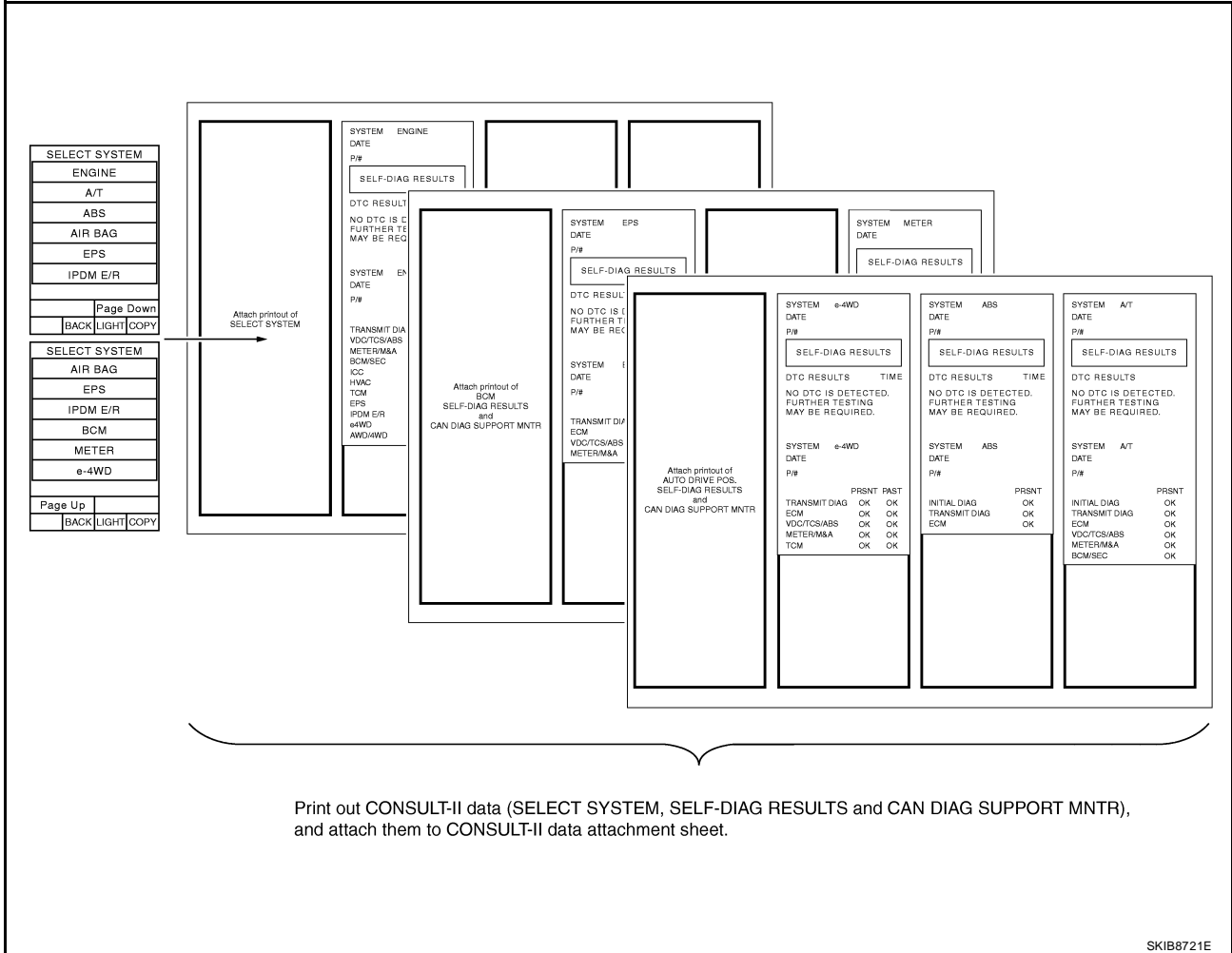

SKIB8721E

# TROUBLE DIAGNOSES WORK FLOW

[CAN FUNDAMENTAL]

## Create On-board Diagnosis Copy Sheet

Display the trouble diagnosis result of CAN communication with the on-board diagnosis function on the vehicle monitor, etc. Copy them on the on-board diagnosis copy sheet.

**NOTE:**

For some models, CAN communication diagnosis result is received from the vehicle monitor. (CONSULT-II is not available.)

Example: Copy the diagnosis result of CAN communication from the vehicle monitor.

Vehicle monitor indication

CAN DIAG SUPPORT MONITOR			
CAN_COMM	OK	0	Delete
CAN_CIRC_1	OK	0	
CAN_CIRC_2	UNKWN	12	
CAN_CIRC_3	UNKWN	12	
CAN_CIRC_4	UNKWN	0	
CAN_CIRC_5	OK	0	
CAN_CIRC_6	UNKWN	0	
CAN_CIRC_7	OK	0	
CAN_CIRC_8	UNKWN	0	
CAN_CIRC_9	UNKWN	50	

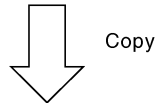

Vehicle monitor (Display control unit) CAN DIAG SUPPORT MONITOR copy sheet

Indication item (Diagnosis item)	Vehicle monitor		Indication item (Diagnosis item)	Vehicle monitor	
	Result indicated	Error counter		Result indicated	Error counter
CAN_COMM (Initial diagnosis)	<b>OK</b>	<b>0</b>	CAN_CIRC_5 (Receive diagnosis of Unified meter and A/C amp.)	<b>OK</b>	<b>0</b>
CAN_CIRC_1 (Transmit diagnosis)	<b>OK</b>	<b>0</b>	CAN_CIRC_6	Not available	
CAN_CIRC_2 (Receive diagnosis of BCM)	<b>UNKWN</b>	<b>12</b>	CAN_CIRC_7 (Receive diagnosis of IPDM E/R)	<b>OK</b>	<b>0</b>
CAN_CIRC_3 (Receive diagnosis of ECM)	<b>UNKWN</b>	<b>12</b>	CAN_CIRC_8	Not available	
CAN_CIRC_4	Not available		CAN_CIRC_9	Not available	

Result indicated: Fill in the indication (OK, NG or UNKWN).  
Error counter: Fill in the indicated number.

SKIB8722E

# TROUBLE DIAGNOSES WORK FLOW

[CAN FUNDAMENTAL]

## CREATE DIAGNOSIS SHEET

### NOTE:

Be sure to use the diagnosis sheet for the correct CAN system type.

### Print Diagnosis Sheet

Print the diagnosis sheet for the applicable CAN system type.

### Check of Received Data

Check the created data sheet for missing information.

- For abbreviations, refer to [LAN-41, "Abbreviation List"](#).

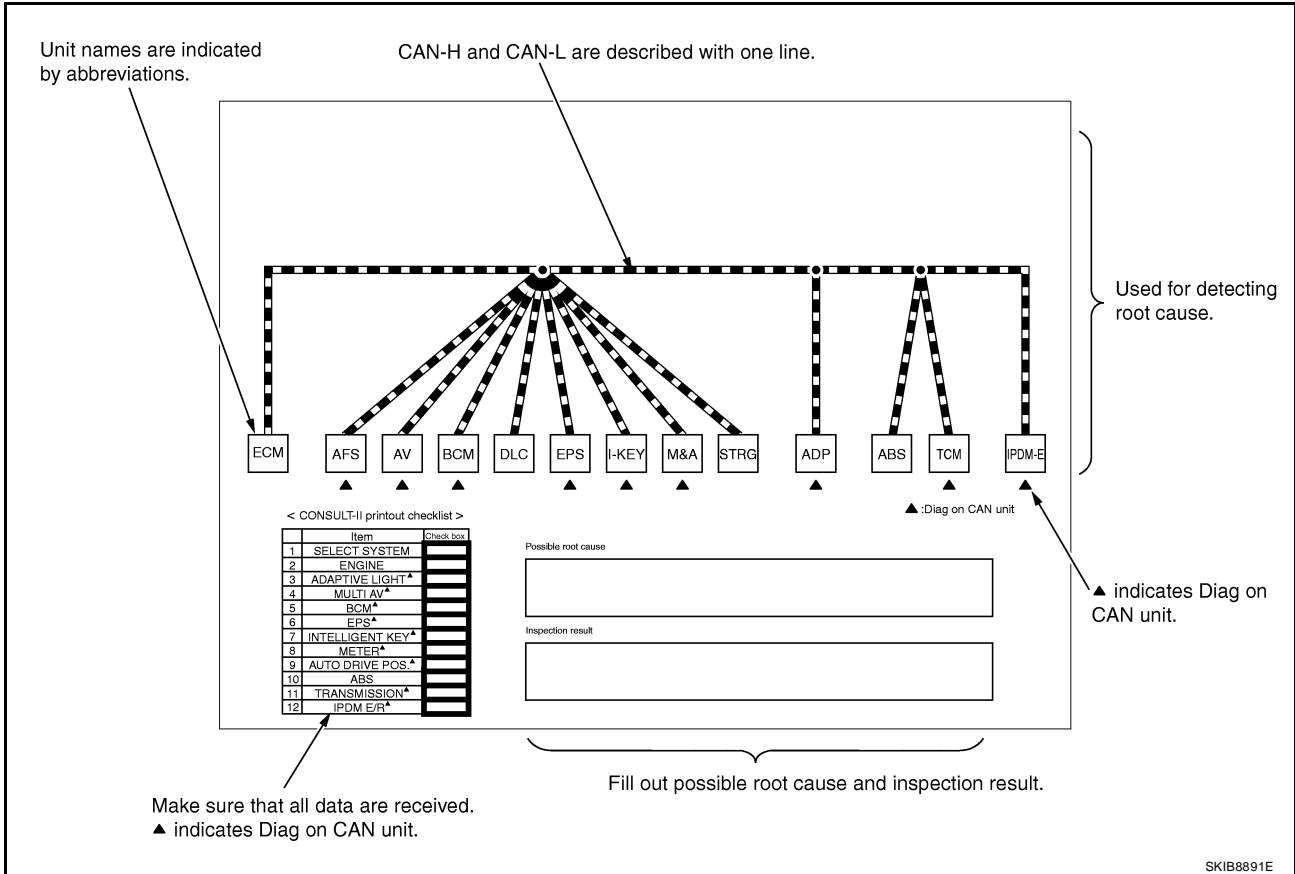

SKIB8891E



**DETECT THE ROOT CAUSE**

Identify the root cause using the created diagnosis sheet.

Identifying the root cause

- Draw a line on the diagnosis sheet to indicate the possible cause. Narrow the search.

**NOTE:**

- Color-code when drawing lines.
- Do not draw a line onto a existing line.
- Drawing a line is not necessary if the circuit is shorted. Refer to [LAN-32, "Present Error — Short Circuit —"](#) , [LAN-39, "Past Error — Short Circuit —"](#) .

Refer to the following for details of the trouble diagnosis procedure.

- [LAN-26, "Present Error — Open Circuit —"](#)
- [LAN-32, "Present Error — Short Circuit —"](#)
- [LAN-33, "Past Error — Open Circuit —"](#)
- [LAN-39, "Past Error — Short Circuit —"](#)

**NOTE:**

When the root cause appears to be a branch line or short circuit, be sure to check the control unit as well as the communication line.

A

B

C

D

E

F

G

H

I

J

LAN

L

M

# TROUBLE DIAGNOSES WORK FLOW

[CAN FUNDAMENTAL]

## Present Error — Open Circuit —

Identify the error circuit using information from the “SELECT SYSTEM” and “CAN DIAG SUPPORT MNTR” screens.

1. SELECT SYSTEM: Check the items indicated in “SELECT SYSTEM”. Draw a line on the diagnosis sheet to indicate the error circuit.

### NOTE:

CAN communication line has no error if units other than Diag on CAN units are indicated. An error may be on the power supply of the control unit, DDL1 line or DDL2 line.

- a. “TRANSMISSION” which is Diag on CAN unit, is not indicated on “SELECT SYSTEM” screen. This indicates that DLC is not receiving a signal from TCM. Draw a line to indicate an error between DLC and TCM (line 1-a in the figure).

### NOTE:

- Diag on CAN units are not indicated on the “SELECT SYSTEM” screen when the CAN line between Diag on CAN unit and the data link connector is open.
- For a description of Diag on CAN, refer to [LAN-6, "Diag on CAN"](#).

(Example)

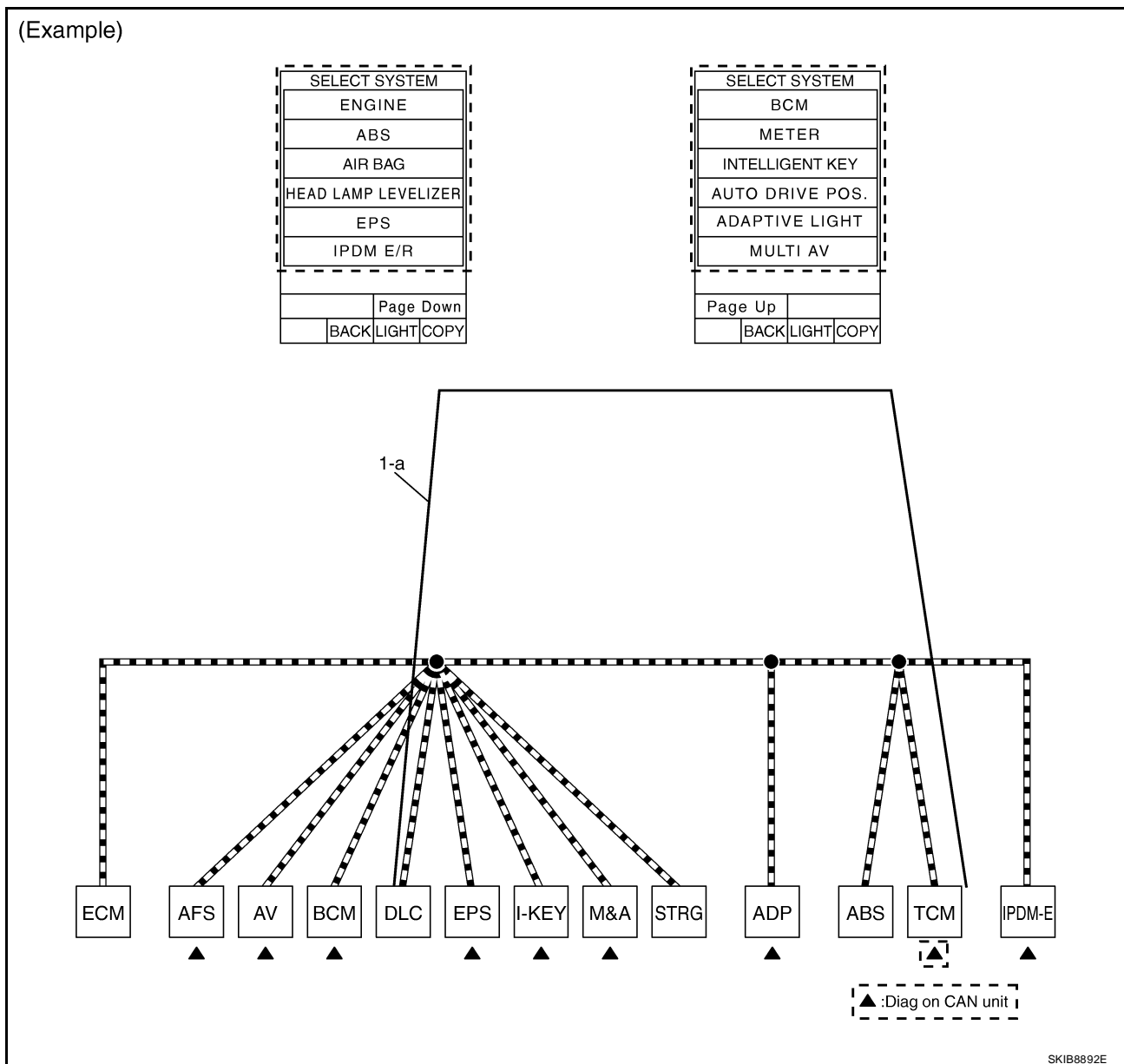

SKIB8892E

# TROUBLE DIAGNOSES WORK FLOW

## [CAN FUNDAMENTAL]

2. CAN DIAG SUPPORT MNTR: Check each item on "CAN DIAG SUPPORT MNTR". Draw a line on the diagnosis sheet to indicate the error circuit.
- a. Reception item of "ENGINE": On "TCM", "UNKWN" is indicated. This means ECM cannot receive the signal from TCM. Draw a line to indicate an error between ECM and TCM (line 2-a in the figure).

**NOTE:**

If "UNKWN" is indicated on "TRANSMIT DIAG", then the control unit cannot transmit CAN communication signal to each unit. Draw a line between the control unit and the splice.

- b. Reception item of "ADAPTIVE LIGHT": On "TCM", "UNKWN" is indicated. This means AFS cannot receive the signal from TCM. Draw a line to indicate an error between AFS and TCM (line 2-b in the figure).
- c. Reception item of "MULTI AV": "UNKWN" is not indicated. This indicates normal communication between AV and its receiving units. Do not draw any line.

(Example)

SYSTEM	ENGINE		SYSTEM	ADAPTIVE LIGHT		SYSTEM	MULTI AV	
DATE			DATE			DATE		
P/#	PRSNT	PAST	P/#	PRSNT	PAST	P/#	PRSNT	PAST
TRANSMIT DIAG	OK	OK	TRANSMIT DIAG	-	-	TRANSMIT DIAG	-	-
VDC/TCS/ABS	OK	OK	ECM	OK	OK	ECM	OK	OK
METER/M&A	-	-	METER/M&A	OK	OK	METER/M&A	OK	OK
BCM/SEC	OK	OK	TCM	UNKWN	0	BCM/SEC	-	-
ICC	-	-	STRG	OK	OK	HVAC	-	-
HVAC	-	-	EPS	-	-	IPDM E/R	-	-
TCM	UNKWN	0	IPDM E/R	OK	OK	TIRE-P	-	-
EPS	OK	OK						
IPDM E/R	OK	OK						
e4WD	-	-						
AWD/4WD	-	-						

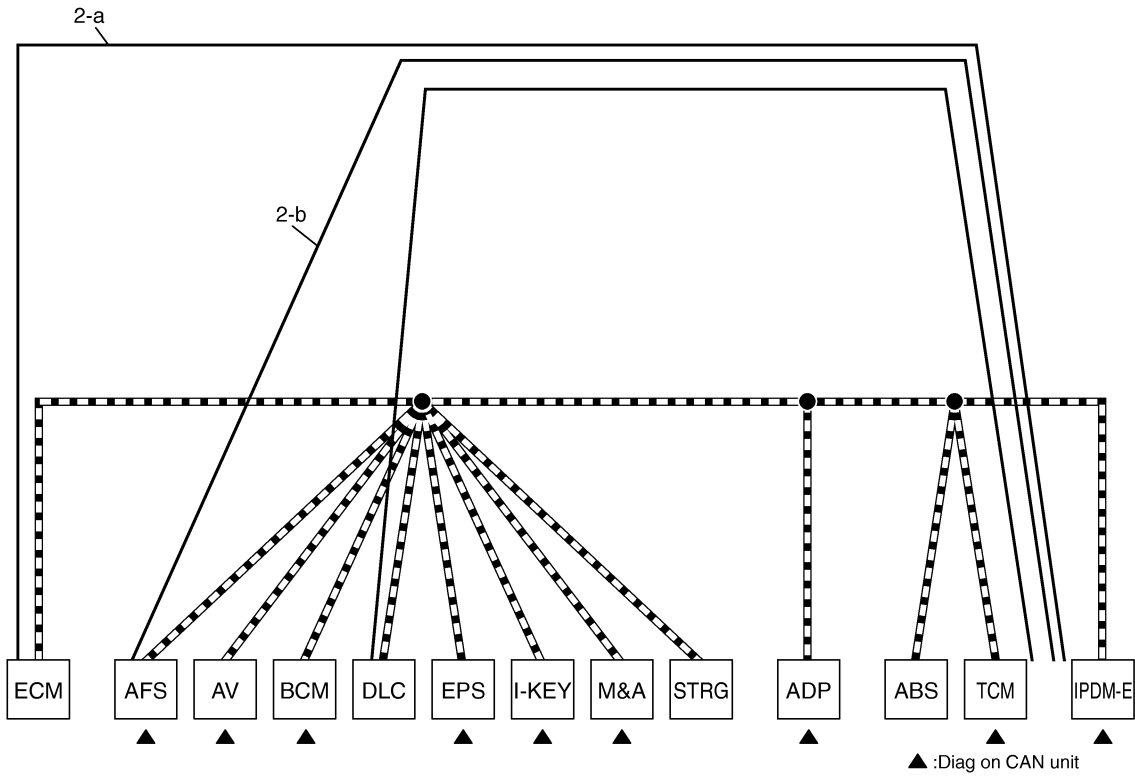

SKIB8725E

# TROUBLE DIAGNOSES WORK FLOW

## [CAN FUNDAMENTAL]

- d. Reception item of "BCM": On "TCM", "UNKWN" is indicated. This means BCM cannot receive the signal from TCM. Draw a line to indicate an error between BCM and TCM (line 2-d in the figure).
- e. Reception item of "EPS" and "INTELLIGENT KEY": "UNKWN" is not indicated. This indicates normal communication between EPS and I-KEY and their receiving units. Do not draw any line.

**NOTE:**

On CAN DIAG SUPPORT MNTR (without PAST), "UNKWN" is indicated even though the item is not used in the trouble diagnosis. For the details of each item on CAN diagnostic support monitor, refer to [LAN-44, "CAN Diagnostic Support Monitor"](#) .

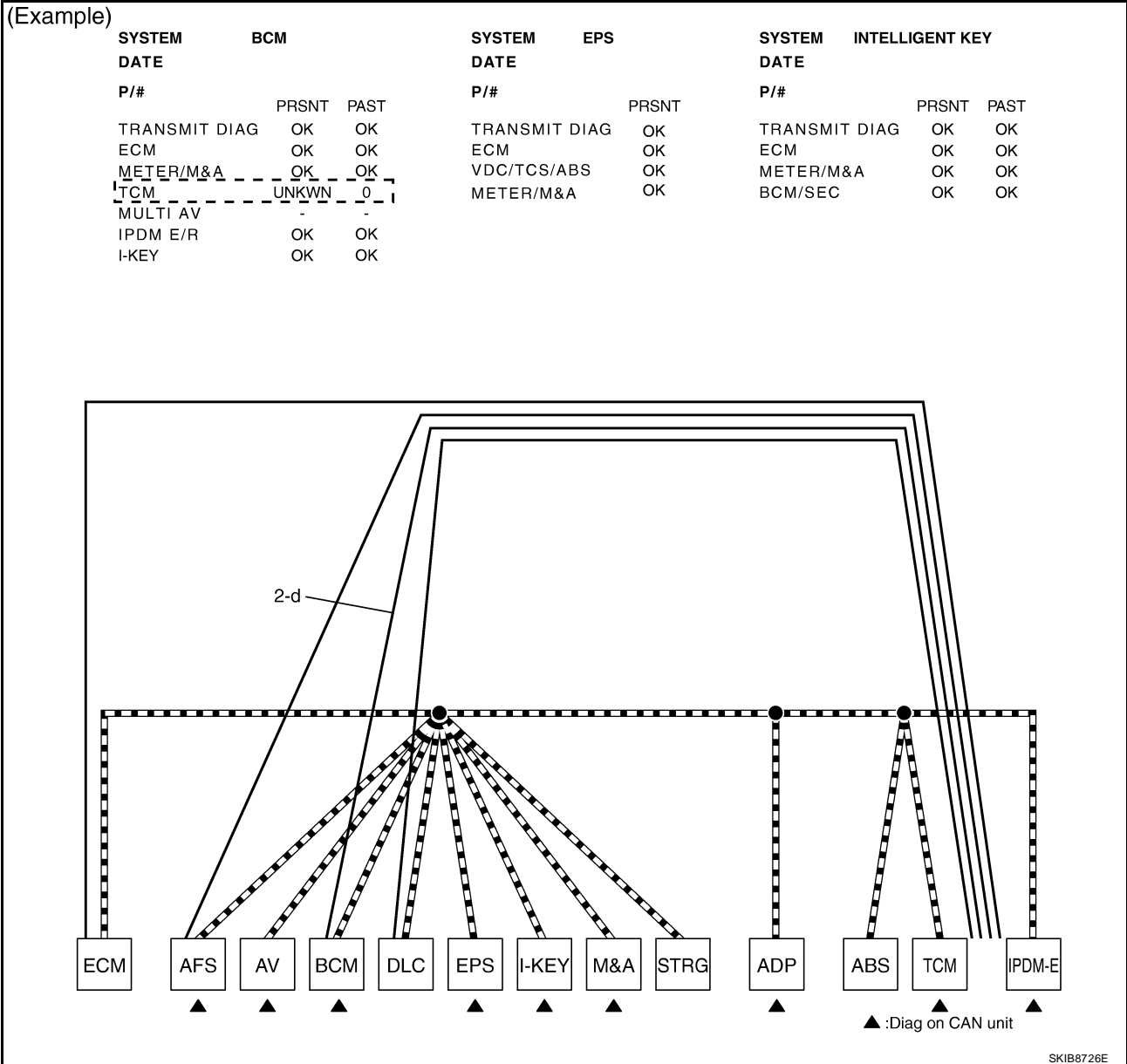

# TROUBLE DIAGNOSES WORK FLOW

## [CAN FUNDAMENTAL]

- f. Reception item of "METER": On "TCM", "UNKWN" is indicated. This means M&A cannot receive the signal from TCM. Draw a line to indicate an error between M&A and TCM (line 2-f in the figure).
- g. Reception item of "AUTO DRIVE POS.": On "TCM", "UNKWN" is indicated. This means ADP cannot receive the signal from TCM. Draw a line to indicate an error between ADP and TCM (line 2-g in the figure).
- h. Reception item of "ABS": "UNKWN" is not indicated. This indicates normal communication between ABS and its receiving units. Do not draw any line.

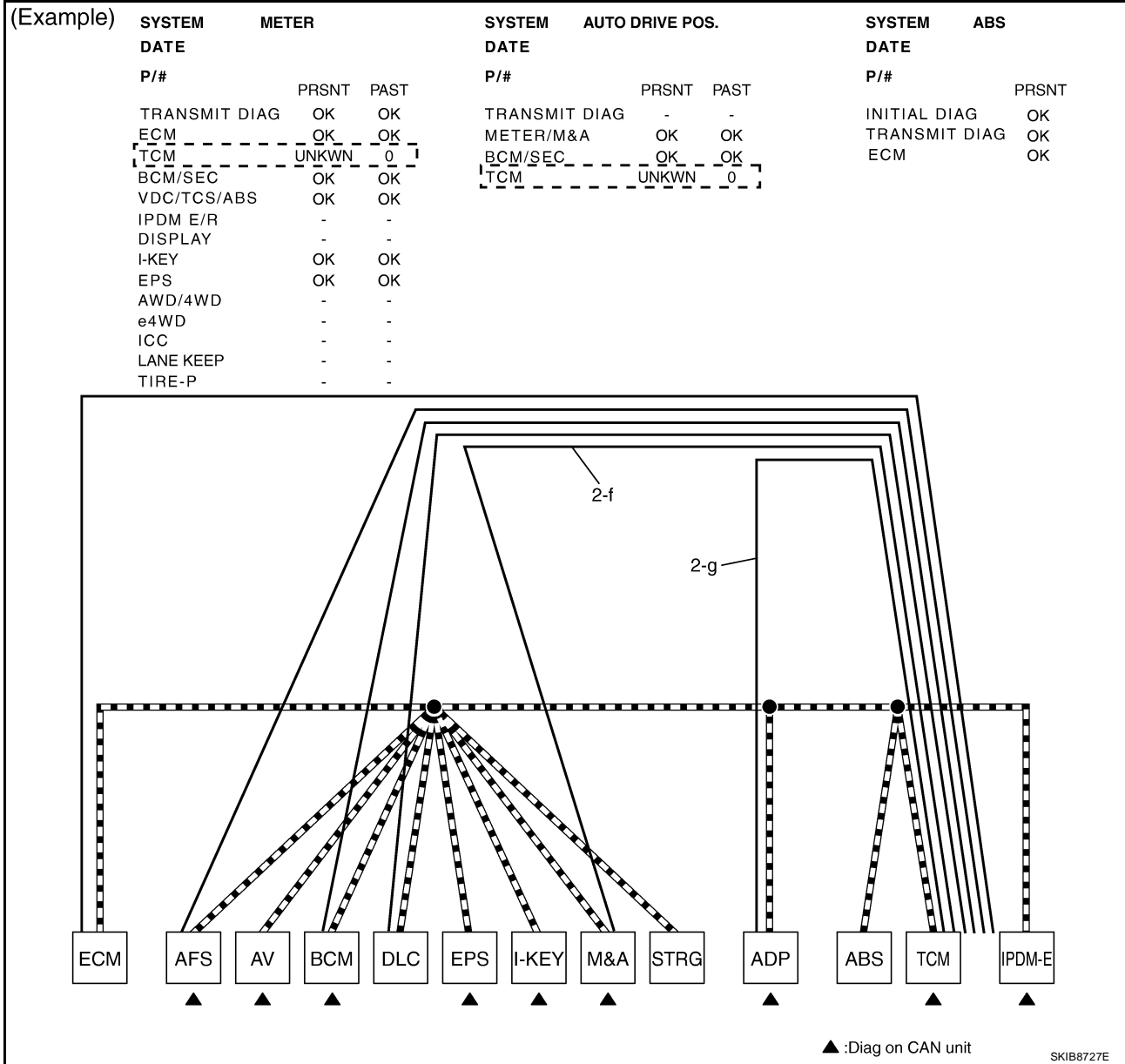

# TROUBLE DIAGNOSES WORK FLOW

[CAN FUNDAMENTAL]

- i. Reception item of "IPDM E/R": "UNKWN" is not indicated. This indicates normal communication between IPDM-E and its receiving units. Do not draw any line.
3. Based on information received from "CAN DIAG SUPPORT MNTR", place a check mark on the known good CAN communication line between ECM and IPDM-E.
  - a. Through the previous procedure, the circuit between ADP splice and TCM has the most amount of lines (shade 3-a in the figure).
  - b. Place a check mark on the known good lines to establish the error circuit. Reception item of "IPDM E/R": On "ECM", "OK" is indicated. IPDM-E communicates normally with ECM. Put a check mark on the normal circuit between ECM and IPDM-E (check mark 3-b in the figure).

(Example)

SYSTEM	IPDM E/R		
DATE		PRSNT	PAST
TRANSMIT DIAG		OK	OK
ECM		OK	OK
BCM/SEC		OK	OK

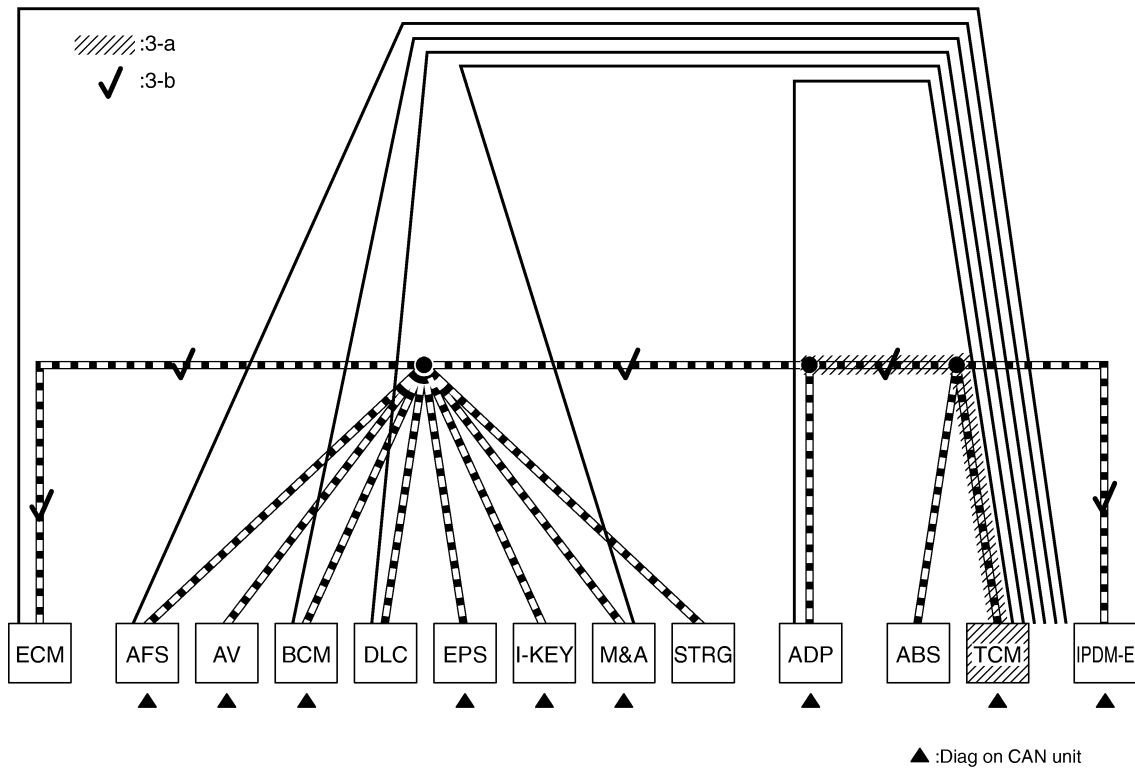

SKIB8728E

# TROUBLE DIAGNOSES WORK FLOW

[CAN FUNDAMENTAL]

4. Through the above procedure, the error is detected in the TCM branch line (shaded in the figure).

**NOTE:**

For abbreviations, refer to [LAN-41, "Abbreviation List"](#).

5. Perform the inspection for the detected error circuit. For the inspection procedure, refer to [LAN-69, "Mal-function Area Chart"](#).

(Example)

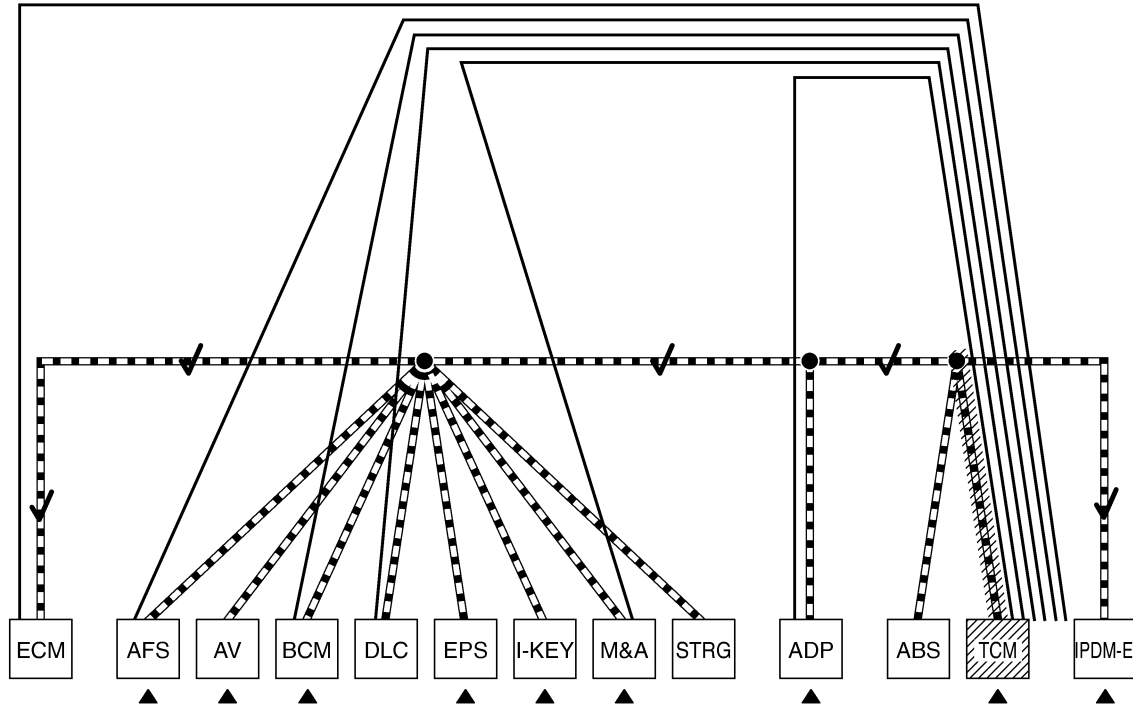

▲ :Diag on CAN unit

< CONSULT-II printout checklist >

	Item	Check box
1	SELECT SYSTEM	<input checked="" type="checkbox"/>
2	ENGINE	<input checked="" type="checkbox"/>
3	ADAPTIVE LIGHT <sup>▲</sup>	<input checked="" type="checkbox"/>
4	MULTI AV <sup>▲</sup>	<input checked="" type="checkbox"/>
5	BCM <sup>▲</sup>	<input checked="" type="checkbox"/>
6	EPS <sup>▲</sup>	<input checked="" type="checkbox"/>
7	INTELLIGENT KEY <sup>▲</sup>	<input checked="" type="checkbox"/>
8	METER <sup>▲</sup>	<input checked="" type="checkbox"/>
9	AUTO DRIVE POS. <sup>▲</sup>	<input checked="" type="checkbox"/>
10	ABS	<input checked="" type="checkbox"/>
11	TRANSMISSION <sup>▲</sup>	N-IDC
12	IPDM E/R <sup>▲</sup>	<input checked="" type="checkbox"/>

Possible root cause

· Error between TCM and splice.  
· Error in TCM.

Inspection result

SKIB8893E

A  
B  
C  
D  
E  
F  
G  
H  
I  
J  
L  
M

LAN





# TROUBLE DIAGNOSES WORK FLOW

[CAN FUNDAMENTAL]

## Past Error — Open Circuit —

Review CAN communication signal chart based on information received from the interview with the customer and on past error information from SELF-DIAG RESULTS and CAN DIAG SUPPORT MNTR.

- SELF-DIAG RESULTS: Inspect the control units indicating "U1000" or "U1001" on SELF-DIAG RESULTS.

(Example)

<p>SYSTEM ENGINE DATE P/#</p> <div style="border: 1px solid black; padding: 5px; text-align: center;">SELF-DIAG RESULTS</div> <p>DTC RESULTS      TIME</p> <div style="border: 1px dashed black; padding: 2px;">CAN COMM CIRCUIT      1t [U1001]</div>	<p>SYSTEM ADAPTIVE LIGHT DATE P/#</p> <div style="border: 1px solid black; padding: 5px; text-align: center;">SELF-DIAG RESULTS</div> <p>DTC RESULTS      TIME</p> <p>NO DTC IS DETECTED. FURTHER TESTING MAY BE REQUIRED.</p>	<p>SYSTEM MULTI AV DATE P/#</p> <div style="border: 1px solid black; padding: 5px; text-align: center;">SELF-DIAG RESULTS</div> <p>DTC RESULTS      TIME</p> <p>NO DTC IS DETECTED. FURTHER TESTING MAY BE REQUIRED.</p>	<p>SYSTEM BCM DATE P/#</p> <div style="border: 1px solid black; padding: 5px; text-align: center;">SELF-DIAG RESULTS</div> <p>DTC RESULTS      TIME</p> <p>NO DTC IS DETECTED. FURTHER TESTING MAY BE REQUIRED.</p>
<p>SYSTEM EPS DATE P/#</p> <div style="border: 1px solid black; padding: 5px; text-align: center;">SELF-DIAG RESULTS</div> <p>DTC RESULTS      TIME</p> <div style="border: 1px dashed black; padding: 2px;">CAN COMM CIRCUIT      PAST [U1000]</div>	<p>SYSTEM INTELLIGENT KEY DATE P/#</p> <div style="border: 1px solid black; padding: 5px; text-align: center;">SELF-DIAG RESULTS</div> <p>DTC RESULTS      TIME</p> <p>NO DTC IS DETECTED. FURTHER TESTING MAY BE REQUIRED.</p>	<p>SYSTEM METER DATE P/#</p> <div style="border: 1px solid black; padding: 5px; text-align: center;">SELF-DIAG RESULTS</div> <p>DTC RESULTS      TIME</p> <div style="border: 1px dashed black; padding: 2px;">CAN COMM CIRCUIT      3 [U1000]</div>	<p>SYSTEM AUTO DRIVE POS. DATE P/#</p> <div style="border: 1px solid black; padding: 5px; text-align: center;">SELF-DIAG RESULTS</div> <p>DTC RESULTS      TIME</p> <p>NO DTC IS DETECTED. FURTHER TESTING MAY BE REQUIRED.</p>
<p>SYSTEM ABS DATE P/#</p> <div style="border: 1px solid black; padding: 5px; text-align: center;">SELF-DIAG RESULTS</div> <p>DTC RESULTS      TIME</p> <div style="border: 1px dashed black; padding: 2px;">CAN COMM CIRCUIT      3 [U1000]</div>	<p>SYSTEM TRANSMISSION DATE P/#</p> <div style="border: 1px solid black; padding: 5px; text-align: center;">SELF-DIAG RESULTS</div> <p>DTC RESULTS      TIME</p> <div style="border: 1px dashed black; padding: 2px;">CAN COMM CIRCUIT      3 [U1000]</div>	<p>SYSTEM IPDM E/R DATE P/#</p> <div style="border: 1px solid black; padding: 5px; text-align: center;">SELF-DIAG RESULTS</div> <p>DTC RESULTS      TIME</p> <p>NO DTC IS DETECTED. FURTHER TESTING MAY BE REQUIRED.</p>	

SKIB8731E

A  
B  
C  
D  
E  
F  
G  
H  
I  
J  
L  
M

LAN

# TROUBLE DIAGNOSES WORK FLOW

**[CAN FUNDAMENTAL]**

2. CAN DIAG SUPPORT MNTR (with PAST): Check the CAN DIAG SUPPORT MNTR (with PAST) of units indicating "U1000" or "U1001" on SELF-DIAG RESULTS. Draw a line on the diagnosis sheet to indicate the possible error circuit.

**NOTE:**

For the details of each indication on CAN DIAG SUPPORT MNTR, refer to [LAN-44, "CAN Diagnostic Support Monitor"](#).

- a. Reception item of "ENGINE": "VDC/TCS/ABS", "3" is indicated in the "PAST". This means ECM could not receive the signal from ABS in the past. Draw a line between ECM and ABS (line 2-a in the figure).
- b. Reception item of "METER": "VDC/TCS/ABS", "3" is indicated in the "PAST". This means M&A could not receive the signal from ABS in the past. Draw a line between M&A and ABS (line 2-b in the figure).
- c. Reception item of "TRANSMISSION": "VDC/TCS/ABS", "3" is indicated in the "PAST". This means TCM could not receive the signal from ABS in the past. Draw a line between TCM and ABS (line 2-c in the figure).

(Example)

SYSTEM ENGINE			SYSTEM METER			SYSTEM TRANSMISSION		
DATE			DATE			DATE		
P/#	PRSENT	PAST	P/#	PRSENT	PAST	P/#	PRSENT	PAST
TRANSMIT DIAG	OK	OK	TRANSMIT DIAG	OK	OK	TRANSMIT DIAG	OK	OK
VDC/TCS/ABS	OK	3	ECM	OK	OK	VDC/TCS/ABS	OK	3
METER/M&A	-	-	TCM	OK	OK	METER/M&A	OK	OK
BCM/SEC	OK	OK	BCM/SEC	OK	OK	BCM/SEC	OK	OK
ICC	-	-	VDC/TCS/ABS	OK	3	ICC	-	-
HVAC	-	-	IPDM E/R	-	-	e4WD	-	-
TCM	OK	OK	DISPLAY	-	-	AWD/4WD	-	-
EPS	OK	OK	I-KEY	OK	OK			
IPDM E/R	OK	OK	EPS	OK	OK			
e4WD	-	-	AWD/4WD	-	-			
AWD/4WD	-	-	e4WD	-	-			
			ICC	-	-			
			LANE KEEP	-	-			
			TIRE-P	-	-			

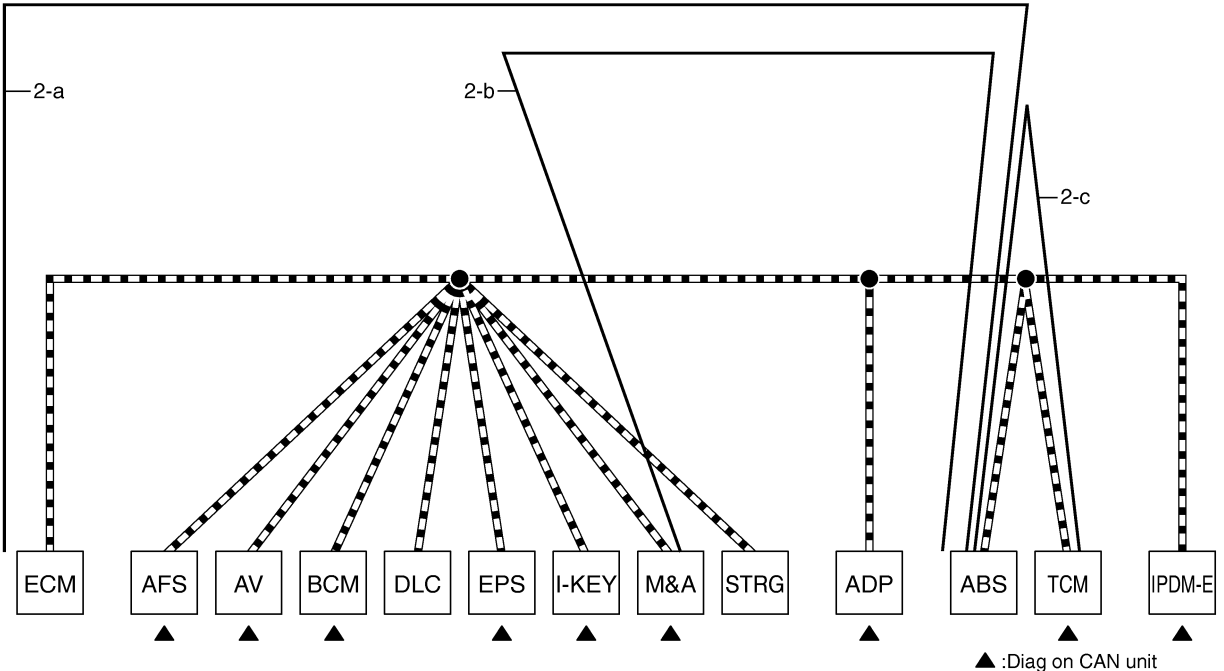

SK1B8732E

# TROUBLE DIAGNOSES WORK FLOW

## [CAN FUNDAMENTAL]

3. CAN DIAG SUPPORT MNTR (without PAST): Check the CAN DIAG SUPPORT MNTR (without PAST) of units indicating "U1000" or "U1001" on SELF-DIAG RESULTS. Draw a line on the diagnosis sheet to indicate the possible error circuit.

**NOTE:**

- While an error occurred in the past according to SELF-DIAG RESULTS, it is unclear which signal is not received. Assume that errors were detected from all reception items.
  - Draw a single line among the unit and all reception items. (Work flow differs from CAN DIAG SUPPORT MNTR (with PAST).)
- a. Reception item of "EPS": Assume that the unit could not receive the signals from ECM, ABS, and M&A. Draw a line among EPS, ECM, ABS, and M&A (line 3-a in the figure).
- b. Reception item of "ABS": Assume that the unit could not receive the signal from ECM. Draw a line between ABS and ECM (line 3-b in the figure).

(Example)

<table border="0" style="width: 100%; border-collapse: collapse;"> <tr> <td style="text-align: center;"><b>SYSTEM</b></td> <td style="text-align: center;"><b>EPS</b></td> <td></td> </tr> <tr> <td style="text-align: center;"><b>DATE</b></td> <td></td> <td></td> </tr> <tr> <td style="text-align: center;"><b>P/#</b></td> <td></td> <td style="text-align: center;"><b>PRSNT</b></td> </tr> <tr> <td style="text-align: center;">TRANSMIT DIAG</td> <td style="text-align: center;">OK</td> <td style="text-align: center;">-</td> </tr> <tr> <td style="text-align: center;">ECM</td> <td style="text-align: center;">OK</td> <td style="text-align: center;">-</td> </tr> <tr> <td style="text-align: center;">VDC/TCS/ABS</td> <td style="text-align: center;">OK</td> <td style="text-align: center;">-</td> </tr> <tr> <td style="text-align: center;">METER/M&amp;A</td> <td style="text-align: center;">OK</td> <td style="text-align: center;">-</td> </tr> </table>	<b>SYSTEM</b>	<b>EPS</b>		<b>DATE</b>			<b>P/#</b>		<b>PRSNT</b>	TRANSMIT DIAG	OK	-	ECM	OK	-	VDC/TCS/ABS	OK	-	METER/M&A	OK	-	<table border="0" style="width: 100%; border-collapse: collapse;"> <tr> <td style="text-align: center;"><b>SYSTEM</b></td> <td style="text-align: center;"><b>ABS</b></td> <td></td> </tr> <tr> <td style="text-align: center;"><b>DATE</b></td> <td></td> <td></td> </tr> <tr> <td style="text-align: center;"><b>P/#</b></td> <td></td> <td style="text-align: center;"><b>PRSNT</b></td> </tr> <tr> <td style="text-align: center;">INITIAL DIAG</td> <td style="text-align: center;">OK</td> <td style="text-align: center;">-</td> </tr> <tr> <td style="text-align: center;">TRANSMIT DIAG</td> <td style="text-align: center;">OK</td> <td style="text-align: center;">-</td> </tr> <tr> <td style="text-align: center;">ECM</td> <td style="text-align: center;">OK</td> <td style="text-align: center;">-</td> </tr> </table>	<b>SYSTEM</b>	<b>ABS</b>		<b>DATE</b>			<b>P/#</b>		<b>PRSNT</b>	INITIAL DIAG	OK	-	TRANSMIT DIAG	OK	-	ECM	OK	-
<b>SYSTEM</b>	<b>EPS</b>																																							
<b>DATE</b>																																								
<b>P/#</b>		<b>PRSNT</b>																																						
TRANSMIT DIAG	OK	-																																						
ECM	OK	-																																						
VDC/TCS/ABS	OK	-																																						
METER/M&A	OK	-																																						
<b>SYSTEM</b>	<b>ABS</b>																																							
<b>DATE</b>																																								
<b>P/#</b>		<b>PRSNT</b>																																						
INITIAL DIAG	OK	-																																						
TRANSMIT DIAG	OK	-																																						
ECM	OK	-																																						

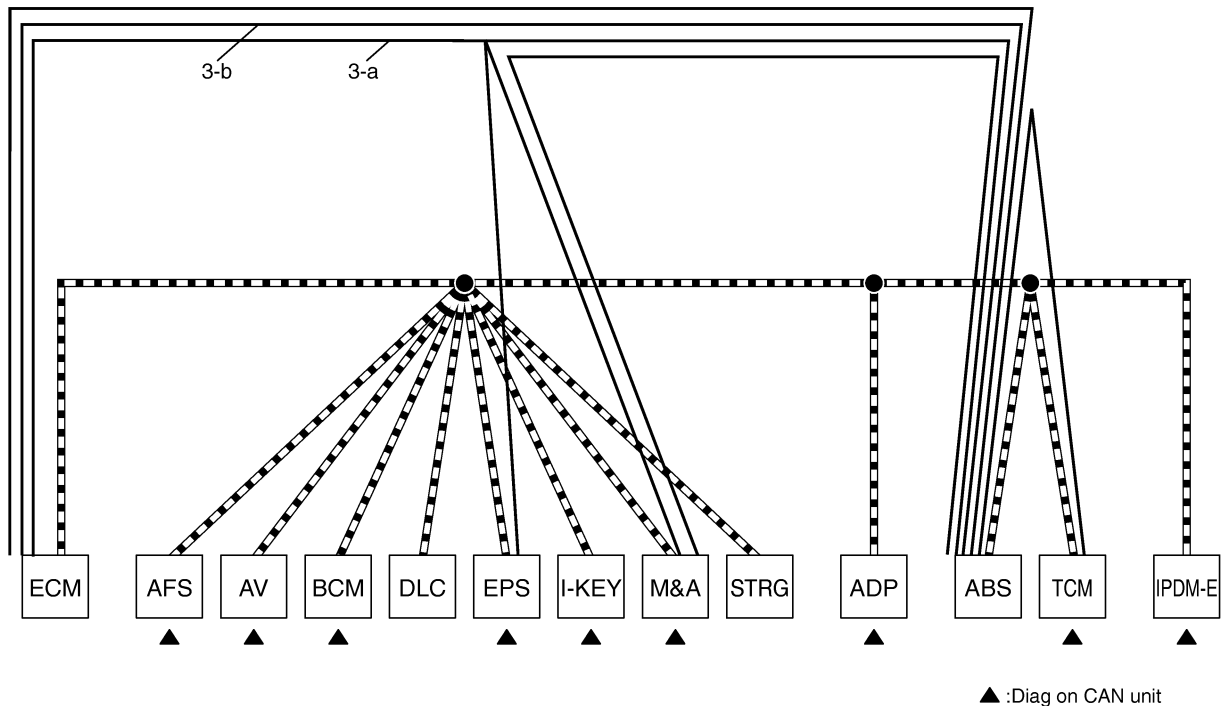

SKIB8733E

# TROUBLE DIAGNOSES WORK FLOW

[CAN FUNDAMENTAL]

4. Search for the possible cause using CAN communication signal chart using information from the interview with the customer.

**NOTE:**

For the details of CAN communication signal, refer to [LAN-48, "CAN Communication Signal Chart"](#) .

- a. ABS warning lamp turned ON and speedometer did not move: This means that “ABS warning lamp signal” and “Vehicle speed signal” could not communicate between M&A and ABS (4-a in the figure).
- b. The tachometer moved normally: This means that “Engine speed signal” could communicate normally between ECM and M&A (4-b in the figure).

(Example)

First registration: 28, Jan. 2005

CAN system type: Type 20

Symptom (Results from interview with customer)

- While driving,
- ABS warning lamp turned ON.
  - Speedometer did not move.
  - Tachometer moved normally.

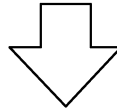

CAN Communication Signal Chart

T: Transmit R: Receive

Signal name/Connecting unit	ECM	AFS <sup>1</sup>	AV <sup>2</sup>	BCM	EPS	I-KEY <sup>3</sup>	M&A	STRG <sup>1</sup>	ADP <sup>4</sup>	ABS	TCM	IPDM-E
A/C compressor request signal	T											R
Accelerator pedal position signal	T										R	
Closed throttle position signal	T										R	
Cooling fan speed request signal	T											R
Engine and CVT integrated control signal	T R										R T	
Engine coolant temperature signal	T						R				R	
4-b Engine speed signal	T						R				R	
Engine status signal	T		R		R							
Fuel consumption monitor signal	T		R				R					
MI signal	T						R					
Wide open throttle position signal	T										R	
4-a ABS warning lamp signal							R			T		
Brake warning lamp signal							R			T		
Steering angle sensor signal		R						T				
Vehicle speed signal	R				R		R			T	R	
Input shaft revolution signal	R	R		R	R	R	T		R			T
Output shaft revolution signal	R											T
Shift position indicator signal	R	R	R	R <sup>5</sup>			R		R <sup>6</sup>			T
Second position indicator signal							R					T
Front wiper stop position signal				R								T
High beam status signal	R	R										T
Low beam status signal	R	R										T

SKIB8895E

# TROUBLE DIAGNOSES WORK FLOW

[CAN FUNDAMENTAL]

5. Fill out the diagnosis sheet based on information from step 4.
  - a. The ABS warning lamp turned ON and speedometer did not move: Assume that a possible cause is no communication between M&A and ABS. Draw a line between M&A and ABS. (Line 5-a in the figure).
  - b. The tachometer moved normally: Put check marks between ECM and M&A. The circuit between ECM and M&A is functioning properly (check marks 5-b in the figure).

(Example)

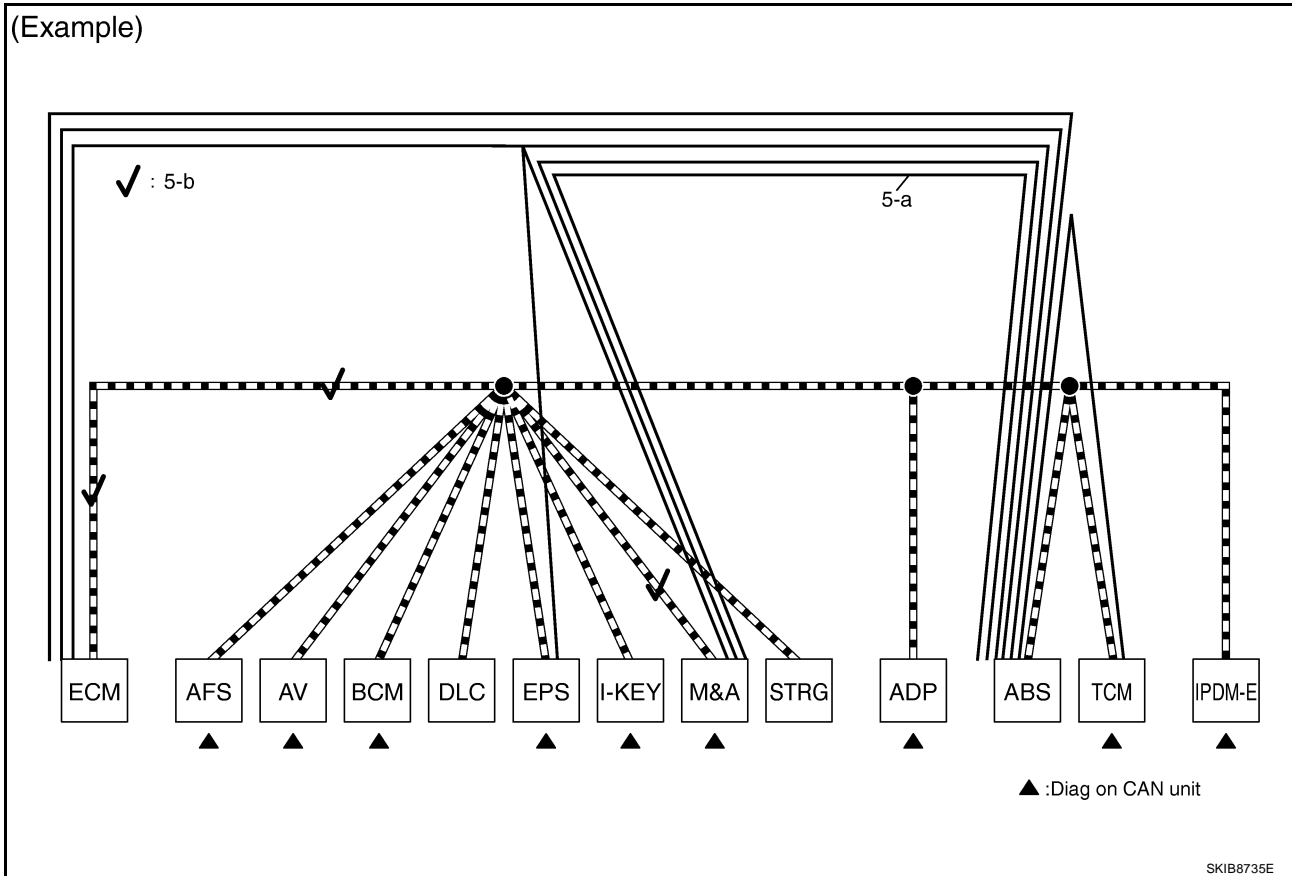

A  
B  
C  
D  
E  
F  
G  
H  
I  
J

LAN

L  
M

# TROUBLE DIAGNOSES WORK FLOW

[CAN FUNDAMENTAL]

6. The circuit which has the most amount of lines are the possible cause. Error is detected from ABS actuator and electric unit (control unit) branch line (shaded in the figure).

**NOTE:**

For abbreviations, refer to [LAN-41, "Abbreviation List"](#) .

7. Perform the inspection procedure for the possible cause. Refer to [LAN-69, "Malfunction Area Chart"](#) .

(Example)

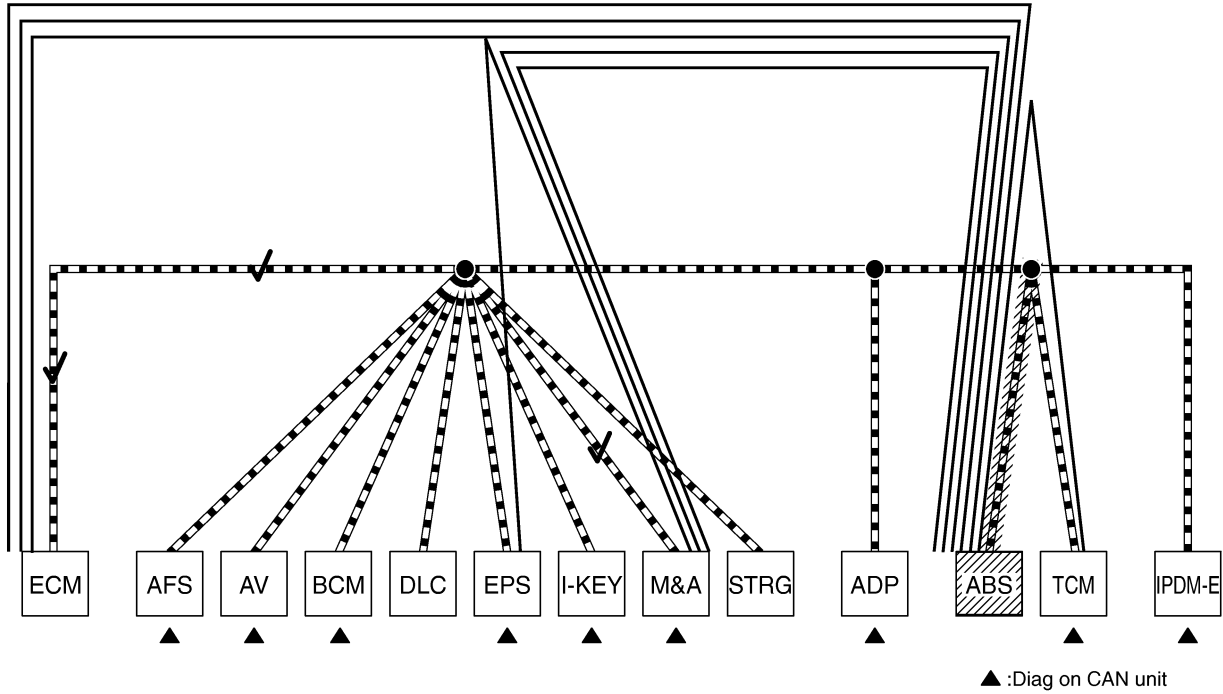

< CONSULT-II printout checklist >

	Item	Check box
1	SELECT SYSTEM	<input checked="" type="checkbox"/>
2	ENGINE	<input checked="" type="checkbox"/>
3	ADAPTIVE LIGHT <sup>▲</sup>	<input checked="" type="checkbox"/>
4	MULTI AV <sup>▲</sup>	<input checked="" type="checkbox"/>
5	BCM <sup>▲</sup>	<input checked="" type="checkbox"/>
6	EPS <sup>▲</sup>	<input checked="" type="checkbox"/>
7	INTELLIGENT KEY <sup>▲</sup>	<input checked="" type="checkbox"/>
8	METER <sup>▲</sup>	<input checked="" type="checkbox"/>
9	AUTO DRIVE POS. <sup>▲</sup>	<input checked="" type="checkbox"/>
10	ABS	<input checked="" type="checkbox"/>
11	TRANSMISSION <sup>▲</sup>	<input checked="" type="checkbox"/>
12	IPDM E/R <sup>▲</sup>	<input checked="" type="checkbox"/>

Possible root cause

- Error between ABS actuator and electric unit (control unit) and splice.
- Error in ABS actuator and electric unit (control unit).

Inspection result

SKIB8896E



# INDEX FOR DTC

**[CAN]**

## INDEX FOR DTC

PFP:00004

### DTC No. Index

UKS006FT

DTC	Self-diagnosis item (CONSULT-II indication)	DTC detection condition	Inspection
U1000	CAN COMM CIRCUIT	When ECM is not transmitting or receiving CAN communication signal of OBD (emission-related diagnosis) for 2 seconds or more.	Refer to <a href="#">LAN-41, "HOW TO USE THIS SECTION"</a> .
		When a control unit (except for ECM) is not transmitting or receiving CAN communication signal for 2 seconds or more.	
U1001	CAN COMM CIRCUIT	When ECM is not transmitting or receiving CAN communication signal other than OBD (emission-related diagnosis) for 2 seconds or more.	
U1002	SYSTEM COMM	When a control unit is not transmitting or receiving CAN communication signal for 2 seconds or less.	Start the inspection. Refer to the applicable section of the indicated control unit.
U1010	CONTROL UNIT [CAN]	When an error is detected during the initial diagnosis for CAN controller of each control unit.	Replace the control unit indicating "U1010".



## HOW TO USE THIS SECTION

### Caution

UKS006FU

- This section describes information peculiar to a vehicle, sheets for trouble diagnosis, and inspection procedures.
- For trouble diagnosis procedure, refer to [LAN-17, "Trouble Diagnosis Procedure"](#).

### Abbreviation List

UKS006FV

Abbreviations in CAN communication signal chart, and the diagnosis sheet are as per the following list.

Abbreviation	Unit name	SELECT SYSTEM (CONSULT-II)	CAN DIAG SUPPORT MNTR (CONSULT-II)
4WD	Transfer control unit	ALL MODE AWD/4WD	AWD/4WD
A-BAG	Air bag diagnosis sensor unit	AIR BAG	—
ABS	ABS actuator and electric unit (control unit)	ABS	VDC/TCS/ABS
BCM	BCM	BCM	BCM/SEC
DIFF	Differential lock control unit	DIFF LOCK	DIFF LOCK
DLC	Data link connector	—	—
ECM	ECM	ENGINE	ECM
IPDM-E	IPDM E/R	IPDM E/R	IPDM E/R
M&A	Combination meter	METER	METER/M&A
STRG	Steering angle sensor	—	STRG
TCM	TCM	A/T	TCM

A  
B  
C  
D  
E  
F  
G  
H  
I  
J  
L  
M

LAN

## PRECAUTIONS

PFP:00001

### Precautions for Supplemental Restraint System (SRS) “AIR BAG” and “SEAT BELT PRE-TENSIONER”

UKS006FW

The Supplemental Restraint System such as “AIR BAG” and “SEAT BELT PRE-TENSIONER”, used along with a front seat belt, helps to reduce the risk or severity of injury to the driver and front passenger for certain types of collision. This system includes seat belt switch inputs and dual stage front air bag modules. The SRS system uses the seat belt switches to determine the front air bag deployment, and may only deploy one front air bag, depending on the severity of a collision and whether the front occupants are belted or unbelted. Information necessary to service the system safely is included in the SRS and SB section of this Service Manual.

**WARNING:**

- To avoid rendering the SRS inoperative, which could increase the risk of personal injury or death in the event of a collision which would result in air bag inflation, all maintenance must be performed by an authorized NISSAN/INFINITI dealer.
- Improper maintenance, including incorrect removal and installation of the SRS, can lead to personal injury caused by unintentional activation of the system. For removal of Spiral Cable and Air Bag Module, see the SRS section.
- Do not use electrical test equipment on any circuit related to the SRS unless instructed to in this Service Manual. SRS wiring harnesses can be identified by yellow and/or orange harnesses or harness connectors.

### Precautions When Using CONSULT-II

UKS006FX

Use CONSULT-II CONVERTER when connecting CONSULT-II to data link connector.

**CAUTION:**

CAN communication does not function properly if CONSULT-II is used without connecting CONSULT-II CONVERTER.

### Precautions for Trouble Diagnosis

UKS006FY

**CAUTION:**

- Never apply 7.0 V or more to the measurement terminal.
- Use a tester with open terminal voltage of 7.0 V or less.
- Turn the ignition switch OFF and disconnect the battery cable from the negative terminal when checking the harness.

### Precautions for Harness Repair

UKS006FZ

- Solder the repaired area and wrap tape around the soldered area.

**NOTE:**

A fray of twisted lines must be within 110 mm (4.33 in).

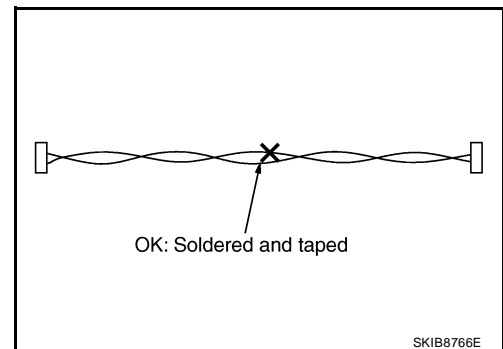

# PRECAUTIONS

[CAN]

- Bypass connection is never allowed at the repaired area.

**NOTE:**

Bypass connection may cause CAN communication error. The spliced wire becomes separated and the characteristics of twisted line are lost.

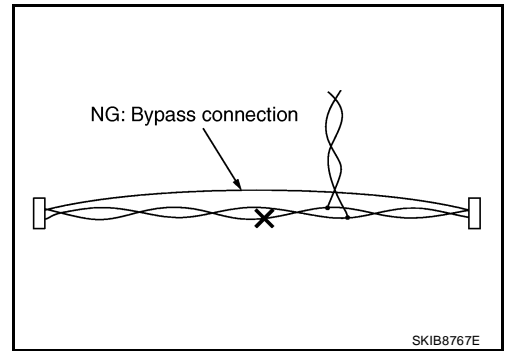

- Replace the applicable harness as an assembly if error is detected on the shield lines of CAN communication line.

A  
B  
C  
D  
E  
F  
G  
H  
I  
J  
L  
M

LAN

# TROUBLE DIAGNOSIS

[CAN]

PFP:00004

UKS006G0

## TROUBLE DIAGNOSIS

### CAN Diagnostic Support Monitor

Use "CAN DIAG SUPPORT MNTR" for detecting the root cause.

#### MONITOR ITEM LIST (CONSULT-II)

#### ECM

0: Error at present, 1 – 39: Error in the past (Number means the number of times the ignition switch is turned OFF→ON)

SELECT SYSTEM	CAN DIAG SUPPORT MNTR	Description	Normal		Error	
			PRSNT	PAST	PRSNT	PAST
ENGINE	TRANSMIT DIAG	Signal transmission status	OK	OK or 1 – 39*	UNKWN	0
	VDC/TCS/ABS	Signal receiving status from the ABS actuator and electric unit (control unit)				
	METER/M&A	Signal receiving status from the combination meter				
	BCM/SEC	Signal receiving status from the BCM				
	ICC	Not used even though indicated				
	HVAC					
	TCM	Signal receiving status from the TCM	OK	OK or 1 – 39*	UNKWN	0
	EPS	Not used even though indicated				
	IPDM E/R	Signal receiving status from the IPDM E/R	OK	OK or 1 – 39*	UNKWN	0
	e4WD	Not used even though indicated				
AWD/4WD	Signal receiving status from the transfer control unit	OK	OK or 1 – 39*	UNKWN	0	

\*: 39 or higher number is fixed at 39 until the self-diagnosis result is erased.

#### TCM

#### NOTE:

Replace the unit when "NG" is indicated on the "INITIAL DIAG".

SELECT SYSTEM	CAN DIAG SUPPORT MNTR	Description	Normal	Error
			PRSNT	
A/T	INITIAL DIAG	Status of CAN controller	OK	NG
	TRANSMIT DIAG	Signal transmission status		
	ECM	Signal receiving status from the ECM		
	VDC/TCS/ABS	Signal receiving status from the ABS actuator and electric unit (control unit)		
	METER/M&A	Signal receiving status from the combination meter		
	ICC/e4WD	Not used even though indicated		
	AWD/4WD	Signal receiving status from the transfer control unit	OK	UNKWN

# TROUBLE DIAGNOSIS

[CAN]

## Transfer Control Unit

**NOTE:**

Replace the unit when “NG” is indicated on the “INITIAL DIAG”.

SELECT SYS- TEM	CAN DIAG SUP- PORT MNTR	Description	Normal	Error
			PRSNT	
ALL MODE AWD/ 4WD	INITIAL DIAG	Status of CAN controller	OK	NG
	TRANSMIT DIAG	Signal transmission status		UNKWN
	ECM	Signal receiving status from the ECM		
	VDC/TCS/ABS	Signal receiving status from the ABS actuator and electric unit (control unit)		
	TCM	Signal receiving status from the TCM		
	METER/M&A	Signal receiving status from the combination meter		

## BCM

**NOTE:**

Replace the unit when “NG” is indicated on the “INITIAL DIAG”.

SELECT SYS- TEM	CAN DIAG SUP- PORT MNTR	Description	Normal	Error
			PRSNT	
BCM	INITIAL DIAG	Status of CAN controller	OK	NG
	TRANSMIT DIAG	Signal transmission status		UNKWN
	ECM	Signal receiving status from the ECM		
	IPDM E/R	Signal receiving status from the IPDM E/R		
	METER/M&A	Signal receiving status from the combination meter		
	I-KEY	Not used even though indicated		

## Differential Lock Control Unit

**NOTE:**

Replace the unit when “NG” is indicated on the “INITIAL DIAG”.

SELECT SYS- TEM	CAN DIAG SUP- PORT MNTR	Description	Normal	Error
			PRSNT	
DIFF LOCK	INITIAL DIAG	Status of CAN controller	OK	NG
	TRANSMIT DIAG	Signal transmission status		UNKWN
	ECM	Signal receiving status from the ECM		
	VDC/TCS/ABS	Signal receiving status from the ABS actuator and electric unit (control unit)		
	AWD/4WD	Signal receiving status from the transfer control unit		

A  
B  
C  
D  
E  
F  
G  
H  
I  
J  
L  
M

LAN

# TROUBLE DIAGNOSIS

[CAN]

## Combination Meter

0: Error at present, 1 – 39: Error in the past (Number means the number of times the ignition switch is turned OFF→ON)

SELECT SYSTEM	CAN DIAG SUPPORT MNTR	Description	Normal		Error	
			PRSNT	PAST	PRSNT	PAST
METER	TRANSMIT DIAG	Signal transmission status	OK	OK or 1 – 39*	UNKWN	0
	ECM	Signal receiving status from the ECM				
	TCM	Signal receiving status from the TCM				
	BCM/SEC	Signal receiving status from the BCM				
	VDC/TCS/ABS	Signal receiving status from the ABS actuator and electric unit (control unit)				
	IPDM E/R	Signal receiving status from the IPDM E/R				
	I-KEY	Not used even though indicated				
	EPS					
	AWD/4WD					
	e4WD					
	ICC					
	LANE KEEP					
	TIRE-P					

\*: 39 or higher number is fixed at 39 until the self-diagnosis result is erased.

## ABS Actuator and Electric Unit (Control Unit)

SELECT SYSTEM	CAN DIAG SUPPORT MNTR	Description	Normal	Error
			PRSNT	
ABS	INITIAL DIAG	Status of CAN controller	OK	NG <sup>Caution</sup>
	TRANSMIT DIAG	Signal transmission status		
	ECM	Signal receiving status from the ECM		
	TCM	Signal receiving status from the TCM		
	METER/M&A	Not used even though indicated		
	STRG	Signal receiving status from the steering angle sensor	OK	UNKWN
	ICC	Not used even though indicated		
	AWD/4WD	Signal receiving status from the transfer control unit	OK	UNKWN
	DIFF LOCK	Signal receiving status from the differential lock control unit		

**CAUTION:**

Never replace the unit even when “NG” is indicated on the “INITIAL DIAG” at this stage. Follow the trouble diagnosis procedures.

## IPDM E/R

0: Error at present, 1 – 39: Error in the past (Number means the number of times the ignition switch is turned OFF→ON)

SELECT SYSTEM	CAN DIAG SUPPORT MNTR	Description	Normal		Error	
			PRSNT	PAST	PRSNT	PAST
IPDM E/R	TRANSMIT DIAG	Signal transmission status	OK	OK or 1 – 39*	UNKWN	0
	ECM	Signal receiving status from the ECM				
	BCM/SEC	Signal receiving status from the BCM				

\*: 39 or higher number is fixed at 39 until the self-diagnosis result is erased.

## CAN System Specification Chart

Determine CAN system type from the following specification chart. Then choose the correct diagnosis sheet.

**NOTE:**

Refer to [LAN-19, "CHECK OF CAN SYSTEM TYPE \(HOW TO USE CAN SYSTEM TYPE SPECIFICATION CHART\)"](#) for how to use CAN system specification chart.

Body type	Wagon					
Axle	2WD		4WD			
Engine	VQ40DE					
Transmission	M/T	A/T	M/T	A/T		
Brake control	VDC					
Electronic locking rear differential				×		×
CAN system type	1	2	3	4	5	6
Diagnosis sheet	<a href="#">LAN-62</a>	<a href="#">LAN-63</a>	<a href="#">LAN-64</a>	<a href="#">LAN-65</a>	<a href="#">LAN-66</a>	<a href="#">LAN-67</a>
CAN communication signal chart	<a href="#">LAN-48, "TYPE 1"</a>	<a href="#">LAN-49, "TYPE 2"</a>	<a href="#">LAN-50, "TYPE 3/TYPE 4"</a>		<a href="#">LAN-51, "TYPE 5/TYPE 6"</a>	

×: Applicable

## VEHICLE EQUIPMENT IDENTIFICATION INFORMATION

**NOTE:**

Check CAN system type from the vehicle shape and equipment.

- Models with electronic locking rear differential

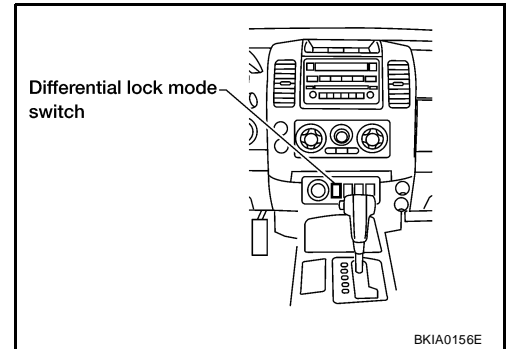

A  
B  
C  
D  
E  
F  
G  
H  
I  
J  
L  
M

LAN

# TROUBLE DIAGNOSIS

[CAN]

UKS006G2

## CAN Communication Signal Chart

Refer to [LAN-15, "How to Use CAN Communication Signal Chart"](#) for how to use CAN communication signal chart.

### TYPE 1

#### NOTE:

Refer to [LAN-41, "Abbreviation List"](#) for the abbreviations of the connecting units.

T: Transmit R: Receive

Signal name/Connecting unit	ECM	BCM	M&A	STRG	ABS	IPDM-E
A/C compressor request signal	T					R
Accelerator pedal position signal	T				R	
ASCD CRUISE lamp signal	T		R			
ASCD SET lamp signal	T		R			
Cooling fan speed request signal	T					R
Engine coolant temperature signal	T		R			
Engine speed signal	T		R		R	
Engine status signal	T	R				
Fuel consumption monitor signal	T		R			
Malfunction indicator lamp signal	T		R			
Power generation command value signal	T					R
A/C switch signal	R	T				
Blower fan motor switch signal	R	T				
Buzzer output signal		T	R			
Day time running light request signal		T	R			R
Door switch signal		T	R			R
Front fog light request signal		T	R			R
Front wiper request signal		T				R
High beam request signal		T	R			R
Horn chirp signal		T				R
Ignition switch signal		T				R
Low beam request signal		T				R
Position light request signal		T	R			R
Rear window defogger switch signal		T				R
Sleep wake up signal		T	R			R
Theft warning horn request signal		T				R
Turn indicator signal		T	R			
Fuel level sensor signal	R		T			
Seat belt buckle switch signal		R	T			
Vehicle speed signal			R		T	
	R	R	T			
Steering angle sensor signal				T	R	
ABS warning lamp signal			R		T	
Brake warning lamp signal			R		T	
HDC indicator lamp signal*			R		T	
SLIP indicator lamp signal			R		T	



# TROUBLE DIAGNOSIS

[CAN]

Signal name/Connecting unit	ECM	BCM	M&A	STRG	ABS	IPDM-E
VDC OFF indicator lamp signal			R		T	
Front wiper stop position signal		R				T
High beam status signal	R					T
Low beam status signal	R					T
Rear window defogger control signal	R					T

**NOTE:**

CAN data of the air bag diagnosis sensor unit is not used by usual service work, thus it is omitted.

**TYPE 2**

**NOTE:**

Refer to [LAN-41, "Abbreviation List"](#) for the abbreviations of the connecting units.

T: Transmit R: Receive

Signal name/Connecting unit	ECM	TCM	BCM	M&A	STRG	ABS	IPDM-E
A/C compressor request signal	T						R
Accelerator pedal position signal	T	R				R	
ASCD CRUISE lamp signal	T			R			
ASCD OD cancel request	T	R					
ASCD operation signal	T	R					
ASCD SET lamp signal	T			R			
Battery voltage signal	T	R					
Closed throttle position signal	T	R					
Cooling fan speed request signal	T						R
Engine coolant temperature signal	T			R			
Engine speed signal	T	R		R		R	
Engine status signal	T		R				
Fuel consumption monitor signal	T			R			
Malfunction indicator lamp signal	T			R			
Power generation command value signal	T						R
Wide open throttle position signal	T	R					
A/T fluid temperature sensor signal		T		R			
A/T position indicator lamp signal		T		R		R	
A/T self-diagnosis signal	R	T					
O/D OFF indicator signal		T		R			
Output shaft revolution signal	R	T					
Turbine revolution signal	R	T					
A/C switch signal	R		T				
Blower fan motor switch signal	R		T				
Buzzer output signal			T	R			
Day time running light request signal			T	R			R
Door switch signal			T	R			R
Front fog light request signal			T	R			R
Front wiper request signal			T				R
High beam request signal			T	R			R

# TROUBLE DIAGNOSIS

[CAN]

Signal name/Connecting unit	ECM	TCM	BCM	M&A	STRG	ABS	IPDM-E
Horn chirp signal			T				R
Ignition switch signal			T				R
Low beam request signal			T				R
Position light request signal			T	R			R
Rear window defogger switch signal			T				R
Sleep wake up signal			T	R			R
Theft warning horn request signal			T				R
Turn indicator signal			T	R			
1st position switch signal		R		T			
Fuel level sensor signal	R			T			
Overdrive control switch signal		R		T			
Seat belt buckle switch signal			R	T			
Stop lamp switch signal		R		T			
Vehicle speed signal				R		T	
	R	R	R	T			
Steering angle sensor signal					T	R	
ABS warning lamp signal				R		T	
Brake warning lamp signal				R		T	
HDC indicator lamp signal*				R		T	
SLIP indicator lamp signal				R		T	
VDC OFF indicator lamp signal				R		T	
Front wiper stop position signal			R				T
High beam status signal	R						T
Low beam status signal	R						T
Rear window defogger control signal	R						T

\*: Models with HDC

**NOTE:**

CAN data of the air bag diagnosis sensor unit is not used by usual service work, thus it is omitted.

**TYPE 3/TYPE 4**

**NOTE:**

Refer to [LAN-41, "Abbreviation List"](#) for the abbreviations of the connecting units.

T: Transmit R: Receive

Signal name/Connecting unit	ECM	BCM	DIFF <sup>*1</sup>	M&A	4WD	STRG	ABS	IPDM-E
A/C compressor request signal	T							R
Accelerator pedal position signal	T						R	
ASCD CRUISE lamp signal	T			R				
ASCD SET lamp signal	T			R				
Cooling fan speed request signal	T							R
Engine coolant temperature signal	T			R				
Engine speed signal	T			R	R		R	
Engine status signal	T	R						
Fuel consumption monitor signal	T			R				

# TROUBLE DIAGNOSIS

[CAN]

Signal name/Connecting unit	ECM	BCM	DIFF <sup>*1</sup>	M&A	4WD	STRG	ABS	IPDM-E	
Malfunction indicator lamp signal	T			R					A
Power generation command value signal	T							R	B
A/C switch signal	R	T							
Blower fan motor switch signal	R	T							C
Buzzer output signal		T		R					
Day time running light request signal		T		R				R	D
Door switch signal		T		R				R	D
Front fog light request signal		T		R				R	E
Front wiper request signal		T						R	E
High beam request signal		T		R				R	F
Horn chirp signal		T						R	F
Ignition switch signal		T						R	F
Low beam request signal		T						R	G
Position light request signal		T		R				R	G
Rear window defogger switch signal		T						R	H
Sleep wake up signal		T		R				R	H
Theft warning horn request signal		T						R	H
Turn indicator signal		T		R					I
Differential lock indicator signal			T				R		I
Differential lock switch signal			T				R		J
Fuel level sensor signal	R			T					J
Seat belt buckle switch signal		R		T					J
Vehicle speed signal	R	R	R	R	R		T		LAN
4WD shift switch signal			R		T		R		LAN
Steering angle sensor signal						T	R		L
ABS warning lamp signal				R			T		L
Brake warning lamp signal				R			T		M
HDC indicator lamp signal <sup>*2</sup>				R			T		M
SLIP indicator lamp signal				R			T		M
Stop lamp switch signal					R		T		
VDC OFF indicator lamp signal				R			T		
Front wiper stop position signal		R						T	
High beam status signal	R							T	
Low beam status signal	R							T	
Rear window defogger control signal	R							T	

● \*1: Models with electronic locking rear differential

● \*2: Models with HDC

## NOTE:

CAN data of the air bag diagnosis sensor unit is not used by usual service work, thus it is omitted.

## TYPE 5/TYPER 6

## NOTE:

Refer to [LAN-41, "Abbreviation List"](#) for the abbreviations of the connecting units.

# TROUBLE DIAGNOSIS

**[CAN]**

T: Transmit R: Receive

Signal name/Connecting unit	ECM	TCM	4WD	BCM	DIFF <sup>*1</sup>	M&A	STRG	ABS	IPDM-E
A/C compressor request signal	T								R
Accelerator pedal position signal	T	R						R	
ASCD CRUISE lamp signal	T					R			
ASCD OD cancel request	T	R							
ASCD operation signal	T	R							
ASCD SET lamp signal	T					R			
Battery voltage signal	T	R							
Closed throttle position signal	T	R							
Cooling fan speed request signal	T								R
Engine coolant temperature signal	T					R			
Engine speed signal	T	R	R			R		R	
Engine status signal	T			R					
Fuel consumption monitor signal	T					R			
Malfunction indicator lamp signal	T					R			
Power generation command value signal	T								R
Wide open throttle position signal	T	R							
A/T fluid temperature sensor signal		T				R			
A/T position indicator lamp signal		T	R			R		R	
A/T self-diagnosis signal	R	T							
O/D OFF indicator signal		T				R			
Output shaft revolution signal	R	T	R						
Turbine revolution signal	R	T							
4WD shift switch signal			T		R			R	
A/C switch signal	R			T					
Blower fan motor switch signal	R			T					
Buzzer output signal				T		R			
Day time running light request signal				T		R			R
Door switch signal				T		R			R
Front fog light request signal				T		R			R
Front wiper request signal				T					R
High beam request signal				T		R			R
Horn chirp signal				T					R
Ignition switch signal				T					R
Low beam request signal				T					R
Position light request signal				T		R			R
Rear window defogger switch signal				T					R
Sleep wake up signal				T		R			R
Theft warning horn request signal				T					R
Turn indicator signal				T		R			
Differential lock indicator signal					T			R	
Differential lock switch signal					T			R	
1st position switch signal		R				T			

# TROUBLE DIAGNOSIS

[CAN]

Signal name/Connecting unit	ECM	TCM	4WD	BCM	DIFF*1	M&A	STRG	ABS	IPDM-E
Fuel level sensor signal	R					T			
Overdrive control switch signal		R				T			
Seat belt buckle switch signal				R		T			
Stop lamp switch signal		R				T			
			R					T	
Vehicle speed signal			R		R	R		T	
	R	R		R		T			
Steering angle sensor signal							T	R	
ABS warning lamp signal						R		T	
Brake warning lamp signal						R		T	
HDC indicator lamp signal*2						R		T	
SLIP indicator lamp signal						R		T	
VDC OFF indicator lamp signal						R		T	
Front wiper stop position signal				R					T
High beam status signal	R								T
Low beam status signal	R								T
Rear window defogger control signal	R								T

- \*1: Models with electronic locking rear differential
- \*2: Models with HDC

**NOTE:**

CAN data of the air bag diagnosis sensor unit is not used by usual service work, thus it is omitted.

A  
B  
C  
D  
E  
F  
G  
H  
I  
J

LAN

L  
M

# TROUBLE DIAGNOSIS

[CAN]

## Schematic

UKS006G3

(4W) : WITH 4-WHEEL DRIVE

(A) : WITH A/T

(DL) : WITH ELECTRONIC LOCKING REAR DIFFERENTIAL

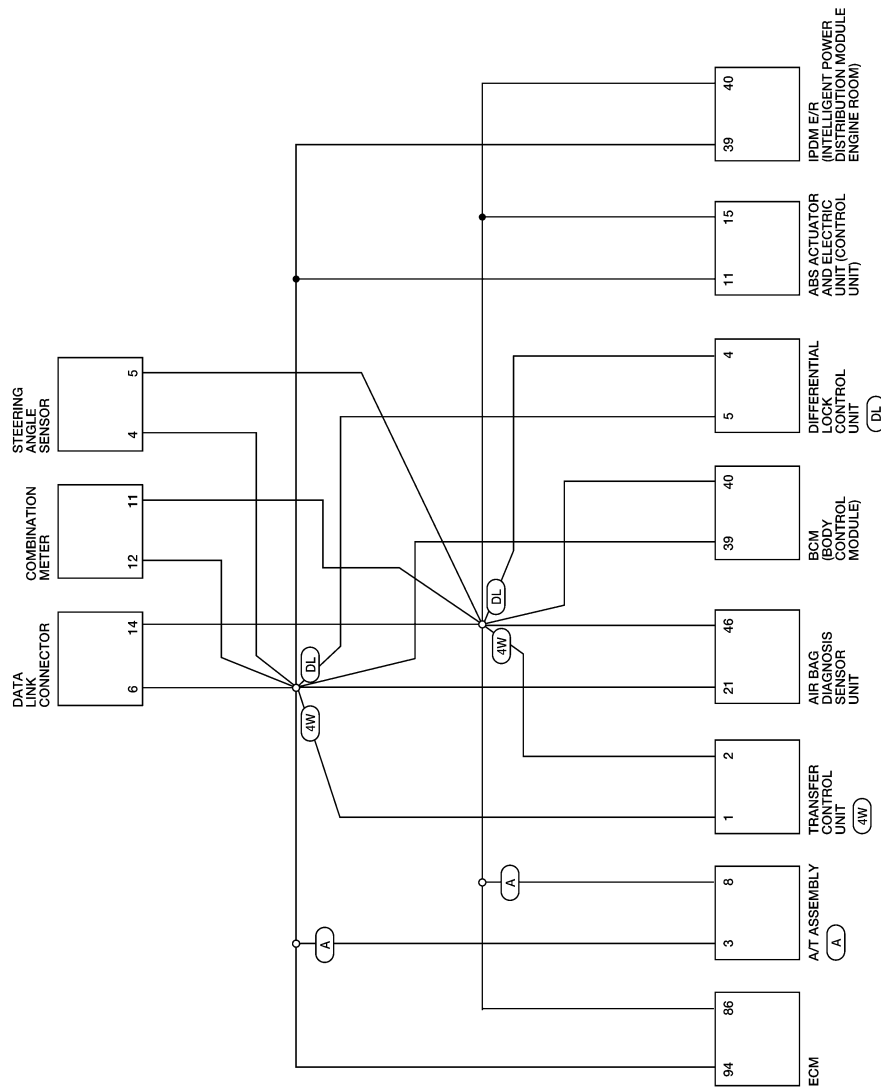

BKWA0721E

# TROUBLE DIAGNOSIS

[CAN]

## Wiring Diagram — CAN —

UKS006G4

### LAN-CAN-01

- : DATA LINE
- (A) : WITH A/T
- (M) : WITH M/T
- (4W) : WITH 4-WHEEL DRIVE

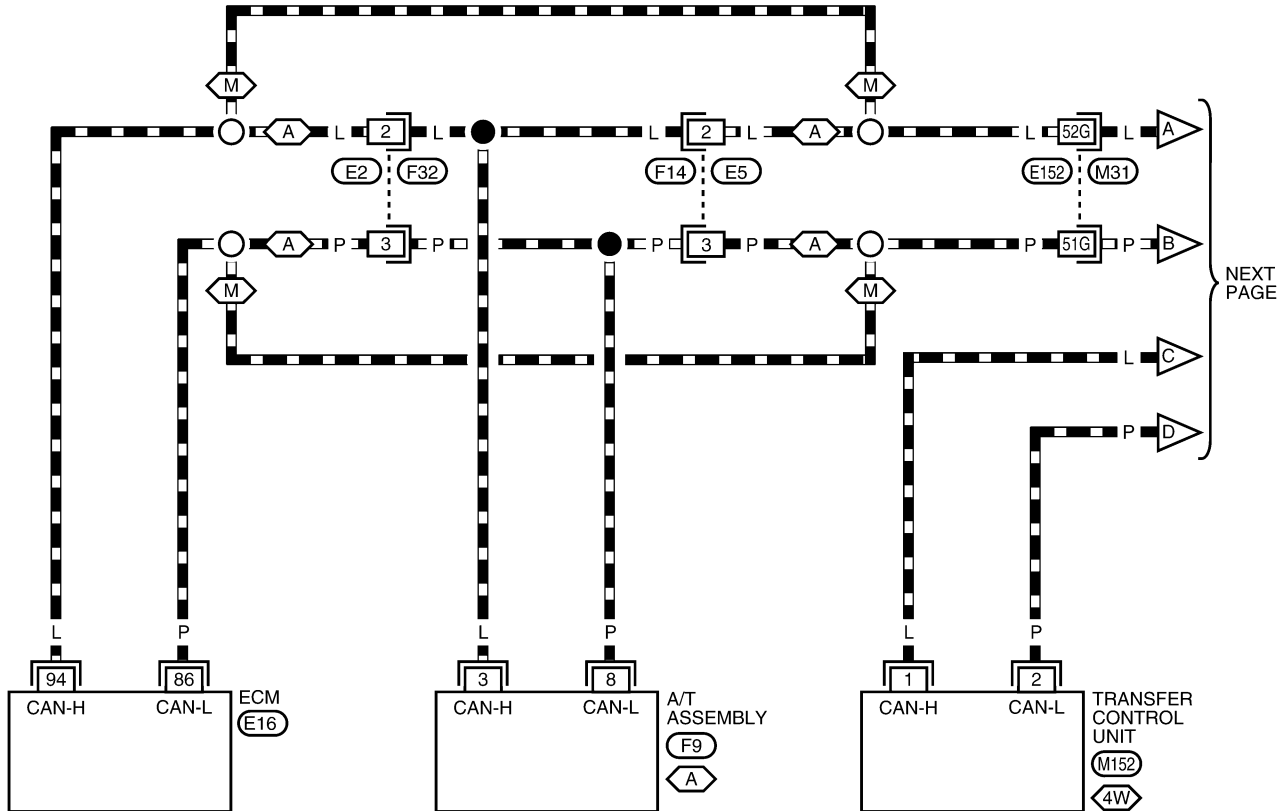

A  
B  
C  
D  
E  
F  
G  
H  
I  
J  
K  
L  
M

LAN

REFER TO THE FOLLOWING.  
(M31) - SUPER MULTIPLE JUNCTION (SMJ)

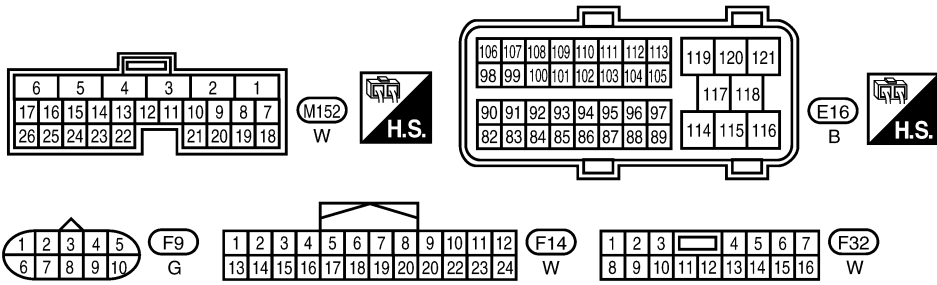

BKWA0744E

## LAN-CAN-02

- : DATA LINE
- : WITH 4-WHEEL DRIVE
- : WITH ELECTRONIC LOCKING REAR DIFFERENTIAL

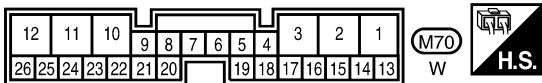
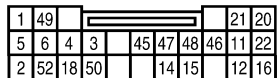
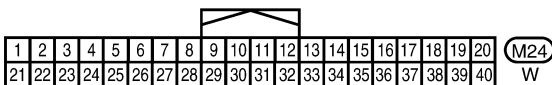
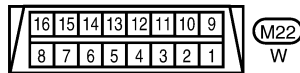
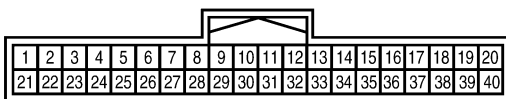
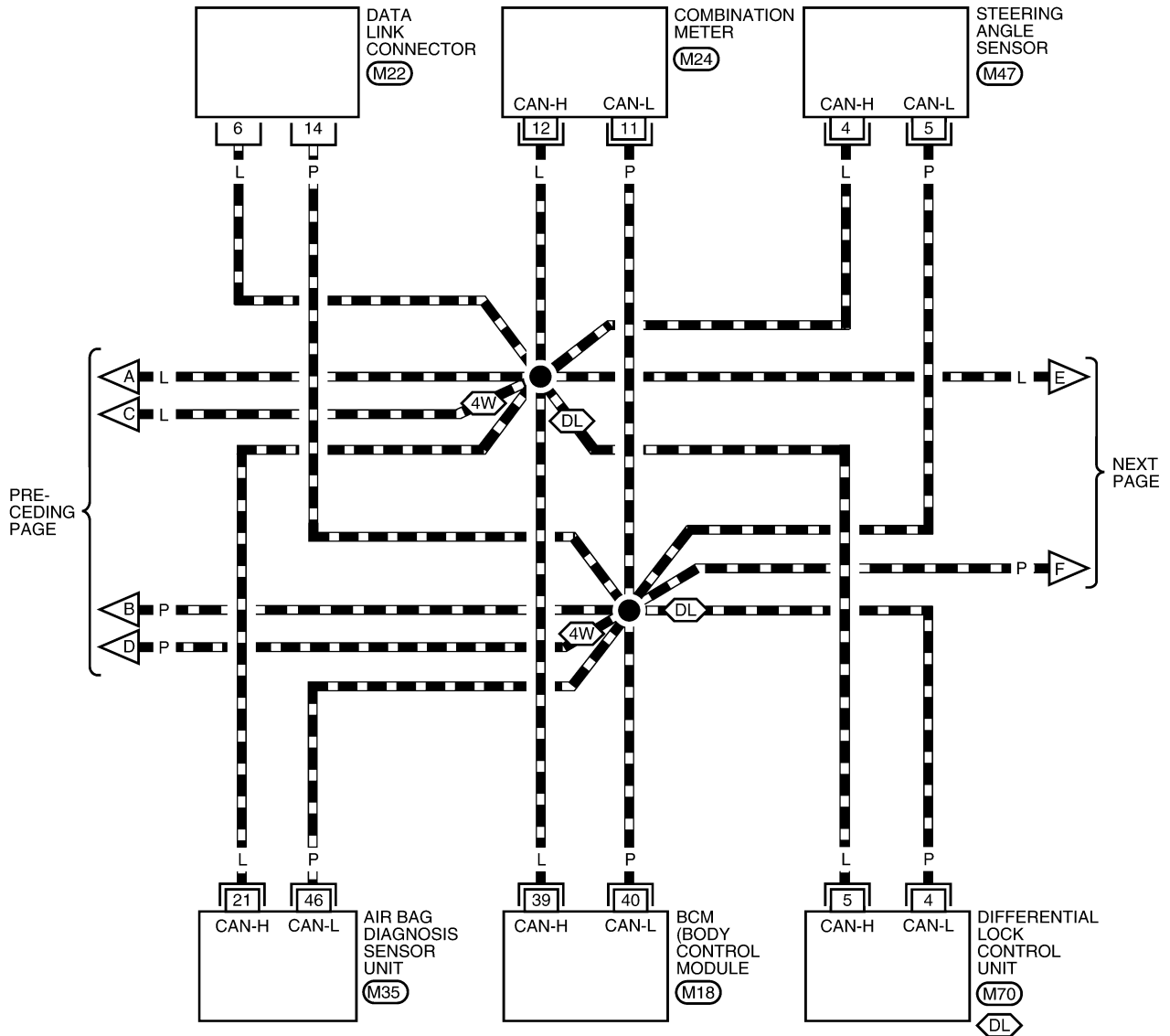

BKWA0722E



# TROUBLE DIAGNOSIS

[CAN]

## LAN-CAN-03

▬ : DATA LINE

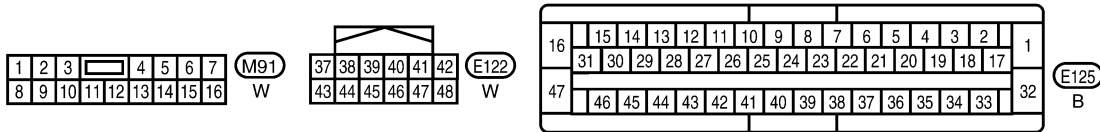
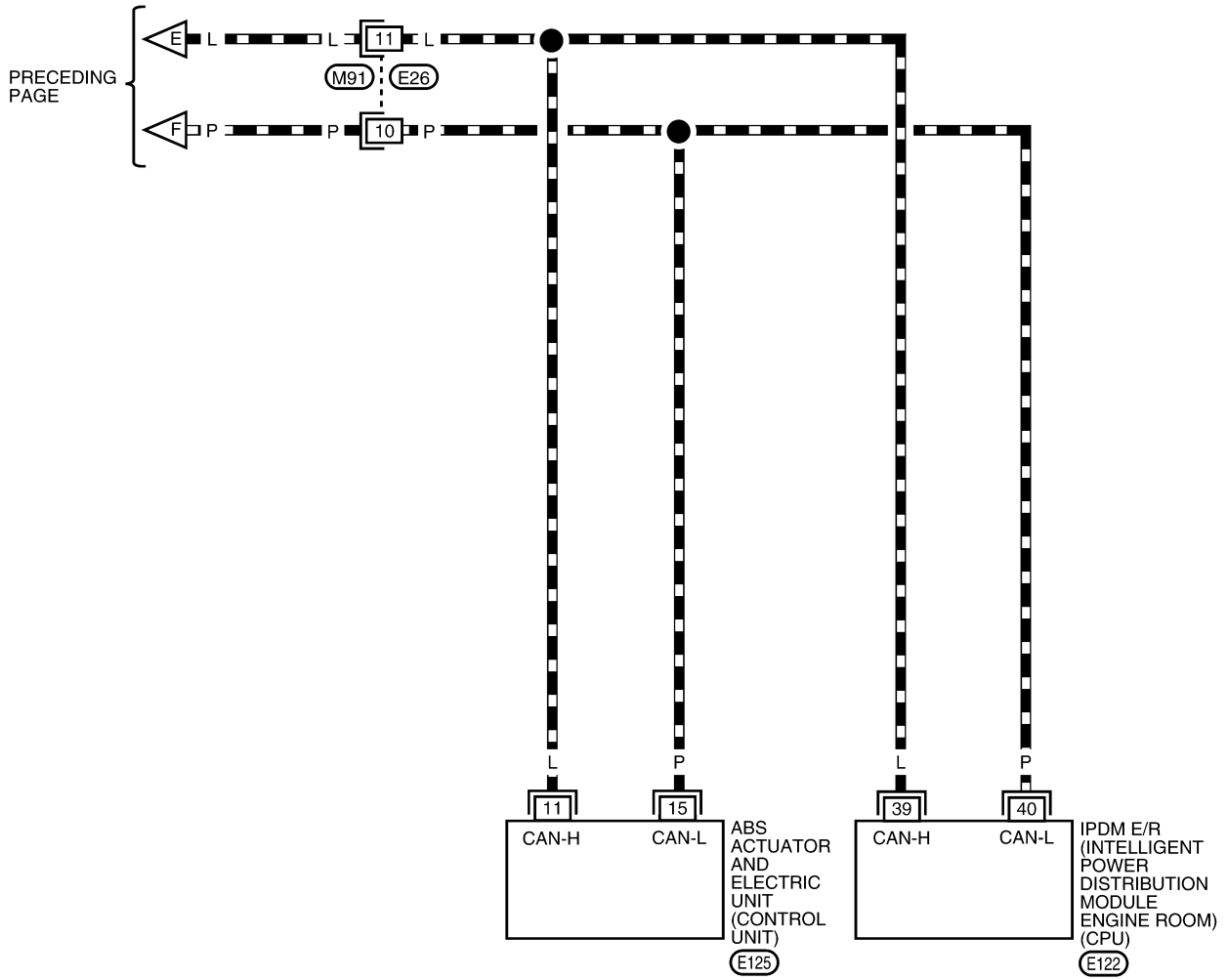

BKWA0723E

Interview Sheet

UKS006G5

CAN Communication System Diagnosis Interview Sheet

Date received:

Type:

VIN No.:

Model:

First registration:

Mileage:

CAN system type:

Symptom (Results from interview with customer)

Condition at inspection

Error symptom : Present / Past

SKIB8898E

# TROUBLE DIAGNOSIS

[CAN]

## Data Sheet

### CONSULT-II DATA ATTACHMENT SHEET

UKS006G6

A  
B  
C  
D  
E  
F  
G  
H  
I  
J  
LAN  
L  
M

<p>Attach printout of ALL MODE AWD/4WD SELF-DIAG RESULTS and CAN DIAG SUPPORT MNTR</p>
<p>Attach printout of A/T SELF-DIAG RESULTS and CAN DIAG SUPPORT MNTR</p>
<p>Attach printout of ENGINE SELF-DIAG RESULTS and CAN DIAG SUPPORT MNTR</p>
<p>Attach printout of SELECT SYSTEM</p>

PKID0617E

# TROUBLE DIAGNOSIS

[CAN]

Attach printout of  
ABS  
SELF-DIAG RESULTS  
and  
CAN DIAG SUPPORT MNTR

Attach printout of  
METER  
SELF-DIAG RESULTS  
and  
CAN DIAG SUPPORT MNTR

Attach printout of  
DIFF LOCK  
SELF-DIAG RESULTS  
and  
CAN DIAG SUPPORT MNTR

Attach printout of  
BCM  
SELF-DIAG RESULTS  
and  
CAN DIAG SUPPORT MNTR

PKID0618E

# TROUBLE DIAGNOSIS

[CAN]

Attach printout of  
IPDM E/R  
SELF-DIAG RESULTS  
and  
CAN DIAG SUPPORT MNTR

SKIB8770E

A

B

C

D

E

F

G

H

I

J

LAN

L

M

# TROUBLE DIAGNOSIS

[CAN]

UKS006G7

## CAN System (Type 1) DIAGNOSIS SHEET

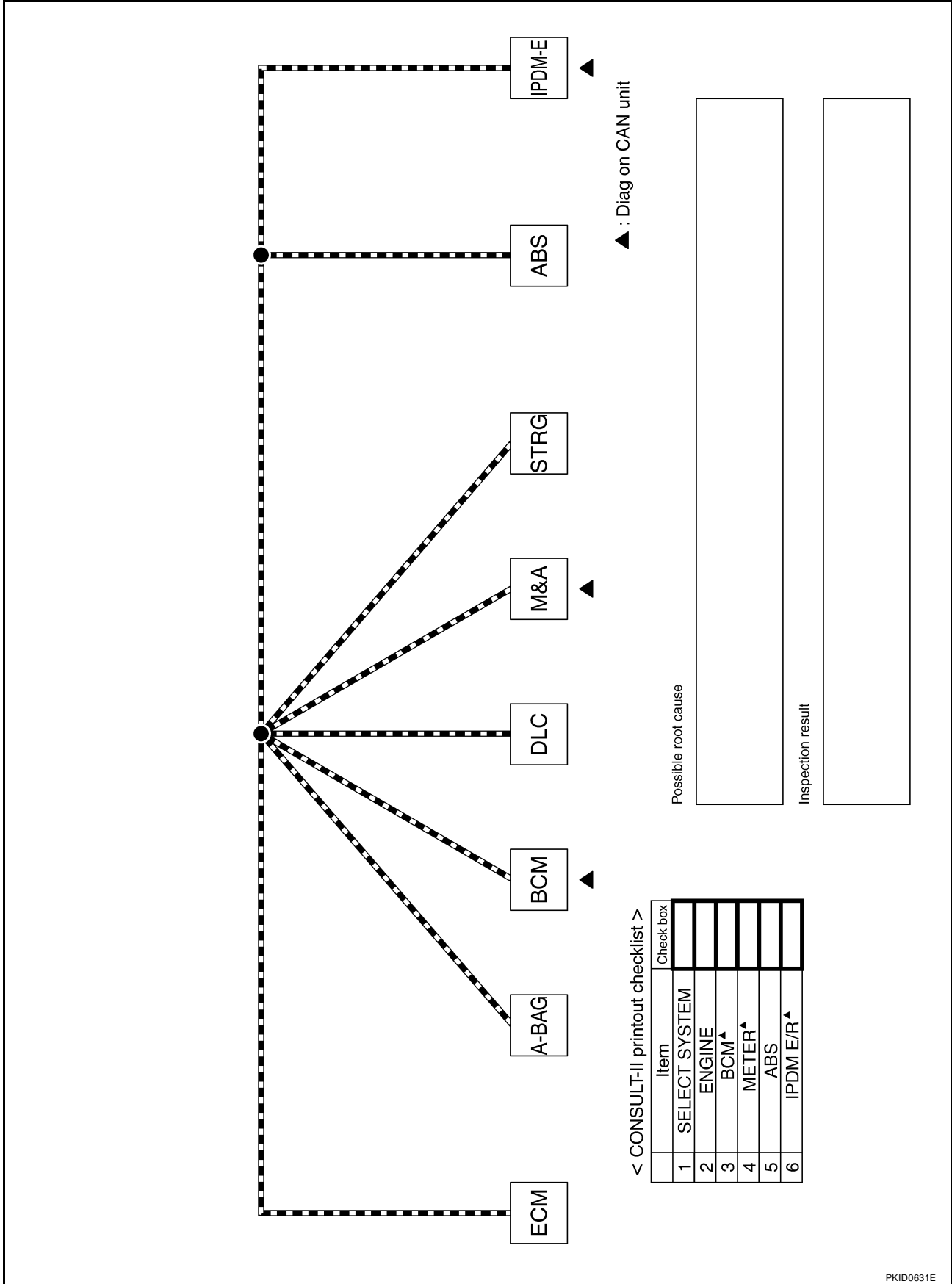

PKID0631E

# TROUBLE DIAGNOSIS

[CAN]

UKS006G8

## CAN System (Type 2) DIAGNOSIS SHEET

A  
B  
C  
D  
E  
F  
G  
H  
I  
J  
LAN  
L  
M

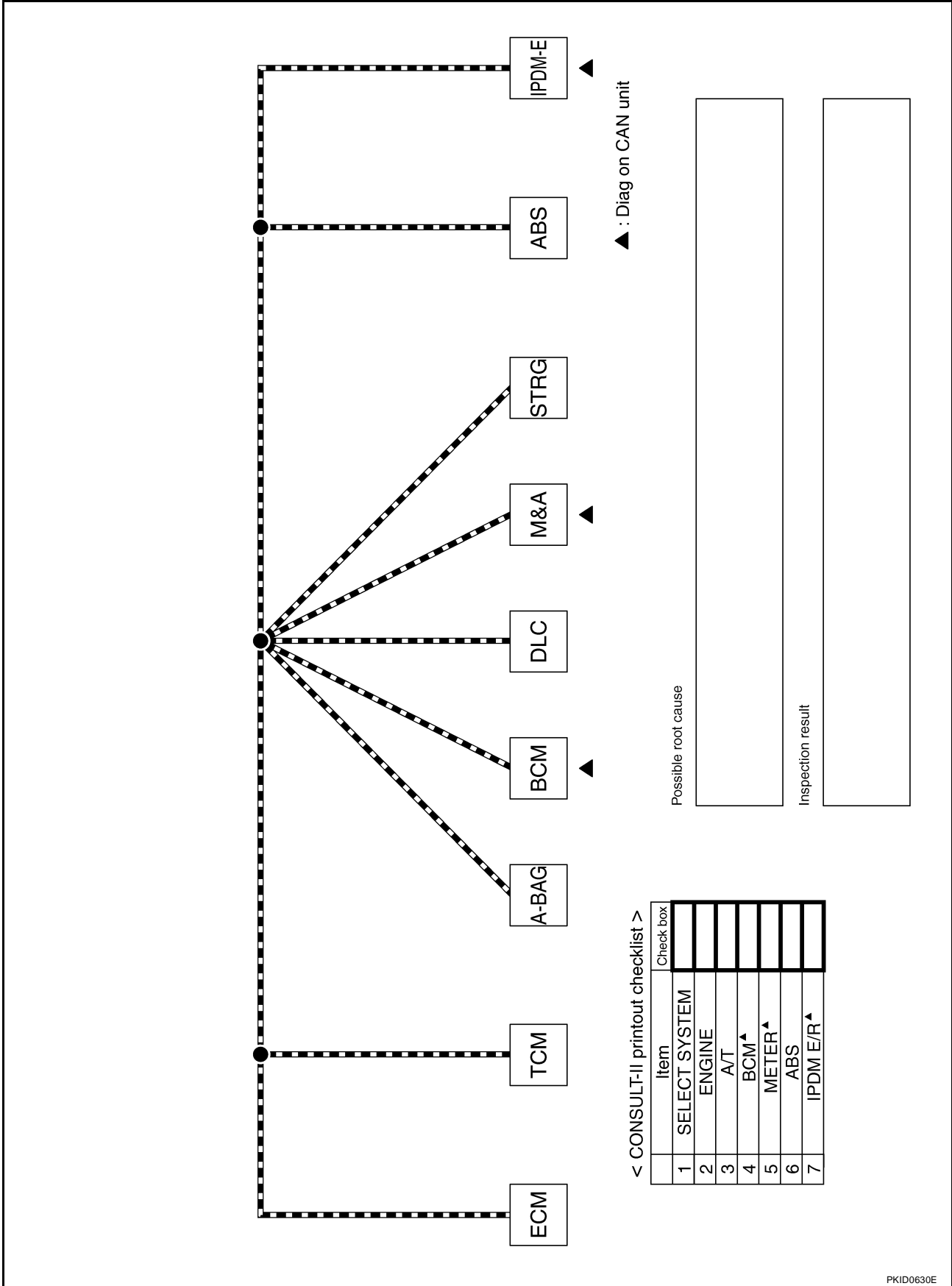

PKID0630E

# TROUBLE DIAGNOSIS

[CAN]

## CAN System (Type 3) DIAGNOSIS SHEET

UKS006G9

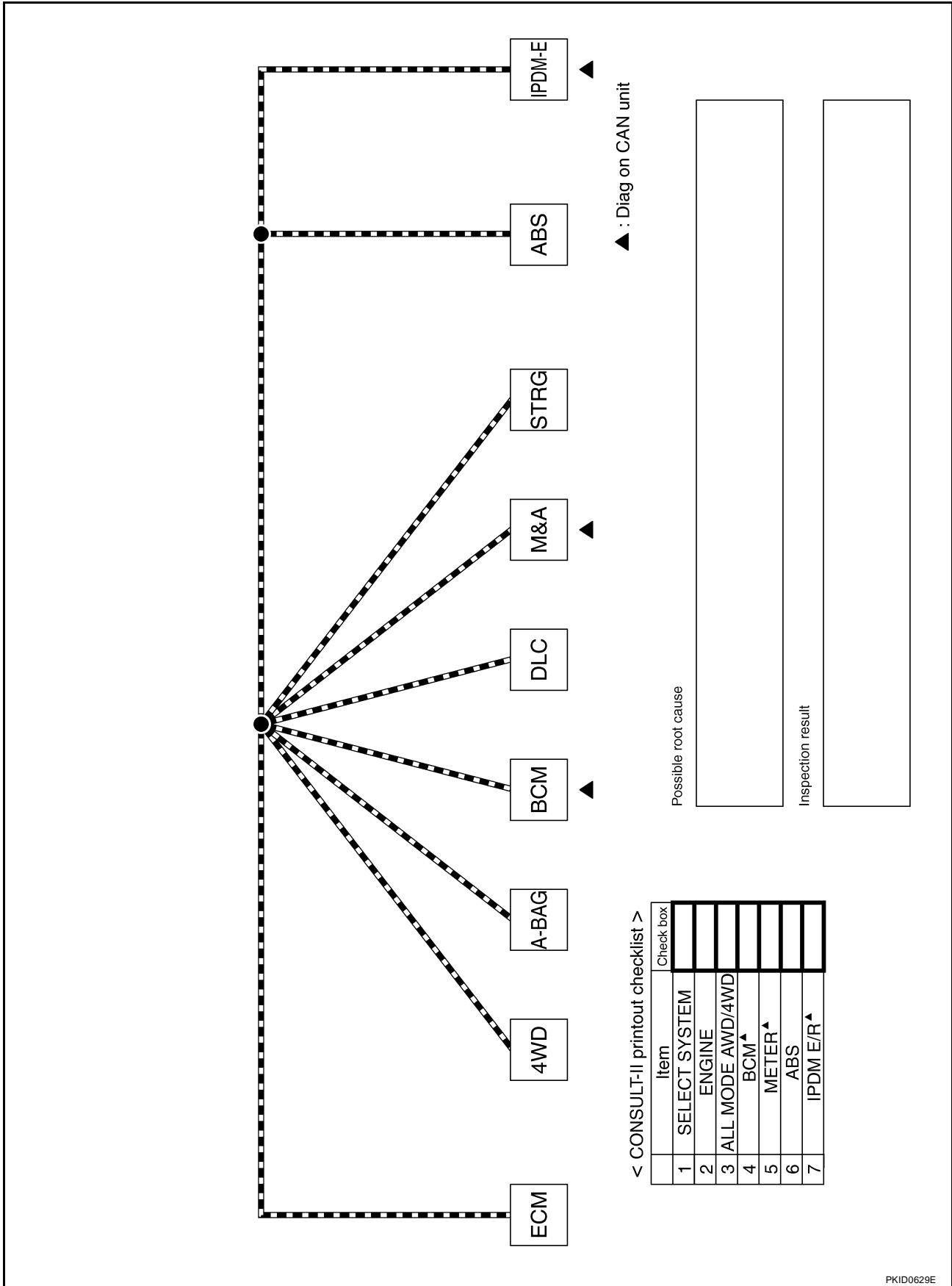

PKID0629E



# TROUBLE DIAGNOSIS

[CAN]

UKS006GA

## CAN System (Type 4) DIAGNOSIS SHEET

A  
B  
C  
D  
E  
F  
G  
H  
I  
J  
K  
L  
M

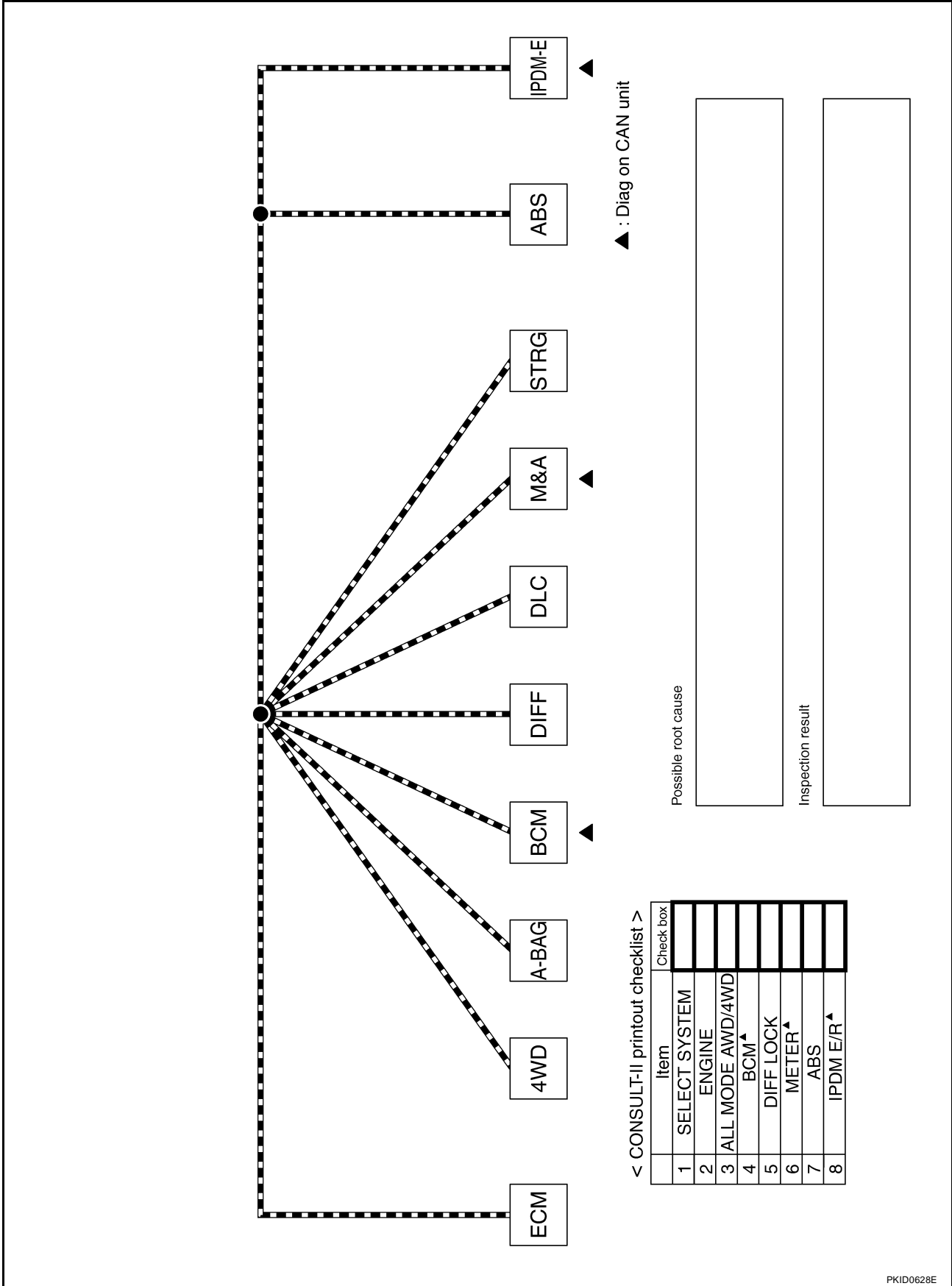

PKID0628E

# TROUBLE DIAGNOSIS

[CAN]

## CAN System (Type 5) DIAGNOSIS SHEET

UKS006GB

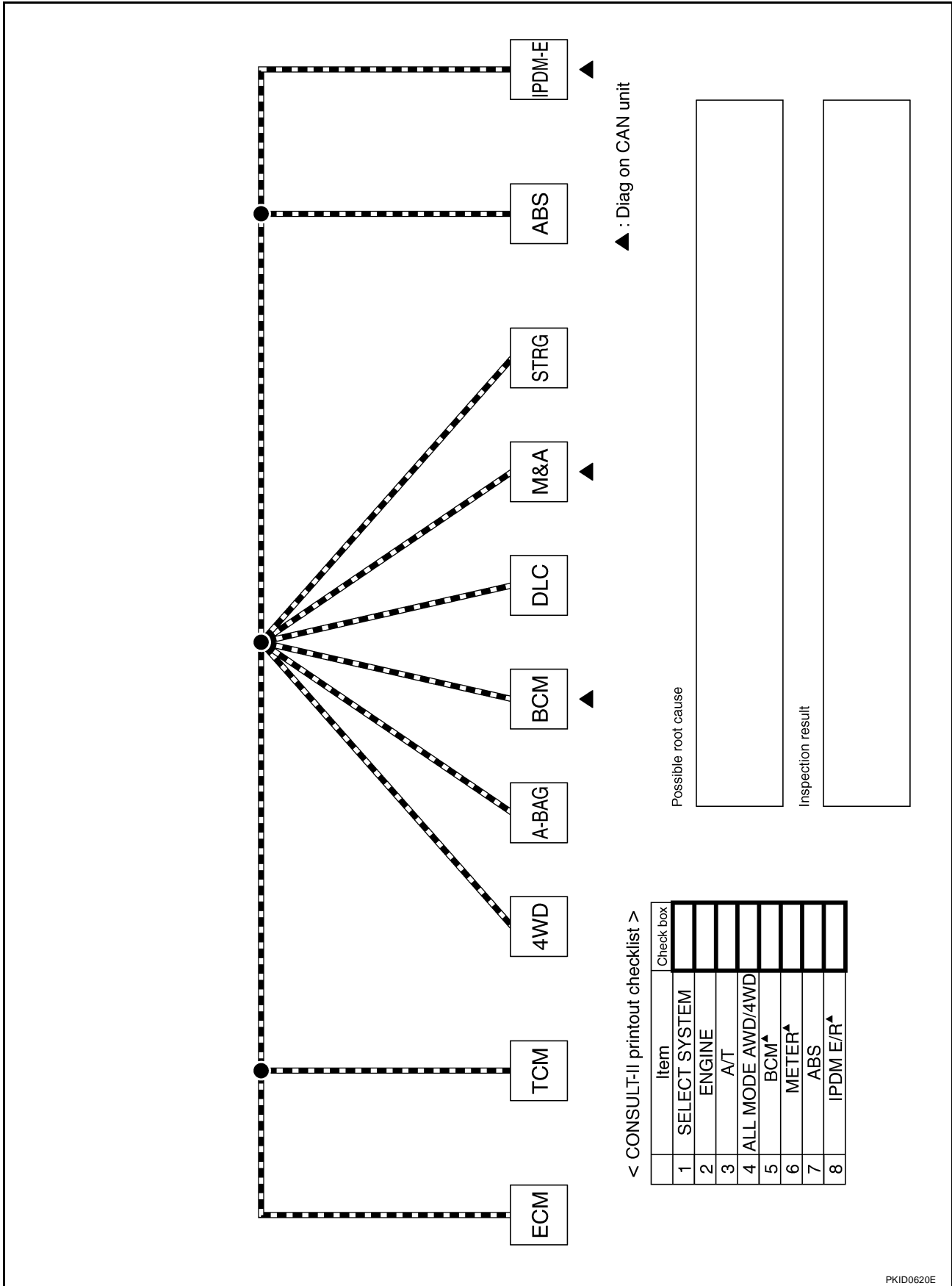

PKID0620E

# TROUBLE DIAGNOSIS

[CAN]

UKS006GC

## CAN System (Type 6) DIAGNOSIS SHEET

A  
B  
C  
D  
E  
F  
G  
H  
I  
J  
K  
L  
M

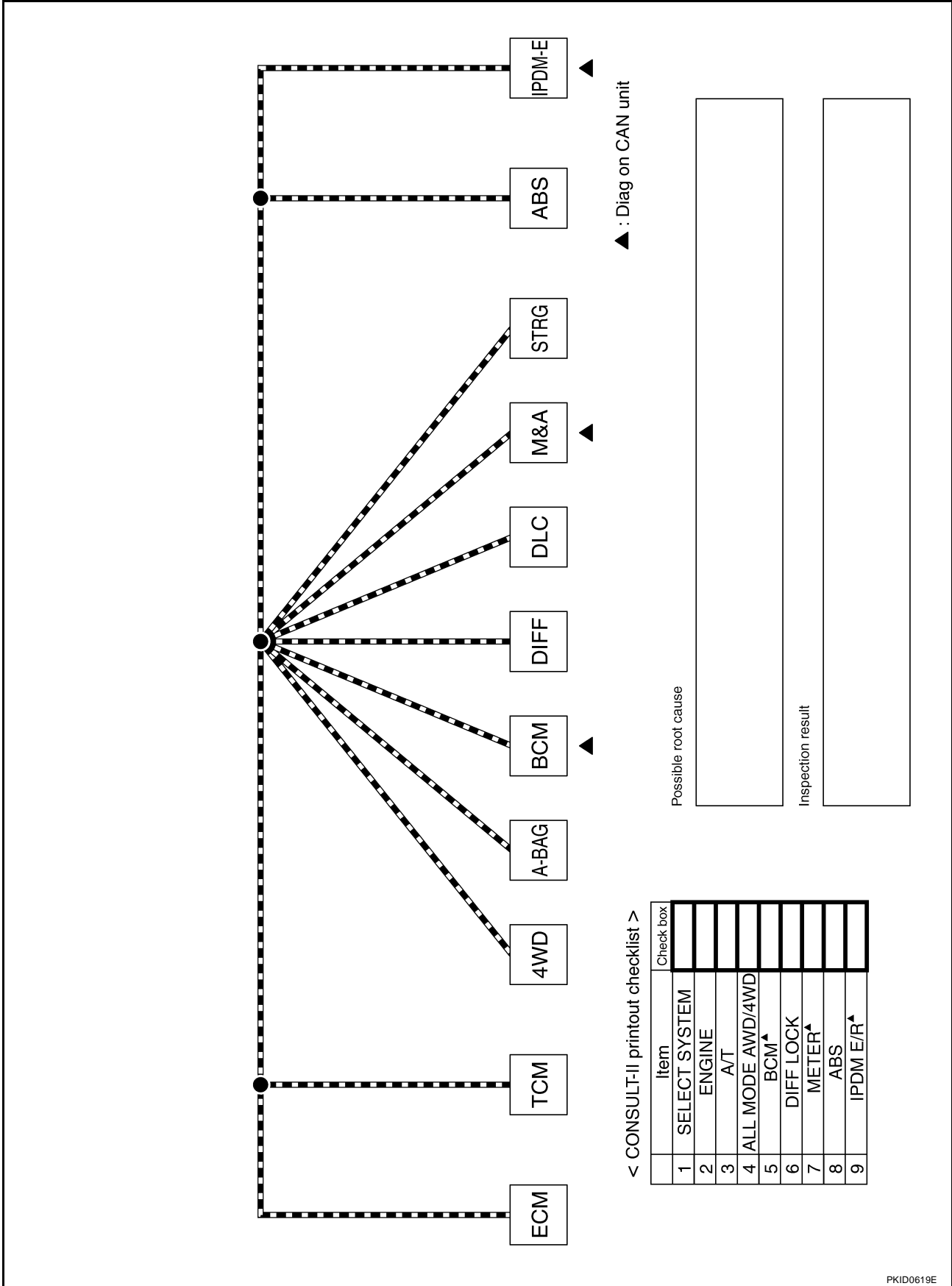

< CONSULT-II printout checklist >

Item	Check box
1 SELECT SYSTEM	<input type="checkbox"/>
2 ENGINE	<input type="checkbox"/>
3 A/T	<input type="checkbox"/>
4 ALL MODE AWD/4WD	<input type="checkbox"/>
5 BCM▲	<input type="checkbox"/>
6 DIFF LOCK	<input type="checkbox"/>
7 METER▲	<input type="checkbox"/>
8 ABS	<input type="checkbox"/>
9 IPDM E/R▲	<input type="checkbox"/>

LAN

PKID0619E

## Component Parts Location

UKS006GM

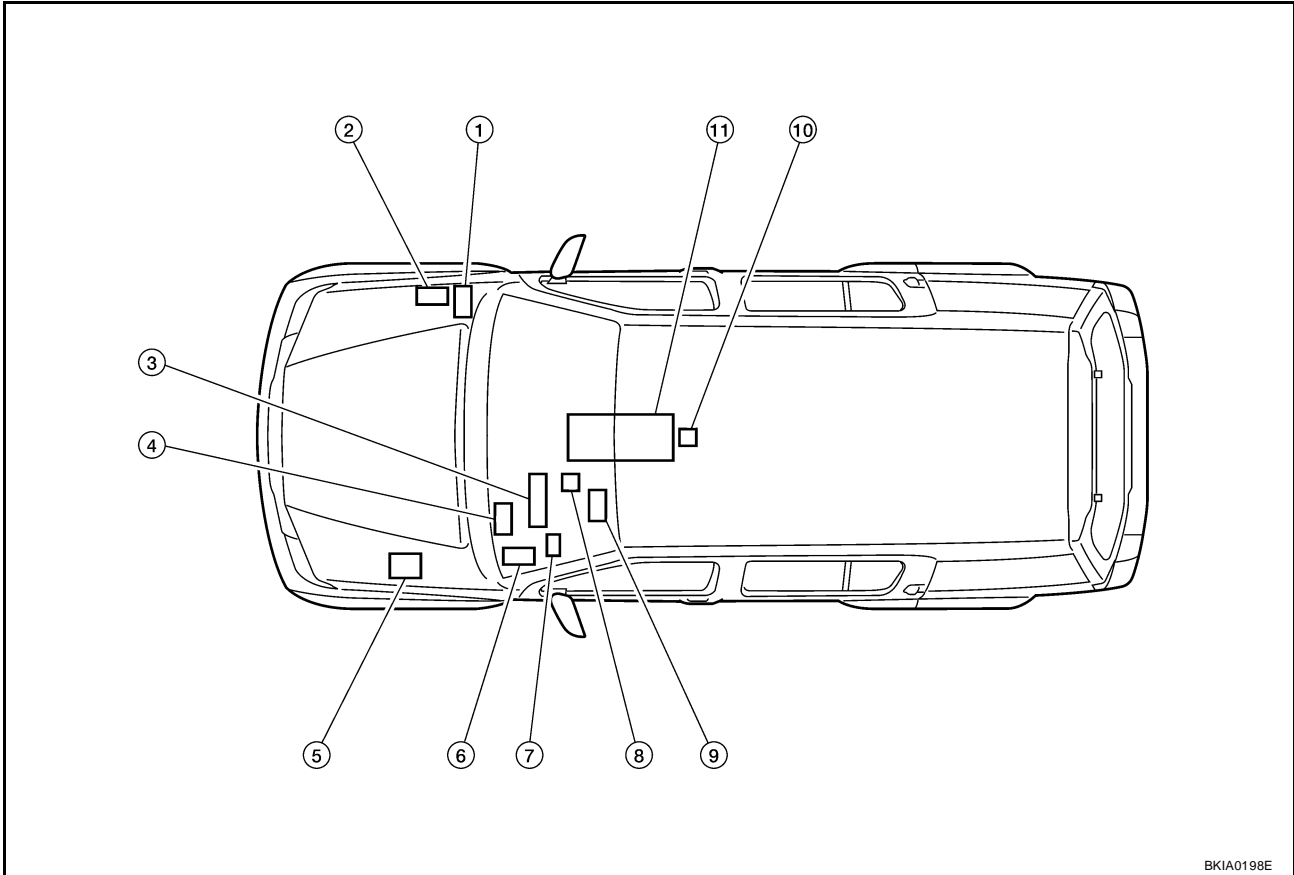

BKIA0198E

- |                                       |   |                               |
|---------------------------------------|---|-------------------------------|
| 1. IPDM E/R E122                      | 2. ECM E16  | 3. Combination meter M24      |
| 4. BCM M18                            | 5. ABS actuator and electric unit (control unit) E125 | 6. Transfer control unit M152 |
| 7. Differential lock control unit M70 | 8. Data link connector M22                            | 9. Steering angle sensor M47  |
| 10. Air bag diagnosis sensor unit M35 | 11. A/T assembly F9                                   |                               |

## Harness Layout

UKS006GN

Refer to [PG-43, "Harness Layout"](#) .

# TROUBLE DIAGNOSIS

[CAN]

UKS006GO

## Malfunction Area Chart

### MAIN LINE

Malfunction Area	Reference
Main line between TCM and data link connector	<a href="#">LAN-70, "Main Line Between TCM and Data Link Connector"</a>
Main line between data link connector and ABS actuator and electric unit (control unit)	<a href="#">LAN-71, "Main Line Between Data Link Connector and ABS Actuator and Electric Unit"</a>

### BRANCH LINE

Malfunction Area	Reference
ECM branch line circuit	<a href="#">LAN-72, "ECM Branch Line Circuit"</a>
TCM branch line circuit	<a href="#">LAN-73, "TCM Branch Line Circuit"</a>
Transfer control unit branch line circuit	<a href="#">LAN-73, "Transfer Control Unit Branch Line Circuit"</a>
BCM branch line circuit	<a href="#">LAN-74, "BCM Branch Line Circuit"</a>
Differential lock control unit branch line circuit	<a href="#">LAN-75, "Differential Lock Control Unit Branch Line Circuit"</a>
Data link connector branch line circuit	<a href="#">LAN-75, "Data Link Connector Branch Line Circuit"</a>
Combination meter branch line circuit	<a href="#">LAN-76, "Combination Meter Branch Line Circuit"</a>
Steering angle sensor branch line circuit	<a href="#">LAN-77, "Steering Angle Sensor Branch Line Circuit"</a>
ABS actuator and electric unit (control unit) branch line circuit	<a href="#">LAN-77, "ABS Actuator and Electric Unit (Control Unit) Branch Line Circuit"</a>
IPDM E/R branch line circuit	<a href="#">LAN-78, "IPDM E/R Branch Line Circuit"</a>

### SHORT CIRCUIT

Malfunction Area	Reference
CAN communication circuit	<a href="#">LAN-79, "CAN Communication Circuit"</a>

A  
B  
C  
D  
E  
F  
G  
H  
I  
J  
L  
M

LAN

## Main Line Between TCM and Data Link Connector

### INSPECTION PROCEDURE

#### 1. CHECK CONNECTOR

1. Turn the ignition switch OFF.
2. Disconnect the battery cable from the negative terminal.
3. Check the following terminals and connectors for damage, bend and loose connection (connector side and harness side).
  - Harness connector F14
  - Harness connector E5
  - Harness connector E152
  - Harness connector M31

OK or NG

- OK >> GO TO 2.  
 NG >> Repair the terminal and connector.

#### 2. CHECK HARNESS CONTINUITY (OPEN CIRCUIT)

1. Disconnect the following harness connectors.
  - A/T assembly connector
  - Harness connector F14 and E5
2. Check the continuity between the A/T assembly harness connector and the harness connector.

A/T assembly harness connector		Harness connector		Continuity
Connector No.	Terminal No.	Connector No.	Terminal No.	
F9	3	F14	2	Yes
	8		3	Yes

OK or NG

- OK >> GO TO 3.  
 NG >> Repair the main line between the A/T assembly and the harness connector F14.

#### 3. CHECK HARNESS CONTINUITY (OPEN CIRCUIT)

1. Disconnect the harness connectors E152 and M31.
2. Check the continuity between harness connectors.

Harness connector		Harness connector		Continuity
Connector No.	Terminal No.	Connector No.	Terminal No.	
E5	2	E152	52G	Yes
	3		51G	Yes

OK or NG

- OK >> GO TO 4.  
 NG >> Repair the main line between the harness connector E5 and the harness connector E152.

**4. CHECK HARNESS CONTINUITY (OPEN CIRCUIT)**

Check the continuity between the harness connector and the data link connector.

Harness connector		Data link connector		Continuity
Connector No.	Terminal No.	Connector No.	Terminal No.	
M31	52G	M22	6	Yes
	51G		14	Yes

**OK or NG**

- OK >> ● Present error: Check the following items again.
- Decision of CAN system type.
  - Not received CONSULT-II data (SELECT SYSTEM, SELF-DIAG RESULTS, CAN DIAG SUPPORT MNTR).
  - Procedure for detecting root cause.
  - Past error: Error was detected in the main line between the A/T assembly and the data link connector.

NG >> Repair the main line between the harness connector M31 and the data link connector.

**Main Line Between Data Link Connector and ABS Actuator and Electric Unit**

UKS006GQ

**INSPECTION PROCEDURE****1. CHECK CONNECTOR**

1. Turn the ignition switch OFF.
2. Disconnect the battery cable from the negative terminal.
3. Check the following terminals and connectors for damage, bend and loose connection (connector side and harness side).
  - Harness connector M91
  - Harness connector E26

**OK or NG**

- OK >> GO TO 2.  
 NG >> Repair the terminal and connector.

**2. CHECK HARNESS CONTINUITY (OPEN CIRCUIT)**

1. Disconnect the harness connectors M91 and E26.
2. Check the continuity between the data link connector and the harness connector.

Data link connector		Harness connector		Continuity
Connector No.	Terminal No.	Connector No.	Terminal No.	
M22	6	M91	11	Yes
	14		10	Yes

**OK or NG**

- OK >> GO TO 3.  
 NG >> Repair the main line between the data link connector and the harness connector M91.

## 3. CHECK HARNESS CONTINUITY (OPEN CIRCUIT)

1. Disconnect the connector of ABS actuator and electric unit (control unit).
2. Check the continuity between the harness connector and the ABS actuator and electric unit (control unit) harness connector.

Harness connector		ABS actuator and electric unit (control unit) harness connector		Continuity
Connector No.	Terminal No.	Connector No.	Terminal No.	
E26	11	E125	11	Yes
	10		15	Yes

### OK or NG

- OK** >> ● Present error: Check the following items again.
- Decision of CAN system type.
  - Not received CONSULT-II data (SELECT SYSTEM, SELF-DIAG RESULTS, CAN DIAG SUPPORT MNTR).
  - Procedure for detecting root cause.
  - Past error: Error was detected in the main line between the data link connector and the ABS actuator and electric unit (control unit).
- NG** >> Repair the main line between the harness connector E26 and the ABS actuator and electric unit (control unit).

## ECM Branch Line Circuit

UKS006GR

### INSPECTION PROCEDURE

## 1. CHECK CONNECTOR

1. Turn the ignition switch OFF.
2. Disconnect the battery cable from the negative terminal.
3. Check the following terminals and connectors for damage, bend and loose connection (unit side and connector side).
  - M/T models
    - ECM connector
    - Harness connector E152
    - Harness connector M31
  - A/T models
    - ECM connector
    - Harness connector E2
    - Harness connector F32

### OK or NG

- OK** >> GO TO 2.
- NG** >> Repair the terminal and connector.

## 2. CHECK HARNESS FOR OPEN CIRCUIT

1. Disconnect the connector of ECM.
2. Check the resistance between the ECM harness connector terminals.

ECM harness connector			Resistance (Ω)
Connector No.	Terminal No.		
E16	94	86	Approx. 108 – 132

### OK or NG

- OK** >> GO TO 3.
- NG** >> Repair the ECM branch line.



**3. CHECK POWER SUPPLY AND GROUND CIRCUIT**

Check the power supply and the ground circuit of the ECM. Refer to [EC-148, "POWER SUPPLY AND GROUND CIRCUIT"](#) .

OK or NG

- OK >> ● Present error: Replace the ECM. Refer to [EC-77, "Procedure After Replacing ECM"](#) .
  - Past error: Error was detected in the ECM branch line.
- NG >> Repair the power supply and the ground circuit.

**TCM Branch Line Circuit**

UKS006GS

INSPECTION PROCEDURE

**1. CHECK CONNECTOR**

1. Turn the ignition switch OFF.
2. Disconnect the battery cable from the negative terminal.
3. Check the terminals and connectors of the A/T assembly for damage, bend and loose connection (unit side and connector side).

OK or NG

- OK >> GO TO 2.
- NG >> Repair the terminal and connector.

**2. CHECK HARNESS FOR OPEN CIRCUIT**

1. Disconnect the connector of A/T assembly.
2. Check the resistance between the A/T assembly harness connector terminals.

A/T assembly harness connector			Resistance (Ω)
Connector No.	Terminal No.		
F9	3	8	Approx. 54 – 66

OK or NG

- OK >> GO TO 3.
- NG >> Repair the TCM branch line.

**3. CHECK POWER SUPPLY AND GROUND CIRCUIT**

Check the power supply and the ground circuit of the TCM. Refer to [AT-168, "MAIN POWER SUPPLY AND GROUND CIRCUIT"](#) .

OK or NG

- OK >> ● Present error: Replace the control valve with the TCM. Refer to [AT-229, "CONTROL VALVE WITH TCM REMOVAL AND INSTALLATION"](#) .
  - Past error: Error was detected in the TCM branch line.
- NG >> Repair the power supply and the ground circuit.

**Transfer Control Unit Branch Line Circuit**

UKS006GT

INSPECTION PROCEDURE

**1. CHECK CONNECTOR**

1. Turn the ignition switch OFF.
2. Disconnect the battery cable from the negative terminal.
3. Check the terminals and connectors of the transfer control unit for damage, bend and loose connection (unit side and connector side).

OK or NG

- OK >> GO TO 2.
- NG >> Repair the terminal and connector.

A  
B  
C  
D  
E  
F  
G  
H  
I  
J

LAN

L  
M

## 2. CHECK HARNESS FOR OPEN CIRCUIT

1. Disconnect the connector of transfer control unit.
2. Check the resistance between the transfer control unit harness connector terminals.

Transfer control unit harness connector			Resistance (Ω)
Connector No.	Terminal No.		
M152	1	2	Approx. 54 – 66

OK or NG

- OK >> GO TO 3.
- NG >> Repair the transfer control unit branch line.

## 3. CHECK POWER SUPPLY AND GROUND CIRCUIT

Check the power supply and the ground circuit of the transfer control unit. Refer to [TF-51, "Power Supply Circuit For Transfer Control Unit"](#) .

OK or NG

- OK >> ● Present error: Replace the transfer control unit. Refer to [TF-102, "Removal and Installation"](#) .  
● Past error: Error was detected in the transfer control unit branch line.
- NG >> Repair the power supply and the ground circuit.

## BCM Branch Line Circuit

UKS006GU

INSPECTION PROCEDURE

### 1. CHECK CONNECTOR

1. Turn the ignition switch OFF.
2. Disconnect the battery cable from the negative terminal.
3. Check the terminals and connectors of the BCM for damage, bend and loose connection (unit side and connector side).

OK or NG

- OK >> GO TO 2.
- NG >> Repair the terminal and connector.

### 2. CHECK HARNESS FOR OPEN CIRCUIT

1. Disconnect the connector of BCM.
2. Check the resistance between the BCM harness connector terminals.

BCM harness connector			Resistance (Ω)
Connector No.	Terminal No.		
M18	39	40	Approx. 54 – 66

OK or NG

- OK >> GO TO 3.
- NG >> Repair the BCM branch line.

### 3. CHECK POWER SUPPLY AND GROUND CIRCUIT

Check the power supply and the ground circuit of the BCM. Refer to [BCS-16, "BCM Power Supply and Ground Circuit Check"](#) .

OK or NG

- OK >> ● Present error: Replace the BCM. Refer to [BCS-25, "Removal and Installation of BCM"](#) .  
● Past error: Error was detected in the BCM branch line.
- NG >> Repair the power supply and the ground circuit.

**Differential Lock Control Unit Branch Line Circuit**

## INSPECTION PROCEDURE

**1. CHECK CONNECTOR**

1. Turn the ignition switch OFF.
2. Disconnect the battery cable from the negative terminal.
3. Check the terminals and connectors of the differential lock control unit for damage, bend and loose connection (unit side and connector side).

OK or NG

- OK >> GO TO 2.  
 NG >> Repair the terminal and connector.

**2. CHECK HARNESS FOR OPEN CIRCUIT**

1. Disconnect the connector of differential lock control unit.
2. Check the resistance between the differential lock control unit harness connector terminals.

Differential lock control unit harness connector			Resistance ( $\Omega$ )
Connector No.	Terminal No.		
M70	5	4	Approx. 54 – 66

OK or NG

- OK >> GO TO 3.  
 NG >> Repair the differential lock control unit branch line.

**3. CHECK POWER SUPPLY AND GROUND CIRCUIT**

Check the power supply and the ground circuit of the differential lock control unit. Refer to [RFD-91, "Power Supply Circuit For Differential Lock Control Unit"](#).

OK or NG

- OK >> ● Present error: Replace the differential lock control unit. Refer to [RFD-110, "Removal and Installation"](#).  
 ● Past error: Error was detected in the differential lock control unit branch line.  
 NG >> Repair the power supply and the ground circuit.

**Data Link Connector Branch Line Circuit**

## INSPECTION PROCEDURE

**1. CHECK CONNECTOR**

1. Turn the ignition switch OFF.
2. Disconnect the battery cable from the negative terminal.
3. Check the terminals and connectors of the data link connector for damage, bend and loose connection (connector side and harness side).

OK or NG

- OK >> GO TO 2.  
 NG >> Repair the terminal and connector.

## 2. CHECK HARNESS FOR OPEN CIRCUIT

Check the resistance between the data link connector terminals.

Data link connector			Resistance (Ω)
Connector No.	Terminal No.		
M22	6	14	Approx. 54 – 66

OK or NG

- OK >> ● Present error: Check the following items again.
- Decision of CAN system type.
  - Not received CONSULT-II data (SELECT SYSTEM, SELF-DIAG RESULTS, CAN DIAG SUPPORT MNTR).
  - Procedure for detecting root cause.
- Past error: Error was detected in the data link connector branch line circuit.

NG >> Repair the data link connector branch line.

### Combination Meter Branch Line Circuit

UKS006GX

INSPECTION PROCEDURE

## 1. CHECK CONNECTOR

1. Turn the ignition switch OFF.
2. Disconnect the battery cable from the negative terminal.
3. Check the terminals and connectors of the combination meter for damage, bend and loose connection (unit side and connector side).

OK or NG

- OK >> GO TO 2.  
 NG >> Repair the terminal and connector.

## 2. CHECK HARNESS FOR OPEN CIRCUIT

1. Disconnect the connector of combination meter.
2. Check the resistance between the combination meter harness connector terminals.

Combination meter harness connector			Resistance (Ω)
Connector No.	Terminal No.		
M24	12	11	Approx. 54 – 66

OK or NG

- OK >> GO TO 3.  
 NG >> Repair the combination meter branch line.

## 3. CHECK POWER SUPPLY AND GROUND CIRCUIT

Check the power supply and the ground circuit of the combination meter. Refer to [DI-18, "Power Supply and Ground Circuit Inspection"](#) .

OK or NG

- OK >> ● Present error: Replace the combination meter. Refer to [DI-23, "Removal and Installation"](#) .
- Past error: Error was detected in the combination meter branch line.
- NG >> Repair the power supply and the ground circuit.

**Steering Angle Sensor Branch Line Circuit**

## INSPECTION PROCEDURE

**1. CHECK CONNECTOR**

1. Turn the ignition switch OFF.
2. Disconnect the battery cable from the negative terminal.
3. Check the terminals and connectors of the steering angle sensor for damage, bend and loose connection (unit side and connector side).

OK or NG

- OK >> GO TO 2.  
 NG >> Repair the terminal and connector.

**2. CHECK HARNESS FOR OPEN CIRCUIT**

1. Disconnect the connector of steering angle sensor.
2. Check the resistance between the steering angle sensor harness connector terminals.

Steering angle sensor harness connector			Resistance ( $\Omega$ )
Connector No.	Terminal No.		
M47	4	5	Approx. 54 – 66

OK or NG

- OK >> GO TO 3.  
 NG >> Repair the steering angle sensor branch line.

**3. CHECK POWER SUPPLY AND GROUND CIRCUIT**

Check the power supply and the ground circuit of the steering angle sensor. Refer to [BRC-16, "Schematic"](#) (VDC/TCS/ABS) or [BRC-77, "Schematic"](#) (HDC/HSA/VDC/TCS/ABS).

OK or NG

- OK >> ● Present error: Replace the steering angle sensor. Refer to [BRC-62, "Removal and Installation"](#) (VDC/TCS/ABS) or [BRC-131, "Removal and Installation"](#) (HDC/HSA/VDC/TCS/ABS).  
 ● Past error: Error was detected in the steering angle sensor branch line.
- NG >> Repair the power supply and the ground circuit.

**ABS Actuator and Electric Unit (Control Unit) Branch Line Circuit**

## INSPECTION PROCEDURE

**1. CHECK CONNECTOR**

1. Turn the ignition switch OFF.
2. Disconnect the battery cable from the negative terminal.
3. Check the terminals and connectors of the ABS actuator and electric unit (control unit) for damage, bend and loose connection (unit side and connector side).

OK or NG

- OK >> GO TO 2.  
 NG >> Repair the terminal and connector.

## 2. CHECK HARNESS FOR OPEN CIRCUIT

1. Disconnect the connector of ABS actuator and electric unit (control unit).
2. Check the resistance between the ABS actuator and electric unit (control unit) harness connector terminals.

ABS actuator and electric unit (control unit) harness connector			Resistance (Ω)
Connector No.	Terminal No.		
E125	11	15	Approx. 54 – 66

OK or NG

- OK >> GO TO 3.  
 NG >> Repair the ABS actuator and electric unit (control unit) branch line.

## 3. CHECK POWER SUPPLY AND GROUND CIRCUIT

Check the power supply and the ground circuit of the ABS actuator and electric unit (control unit). Refer to [BRC-16, "Schematic"](#) (VDC/TCS/ABS) or [BRC-77, "Schematic"](#) (HDC/HSA/VDC/TCS/ABS).

OK or NG

- OK >> ● Present error: Replace the ABS actuator and electric unit (control unit). Refer to [BRC-60, "Removal and Installation"](#) (VDC/TCS/ABS) or [BRC-129, "Removal and Installation"](#) (HDC/HSA/VDC/TCS/ABS).  
 ● Past error: Error was detected in the ABS actuator and electric unit (control unit) branch line.
- NG >> Repair the power supply and the ground circuit.

## IPDM E/R Branch Line Circuit

UKS006H0

INSPECTION PROCEDURE

### 1. CHECK CONNECTOR

1. Turn the ignition switch OFF.
2. Disconnect the battery cable from the negative terminal.
3. Check the terminals and connectors of the IPDM E/R for damage, bend and loose connection (unit side and connector side).

OK or NG

- OK >> GO TO 2.  
 NG >> Repair the terminal and connector.

### 2. CHECK HARNESS FOR OPEN CIRCUIT

1. Disconnect the connector of IPDM E/R.
2. Check the resistance between the IPDM E/R harness connector terminals.

IPDM E/R harness connector			Resistance (Ω)
Connector No.	Terminal No.		
E122	39	40	Approx. 108 – 132

OK or NG

- OK >> GO TO 3.  
 NG >> Repair the IPDM E/R branch line.

## 3. CHECK POWER SUPPLY AND GROUND CIRCUIT

Check the power supply and the ground circuit of the IPDM E/R. Refer to [PG-29, "IPDM E/R Power/Ground Circuit Inspection"](#).

OK or NG

OK >> ● Present error: Replace the IPDM E/R. Refer to [PG-32, "Removal and Installation of IPDM E/R"](#)

● Past error: Error was detected in the IPDM E/R branch line.

NG >> Repair the power supply and the ground circuit.

## CAN Communication Circuit

UKS006H1

### INSPECTION PROCEDURE

#### 1. CONNECTOR INSPECTION

1. Turn the ignition switch OFF
2. Disconnect the battery cable from the negative terminal.
3. Disconnect all the unit connectors on CAN communication system.
4. Check terminals and connectors for damage, bend and loose connection.

OK or NG

OK >> GO TO 2.

NG >> Repair the terminal and connector.

#### 2. CHECK HARNESS CONTINUITY (SHORT CIRCUIT)

Check the continuity between the data link connector terminals.

Data link connector		Continuity
Connector No.	Terminal No.	
M22	6                      14	No

OK or NG

OK >> GO TO 3.

NG >> Check the harness and repair the root cause.

#### 3. CHECK HARNESS CONTINUITY (SHORT CIRCUIT)

Check the continuity between the data link connector and the ground.

Data link connector		Ground	Continuity
Connector No.	Terminal No.		
M22	6	Ground	No
	14		No

OK or NG

OK >> GO TO 4.

NG >> Check the harness and repair the root cause.

A  
B  
C  
D  
E  
F  
G  
H  
I  
J  
LAN  
L  
M

## 4. CHECK ECM AND IPDM E/R TERMINATION CIRCUIT

1. Remove the ECM and the IPDM E/R.
2. Check the resistance between the ECM terminals.

ECM		Resistance (Ω)
Terminal No.		
94	86	Approx. 108 – 132

3. Check the resistance between the IPDM E/R terminals.

IPDM E/R		Resistance (Ω)
Terminal No.		
39	40	Approx. 108 – 132

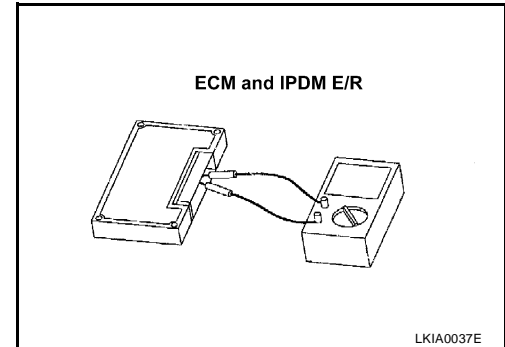

**OK or NG**

- OK >> GO TO 5.
- NG >> Replace the ECM and/or the IPDM E/R.

## 5. CHECK SYMPTOM

Connect all the connectors. Check if the symptoms described in the “Symptom (Results from interview with customer)” are reproduced.

Inspection result

- Reproduced>>GO TO 6.
- Non-reproduced>>Start the diagnosis again. Follow the trouble diagnosis procedure when past error is detected.

## 6. CHECK UNIT REPRODUCTION

Perform the reproduction test as per the following procedure for each unit.

1. Turn the ignition switch OFF
2. Disconnect the battery cable from the negative terminal.
3. Disconnect all the unit connectors on CAN communication system.

**NOTE:**

ECM and IPDM E/R have a termination circuit. Check other units first.

4. Connect the battery cable to the negative terminal. Check if the symptoms described in the “Symptom (Results from interview with customer)” are reproduced.

**NOTE:**

Although unit-related error symptoms occur, do not confuse them with other symptoms.

Inspection result

- Reproduced>>Connect the connector. Check other units as per the above procedure.
- Non-reproduced>>Replace the unit whose connector was disconnected.