

## SECTION **GI**

**GI**

MA

EM

LC

EC

FE

AT

FA

RA

BR

ST

RS

BT

HA

EL

IDX

## CONTENTS

<b>PRECAUTIONS</b> .....	2	Notice.....	28
Precautions for Supplemental Restraint System (SRS) "AIR BAG" .....	2	How To Follow This Flowchart .....	29
General Precautions .....	2	<b>CONSULT CHECKING SYSTEM</b> .....	32
Precautions for Multiport Fuel Injection System.....	4	Function and System Application .....	32
Precautions for Three Way Catalyst.....	4	Lithium Battery Replacement.....	32
Engine Oils.....	4	Checking Equipment.....	32
Precautions for Fuel.....	5	<b>IDENTIFICATION INFORMATION</b> .....	33
Precautions for Air Conditioning .....	5	Model Variation .....	33
<b>HOW TO USE THIS MANUAL</b> .....	6	Identification Number .....	34
<b>HOW TO READ WIRING DIAGRAMS</b> .....	8	Dimensions .....	35
Sample/Wiring Diagram -EXAMPL-.....	8	Wheels and Tires .....	35
Description .....	10	<b>LIFTING POINTS AND TOW TRUCK TOWING</b> .....	36
Wiring Diagram Codes (Cell Codes) .....	16	Preparation.....	36
<b>HOW TO PERFORM EFFICIENT DIAGNOSIS FOR AN ELECTRICAL INCIDENT</b> .....	17	Board-on Lift .....	36
Work Flow.....	17	Garage Jack and Safety Stand .....	37
Incident Simulation Tests .....	18	2-pole Lift .....	37
Circuit Inspection .....	22	Tow Truck Towing .....	38
<b>HOW TO FOLLOW FLOW CHART IN TROUBLE DIAGNOSES</b> .....	28	<b>TIGHTENING TORQUE OF STANDARD BOLTS</b> ...	39
		<b>SAE J1930 TERMINOLOGY LIST</b> .....	40

## PRECAUTIONS

Observe the following precautions to ensure safe and proper servicing.



### Precautions for Supplemental Restraint System (SRS) "AIR BAG"

The Supplemental Restraint System "Air Bag", used along with a seat belt, helps to reduce the risk or severity of injury to the driver and front passenger in a frontal collision. The Supplemental Restraint System consists of air bag modules (located in the center of the steering wheel and on the instrument panel on the passenger side), a diagnosis sensor unit, warning lamp, wiring harness and spiral cable. Information necessary to service the system safely is included in the **RS section** of this Service Manual.

#### WARNING:

- To avoid rendering the SRS inoperative, which could increase the risk of personal injury or death in the event of a collision which would result in air bag inflation, all maintenance must be performed by an authorized NISSAN dealer.
- Improper maintenance, including incorrect removal and installation of the SRS, can lead to personal injury caused by unintentional activation of the system.
- Do not use electrical test equipment on any circuit related to the SRS unless instructed to in this Service Manual. SRS wiring harnesses are covered with yellow insulation either just before the harness connectors or for the complete harness, for easy identification.

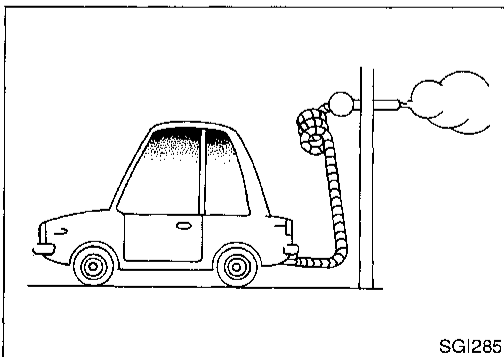

### General Precautions

- Do not operate the engine for an extended period of time without proper exhaust ventilation. Keep the work area well ventilated and free of any flammable materials. Special care should be taken when handling any flammable or poisonous materials, such as gasoline, refrigerant gas, etc. When working in a pit or other enclosed area, be sure to properly ventilate the area before working with hazardous materials. Do not smoke while working on the vehicle.

## PRECAUTIONS

### General Precautions (Cont'd)

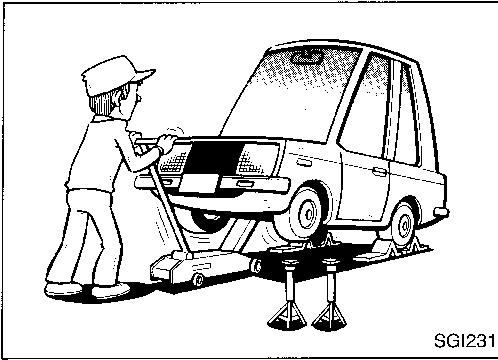

- Before jacking up the vehicle, apply wheel chocks or tire blocks to the wheels to prevent the vehicle from moving. After jacking up the vehicle, support the vehicle weight with safety stands at the points designated for proper lifting before working on the vehicle.

These operations should be done on a level surface.

- When removing a heavy component such as the engine or transaxle, be careful not to lose your balance and drop them. Also, do not allow them to strike adjacent parts, especially the brake tubes and master cylinder.

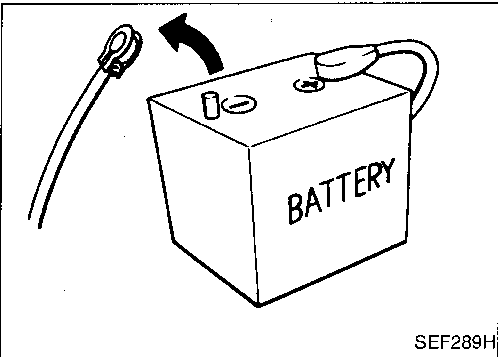

- Before starting repairs which do not require battery power: Turn off ignition switch. Disconnect the negative battery terminal.

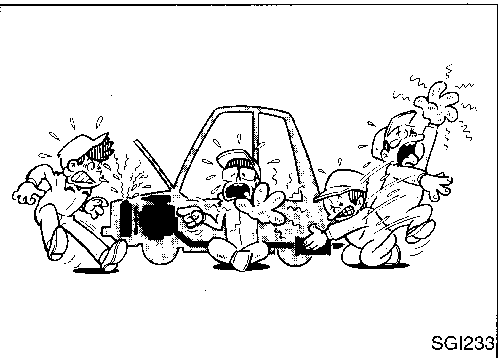

- To prevent serious burns: Avoid contact with hot metal parts. Do not remove the radiator cap when the engine is hot.

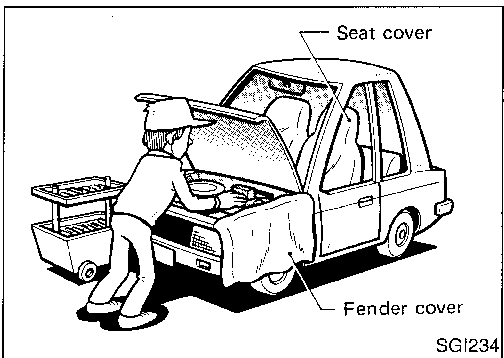

- Before servicing the vehicle: Protect fenders, upholstery and carpeting with appropriate covers. Take caution that keys, buckles or buttons do not scratch paint.

- Clean all disassembled parts in the designated liquid or solvent prior to inspection or assembly.
- Replace oil seals, gaskets, packings, O-rings, locking washers, cotter pins and self-locking nuts, with new ones.
- Replace inner and outer races of tapered roller bearings and needle bearings as a set.
- Arrange the disassembled parts in sequence with their assembled locations.
- Do not touch the terminals of electrical components which use microcomputers (such as electronic control unit). Static electricity may damage internal electronic components.

GI

MA

EM

LC

EC

FE

AT

FA

RA

BR

ST

RS

BT

HA

EL

IDX

## PRECAUTIONS

### General Precautions (Cont'd)

- After disconnecting vacuum or air hoses, attach a tag to indicate the proper connection.
- Use only the fluids and lubricants specified in this manual.
- Use approved bonding agent, sealants or their equivalents when required.
- Use tools and recommended special tools where specified for safe and efficient service repairs.
- When repairing the fuel, oil, water, vacuum or exhaust systems, check all affected lines for leaks.
- Dispose of drained oil or the solvent used for cleaning parts in an appropriate manner.

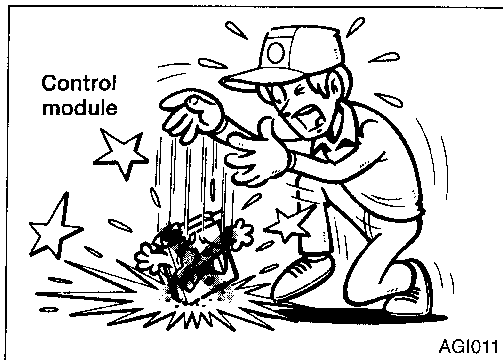

### Precautions for Multiport Fuel Injection System

- Before connecting or disconnecting any harness connector for the multiport fuel injection system or ECM (Engine control module):  
Turn ignition switch to "OFF" position.  
Disconnect negative battery terminal, otherwise, there may be damage to ECM.
- Before disconnecting pressurized fuel line from fuel pump to injectors, be sure to release fuel pressure.
- Be careful not to jar components such as ECM and mass air flow sensor.

### Precautions for Three Way Catalyst

If a large amount of unburned fuel flows into the catalyst, the catalyst temperature will be excessively high. To prevent this, follow the instructions below:

- Use unleaded gasoline only. Leaded gasoline will seriously damage the three way catalyst.
- When checking for ignition spark or measuring engine compression, make tests quickly and only when necessary.
- Do not run engine when the fuel tank level is low, otherwise the engine may misfire causing damage to the catalyst.

Do not place the vehicle on flammable material. Keep flammable material off the exhaust system.

### Engine Oils

Prolonged and repeated contact with used engine oil may cause skin cancer. Try to avoid direct skin contact with used oil. If skin contact is made, wash thoroughly with soap or hand cleaner as soon as possible.

### HEALTH PROTECTION PRECAUTIONS

- Avoid prolonged and repeated contact with oils, particularly used engine oils.
- Wear protective clothing, including oil resistant gloves when practicable.
- Do not put oily rags in pockets.
- Avoid contaminating clothes, particularly underclothing, with oil.
- Heavily soiled clothing and oil-impregnated footwear should not be worn. Overalls must be cleaned regularly.

## PRECAUTIONS

### Engine Oils (Cont'd)

- First aid treatment should be obtained immediately for open cuts and wounds.
- Use barrier creams, applying them before each work period, to help the removal of oil from the skin.
- Wash with soap and water to ensure all oil is removed (skin cleansers and nail brushes will help). Preparations containing lanolin replace the natural skin oils which have been removed.
- Do not use gasoline, kerosine, diesel fuel, gas oil, thinners or solvents for cleaning skin.
- If skin disorders develop, obtain medical advice without delay.
- Where practicable, degrease components prior to handling.
- Where there is a risk of eye contact, eye protection should be worn, for example, chemical goggles or face shields; in addition an eye wash facility should be provided.

GI

WA

EM

LC

EC

### ENVIRONMENTAL PROTECTION PRECAUTIONS

Burning used engine oil in small space heaters or boilers can be recommended only for units of approved design. The heating system must meet the requirements of HM Inspectorate of Pollution for small burners of less than 0.4 MW. If in doubt check with the appropriate local authority and/or manufacturer of the approved appliance.

FE

AT

FA

Dispose of used oil and used oil filters through authorized waste disposal contractors to licensed waste disposal sites, or to the waste oil reclamation trade. If in doubt, contact the local authority for advice on disposal facilities.

RA

It is illegal to pour used oil on to the ground, down sewers, drains, or into water courses.

BR

The regulations concerning the pollution of the environment will vary between regions.

ST

### Precautions for Fuel

Use premium unleaded gasoline with an octane rating of at least 91 AKI (Anti-Knock Index) number (research octane number 96). If premium unleaded gasoline is not available, regular unleaded gasoline with an octane rating of at least 87 AKI (research octane number 91) can be used.

RS

BT

However, for maximum vehicle performance, the use of premium unleaded gasoline is recommended.

HA

#### CAUTION:

**Do not use leaded gasoline. Using leaded gasoline will damage the three way catalyst.**

EL

### Precautions for Air Conditioning

IDX

Use an approved refrigerant recovery unit anytime the air conditioner system must be discharged. Refer to HA section ("R-134a Service Procedure", "SERVICE PROCEDURES") for specific instructions.

## HOW TO USE THIS MANUAL



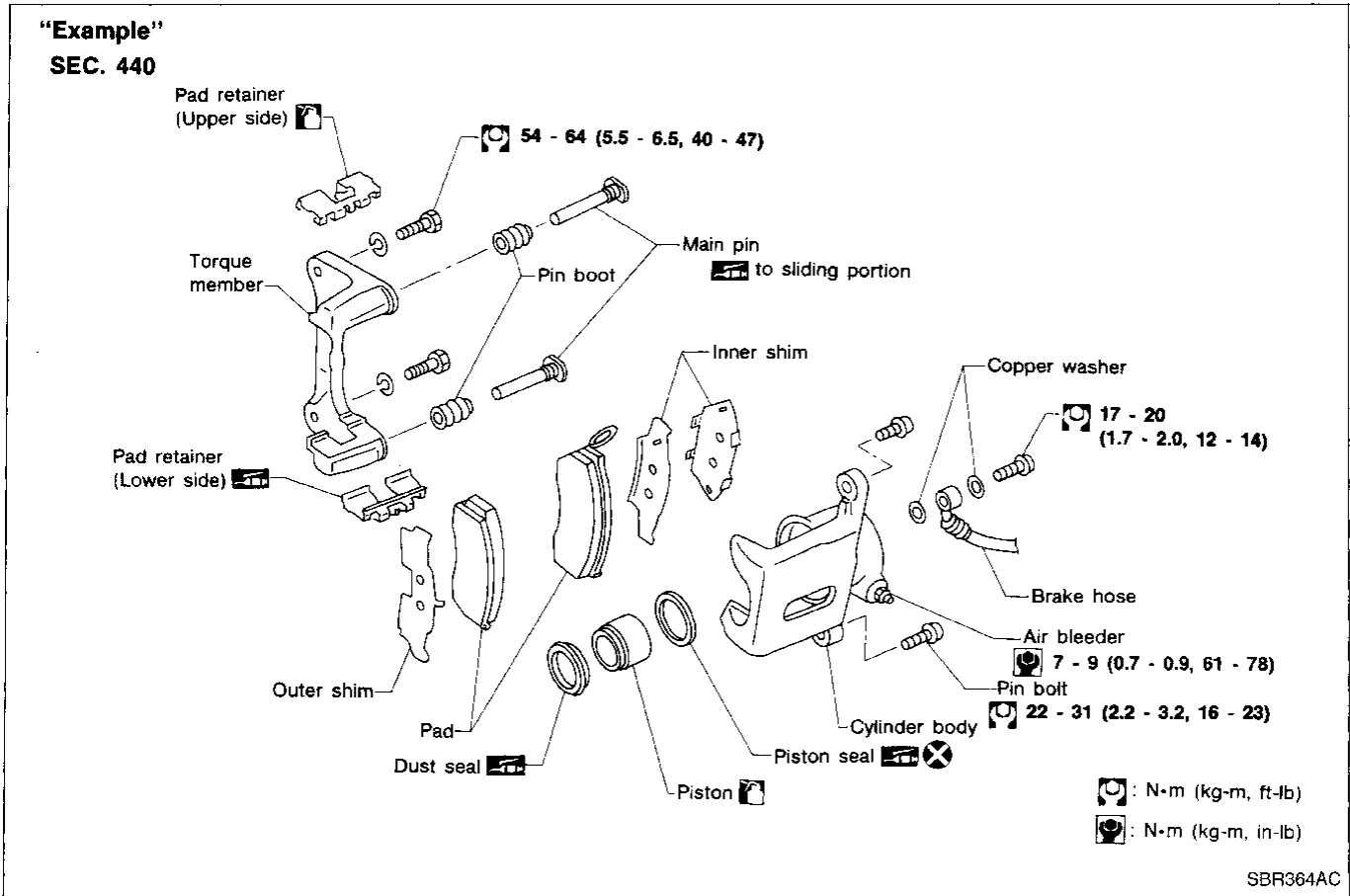







- **ALPHABETICAL INDEX** is provided at the end of this manual so that you can rapidly find the item and page you are searching for.
- **A QUICK REFERENCE INDEX**, a black tab (e.g., **BR**) is provided on the first page. You can quickly find each section by matching it to the section's black tabs.
- **THE CONTENTS** are listed on the first page of each section.
- **THE TITLE** is indicated on the upper portion of each page and shows the part or system.
- **THE PAGE NUMBER** of each section consists of two letters designating the particular section combined with a number (e.g., "BR-5").
- **THE LARGE ILLUSTRATIONS** are exploded views (see example below). These contain tightening torques, lubrication points, section number of the **PARTS CATALOG** (e.g., SEC. 440) and other information necessary to perform repairs.  
The illustrations should be used in reference to service matters only. When ordering parts, refer to the appropriate **PARTS CATALOG**.



- **THE SMALL ILLUSTRATIONS** show items not shown in the previous large illustrations. These include important steps such as inspection points, use of special tools, hidden fasteners and special or unique procedures.  
A step-by-step format for assembly, inspection and adjustment is presented for complicated units such as the automatic transaxle.

# HOW TO USE THIS MANUAL

- The following **SYMBOLS AND ABBREVIATIONS** are used:

	:	Tightening torque	M/T	:	Manual Transaxle/Transmission	<b>GI</b>
	:	Should be lubricated with grease. Unless otherwise indicated, use recommended multi-purpose grease.	A/T	:	Automatic Transaxle/Transmission	
	:	Should be lubricated with oil.	A/C	:	Air Conditioner	<b>MA</b>
	:	Sealing point	P/S	:	Power Steering	
	:	Checking point	Tool	:	Special Service Tools	<b>EM</b>
	:	Always replace after every disassembly.	SAE	:	Society of Automotive Engineers, Inc.	
	Ⓟ	Apply petroleum jelly.	ATF	:	Automatic Transmission Fluid	<b>LC</b>
	:	Apply ATF.	D <sub>1</sub>	:	Drive range 1st gear	
	:	Select with proper thickness.	D <sub>2</sub>	:	Drive range 2nd gear	<b>EC</b>
	:	Adjustment is required.	D <sub>3</sub>	:	Drive range 3rd gear	
SDS	:	Service Data and Specifications	D <sub>4</sub>	:	Drive range 4th gear	<b>FE</b>
LH, RH	:	Left-Hand, Right-Hand	OD	:	Overdrive	
FR, RR	:	Front, Rear	2 <sub>2</sub>	:	2nd range 2nd gear	<b>AT</b>
			2 <sub>1</sub>	:	2nd range 1st gear	
			1 <sub>2</sub>	:	1st range 2nd gear	<b>FA</b>
			1 <sub>1</sub>	:	1st range 1st gear	

- The **UNITS** given in this manual are primarily expressed as the SI UNIT (International System of Unit), and alternatively expressed in the metric system and in the yard/pound system.

“Example”

**Tightening torque:**

**59 - 78 N·m (6.0 - 8.0 kg-m, 43 - 58 ft-lb)**

- TROUBLE DIAGNOSES** are included in sections dealing with complicated components. RA
- SERVICE DATA AND SPECIFICATIONS** are contained at the end of each section for quick reference of data. BR
- The captions **WARNING** and **CAUTION** warn you of steps that must be followed to prevent personal injury and/or damage to some part of the vehicle. ST  
**WARNING** indicates the possibility of personal injury if instructions are not followed.  
**CAUTION** indicates the possibility of component damage if instructions are not followed.  
**BOLD TYPED STATEMENTS** except **WARNING** and **CAUTION** give you helpful information. RS

BT  
HA  
EL  
IDX

# HOW TO READ WIRING DIAGRAMS

## Sample/Wiring Diagram -EXAMPL-

- For Description, refer to GI-10.

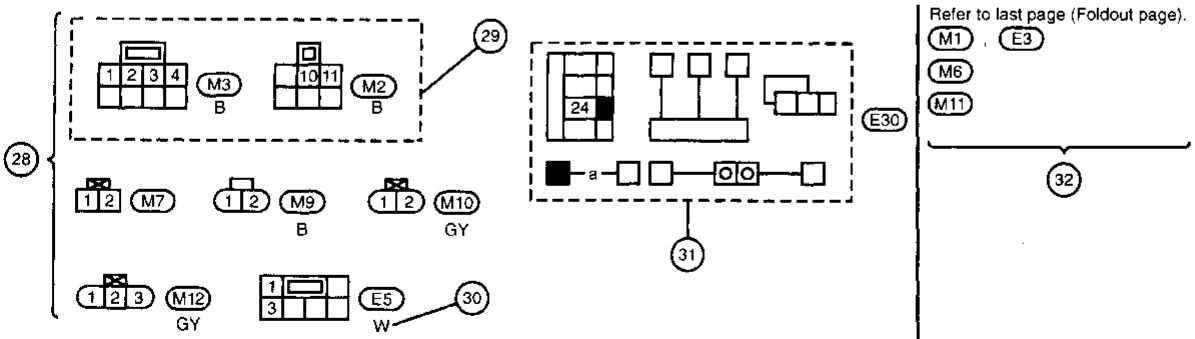
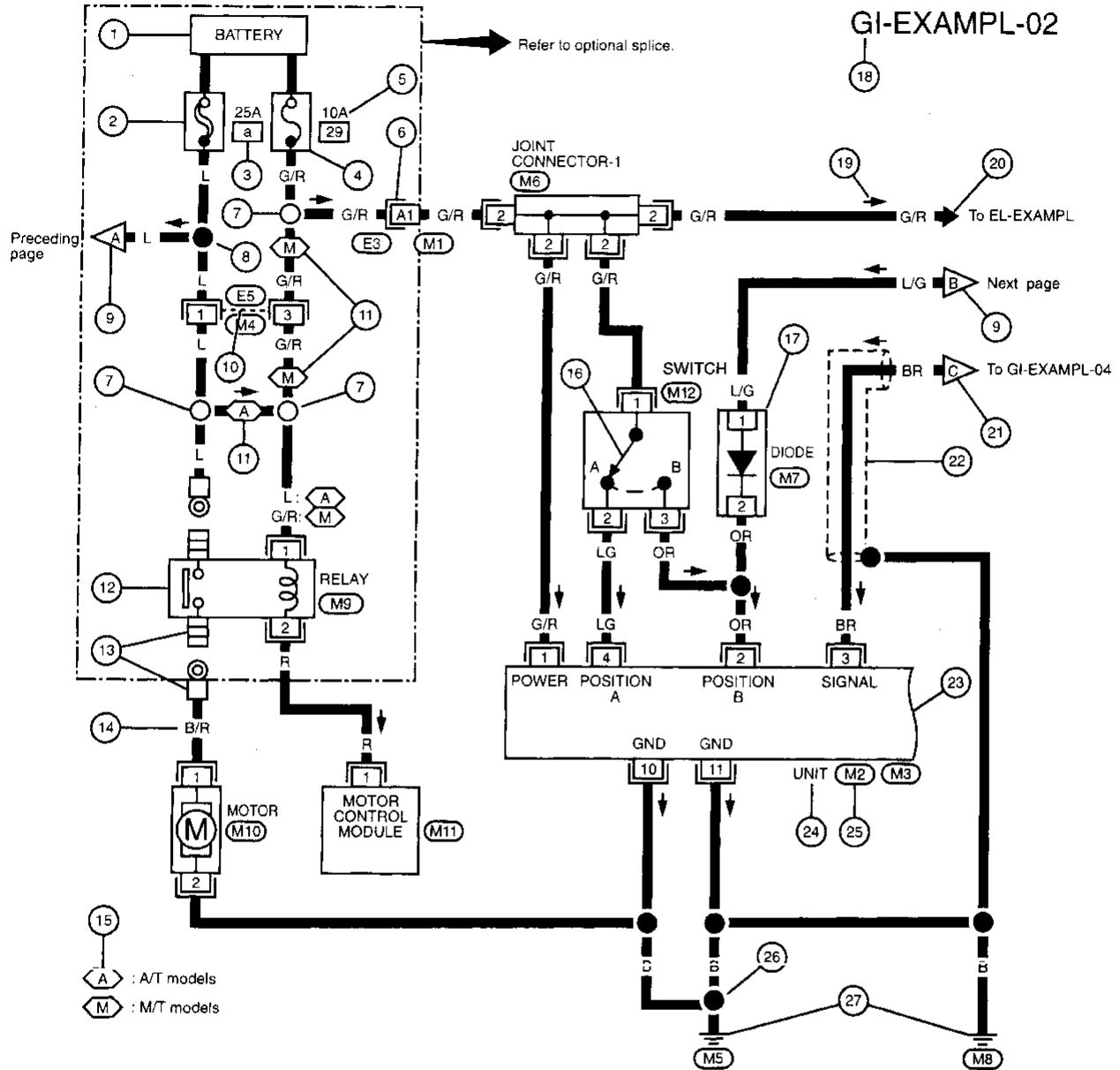



# HOW TO READ WIRING DIAGRAMS

## Sample/Wiring Diagram -EXAMPL- (Cont'd)

### OPTIONAL SPLICE

Optional splice

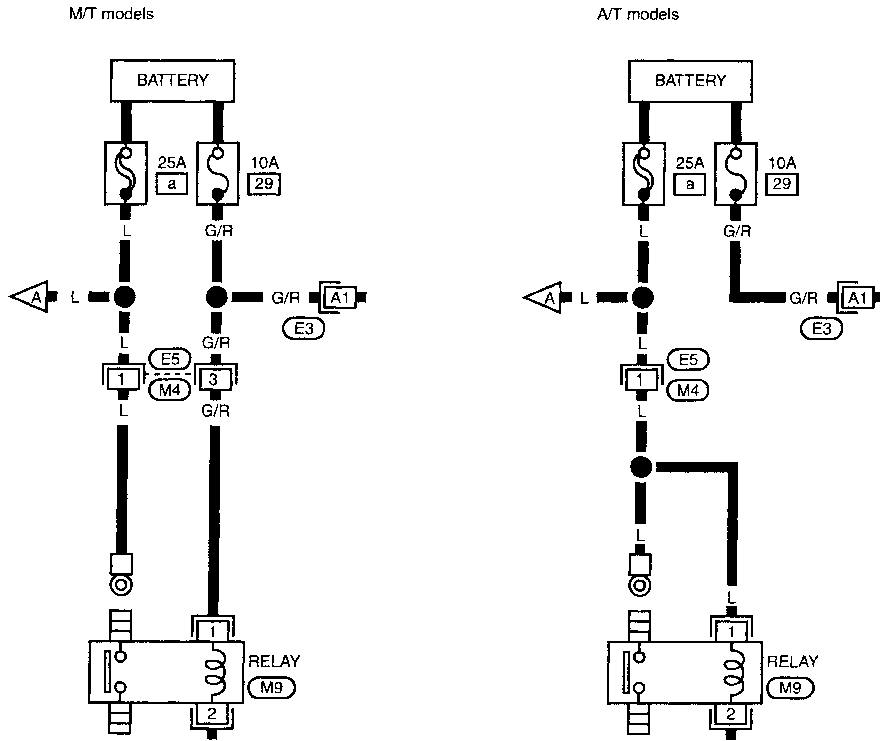

SGI858

GI

MA

EW

LC

EC

FE

AT

FA

RA

BR

ST

RS

BT

HA

EL

IDX

# HOW TO READ WIRING DIAGRAMS

## Description

Number	Item	Description																
①	Power condition	<ul style="list-style-type: none"> <li>This shows the condition when the system receives battery positive voltage (can be operated).</li> </ul>																
②	Fusible link	<ul style="list-style-type: none"> <li>The double line shows that this is a fusible link.</li> <li>The open circle shows current flow in, and the shaded circle shows current flow out.</li> </ul>																
③	Fusible link/fuse location	<ul style="list-style-type: none"> <li>This shows the location of the fusible link or fuse in the fusible link or fuse box. For arrangement, refer to EL section ("POWER SUPPLY ROUTING").</li> </ul>																
④	Fuse	<ul style="list-style-type: none"> <li>The single line shows that this is a fuse.</li> <li>The open circle shows current flow in, and the shaded circle shows current flow out.</li> </ul>																
⑤	Current rating	<ul style="list-style-type: none"> <li>This shows the current rating of the fusible link or fuse.</li> </ul>																
⑥	Connectors	<ul style="list-style-type: none"> <li>This shows that connector <b>(E3)</b> is female and connector <b>(M1)</b> is male.</li> <li>The G/R wire is located in the A1 terminal of both connectors.</li> <li>Terminal number with an alphabet (A1, B5, etc.) indicates that the connector is SMJ connector. Refer to GI-15.</li> </ul>																
⑦	Optional splice	<ul style="list-style-type: none"> <li>The open circle shows that the splice is optional depending on vehicle application.</li> </ul>																
⑧	Splice	<ul style="list-style-type: none"> <li>The shaded circle shows that the splice is always on the vehicle.</li> </ul>																
⑨	Page crossing	<ul style="list-style-type: none"> <li>This arrow shows that the circuit continues to an adjacent page.</li> <li>The A will match with the A on the preceding or next page.</li> </ul>																
⑩	Common connector	<ul style="list-style-type: none"> <li>The dotted lines between terminals show that these terminals are part of the same connector.</li> </ul>																
⑪	Option abbreviation	<ul style="list-style-type: none"> <li>This shows that the circuit is optional depending on vehicle application.</li> </ul>																
⑫	Relay	<ul style="list-style-type: none"> <li>This shows an internal representation of the relay. For details, refer to EL section ("STANDARDIZED RELAY").</li> </ul>																
⑬	Connectors	<ul style="list-style-type: none"> <li>This shows that the connector is connected to the body or a terminal with bolt or nut.</li> </ul>																
⑭	Wire color	<ul style="list-style-type: none"> <li>This shows a code for the color of the wire.</li> </ul> <table style="width: 100%; border: none;"> <tr> <td>B = Black</td> <td>BR = Brown</td> </tr> <tr> <td>W = White</td> <td>OR = Orange</td> </tr> <tr> <td>R = Red</td> <td>P = Pink</td> </tr> <tr> <td>G = Green</td> <td>PU = Purple</td> </tr> <tr> <td>L = Blue</td> <td>GY = Gray</td> </tr> <tr> <td>Y = Yellow</td> <td>SB = Sky Blue</td> </tr> <tr> <td>LG = Light Green</td> <td>CH = Dark Brown</td> </tr> <tr> <td></td> <td>DG = Dark Green</td> </tr> </table> <p>When the wire color is striped, the base color is given first, followed by the stripe color as shown below: Example: L/W = Blue with White Stripe</p>	B = Black	BR = Brown	W = White	OR = Orange	R = Red	P = Pink	G = Green	PU = Purple	L = Blue	GY = Gray	Y = Yellow	SB = Sky Blue	LG = Light Green	CH = Dark Brown		DG = Dark Green
B = Black	BR = Brown																	
W = White	OR = Orange																	
R = Red	P = Pink																	
G = Green	PU = Purple																	
L = Blue	GY = Gray																	
Y = Yellow	SB = Sky Blue																	
LG = Light Green	CH = Dark Brown																	
	DG = Dark Green																	
⑮	Option description	<ul style="list-style-type: none"> <li>This shows a description of the option abbreviation used on the page.</li> </ul>																
⑯	Switch	<ul style="list-style-type: none"> <li>This shows that continuity exists between terminals ① and ② when the switch is in the A position. Continuity exists between terminals ① and ③ when the switch is in the B position.</li> </ul>																
⑰	Assembly parts	<ul style="list-style-type: none"> <li>Connector terminal in component shows that it is a harness incorporated assembly.</li> </ul>																
⑱	Cell code	<ul style="list-style-type: none"> <li>This identifies each page of the wiring diagram by section, system and wiring diagram page number.</li> </ul>																

# HOW TO READ WIRING DIAGRAMS

## Description (Cont'd)

Number	Item	Description
19	Current flow arrow	<ul style="list-style-type: none"> <li>● Arrow indicates electric current flow, especially where the direction of standard flow (vertically downward or horizontally from left to right) is difficult to follow.</li> <li>● A double arrow "↔" shows that current can flow in either direction depending on circuit operation.</li> </ul>
20	System branch	<ul style="list-style-type: none"> <li>● This shows that the system branches to another system identified by cell code (section and system).</li> </ul>
21	Page crossing	<ul style="list-style-type: none"> <li>● This arrow shows that the circuit continues to another page identified by cell code.</li> <li>● The C will match with the C on another page within the system other than the next or preceding pages.</li> </ul>
22	Shielded line	<ul style="list-style-type: none"> <li>● The line enclosed by broken line circle shows shield wire.</li> </ul>
23	Component box in wave line	<ul style="list-style-type: none"> <li>● This shows that another part of the component is also shown on another page (indicated by wave line) within the system.</li> </ul>
24	Component name	<ul style="list-style-type: none"> <li>● This shows the name of a component.</li> </ul>
25	Connector number	<ul style="list-style-type: none"> <li>● This shows the connector number.</li> <li>● The letter shows which harness the connector is located in. Example: <b>M</b>: main harness. For detail and to locate the connector, refer to EL section ("Main Harness", "HARNESS LAYOUT"). A coordinate grid is included for complex harnesses to aid in locating connectors.</li> </ul>
26	Ground	<ul style="list-style-type: none"> <li>● The line spliced and grounded under wire color shows that ground line is spliced at the grounded connector.</li> </ul>
27	Ground	<ul style="list-style-type: none"> <li>● This shows the ground connection.</li> </ul>
28	Connector views	<ul style="list-style-type: none"> <li>● This area shows the connector faces of the components in the wiring diagram on the page.</li> </ul>
29	Common component	<ul style="list-style-type: none"> <li>● Connectors enclosed in broken line show that these connectors belong to the same component.</li> </ul>
30	Connector color	<ul style="list-style-type: none"> <li>● This shows a code for the color of the connector. For code meaning, refer to wire color codes, number 14 of this chart.</li> </ul>
31	Fusible link and fuse box	<ul style="list-style-type: none"> <li>● This shows the arrangement of fusible link(s) and fuse(s), used for connector views of "POWER SUPPLY ROUTING" in EL section. The open square shows current flow in, and the shaded square shows current flow out.</li> </ul>
32	Reference area	<ul style="list-style-type: none"> <li>● This shows that more information on the Super Multiple Junction (SMJ) and Joint Connectors (J/C) exists on the foldout page. Refer to GI-15 for details.</li> </ul>

GI

MA

EW

LC

EC

FE

AT

FA

RA

BR

ST

RS

BT

HA

EL

IDX

# HOW TO READ WIRING DIAGRAMS

## Description (Cont'd)

### CONNECTOR SYMBOLS

Most connector symbols in wiring diagrams are shown from the terminal side.

- Connector symbols shown from the terminal side are enclosed by a single line and followed by the direction mark



- Connector symbols shown from the harness side are enclosed by a double line and followed by the direction mark

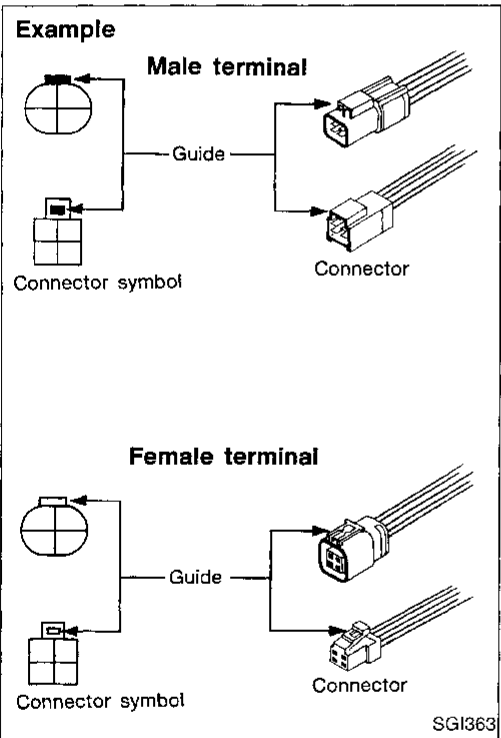
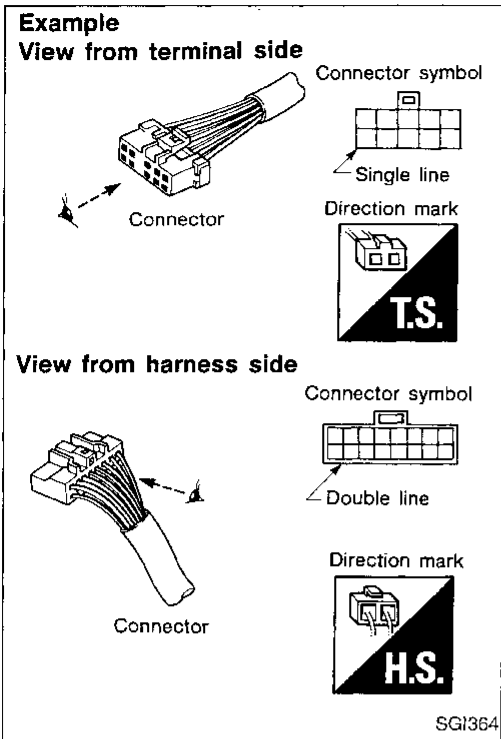

- Connector guides for male terminals are shown in black.
- Connector guides for female terminals are shown in white.

# HOW TO READ WIRING DIAGRAMS

## Description (Cont'd)

### SWITCH POSITIONS

Switches are shown in wiring diagrams as if the vehicle is in the "normal" condition.

A vehicle is in the "normal" condition when:

- ignition switch is OFF,
- doors, hood and trunk lid/back door are closed,
- pedals are not depressed, and
- parking brake is released.

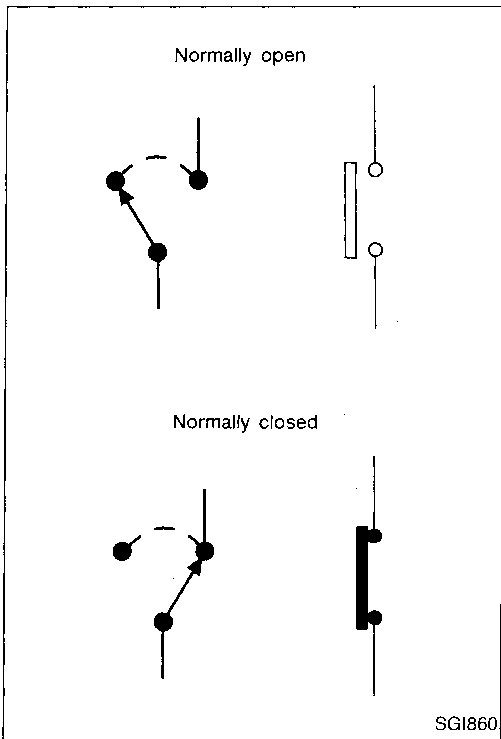

### DETECTABLE LINES AND NON-DETECTABLE LINES

In some wiring diagrams, two kinds of lines with different thicknesses are used to represent wires.

- A line with regular thickness (wider line) represents a "detectable line for DTC (Diagnostic Trouble Code)". A "detectable line for DTC" is a circuit in which ECM (ECCS control module) can detect malfunctions with the on-board diagnostic system.
- A line with less thickness (thinner line) represents a "non-detectable line for DTC". A "non-detectable line for DTC" is a circuit in which ECM cannot detect malfunctions with the on-board diagnostic system.

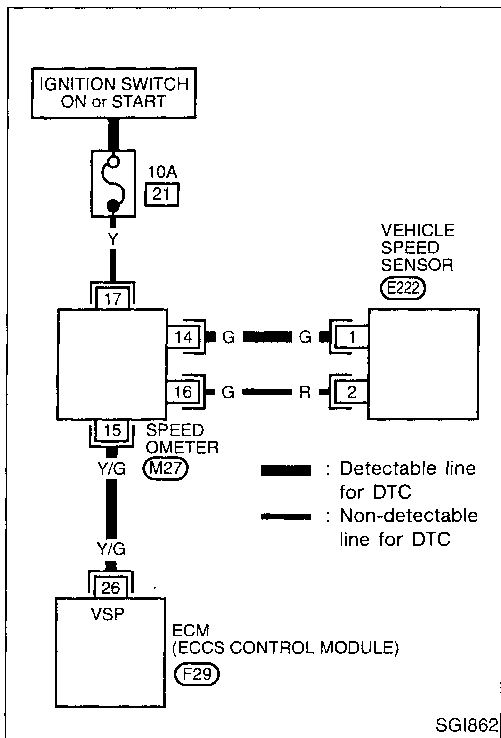

GI  
NA  
EM  
LC  
EC  
FE  
AT  
FA  
RA  
BR  
ST  
PS  
BT  
HA  
EL  
IDX

# HOW TO READ WIRING DIAGRAMS

## Description (Cont'd)

### MULTIPLE SWITCH

The continuity of multiple switch is described in two ways as shown below.

- The switch chart is used in schematic diagrams.
- The switch diagram is used in wiring diagrams.

#### Example

(SWITCH CHART)

WIPER SWITCH					
	OFF	INT	LO	HI	WASH
1					○
2				○	
3	○	○	○		
4	○	○			
5		○			
6		○	○	○	○

(SWITCH DIAGRAM)

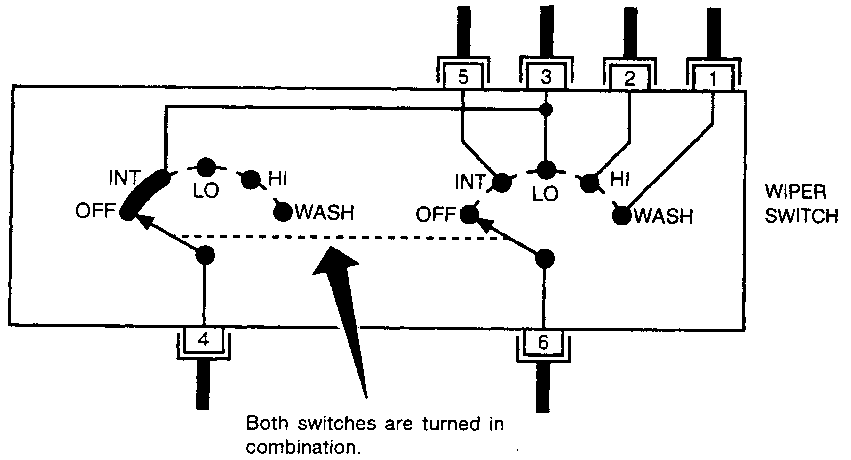

Continuity circuit of wiper switch

SWITCH POSITION	CONTINUITY CIRCUIT
OFF	3-4
INT	3-4, 5-6
LO	3-6
HI	2-6
WASH	1-6

SG1875

# HOW TO READ WIRING DIAGRAMS

## Description (Cont'd)

### FOLDOUT PAGE

The foldout page should be opened when reading a wiring diagram.

#### Super multiple junction (SMJ)

In a wiring diagram, SMJ connectors include a letter of the alphabet in the terminal number. SMJ connector numbers are shown in the Reference Area. Terminal arrangement can be found on the foldout page.

If connector numbers are shown in Reference Area, these connector symbols are not shown in Connector Area. For terminal arrangement of these connectors, refer to the foldout page at the end of this manual.

#### Joint connector

Joint connector symbols are shown in Connector Area of the wiring diagram. Inside wiring layout and joint connector terminal arrangement can be found on the foldout page.

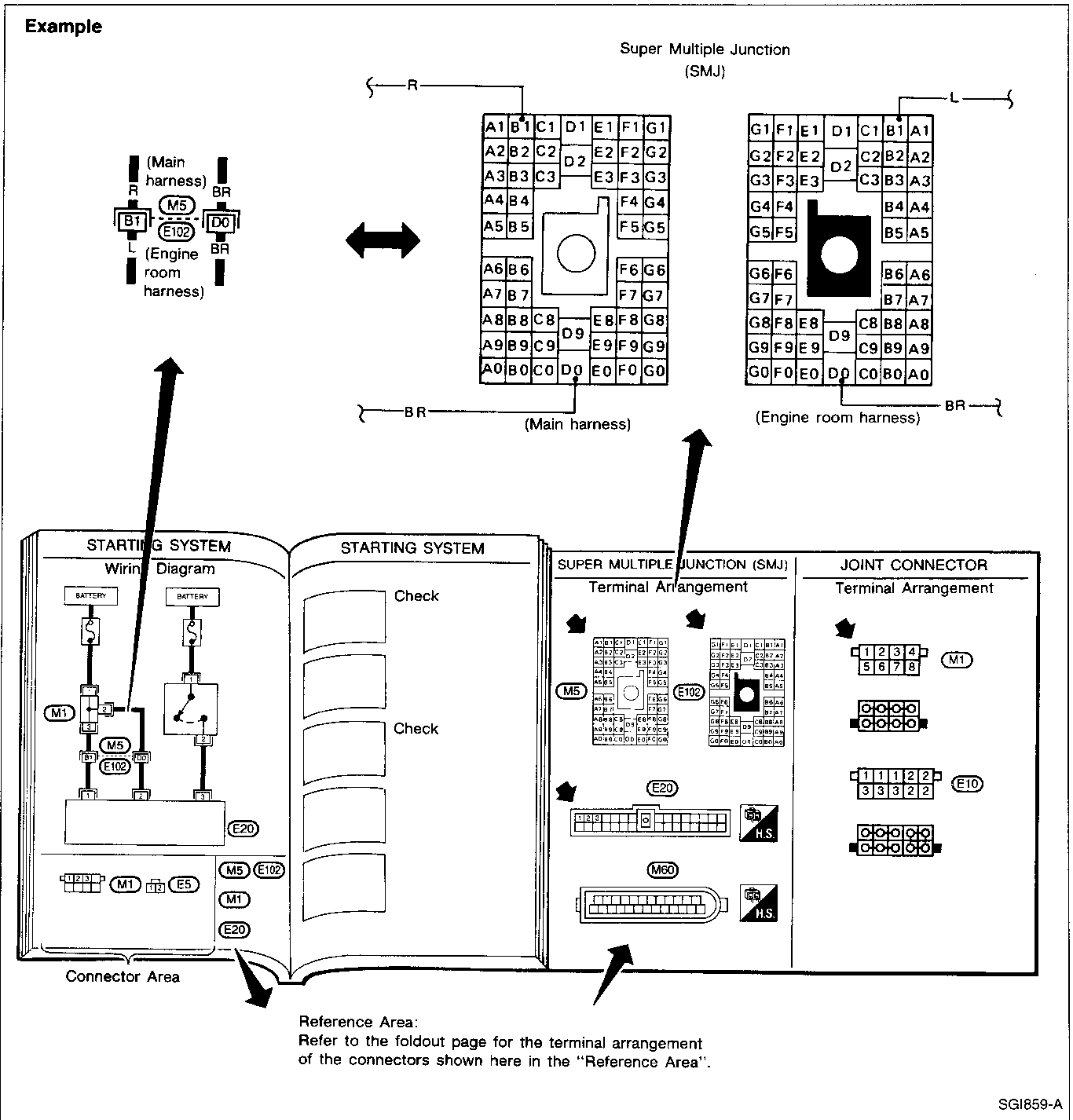

GI  
MA  
EM  
LC  
EC  
FE  
AT  
FA  
RA  
BR  
ST  
RS  
BT  
HA  
EL  
IDX

# HOW TO READ WIRING DIAGRAMS

## Wiring Diagram Codes (Cell Codes)

Use the chart below to find out what each wiring diagram code stands for.

Code	Section	Wiring Diagram Name
AAC/V	EC	IACV-AAC Valve
ABS	BR	Anti-lock Brake System
A/C, A	HA	Auto Air Conditioner
A/C, M	HA	Manual Air Conditioner
ASCD	EL	Automatic Speed Control Device (ASCD)
A/T	AT	Automatic Transaxle
AT/C	EC	A/T Control
ATDIAG	EC	A/T Diagnosis Communication Line
AUDIO	EL	Audio
BACK/L	EL	Back-up Lamp
CHARGE	EL	Charging System
CHIME	EL	Warning Chime
CKPS	EC	Crankshaft Position Sensor
CMPS	EC	Camshaft Position Sensor
COOL/F	EC	Cooling Fan Control
CORNER	EL	Cornering Lamp
DEF	EL	Rear Window Defogger
D/LOCK	EL	Power Door Lock
DTRL	EL	Headlamp - With Daytime Light System
ECTS	EC	Engine Coolant Temperature Sensor
EGRC1	EC	EGR Function
EGRC/V	EC	EGR Valve and EVAP Canister Purge Control Solenoid Valve
EGR/TS	EC	EGR Temperature Sensor
FICD	EC	IACV-FICD Solenoid Valve
F/PUMP	EC	Fuel Pump Control
FRO2	EC	Front Heated Oxygen Sensor
FRO2/H	EC	Front Heated Oxygen Sensor Heater
FUEL	EC	Fuel Injection System Function
H/LAMP	EL	Headlamp
H/MIRR	EL	Heated mirror
HORN	EL	Horn and Cigarette Lighter
IATS	EC	Intake Air Temperature Sensor
IGN/SG	EC	Ignition Signal
ILL	EL	Illumination
INJECT	EC	Injector

Code	Section	Wiring Diagram Name
INT/L	EL	Interior, Map, Step and Tailgate Lamps
KS	EC	Knock Sensor
MAFS	EC	Mass Air Flow Sensor
MAIN	EC	Main Power Supply and Ground Circuit
METER	EL	Speedometer, Tachometer, Temp. and Fuel Gauges
MIL	EC	MIL, Data Link Connector For CONSULT, GST
MIRROR	EL	Door Mirror
MULTI	EL	Multi-remote Control System
P/ANT	EL	Power Antenna
PNP/SW	EC	Park/Neutral Position Switch
POWER	EL	Power Supply Routing
PST/SW	EC	Power Steering Oil Pressure Switch
RRO2	EC	Rear Heated Oxygen Sensor
RRO2/H	EC	Rear Heated Oxygen Sensor Heater
SEAT	EL	Power Seat
SHIFT	AT	A/T Shift Lock System
SROOF	EL	Sunroof
SRS	RS	Supplemental Restraint System
S/SIG	EC	Start Signal
START	EL	Starting System
TAIL/L	EL	Clearance, License, Tail and Stop Lamps
T/TOW	EL	Trailer Tow
THEFT	EL	Theft Warning System
TPS	EC	Throttle Position Sensor
TURN	EL	Turn Signal and Hazard Warning Lamps
VSS	EC	Vehicle Speed Sensor
WARN	EL	Warning Lamps
WINDOW	EL	Power Window
WIPER	EL	Front Wiper and Washer
WIP/R	EL	Rear Wiper and Washer (Except for Glass Hatch Model)
WIP/HR	EL	Rear Wiper and Washer (For Glass Hatch Model)



# HOW TO PERFORM EFFICIENT DIAGNOSIS FOR AN ELECTRICAL INCIDENT

## Work Flow

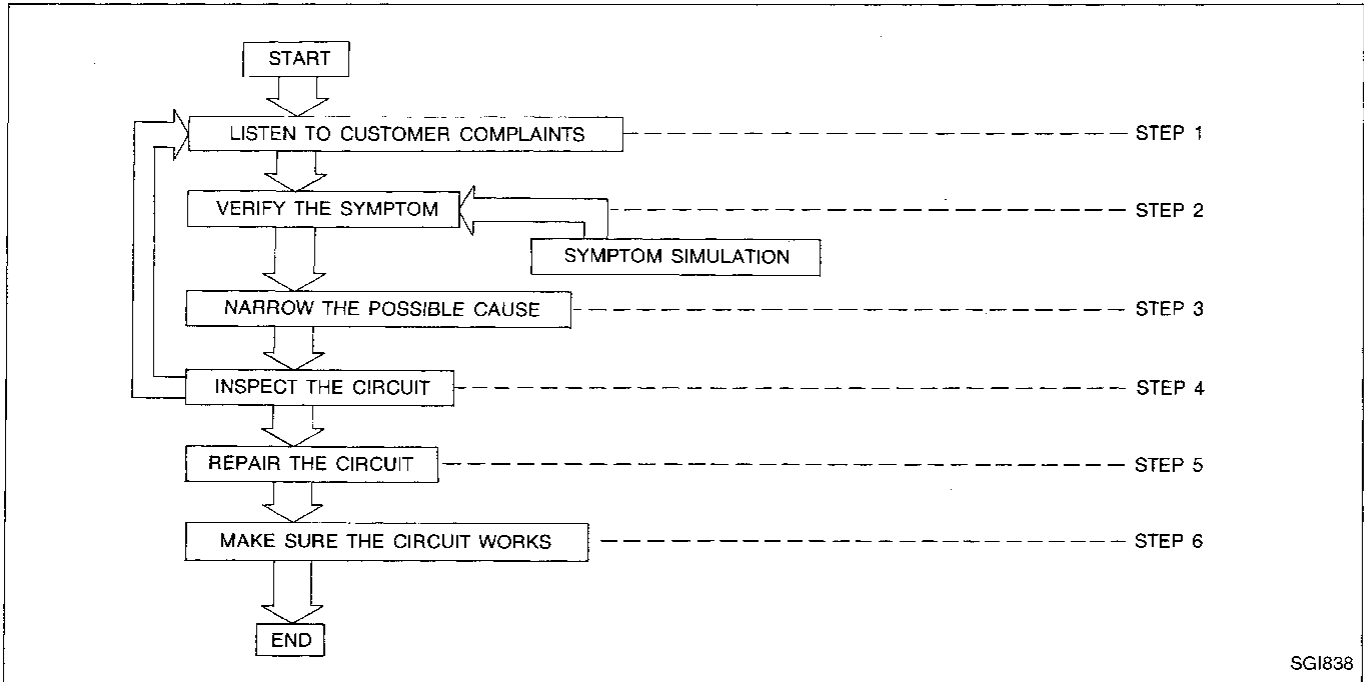

STEP	DESCRIPTION
STEP 1	<p>Get detailed information about the conditions and the environment when the incident occurred. The following are key pieces of information required to make a good analysis:</p> <p><b>WHAT</b> Vehicle Model, Engine, Transmission and the System (i.e., Radio).</p> <p><b>WHEN</b> Date, Time of Day, Weather Conditions, Frequency.</p> <p><b>WHERE</b> Road Conditions, Altitude and Traffic Situation.</p> <p><b>HOW</b> System Symptoms, Operating Conditions (Other Components Interaction). Service History and if any After Market Accessories have been installed.</p>
STEP 2	<p>Operate the system, road test if necessary. Verify the parameter of the incident. If the problem can not be duplicated, refer to "Incident Simulation Tests" next page.</p>
STEP 3	<p>Get the proper diagnosis materials together including:</p> <p style="padding-left: 40px;">POWER SUPPLY ROUTING System Operation Descriptions Applicable Service Manual Sections</p> <p>Identify where to begin diagnosis based upon your knowledge of the system operation and the customer comments.</p>
STEP 4	<p>Inspect the system for mechanical binding, loose connectors or wiring damage. Determine which circuits and components are involved and diagnose using the Power Supply Routing and Harness Layouts.</p>
STEP 5	<p>Repair or replace the incident circuit or component.</p>
STEP 6	<p>Operate and verify the system works properly under all conditions. Make sure you have not unintentionally created a new incident during your diagnosis or repair steps.</p>

# HOW TO PERFORM EFFICIENT DIAGNOSIS FOR AN ELECTRICAL INCIDENT

## Incident Simulation Tests

### INTRODUCTION

Sometimes the symptom is not present when the vehicle is brought in for service. If possible, re-create the conditions present at the time of the incident. Doing so may help avoid a No Trouble Found Diagnosis. The following section illustrates ways to simulate the conditions/environment under which the owner experiences an electrical incident.

The section is broken into the six following topics:

- Vehicle vibration
- Heat sensitive
- Freezing
- Water intrusion
- Electrical load
- Cold or hot start up

Get a thorough description of the incident from the customer. It is important for simulating the conditions of the problem.

### VEHICLE VIBRATION

The problem may occur or become worse while driving on a rough road or when the engine is vibrating (idle with A/C on). In such a case, you will want to check for a vibration related condition. Refer to the illustration below.

#### Connectors & harness

Determine which connectors and wiring harness would affect the electrical system you are inspecting. **Gently** shake each connector and harness while monitoring the system for the incident you are trying to duplicate. This test may indicate a loose or poor electrical connection.

#### Hint

Connectors can be exposed to moisture. It is possible to get a thin film of corrosion on the connector terminals. A visual inspection may not reveal this without disconnecting the connector. If the problem occurs intermittently, perhaps the problem is caused by corrosion. It is a good idea to disconnect, inspect and clean the terminals on related connectors in the system.

#### Sensors & relays

**Gently** apply a slight vibration to sensors and relays in the system you are inspecting. This test may indicate a loose or poorly mounted sensor or relay.

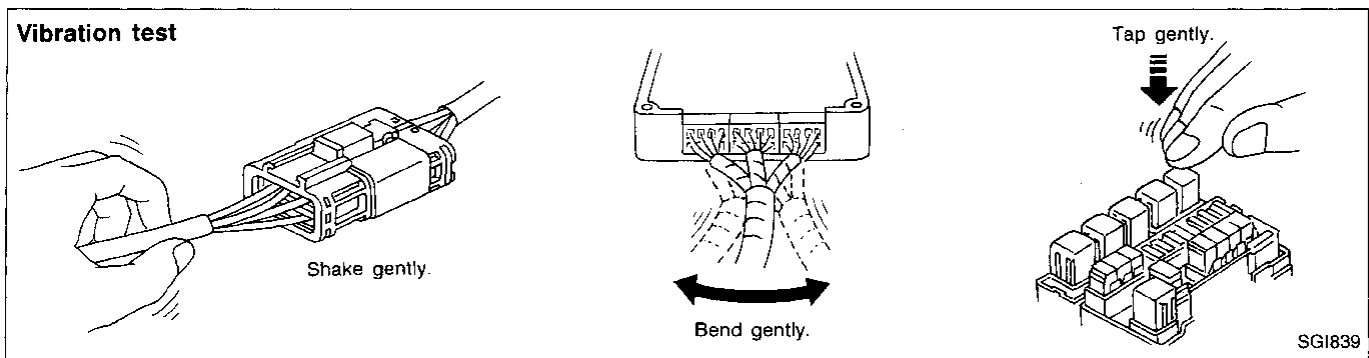

# HOW TO PERFORM EFFICIENT DIAGNOSIS FOR AN ELECTRICAL INCIDENT

## Incident Simulation Tests (Cont'd)

**Possible cause**

Any probe entering the terminal may enlarge the contact spring opening creating an intermittent signal.

The diagrams illustrate various causes of electrical incidents. On the left, under 'Possible cause', two pairs of female terminals are shown: one pair is 'Enlarged' (deformed) and the other is 'Normal'. On the right, under 'DEFECTIVE INSULATION STRIPPING', three cross-sections of a terminal are shown: 'Proper crimp', 'Insulation not removed' (causing 'Intermittent signals through pierced insulation'), and 'Wire strands missing'.

**DEFORMED (ENLARGED) FEMALE TERMINALS**

**DEFECTIVE INSULATION STRIPPING**

The diagram shows a cross-section of a connector with labels: 'Male half', 'Female half', 'Locked terminal', 'Seal', 'Unlocked terminal (Hidden by wire seal)', and 'Intermittent contact'. A note says: 'Check for unlocked terminals by pulling each wire at the end of the connector.' Below this is another diagram of a connector labeled 'Loose'.

**TERMINAL NOT PROPERLY SEATED**

SGI840

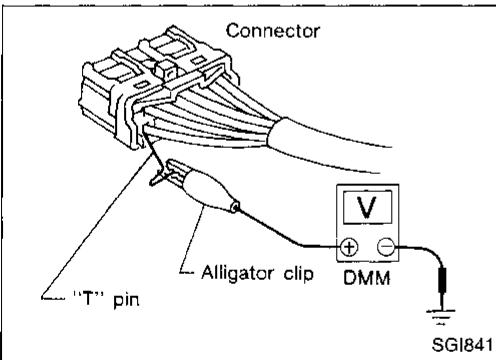

### Tester probe

When probing a connector it is possible to enlarge the contact spring opening. If this occurs it may create an intermittent signal in the circuit. When probing a connector, use care not to enlarge the opening. The probe of the Digital Multimeter (DMM) may not fit into the connector cavity. In such cases make an extension of a "T" pin and probe it from the harness side of the connector. Most DMMs have accessory alligator clips. Slide these over the probe to allow clipping the "T" pin for a better contact. If you have any difficulty probing a terminal, inspect the terminal. Make sure that you have not accidentally opened the contact spring or pulled a wire loose.

GI  
WA  
EM  
LC  
EC  
FE  
AT  
FA  
RA  
BR  
ST  
RS  
BT  
HA  
EL  
IDX

# HOW TO PERFORM EFFICIENT DIAGNOSIS FOR AN ELECTRICAL INCIDENT

## Incident Simulation Tests (Cont'd)

### Engine compartment

There are several reasons a vehicle or engine vibration could cause an electrical complaint. Some of the things to check for are:

- Connectors not fully seated.
- Wiring harness not long enough and is being stressed due to engine vibrations or rocking.
- Wires laying across brackets or moving components.
- Loose, dirty or corroded ground wires.
- Wires routed too close to hot components.

To inspect components under the hood, start by verifying the integrity of ground connections. Refer to GI-24. First check that the system is properly grounded. Then, check for loose connection by **gently shaking** the wiring or components as previously explained. Using the wiring diagrams, inspect the wiring for continuity.

### Behind the instrument panel

An improperly routed or improperly clamped harness can become pinched during accessory installation. Vehicle vibration can aggravate a harness which is routed along a bracket or near a screw.

### Under seating areas

An unclamped or loose harness can cause wiring to be pinched by seat components during vehicle vibration. If the wiring runs under seating areas, inspect wire routing for possible damage or pinching.

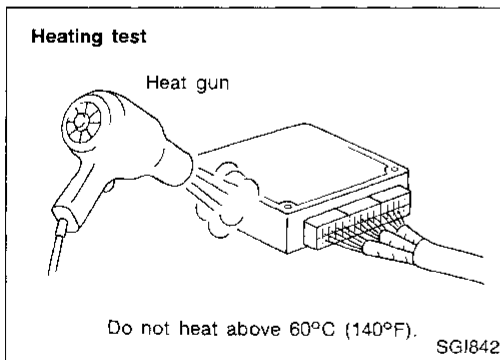

### HEAT SENSITIVE

The owner's problem may occur during hot weather or after car has sat for a short time. In such cases you will want to check for a heat sensitive condition.

To determine if an electrical component is heat sensitive, heat the component with a heat gun or equivalent.

**Do not heat components above 60°C (140°F).** If incident occurs while heating the unit, either replace or properly insulate the component.

# HOW TO PERFORM EFFICIENT DIAGNOSIS FOR AN ELECTRICAL INCIDENT

## Incident Simulation Tests (Cont'd)

### FREEZING

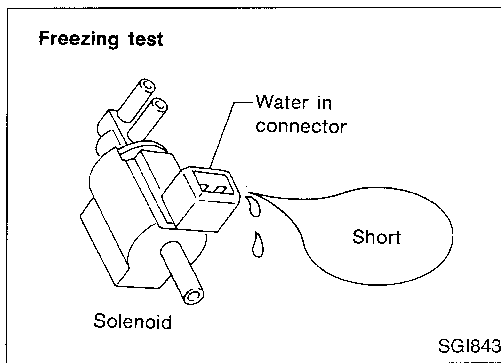

The customer may indicate the incident goes away after the car warms up (winter time). The cause could be related to water freezing somewhere in the wiring/electrical system.

There are two methods to check for this. The first is to arrange for the owner to leave the car overnight. Make sure it will get cold enough to demonstrate the complaint. Leave the car parked outside overnight. In the morning, do a quick and thorough diagnosis of those electrical components which could be affected.

The second method is to put the suspect component into a freezer long enough for any water to freeze. Reinstall the part into the car and check for the reoccurrence of the incident. If it occurs, repair or replace the component.

GI

MA

EM

LC

EC

FE

AT

FA

RA

BR

ST

RS

BT

HA

EL

IDX

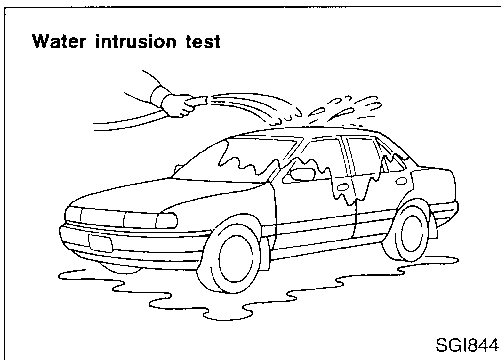

### WATER INTRUSION

The incident may occur only during high humidity or in rainy/snowy weather. In such cases the incident could be caused by water intrusion on an electrical part. This can be simulated by soaking the car or running it through a car wash.

**Do not spray water directly on any electrical components.**

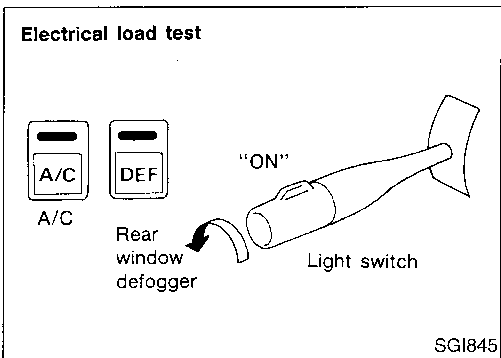

### ELECTRICAL LOAD

The incident may be electrical load sensitive. Perform diagnosis with all accessories (including A/C, rear window defogger, radio, fog lamps) turned on.

### COLD OR HOT START UP

On some occasions an electrical incident may occur only when the car is started cold. Or it may occur when the car is restarted hot shortly after being turned off. In these cases you may have to keep the car overnight to make a proper diagnosis.

# HOW TO PERFORM EFFICIENT DIAGNOSIS FOR AN ELECTRICAL INCIDENT

## Circuit Inspection

### INTRODUCTION

In general, testing electrical circuits is an easy task if approached logically. Before beginning, it is important to have all available information on the system to be tested. Also, get a thorough understanding of system operation. Then you will be able to use the appropriate equipment and follow the correct test procedure.

You may have to simulate vehicle vibrations while testing electrical components. **Gently shake** the wiring harness or electrical component to do this.

**OPEN** A circuit is open when there is no continuity through a section of the circuit.

**SHORT** There are two types of shorts.

- **SHORT CIRCUIT** When a circuit contacts another circuit and causes the normal resistance to change.
- **SHORT TO GROUND** When a circuit contacts a ground source and grounds the circuit.

### TESTING FOR "OPENS" IN THE CIRCUIT

Before you begin to diagnose and test the system, you should rough sketch a schematic of the system. This will help you to logically walk through the diagnosis process. Drawing the sketch will also reinforce your working knowledge of the system.

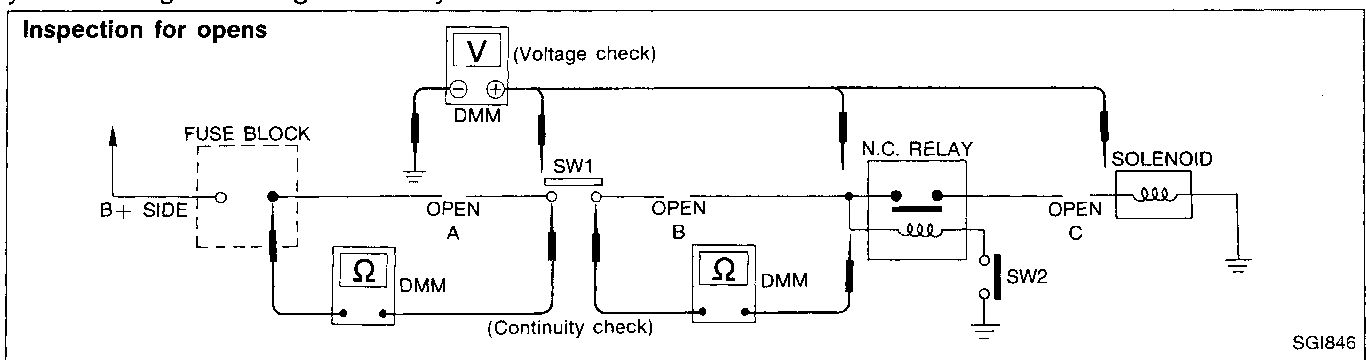

### Continuity check method

The continuity check is used to find an open in the circuit. The Digital Multimeter (DMM) set on the resistance function will indicate an open circuit as over limit (OL, no beep tone or no ohms symbol). Make sure no power is supplied to the checked component. Always start with the DMM at the highest resistance level.

To help in understanding the diagnosis of open circuits please refer to the schematic above.

1. Disconnect the battery negative cable.
2. Start at one end of the circuit and work your way to the other end. (At the fuse block in this example)
3. Connect one probe of the DMM to the fuse block terminal on the load side.
4. Connect the other probe to the fuse block (power) side of SW1. Little or no resistance will indicate that portion of the circuit has good continuity. If there were an open in the circuit, the DMM would indicate an over limit or infinite resistance condition. (point A)
5. Connect the probes between SW1 and the relay. Little or no resistance will indicate that portion of the circuit has good continuity. If there were an open in the circuit, the DMM would indicate an over limit or infinite resistance condition. (point B)
6. Connect the probes between the relay and the solenoid. Little or no resistance will indicate that portion of the circuit has good continuity. If there were an open in the circuit, the DMM would indicate an over limit or infinite resistance condition. (point C)

Any circuit can be diagnosed using the approach in the above example.

# HOW TO PERFORM EFFICIENT DIAGNOSIS FOR AN ELECTRICAL INCIDENT

## Circuit Inspection (Cont'd)

### Voltage check method

To help in understanding the diagnosis of open circuits please refer to the previous schematic. In any powered circuit, an open can be found by methodically checking the system for voltage. This is done by switching the DMM to the voltage function.

1. Connect one probe of the DMM to a known good ground.
2. Begin probing at one end of the circuit and work your way to the other end.
3. With SW1 open, probe at SW1 to check for voltage.  
voltage; open is further down the circuit than SW1.  
no voltage; open is between fuse block and SW1 (point A).
4. Close SW1 and probe at relay.  
voltage; open is further down the circuit than the relay.  
no voltage; open is between SW1 and relay (point B).
5. Close the relay and probe at the solenoid.  
voltage; open is further down the circuit than the solenoid.  
no voltage; open is between relay and solenoid (point C).

Any powered circuit can be diagnosed using the approach in the above example.

### TESTING FOR "SHORTS" IN THE CIRCUIT

To simplify the discussion of shorts in the system please refer to the schematic below.

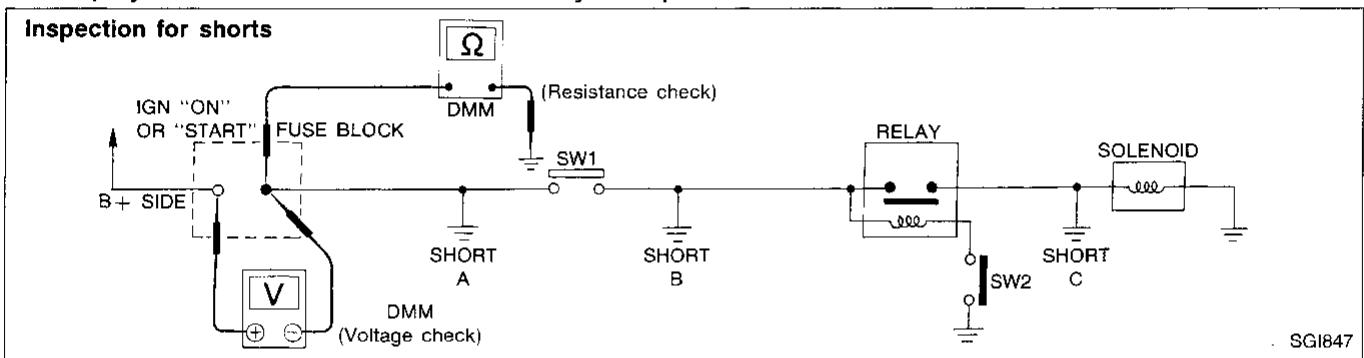

### Resistance check method

1. Disconnect the battery negative cable and remove the blown fuse.
2. Disconnect all loads (SW1 open, relay disconnected and solenoid disconnected) powered through the fuse.
3. Connect one probe of the ohmmeter to the load side of the fuse terminal. Connect the other probe to a known good ground.
4. With SW1 open, check for continuity.  
continuity; short is between fuse terminal and SW1 (point A).  
no continuity; short is further down the circuit than SW1.
5. Close SW1 and disconnect the relay. Put probes at the load side of fuse terminal and a known good ground. Then, check for continuity.  
continuity; short is between SW1 and the relay (point B).  
no continuity; short is further down the circuit than the relay.
6. Close SW1 and jump the relay contacts with jumper wire. Put probes at the load side of fuse terminal and a known good ground. Then, check for continuity.  
continuity; short is between relay and solenoid (point C).  
no continuity; check solenoid, retrace steps.

### Voltage check method

1. Remove the blown fuse and disconnect all loads (i.e. SW1 open, relay disconnected and solenoid disconnected) powered through the fuse.
2. Turn the ignition key to the ON or START position. Verify battery voltage at the B + side of the fuse terminal (one lead on the B + terminal side of the fuse block and one lead on a known good ground).
3. With SW1 open and the DMM leads across both fuse terminals, check for voltage.  
voltage; short is between fuse block and SW1 (point A).  
no voltage; short is further down the circuit than SW1.

# HOW TO PERFORM EFFICIENT DIAGNOSIS FOR AN ELECTRICAL INCIDENT

## Circuit Inspection (Cont'd)

4. With SW1 closed, relay and solenoid disconnected and the DMM leads across both fuse terminals, check for voltage.  
voltage; short is between SW1 and the relay (point B).  
no voltage; short is further down the circuit than the relay.
5. With SW1 closed, relay contacts jumped with fused jumper wire check for voltage.  
voltage; short is down the circuit of the relay or between the relay and the disconnected solenoid (point C).  
no voltage; retrace steps and check power to fuse block.

## GROUND INSPECTION

Ground connections are very important to the proper operation of electrical and electronic circuits. Ground connections are often exposed to moisture, dirt and other corrosive elements. The corrosion (rust) can become an unwanted resistance. This unwanted resistance can change the way a circuit works. Electronically controlled circuits are very sensitive to proper grounding. A loose or corroded ground can drastically affect an electronically controlled circuit. A poor or corroded ground can easily affect the circuit. Even when the ground connection looks clean, there can be a thin film of rust on the surface.

When inspecting a ground connection follow these rules:

1. Remove the ground bolt screw or clip.
2. Inspect all mating surfaces for tarnish, dirt, rust, etc.
3. Clean as required to assure good contact.
4. Reinstall bolt or screw securely.
5. Inspect for "add-on" accessories which may be interfering with the ground circuit.
6. If several wires are crimped into one ground eyelet terminal, check for proper crimps. Make sure all of the wires are clean, securely fastened and providing a good ground path. If multiple wires are cased in one eyelet make sure no ground wires have excess wire insulation.

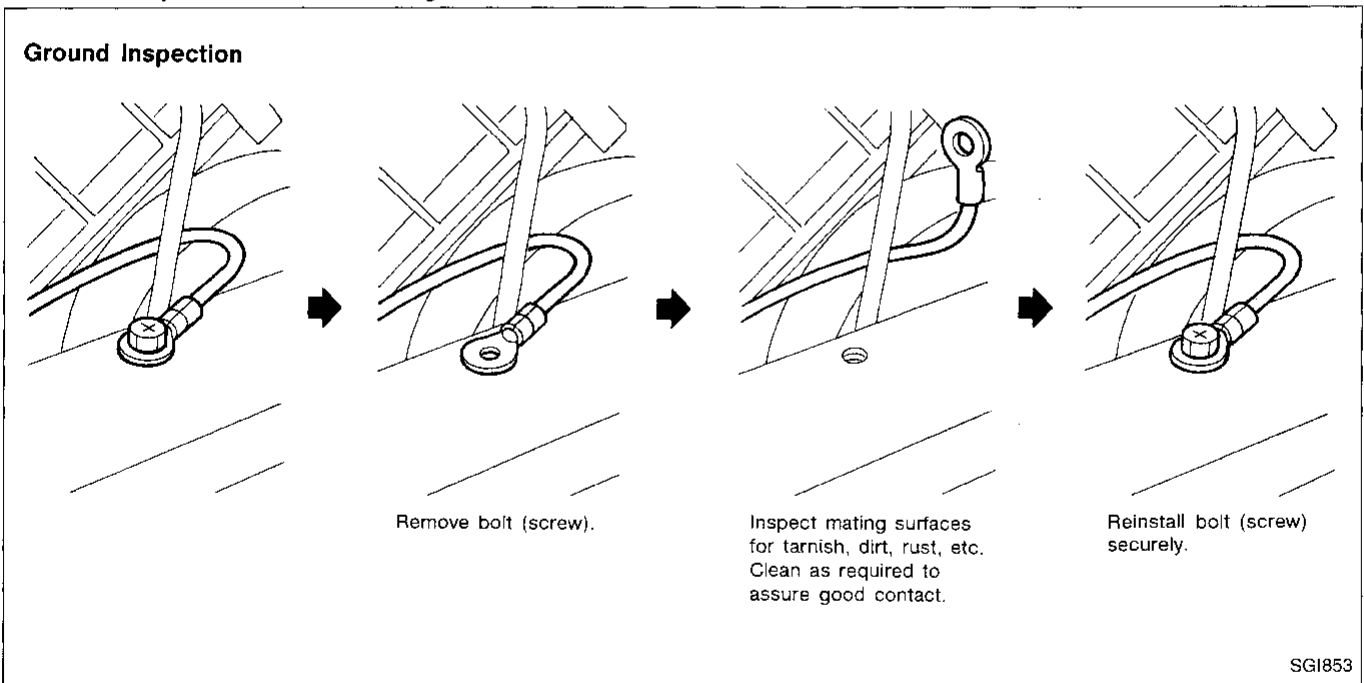



# HOW TO PERFORM EFFICIENT DIAGNOSIS FOR AN ELECTRICAL INCIDENT

## Circuit Inspection (Cont'd)

### VOLTAGE DROP TESTS

Voltage drop tests are often used to find components or circuits which have excessive resistance. A voltage drop in a circuit is caused by a resistance **when the circuit is in operation**.

Check the wire in the illustration. When measuring resistance with ohmmeter, contact by a single strand of wire will give reading of 0 ohms. This would indicate a good circuit. When the circuit operates, this single strand of wire is not able to carry the current. The single strand will have a high resistance to the current. This will be picked up as a slight voltage drop.

Unwanted resistance can be caused by many situations:

Undersized wiring (single strand example)

Corrosion on switch contacts

Loose wire connections or splices.

If repairs are needed always use wire that is of the same or larger gauge.

### Measuring voltage drop — Accumulated method

1. Connect the voltmeter across the connector or part of the circuit you want to check. The positive lead of the voltmeter should be closer to power and the negative lead closer to ground.
2. Operate the circuit.
3. The voltmeter will indicate how many volts are being used to “push” current through that part of the circuit.

**Note in the illustration that there is an excessive 4.1 volt drop between the battery and the bulb.**

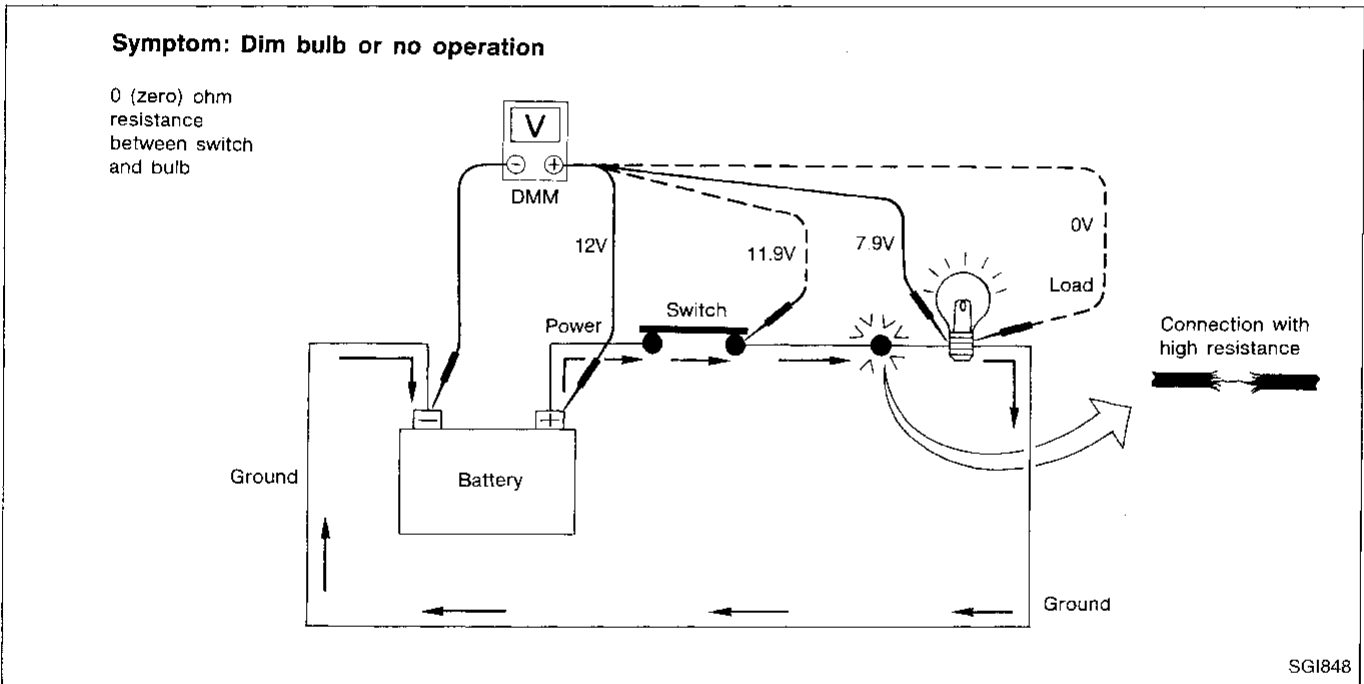

### Measuring voltage drop — Step by step

The step by step method is most useful for isolating excessive drops in low voltage systems (such as those in “Computer Controlled Systems”).

Circuits in the computer controlled system operate on very low amperage.

Computer controlled operations can be adversely affected by any variation in resistance in the system. Such resistance variation may be caused by poor connection, improper installation, improper wire gauge or corrosion.

The step by step voltage drop test can identify a component or wire with too much resistance.

# HOW TO PERFORM EFFICIENT DIAGNOSIS FOR AN ELECTRICAL INCIDENT

## Circuit Inspection (Cont'd)

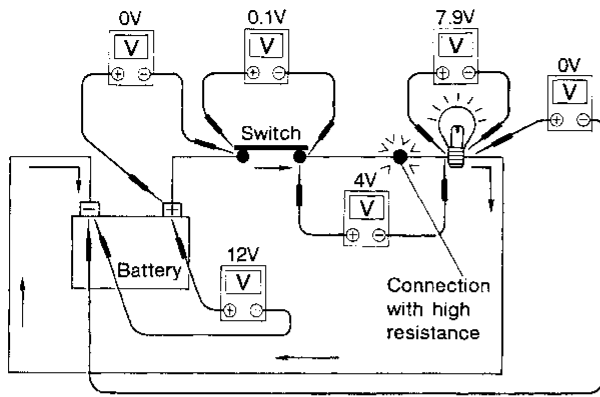

1. Connect the voltmeter as shown, starting at the battery and working your way around the circuit.
2. An unusually large voltage drop will indicate a component or wire that needs to be repaired. In the illustration, the poor connection causes a 4 volt drop.

The chart that follows illustrates some maximum allowable voltage drops. These values are given as a guideline, the exact value for each component may vary.

COMPONENT	VOLTAGE DROP
Wire	negligible <.001 volts
Ground Connections	Approx. 0.1 volts
Switch Contacts	Approx. 0.3 volts

AGI055

# HOW TO PERFORM EFFICIENT DIAGNOSIS FOR AN ELECTRICAL INCIDENT

## Circuit Inspection (Cont'd)

### Relationship between open/short (high resistance) circuit and the ECM pin control

System Description: When the switch is ON, the ECM lights up the lamp.

#### Case 1

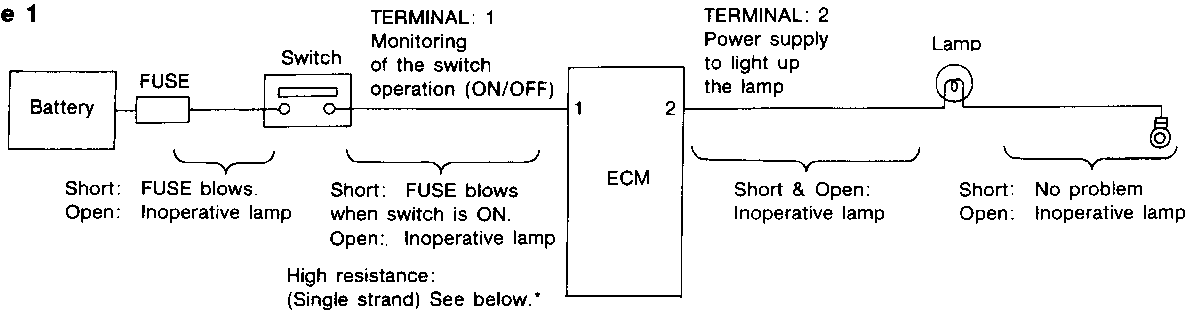

#### Input-output voltage chart

Pin No.	Item	Condition	Voltage value [V]	In case of high resistance such as single strand [V] *
1	Switch	Switch ON	Battery voltage	Lower than battery voltage Approx. 8 (Example)
		OFF	Approx. 0	Approx. 0
2	Lamp	Switch ON	Battery voltage	Approx. 0 (Inoperative lamp)
		OFF	Approx. 0	Approx. 0

The voltage value is based on the body ground.

\* : If high resistance exists in the switch side circuit (caused by a single strand), terminal 1 does not detect battery voltage. ECM does not detect the switch is ON even if the switch does turn ON. Therefore, the ECM does not supply power to light up the lamp.

#### Case 2

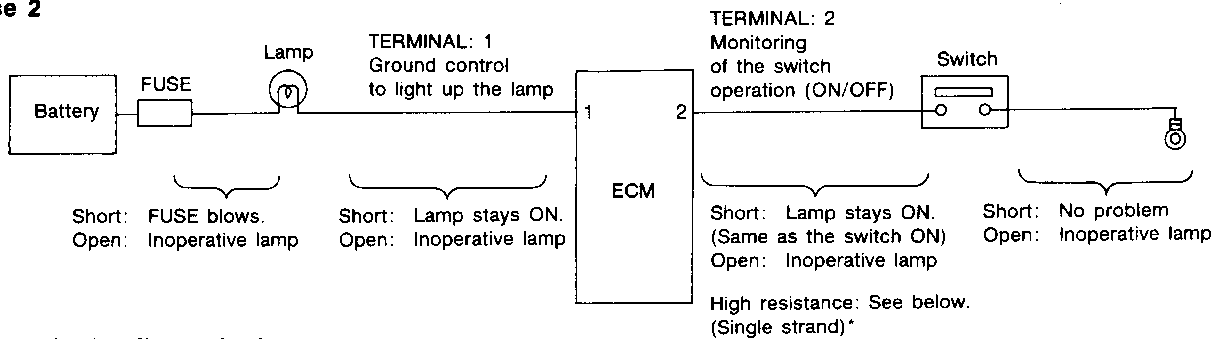

#### Input-output voltage chart

Pin No.	Item	Condition	Voltage value [V]	In case of high resistance such as single strand [V] *
1	Lamp	Switch ON	Approx. 0	Battery voltage (Inoperative lamp)
		OFF	Battery voltage	Battery voltage
2	Switch	Switch ON	Approx. 0	Higher than 0 Approx. 4 (Example)
		OFF	Approx. 5	Approx. 5

The voltage value is based on the body ground.

\* : If high resistance exists in the switch side circuit (caused by a single strand), terminal 2 does not detect approx. 0V. ECM does not detect the switch is ON even if the switch does turn ON. Therefore, the ECM does not control ground to light up the lamp.

GI

MA

EM

LC

EC

FE

AT

FA

RA

BR

ST

RS

BT

HA

EL

IDX

# HOW TO FOLLOW FLOW CHART IN TROUBLE DIAGNOSES

## NOTICE

The flow chart indicates work procedures required to diagnose problems effectively. Observe the following instructions before diagnosing.

- 1) Use the flow chart after locating probable causes of a problem following the "Preliminary Check", the "Symptom Chart" or the "Work Flow".
- 2) After repairs, re-check that the problem has been completely eliminated.
- 3) Refer to Component Parts Location and Harness Layout for the Systems described in each section for identification/location of components and harness connectors.
- 4) Refer to the Circuit Diagram for quick pinpoint check. If you must check circuit continuity between harness connectors in more detail, such as when a sub-harness is used, refer to Wiring Diagram and Harness Layout in EL section for identification of harness connectors.
- 5) When checking circuit continuity, ignition switch should be "OFF".
- 6) Before checking voltage at connectors, check battery voltage.
- 7) After accomplishing the Diagnostic Procedures and Electrical Components Inspection, make sure that all harness connectors are reconnected properly.

## Example

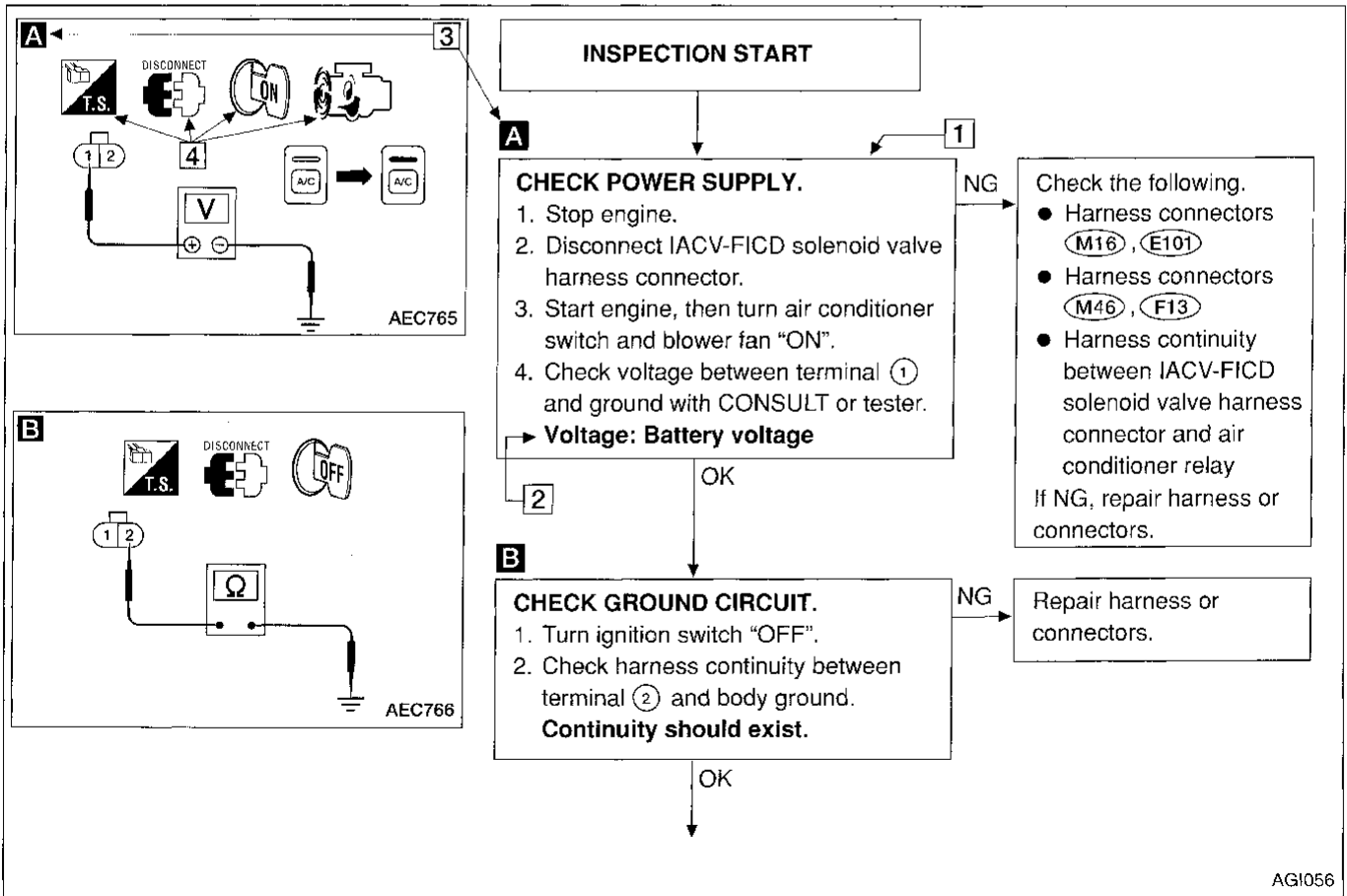

## HOW TO FOLLOW THIS FLOWCHART

### 1 Work and diagnostic procedure

Start to diagnose a problem using procedures indicated in enclosed blocks, as shown in the following example.

**A**

#### CHECK POWER SUPPLY.

1. Stop engine.
2. Disconnect IACV-FICD solenoid valve harness connector.
3. Start engine, then turn air conditioner switch and blower fan "ON".
4. Check voltage between terminal ① and ground with CONSULT or tester.  
**Voltage: Battery voltage**

← Check item being performed.

Procedure, steps or measurement results

GI

MA

EM

LC

EC

### 2 Measurement results

Required results are indicated in bold type in the corresponding block, as shown below.

These have the following meanings:

**Battery voltage** → 11 - 14V or approximately 12V

**Voltage: Approximately 0V** → Less than 1V

**Resistance: Continuity should exist** → Approximately 0Ω

HE

AT

FA

### 3 Cross reference of work symbols in the text and illustrations

Illustrations are provided as visual aids for work procedures. For example, symbol **A** indicated in the left upper portion of each illustration corresponds with the symbol in the flowchart for easy identification. More precisely, the procedure under the "CHECK POWER SUPPLY" outlined previously is indicated by an illustration **A**.

PA

BR

ST

### 4 Symbols used in illustrations

Symbols included in illustrations refer to measurements or procedures. Before diagnosing a problem, familiarize yourself with each symbol.

For connector symbols, refer to GI-12.

RS

BT





















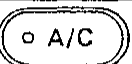

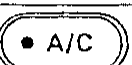

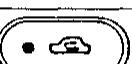

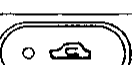

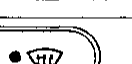



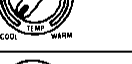

HA

EL











IDX

# HOW TO FOLLOW FLOW CHART IN TROUBLE DIAGNOSES

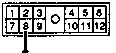
## Key to symbols signifying measurements or procedures

Symbol	Symbol explanation	Symbol	Symbol explanation
	Check after disconnecting the connector to be measured.		Current should be measured with an ammeter.
	Check after connecting the connector to be measured.		Procedure with CONSULT
	Insert key into ignition switch.		Procedure without CONSULT
	Remove key from ignition switch.		Procedure with Generic Scan Tool (GST, OBD-II scan tool)
	Turn ignition switch to "OFF" position.		Procedure without CONSULT or GST
	Turn ignition switch to "ON" position.		A/C switch is "OFF".
	Turn ignition switch to "START" position.		A/C switch is "ON".
	Turn ignition switch from "OFF" to "ACC" position.		REC switch is "ON".
	Turn ignition switch from "ACC" to "OFF" position.		REC switch is "OFF".
	Turn ignition switch from "OFF" to "ON" position.		DEF switch is "ON".
	Turn ignition switch from "ON" to "OFF" position.		VENT switch is "ON".
	Do not start engine, or check with engine stopped.		Fan switch is "ON".
	Start engine, or check with engine running.		Temperature control switch is in full cold position.
	Apply parking brake.		Temperature control switch is in full hot position.
	Release parking brake.		Apply positive voltage from battery with fuse directly to components.
	Check after engine is warmed up sufficiently.		Drive vehicle.
	Voltage should be measured with a voltmeter.		Disconnect battery negative cable.
	Circuit resistance should be measured with an ohmmeter.		Depress brake pedal.

# HOW TO FOLLOW FLOW CHART IN TROUBLE DIAGNOSES

Symbol	Symbol explanation	Symbol	Symbol explanation
	Release brake pedal.	   	<p>Pin terminal check for SMJ type ECM and A/T control unit connectors.  <b>For details regarding the terminal arrangement, refer to the foldout page.</b></p>    
	Depress accelerator pedal.		
	Release accelerator pedal.		

GI

MA

EM

LC

EC

FE

AT

FA

RA

BR

ST

RS

BT

HA

EL

IDX

# CONSULT CHECKING SYSTEM

## Function and System Application

Diagnostic test mode	Function	ECCS	A/T	Air bag
Work support	This mode enables a technician to adjust some devices faster and more accurately by following the indications on CONSULT.	x	—	—
Self-diagnostic results	Self-diagnostic results can be read and erased quickly.	x	x	x
Trouble diagnostic record	Current self-diagnostic results and all trouble diagnostic records previously stored can be read.	—	—	x
ECU discriminated No.	Classification number of a replacement ECU can be read to prevent an incorrect ECU from being installed.	—	—	x
Data monitor	Input/Output data in the ECM can be read.	x	x	—
Active test	Diagnostic Test Mode in which CONSULT drives some actuators apart from the ECMs and also shifts some parameters in a specified range.	x	—	—
ECM part number	ECM part number can be read.	x	x	—
Function test	Conducted by CONSULT instead of a technician to determine whether each system is "OK" or "NG".	x	—	—

x: Applicable

## Lithium Battery Replacement

CONSULT contains a lithium battery. When replacing the battery do the following:

**WARNING:**

**Replace the lithium battery with SANYO Electric Co., Ltd., CR2032 only. Use of another battery may present a risk of fire or explosion. The battery may present a fire or chemical burn hazard if mistreated. Do not recharge, disassemble or dispose of in fire.**

**Keep the battery out of reach of children and discard used battery conforming to the local regulations.**

## Checking Equipment

When ordering the below equipment, contact your NISSAN distributor

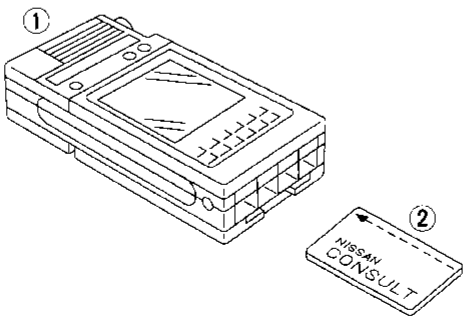
Tool name	Description
<b>NISSAN CONSULT</b> ① CONSULT unit and accessories ② Program card UE950	 <p style="text-align: left; margin-left: 20px;">NT004</p>



# IDENTIFICATION INFORMATION

## Model Variation

Body	Engine	Transaxle (A/T)	Destination	Grade	Model
Wagon	VG30E	RE4F04A	Non-California, U.S.A.	XE	TLBVLTB-EUA
				GXE	TLBVLUB-EUA
				Cargo Van	YLBVLSB-EUA
			California, U.S.A.	XE	TLBVLTB-EVA
				GXE	TLBVLUB-EVA
				Cargo Van	YLBVLSB-EVA
			Canada	XE	TLBVLTB-ENA
				GXE	TLBVLUB-ENA

**Prefix and suffix designations:**

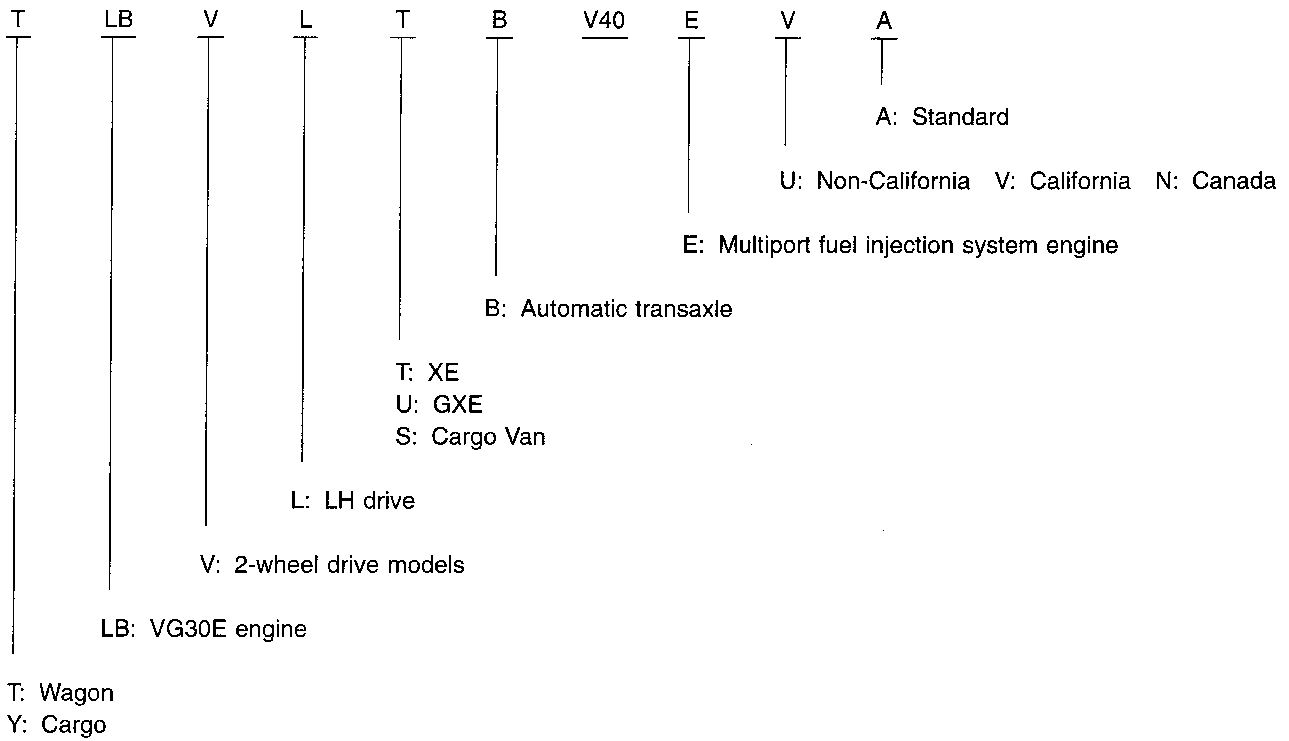

GI  
MA  
EM  
LC  
EC  
FE  
AT  
FA  
RA  
BR  
ST  
RS  
BT  
HA  
EL  
IDX

# IDENTIFICATION INFORMATION

## Identification Number

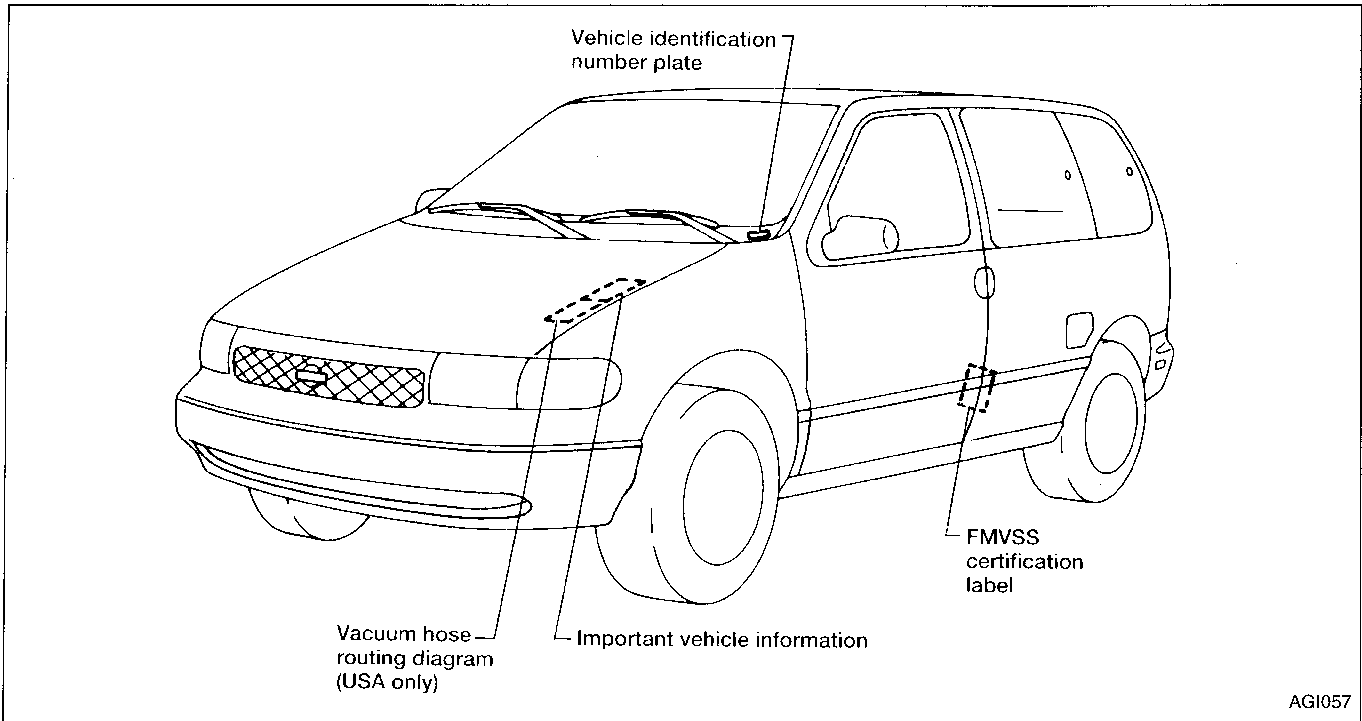

AGI057

## VEHICLE IDENTIFICATION NUMBER ARRANGEMENT

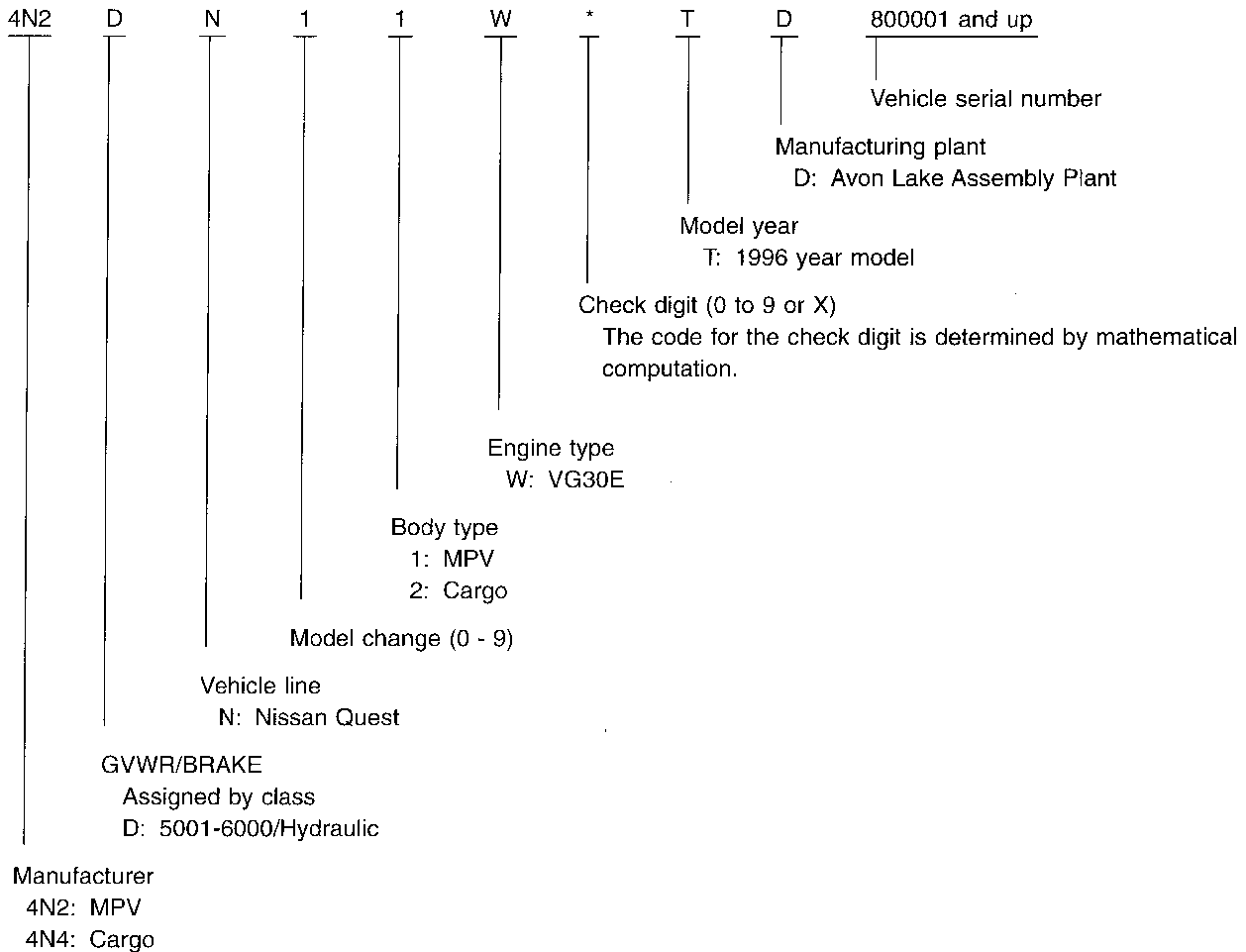

# IDENTIFICATION INFORMATION

## Identification Number (Cont'd)

### ENGINE SERIAL NUMBER

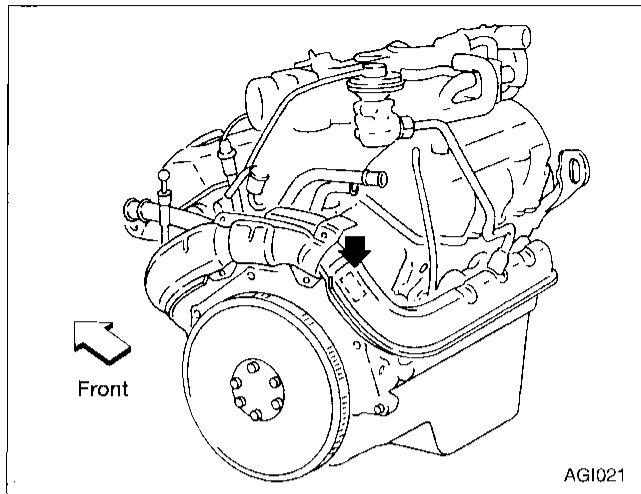

### AUTOMATIC TRANSAXLE NUMBER

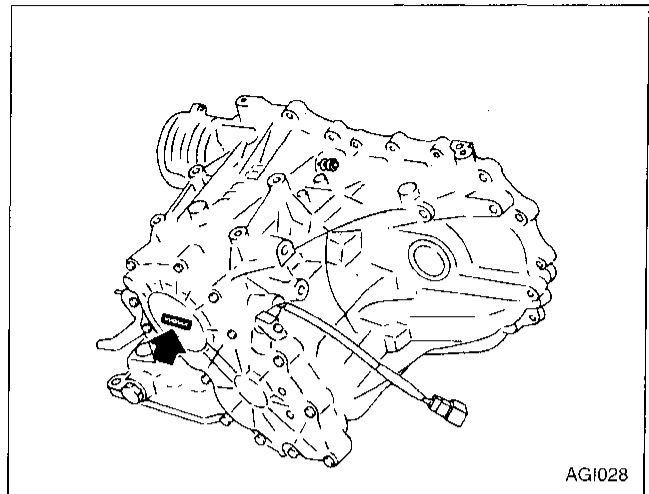

GI

NA

EM

LC

EC

PE

## Dimensions

Unit: mm (in)

Overall length	4,824 (189.9)
Overall width	1,871 (73.7)
Overall height	1,717 (67.6)
Front tread	1,610 (63.4)
Rear tread	1,610 (63.4)
Wheelbase	2,850 (112.2)

AT

FA

RA

## Wheels and Tires

	5-1/2-JJx15 (Steel)	6-1/2-JJx15 (Cast aluminum)
Road wheel	5-1/2-JJx15 (Steel)	6-1/2-JJx15 (Cast aluminum)
Offset	45 (1.77)	45 (1.77)
Conventional tire	P205/75R15 97S	P205/75R15 97S, P215/70R15 97H*1
Spare tire	T125/90D16, P205/75R15 97S*2*3 P215/70R15 97H*1	—
Towing package	P205/75R15 97S	P215/70R15 97H*1
Optional suspension	—	P215/70R15 97H

BR

ST

RS

BT

FA

\*1: With optional suspension.

\*2: With towing package.

\*3: Or with P205 full size spare option.

EL

IDX

# LIFTING POINTS AND TOW TRUCK TOWING

## Preparation

### SPECIAL SERVICE TOOLS

The actual shapes of Kent-Moore tools may differ from those of special service tools illustrated here.

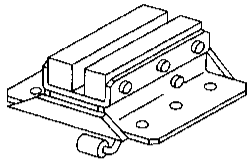
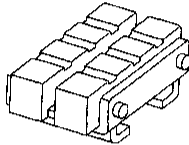
Tool number (Kent-Moore number) Tool name	Description
LM4086-0200 ( — ) Board on attachment	 NT001
LM4519-0000 ( — ) Safety stand attachment	 NT002

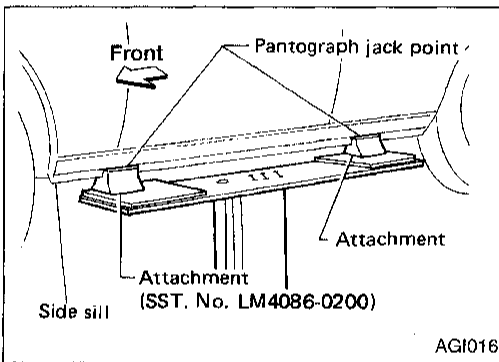

### Board-on Lift

#### CAUTION:

Make sure vehicle is empty when lifting.

- The board-on lift attachment (LM4086-0200) set at front end of vehicle should be set on the front of the sill under the front door opening.
- Position attachments at front and rear ends of board-on lift.

## Garage Jack and Safety Stand

### WARNING:

- Never get under the vehicle while it is supported only by the jack. Always use safety stands to support the frame when you have to get under the vehicle.
- Place wheel chocks at both front and back of the wheels on the ground.

### CAUTION:

Place a wooden or rubber block between safety stand and vehicle body when the supporting body is flat.

## 2-pole Lift

### WARNING:

When lifting the vehicle, open the lift arms as wide as possible and ensure that the front and rear of the vehicle are well balanced.

When setting the lift arm, do not allow the arm to contact the brake tubes or fuel lines.

### CAUTION:

Place a wooden or rubber block between front lift arms and body to ensure proper clearance.

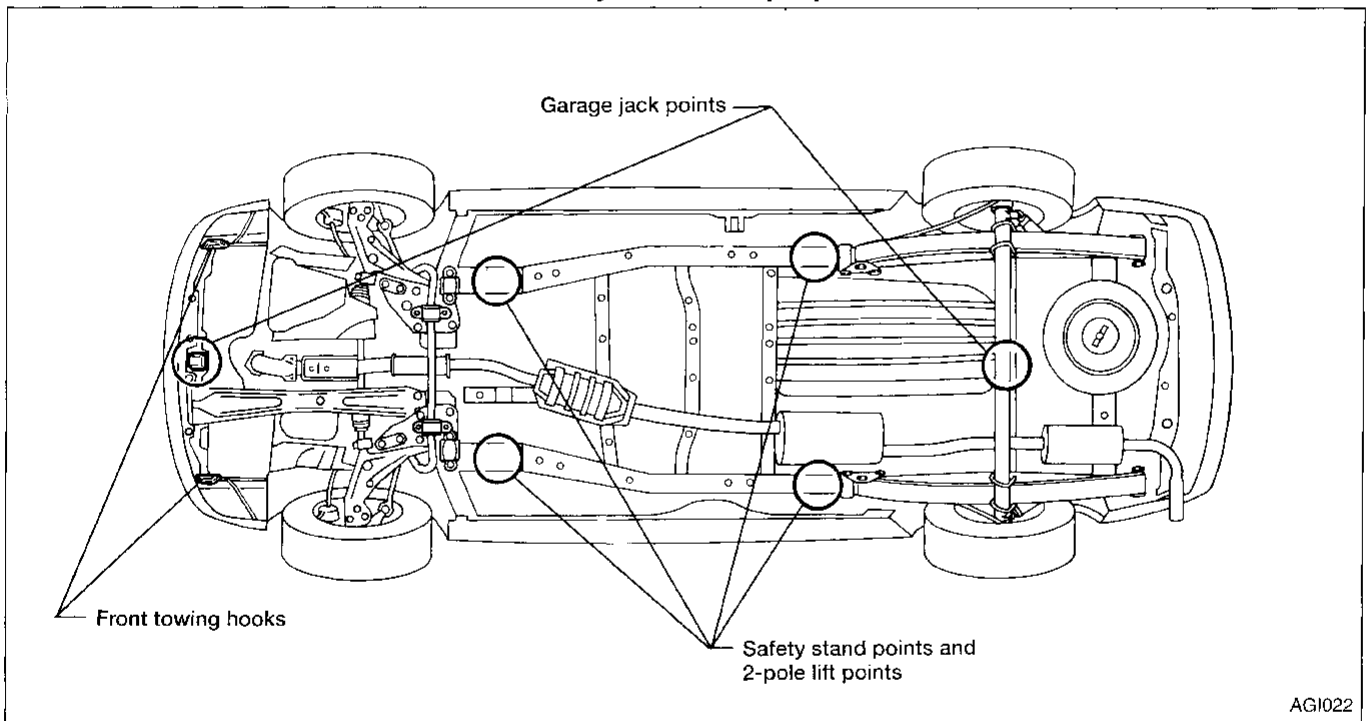

## Tow Truck Towing

### CAUTION:

- All applicable local laws regarding the towing operation must be obeyed.
- Use proper towing equipment to avoid possible damage to the vehicle during a towing operation.
- When towing with the rear wheels on the ground, release the parking brake and move the gearshift lever to neutral position ("N" position).

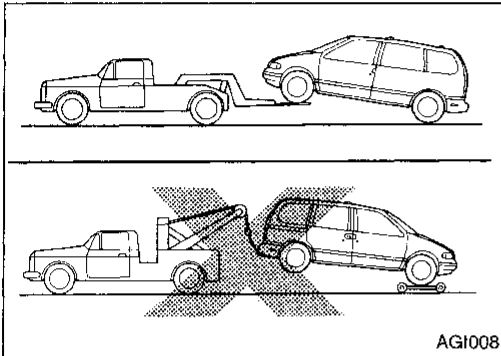

NISSAN recommends that vehicle be towed with the driving (front) wheels off the ground as illustrated.

- No sling towing from the rear is allowed because damage may occur to the bumper's absorbing mechanism.

### TOWING AN AUTOMATIC TRANSAXLE MODEL WITH FOUR WHEELS ON GROUND

Observe the following restricted towing speeds and distances.

#### Speed:

Below 50 km/h (30 MPH)

#### Distance:

Less than 65 km (40 miles)

### CAUTION:

Never tow an automatic transaxle model from the rear (i.e., backward) with four wheels on the ground as this may cause serious and expensive damage to the transaxle.

### TOWING AN AUTOMATIC TRANSAXLE MODEL WITH REAR WHEELS RAISED (With front wheels on ground)

### CAUTION:

Never tow an automatic transaxle model with rear wheels raised (with front wheels on ground). This may cause serious and expensive damage to the transaxle. If it is necessary to tow it with rear wheels raised, always use a towing dolly under the front wheels.

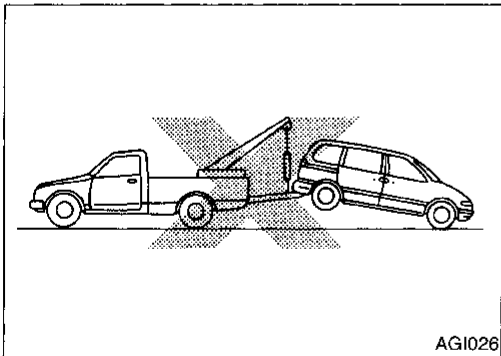

### VEHICLE RECOVERY (Freeing a stuck vehicle)

- Tow chains or cables must be attached only to the main structural members of the vehicle.
- Pulling devices should be routed so they do not touch any part of the suspension, steering, brake or cooling systems.
- Always pull the cable straight out from the front or rear of the vehicle. Never pull the vehicle at a sideways angle.
- Pulling devices such as ropes or canvas straps are not recommended for use for vehicle towing or recovery.

# TIGHTENING TORQUE OF STANDARD BOLTS

Grade	Bolt size	Bolt diameter* mm	Pitch mm	Tightening torque (Without lubricant)								
				Hexagon head bolt				Hexagon flange bolt				
				N·m	kg·m	ft·lb	in·lb	N·m	kg·m	ft·lb	in·lb	
4T	M6	6.0	1.0	5.1	0.52	3.8	45.1	6.1	0.62	4.5	53.8	GI
	M8	8.0	1.25	13	1.3	9	—	15	1.5	11	—	MA
			1.0	13	1.3	9	—	16	1.6	12	—	EM
	M10	10.0	1.5	25	2.5	18	—	29	3.0	22	—	EM
			1.25	25	2.6	19	—	30	3.1	22	—	LC
	M12	12.0	1.75	42	4.3	31	—	51	5.2	38	—	LC
1.25			46	4.7	34	—	56	5.7	41	—	EC	
M14	14.0	1.5	74	7.5	54	—	88	9.0	65	—	EC	
7T	M6	6.0	1.0	8.4	0.86	6.2	74.6	10	1.0	7	87	EC
	M8	8.0	1.25	21	2.1	15	—	25	2.5	18	—	FE
			1.0	22	2.2	16	—	26	2.7	20	—	FE
	M10	10.0	1.5	41	4.2	30	—	48	4.9	35	—	AT
			1.25	43	4.4	32	—	51	5.2	38	—	AT
	M12	12.0	1.75	71	7.2	52	—	84	8.6	62	—	FA
1.25			77	7.9	57	—	92	9.4	68	—	FA	
M14	14.0	1.5	127	13.0	94	—	147	15.0	108	—	FA	
9T	M6	6.0	1.0	12	1.2	9	—	15	1.5	11	—	RS
	M8	8.0	1.25	29	3.0	22	—	35	3.6	26	—	RA
			1.0	31	3.2	23	—	37	3.8	27	—	RA
	M10	10.0	1.5	59	6.0	43	—	70	7.1	51	—	BR
			1.25	62	6.3	46	—	74	7.5	54	—	BR
	M12	12.0	1.75	98	10.0	72	—	118	12.0	87	—	ST
1.25			108	11.0	80	—	137	14.0	101	—	ST	
M14	14.0	1.5	177	18.0	130	—	206	21.0	152	—	RS	

1. Special parts are excluded.

2. This standard is applicable to bolts having the following marks embossed on the bolt head.

\*: Nominal diameter

Grade	Mark
4T	4
7T	7
9T	9

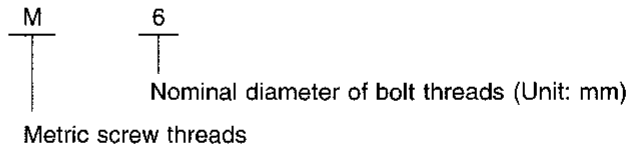

# SAE J1930 TERMINOLOGY LIST

## SAE J1930 Terminology List

All emission related terms used in this publication in accordance with SAE J1930 are listed. Accordingly, new terms, new acronyms/abbreviations and old terms are listed in the following chart.

\*\*\*: Not applicable

NEW TERM	NEW ACRONYM / ABBREVIATION	OLD TERM
Absolute pressure sensor	***	***
Air cleaner	ACL	Air cleaner
Barometric pressure	BARO	***
Barometric pressure sensor-BCDD	BAROS-BCDD	BCDD
Camshaft position	CMP	***
Camshaft position sensor	CMPS	Crank angle sensor
Canister	***	Canister
Carburetor	CARB	Carburetor
Charge air cooler	CAC	Intercooler
Closed loop	CL	Closed loop
Closed throttle position switch	CTP switch	Idle switch
Clutch pedal position switch	CPP switch	Clutch switch
Continuous fuel injection system	CFI system	***
Continuous trap oxidizer system	CTOX system	***
Crankshaft position	CKP	***
Crankshaft position sensor	CKPS	***
Data link connector	DLC	***
Data link connector for CONSULT	DLC for CONSULT	Diagnostic connector for CONSULT
Diagnostic test mode	DTM	Diagnostic mode
Diagnostic test mode selector	DTM selector	Diagnostic mode selector
Diagnostic test mode I	DTM I	Mode I
Diagnostic test mode II	DTM II	Mode II
Diagnostic trouble code	DTC	Malfunction code
Direct fuel injection system	DFI system	***
Distributor ignition system	DI system	Ignition timing control
Early fuel evaporation-mixture heater	EFE-mixture heater	Mixture heater
Early fuel evaporation system	EFE system	Mixture heater control
Electrically erasable programmable read only memory	EEPROM	***
Electronic ignition system	EI system	Ignition timing control
Engine control	EC	***
Engine control module	ECM	ECCS control unit
Engine coolant temperature	ECT	Engine temperature
Engine coolant temperature sensor	ECTS	Engine temperature sensor
Engine modification	EM	***
Engine speed	RPM	Engine speed
Erasable programmable read only memory	EPROM	***



# SAE J1930 TERMINOLOGY LIST

## SAE J1930 Terminology List (Cont'd)

\*\*\*: Not applicable

NEW TERM	NEW ACRONYM / ABBREVIATION	OLD TERM	
Evaporative emission canister or Canister	EVAP canister or Canister	Canister	<b>GI</b>
Evaporative emission canister purge control solenoid valve	EVAP canister purge control solenoid valve	Canister control solenoid valve	MA
Evaporative emission canister purge control valve	EVAP canister purge control valve	Canister purge cut valve	EM
Evaporative emission canister vent control valve	EVAP canister vent control valve	***	LC
Evaporative emission canister purge volume control valve	EVAP canister purge volume control valve	Canister purge control valve	EC
Evaporative emission control system pressure sensor	EVAP control system pressure sensor	***	FE
Evaporative emission shut valve	EVAP shut valve	Shutoff valve	AT
Evaporative emission system	EVAP system	Evaporative emission control system	FA
Exhaust gas recirculation valve	EGR valve	EGR valve	RA
Exhaust gas recirculation control-BPT valve	EGRC-BPT valve	BPT valve	BR
Exhaust gas recirculation control-solenoid valve	EGRC-solenoid valve	EGR control solenoid valve	ST
Exhaust gas recirculation temperature sensor	EGRT sensor	Exhaust gas temperature sensor	RS
EGR temperature sensor			BT
Flash electrically erasable programmable read only memory	FEEPROM	***	HA
Flash erasable programmable read only memory	FEPROM	***	EL
Flexible fuel sensor	FFS	***	IDX
Flexible fuel system	FF system	***	
Fuel pressure regulator	***	Pressure regulator	
Fuel pressure regulator control solenoid valve	***	PRVR control solenoid valve	
Fuel trim	FT	***	
Heated Oxygen sensor	HO2S	Exhaust gas sensor	
Idle air control system	IAC system	Idle speed control	
Idle air control valve-air regulator	IACV-air regulator	Air regulator	
Idle air control valve-auxiliary air control valve	IACV-AAC valve	Auxiliary air control (AAC) valve	
Idle air control valve-FICD solenoid valve	IACV-FICD solenoid valve	FICD solenoid valve	
Idle air control valve-idle up control solenoid valve	IACV-idle up control solenoid valve	Idle up control solenoid valve	
Idle speed control-FI pot	ISC-FI pot	FI pot	
Idle speed control system	ISC system	***	
Ignition control	IC	***	
Ignition control module	ICM	***	
Indirect fuel injection system	IFI system	***	
Intake air	IA	Air	
Intake air temperature sensor	IAT sensor	Air temperature sensor	

# SAE J1930 TERMINOLOGY LIST

## SAE J1930 Terminology List (Cont'd)

\*\*\*: Not applicable

NEW TERM	NEW ACRONYM / ABBREVIATION	OLD TERM
Knock	***	Detonation
Knock sensor	KS	Detonation sensor
Malfunction indicator lamp	MIL	Check engine light
Manifold absolute pressure	MAP	***
Manifold absolute pressure/Barometric pressure switch solenoid valve	MAP/BARO switch solenoid valve	***
Manifold absolute pressure sensor	MAPS	***
Manifold differential pressure	MDP	***
Manifold differential pressure sensor	MDPS	***
Manifold surface temperature	MST	***
Manifold surface temperature sensor	MSTS	***
Manifold vacuum zone	MVZ	***
Manifold vacuum zone sensor	MVZS	***
Mass air flow sensor	MAFS	Air flow meter
Mixture control solenoid valve	MC solenoid valve	Air-fuel ratio control solenoid valve
Multiport fuel injection System	MFI system	Fuel injection control
Neutral position switch	***	Neutral switch
Nonvolatile random access memory	NVRAM	***
Onboard diagnostic system	OBD system	Self-diagnosis
Open loop	OL	Open loop
Oxidation catalyst	OC	Catalyst
Oxidation catalytic converter system	OC system	***
Oxygen sensor	O2S	Exhaust gas sensor
Park position switch	***	Park switch
Park/neutral position switch	PNP switch	Park/neutral switch
Periodic trap oxidizer system	PTOX system	***
Positive crankcase ventilation	PCV	Positive crankcase ventilation
Positive crankcase ventilation valve	PCV valve	PCV valve
Powertrain control module	PCM	***
Programmable read only memory	PROM	***
Pulsed secondary air injection control solenoid valve	PAIRC solenoid valve	AIV control solenoid valve
Pulsed secondary air injection system	PAIR system	Air induction valve (AIV) control
Pulsed secondary air injection valve	PAIR valve	Air induction valve
Random access memory	RAM	***
Read only memory	ROM	***
Scan tool	ST	***
Secondary air injection pump	AIR pump	***
Secondary air injection system	AIR system	***
Sequential multiport fuel injection system	SFI system	Sequential fuel injection

# SAE J1930 TERMINOLOGY LIST

## SAE J1930 Terminology List (Cont'd)

\*\*\*: Not applicable

NEW TERM	NEW ACRONYM / ABBREVIATION	OLD TERM
Service reminder indicator	SRI	***
Simultaneous multiport fuel injection system	***	Simultaneous fuel injection
Smoke puff limiter system	SPL system	***
Supercharger	SC	***
Supercharger bypass	SCB	***
System readiness test	SRT	***
Tank fuel temperature sensor	***	***
Thermal vacuum valve	TVV	Thermal vacuum valve
Three-way catalyst	TWC	Catalyst
Three-way catalytic converter system	TWC system	***
Three-way + oxidation catalyst	TWC + OC	Catalyst
Three-way + oxidation catalytic converter system	TWC + OC system	***
Throttle body	TB	Throttle chamber SPI body
Throttle body fuel injection system	TBI system	Fuel injection control
Throttle position	TP	Throttle position
Throttle position sensor	TPS	Throttle sensor
Throttle position switch	TP switch	Throttle switch
Torque converter clutch solenoid valve	TCC solenoid valve	Lock-up cancel solenoid Lock-up solenoid
Turbocharger	TC	Turbocharger
Vacuum cut valve	***	Vacuum control valve
Vacuum cut valve bypass valve	***	***
Vehicle speed sensor	VSS	Vehicle speed sensor
Volume air flow sensor	VAFS	Air flow meter
Warm up oxidation catalyst	WU-OC	Catalyst
Warm up oxidation catalytic converter system	WU-OC system	***
Warm up three-way catalyst	WU-TWC	Catalyst
Warm up three-way catalytic converter system	WU-TWC system	***
Wide open throttle position switch	WOTP switch	Full switch

GI

MA

EW

LC

EC

FE

AT

FA

RA

BR

ST

RS

BT

HA

EL

IX