

SECTION **AV**

AUDIO, VISUAL & NAVIGATION SYSTEM

CONTENTS

BASE AUDIO	Reference Values	25	F
	Wiring Diagram — BASE AUDIO —	27	
BASIC INSPECTION	SYMPTOM DIAGNOSIS	32	G
DIAGNOSIS AND REPAIR WORKFLOW	AUDIO SYSTEM SYMPTOMS	32	
Work Flow	Symptom Table	32	H
FUNCTION DIAGNOSIS	NORMAL OPERATING CONDITION	33	
AUDIO SYSTEM	Description	33	I
System Diagram	PRECAUTION	34	
System Description	PRECAUTIONS	34	J
Component Parts Location	Precaution for Supplemental Restraint System (SRS) "AIR BAG" and "SEAT BELT PRE-TENSIONER"	34	K
Component Description	Precaution for Trouble Diagnosis	34	
DIAGNOSIS SYSTEM (AUDIO UNIT)	Precaution for Harness Repair	34	L
Diagnosis Description	PREPARATION	36	
COMPONENT DIAGNOSIS	PREPARATION	36	M
POWER SUPPLY AND GROUND CIRCUIT	Commercial Service Tools	36	
AUDIO UNIT	ON-VEHICLE REPAIR	37	
AUDIO UNIT : Diagnosis Procedure	AUDIO UNIT	37	AV
STEERING SWITCH SIGNAL A CIRCUIT	Exploded View	37	
Description	Removal and Installation	37	
Diagnosis Procedure	AUDIO DISPLAY	38	O
Component Inspection	Exploded View	38	
STEERING SWITCH SIGNAL B CIRCUIT	Removal and Installation	38	P
Description	FRONT DOOR SPEAKER	39	
Diagnosis Procedure	Exploded View	39	
Component Inspection	Removal and Installation	39	
STEERING SWITCH SIGNAL GND CIRCUIT	REAR DOOR SPEAKER	40	
Description	Exploded View	40	
Diagnosis Procedure	Removal and Installation	40	
Component Inspection			
ECU DIAGNOSIS			
AUDIO UNIT			

FRONT SQUAWKER	41	System Diagram	60
Exploded View	41	System Description	60
Removal and Installation	41	Component Parts Location	62
STEERING SWITCH	42	Component Description	63
Exploded View	42	DVD ENTERTAINMENT SYSTEM	64
Removal and Installation	42	System Diagram	64
ROOF ANTENNA	43	System Description	64
Exploded View	43	Component Parts Location	65
Removal and Installation	43	Component Description	66
ANTENNA FEEDER (RADIO)	44	HANDS-FREE PHONE SYSTEM	67
Harness Layout	44	System Diagram	67
BOSE AUDIO WITHOUT NAVIGATION		System Description	67
BASIC INSPECTION	45	Component Parts Location	68
DIAGNOSIS AND REPAIR WORK FLOW	45	Component Description	69
Work Flow	45	DIAGNOSIS SYSTEM (AV CONTROL UNIT)...	70
INSPECTION AND ADJUSTMENT	47	Diagnosis Description	70
ADDITIONAL SERVICE WHEN REMOVING BATTERY NEGATIVE TERMINAL	47	CONSULT-III Function (MULTI AV)	83
ADDITIONAL SERVICE WHEN REMOVING BATTERY NEGATIVE TERMINAL : Description ...	47	DIAGNOSIS SYSTEM (TEL ADAPTER UNIT)..	87
ADDITIONAL SERVICE WHEN REMOVING BATTERY NEGATIVE TERMINAL : Special Repair Requirement	47	Diagnosis Description	87
ADDITIONAL SERVICE WHEN REPLACING CONTROL UNIT	47	COMPONENT DIAGNOSIS	89
ADDITIONAL SERVICE WHEN REPLACING CONTROL UNIT : Description	47	U1000 CAN COMM CIRCUIT	89
ADDITIONAL SERVICE WHEN REPLACING CONTROL UNIT : Special Repair Requirement	47	Description	89
REAR VIEW MONITOR POSSIBLE ROUTE LINE CENTER POSITION ADJUSTMENT	47	DTC Logic	89
REAR VIEW MONITOR POSSIBLE ROUTE LINE CENTER POSITION ADJUSTMENT : Description ...	47	Diagnosis Procedure	89
REAR VIEW MONITOR POSSIBLE ROUTE LINE CENTER POSITION ADJUSTMENT : Special Repair Requirement	47	U1010 CONTROL UNIT (CAN)	90
FUNCTION DIAGNOSIS	48	Description	90
MULTI AV SYSTEM	48	DTC Logic	90
System Diagram	48	Diagnosis Procedure	90
System Description	51	U1310 AV CONTROL UNIT	91
Component Parts Location	53	Description	91
Component Description	54	DTC Logic	91
REAR VIEW MONITOR SYSTEM	57	U1200 AV CONTROL UNIT	92
System Diagram	57	Description	92
System Description	57	DTC Logic	92
Component Parts Location	58	U1216 AV CONTROL UNIT	93
Component Description	59	Description	93
AUDIO SYSTEM	60	DTC Logic	93
		U1243 DISPLAY UNIT	94
		Description	94
		DTC Logic	94
		Diagnosis Procedure	94
		U1247 REAR DISP CONN	96
		Description	96
		DTC Logic	96
		Diagnosis Procedure	96
		U1250 CAMERA CONTROL UNIT	98
		Description	98
		DTC Logic	98
		Diagnosis Procedure	98

U1255 SATELLITE RADIO TUNER	99	RGB AREA (YS) SIGNAL CIRCUIT (AV CONTROL UNIT TO FRONT DISPLAY UNIT)	115	A
Description	99	Description	115	
DTC Logic	99	Diagnosis Procedure	115	
Diagnosis Procedure	99			
U1300 AV COMM CIRCUIT	101	HP SIGNAL CIRCUIT (FRONT DISPLAY UNIT TO AV CONTROL UNIT)	116	B
Description	101	Description	116	
		Diagnosis Procedure	116	
POWER SUPPLY AND GROUND CIRCUIT ...	103			C
AV CONTROL UNIT	103	VP SIGNAL CIRCUIT (FRONT DISPLAY UNIT TO AV CONTROL UNIT)	117	D
AV CONTROL UNIT : Diagnosis Procedure	103	Description	117	
		Diagnosis Procedure	117	
FRONT DISPLAY UNIT	103			E
FRONT DISPLAY UNIT : Diagnosis Procedure ...	103	COMPOSITE IMAGE SIGNAL CIRCUIT (AV CONTROL UNIT TO FRONT DISPLAY UNIT). 118		
		Description	118	
REAR DISPLAY UNIT	104	Diagnosis Procedure	118	F
REAR DISPLAY UNIT : Diagnosis Procedure	104			
VIDEO DISTRIBUTOR	105	COMPOSITE IMAGE SIGNAL CIRCUIT (VIDEO DISTRIBUTOR TO AV CONTROL UNIT) . 119		G
VIDEO DISTRIBUTOR : Diagnosis Procedure	105	Description	119	
		Diagnosis Procedure	119	
DVD PLAYER	106			H
DVD PLAYER : Diagnosis Procedure	106	COMPOSITE IMAGE SIGNAL CIRCUIT (VIDEO DISTRIBUTOR TO REAR DISPLAY UNIT)		
		Description	120	
MULTIFUNCTION SWITCH	106	Diagnosis Procedure	120	I
MULTIFUNCTION SWITCH : Diagnosis Procedure	106			
BOSE AMP.	107	RGB (R: RED) SIGNAL CIRCUIT (VIDEO DISTRIBUTOR TO REAR DISPLAY UNIT)	121	J
BOSE AMP. : Diagnosis Procedure	107	Description	121	
		Diagnosis Procedure	121	
WOOFER	108			K
WOOFER : Diagnosis Procedure	108	RGB (G: GREEN) SIGNAL CIRCUIT (VIDEO DISTRIBUTOR TO REAR DISPLAY UNIT)	122	
		Description	122	
IPOD ADAPTER	108	Diagnosis Procedure	122	L
iPod ADAPTER : Diagnosis Procedure	108			
SATELLITE RADIO TUNER	109	RGB (B: BLUE) SIGNAL CIRCUIT (VIDEO DISTRIBUTOR TO REAR DISPLAY UNIT)	123	M
SATELLITE RADIO TUNER : Diagnosis Procedure	109	Description	123	
		Diagnosis Procedure	123	
TEL ADAPTER UNIT	109			
TEL ADAPTER UNIT : Diagnosis Procedure	109	COMPOSITE SYNCHRONIZING SIGNAL CIRCUIT (VIDEO DISTRIBUTOR TO REAR DISPLAY UNIT)	124	O
		Description	124	
		Diagnosis Procedure	124	
RGB (R: RED) SIGNAL CIRCUIT (AV CONTROL UNIT TO FRONT DISPLAY UNIT)	111			P
Description	111	RGB AREA (YS) SIGNAL CIRCUIT (VIDEO DISTRIBUTOR TO REAR DISPLAY UNIT)	125	
Diagnosis Procedure	111	Description	125	
		Diagnosis Procedure	125	
RGB (G: GREEN) SIGNAL CIRCUIT (AV CONTROL UNIT TO FRONT DISPLAY UNIT). 112				
Description	112	VP SIGNAL CIRCUIT (REAR DISPLAY UNIT TO VIDEO DISTRIBUTOR)	126	
Diagnosis Procedure	112	Description	126	
RGB (B: BLUE) SIGNAL CIRCUIT (AV CONTROL UNIT TO FRONT DISPLAY UNIT)	113			
Description	113			
Diagnosis Procedure	113			
RGB SYNCHRONIZING SIGNAL CIRCUIT	114			
Description	114			
Diagnosis Procedure	114			

Diagnosis Procedure	126	STEERING SWITCH SIGNAL B CIRCUIT	143
HP SIGNAL CIRCUIT (REAR DISPLAY UNIT TO VIDEO DISTRIBUTOR)	127	Description	143
Description	127	Diagnosis Procedure	143
Diagnosis Procedure	127	Component Inspection	144
AUX IMAGE SIGNAL CIRCUIT	128	STEERING SWITCH SIGNAL GND CIRCUIT..	145
WITHOUT DVD ENTERTAINMENT SYSTEM	128	Description	145
WITHOUT DVD ENTERTAINMENT SYSTEM :		Diagnosis Procedure	145
Description	128	Component Inspection	146
WITHOUT DVD ENTERTAINMENT SYSTEM :		ECU DIAGNOSIS	147
Diagnosis Procedure	128	AV CONTROL UNIT	147
WITH DVD ENTERTAINMENT SYSTEM	129	Reference Values	147
WITH DVD ENTERTAINMENT SYSTEM : De-		Wiring Diagram - BOSE AUDIO WITHOUT NAVI-	
scription	129	GATION WITHOUT DVD ENTERTAINMENT	
WITH DVD ENTERTAINMENT SYSTEM : Diag-		SYSTEM -	154
nosis Procedure	129	Wiring Diagram - BOSE AUDIO WITHOUT NAVI-	
DVD IMAGE SIGNAL CIRCUIT	131	GATION WITH DVD ENTERTAINMENT SYS-	
Description	131	TEM -	171
Diagnosis Procedure	131	DTC Index	192
DISK EJECT SIGNAL CIRCUIT	132	FRONT DISPLAY UNIT	194
Description	132	Reference Values	194
Diagnosis Procedure	132	Wiring Diagram - BOSE AUDIO WITHOUT NAVI-	
MICROPHONE SIGNAL CIRCUIT	133	GATION WITHOUT DVD ENTERTAINMENT	
Description	133	SYSTEM -	196
Diagnosis Procedure	133	Wiring Diagram - BOSE AUDIO WITHOUT NAVI-	
CONTROL SIGNAL CIRCUIT	135	GATION WITH DVD ENTERTAINMENT SYS-	
Description	135	TEM -	213
Diagnosis Procedure	135	BOSE AMP.	235
CAMERA IMAGE SIGNAL CIRCUIT (REAR VIEW CAMERA TO CAMERA CONTROL UNIT)	136	Reference Values	235
Description	136	Wiring Diagram - BOSE AUDIO WITHOUT NAVI-	
Diagnosis Procedure	136	GATION WITHOUT DVD ENTERTAINMENT	
CAMERA ON SIGNAL CIRCUIT	137	SYSTEM -	237
Description	137	Wiring Diagram - BOSE AUDIO WITHOUT NAVI-	
Diagnosis Procedure	137	GATION WITH DVD ENTERTAINMENT SYS-	
CAMERA IMAGE SIGNAL CIRCUIT (CAMERA CONTROL UNIT TO AV CONTROL UNIT)	138	TEM -	254
Description	138	REAR DISPLAY UNIT	276
Diagnosis Procedure	138	Reference Values	276
STEERING ANGLE SENSOR SIGNAL CIR-		Wiring Diagram - BOSE AUDIO WITHOUT NAVI-	
CUIT	139	GATION WITH DVD ENTERTAINMENT SYS-	
Description	139	TEM -	278
Diagnosis Procedure	139	VIDEO DISTRIBUTOR	300
STEERING SWITCH SIGNAL A CIRCUIT	141	Reference Values	300
Description	141	Wiring Diagram - BOSE AUDIO WITHOUT NAVI-	
Diagnosis Procedure	141	GATION WITH DVD ENTERTAINMENT SYS-	
Component Inspection	142	TEM -	303
		DVD PLAYER	325
		Reference Values	325
		Wiring Diagram - BOSE AUDIO WITHOUT NAVI-	
		GATION WITH DVD ENTERTAINMENT SYS-	
		TEM -	326
		SATELLITE RADIO TUNER	348
		Reference Values	348

Wiring Diagram - BOSE AUDIO WITHOUT NAVIGATION WITHOUT DVD ENTERTAINMENT SYSTEM -	349	FRONT DISPLAY UNIT	523	
Wiring Diagram - BOSE AUDIO WITHOUT NAVIGATION WITH DVD ENTERTAINMENT SYSTEM -	366	Exploded View	523	A
iPod ADAPTER	388	Removal and Installation	523	
Reference Values	388	REAR DISPLAY UNIT	524	B
Wiring Diagram - BOSE AUDIO WITHOUT NAVIGATION WITHOUT DVD ENTERTAINMENT SYSTEM -	389	Exploded View	524	
Wiring Diagram - BOSE AUDIO WITHOUT NAVIGATION WITH DVD ENTERTAINMENT SYSTEM -	406	Removal and Installation	524	
TEL ADAPTER UNIT	428	VIDEO DISTRIBUTOR	525	C
Reference Values	428	Exploded View	525	
Wiring Diagram - BOSE AUDIO WITHOUT NAVIGATION WITHOUT DVD ENTERTAINMENT SYSTEM -	429	Removal and Installation	525	
Wiring Diagram - BOSE AUDIO WITHOUT NAVIGATION WITH DVD ENTERTAINMENT SYSTEM -	446	DVD PLAYER	526	D
CAMERA CONTROL UNIT	468	Exploded View	526	
Reference Values	468	Removal and Installation	526	E
Wiring Diagram - BOSE AUDIO WITHOUT NAVIGATION WITHOUT DVD ENTERTAINMENT SYSTEM -	470	FRONT DOOR SPEAKER	527	
Wiring Diagram - BOSE AUDIO WITHOUT NAVIGATION WITH DVD ENTERTAINMENT SYSTEM -	487	Exploded View	527	
SYMPTOM DIAGNOSIS	509	Removal and Installation	527	F
MULTI AV SYSTEM SYMPTOMS	509	REAR DOOR SPEAKER	528	
Symptom Table	509	Exploded View	528	
NORMAL OPERATING CONDITION	517	Removal and Installation	528	G
Description	517	FRONT SQUAWKER	529	
PRECAUTION	519	Exploded View	529	
PRECAUTIONS	519	Removal and Installation	529	H
Precaution for Supplemental Restraint System (SRS) "AIR BAG" and "SEAT BELT PRE-TENSIONER"	519	REAR SPEAKER	530	
Precaution for Trouble Diagnosis	519	Exploded View	530	I
Precaution for Harness Repair	519	Removal and Installation	530	
PREPARATION	521	CENTER SPEAKER	531	J
PREPARATION	521	Exploded View	531	
Commercial Service Tools	521	Removal and Installation	531	
ON-VEHICLE REPAIR	522	WOOFER	532	K
AV CONTROL UNIT	522	Exploded View	532	
Exploded View	522	Removal and Installation	532	
Removal and Installation	522	BOSE AMP.	533	L
		Exploded View	533	
		Removal and Installation	533	
		MULTIFUNCTION SWITCH	534	M
		Exploded View	534	
		Removal and Installation	534	
		PRESET SWITCH	535	AV
		Exploded View	535	
		Removal and Installation	535	O
		STEERING SWITCH	536	
		Exploded View	536	
		Removal and Installation	536	P
		iPod ADAPTER	537	
		Exploded View	537	
		Removal and Installation	537	
		iPod CONNECTOR	538	
		Exploded View	538	

Removal and Installation	538	ADDITIONAL SERVICE WHEN REPLACING CONTROL UNIT : Description	553
AUXILIARY INPUT JACKS	539	ADDITIONAL SERVICE WHEN REPLACING CONTROL UNIT : Special Repair Requirement ..	553
Exploded View	539	REAR VIEW MONITOR POSSIBLE ROUTE LINE CENTER POSITION ADJUSTMENT	553
Removal and Installation	539	REAR VIEW MONITOR POSSIBLE ROUTE LINE CENTER POSITION ADJUSTMENT : Description ..	553
MICROPHONE	540	REAR VIEW MONITOR POSSIBLE ROUTE LINE CENTER POSITION ADJUSTMENT : Special Re- pair Requirement	553
Exploded View	540	FUNCTION DIAGNOSIS	554
Removal and Installation	540	MULTI AV SYSTEM	554
CAMERA CONTROL UNIT	541	System Diagram	554
Exploded View	541	System Description	555
Removal and Installation	541	Component Parts Location	557
Adjustment	541	Component Description	558
REAR VIEW CAMERA	542	NAVIGATION SYSTEM	560
Exploded View	542	System Diagram	560
Removal and Installation	542	System Description	560
Adjustment	542	Component Parts Location	563
STEERING ANGLE SENSOR	544	Component Description	564
Exploded View	544	REAR VIEW MONITOR SYSTEM	565
Removal and Installation	544	System Diagram	565
ROOF ANTENNA	545	System Description	565
Exploded View	545	Component Parts Location	566
Removal and Installation	545	Component Description	567
SATELLITE RADIO TUNER	546	AUDIO SYSTEM	568
Exploded View	546	System Diagram	568
Removal and Installation	546	System Description	568
TEL ADAPTER UNIT	547	Component Parts Location	570
Exploded View	547	Component Description	571
Removal and Installation	547	HANDS-FREE PHONE SYSTEM	572
ANTENNA FEEDER (RADIO)	548	System Diagram	572
Harness Layout	548	System Description	572
ANTENNA FEEDER (SATELLITE RADIO)	549	Component Parts Location	573
Harness Layout	549	Component Description	574
ANTENNA FEEDER (TEL)	550	DIAGNOSIS SYSTEM (AV CONTROL UNIT)..	575
Harness Layout	550	Diagnosis Description	575
BOSE AUDIO WITH NAVIGATION		CONSULT-III Function (MULTI AV)	589
BASIC INSPECTION	551	COMPONENT DIAGNOSIS	593
DIAGNOSIS AND REPAIR WORK FLOW	551	U1000 CAN COMM CIRCUIT	593
Work Flow	551	Description	593
INSPECTION AND ADJUSTMENT	553	DTC Logic	593
ADDITIONAL SERVICE WHEN REMOVING BAT- TERY NEGATIVE TERMINAL	553	Diagnosis Procedure	593
ADDITIONAL SERVICE WHEN REMOVING BATTERY NEGATIVE TERMINAL : Description ..	553	U1010 CONTROL UNIT (CAN)	594
ADDITIONAL SERVICE WHEN REMOVING BATTERY NEGATIVE TERMINAL : Special Re- pair Requirement	553	Description	594
ADDITIONAL SERVICE WHEN REPLACING CONTROL UNIT	553	DTC Logic	594
		Diagnosis Procedure	594

U1310 AV CONTROL UNIT	595	U1205 GPS	610	A
Description	595	Description	610	
DTC Logic	595	DTC Logic	610	
U1200 AV CONTROL UNIT	596	Diagnosis Procedure	610	B
Description	596	U1206 GPS	611	
DTC Logic	596	Description	611	
U1201 AV CONTROL UNIT	597	DTC Logic	611	C
Description	597	Diagnosis Procedure	611	
DTC Logic	597	U1207 GPS	612	D
U1216 AV CONTROL UNIT	598	Description	612	
Description	598	DTC Logic	612	
DTC Logic	598	Diagnosis Procedure	612	E
U1217 AV CONTROL UNIT	599	U1243 DISPLAY UNIT	613	
Description	599	Description	613	
DTC Logic	599	DTC Logic	613	F
U1218 AV CONTROL UNIT	600	Diagnosis Procedure	613	
Description	600	U1244 GPS ANTENNA	615	G
DTC Logic	600	Description	615	
U1219 AV CONTROL UNIT	601	DTC Logic	615	
Description	601	Diagnosis Procedure	615	H
DTC Logic	601	U1250 CAMERA CONTROL UNIT	616	
U1220 AV CONTROL UNIT	602	Description	616	I
Description	602	DTC Logic	616	
DTC Logic	602	Diagnosis Procedure	616	J
U121A AV CONTROL UNIT	603	U1258 SATELLITE RADIO ANTENNA	617	
Description	603	Description	617	
DTC Logic	603	DTC Logic	617	K
U121B AV CONTROL UNIT	604	Diagnosis Procedure	617	
Description	604	U1300 AV COMM CIRCUIT	618	
DTC Logic	604	Description	618	L
U121C AV CONTROL UNIT	605	POWER SUPPLY AND GROUND CIRCUIT ..	619	
Description	605	AV CONTROL UNIT	619	
DTC Logic	605	AV CONTROL UNIT : Diagnosis Procedure	619	M
U121D AV CONTROL UNIT	606	FRONT DISPLAY UNIT	619	
Description	606	FRONT DISPLAY UNIT : Diagnosis Procedure ..	619	
DTC Logic	606	MULTIFUNCTION SWITCH	620	AV
U121E AV CONTROL UNIT	607	MULTIFUNCTION SWITCH : Diagnosis Proce-	620	
Description	607	dure	620	
DTC Logic	607	CAMERA CONTROL UNIT	621	O
U121F AV CONTROL UNIT	608	CAMERA CONTROL UNIT : Diagnosis Procedure	..621	
Description	608			
DTC Logic	608	BOSE AMP.	621	P
Diagnosis Procedure	608	BOSE AMP. : Diagnosis Procedure	621	
U1204 GPS	609	WOOFER	622	
Description	609	WOOFER : Diagnosis Procedure	622	
DTC Logic	609	IPOD ADAPTER	622	
Diagnosis Procedure	609	iPod ADAPTER : Diagnosis Procedure	623	

RGB (R: RED) SIGNAL CIRCUIT (AV CONTROL UNIT TO FRONT DISPLAY UNIT)	624	STEERING ANGLE SENSOR SIGNAL CIRCUIT	638
Description	624	Description	638
Diagnosis Procedure	624	Diagnosis Procedure	638
RGB (G: GREEN) SIGNAL CIRCUIT (AV CONTROL UNIT TO FRONT DISPLAY UNIT)	625	STEERING SWITCH SIGNAL A CIRCUIT	640
Description	625	Description	640
Diagnosis Procedure	625	Diagnosis Procedure	640
RGB (B: BLUE) SIGNAL CIRCUIT (AV CONTROL UNIT TO FRONT DISPLAY UNIT)	626	Component Inspection	641
Description	626	STEERING SWITCH SIGNAL B CIRCUIT	642
Diagnosis Procedure	626	Description	642
RGB SYNCHRONIZING SIGNAL CIRCUIT ...	627	Diagnosis Procedure	642
Description	627	Component Inspection	643
Diagnosis Procedure	627	STEERING SWITCH SIGNAL GND CIRCUIT..	644
RGB AREA (YS) SIGNAL CIRCUIT (AV CONTROL UNIT TO FRONT DISPLAY UNIT)	628	Description	644
Description	628	Diagnosis Procedure	644
Diagnosis Procedure	628	Component Inspection	645
HP SIGNAL CIRCUIT (FRONT DISPLAY UNIT TO AV CONTROL UNIT)	629	ECU DIAGNOSIS	646
Description	629	AV CONTROL UNIT	646
Diagnosis Procedure	629	Reference Values	646
VP SIGNAL CIRCUIT (FRONT DISPLAY UNIT TO AV CONTROL UNIT)	630	Wiring Diagram - BOSE AUDIO WITH NAVIGATION SYSTEM -	652
Description	630	Fail-Safe	668
Diagnosis Procedure	630	DTC Index	670
AUX IMAGE SIGNAL CIRCUIT	631	FRONT DISPLAY UNIT	672
Description	631	Reference Values	672
Diagnosis Procedure	631	Wiring Diagram - BOSE AUDIO WITH NAVIGATION SYSTEM -	674
DISK EJECT SIGNAL CIRCUIT	632	BOSE AMP.	692
Description	632	Reference Values	692
Diagnosis Procedure	632	Wiring Diagram - BOSE AUDIO WITH NAVIGATION SYSTEM -	694
MICROPHONE SIGNAL CIRCUIT	633	iPod ADAPTER	712
Description	633	Reference Values	712
Diagnosis Procedure	633	Wiring Diagram - BOSE AUDIO WITH NAVIGATION SYSTEM -	714
CAMERA IMAGE SIGNAL CIRCUIT (REAR VIEW CAMERA TO CAMERA CONTROL UNIT)	635	CAMERA CONTROL UNIT	731
Description	635	Reference Values	731
Diagnosis Procedure	635	Wiring Diagram - BOSE AUDIO WITH NAVIGATION SYSTEM -	733
CAMERA ON SIGNAL CIRCUIT	636	SYMPTOM DIAGNOSIS	751
Description	636	MULTI AV SYSTEM SYMPTOMS	751
Diagnosis Procedure	636	Symptom Table	751
CAMERA IMAGE SIGNAL CIRCUIT (CAMERA CONTROL UNIT TO FRONT DISPLAY UNIT)	637	NORMAL OPERATING CONDITION	756
Description	637	Description	756
Diagnosis Procedure	637	PRECAUTION	761
		PRECAUTIONS	761

Precaution for Supplemental Restraint System (SRS) "AIR BAG" and "SEAT BELT PRE-TENSIONER"	761	Exploded View	774	
Precaution for Trouble Diagnosis	761	Removal and Installation	774	A
Precaution for Harness Repair	761			
PREPARATION	763	STEERING SWITCH	775	
PREPARATION	763	Exploded View	775	B
Commercial Service Tools	763	Removal and Installation	775	
ON-VEHICLE REPAIR	764	iPod ADAPTER	776	
AV CONTROL UNIT	764	Exploded View	776	C
Exploded View	764	Removal and Installation	776	
Removal and Installation	764	iPod CONNECTOR	777	
FRONT DISPLAY UNIT	765	Exploded View	777	D
Exploded View	765	Removal and Installation	777	
Removal and Installation	765	AUXILIARY INPUT JACKS	778	
FRONT DOOR SPEAKER	766	Exploded View	778	E
Exploded View	766	Removal and Installation	778	
Removal and Installation	766	MICROPHONE	779	
REAR DOOR SPEAKER	767	Exploded View	779	F
Exploded View	767	Removal and Installation	779	
Removal and Installation	767	GPS ANTENNA	780	
FRONT SQUAWKER	768	Exploded View	780	G
Exploded View	768	Harness Layout	780	
Removal and Installation	768	Removal and Installation	781	H
REAR SPEAKER	769	CAMERA CONTROL UNIT	782	
Exploded View	769	Exploded View	782	I
Removal and Installation	769	Removal and Installation	782	
CENTER SPEAKER	770	Adjustment	782	
Exploded View	770	REAR VIEW CAMERA	783	
Removal and Installation	770	Exploded View	783	J
WOOFER	771	Removal and Installation	783	
Exploded View	771	Adjustment	783	K
Removal and Installation	771	STEERING ANGLE SENSOR	785	
BOSE AMP.	772	Exploded View	785	L
Exploded View	772	Removal and Installation	785	
Removal and Installation	772	ROOF ANTENNA	786	
MULTIFUNCTION SWITCH	773	Exploded View	786	M
Exploded View	773	Removal and Installation	786	
Removal and Installation	773	ANTENNA FEEDER (RADIO)	787	
PRESET SWITCH	774	Harness Layout	787	AV
		ANTENNA FEEDER (SATELLITE RADIO)	788	
		Harness Layout	788	O
		ANTENNA FEEDER (GPS)	789	
		Harness Layout	789	P

BASIC INSPECTION

DIAGNOSIS AND REPAIR WORKFLOW

Work Flow

INFOID:000000003465354

OVERALL SEQUENCE

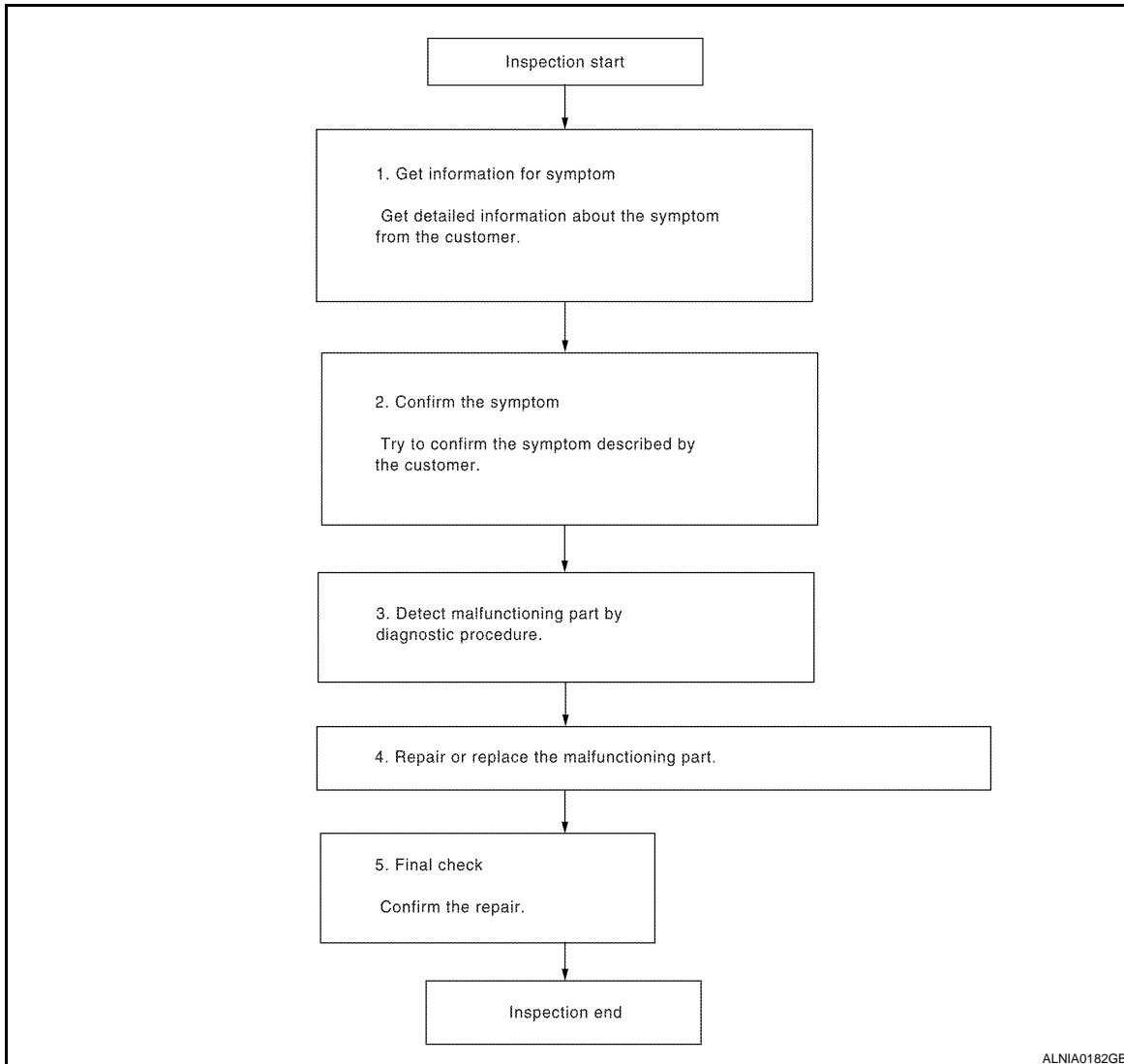

DETAILED FLOW

1.GET INFORMATION FOR SYMPTOM

Get detailed information from the customer about the symptom (the condition and the environment when the incident/malfunction occurred).

>> GO TO 2

2.CONFIRM THE SYMPTOM

Try to confirm the symptom described by the customer. Verify the relation between the symptom and the condition when the symptom is detected.

>> GO TO 3

3.DETECT MALFUNCTIONING PART BY DIAGNOSTIC PROCEDURE

Inspect according to Diagnostic Procedure of the system.

DIAGNOSIS AND REPAIR WORKFLOW

< BASIC INSPECTION >

[BASE AUDIO]

Is a malfunctioning part detected?

YES >> GO TO 4

NO >> GO TO 2

4.REPAIR OR REPLACE THE MALFUNCTIONING PART

1. Repair or replace the malfunctioning part.
2. Reconnect parts or connectors disconnected during Diagnostic Procedure.

>> GO TO 5

5.FINAL CHECK

Refer to confirmed symptom in step 2, and check that the symptom is not detected.

Has the symptom been repaired?

YES >> INSPECTION END.

NO >> GO TO 2

A

B

C

D

E

F

G

H

I

J

K

L

M

AV

O

P

FUNCTION DIAGNOSIS

AUDIO SYSTEM

System Diagram

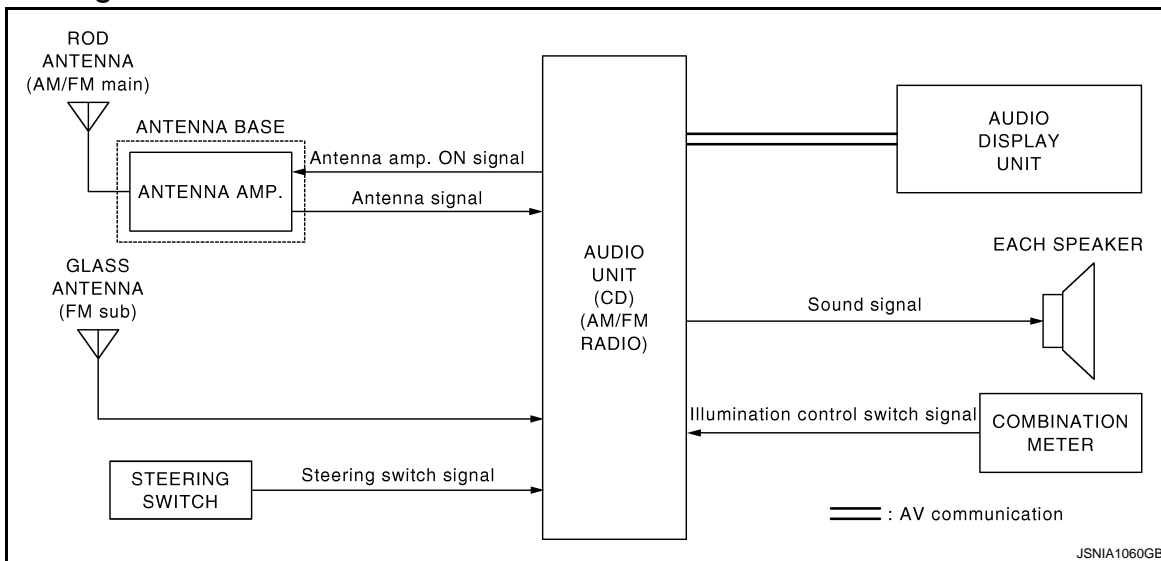

NOTE:

An antenna base integrated with radio antenna amp. is adopted.

System Description

INFOID:000000003465355

AUDIO SYSTEM

The audio system consists of the following components.

- Audio unit
- Rod antenna (AM/FM main)
- Glass antenna (FM sub)
- Steering switch
- Front door speakers
- Rear door speakers
- Front squawker
- Audio display unit

AM/FM Radio Mode

- AM/FM radio tuner is integrated into audio unit.
- When AM/FM radio waves are received by rod antenna, the radio waves are amplified by an antenna amp. to input them to audio unit. Sound signals are output to each speaker for the audio unit. The FM sub antenna is installed on the back door window glass and the audio unit is received.

CD Mode

- The audio unit has CD function.
- The audio unit outputs sound signals to each speaker when CD is inserted into the audio unit.

AUDIO SYSTEM

< FUNCTION DIAGNOSIS >

[BASE AUDIO]

Component Parts Location

INFOID:000000003415158

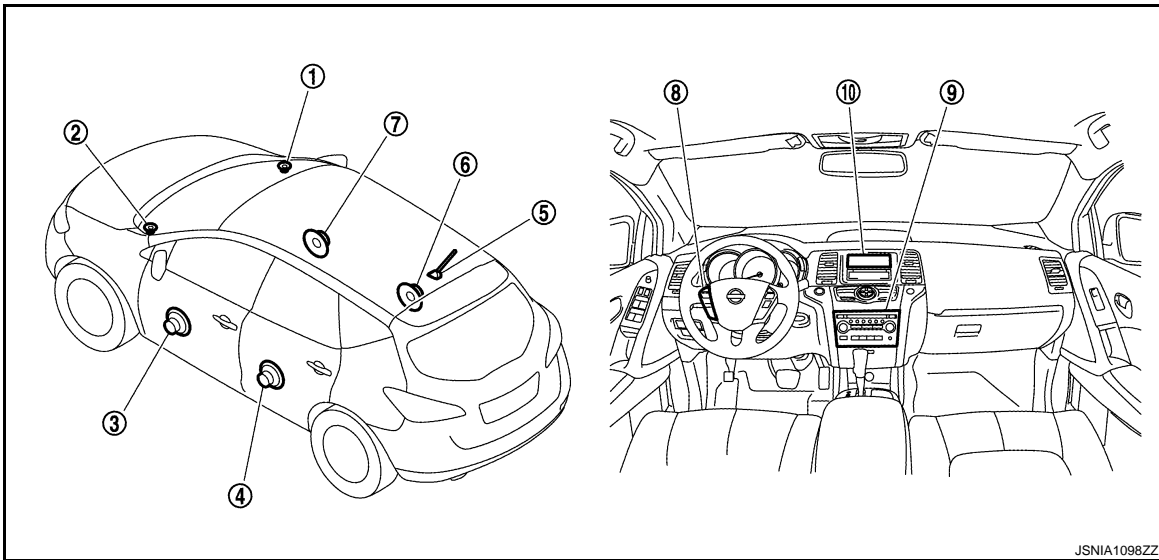

- | | | |
|--------------------------|--------------------------------|--------------------------|
| 1. Front squawker RH | 2. Front squawker LH | 3. Front door speaker LH |
| 4. Rear door speaker LH | 5. Antenna base (antenna amp.) | 6. Rear door speaker RH |
| 7. Front door speaker RH | 8. Steering switch | 9. Audio unit |
| 10. Audio display unit | | |

Component Description

INFOID:000000003415159

Part name	Description
AUDIO UNIT	<ul style="list-style-type: none"> Has radio function and CD playing function. Sound signals are output to each speaker.
AUDIO DISPLAY UNIT	Display images are controlled by AV communication from audio unit.
FRONT DOOR SPEAKER	<ul style="list-style-type: none"> Outputs sound signals from audio unit. Outputs sound (mid and low range).
REAR DOOR SPEAKER	<ul style="list-style-type: none"> Outputs sound signals from audio unit. Outputs sound (mid and low range).
FRONT SQUAWKER	<ul style="list-style-type: none"> Outputs sound signals from audio unit. Outputs sound (high and mid range).
STEERING SWITCH	Steering switch signals (operation signals) are output to audio unit.
ANTENNA BASE	<p>An antenna base integrated with radio antenna amp. is adopted. ANTENNA AMP.</p> <ul style="list-style-type: none"> Radio waves received by rod antenna are amplified and transmitted to audio unit. Power (antenna amp. ON signal) is supplied from audio unit.

DIAGNOSIS SYSTEM (AUDIO UNIT)

Diagnosis Description

INFOID:000000003465356

Self-diagnosis mode can perform the following items.

- Versions display
- Channel check diagnosis
- Key check diagnosis
- AV communication diagnosis

VERSIONS DISPLAY FUNCTION

1. Turn ignition switch ON.
2. Turn the audio unit off.
3. While pressing "1" button, turn volume control dial clockwise or counterclockwise for 30 clicks or more.

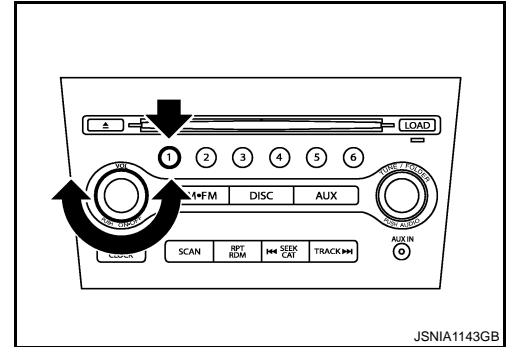

4. Diagnosis default screen of audio display unit is displayed.

NOTE:

Diagnosis default screen = All icons and segments of the audio display unit are turned on.

5. Pressing the AUDIO switch briefly displays the version display mode. Pressing the AUDIO switch briefly switches to each version display. Pressing and holding the AUDIO switch when displaying each software version returns to the diagnosis default screen.

Version display item

	Mode	Description
Versions display	Software V#####	Audio unit software version is displayed.
	Hardware V#####	Audio unit hardware version is displayed.
	CD Mech V#####	Audio unit CD mechanism version is displayed.
	EEPROM V#####	Audio unit EEPROM version is displayed.
	Disp SW V#####	Display unit software version is displayed.
	Disp HW V#####	Display unit hardware version is displayed.
	SDARS V#####	Audio unit SDARS version is displayed. NOTE: "VFFFFFFF" is displayed when SRARS is not available.

6. Self-diagnosis mode is canceled when the ignition switch is turned OFF.

CHANNEL CHECK DIAGNOSIS FUNCTION

1. Turn ignition switch ON.
2. Turn the audio unit off.

DIAGNOSIS SYSTEM (AUDIO UNIT)

[BASE AUDIO]

< FUNCTION DIAGNOSIS >

- While pressing the “1” button, turn the volume control dial clockwise or counterclockwise for 30 clicks or more.

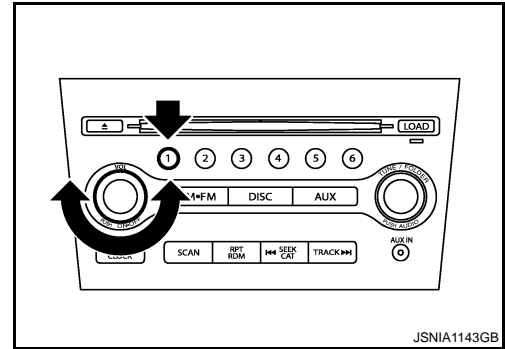

- The diagnosis default screen of audio display unit is displayed.

NOTE:
Diagnosis default screen = All icons and segments of the audio display unit are turned on.
- Turning the TUNE/FOLDER dial clockwise displays the channel check mode. Pressing and holding the AUDIO switch during each channel check or waiting approximately 1 second after finishing all channel checks returns to the diagnosis default screen.

Channel check item

	Mode	Description
Channel check	Channel Check Front Left	Connection of a speaker can be confirmed by test tone.
	Channel Check Front Right	
	Channel Check Rear Right	
	Channel Check Rear Left	

- Self-diagnosis mode is canceled when the ignition switch is turned OFF.

KEY CHECK DIAGNOSIS FUNCTION

- Turn ignition switch ON.
- Turn the audio unit off.
- While pressing the “1” button, turn the volume control dial clockwise or counterclockwise for 30 clicks or more.

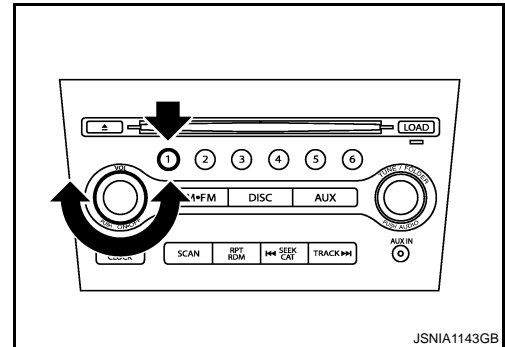

- The diagnosis default screen of audio display unit is displayed.

NOTE:
Diagnosis default screen = All icons and segments of the audio display unit are turned on.
- Turning the TUNE/FOLDER dial counterclockwise displays the key check mode, and the pressed switch name is shown. Pressing and holding the AUDIO switch during the key check returns to the diagnosis default screen.

DIAGNOSIS SYSTEM (AUDIO UNIT)

< FUNCTION DIAGNOSIS >

[BASE AUDIO]

Key check item (audio unit)

Mode	Display item	Switch name
Key check	1	Preset button "1" switch
	2	Preset button "2" switch
	3	Preset button "3" switch
	4	Preset button "4" switch
	5	Preset button "5" switch
	6	Preset button "6" switch
	POWER	"ON-OFF" switch
	VOLUME up	"VOL up" switch
	VOLUME down	"VOL down" switch
	AM-FM	"AM-FM" switch
	DISC	"DISC" switch
	AUX	"AUX" switch
	AUDIO	"AUDIO" switch
	TUNE/FOLDER up	"TUNE/FOLDER up" switch
	TUNE/FOLDER down	"TUNE/FOLDER up" switch
	DISP CLOCK	"DISP CLOCK" switch
	SCAN	"SCAN" switch
	RPT/RDM	"RPT RDM" switch
	SEEK/TRACK up	"SEEK CAT" switch
	SEEK/TRACK down	"TRACK" switch
LOAD	"LOAD" switch	
EJECT	"EJECT" switch	

Key check item (steering switch)

Mode	Display item	Switch name
Key check	STR SOURCE	"SOURCE" switch
	STR VOL UP	"VOL up" switch
	STR VOL DOWN	"VOL down" switch
	STR UP	"MENU up" switch
	STR DOWN	"MENU down" switch

6. Self-diagnosis mode is canceled when the ignition switch is turned OFF.

AV COMMUNICATION DIAGNOSIS FUNCTION

1. Turn ignition switch ON.
2. Turn the audio unit off.
3. While pressing the "6" button, turn the volume control dial clockwise or counterclockwise for 30 clicks or more.

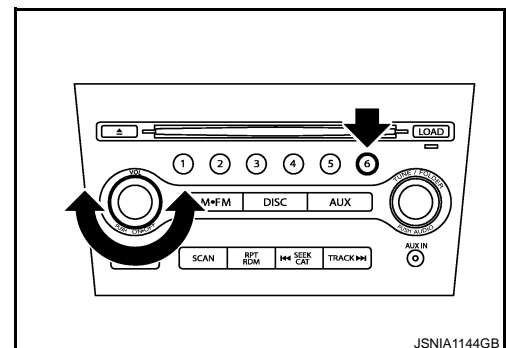

4. Returns to diagnosis default screen and displays "AV DIAGNOSIS".

DIAGNOSIS SYSTEM (AUDIO UNIT)

< FUNCTION DIAGNOSIS >

[BASE AUDIO]

5. Pressing the AUDIO switch briefly displays the AV communication diagnosis mode. Pressing the AUDIO switch briefly again switches to each AV communication display.

AV communication diagnosis item

Display item			Description
AV communication item	Current	Past	
TRANSMIT	OK / UN	OK / 0 -39	The communication condition and error counter from the audio unit to the audio display unit are displayed.
DISP	OK / UN	OK / 0 -39	The communication condition and error counter from the audio display unit to the audio unit.
DISP MPDT	OK / UN	OK / 0 -39	
NO HISTORY BTHF	—	—	Not used.
AV TROUBLE DEL	—	—	The error record can be deleted.

6. Pressing the SEEK TRACK up switch displays the confirmation screen of “delete error record”. Press the SEEK TRACK down switch if returning from RECORD DEL YES? to RECORD DEL NO? The item is automatically determined approximately 6 seconds after it is displayed. Then the display returns to AV TROUBLE DEL display item.

Display item	Description
RECORD DEL NO?	Does not delete error record.
RECORD DEL YES?	Deletes error record.

7. Self-diagnosis mode is canceled when the ignition switch is turned OFF.

A
B
C
D
E
F
G
H
I
J
K
L
M

AV

O
P

POWER SUPPLY AND GROUND CIRCUIT

< COMPONENT DIAGNOSIS >

[BASE AUDIO]

COMPONENT DIAGNOSIS

POWER SUPPLY AND GROUND CIRCUIT AUDIO UNIT

AUDIO UNIT : Diagnosis Procedure

INFOID:000000003468501

1.CHECK FUSE

Check for blown fuses.

Power source	Fuse No.
Battery	35
Ignition switch ACC or ON	19

Is the inspection result normal?

YES >> GO TO 2.

NO >> Be sure to eliminate the cause of malfunction before installing new fuse.

2.CHECK POWER SUPPLY CIRCUIT

Check voltage between audio unit harness connectors and ground.

Signal name	Connector No.	Terminal No.	Ignition switch position	Value (Approx.)
Battery power supply	M46	19	OFF	Battery voltage
ACC power supply		7	ACC	

Is the inspection result normal?

YES >> INSPECTION END

NO >> Check harness between audio unit and fuse.

STEERING SWITCH SIGNAL A CIRCUIT

< COMPONENT DIAGNOSIS >

[BASE AUDIO]

STEERING SWITCH SIGNAL A CIRCUIT

Description

INFOID:000000003468488

Transmits the steering switch signal to audio unit.

Diagnosis Procedure

INFOID:000000003468489

1.CHECK STEERING SWITCH SIGNAL A CIRCUIT

1. Disconnect audio unit connector and spiral cable connector.
2. Check continuity between audio unit harness connector and spiral cable harness connector.

Audio unit		Spiral cable		Continuity
Connector	Terminal	Connector	Terminal	
M46	6	M33	24	Existed

3. Check continuity between audio unit harness connector and ground.

Audio unit		—	Continuity
Connector	Terminal		
M46	6	Ground	Not existed

Is the inspection result normal?

- YES >> GO TO 2.
NO >> Repair harness or connector.

2.CHECK SPIRAL CABLE

Check spiral cable.

Is the inspection result normal?

- YES >> GO TO 3.
NO >> Replace spiral cable.

3.CHECK AUDIO UNIT VOLTAGE

1. Connect audio unit connector and spiral cable connector.
2. Turn ignition switch ON.
3. Check voltage between audio unit harness connector terminals.

(+)		(-)		Voltage
Audio unit				
Connector	Terminal	Connector	Terminal	
M46	6	M46	15	Approx 5.0 V

Is the inspection result normal?

- YES >> GO TO 4.
NO >> Replace audio unit.

4.CHECK STEERING SWITCH

1. Turn ignition switch OFF.
2. Check steering switch. Refer to [AV-20, "Component Inspection"](#).

Is the inspection result normal?

- YES >> INSPECTION END
NO >> Replace steering switch.

A
B
C
D
E
F
G
H
I
J
K
L
M
AV
O
P

STEERING SWITCH SIGNAL A CIRCUIT

< COMPONENT DIAGNOSIS >

[BASE AUDIO]

Component Inspection

INFOID:000000003468490

Measure the resistance between the steering switch connector terminals.

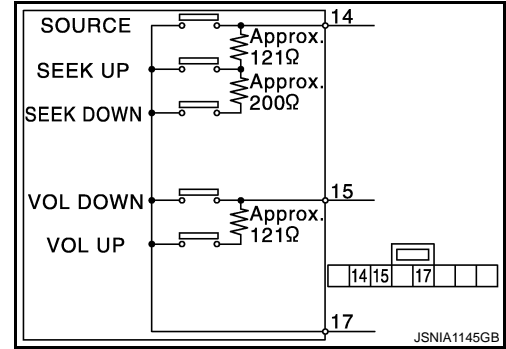

Standard

Steering switch				Condition	Resistance Ω
Con- nector	Termi- nals	Con- nector	Termi- nal		
M303	14	M303	17	SEEK DOWN switch ON	315 – 327
				SEEK UP switch ON	119 – 123
				SOURCE switch ON	0
	15			VOL UP switch ON	119 – 123
				VOL DOWN switch ON	0

STEERING SWITCH SIGNAL B CIRCUIT

< COMPONENT DIAGNOSIS >

[BASE AUDIO]

STEERING SWITCH SIGNAL B CIRCUIT

Description

INFOID:000000003468491

Transmits the steering switch signal to audio unit.

Diagnosis Procedure

INFOID:000000003468492

1.CHECK STEERING SWITCH SIGNAL B CIRCUIT

1. Disconnect audio unit connector and spiral cable connector.
2. Check continuity between audio unit harness connector and spiral cable harness connector.

Audio unit		Spiral cable		Continuity
Connector	Terminal	Connector	Terminal	
M46	16	M33	31	Existed

3. Check continuity between audio unit harness connector and ground.

Audio unit		—	Continuity
Connector	Terminal		
M46	16	Ground	Not existed

Is the inspection result normal?

- YES >> GO TO 2.
NO >> Repair harness or connector.

2.CHECK SPIRAL CABLE

Check spiral cable.

Is the inspection result normal?

- YES >> GO TO 3.
NO >> Replace spiral cable.

3.CHECK AUDIO UNIT VOLTAGE

1. Connect audio unit connector and spiral cable connector.
2. Turn ignition switch ON.
3. Check voltage between audio unit harness connector terminals.

(+)		(-)		Voltage
Audio unit				
Connector	Terminal	Connector	Terminal	
M46	16	M46	15	Approx 5.0 V

Is the inspection result normal?

- YES >> GO TO 4.
NO >> Replace audio unit.

4.CHECK STEERING SWITCH

1. Turn ignition switch OFF.
2. Check steering switch. Refer to [AV-22, "Component Inspection"](#).

Is the inspection result normal?

- YES >> INSPECTION END
NO >> Replace steering switch.

A
B
C
D
E
F
G
H
I
J
K
L
M
AV
O
P

STEERING SWITCH SIGNAL B CIRCUIT

< COMPONENT DIAGNOSIS >

[BASE AUDIO]

INFOID:000000003470180

Component Inspection

Measure the resistance between the steering switch connector terminals.

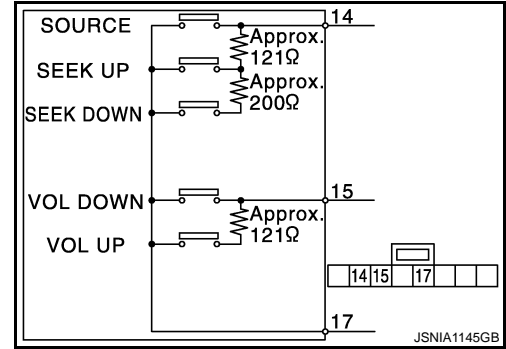

Standard

Steering switch				Condition	Resistance Ω
Con- nector	Termi- nals	Con- nector	Termi- nal		
M303	14	M303	17	SEEK DOWN switch ON	315 – 327
				SEEK UP switch ON	119 – 123
				SOURCE switch ON	0
	15			VOL UP switch ON	119 – 123
				VOL DOWN switch ON	0

STEERING SWITCH SIGNAL GND CIRCUIT

< COMPONENT DIAGNOSIS >

[BASE AUDIO]

STEERING SWITCH SIGNAL GND CIRCUIT

Description

INFOID:000000003468494

Transmits the steering switch signal to audio unit.

Diagnosis Procedure

INFOID:000000003468495

1.CHECK STEERING SWITCH SIGNAL GND CIRCUIT

1. Turn ignition switch OFF.
2. Disconnect audio unit connector and spiral cable connector.
3. Check continuity between audio unit harness connector and spiral cable harness connector.

Audio unit		Spiral cable		Continuity
Connector	Terminal	Connector	Terminal	
M46	15	M33	33	Existed

Is the inspection result normal?

- YES >> GO TO 2.
NO >> Repair harness or connector.

2.CHECK SPIRAL CABLE

Check spiral cable.

Is the inspection result normal?

- YES >> GO TO 3.
NO >> Replace spiral cable.

3.CHECK GROUND CIRCUIT

1. Connect audio unit connector.
2. Check continuity between audio unit harness connector and ground.

Audio unit		—	Continuity
Connector	Terminal		
M46	15	Ground	Existed

Is the inspection result normal?

- YES >> GO TO 4.
NO >> Replace audio unit.

4.CHECK STEERING SWITCH

1. Turn ignition switch OFF.
2. Check steering switch. Refer to [AV-24, "Component Inspection"](#).

Is the inspection result normal?

- YES >> INSPECTION END
NO >> Replace steering switch.

A
B
C
D
E
F
G
H
I
J
K
L
M
O
P

AV

STEERING SWITCH SIGNAL GND CIRCUIT

< COMPONENT DIAGNOSIS >

[BASE AUDIO]

INFOID:000000003470181

Component Inspection

Measure the resistance between the steering switch connector terminals.

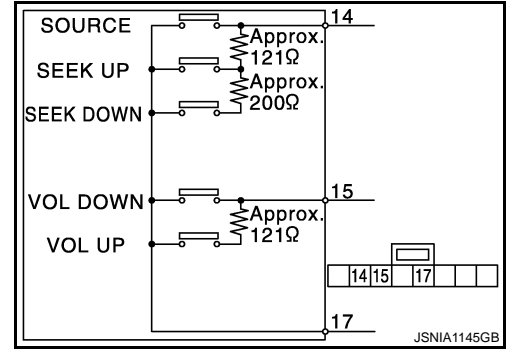

Standard

Steering switch				Condition	Resistance Ω
Con- nector	Termi- nals	Con- nector	Termi- nal		
M303	14	M303	17	SEEK DOWN switch ON	315 – 327
				SEEK UP switch ON	119 – 123
				SOURCE switch ON	0
	15			VOL UP switch ON	119 – 123
				VOL DOWN switch ON	0

AUDIO UNIT

< ECU DIAGNOSIS >

[BASE AUDIO]

ECU DIAGNOSIS

AUDIO UNIT

Reference Values

INFOID:000000003468498

TERMINAL LAYOUT

PHYSICAL VALUES

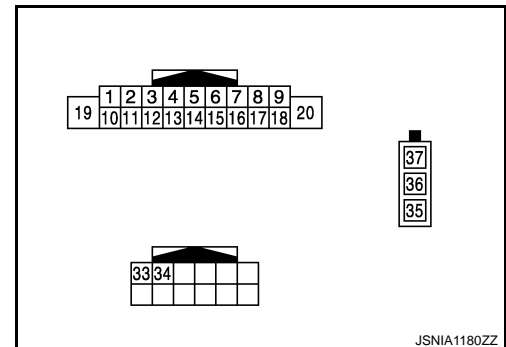

Terminal (Wire color)		Description		Condition		Reference value (Approx.)
+	-	Signal name	Input/ Output			
2 (L)	3 (B)	Sound signal front LH	Output	Ignition switch ON	Sound output.	 SKIB3609E
4 (LG)	5 (Y)	Sound signal rear LH	Output	Ignition switch ON	Sound output.	 SKIB3609E
6 (W)	15 (SB)	Steering switch signal A	Input	Ignition switch ON	Keep pressing SOURCE switch.	0 V
					Keep pressing Δ switch.	1.0 V
					Keep pressing ∇ switch.	2.0 V
					Except for above.	5.0 V
7 (R)	Ground	ACC power supply	Input	Ignition switch ACC	—	Battery voltage
11 (BR)	12 (W)	Sound signal front RH	Output	Ignition switch ON	Sound output.	 SKIB3609E

AUDIO UNIT

< ECU DIAGNOSIS >

[BASE AUDIO]

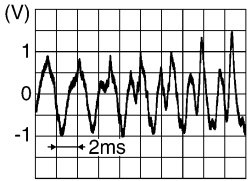
Terminal (Wire color)		Description		Condition		Reference value (Approx.)
+	-	Signal name	Input/ Output			
13 (O)	14 (P)	Sound signal rear RH	Output	Ignition switch ON	Sound output.	 SKIB3609E
15 (SB)	Ground	Steering switch signal ground	—	Ignition switch ON	—	0 V
16 (Y)	15 (SB)	Steering switch signal B	Input	Ignition switch ON	Keep pressing VOL DOWN switch.	0 V
					Keep pressing VOL UP switch.	1.0 V
					Except for above.	5.0 V
19 (Y)	Ground	Battery power supply	Input	Ignition switch OFF	—	Battery voltage
33 (G)	Ground	AV communication signal (L)	Input/ Output	—	—	—
34 (R)	Ground	AV communication signal (H)	Input/ Output	—	—	—
35	—	FM sub	Input	—	—	—
36	—	AM-FM main	Input	—	—	—
37	Ground	Antenna amp. ON signal	Output	Ignition switch ACC	—	12.0 V

AUDIO UNIT

< ECU DIAGNOSIS >

[BASE AUDIO]

Wiring Diagram — BASE AUDIO —

INFOID:000000003465382

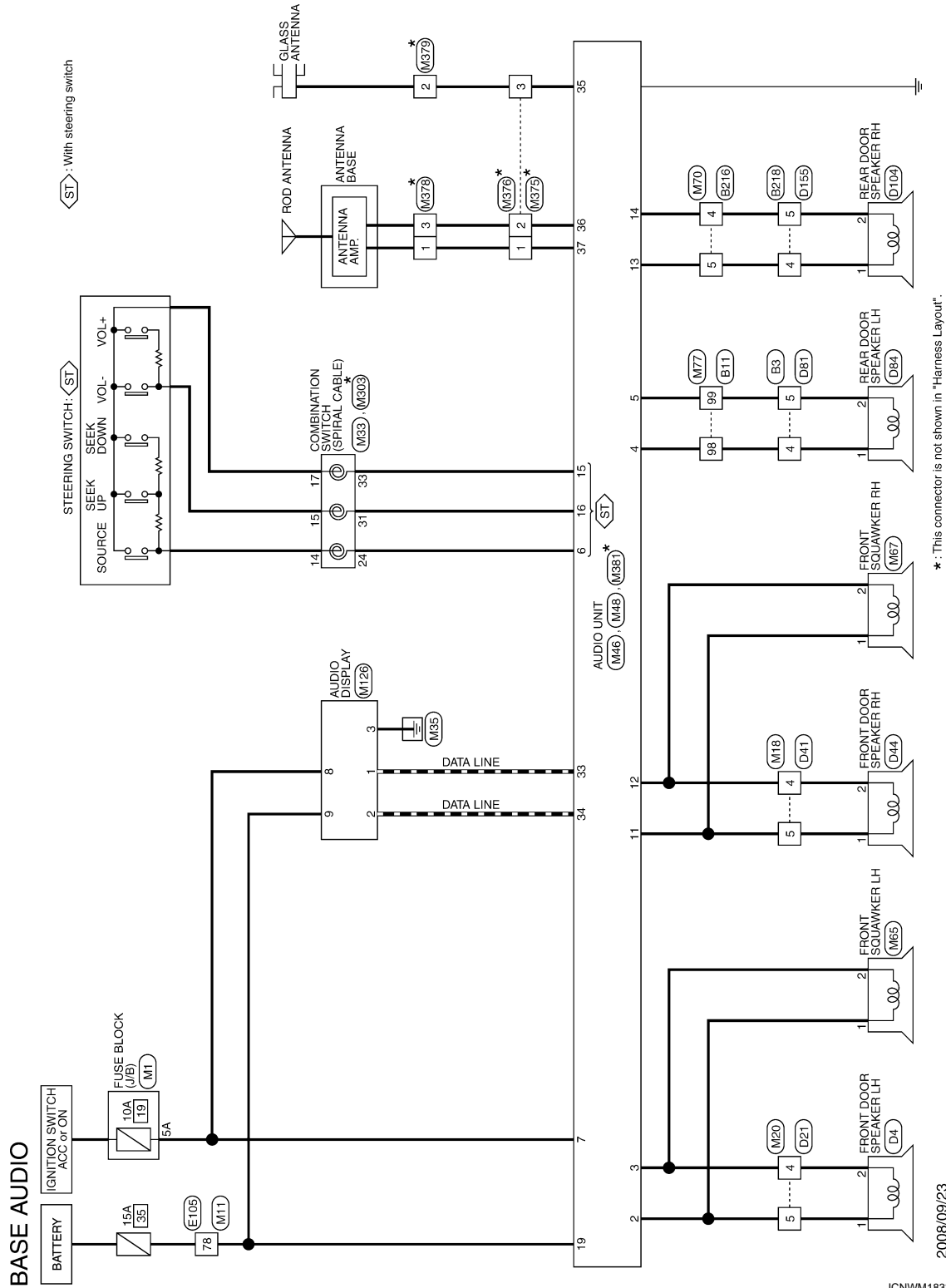

*: This connector is not shown in "Harness Layout".

2008/09/23

JCNWM1833GI

A
B
C
D
E
F
G
H
I
J
K
L
M
N
O
P

AV

AUDIO UNIT

< ECU DIAGNOSIS >

[BASE AUDIO]

BASE AUDIO

Connector No.	B218
Connector Name	WIRE TO WIRE
Connector Type	TK10FW-NS8



Terminal No.	Color of Wire	Signal Name [Specification]
4	O	- [Without BOSE system]
5	B/P	- [Without BOSE system]

Connector No.	B216
Connector Name	WIRE TO WIRE
Connector Type	NS16MRF-CS



Terminal No.	Color of Wire	Signal Name [Specification]
4	B/P	-
5	O	-

Connector No.	B11
Connector Name	WIRE TO WIRE
Connector Type	TH80MW-CS19

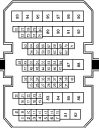

Terminal No.	Color of Wire	Signal Name [Specification]
98	LG	-
99	O	-

Connector No.	B3
Connector Name	WIRE TO WIRE
Connector Type	TK10FW-NS8



Terminal No.	Color of Wire	Signal Name [Specification]
4	LG	-
5	O	-

Connector No.	D44
Connector Name	FRONT DOOR SPEAKER RH (WITHOUT BOSE SYSTEM)
Connector Type	NS02FW-CS



Terminal No.	Color of Wire	Signal Name [Specification]
1	BR	- [Type A]
1	W	- [Type B]
2	B/R	- [Type A]
2	B	- [Type B]

Connector No.	D41
Connector Name	WIRE TO WIRE
Connector Type	TH40FW-CS15

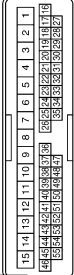

Terminal No.	Color of Wire	Signal Name [Specification]
4	B/R	- [Type A]
4	B	- [Type B]
5	BR	- [Type A]
5	W	- [Type B]

Connector No.	D21
Connector Name	WIRE TO WIRE
Connector Type	TH40FW-CS15

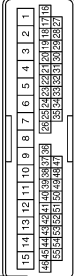

Terminal No.	Color of Wire	Signal Name [Specification]
4	B/W	- [Type A]
4	B	- [Type B]
5	L	- [Type A]
5	W	- [Type B]

Connector No.	D4
Connector Name	FRONT DOOR SPEAKER LH (WITHOUT BOSE SYSTEM)
Connector Type	NS02FW-CS



Terminal No.	Color of Wire	Signal Name [Specification]
1	L	- [Type A]
1	W	- [Type B]
2	B/W	- [Type A]
2	B	- [Type B]

















JCNWM1834GI

AUDIO UNIT

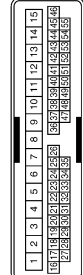
< ECU DIAGNOSIS >

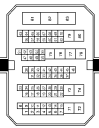
[BASE AUDIO]

BASE AUDIO

<table border="1"> <tr><td>Connector No.</td><td>D81</td></tr> <tr><td>Connector Name</td><td>WIRE TO WIRE</td></tr> <tr><td>Connector Type</td><td>TK10MW-NSS</td></tr> </table>   <table border="1"> <tr><th>Terminal No.</th><th>Color of Wire</th><th>Signal Name [Specification]</th></tr> <tr><td>4</td><td>L</td><td>-</td></tr> <tr><td>5</td><td>W</td><td>-</td></tr> </table>	Connector No.	D81	Connector Name	WIRE TO WIRE	Connector Type	TK10MW-NSS	Terminal No.	Color of Wire	Signal Name [Specification]	4	L	-	5	W	-	<table border="1"> <tr><td>Connector No.</td><td>D104</td></tr> <tr><td>Connector Name</td><td>REAR DOOR SPEAKER RH (WITHOUT BOSE SYSTEM)</td></tr> <tr><td>Connector Type</td><td>NS22FW-CS</td></tr> </table>   <table border="1"> <tr><th>Terminal No.</th><th>Color of Wire</th><th>Signal Name [Specification]</th></tr> <tr><td>1</td><td>O</td><td>- [Type A]</td></tr> <tr><td>1</td><td>L</td><td>- [Type B]</td></tr> <tr><td>2</td><td>B/P</td><td>- [Type A]</td></tr> <tr><td>2</td><td>W</td><td>- [Type B]</td></tr> </table>	Connector No.	D104	Connector Name	REAR DOOR SPEAKER RH (WITHOUT BOSE SYSTEM)	Connector Type	NS22FW-CS	Terminal No.	Color of Wire	Signal Name [Specification]	1	O	- [Type A]	1	L	- [Type B]	2	B/P	- [Type A]	2	W	- [Type B]	<table border="1"> <tr><td>Connector No.</td><td>D104</td></tr> <tr><td>Connector Name</td><td>REAR DOOR SPEAKER RH (WITHOUT BOSE SYSTEM)</td></tr> <tr><td>Connector Type</td><td>TK10MW-NSS</td></tr> </table>   <table border="1"> <tr><th>Terminal No.</th><th>Color of Wire</th><th>Signal Name [Specification]</th></tr> <tr><td>4</td><td>O</td><td>- [Type A]</td></tr> <tr><td>4</td><td>L</td><td>- [Type B]</td></tr> <tr><td>5</td><td>B/P</td><td>- [Type A]</td></tr> <tr><td>5</td><td>W</td><td>- [Type B]</td></tr> </table>	Connector No.	D104	Connector Name	REAR DOOR SPEAKER RH (WITHOUT BOSE SYSTEM)	Connector Type	TK10MW-NSS	Terminal No.	Color of Wire	Signal Name [Specification]	4	O	- [Type A]	4	L	- [Type B]	5	B/P	- [Type A]	5	W	- [Type B]
Connector No.	D81																																																										
Connector Name	WIRE TO WIRE																																																										
Connector Type	TK10MW-NSS																																																										
Terminal No.	Color of Wire	Signal Name [Specification]																																																									
4	L	-																																																									
5	W	-																																																									
Connector No.	D104																																																										
Connector Name	REAR DOOR SPEAKER RH (WITHOUT BOSE SYSTEM)																																																										
Connector Type	NS22FW-CS																																																										
Terminal No.	Color of Wire	Signal Name [Specification]																																																									
1	O	- [Type A]																																																									
1	L	- [Type B]																																																									
2	B/P	- [Type A]																																																									
2	W	- [Type B]																																																									
Connector No.	D104																																																										
Connector Name	REAR DOOR SPEAKER RH (WITHOUT BOSE SYSTEM)																																																										
Connector Type	TK10MW-NSS																																																										
Terminal No.	Color of Wire	Signal Name [Specification]																																																									
4	O	- [Type A]																																																									
4	L	- [Type B]																																																									
5	B/P	- [Type A]																																																									
5	W	- [Type B]																																																									
<table border="1"> <tr><td>Connector No.</td><td>D84</td></tr> <tr><td>Connector Name</td><td>REAR DOOR SPEAKER LH (WITHOUT BOSE SYSTEM)</td></tr> <tr><td>Connector Type</td><td>NS22FW-CS</td></tr> </table>   <table border="1"> <tr><th>Terminal No.</th><th>Color of Wire</th><th>Signal Name [Specification]</th></tr> <tr><td>1</td><td>L</td><td>-</td></tr> <tr><td>2</td><td>W</td><td>-</td></tr> </table>	Connector No.	D84	Connector Name	REAR DOOR SPEAKER LH (WITHOUT BOSE SYSTEM)	Connector Type	NS22FW-CS	Terminal No.	Color of Wire	Signal Name [Specification]	1	L	-	2	W	-	<table border="1"> <tr><td>Connector No.</td><td>M11</td></tr> <tr><td>Connector Name</td><td>WIRE TO WIRE</td></tr> <tr><td>Connector Type</td><td>TH70FW-CS10-M3</td></tr> </table>   <table border="1"> <tr><th>Terminal No.</th><th>Color of Wire</th><th>Signal Name [Specification]</th></tr> <tr><td>78</td><td>Y</td><td>-</td></tr> </table>	Connector No.	M11	Connector Name	WIRE TO WIRE	Connector Type	TH70FW-CS10-M3	Terminal No.	Color of Wire	Signal Name [Specification]	78	Y	-	<table border="1"> <tr><td>Connector No.</td><td>M18</td></tr> <tr><td>Connector Name</td><td>WIRE TO WIRE</td></tr> <tr><td>Connector Type</td><td>TH40MW-CS15</td></tr> </table>   <table border="1"> <tr><th>Terminal No.</th><th>Color of Wire</th><th>Signal Name [Specification]</th></tr> <tr><td>4</td><td>W</td><td>-</td></tr> <tr><td>5</td><td>BR</td><td>- [Type A and without BOSE system type B]</td></tr> </table>	Connector No.	M18	Connector Name	WIRE TO WIRE	Connector Type	TH40MW-CS15	Terminal No.	Color of Wire	Signal Name [Specification]	4	W	-	5	BR	- [Type A and without BOSE system type B]															
Connector No.	D84																																																										
Connector Name	REAR DOOR SPEAKER LH (WITHOUT BOSE SYSTEM)																																																										
Connector Type	NS22FW-CS																																																										
Terminal No.	Color of Wire	Signal Name [Specification]																																																									
1	L	-																																																									
2	W	-																																																									
Connector No.	M11																																																										
Connector Name	WIRE TO WIRE																																																										
Connector Type	TH70FW-CS10-M3																																																										
Terminal No.	Color of Wire	Signal Name [Specification]																																																									
78	Y	-																																																									
Connector No.	M18																																																										
Connector Name	WIRE TO WIRE																																																										
Connector Type	TH40MW-CS15																																																										
Terminal No.	Color of Wire	Signal Name [Specification]																																																									
4	W	-																																																									
5	BR	- [Type A and without BOSE system type B]																																																									
<table border="1"> <tr><td>Connector No.</td><td>E105</td></tr> <tr><td>Connector Name</td><td>WIRE TO WIRE</td></tr> <tr><td>Connector Type</td><td>TH70MW-CS10-M3</td></tr> </table>   <table border="1"> <tr><th>Terminal No.</th><th>Color of Wire</th><th>Signal Name [Specification]</th></tr> <tr><td>78</td><td>V</td><td>-</td></tr> </table>	Connector No.	E105	Connector Name	WIRE TO WIRE	Connector Type	TH70MW-CS10-M3	Terminal No.	Color of Wire	Signal Name [Specification]	78	V	-	<table border="1"> <tr><td>Connector No.</td><td>M1</td></tr> <tr><td>Connector Name</td><td>FUSE BLOCK (J/B)</td></tr> <tr><td>Connector Type</td><td>NS20FW-M2</td></tr> </table>   <table border="1"> <tr><th>Terminal No.</th><th>Color of Wire</th><th>Signal Name [Specification]</th></tr> <tr><td>5A</td><td>R</td><td>-</td></tr> </table>	Connector No.	M1	Connector Name	FUSE BLOCK (J/B)	Connector Type	NS20FW-M2	Terminal No.	Color of Wire	Signal Name [Specification]	5A	R	-	<table border="1"> <tr><td>Connector No.</td><td>M1</td></tr> <tr><td>Connector Name</td><td>FUSE BLOCK (J/B)</td></tr> <tr><td>Connector Type</td><td>NS20FW-M2</td></tr> </table>   <table border="1"> <tr><th>Terminal No.</th><th>Color of Wire</th><th>Signal Name [Specification]</th></tr> <tr><td>78</td><td>Y</td><td>-</td></tr> </table>	Connector No.	M1	Connector Name	FUSE BLOCK (J/B)	Connector Type	NS20FW-M2	Terminal No.	Color of Wire	Signal Name [Specification]	78	Y	-																					
Connector No.	E105																																																										
Connector Name	WIRE TO WIRE																																																										
Connector Type	TH70MW-CS10-M3																																																										
Terminal No.	Color of Wire	Signal Name [Specification]																																																									
78	V	-																																																									
Connector No.	M1																																																										
Connector Name	FUSE BLOCK (J/B)																																																										
Connector Type	NS20FW-M2																																																										
Terminal No.	Color of Wire	Signal Name [Specification]																																																									
5A	R	-																																																									
Connector No.	M1																																																										
Connector Name	FUSE BLOCK (J/B)																																																										
Connector Type	NS20FW-M2																																																										
Terminal No.	Color of Wire	Signal Name [Specification]																																																									
78	Y	-																																																									

A
B
C
D
E
F
G
H
I
J
K
L
M
AV
O
P

AUDIO UNIT

< ECU DIAGNOSIS >

[BASE AUDIO]

BASE AUDIO

Connector No.	M20	WIRE TO WIRE	STRG SW B
Connector Name	TH40MW-CS15		BATTERY
Connector Type			

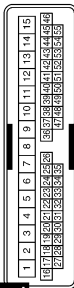

Terminal No.	Color of Wire	Signal Name [Specification]
4	B	
5	L	

Connector No.	M33	COMBINATION SWITCH (SPIRAL CABLE)
Connector Name	TK08FY-TV	
Connector Type		



Terminal No.	Color of Wire	Signal Name [Specification]
24	W	-(With audio steering switch without telephone)
31	Y	-(With audio steering switch without telephone)
33	SB	-(With audio steering switch without telephone)

Connector No.	M48	AUDIO UNIT
Connector Name	TH12FW-NH	
Connector Type		

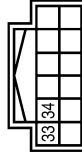

Terminal No.	Color of Wire	Signal Name [Specification]
33	G	AV COMM (L)
34	R	AV COMM (H)

Connector No.	M46	AUDIO UNIT
Connector Name	TH18FW-GS2	
Connector Type		



Terminal No.	Color of Wire	Signal Name [Specification]
2	L	SOUND SIGNAL FRONT LH (+)
3	B	SOUND SIGNAL FRONT LH (-)
4	LG	SOUND SIGNAL REAR LH (+)
5	Y	SOUND SIGNAL REAR LH (-)
6	W	STRG SW A
7	R	ACC
11	BR	SOUND SIGNAL FRONT RH (+)
12	W	SOUND SIGNAL FRONT RH (-)
13	O	SOUND SIGNAL REAR RH (+)
14	P	SOUND SIGNAL REAR RH (-)
15	SB	STRG SW GND

Connector No.	M67	FRONT SQUAWKER RH
Connector Name	TK02FBR	
Connector Type		



Terminal No.	Color of Wire	Signal Name [Specification]
1	BR	
2	W	-(Without BOSE system)

Connector No.	M70	WIRE TO WIRE
Connector Name	NS16FBR-GS	
Connector Type		









Terminal No.	Color of Wire	Signal Name [Specification]
4	P	
5	O	

AUDIO UNIT

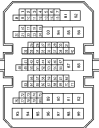
< ECU DIAGNOSIS >

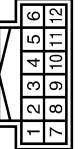
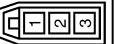
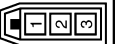
[BASE AUDIO]

BASE AUDIO

<table border="1"> <tr><td>Connector No.</td><td>M377</td></tr> <tr><td>Connector Name</td><td>WIRE TO WIRE</td></tr> <tr><td>Connector Type</td><td>THBDFW-CS1.9</td></tr> </table>  <p>H.S.</p> <table border="1"> <thead> <tr> <th>Terminal No.</th> <th>Color of Wire</th> <th>Signal Name [Specification]</th> </tr> </thead> <tbody> <tr><td>98</td><td>LG</td><td>-</td></tr> <tr><td>99</td><td>Y</td><td>-</td></tr> </tbody> </table>	Connector No.	M377	Connector Name	WIRE TO WIRE	Connector Type	THBDFW-CS1.9	Terminal No.	Color of Wire	Signal Name [Specification]	98	LG	-	99	Y	-	<table border="1"> <tr><td>Connector No.</td><td>M303</td></tr> <tr><td>Connector Name</td><td>COMBINATION SWITCH (SPIRAL CABLE)</td></tr> <tr><td>Connector Type</td><td>TKGBFGY</td></tr> </table>  <p>H.S.</p> <table border="1"> <thead> <tr> <th>Terminal No.</th> <th>Color of Wire</th> <th>Signal Name [Specification]</th> </tr> </thead> <tbody> <tr><td>14</td><td>-</td><td>-</td></tr> <tr><td>15</td><td>-</td><td>-</td></tr> <tr><td>17</td><td>-</td><td>-</td></tr> </tbody> </table>	Connector No.	M303	Connector Name	COMBINATION SWITCH (SPIRAL CABLE)	Connector Type	TKGBFGY	Terminal No.	Color of Wire	Signal Name [Specification]	14	-	-	15	-	-	17	-	-	<table border="1"> <tr><td>Connector No.</td><td>M126</td></tr> <tr><td>Connector Name</td><td>AUDIO DISPLAY</td></tr> <tr><td>Connector Type</td><td>TH12FW-NH</td></tr> </table>  <p>H.S.</p> <table border="1"> <thead> <tr> <th>Terminal No.</th> <th>Color of Wire</th> <th>Signal Name [Specification]</th> </tr> </thead> <tbody> <tr><td>1</td><td>G</td><td>AV COMM (L)</td></tr> <tr><td>2</td><td>R</td><td>AV COMM (H)</td></tr> <tr><td>3</td><td>B</td><td>GND</td></tr> <tr><td>8</td><td>R</td><td>ACC</td></tr> <tr><td>9</td><td>Y</td><td>+B</td></tr> </tbody> </table>	Connector No.	M126	Connector Name	AUDIO DISPLAY	Connector Type	TH12FW-NH	Terminal No.	Color of Wire	Signal Name [Specification]	1	G	AV COMM (L)	2	R	AV COMM (H)	3	B	GND	8	R	ACC	9	Y	+B	<table border="1"> <tr><td>Connector No.</td><td>M375</td></tr> <tr><td>Connector Name</td><td>WIRE TO WIRE</td></tr> <tr><td>Connector Type</td><td>GT13SH-2/1S-HU</td></tr> </table>  <p>H.S.</p> <table border="1"> <thead> <tr> <th>Terminal No.</th> <th>Color of Wire</th> <th>Signal Name [Specification]</th> </tr> </thead> <tbody> <tr><td>1</td><td>-</td><td>-</td></tr> <tr><td>2</td><td>-</td><td>-</td></tr> <tr><td>3</td><td>-</td><td>-</td></tr> </tbody> </table>	Connector No.	M375	Connector Name	WIRE TO WIRE	Connector Type	GT13SH-2/1S-HU	Terminal No.	Color of Wire	Signal Name [Specification]	1	-	-	2	-	-	3	-	-	<table border="1"> <tr><td>Connector No.</td><td>M376</td></tr> <tr><td>Connector Name</td><td>WIRE TO WIRE</td></tr> <tr><td>Connector Type</td><td>GT13SON-2/1PP-HU</td></tr> </table>  <p>H.S.</p> <table border="1"> <thead> <tr> <th>Terminal No.</th> <th>Color of Wire</th> <th>Signal Name [Specification]</th> </tr> </thead> <tbody> <tr><td>1</td><td>-</td><td>-</td></tr> <tr><td>2</td><td>-</td><td>-</td></tr> <tr><td>3</td><td>-</td><td>-</td></tr> </tbody> </table>	Connector No.	M376	Connector Name	WIRE TO WIRE	Connector Type	GT13SON-2/1PP-HU	Terminal No.	Color of Wire	Signal Name [Specification]	1	-	-	2	-	-	3	-	-	<table border="1"> <tr><td>Connector No.</td><td>M378</td></tr> <tr><td>Connector Name</td><td>ANTENNA BASE (ANTENNA AMP.)</td></tr> <tr><td>Connector Type</td><td>GT13SSN-1/1PP-HU</td></tr> </table>  <p>H.S.</p> <table border="1"> <thead> <tr> <th>Terminal No.</th> <th>Color of Wire</th> <th>Signal Name [Specification]</th> </tr> </thead> <tbody> <tr><td>1</td><td>-</td><td>-</td></tr> <tr><td>2</td><td>-</td><td>-</td></tr> <tr><td>3</td><td>-</td><td>-</td></tr> </tbody> </table>	Connector No.	M378	Connector Name	ANTENNA BASE (ANTENNA AMP.)	Connector Type	GT13SSN-1/1PP-HU	Terminal No.	Color of Wire	Signal Name [Specification]	1	-	-	2	-	-	3	-	-	<table border="1"> <tr><td>Connector No.</td><td>M379</td></tr> <tr><td>Connector Name</td><td>GLASS ANTENNA</td></tr> <tr><td>Connector Type</td><td>GT13SCN-1/1PP-HU</td></tr> </table>  <p>H.S.</p> <table border="1"> <thead> <tr> <th>Terminal No.</th> <th>Color of Wire</th> <th>Signal Name [Specification]</th> </tr> </thead> <tbody> <tr><td>2</td><td>-</td><td>FM SUB</td></tr> </tbody> </table>	Connector No.	M379	Connector Name	GLASS ANTENNA	Connector Type	GT13SCN-1/1PP-HU	Terminal No.	Color of Wire	Signal Name [Specification]	2	-	FM SUB	<table border="1"> <tr><td>Connector No.</td><td>M381</td></tr> <tr><td>Connector Name</td><td>AUDIO UNIT</td></tr> <tr><td>Connector Type</td><td>GT13SC-2/1S-HU</td></tr> </table>  <p>H.S.</p> <table border="1"> <thead> <tr> <th>Terminal No.</th> <th>Color of Wire</th> <th>Signal Name [Specification]</th> </tr> </thead> <tbody> <tr><td>35</td><td>-</td><td>FM SUB</td></tr> <tr><td>36</td><td>-</td><td>AM-FM MAIN</td></tr> <tr><td>37</td><td>-</td><td>ANTENNA AMP. ON SIGNAL</td></tr> </tbody> </table>	Connector No.	M381	Connector Name	AUDIO UNIT	Connector Type	GT13SC-2/1S-HU	Terminal No.	Color of Wire	Signal Name [Specification]	35	-	FM SUB	36	-	AM-FM MAIN	37	-	ANTENNA AMP. ON SIGNAL
Connector No.	M377																																																																																																																																																			
Connector Name	WIRE TO WIRE																																																																																																																																																			
Connector Type	THBDFW-CS1.9																																																																																																																																																			
Terminal No.	Color of Wire	Signal Name [Specification]																																																																																																																																																		
98	LG	-																																																																																																																																																		
99	Y	-																																																																																																																																																		
Connector No.	M303																																																																																																																																																			
Connector Name	COMBINATION SWITCH (SPIRAL CABLE)																																																																																																																																																			
Connector Type	TKGBFGY																																																																																																																																																			
Terminal No.	Color of Wire	Signal Name [Specification]																																																																																																																																																		
14	-	-																																																																																																																																																		
15	-	-																																																																																																																																																		
17	-	-																																																																																																																																																		
Connector No.	M126																																																																																																																																																			
Connector Name	AUDIO DISPLAY																																																																																																																																																			
Connector Type	TH12FW-NH																																																																																																																																																			
Terminal No.	Color of Wire	Signal Name [Specification]																																																																																																																																																		
1	G	AV COMM (L)																																																																																																																																																		
2	R	AV COMM (H)																																																																																																																																																		
3	B	GND																																																																																																																																																		
8	R	ACC																																																																																																																																																		
9	Y	+B																																																																																																																																																		
Connector No.	M375																																																																																																																																																			
Connector Name	WIRE TO WIRE																																																																																																																																																			
Connector Type	GT13SH-2/1S-HU																																																																																																																																																			
Terminal No.	Color of Wire	Signal Name [Specification]																																																																																																																																																		
1	-	-																																																																																																																																																		
2	-	-																																																																																																																																																		
3	-	-																																																																																																																																																		
Connector No.	M376																																																																																																																																																			
Connector Name	WIRE TO WIRE																																																																																																																																																			
Connector Type	GT13SON-2/1PP-HU																																																																																																																																																			
Terminal No.	Color of Wire	Signal Name [Specification]																																																																																																																																																		
1	-	-																																																																																																																																																		
2	-	-																																																																																																																																																		
3	-	-																																																																																																																																																		
Connector No.	M378																																																																																																																																																			
Connector Name	ANTENNA BASE (ANTENNA AMP.)																																																																																																																																																			
Connector Type	GT13SSN-1/1PP-HU																																																																																																																																																			
Terminal No.	Color of Wire	Signal Name [Specification]																																																																																																																																																		
1	-	-																																																																																																																																																		
2	-	-																																																																																																																																																		
3	-	-																																																																																																																																																		
Connector No.	M379																																																																																																																																																			
Connector Name	GLASS ANTENNA																																																																																																																																																			
Connector Type	GT13SCN-1/1PP-HU																																																																																																																																																			
Terminal No.	Color of Wire	Signal Name [Specification]																																																																																																																																																		
2	-	FM SUB																																																																																																																																																		
Connector No.	M381																																																																																																																																																			
Connector Name	AUDIO UNIT																																																																																																																																																			
Connector Type	GT13SC-2/1S-HU																																																																																																																																																			
Terminal No.	Color of Wire	Signal Name [Specification]																																																																																																																																																		
35	-	FM SUB																																																																																																																																																		
36	-	AM-FM MAIN																																																																																																																																																		
37	-	ANTENNA AMP. ON SIGNAL																																																																																																																																																		

A
B
C
D
E
F
G
H
I
J
K
L
M
O
P

AV

JCNWM1837GI

SYMPTOM DIAGNOSIS

AUDIO SYSTEM SYMPTOMS

Symptom Table

INFOID:000000003470195

RELATED TO AUDIO

Trouble diagnosis chart by symptom

Symptoms	Check items	Possible malfunction location / Action to take
Audio sound is not heard.	No sound from all speakers.	Audio unit malfunction. Refer to AV-37, "Exploded View" .
	There is no sound from one of speakers.	Sound signal malfunction between audio unit and speaker on the side where there is no sound.
AM/FM radio is not received.	Other audio sounds are normal.	<ul style="list-style-type: none"> • Antenna amp. ON signal circuit. • Antenna feeder. • Rod antenna. • Antenna base.
Audio display does not work.	—	<ul style="list-style-type: none"> • Audio display power supply and ground circuits. • AV communication circuits between audio unit and audio display.

RELATED TO STEERING SWITCH

Trouble diagnosis chart by symptom

Symptoms	Inspection location / Probable malfunction location
None of the steering switch operations work.	Steering switch signal GND circuit. Refer to AV-23, "Diagnosis Procedure" .
Only specified switch cannot be operated.	Steering switch. Refer to AV-42, "Exploded View" .
"SOURCE", "MENU UP", "MENU DOWN" switches of steering switch are not operational.	Steering switch signal A circuit. Refer to AV-19, "Diagnosis Procedure" .
"VOL UP", "VOL DOWN" switches of steering switch are not operational.	Steering switch signal B circuit. Refer to AV-21, "Diagnosis Procedure" .

NORMAL OPERATING CONDITION

< SYMPTOM DIAGNOSIS >

[BASE AUDIO]

NORMAL OPERATING CONDITION

Description

INFOID:000000003465389

NOTE:

- Audio operation information, refer to Owner's Manual.
- The majority of the audio concerns are the result of outside causes (bad CD, electromagnetic interference, etc.).

NOISE

The following noise results from variations in field strength, such as fading noise and multi-path noise, or external noise from trains and other sources. It is not a malfunction.

- Fading noise: This noise occurs because of variations in the field strength in a narrow range due to mountains or buildings blocking the signal.
- Multi-path noise: This noise results from the waves sent directly from the broadcast station arriving at the antenna at a different time from the waves that reflect off mountains or buildings.

The vehicle itself can be a source of noise if noise prevention parts or electrical equipment is malfunctioning. Check if noise is caused and/or changed by engine speed, ignition switch turned to each position, and operation of each piece of electrical equipment, and then determine the cause.

NOTE:

The source of the noise can be easily found by listening to the noise while removing the fuses of electrical components, one by one.

Types of Noise and Possible Causes

Occurrence condition		Possible cause
Occurs only when engine is ON.	A continuous growling noise occurs. The speed of the noise varies with changes in the engine speed.	• Ignition components
The occurrence of the noise is linked with the operation of the fuel pump.		• Fuel pump condenser
Noise only occurs when various electrical components are operating.	A cracking or snapping sound occurs with the operation of various switches.	• Relay malfunction, audio unit malfunction
	The noise occurs when various motors are operating.	• Motor case ground • Motor
The noise occurs constantly, not just under certain conditions.		• Rear defogger coil malfunction • Open circuit in printed heater • Poor ground of antenna feeder line
A cracking or snapping sound occurs while the vehicle is being driven, especially when it is vibrating excessively.		• Ground wire of body parts • Ground due to improper part installation • Wiring connections or a short circuit

A
B
C
D
E
F
G
H
I
J
K
L
M
O
P

AV

PRECAUTION

PRECAUTIONS

Precaution for Supplemental Restraint System (SRS) "AIR BAG" and "SEAT BELT PRE-TENSIONER"

INFOID:000000003671426

The Supplemental Restraint System such as "AIR BAG" and "SEAT BELT PRE-TENSIONER", used along with a front seat belt, helps to reduce the risk or severity of injury to the driver and front passenger for certain types of collision. This system includes seat belt switch inputs and dual stage front air bag modules. The SRS system uses the seat belt switches to determine the front air bag deployment, and may only deploy one front air bag, depending on the severity of a collision and whether the front occupants are belted or unbelted. Information necessary to service the system safely is included in the "SRS AIRBAG" and "SEAT BELT" of this Service Manual.

WARNING:

- **To avoid rendering the SRS inoperative, which could increase the risk of personal injury or death in the event of a collision which would result in air bag inflation, all maintenance must be performed by an authorized NISSAN/INFINITI dealer.**
- **Improper maintenance, including incorrect removal and installation of the SRS, can lead to personal injury caused by unintentional activation of the system. For removal of Spiral Cable and Air Bag Module, see the "SRS AIRBAG".**
- **Never use electrical test equipment on any circuit related to the SRS unless instructed to in this Service Manual. SRS wiring harnesses can be identified by yellow and/or orange harnesses or harness connectors.**

PRECAUTIONS WHEN USING POWER TOOLS (AIR OR ELECTRIC) AND HAMMERS

When working near the Airbag Diagnosis Sensor Unit or other Airbag System sensors while ignition switch is ON or engine is running, never use air or electric power tools or strike near the sensor(s) with a hammer. Heavy vibration may activate the sensor(s), deploy the airbag(s), possibly cause serious injury. When using air or electric power tools or hammers, always turn OFF ignition switch, disconnect the battery, and wait 3 minutes or more before performing any service.

Precaution for Trouble Diagnosis

INFOID:000000003509002

AV COMMUNICATION SYSTEM

- Do not apply voltage of 7.0 V or higher to the measurement terminals.
- Use the tester with its open terminal voltage at 7.0 V or less.
- Turn ignition switch OFF and disconnect the battery cable from the negative terminal before checking the circuit.

Precaution for Harness Repair

INFOID:000000003509003

AV COMMUNICATION SYSTEM

- Solder the repaired parts, and wrap with tape. [Frays of twisted line must be within 110 mm (4.33 in).]

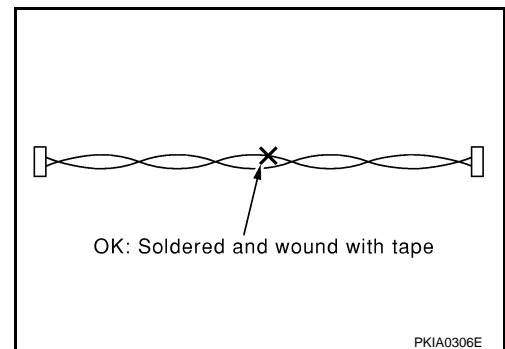

PRECAUTIONS

< PRECAUTION >

[BASE AUDIO]

- Do not perform bypass wire connections for the repair parts. (The spliced wire will become separated and the characteristics of twisted line will be lost.)

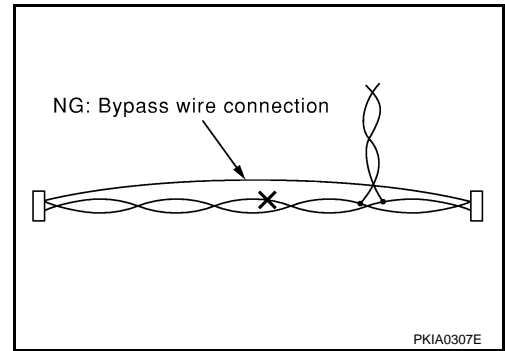

A
B
C
D
E
F
G
H
I
J
K
L
M
AV
O
P

PREPARATION

PREPARATION

Commercial Service Tools

INFOID:000000003509004

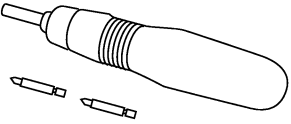
Tool name	Description
<p data-bbox="175 516 285 541">Power tool</p>  <p data-bbox="850 632 919 646">PBIC0191E</p>	<p data-bbox="1005 516 1187 541">Loosening screws</p>

ON-VEHICLE REPAIR**AUDIO UNIT****Exploded View**

INFOID:000000003509006

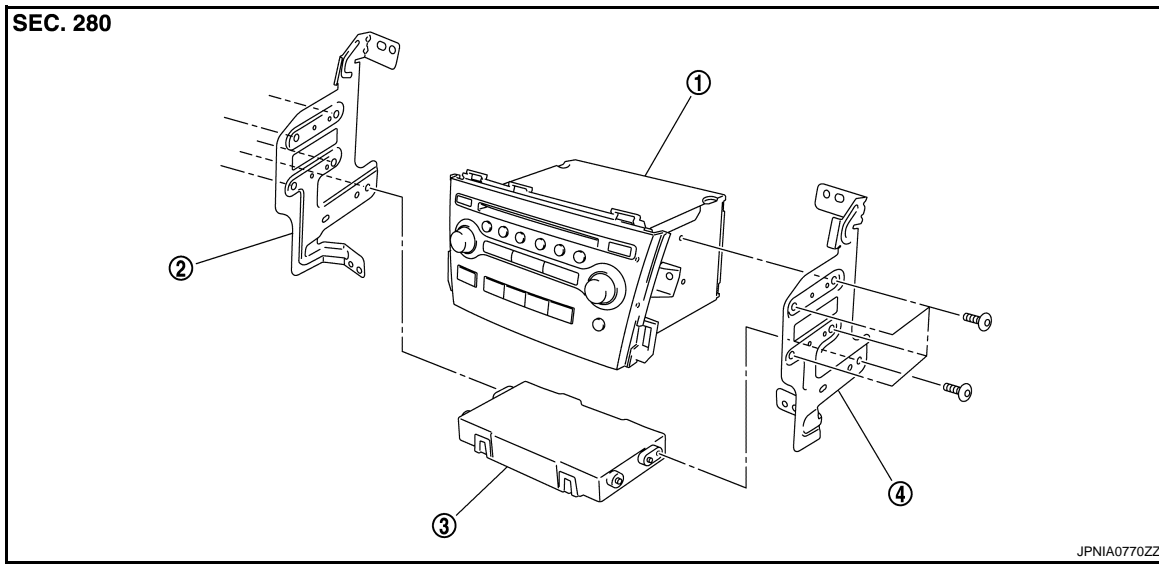
REMOVALRefer to [IP-11, "Exploded View"](#).**DISASSEMBLY**

- | | | |
|---------------|---------------|------------------|
| 1. Audio unit | 2. Bracket LH | 3. A/C auto amp. |
| 4. Bracket RH | | |

Removal and Installation

INFOID:000000003509007

REMOVAL

1. Remove cluster lid C lower. Refer to [IP-11, "Exploded View"](#).
2. Remove instrument stay cover LH and instrument stay cover RH Refer to [IP-11, "Exploded View"](#).
3. Remove audio unit with an A/C auto amp. as a single unit from the body.
4. Remove bracket screws, and then remove audio unit.

INSTALLATION

Install in the reverse order of removal.

A
B
C
D
E
F
G
H
I
J
K
L
M
O
P

AV

AUDIO DISPLAY

< ON-VEHICLE REPAIR >

[BASE AUDIO]

AUDIO DISPLAY

Exploded View

INFOID:000000003509008

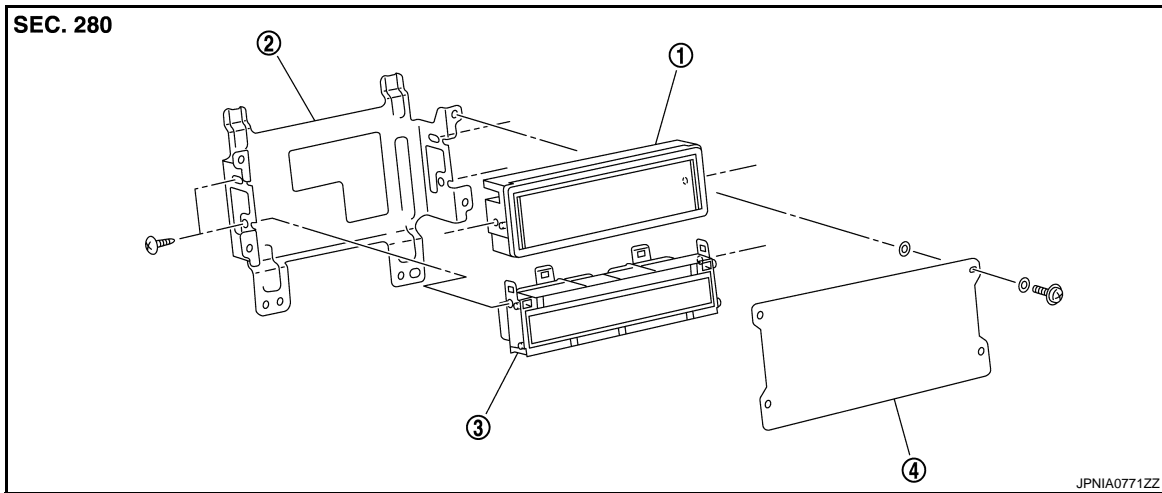

1. Audio display unit

2. Bracket

3. A/C display

4. Front cover

Removal and Installation

INFOID:000000003509009

REMOVAL

1. Remove center ventilator assembly. Refer to [IP-11. "Exploded View"](#).
2. Remove audio display unit and A/C display with bracket as a single unit (1).
3. Remove bracket screws, and then remove audio display unit.

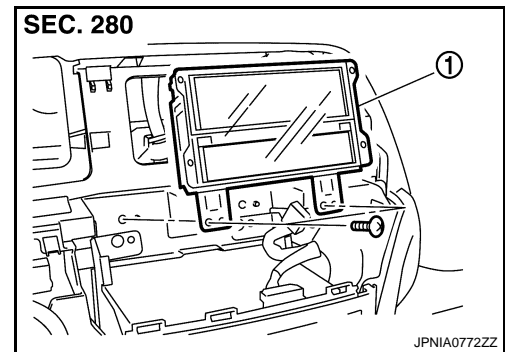

INSTALLATION

Install in the reverse order of removal.

FRONT DOOR SPEAKER

< ON-VEHICLE REPAIR >

[BASE AUDIO]

FRONT DOOR SPEAKER

Exploded View

INFOID:000000003509010

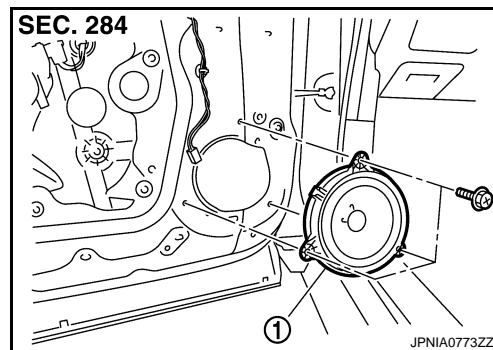

1. Front door speaker

Removal and Installation

INFOID:000000003509011

REMOVAL

1. Remove front door finisher. Refer to [INT-11, "FRONT DOOR FINISHER : Exploded View"](#).
2. Remove front door speaker screws, then disconnect front door speaker connector and remove front door speaker.

INSTALLATION

Install in the reverse order of removal.

A
B
C
D
E
F
G
H
I
J
K
L
M
O
P

AV

REAR DOOR SPEAKER

< ON-VEHICLE REPAIR >

[BASE AUDIO]

REAR DOOR SPEAKER

Exploded View

INFOID:000000003509012

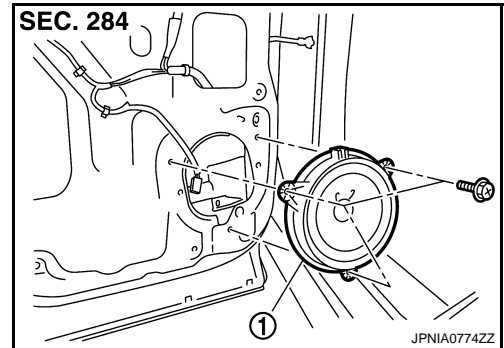

1. Rear door speaker

Removal and Installation

INFOID:000000003509013

REMOVAL

1. Remove rear door finisher. Refer to [INT-15. "REAR DOOR FINISHER : Exploded View"](#).
2. Remove rear door speaker screws, then disconnect rear door speaker connector and remove rear door speaker.

INSTALLATION

Install in the reverse order of removal.

FRONT SQUAWKER

< ON-VEHICLE REPAIR >

[BASE AUDIO]

FRONT SQUAWKER

Exploded View

INFOID:000000003509014

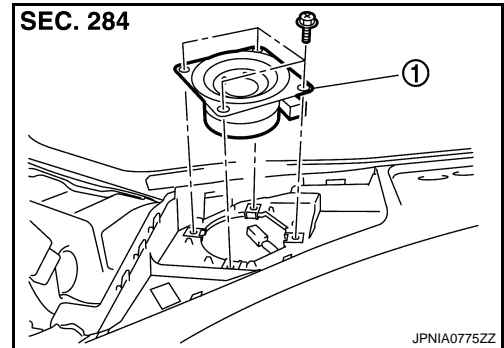

1. Front squawker

Removal and Installation

INFOID:000000003509015

REMOVAL

1. Remove speaker grille. Refer to [IP-11, "Exploded View"](#).
2. Remove front squawker screws, lift up the front squawker and disconnect front squawker connector. Then remove the front squawker.

INSTALLATION

Install in the reverse order of removal.

A
B
C
D
E
F
G
H
I
J
K
L
M
O
P

AV

STEERING SWITCH

< ON-VEHICLE REPAIR >

[BASE AUDIO]

STEERING SWITCH

Exploded View

INFOID:000000003509028

Refer to [ST-15. "Exploded View"](#).

Removal and Installation

INFOID:000000003509029

REMOVAL

Refer to [ST-15. "Removal and Installation"](#).

INSTALLATION

Install in the reverse order of removal.

ROOF ANTENNA

Exploded View

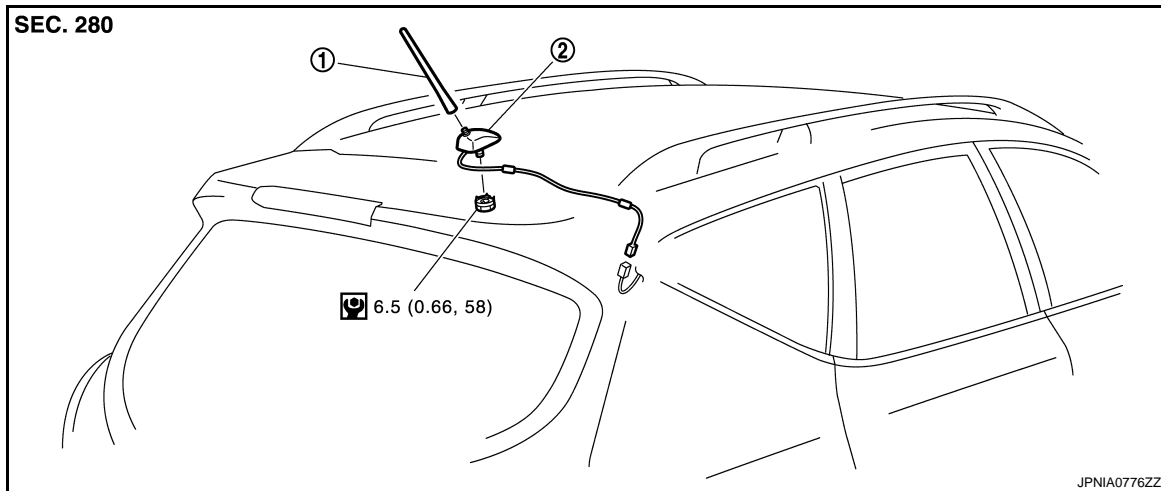

1. Rod antenna
2. Antenna base

Refer to [GI-4. "Components"](#) for symbols in the figure.

Removal and Installation

REMOVAL

1. Remove headlining assembly (rear) to secure work space between vehicle and headlining. Refer to [INT-25. "NORMAL ROOF : Exploded View"](#) [without sunroof] or [INT-29. "SUNROOF : Exploded View"](#) [with sunroof].
2. Disconnect AM/FM main connector.
3. Remove antenna base nut, and then remove antenna base from roof panel.

INSTALLATION

Install in the reverse order of removal.

Antenna base mounting nut : **6.5 N-m (0.66 kg-m, 58 in-lb)**

CAUTION:

Be careful about tightening torque. When the antenna base mounting nut tightening torque is loose, the antenna sensitivity becomes poor, and when it is excessive, the roof panel may be deformed.

A
B
C
D
E
F
G
H
I
J
K
L
M

AV

O
P

ANTENNA FEEDER (RADIO)

< ON-VEHICLE REPAIR >

[BASE AUDIO]

ANTENNA FEEDER (RADIO)

Harness Layout

INFOID:000000003509052

SEC. 280

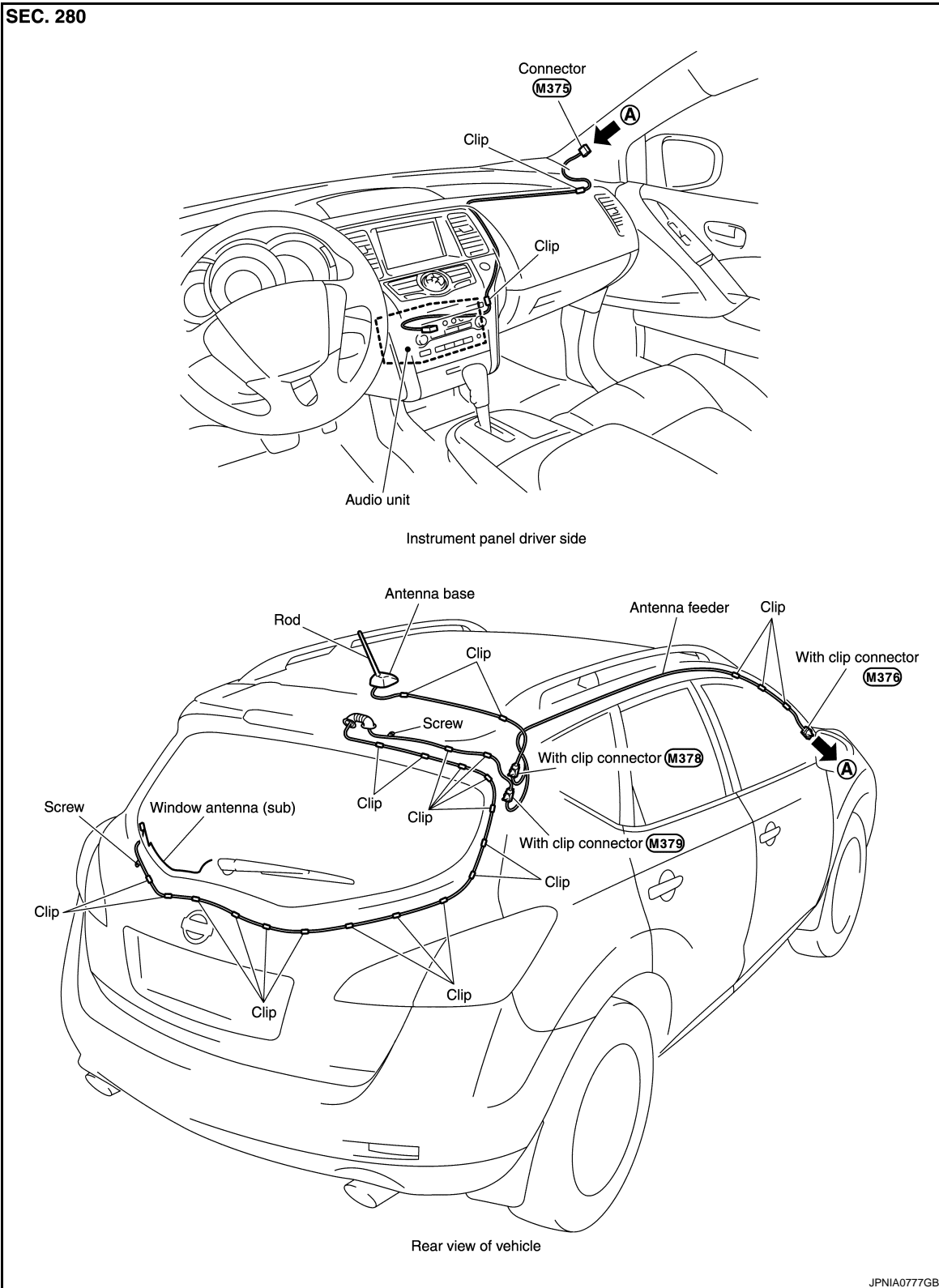

JPNIA077GB

BASIC INSPECTION

DIAGNOSIS AND REPAIR WORK FLOW

Work Flow

INFOID:000000003356747

OVERALL SEQUENCE

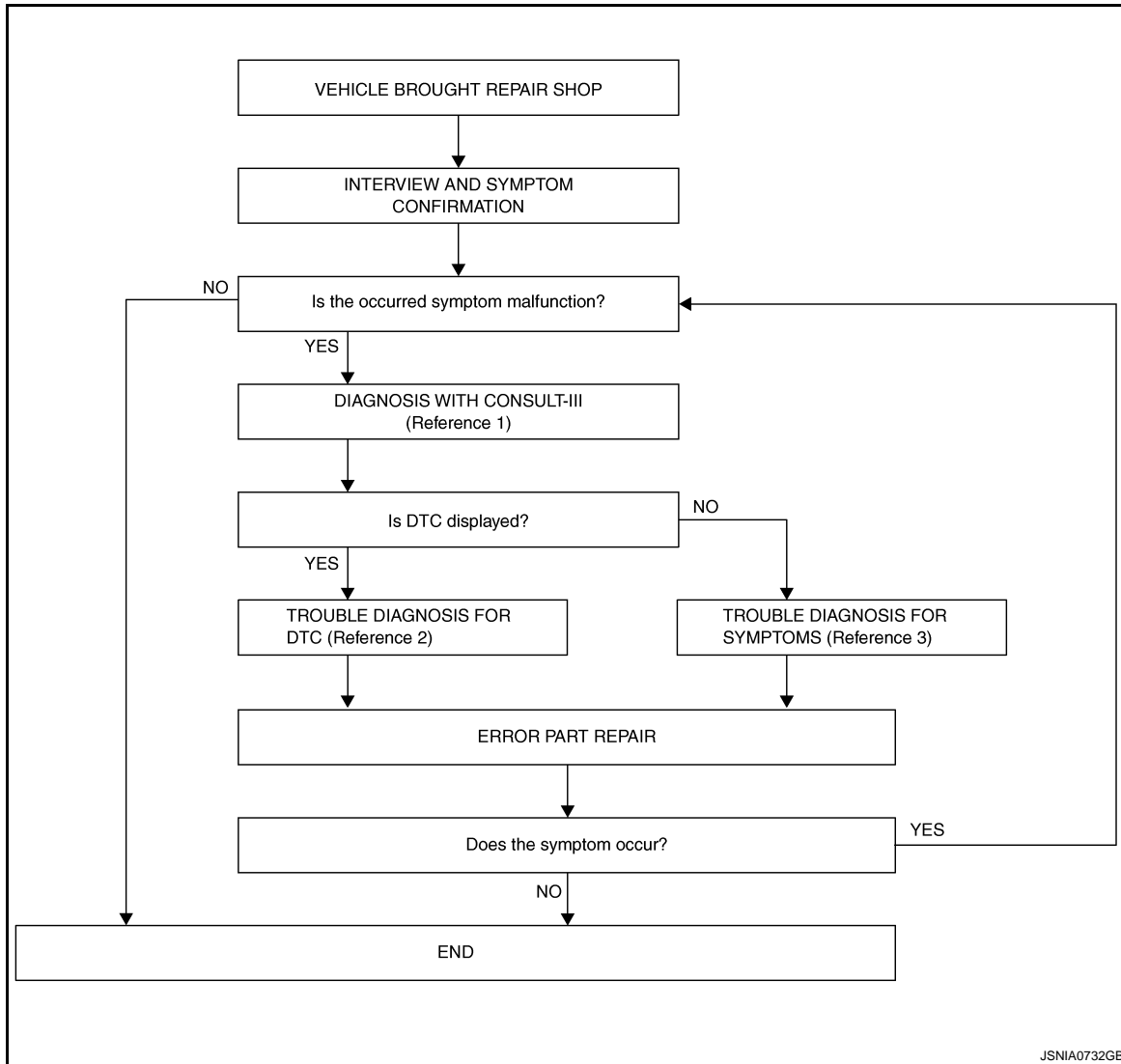

- Reference 1... Refer to [AV-83. "CONSULT-III Function \(MULTI AV\)".](#)
- Reference 2... Refer to [AV-192. "DTC Index".](#)
- Reference 3... Refer to [AV-509. "Symptom Table".](#)

DETAILED FLOW

1. INTERVIEW AND SYMPTOM CONFIRMATION

Check the malfunction symptoms by performing the following items.

- Interview the customer to obtain the malfunction information (conditions and environment when the malfunction occurred).
- Check the symptom.

Is the occurring symptom a malfunction?

YES >> GO TO 2.

NO >> INSPECTION END

2. DIAGNOSIS WITH CONSULT-III

DIAGNOSIS AND REPAIR WORK FLOW

[BOSE AUDIO WITHOUT NAVIGATION]

< BASIC INSPECTION >

1. Connect CONSULT-III and perform a self-diagnosis for "MULTI AV". Refer to [AV-83. "CONSULT-III Function \(MULTI AV\)".](#)

NOTE:

Skip to step 4 of the diagnosis procedure if "MULTI AV" is not displayed.

2. Check if any DTC is displayed in the self-diagnosis results.

Is DTC displayed?

YES >> GO TO 3.

NO >> GO TO 4.

3. TROUBLE DIAGNOSIS FOR DTC

1. Check the DTC indicated in the self-diagnosis results.
2. Perform the relevant diagnosis referring to the DTC Index. Refer to [AV-192. "DTC Index".](#)

>> GO TO 5.

4. TROUBLE DIAGNOSIS FOR SYMPTOMS

Perform the relevant diagnosis referring to the diagnosis chart by symptom. Refer to [AV-509. "Symptom Table".](#)

>> GO TO 5.

5. ERROR PART REPAIR

1. Repair or replace the identified malfunctioning parts.
2. Perform a self-diagnosis for "MULTI AV" with CONSULT-III.

NOTE:

Erase the stored self-diagnosis results after repairing or replacing the relevant components if any DTC has been indicated in the self-diagnosis results.

3. Check that the symptom does not occur.

Does the symptom occur?

YES >> GO TO 1.

NO >> INSPECTION END

INSPECTION AND ADJUSTMENT

< BASIC INSPECTION >

[BOSE AUDIO WITHOUT NAVIGATION]

INSPECTION AND ADJUSTMENT

ADDITIONAL SERVICE WHEN REMOVING BATTERY NEGATIVE TERMINAL

ADDITIONAL SERVICE WHEN REMOVING BATTERY NEGATIVE TERMINAL : Description

INFOID:000000003579559

Always correct the center position of the rear view monitor's possible route line after disconnecting the battery negative terminal.

ADDITIONAL SERVICE WHEN REMOVING BATTERY NEGATIVE TERMINAL : Special Repair Requirement

INFOID:000000003579560

1. CORRECTION OF CENTER POSITION OF REAR VIEW MONITOR'S POSSIBLE ROUTE LINE

Refer to the following for details.

>> Refer to [AV-47, "REAR VIEW MONITOR POSSIBLE ROUTE LINE CENTER POSITION ADJUSTMENT : Special Repair Requirement"](#).

ADDITIONAL SERVICE WHEN REPLACING CONTROL UNIT

ADDITIONAL SERVICE WHEN REPLACING CONTROL UNIT : Description

INFOID:000000003579561

When camera control unit is replaced, the center position of rear view monitor possible route line is corrected.

ADDITIONAL SERVICE WHEN REPLACING CONTROL UNIT : Special Repair Requirement

INFOID:000000003579562

1. CORRECTION OF CENTER POSITION OF REAR VIEW MONITOR'S POSSIBLE ROUTE LINE

Refer to the following for details.

>> Refer to [AV-47, "REAR VIEW MONITOR POSSIBLE ROUTE LINE CENTER POSITION ADJUSTMENT : Special Repair Requirement"](#).

REAR VIEW MONITOR POSSIBLE ROUTE LINE CENTER POSITION ADJUSTMENT

REAR VIEW MONITOR POSSIBLE ROUTE LINE CENTER POSITION ADJUSTMENT : Description

INFOID:000000003579563

Adjust the center position of the possible route line of the rear view monitor if it is shifted.

REAR VIEW MONITOR POSSIBLE ROUTE LINE CENTER POSITION ADJUSTMENT : Special Repair Requirement

INFOID:000000003579564

1. STEERING OPERATION

Steer the steering wheel to the leftmost and rightmost positions.

>> GO TO 2

2. DRIVING

Drive the vehicle straight ahead 100 m (328.1 ft) or more at a speed of 30 km/h (18.6 MPH) or more.

>> END

MULTI AV SYSTEM

< FUNCTION DIAGNOSIS >

[BOSE AUDIO WITHOUT NAVIGATION]

FUNCTION DIAGNOSIS

MULTI AV SYSTEM

System Diagram

INFOID:000000003356748

WITHOUT DVD ENTERTAINMENT SYSTEM

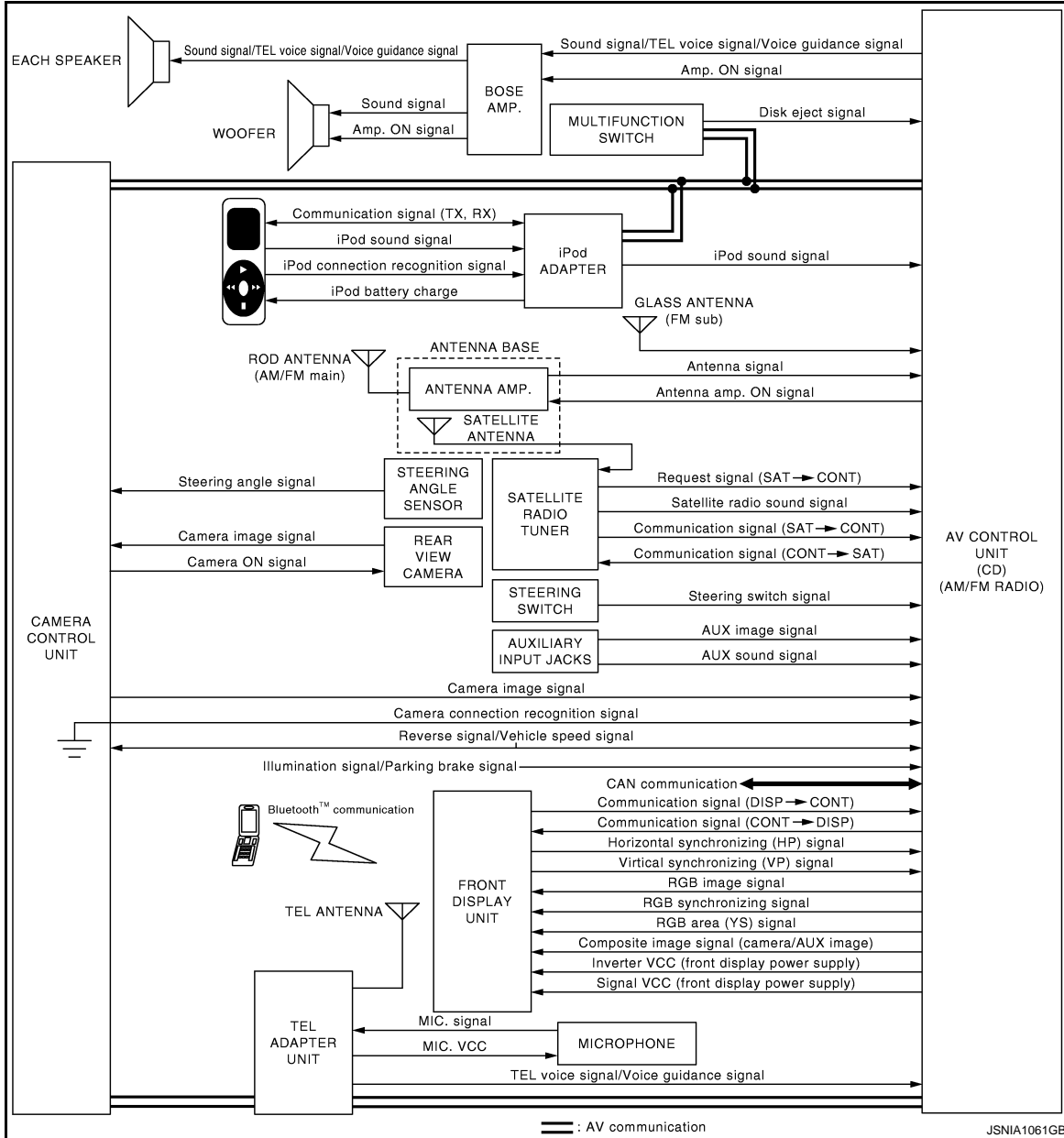

NOTE:

- Woofer, illustrated in the above figure, integrates two woofers and a woofer amp.
- In this section, PRESET SWITCH and MULTIFUNCTION SWITCH are written as the MULTIFUNCTION SWITCH.

MULTI AV SYSTEM

[BOSE AUDIO WITHOUT NAVIGATION]

< FUNCTION DIAGNOSIS >

- An antenna base integrated with radio antenna amp. and satellite radio antenna is adopted.

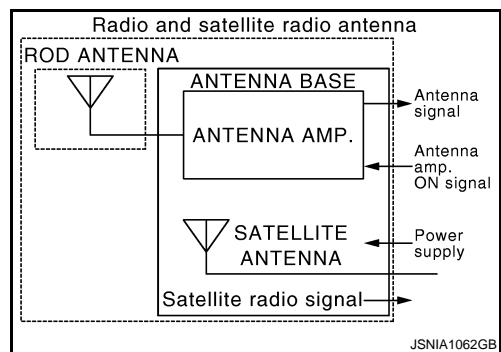

A
B
C
D
E
F
G
H
I
J
K
L
M

AV

O
P

MULTI AV SYSTEM

< FUNCTION DIAGNOSIS >

[BOSE AUDIO WITHOUT NAVIGATION]

WITH DVD ENTERTAINMENT SYSTEM

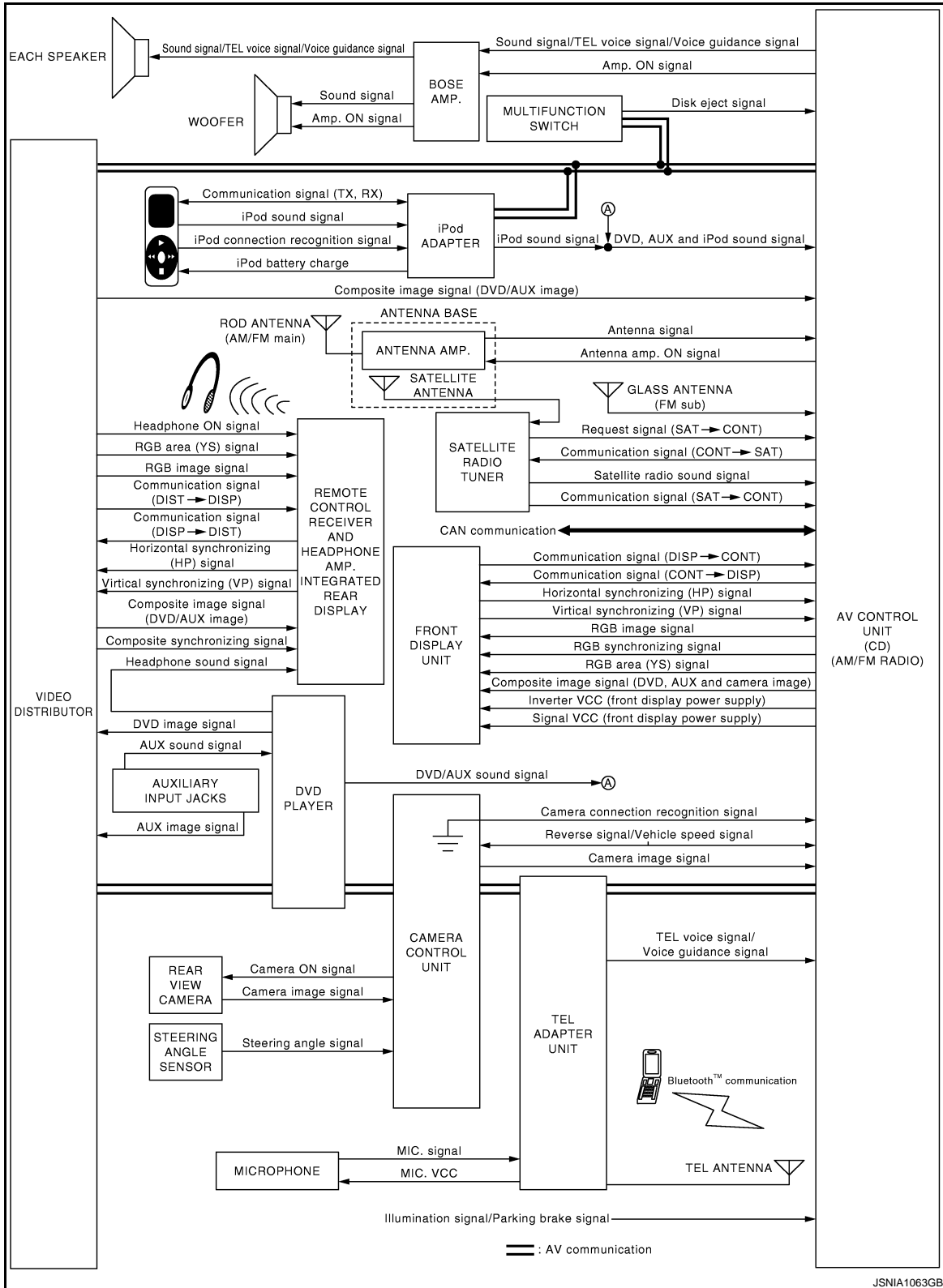

NOTE:

- Woofer, illustrated in the above figure, integrates two woofers and a woofer amp.
- In this section, PRESET SWITCH and MULTIFUNCTION SWITCH are written as the MULTIFUNCTION SWITCH.

MULTI AV SYSTEM

[BOSE AUDIO WITHOUT NAVIGATION]

< FUNCTION DIAGNOSIS >

- An antenna base integrated with radio antenna and satellite radio antenna is adopted.

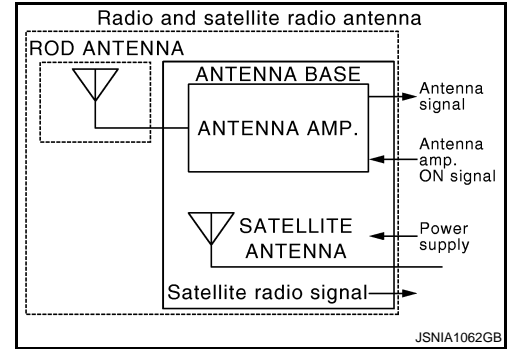

System Description

INFOID:000000003356749

MULTI AV system means that the following systems are integrated.

System name	System explanation
AUDIO SYSTEM	AV-60, "System Description"
REAR VIEW MONITOR SYSTEM	AV-57, "System Description"
DVD ENTERTAINMENT SYSTEM	AV-64, "System Description"
HANDS-FREE PHONE SYSTEM	AV-67, "System Description"
VEHICLE INFORMATION SYSTEM	<ul style="list-style-type: none"> Indicates the status of audio, climate control system, fuel economy and maintenance. AV control unit displays the fuel consumption status while receiving data signals through CAN communication from ECM, combination meter and BCM.
AUXILIARY INPUT SYSTEM	Refer to "AUXILIARY INPUT SYSTEM" shown below.

- AV control unit functions by transmitting/receiving data one by one with each unit (slave unit) that configures them completely as a master unit by connecting between units that configure MULTI AV system with two AV communication lines (H, L).
- Two AV communication lines (H, L) adopt a twisted pair line that is resistant to noise.
- AV control unit is connected by CAN communication, and it receives data signals from ECM and combination meter. It computes and displays fuel economy information value with the obtained information. Transmitting/receiving of data signals are performed by BCM. Also, it transmits the required signal of vehicle setting and receives the response signal.
- AV control unit is connected with front display unit and serial communication, and it transmits the required signal of display and display control and receives the response signal from front display unit. It is also connected with satellite radio by serial communication, transmits the operating signal and receives the display signal.

NOTE:

AV control unit can perform CONSULT-III self-operating function and on board self-diagnosis.

- CONSULT-III self-diagnosis: refer to [AV-83, "CONSULT-III Function \(MULTI AV\)"](#).
- On board self-diagnosis: refer to [AV-70, "Diagnosis Description"](#).

On board self-diagnosis of TEL adapter unit can be performed.

- Refer to [AV-87, "Diagnosis Description"](#) for on board self-diagnosis.

AUXILIARY INPUT SYSTEM

- Image and sound can be output from an external device by connecting a device with auxiliary input jacks.
- Operation can be performed with multifunction switch and steering switch. Multifunction switch transmits operation signal to AV control unit by AV communication.

Without DVD Entertainment System

- The AUX image signal is input from the auxiliary input jacks to the AV control unit. The AV control unit outputs AUX image signal to the front display unit.

MULTI AV SYSTEM

< FUNCTION DIAGNOSIS >

[BOSE AUDIO WITHOUT NAVIGATION]

- The AUX sound signal is input from the auxiliary input jacks to the AV control unit. The AV control unit outputs the AUX sound signal to BOSE amp. The BOSE amp. outputs the AUX sound signal to woofer and each speaker.

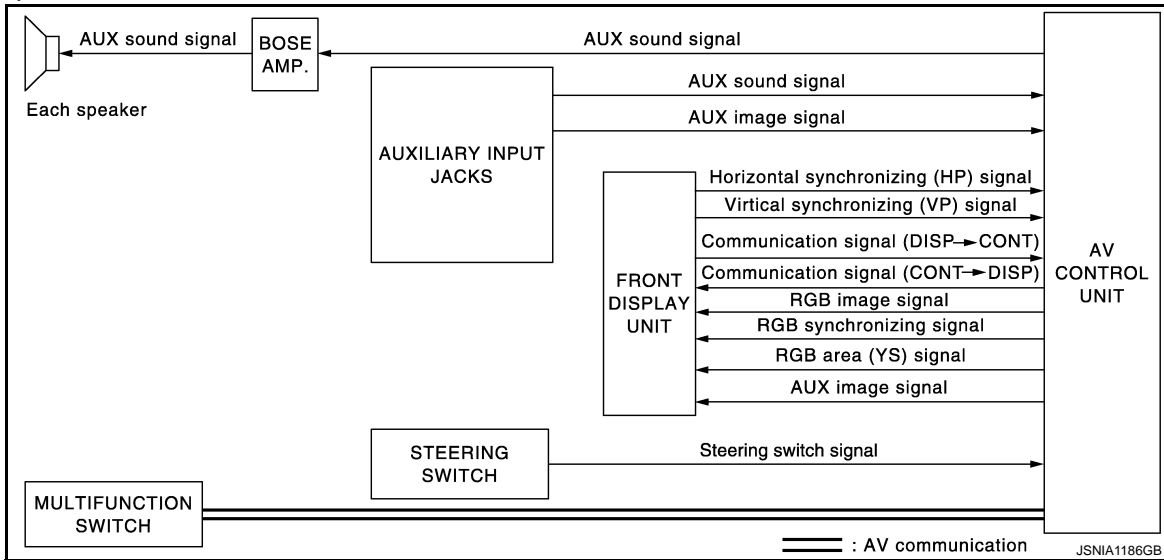

With DVD Entertainment System

- The AUX sound signal input from the external input device is transmitted from auxiliary input jacks to DVD player. DVD player transmits it to AV control unit. AV control unit transmits the AUX sound signal to BOSE amp. The BOSE amp. outputs the AUX sound signal to woofer and each speaker.
- The AUX image signal input from the external input device is transmitted to the video distributor. The video distributor transmits the AUX image signal to the AV control unit and rear display unit.

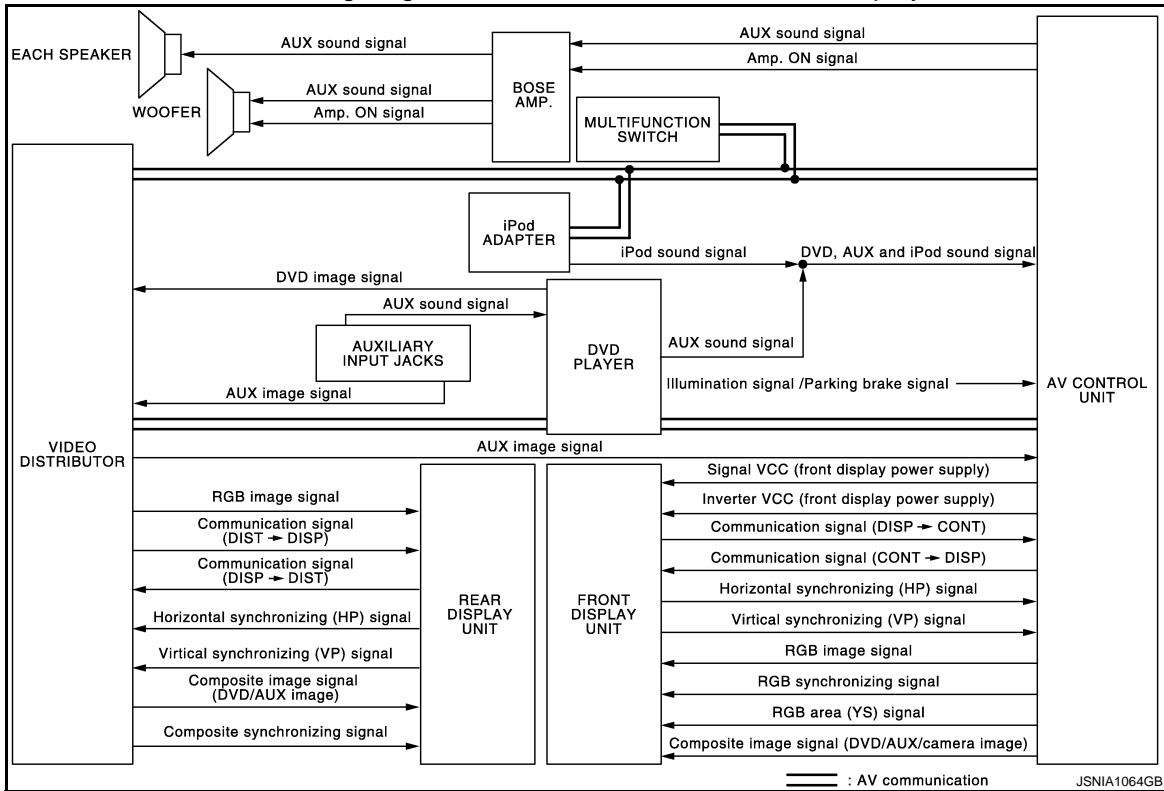

MULTI AV SYSTEM

[BOSE AUDIO WITHOUT NAVIGATION]

< FUNCTION DIAGNOSIS >

Component Parts Location

INFOID:000000003356750

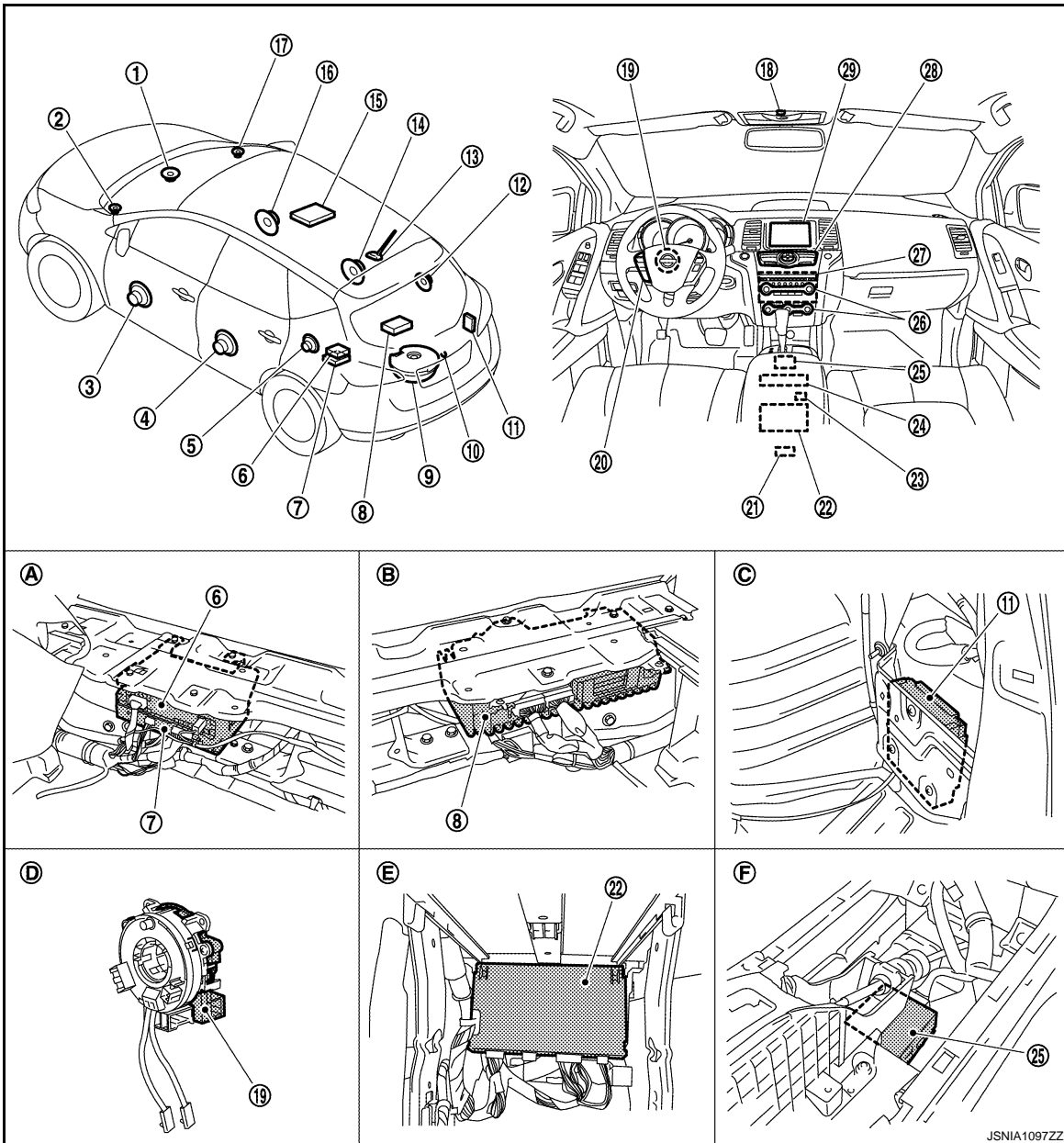

- | | | |
|---|--|--|
| 1. Center speaker | 2. Front squawker LH | 3. Front door speaker LH |
| 4. Rear door speaker LH | 5. Rear speaker LH | 6. Satellite radio tuner |
| 7. TEL adapter unit | 8. BOSE amp. | 9. Woofer |
| 10. Rear view camera | 11. Camera control unit | 12. Rear speaker RH |
| 13. Antenna base (antenna amp. and satellite antenna) | 14. Rear door speaker RH | 15. Rear display unit |
| 16. Front door speaker RH | 17. Front squawker RH | 18. Microphone |
| 19. Steering angle sensor | 20. Steering switch | 21. Auxiliary input jacks |
| 22. Video distributor | 23. iPod connector | 24. DVD player |
| 25. iPod adapter | 26. Preset switch | 27. AV control unit |
| 28. Multifunction switch | 29. Front display unit | |
| A. Luggage floor finisher is removed condition | B. Luggage floor finisher is removed condition | C. Luggage side finisher lower RH is removed condition |
| D. Spiral cable part | E. Console rear finisher is removed condition | F. Console finisher is removed condition |

A
B
C
D
E
F
G
H
I
J
K
L
M

AV

MULTI AV SYSTEM

[BOSE AUDIO WITHOUT NAVIGATION]

< FUNCTION DIAGNOSIS >

Component Description

INFOID:000000003356751

Part name	Description
AV CONTROL UNIT	<ul style="list-style-type: none"> • It is the master unit of the MULTI AV system, and it is connected to each control unit by communication. It operates each system according to communication signals from the AV control unit. • AV control unit includes audio function and vehicle information function. • It is connected to ECM, A/C auto amp. and combination meter via CAN communication to obtain necessary information for the vehicle information function. • It is connected to BCM via CAN communication transmitting/receiving for the vehicle settings function. • It inputs the illumination signals that are required for the display dimming control. • It inputs the signals for driving status recognition (vehicle speed, reverse and parking brake). • The camera image signal is input from the camera control unit. The AV control unit outputs camera image signal to the front display unit. • BOSE amp. ON signal and sound signal are transmitted to BOSE amp. • Power (signal VCC and inverter VCC) is transmitted to front display unit. Without DVD entertainment system • Auxiliary image and auxiliary sound signals are input from the auxiliary input jacks. With DVD entertainment system • Composite image signal (auxiliary and DVD images) is input from the video distributor. • Sound signal (DVD and auxiliary sounds) is input from the DVD player.
VIDEO DISTRIBUTOR	<ul style="list-style-type: none"> • It receives the image signal from the DVD player, and auxiliary input jack, and then transmits it to the AV control unit and rear display unit. • Composite synchronize signal is output to rear display unit. • It transmits the headphone ON signal to the rear display unit, and then receives the remote controller operation signal from the rear display unit.
FRONT DISPLAY UNIT	<ul style="list-style-type: none"> • Front display image is controlled by the serial communication from AV control unit. • It receives the power (signal VCC and inverter VCC) from the AV control unit and operates. • RGB image signal is input from AV control unit (RGB, RGB area and RGB synchronizing). • Synchronizing signal (HP, VP) is output to AV control unit. • Camera image signal is input from AV control unit. Without DVD entertainment system • Auxiliary image signal is input from AV control unit. With DVD entertainment system • Composite image signal (auxiliary and DVD images) is input from the AV control unit.
REAR DISPLAY UNIT	<ul style="list-style-type: none"> • The rear display unit has functions of remote control receiver and headphone amp. • Transmits the headphone sound signal when receiving headphone ON signal from the video distributor. • Headphone sound signal is input from DVD player via wiring harnesses and outputs the signal to headphones via infrared wireless communication. • Receives the operation signal from the remote controller and transmits the signal to the video distributor via serial communication. • Rear display image is controlled by the serial communication from video distributor. • RGB image signal is input from video distributor (RGB image and RGB area). Composite image signal (DVD and auxiliary images) is input from the video distributor. • Synchronize signal (HP, VP) is output to video distributor.
DVD PLAYER	<ul style="list-style-type: none"> • It transmits the playback DVD image signal to the video distributor. • It transmits the playback DVD sound signal to the AV control unit. • It also transmits the input AUX sound signal to the AV control unit.

MULTI AV SYSTEM

< FUNCTION DIAGNOSIS >

[BOSE AUDIO WITHOUT NAVIGATION]

Part name	Description	
BOSE AMP.	<ul style="list-style-type: none"> Inputs power (amp. ON) and sound signal from AV control unit, and outputs sound signal to woofer and each speaker. Woofer amp. ON signal is transmitted to woofer. 	A
WOOFER	<ul style="list-style-type: none"> Composed of two woofers and a woofer amp. Inputs power (amp. ON) and sound signal from BOSE amp. Outputs low frequency sound. 	B
FRONT DOOR SPEAKER	<ul style="list-style-type: none"> Outputs sound signal from BOSE amp. Outputs sound (mid and low range). 	C
REAR DOOR SPEAKER	<ul style="list-style-type: none"> Outputs sound signal from BOSE amp. Outputs sound (mid and low range). 	D
FRONT SQUAWKER	<ul style="list-style-type: none"> Outputs sound signal from BOSE amp. Outputs sound (high and mid range). 	E
REAR SPEAKER	<ul style="list-style-type: none"> Outputs sound signal from BOSE amp. Outputs sound (high and mid range). 	F
CENTER SPEAKER	<ul style="list-style-type: none"> Outputs sound signal from BOSE amp. Outputs sound (high and mid range). 	F
MULTIFUNCTION SWITCH	<ul style="list-style-type: none"> Operation panel is equipped with the centralized switch where audio and auxiliary input operations are integrated. The multifunction switch is connected to the preset switch by wiring harness, and it transmits the operation signal to the preset switch. 	G
PRESET SWITCH	<ul style="list-style-type: none"> Operation panel is equipped with the centralized switch where audio and air conditioner operations are integrated. The preset switch is connected via AV communication, and it transmits the operation signals of the preset switch and multifunction switch. The disk ejection operating signal is performed by wiring harness. 	H
STEERING SWITCH	<ul style="list-style-type: none"> Operations such as audio and hands-free phone are possible. Steering switch signal (operation signal) is output to AV control unit. 	I
MICROPHONE	<ul style="list-style-type: none"> Used only when hands-free phone is operated. Outputs Mic. signal (TEL voice signal) to the TEL adapter unit. The power (Mic. power supply) is supplied from the TEL adapter unit. 	J
AUXILIARY INPUT JACKS	<p>Without DVD entertainment system</p> <ul style="list-style-type: none"> The image signal of the auxiliary input is output via the AV control unit to the front display, and it outputs the sound signal to the AV control unit. <p>With DVD entertainment system</p> <ul style="list-style-type: none"> The AUX image signal of the auxiliary input is output via the video distributor to the AV control unit and rear display unit, and it outputs the AUX sound signal to the DVD player. 	K
ANTENNA BASE	<p>An antenna base integrated with radio antenna amp. and satellite radio antenna is adopted.</p> <p>ANTENNA AMP.</p> <ul style="list-style-type: none"> Radio signal received by rod antenna is amplified and transmitted to AV control unit. <p>SATELLITE RADIO ANTENNA</p> <ul style="list-style-type: none"> Power (antenna amp. ON signal) is supplied from AV control unit. Receives the satellite radio wave and outputs it to the satellite radio tuner. 	M
CAMERA CONTROL UNIT	<ul style="list-style-type: none"> Camera image signal is input from rear view camera. Camera image signal output to AV control unit. Power (camera ON signal) is transmitted to rear view camera. AV control unit recognizes the presence of camera system with camera connection recognition signal. Camera control unit is connected via AV communication. 	O
REAR VIEW CAMERA	<ul style="list-style-type: none"> The image of vehicle rear view is transmitted to camera control unit. It receives the power (camera ON signal) from the camera control unit and operates. 	P
STEERING ANGLE SENSOR	Steering signal necessary for possible route line control is transmitted to camera control unit.	

AV

MULTI AV SYSTEM

< FUNCTION DIAGNOSIS >

[BOSE AUDIO WITHOUT NAVIGATION]

Part name	Description
TEL ADAPTER UNIT	<ul style="list-style-type: none">• Inputs the TEL voice signal from TEL antenna and outputs it to the AV control unit.• It is connected with the AV control unit via AV communication and controlled with the AV control unit.
TEL ANTENNA	Receives the TEL voice signal and outputs it to the TEL adapter unit.
SATELLITE RADIO TUNER	<ul style="list-style-type: none">• Inputs the satellite radio signal from satellite radio antenna and outputs the sound signal to the AV control unit.• It is controlled with the AV control unit and serial communication (communication signal and request signal).
iPod ADAPTER	<ul style="list-style-type: none">• Inputs iPod sound signal from iPod[®], and outputs iPod sound signal to AV control unit.• Receiving/transmitting of iPod[®] operation signals are performed as follows:<ul style="list-style-type: none">- between AV control unit and iPod adapter: AV communication.- between iPod[®] and iPod adapter: serial communication.

REAR VIEW MONITOR SYSTEM

[BOSE AUDIO WITHOUT NAVIGATION]

< FUNCTION DIAGNOSIS >

REAR VIEW MONITOR SYSTEM

System Diagram

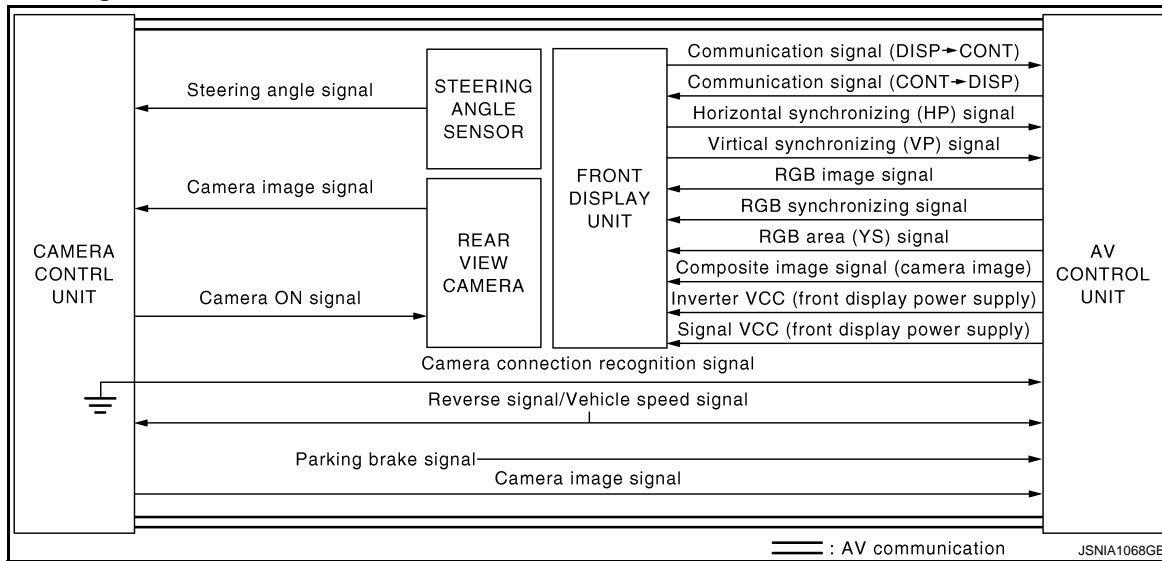

System Description

INFOID:000000003416490

CAMERA IMAGE OPERATION PRINCIPLE

- Power is supplied to rear view camera from camera control unit and outputs camera image signal to camera control unit when selector lever is set to R position and the reverse signal on camera control unit is input.
- Camera control unit synthesizes guide lines and possible route lines with camera image signal from rear view camera, and transmits camera image signal to the AV control unit. In this case, since the reverse signal is also input to AV control unit, the AV control unit recognizes that the selector lever is in the R position, and it switches communication signal between AV control unit and front display unit, and image that is displayed on the front display unit by RGB image signal with rear view monitor image. In addition, possible route lines are controlled by original sensor signal from steering angle sensor.
- The AV control unit determines whether rear view camera is equipped or not, based on the presence of camera connection recognition signal. It switches to rear view monitor image at the time of reverse signal input when it is equipped.
- Warning message under the rear view monitor display is described by AV control unit.
- AV control unit is connected in communication with camera control unit and front display unit, and it controls operation of rear view monitor system.

A
B
C
D
E
F
G
H
I
J
K
L
M
O
P

AV

REAR VIEW MONITOR SYSTEM

[BOSE AUDIO WITHOUT NAVIGATION]

< FUNCTION DIAGNOSIS >

Component Parts Location

INFOID:000000003464493

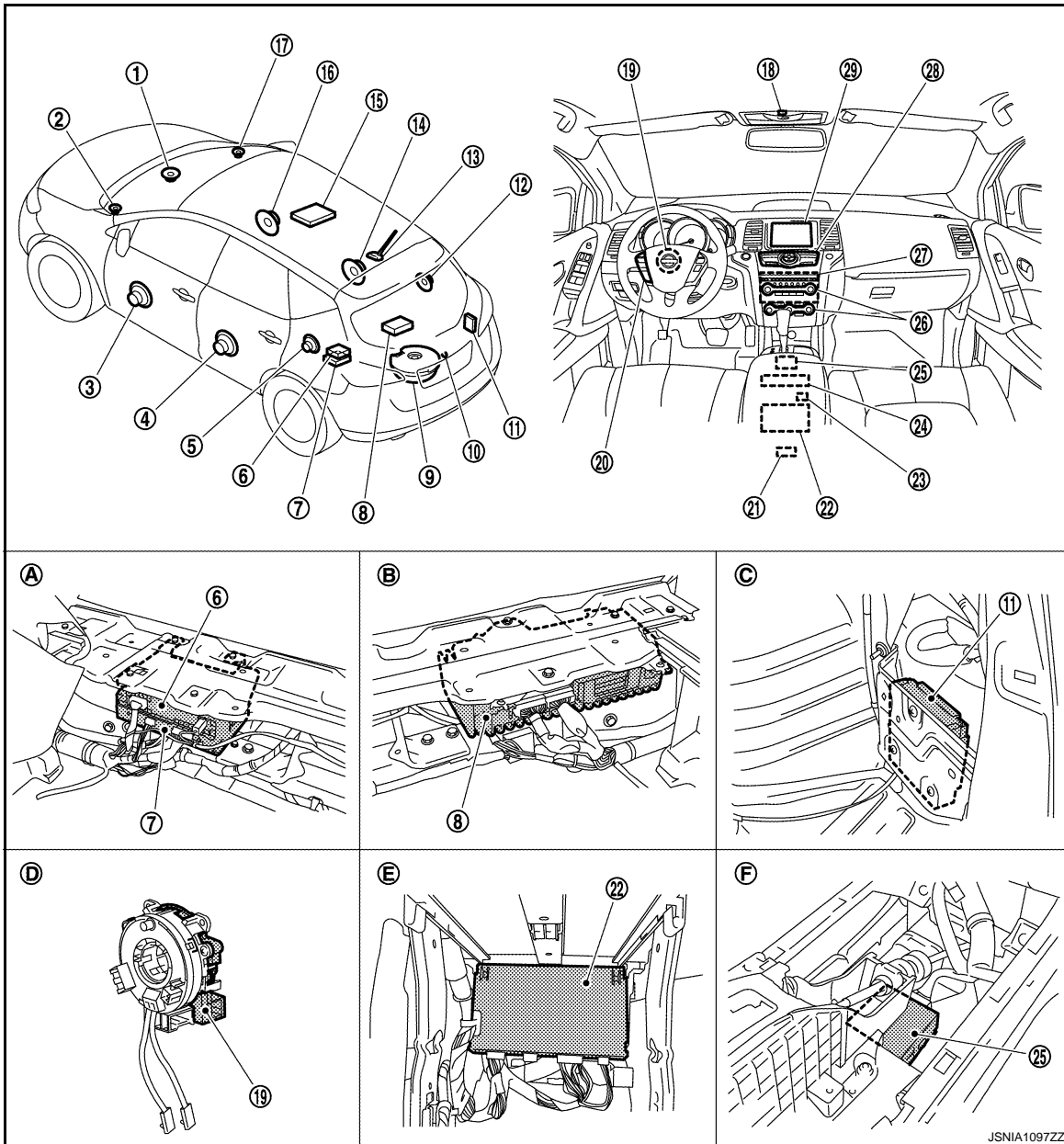

- | | | |
|---|--|--|
| 1. Center speaker | 2. Front squawker LH | 3. Front door speaker LH |
| 4. Rear door speaker LH | 5. Rear speaker LH | 6. Satellite radio tuner |
| 7. TEL adapter unit | 8. BOSE amp. | 9. Woofer |
| 10. Rear view camera | 11. Camera control unit | 12. Rear speaker RH |
| 13. Antenna base (antenna amp. and satellite antenna) | 14. Rear door speaker RH | 15. Rear display unit |
| 16. Front door speaker RH | 17. Front squawker RH | 18. Microphone |
| 19. Steering angle sensor | 20. Steering switch | 21. Auxiliary input jacks |
| 22. Video distributor | 23. iPod connector | 24. DVD player |
| 25. iPod adapter | 26. Preset switch | 27. AV control unit |
| 28. Multifunction switch | 29. Front display unit | |
| A. Luggage floor finisher is removed condition | B. Luggage floor finisher is removed condition | C. Luggage side finisher lower RH is removed condition |
| D. Spiral cable part | E. Console rear finisher is removed condition | F. Console finisher is removed condition |

REAR VIEW MONITOR SYSTEM

[BOSE AUDIO WITHOUT NAVIGATION]

< FUNCTION DIAGNOSIS >

INFOID:000000003416492

Component Description

Part name	Description
AV CONTROL UNIT	<ul style="list-style-type: none"> • Camera image signal is input from camera control unit, and it is output to front display unit when input reverse signal. • Image on display is changed to rear view monitor with the communication for AV control unit and front display unit. • Warning displayed in rear view monitor image is illustrated.
FRONT DISPLAY UNIT	<ul style="list-style-type: none"> • Camera image signal is input from AV control unit. • RGB image signal for warning display is input from AV control unit. • Rear view monitor image is changed with the serial communication for AV control unit.
CAMERA CONTROL UNIT	<ul style="list-style-type: none"> • Camera image signal is input from rear view camera. Camera image signal output to AV control unit. • Power (camera ON signal) is transmitted to rear view camera. • AV control unit recognizes the presence of camera system with camera connection recognition signal. • Camera control unit is connected via AV communication.
REAR VIEW CAMERA	<ul style="list-style-type: none"> • The image of vehicle rear view is transmitted to camera control unit. • It receives the power (camera ON signal) from the camera control unit and operates.
STEERING ANGLE SENSOR	Steering signal necessary for possible route line control is transmitted to camera control unit.

A
B
C
D
E
F
G
H
I
J
K
L
M

AV

O
P

AUDIO SYSTEM

< FUNCTION DIAGNOSIS >

[BOSE AUDIO WITHOUT NAVIGATION]

AUDIO SYSTEM

System Diagram

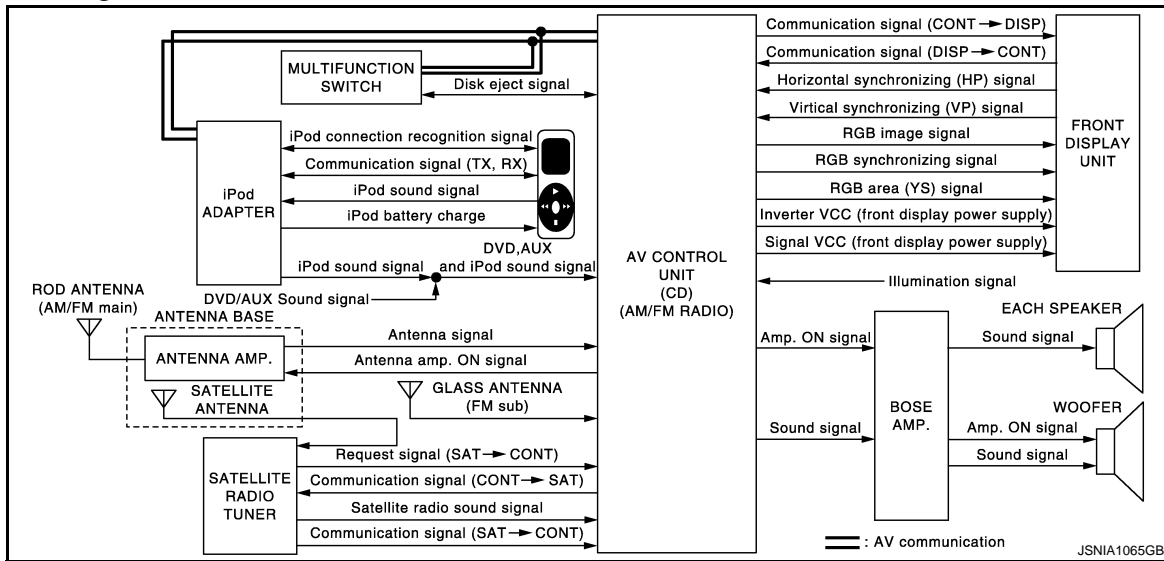

INFOID:000000003356752

NOTE:

- Woofer, illustrated in the above figure, integrates two woofers and a woofer amp.
- In this section, PRESET SWITCH and MULTIFUNCTION SWITCH are written as the MULTIFUNCTION SWITCH.
- An antenna base integrated with radio antenna amp. and satellite radio antenna is adopted.

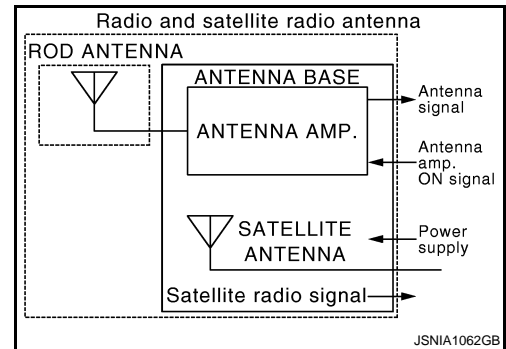

JSNIA1062GB

System Description

INFOID:000000003356753

The audio system is equipped with the following functions. Each function can be operated with the multifunction switch, preset switch or steering switch. It indicates the operation status of AUDIO to the front display unit.

Function
AM/FM radio
Satellite radio
CD mode
iPod connection
AUX mode
DVD mode

FUNCTION DESCRIPTION

Operating Signal

- Audio system operation can be performed with multifunction switch, preset switch, and steering switch.
- Operating signal is transmitted to AV control unit with AV communication when it is operated by multifunction switch or preset switch. The disk ejection operating signal is performed by wiring harness.
- Operating signal is transmitted to AV control unit with steering switch signal when it is operated by steering switch.

AUDIO SYSTEM

< FUNCTION DIAGNOSIS >

[BOSE AUDIO WITHOUT NAVIGATION]

Screen Front Display

- The display switching of the screen is performed with the serial communication signal between the front display unit and the AV control unit.
- The image signal to display operating condition is performed with RGB image signal, RGB area signal and RGB image synchronizing signal.

AM/FM Radio Mode

- AM/FM radio tuner is built into AV control unit.
- AM/FM radio wave is received by rod antenna, next it is amplified by antenna amp., and finally it is input to AV control unit. The FM sub antenna is installed on the back door window glass and the AV control unit is received.
- Audio signal is input to BOSE amp. and BOSE amp. outputs to woofer and each speaker for AV control unit.

Satellite Radio Mode

- Satellite radio tuner is controlled by serial communication and request signal with AV control unit.
- Satellite radio wave is received by satellite radio antenna, and it is input to satellite radio tuner. Satellite radio tuner outputs satellite radio sound signal to AV control unit. AV control unit outputs satellite radio sound signal to BOSE amp. and BOSE amp. outputs the sound signal to each speaker and woofer.

CD Mode

- CD function is built into AV control unit.
- AV control unit outputs audio signal to BOSE amp. and BOSE amp. outputs to woofer and each speaker when CD is inserted to AV control unit.

iPod Connection

- Connect iPod® and iPod adapter with wire harness and iPod adapter input iPod sound signal from iPod®. When iPod mode is selected, iPod adapter output iPod sound signal to AV control unit. AV control unit output sound signal to BOSE amp., and BOSE amp. output sound signal to woofer and each speaker.
- Receiving/transmitting of iPod® operation signals are performed as follows:
 - between AV control unit and iPod adapter: AV communication.
 - between iPod® and iPod adapter: serial communication.
- The iPod® connection status can be recognized if iPod adapter receives iPod connection recognition signal.
- The iPod adapter can charge iPod®.

AUX Mode

Refer to [AV-51. "System Description"](#).

DVD Mode

Refer to [AV-64. "System Description"](#).

A
B
C
D
E
F
G
H
I
J
K
L
M

AV

O
P

AUDIO SYSTEM

[BOSE AUDIO WITHOUT NAVIGATION]

< FUNCTION DIAGNOSIS >

Component Parts Location

INFOID:000000003464494

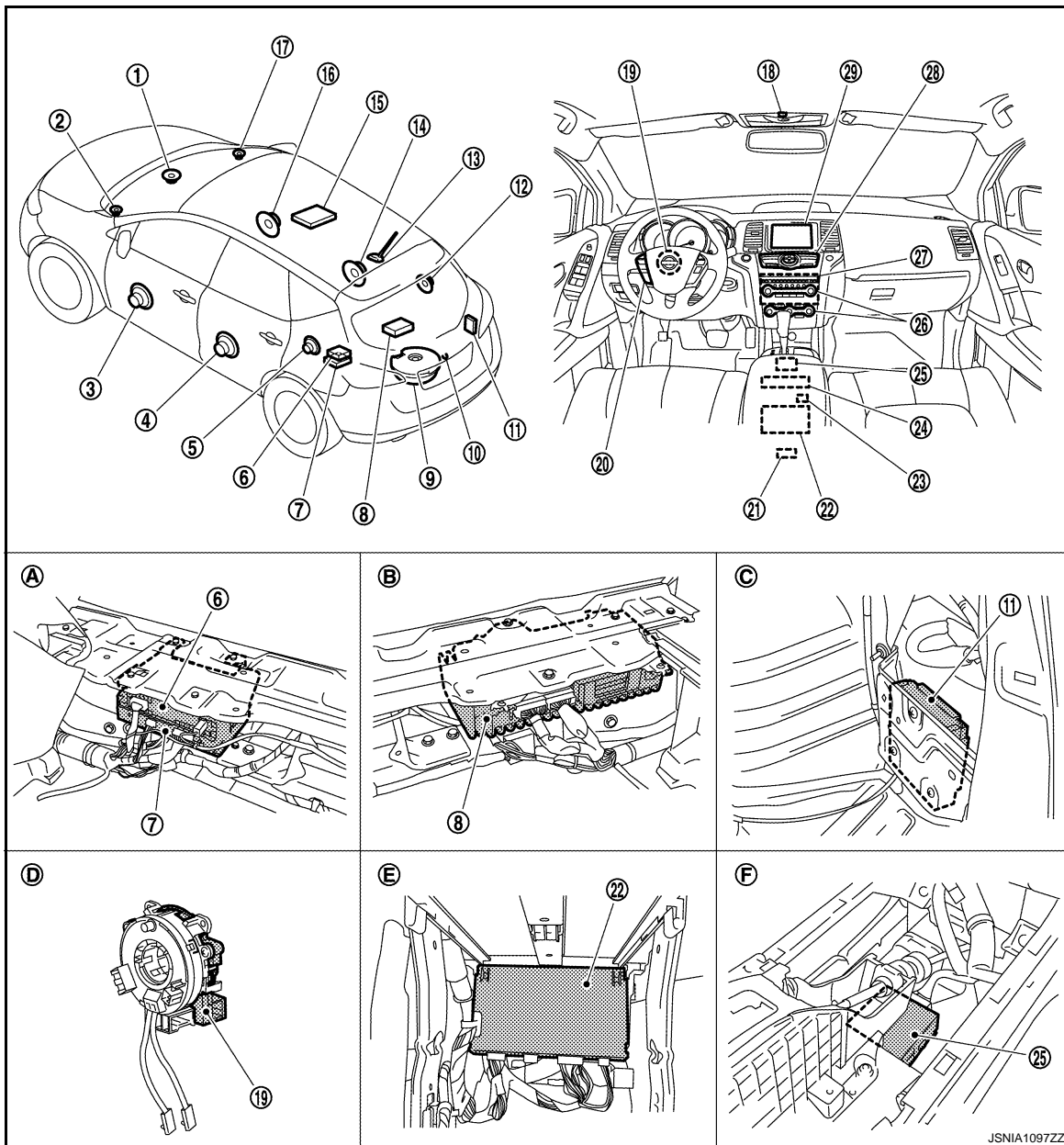

- | | | |
|---|--|--|
| 1. Center speaker | 2. Front squawker LH | 3. Front door speaker LH |
| 4. Rear door speaker LH | 5. Rear speaker LH | 6. Satellite radio tuner |
| 7. TEL adapter unit | 8. BOSE amp. | 9. Woofer |
| 10. Rear view camera | 11. Camera control unit | 12. Rear speaker RH |
| 13. Antenna base (antenna amp. and satellite antenna) | 14. Rear door speaker RH | 15. Rear display unit |
| 16. Front door speaker RH | 17. Front squawker RH | 18. Microphone |
| 19. Steering angle sensor | 20. Steering switch | 21. Auxiliary input jacks |
| 22. Video distributor | 23. iPod connector | 24. DVD player |
| 25. iPod adapter | 26. Preset switch | 27. AV control unit |
| 28. Multifunction switch | 29. Front display unit | |
| A. Luggage floor finisher is removed condition | B. Luggage floor finisher is removed condition | C. Luggage side finisher lower RH is removed condition |
| D. Spiral cable part | E. Console rear finisher is removed condition | F. Console finisher is removed condition |

AUDIO SYSTEM

[BOSE AUDIO WITHOUT NAVIGATION]

< FUNCTION DIAGNOSIS >

Component Description

INFOID:000000003356755

Part name	Description
AV CONTROL UNIT	<ul style="list-style-type: none"> The AM/FM receiving function and the CD playing function are equipped. BOSE amp. ON signal and sound signal are transmitted to BOSE amp.
FRONT DISPLAY UNIT	<ul style="list-style-type: none"> Front display image is controlled by the serial communication from AV control unit. RGB image signal (audio operation condition) is input from AV control unit.
BOSE AMP.	<ul style="list-style-type: none"> Inputs power (amp. ON) and sound signal from AV control unit, and outputs sound signal to woofer and each speaker. Woofer amp. ON signal is transmitted to woofer.
WOOFER	<ul style="list-style-type: none"> Composed of two woofers and a woofer amp. Inputs power (amp. ON) and sound signal from BOSE amp. Outputs low frequency sound.
FRONT DOOR SPEAKER	<ul style="list-style-type: none"> Outputs sound signal from BOSE amp. Outputs sound (mid and low range).
REAR DOOR SPEAKER	<ul style="list-style-type: none"> Outputs sound signal from BOSE amp. Outputs sound (mid and low range).
FRONT SQUAWKER	<ul style="list-style-type: none"> Outputs sound signal from BOSE amp. Outputs sound (high and mid range).
REAR SPEAKER	<ul style="list-style-type: none"> Outputs sound signal from BOSE amp. Outputs sound (high and mid range).
CENTER SPEAKER	<ul style="list-style-type: none"> Outputs sound signal from BOSE amp. Outputs sound (high and mid range).
MULTIFUNCTION SWITCH	<ul style="list-style-type: none"> Operation panel is equipped with the centralized switch where audio and auxiliary input operations are integrated. The multifunction switch is connected to the preset switch by wiring harness, and it transmits the operation signal to the preset switch.
PRESET SWITCH	<ul style="list-style-type: none"> Operation panel is equipped with the centralized switch where audio and air conditioner operations are integrated. The preset switch is connected via AV communication, and it transmits the operation signals of the preset switch and multifunction switch. The disk ejection operating signal is performed by wiring harness.
STEERING SWITCH	<ul style="list-style-type: none"> Operations such as audio and hands-free phone are possible. Steering switch signal (operation signal) is output to AV control unit.
ANTENNA BASE	<p>An antenna base integrated with radio antenna amp. and satellite radio antenna is adopted.</p> <p>ANTENNA AMP.</p> <ul style="list-style-type: none"> Radio signal received by rod antenna is amplified and transmitted to AV control unit. Power (antenna amp. ON signal) is supplied from AV control unit. <p>SATELLITE RADIO ANTENNA</p> <ul style="list-style-type: none"> Receives the satellite radio wave and outputs it to the satellite radio tuner.
SATELLITE RADIO TUNER	<ul style="list-style-type: none"> Inputs the satellite radio signal from satellite radio antenna and outputs the sound signal to the AV control unit. It is controlled with the AV control unit and serial communication (communication signal and request signal).
iPod ADAPTER	<ul style="list-style-type: none"> Inputs iPod sound signal from iPod®, and outputs iPod sound signal to AV control unit. Receiving/transmitting of iPod® operation signals are performed as follows: <ul style="list-style-type: none"> between AV control unit and iPod adapter: AV communication. between iPod® and iPod adapter: serial communication.

A

B

C

D

E

F

G

H

I

J

K

L

M

AV

O

P

DVD ENTERTAINMENT SYSTEM

< FUNCTION DIAGNOSIS >

[BOSE AUDIO WITHOUT NAVIGATION]

DVD ENTERTAINMENT SYSTEM

System Diagram

INFOID:000000003416493

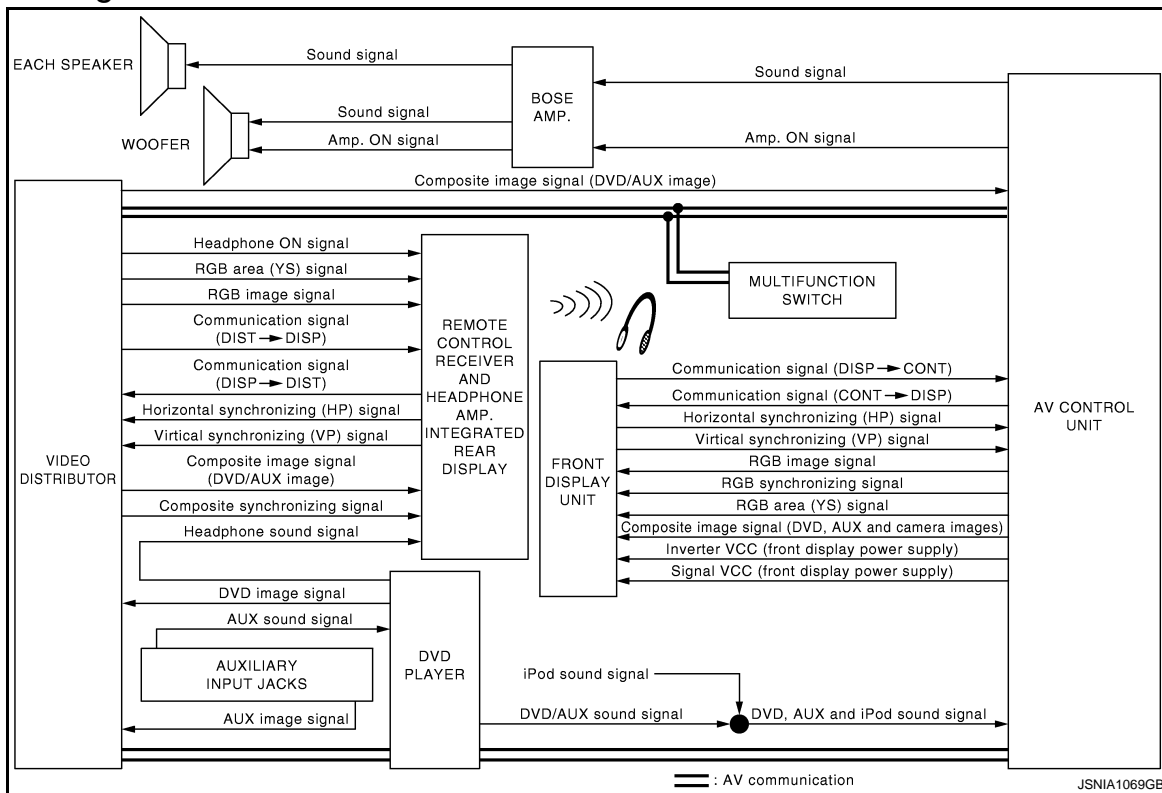

System Description

INFOID:000000003416494

The passengers can enjoy watching DVDs in the rear seat with the rear display unit. They can also listen to a DVD and AUX in the rear seat independently by cordless headphones.

FUNCTION DESCRIPTION

Operating Signal

The mobile entertainment system can be controlled by the rear seat remote controller.

It receives the operation signal of the rear seat remote controller by the rear display unit, and then transmits it to the video distributor.

Screen Rear Display

- Switching of display is performed with serial communication between rear display unit and video distributor.
- The rear display unit receives the DVD/AUX image signal and RGB image signal from the video distributor.

Screen Front Display

- Switching of display is performed with serial communication between front display unit and AV control unit.
- The front display unit receives the DVD/AUX image signal from the AV control unit.
- The front display unit receives the RGB image signal from the AV control unit.

DVD Mode

- The DVD player is connected to the AV control unit via AV communication and controlled by the AV control unit.
- The DVD player sound signal is output to the AV control unit. The AV control unit outputs DVD player sound signal to BOSE amp. The BOSE amp. outputs it to woofer and each speaker.
- The DVD image signal is output to the video distributor. The video distributor outputs it to AV control unit and rear display unit. The AV control unit output DVD image signal to front display unit.

AUX Mode

Refer to [AV-51, "System Description"](#).

DVD ENTERTAINMENT SYSTEM

[BOSE AUDIO WITHOUT NAVIGATION]

< FUNCTION DIAGNOSIS >

Component Parts Location

INFOID:000000003464495

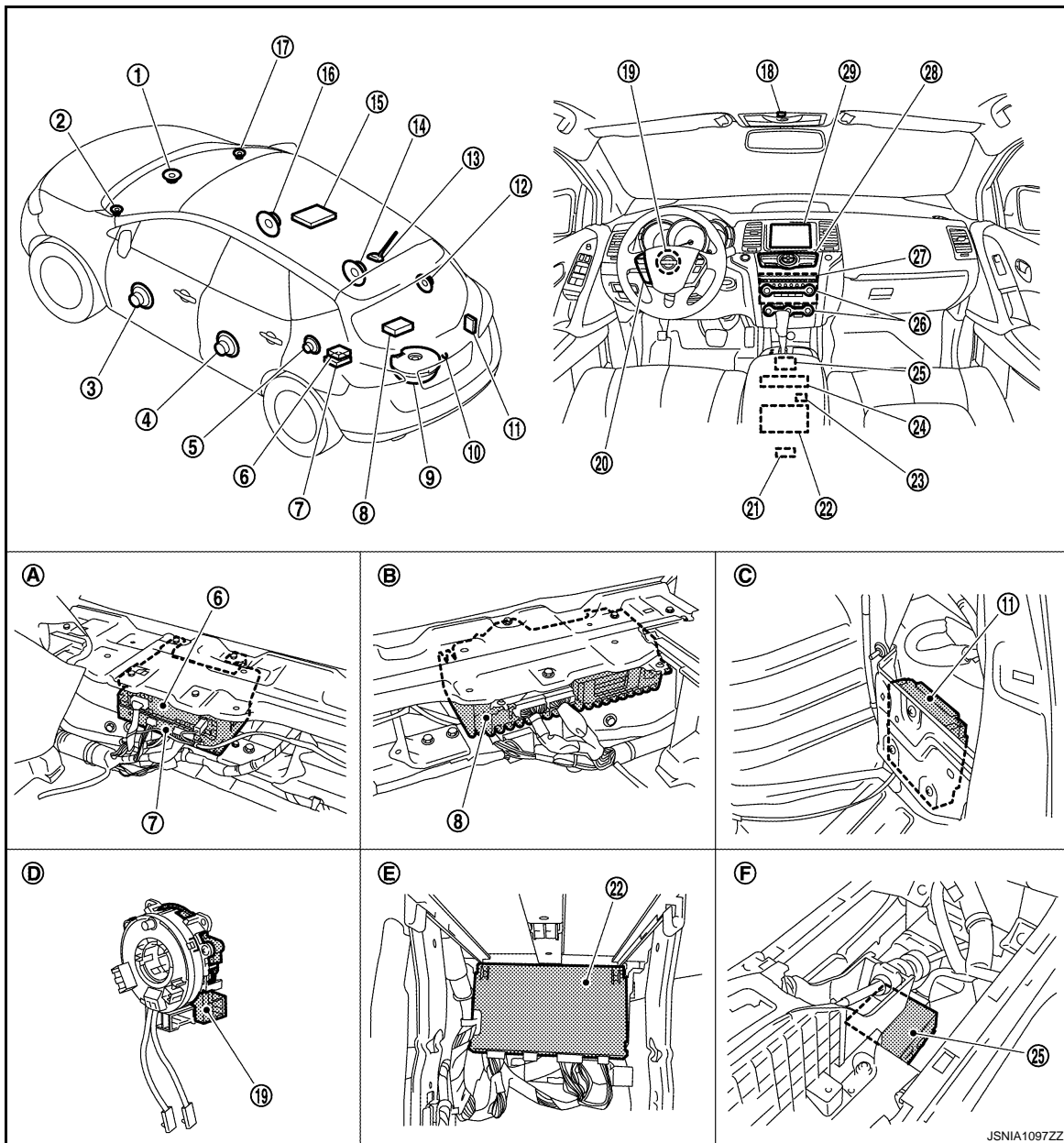

- | | | |
|---|--|--|
| 1. Center speaker | 2. Front squawker LH | 3. Front door speaker LH |
| 4. Rear door speaker LH | 5. Rear speaker LH | 6. Satellite radio tuner |
| 7. TEL adapter unit | 8. BOSE amp. | 9. Woofer |
| 10. Rear view camera | 11. Camera control unit | 12. Rear speaker RH |
| 13. Antenna base (antenna amp. and satellite antenna) | 14. Rear door speaker RH | 15. Rear display unit |
| 16. Front door speaker RH | 17. Front squawker RH | 18. Microphone |
| 19. Steering angle sensor | 20. Steering switch | 21. Auxiliary input jacks |
| 22. Video distributor | 23. iPod connector | 24. DVD player |
| 25. iPod adapter | 26. Preset switch | 27. AV control unit |
| 28. Multifunction switch | 29. Front display unit | |
| A. Luggage floor finisher is removed condition | B. Luggage floor finisher is removed condition | C. Luggage side finisher lower RH is removed condition |
| D. Spiral cable part | E. Console rear finisher is removed condition | F. Console finisher is removed condition |

A
B
C
D
E
F
G
H
I
J
K
L
M

AV

DVD ENTERTAINMENT SYSTEM

[BOSE AUDIO WITHOUT NAVIGATION]

< FUNCTION DIAGNOSIS >

Component Description

INFOID:00000003416496

Part name	Description
AV CONTROL UNIT	<ul style="list-style-type: none"> It is the master unit of the MULTI AV system, and it is connected to each control unit by communication. It operates each system according to communication signals from the AV control unit. AV control unit includes audio function and vehicle information function. It inputs the illumination signals that are required for the display dimming control. It inputs the signals for driving status recognition (vehicle speed, reverse and parking brake). BOSE amp. ON signal and sound signal are transmitted to BOSE amp. Composite image signal (auxiliary and DVD images) is input from the video distributor. Sound signal (DVD and auxiliary sounds) is input from the DVD player.
VIDEO DISTRIBUTOR	<ul style="list-style-type: none"> It receives the image signal from the DVD player, and auxiliary input jack, and then transmits it to the AV control unit and rear display unit. Composite synchronize signal is output to rear display unit. It transmits the headphone ON signal to the rear display unit, and then receives the remote controller operation signal from the rear display unit.
FRONT DISPLAY UNIT	<ul style="list-style-type: none"> Front display image is controlled by the serial communication from AV control unit. RGB image signal is input from AV control unit (RGB, RGB area and RGB synchronizing). Synchronizing signal (HP, VP) is output to AV control unit. Composite image signal (auxiliary and DVD images) is input from the AV control unit.
REAR DISPLAY UNIT	<ul style="list-style-type: none"> The rear display unit has functions of remote control receiver and headphone amp. Transmits the headphone sound signal when receiving headphone ON signal from the video distributor. Headphone sound signal is input from DVD player via wiring harnesses and outputs the signal to headphones via infrared wireless communication. Receives the operation signal from the remote controller and transmits the signal to the video distributor via serial communication. Rear display image is controlled by the serial communication from video distributor. RGB image signal is input from video distributor (RGB image and RGB area). Composite image signal (DVD and auxiliary images) is input from the video distributor. Synchronize signal (HP, VP) is output to the video distributor.
DVD PLAYER	<ul style="list-style-type: none"> It transmits the playback DVD image signal to the video distributor. It transmits the playback DVD sound signal to the AV control unit. It also transmits the input AUX sound signal to the AV control unit.
BOSE AMP.	<ul style="list-style-type: none"> Inputs power (amp. ON) and sound signal from AV control unit, and outputs sound signal to woofer and each speaker. Woofer amp. ON signal is transmitted to woofer.
WOOFER	<ul style="list-style-type: none"> Composed of two woofers and a woofer amp. Inputs power (amp. ON) and sound signal from BOSE amp. Outputs low frequency sound.
FRONT DOOR SPEAKER	<ul style="list-style-type: none"> Outputs sound signal from BOSE amp. Outputs sound (mid and low range).
REAR DOOR SPEAKER	<ul style="list-style-type: none"> Outputs sound signal from BOSE amp. Outputs sound (mid and low range).
FRONT SQUAWKER	<ul style="list-style-type: none"> Outputs sound signal from BOSE amp. Outputs sound (high and mid range).
REAR SPEAKER	<ul style="list-style-type: none"> Outputs sound signal from BOSE amp. Outputs sound (high and mid range).
CENTER SPEAKER	<ul style="list-style-type: none"> Outputs sound signal from BOSE amp. Outputs sound (high and mid range).

HANDS-FREE PHONE SYSTEM

< FUNCTION DIAGNOSIS >

[BOSE AUDIO WITHOUT NAVIGATION]

HANDS-FREE PHONE SYSTEM

System Diagram

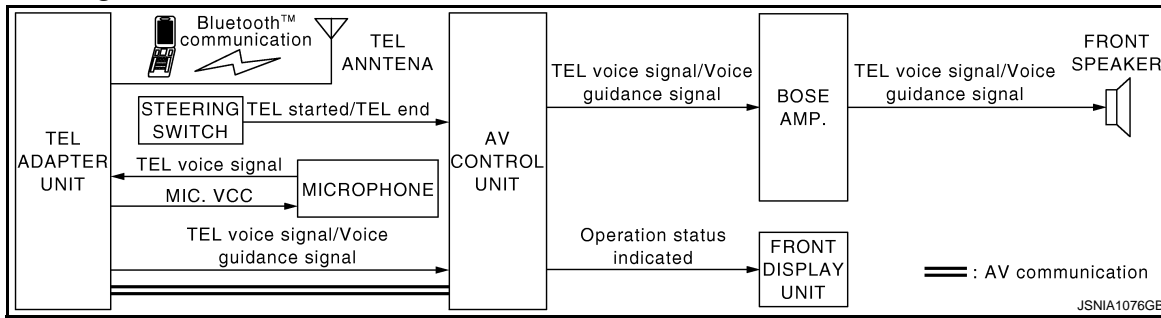

System Description

INFOID:000000003356757

- TEL adapter unit is controlled with AV communication from AV control unit.
- The connection between portable telephone and TEL adapter unit is performed with Bluetooth™ communication.
- The voice guidance signal is input from the TEL adapter unit to the AV control unit and output via BOSE amp. to the front door speaker when operating the cellular phone.
- TEL adapter unit has the on board self-diagnosis function. Refer to [AV-87, "Diagnosis Description"](#).

WHEN RECEIVING A CALL

TEL voice signal received with the portable telephone is input from TEL antenna via TEL adapter unit to AV control unit with Bluetooth™ communication and output via BOSE amp. to the front door speaker. The operation is performed with the steering switch or voice recognition function (TEL operation only).

WHEN A CALL IS TRANSMITTED

Speech sounds (TEL voice signal) are input from the microphone to the TEL adapter unit. It is input from the TEL antenna via Bluetooth™ communication to the portable telephone. It is transmitted to the phone on the other side. The operation is performed with the steering switch or voice recognition function (TEL operation only).

A
B
C
D
E
F
G
H
I
J
K
L
M
O
P

AV

HANDS-FREE PHONE SYSTEM

[BOSE AUDIO WITHOUT NAVIGATION]

< FUNCTION DIAGNOSIS >

Component Parts Location

INFOID:000000003464496

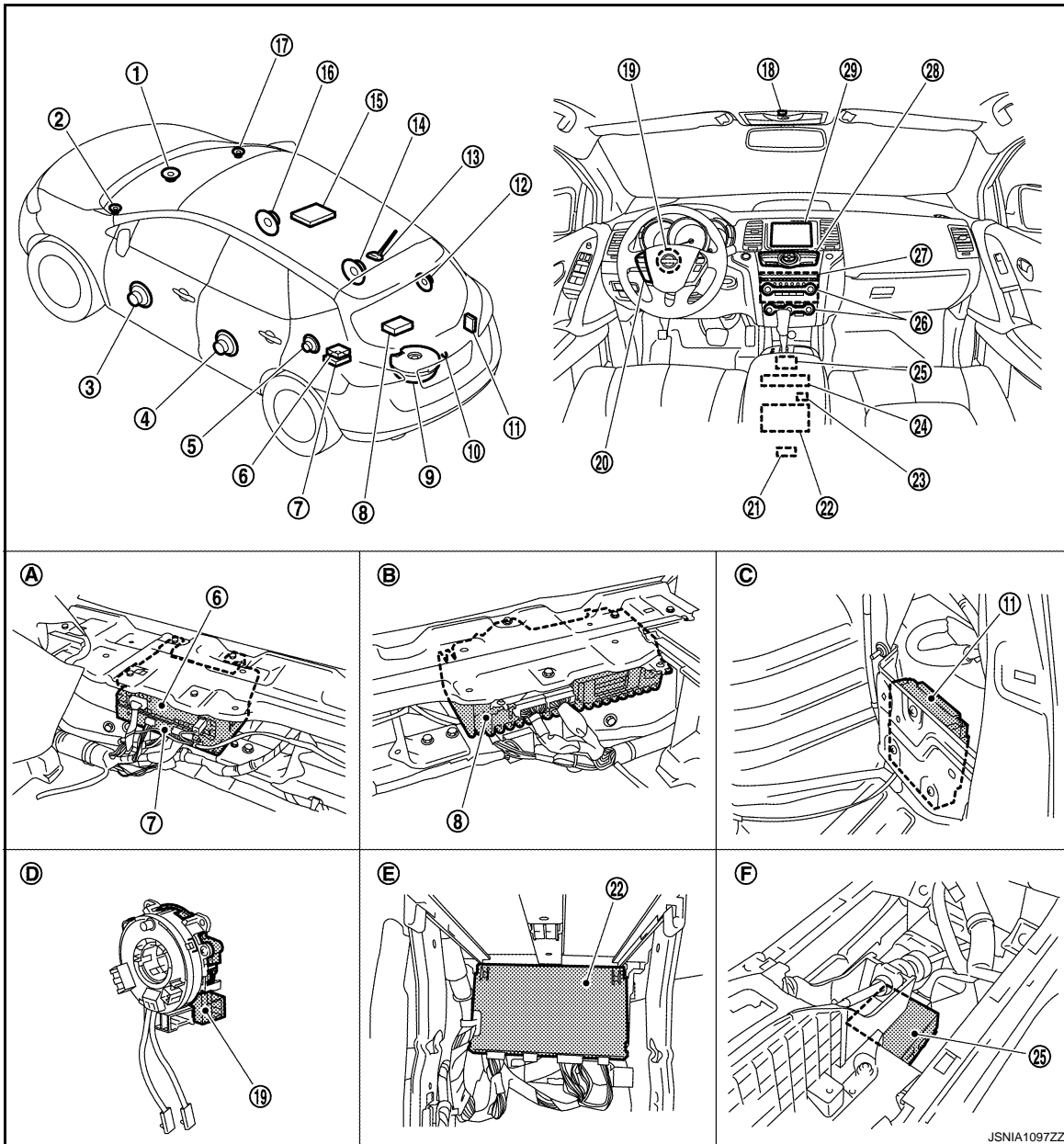

- | | | |
|---|--|--|
| 1. Center speaker | 2. Front squawker LH | 3. Front door speaker LH |
| 4. Rear door speaker LH | 5. Rear speaker LH | 6. Satellite radio tuner |
| 7. TEL adapter unit | 8. BOSE amp. | 9. Woofer |
| 10. Rear view camera | 11. Camera control unit | 12. Rear speaker RH |
| 13. Antenna base (antenna amp. and satellite antenna) | 14. Rear door speaker RH | 15. Rear display unit |
| 16. Front door speaker RH | 17. Front squawker RH | 18. Microphone |
| 19. Steering angle sensor | 20. Steering switch | 21. Auxiliary input jacks |
| 22. Video distributor | 23. iPod connector | 24. DVD player |
| 25. iPod adapter | 26. Preset switch | 27. AV control unit |
| 28. Multifunction switch | 29. Front display unit | |
| A. Luggage floor finisher is removed condition | B. Luggage floor finisher is removed condition | C. Luggage side finisher lower RH is removed condition |
| D. Spiral cable part | E. Console rear finisher is removed condition | F. Console finisher is removed condition |

HANDS-FREE PHONE SYSTEM

[BOSE AUDIO WITHOUT NAVIGATION]

< FUNCTION DIAGNOSIS >

Component Description

INFOID:000000003356759

Part name	Description
AV CONTROL UNIT	<ul style="list-style-type: none"> Inputs TEL voice signal or voice guidance signal from TEL adapter unit and outputs it to BOSE amp. during reception. Connects with TEL adapter unit and AV communication and controls hands free phone system.
FRONT DISPLAY UNIT	<ul style="list-style-type: none"> Display image is controlled by the serial communication from AV control unit. Inputs RGB image signal (RGB, RGB area and RGB synchronizing) from AV control unit and displays the status of hands free phone system.
BOSE AMP.	Inputs TEL voice signal or voice guidance signal from AV control unit and outputs it to front speaker.
FRONT DOOR SPEAKER	Outputs the TEL voice signal or voice guidance signal from BOSE amp.
FRONT SQUAWKER	
PRESET SWITCH	<ul style="list-style-type: none"> Adjust the sound when using hands-free phone system. The operation signal is transmitted to the AV control unit via AV communication.
STEERING SWITCH	<ul style="list-style-type: none"> The hands-free phone system can be operated. Steering switch signal (operation signal) is output to AV control unit.
MICROPHONE	<ul style="list-style-type: none"> Uses when operating the hands-free phone. Outputs Mic. signal (TEL voice signal) to the TEL adapter unit. The power (Mic. power supply) is supplied from the TEL adapter unit.
TEL ADAPTER UNIT	<ul style="list-style-type: none"> Receives the steering switch signal (operation signal) from the steering switch. Inputs the TEL voice signal from TEL antenna during reception and outputs it to the AV control unit. Inputs the TEL voice signal from microphone during speech recognition and outputs it to the TEL antenna. Controlled by AV communication transmitted from AV control unit.
TEL ANTENNA	Connects with the portable telephone via Bluetooth™ and communicates the TEL voice signal.

A
B
C
D
E
F
G
H
I
J
K
L
M

AV

O
P

DIAGNOSIS SYSTEM (AV CONTROL UNIT)

< FUNCTION DIAGNOSIS >

[BOSE AUDIO WITHOUT NAVIGATION]

DIAGNOSIS SYSTEM (AV CONTROL UNIT)

Diagnosis Description

INFOID:000000003356760

MULTIFUNCTION SWITCH AND PRESET SWITCH SELF-DIAGNOSIS FUNCTION

The ON/OFF operation (continuity) of each switch in the multifunction switch and preset switch can be checked.

Self-Diagnosis Mode

- Press the “BACK” switch and the “▲” switch of the 8-direction switches within 10 seconds after turning the ignition switch from OFF to ACC and hold them for 3 seconds or more. Then the buzzer sounds, all indicators of the preset switch illuminate, and the self-diagnosis mode starts.
- The continuity of each switch at the ON position can be checked by pressing the switch. The buzzer sounds if the switch is normal.

NOTE:

The disk eject switch cannot be checked.

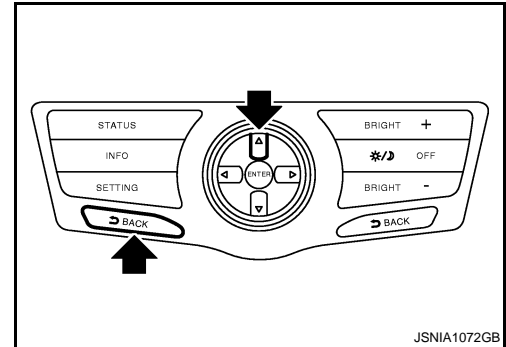

JSNIA1072GB

Finishing Self-diagnosis Mode

Self-diagnosis mode is canceled when the ignition switch is turned OFF.

MULTI AV SYSTEM ON BOARD DIAGNOSIS FUNCTION

- The AV control unit diagnosis function starts up with multifunction switch operation and the AV control unit performs a diagnosis for each unit in the system during the on board diagnosis.
- Perform a CONSULT-III diagnosis if the on board diagnosis does not start, e.g., if the screen does not display anything, the multifunction switch does not function, etc.

ON BOARD DIAGNOSIS

Description

- The trouble diagnosis function has a self-diagnosis mode for conducting trouble diagnosis automatically and a confirmation/adjustment mode for operating manually.
- Self-diagnosis mode performs the AV control unit diagnosis and the connection diagnosis between each of the units that make up the system, and it indicates the results to the display.
- The confirmation/adjustment mode allows the technician to check, modify or adjust the vehicle signals and set values, as well as to monitor the system error records and system communication status. The checking, modifying or adjusting generally requires human intervention and judgment (the system cannot make judgment automatically).

On Board Diagnosis Item

Mode	Description
Self-Diagnosis	<ul style="list-style-type: none">• AV control unit diagnosis• Perform the connection diagnosis between each of the units.

DIAGNOSIS SYSTEM (AV CONTROL UNIT)

[BOSE AUDIO WITHOUT NAVIGATION]

< FUNCTION DIAGNOSIS >

	Mode	Description
Confirmation/ Adjustment	Display Diagnosis	The confirmation of the tint with the color spectrum bar display and shading of color with the gradation bar display can be performed.
	Vehicle Signals	Diagnosis of signals can be performed for vehicle speed, parking brake, lights, ignition switch, and reverse.
	Speaker Test	The connection of a speaker can be confirmed by test tone.
	Climate Control*	Not used.
	Error History	System malfunctions and the frequency when occurring in the past are displayed. When the malfunctioning item is selected, the time and place that the selected malfunction last occurred are displayed.
	Camera Cont.	The signal connected to camera control unit can be checked and the guiding line position that overlaps rear view camera image can be adjusted.
	Vehicle CAN Diagnosis	The transmitting/receiving of CAN communication can be monitored.
	AV COMM Diagnosis	The communication condition of each unit of MULTI AV system can be monitored.
	Delete Unit Connection Log	Erase the connection history of unit and error history
	Initialize Settings	Initializes the AV control unit memory.

NOTE:

*: On-board self-diagnosis is not supported. Only CONSULT-III is supported.

STARTING PROCEDURE

1. Start the engine.
2. Turn the audio system OFF.
3. While pressing the "SETTING" button, turn the volume control dial clockwise or counterclockwise for 40 clicks or more. (When the self-diagnosis mode is started, a short beep will be heard.)
 - Shifting from current screen to previous screen is performed by pressing the "BACK" button.
4. The trouble diagnosis initial screen is displayed, and then the items of "Self Diagnosis" and "Confirmation/Adjustment" can be selected.

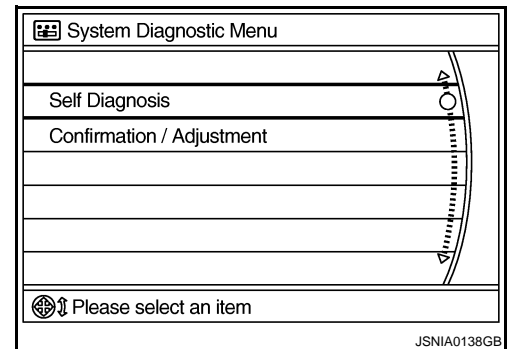
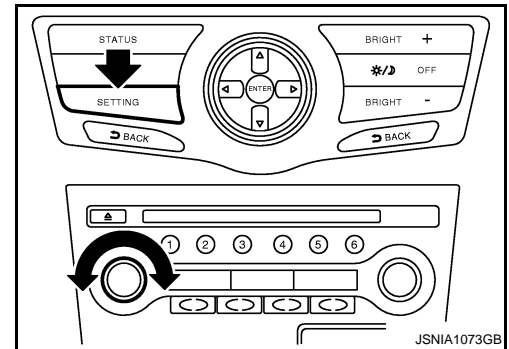

SELF-DIAGNOSIS MODE

DIAGNOSIS SYSTEM (AV CONTROL UNIT)

[BOSE AUDIO WITHOUT NAVIGATION]

< FUNCTION DIAGNOSIS >

1. Start the self-diagnosis function and select "Self-diagnosis".

NOTE:

Because the start condition of diagnosis function is a switch operation, the on board diagnosis function cannot start up if any malfunction is detected in the AV communication circuit between AV control unit and multifunction switch.

- Self-diagnosis subdivision screen is displayed, and the self-diagnosis mode starts.
- The bar graph visible on the center of the self-diagnosis subdivision screen indicates progress of the trouble diagnosis.

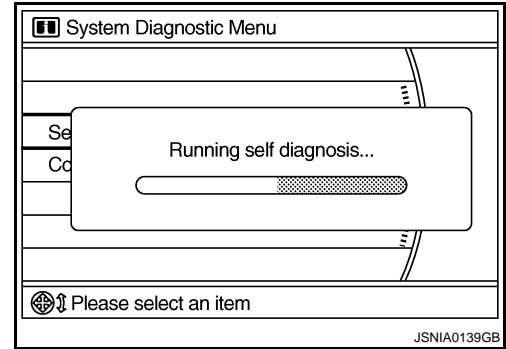

2. Diagnosis results are displayed after the self-diagnosis is completed. The unit names and the connection lines are color-coded according to the diagnostic results.

Diagnosis results	Unit	Con- nection line
Normal	Green	Green
Connection malfunction	Gray	Yellow
Unit malfunction ^{Note}	Red	Green

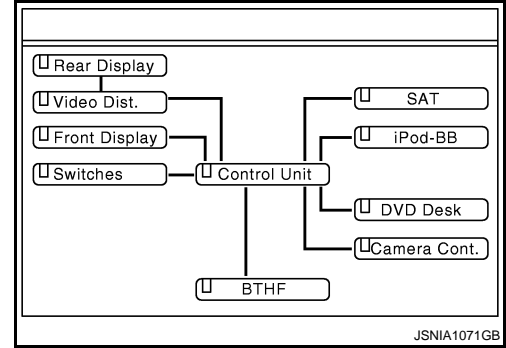

NOTE:

- Only the control unit (AV control unit) is displayed in red.
- Replace AV control unit if "Self-Diagnosis did not run because of a control unit malfunction" is indicated. The symptom is AV control unit internal error. Refer to [AV-522, "Exploded View"](#).
- If multiple errors occur at the same time for a single unit, the screen switch colors are determined according to the following order of priority: red > gray.
- The comments of the self-diagnosis results can be viewed with a component in the diagnosis result screen.

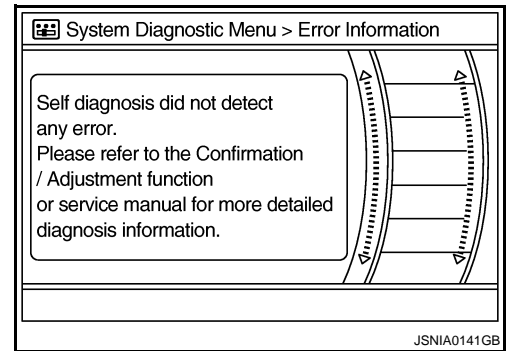

SELF-DIAGNOSIS RESULTS

Check the applicable display at the following table, and then repair the malfunctioning parts.

NOTE:

Because the start condition of diagnosis function is a switch operation, the on board diagnosis function cannot be started up if any malfunction is detected in the AV communication circuit between AV control unit and multifunction switch.

Self-diagnosis Result Chart

DIAGNOSIS SYSTEM (AV CONTROL UNIT)

< FUNCTION DIAGNOSIS >

[BOSE AUDIO WITHOUT NAVIGATION]

Diagnosis results	Detection logic	Possible malfunction location / Action to take
<div style="border: 1px solid black; padding: 5px; margin-bottom: 10px;"> <p style="font-size: small; margin-top: 5px;">■ : Red JSNIA1077GB</p> </div> <p>NOTE: When a control unit malfunction is detected (red in unit display), connection malfunctions with other connection unit may be displayed.</p> <p>“Self-Diagnosis did not run because of a control unit malfunction”</p>	<p>Malfunction is detected in AV control unit power supply and ground circuits.</p>	<p>Check AV control unit power supply and ground circuits. When detecting no malfunction in those components, replace AV control unit.</p>
<div style="border: 1px solid black; padding: 5px; margin-bottom: 10px;"> <p style="font-size: small; margin-top: 5px;">■ : Gray - - - - : Yellow JSNIA1078GB</p> </div>	<p>When either one of the following items are detected:</p> <ul style="list-style-type: none"> serial communication circuits between AV control unit and front display unit are malfunctioning. serial communication signal between AV control unit and front display unit is malfunctioning. 	<p>Serial communication circuits between AV control unit and front display unit.</p>
<div style="border: 1px solid black; padding: 5px; margin-bottom: 10px;"> <p style="font-size: small; margin-top: 5px;">■ : Gray - - - - : Yellow JSNIA1079GB</p> </div>	<p>When either one of the following items are detected:</p> <ul style="list-style-type: none"> satellite radio tuner power supply and ground circuits are malfunctioning. serial communication circuits between AV control unit and satellite radio tuner are malfunctioning. serial communication or request signal between AV control unit and satellite radio tuner is malfunctioning. request signal circuit between AV control unit and satellite radio tuner is malfunctioning. 	<ul style="list-style-type: none"> Satellite radio tuner power supply and ground circuits. Serial communication circuits between AV control unit and satellite radio tuner. Request signal circuit between AV control unit and satellite radio tuner.

A
B
C
D
E
F
G
H
I
J
K
L
M
O
P

AV

DIAGNOSIS SYSTEM (AV CONTROL UNIT)

< FUNCTION DIAGNOSIS >

[BOSE AUDIO WITHOUT NAVIGATION]

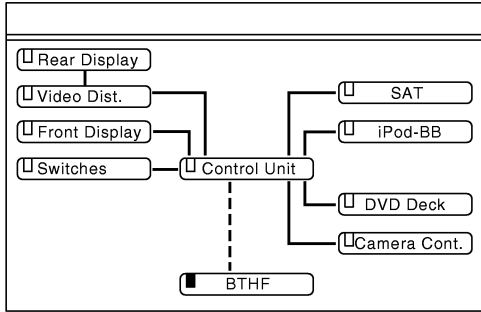
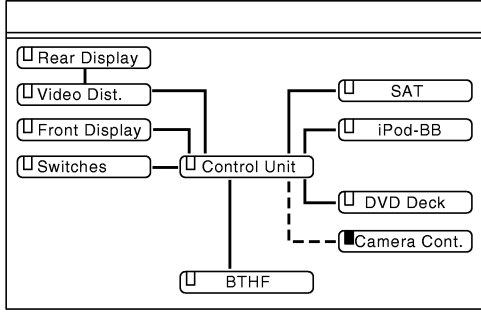
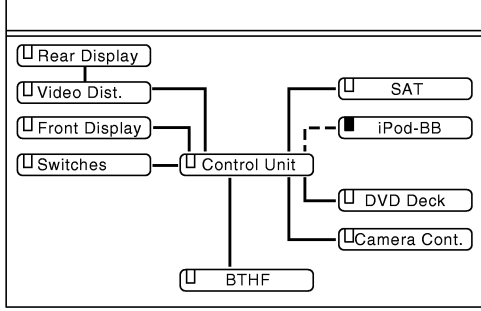
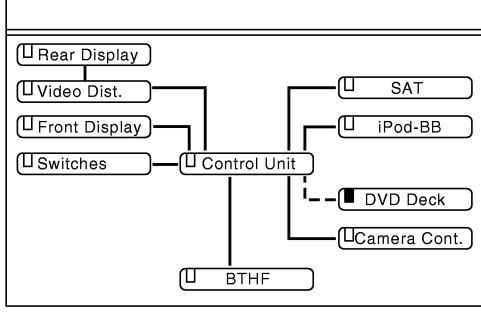
Diagnosis results	Detection logic	Possible malfunction location / Action to take
 <p style="font-size: small;">■ : Gray - - - - : Yellow JSNIA1080GB</p>	<p>When either one of the following items are detected:</p> <ul style="list-style-type: none"> • TEL adapter unit power supply and ground circuits are malfunctioning. • AV communication circuits between camera control unit and TEL adapter unit are malfunctioning. • AV communication circuits between multifunction switch and camera control unit are malfunctioning. (without DVD player models) • AV communication circuits between DVD player and camera control unit are malfunctioning. (with DVD player models) • AV communication circuits between camera control unit and TEL adapter unit is malfunctioning. • AV communication signal between AV control unit and TEL adapter unit is malfunctioning. 	<ul style="list-style-type: none"> • TEL adapter unit power supply and ground circuits. • AV communication circuits between camera control unit and TEL adapter unit. • AV communication circuits between multifunction switch and camera control unit. (without DVD player models) • AV communication circuits between DVD player and camera control unit. (with DVD player models) • AV communication circuits between camera control unit and TEL adapter unit. • AV communication circuits between multifunction switch and TEL adapter unit. (without rear view camera)
 <p style="font-size: small;">■ : Gray - - - - : Yellow JSNIA1081GB</p>	<p>Malfunction is detected in camera-connection recognition signal circuit.</p>	<p>Camera connection recognition signal circuit.</p>
 <p style="font-size: small;">■ : Gray - - - - : Yellow JSNIA1082GB</p>	<p>When either one of the following items are detected:</p> <ul style="list-style-type: none"> • iPod adapter power supply and ground circuits are malfunctioning. • AV communication circuits between multifunction switch and iPod adapter are malfunctioning. • AV communication signal between AV control unit and iPod adapter is malfunctioning. 	<ul style="list-style-type: none"> • iPod adapter power supply and ground circuits. • AV communication circuits between multifunction switch and iPod adapter.
 <p style="font-size: small;">■ : Gray - - - - : Yellow JSNIA1083GB</p>	<p>When either one of the following items are detected:</p> <ul style="list-style-type: none"> • DVD player power supply and ground circuits are malfunctioning. • AV communication signal between AV control unit and DVD player is malfunctioning. 	<p>DVD player power supply and ground circuits.</p>

DIAGNOSIS SYSTEM (AV CONTROL UNIT)

< FUNCTION DIAGNOSIS >

[BOSE AUDIO WITHOUT NAVIGATION]

Diagnosis results	Detection logic	Possible malfunction location / Action to take
<p>■ : Gray - - - - : Yellow JSNIA1084GB</p>	<p>When either one of the following items are detected:</p> <ul style="list-style-type: none"> rear display unit power supply and ground circuits are malfunctioning. serial communication circuits between video distributor and rear display unit are malfunctioning. serial communication signal between video distributor and rear display unit is malfunctioning. 	<ul style="list-style-type: none"> Rear display unit power supply and ground circuits. Serial communication circuits between video distributor and rear display unit.
<p>■ : Gray - - - - : Yellow ······ : Gray JSNIA1085GB</p>	<p>When either one of the following items are detected:</p> <ul style="list-style-type: none"> Malfunction is detected in video distributor power supply and ground circuits. AV communication signal between AV control unit and video distributor is malfunctioning. 	<p>Video distributor power supply and ground circuits.</p>
<p>■ : Gray - - - - : Yellow JSNIA1086GB</p>	<p>Malfunction is detected in AV communication circuits between video distributor and DVD player.</p>	<p>AV communication circuits between video distributor and DVD player malfunction.</p>

A
B
C
D
E
F
G
H
I
J
K
L
M
N
O
P

AV

DIAGNOSIS SYSTEM (AV CONTROL UNIT)

< FUNCTION DIAGNOSIS >

[BOSE AUDIO WITHOUT NAVIGATION]

Diagnosis results	Detection logic	Possible malfunction location / Action to take
<p>■ : Gray - - - : Yellow ····· : Gray JSNIA1087GB</p>	<p>Malfunction is detected in AV communication circuits between multifunction switch and video distributor.</p>	<p>AV communication circuits between multifunction switch and video distributor.</p>
<p>■ : Gray - - - : Yellow ····· : Gray JSNIA1174GB</p>	<p>Malfunction is detected in AV communication circuits between multifunction switch and iPod adapter.</p>	<p>AV communication circuits between multifunction switch and iPod adapter.</p>

NOTE:

The number of units that is displayed on the on board self-diagnosis display according to equipment.

CONFIRMATION/ADJUSTMENT MODE

1. Start the diagnosis function and select "Confirmation/Adjustment". The confirmation/adjustment mode indicates where each item can be checked or adjusted.
2. Select each switch on the "Confirmation/Adjustment Mode" screen to display the relevant trouble diagnosis screen. Press the "RETURN" switch to return to the initial Confirmation/Adjustment Mode screen.

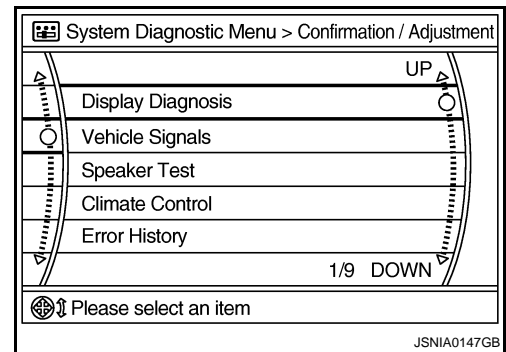

DIAGNOSIS SYSTEM (AV CONTROL UNIT)

< FUNCTION DIAGNOSIS >

[BOSE AUDIO WITHOUT NAVIGATION]

Display Diagnosis

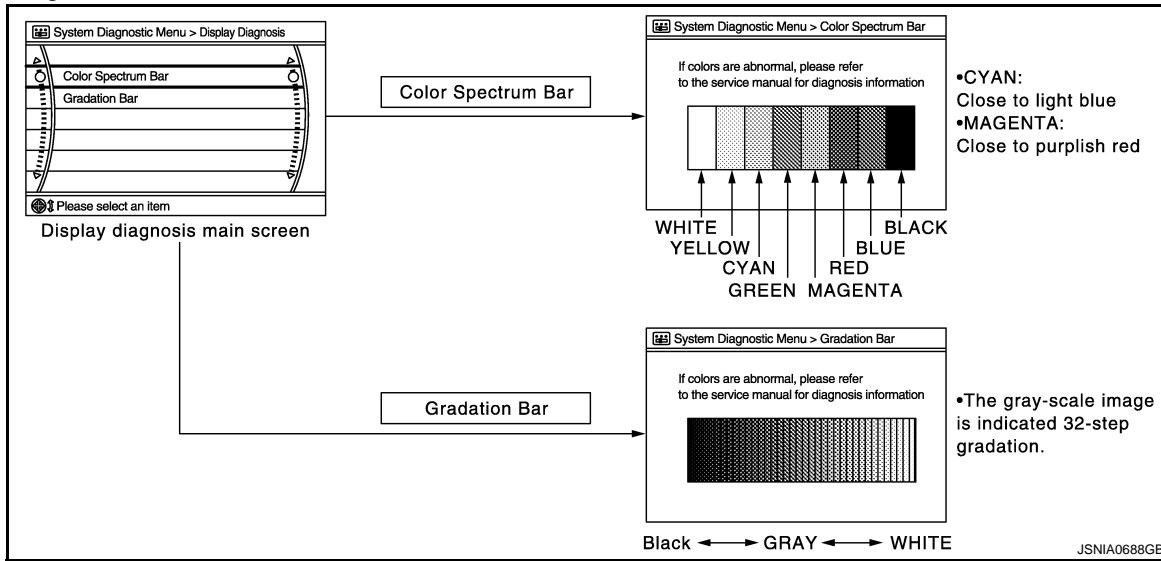

The tint of the color bar indication is as per the following list if RGB image signal error is detected.

- R (red) signal error** : Light blue (Cyan) tint
- G (green) signal error** : Purple (Magenta) tint
- B (blue) signal error** : Yellow tint

Vehicle Signals

A comparison check can be made of each actual vehicle signal and the signals recognized by the system.

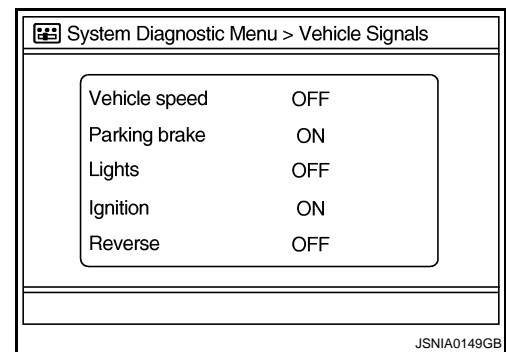

Diagnosis item	Display	Vehicle status	Remarks
Vehicle speed	ON	Vehicle speed > 0 km/h (0 MPH)	Changes in indication may be delayed. This is normal.
	OFF	Vehicle speed = 0 km/h (0 MPH)	
Parking brake	ON	Parking brake is applied.	
	OFF	Parking brake is released.	
Lights	ON	Light switch ON	—
	OFF	Light switch OFF	—
Ignition	ON	Ignition switch ON	—
	OFF	Ignition switch in the ACC position	—
Reverse	ON	Shift the selector lever to the "R" position	Changes in indication may be delayed. This is normal.
	OFF	Shift the selector lever to a position other than the "R" position	

Speaker Test

DIAGNOSIS SYSTEM (AV CONTROL UNIT)

[BOSE AUDIO WITHOUT NAVIGATION]

< FUNCTION DIAGNOSIS >

Select "SPEAKER DIAGNOSIS" to display the Speaker Diagnosis screen. Press "START and NEXT" to generate a test tone in a speaker. Press "Start" to generate a test tone in the next speaker. Press "End" to stop the test tones.

NOTE:

The frequency of test tone emitted from each speaker is as follows.

Tweeter	: 3 kHz
Front speaker	: 300 Hz
Rear speaker	: 1 kHz

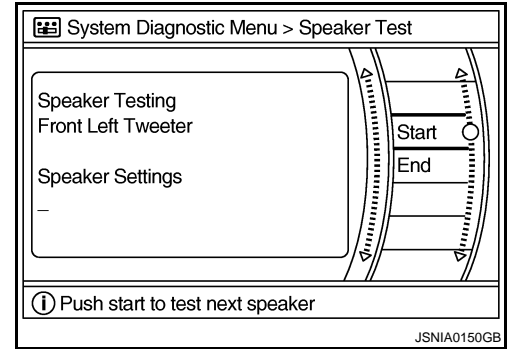

Climate Control

On-board self-diagnosis is not supported. Only CONSULT-III is supported.

Refer to [HAC-38, "CONSULT-III Function"](#) [without 7 inch display].

Refer to [HAC-157, "CONSULT-III Function"](#) [with 7 inch display].

Error History

The self-diagnosis results are judged depending on whether any error occurs from when "Self-diagnosis" is selected until the self-diagnosis results are displayed.

However, the diagnosis results are judged normal if an error has occurred before the ignition switch is turned ON and then no error has occurred until the self-diagnosis start. Check the "Error Record" to detect any error that may have occurred before the self-diagnosis start because of this situation.

Count up method A

- The counter resets to 0 if an error occurs when IGN switch is turned ON. The counter increases by 1 if the condition is normal at the next IGN ON cycle.
- The counter upper limit is 39. Any counts exceeding 39 are ignored. The counter can be reset (no error record display) with the "Delete log" switch or CONSULT-III.

Count up method B

- The counter increases by 1 if an error occurs when IGN switch is ON. The counter will not decrease even if the condition is normal at the next IGN ON cycle.
- The counter upper limit is 50. Any counts exceeding 50 are ignored. The counter can be reset (no error record display) with the "Delete log" switch or CONSULT-III.

Display type of occurrence frequency	Error history display item
Count up method A	CAN communication line, control unit (CAN), AV communication line, control unit (AV communication)
Count up method B	Other than the above

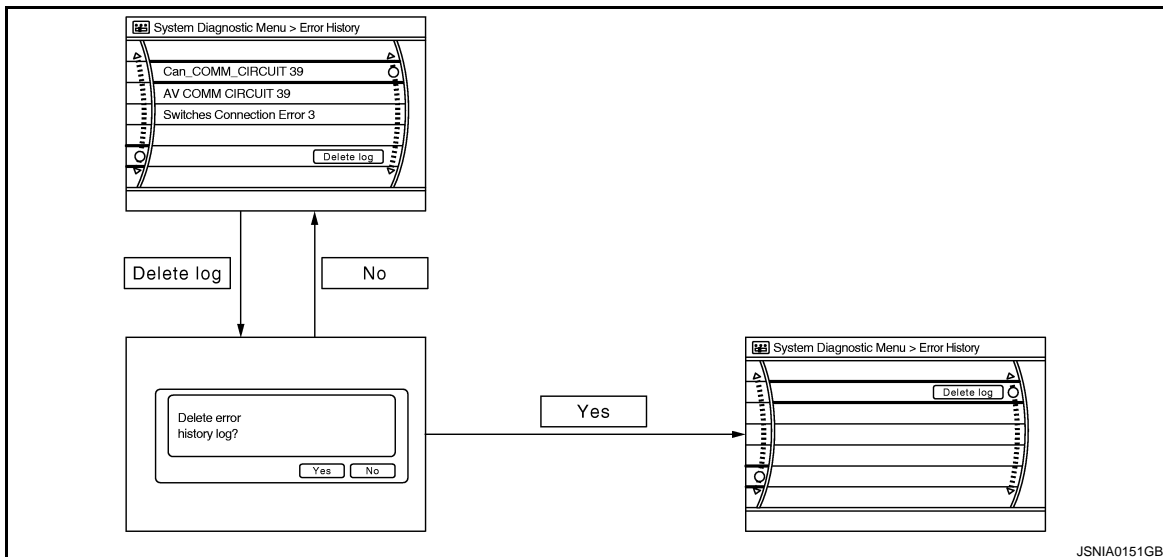

Error Item

Some error items may be displayed simultaneously according to the cause. If some error items are displayed simultaneously, the detection of the cause can be performed by the combination of display items

DIAGNOSIS SYSTEM (AV CONTROL UNIT)

< FUNCTION DIAGNOSIS >

[BOSE AUDIO WITHOUT NAVIGATION]

Error item	Description	Possible malfunction factor/Action to take	A
CAN COMM CIRCUIT	CAN communication malfunction is detected.	Perform diagnosis with CONSULT-III, and then repair the malfunctioning parts according to the diagnosis results. Refer to AV-83, "CONSULT-III Function (MULTI AV)" .	B
CONTROL UNIT (CAN)	CAN initial diagnosis malfunction is detected.	Replace the AV control unit.	C
CONTROL UNIT (AV)	AV communication circuit initial diagnosis malfunction is detected.		D
FLASH-ROM Error Of Control Unit CAN Controller Memory Error	AV control unit malfunction is detected.		E
Front Display Connection Error	When either one of the following items are detected: <ul style="list-style-type: none"> • front display unit power supply and ground circuits are malfunctioning. • serial communication circuits between AV control unit and front display unit are malfunctioning. • serial communication signal between AV control unit and front display unit is malfunctioning. 	<ul style="list-style-type: none"> • Front display unit power supply and ground circuits. • Serial communication circuits between AV control unit and front display unit. 	F
Rear Display Connection Error	When either one of the following items are detected: <ul style="list-style-type: none"> • rear display unit power supply and ground circuits are malfunctioning. • serial communication circuits between video distributor and rear display unit are malfunctioning. • serial communication signal between video distributor and rear display unit is malfunctioning. 	<ul style="list-style-type: none"> • Rear display unit power supply and ground circuits. • Serial communication circuits between video distributor and rear display unit. 	G
Camera Control Unit Connection Error	Malfunction is detected in camera connection recognition circuit between AV control unit and camera control unit.	Camera-connection recognition circuit between AV control unit and camera control unit.	H
SAT Connection Error	When either one of the following items are detected: <ul style="list-style-type: none"> • satellite radio tuner power supply and ground circuits are malfunctioning. • serial communication circuits between AV control unit and satellite radio tuner are malfunctioning. • serial communication or request signal between AV control unit and satellite radio tuner is malfunctioning. • request signal circuit between AV control unit and satellite radio tuner is malfunctioning. 	<ul style="list-style-type: none"> • Satellite radio tuner power supply and ground circuits. • Serial communication circuits between AV control unit and satellite radio tuner. • Request signal circuit between AV control unit and satellite radio tuner. 	I
<ul style="list-style-type: none"> • AV COMM CIRCUIT • Switches Connection Error 	When either one of the following items are detected: <ul style="list-style-type: none"> • multifunction switch power supply and ground circuits are malfunctioning. • AV communication circuits between AV control unit and multifunction switch are malfunctioning. • AV communication signal between AV control unit and multifunction switch is malfunctioning. 	<ul style="list-style-type: none"> • Multifunction switch power supply and ground circuits. • AV communication circuits between AV control unit and multifunction switch. 	J

AV

DIAGNOSIS SYSTEM (AV CONTROL UNIT)

< FUNCTION DIAGNOSIS >

[BOSE AUDIO WITHOUT NAVIGATION]

Error item	Description	Possible malfunction factor/Action to take
<ul style="list-style-type: none"> • AV COMM CIRCUIT • Video Distributor Connection Error 	When either one of the following items are detected: <ul style="list-style-type: none"> • video distributor power supply and ground circuits are malfunctioning. • AV communication signal between AV control unit and video distributor is malfunctioning. 	Video distributor power supply and ground circuits.
<ul style="list-style-type: none"> • AV COMM CIRCUIT • DVD Deck Connection Error 	When either one of the following items are detected: <ul style="list-style-type: none"> • DVD player power supply and ground circuits are malfunctioning. • AV communication signal between AV control unit and DVD player is malfunctioning. 	DVD player power supply and ground circuits.
<ul style="list-style-type: none"> • AV COMM CIRCUIT • Rearview Camera Connection Error 	When either one of the following items are detected: <ul style="list-style-type: none"> • camera control unit power supply and ground circuits are malfunctioning. • AV communication signal between AV control unit and camera control unit is malfunctioning. • AV communication circuits between multifunction switch and camera control unit are malfunctioning. (Without DVD entertainment system models) 	<ul style="list-style-type: none"> • Camera control unit power supply and ground circuits. • AV communication circuits between multifunction switch and camera control unit. (Without DVD entertainment system models)
<ul style="list-style-type: none"> • AV COMM CIRCUIT • iPod Connection Error 	When either one of the following items are detected: <ul style="list-style-type: none"> • iPod adapter power supply and ground circuits are malfunctioning. • AV communication circuits between multifunction switch and iPod adapter are malfunctioning. • AV communication signal between AV control unit and iPod adapter is malfunctioning. 	<ul style="list-style-type: none"> • iPod adapter power supply and ground circuits. • AV communication circuits between multifunction switch and iPod adapter.
<ul style="list-style-type: none"> • AV COMM CIRCUIT • H/F Unit Connection Error 	When either one of the following items are detected: <ul style="list-style-type: none"> • TEL adapter unit power supply and ground circuits are malfunctioning. • AV communication circuits between camera control unit and TEL adapter unit are malfunctioning. • AV communication signal between AV control unit and TEL adapter unit is malfunctioning. 	<ul style="list-style-type: none"> • TEL adapter unit power supply and ground circuits. • AV communication circuits between camera control unit and TEL adapter unit.
<ul style="list-style-type: none"> • AV COMM CIRCUIT • Rearview Camera Connection Error • H/F Unit Connection Error* 	When either one of the following items are detected: <ul style="list-style-type: none"> • AV communication circuits between multifunction switch and camera control unit are malfunctioning. (without DVD player models) • AV communication circuits between DVD player and camera control unit are malfunctioning. (with DVD player models) 	<ul style="list-style-type: none"> • AV communication circuits between multifunction switch and camera control unit. (without DVD player models) • AV communication circuits between DVD player and camera control unit. (with DVD player models)
<ul style="list-style-type: none"> • AV COMM CIRCUIT • DVD Deck Connection Error • Rearview Camera Connection Error • H/F Unit Connection Error 	Malfunction is detected in AV communication circuits between video distributor and DVD player.	AV communication circuits between video distributor and DVD player.

DIAGNOSIS SYSTEM (AV CONTROL UNIT)

< FUNCTION DIAGNOSIS >

[BOSE AUDIO WITHOUT NAVIGATION]

Error item	Description	Possible malfunction factor/Action to take
<ul style="list-style-type: none"> • AV COMM CIRCUIT • Video Distributor Connection Error • DVD Deck Connection Error • Rearview Camera Connection Error • H/F Unit Connection Error 	Malfunction is detected in AV communication circuits between multifunction switch and video distributor.	AV communication circuits between multifunction switch and video distributor.
<ul style="list-style-type: none"> • AV COMM CIRCUIT • Video Distributor Connection Error • DVD Deck Connection Error • Rearview Camera Connection Error • iPod Connection Error • H/F Unit Connection Error 	Malfunction is detected in AV communication circuits between multifunction switch and iPod adapter.	AV communication circuits between multifunction switch and iPod adapter.
<ul style="list-style-type: none"> • AV COMM CIRCUIT • Switches Connection Error • Rearview Camera Connection Error • iPod Connection Error* • H/F Unit Connection Error* 	When either one of the following items are detected: <ul style="list-style-type: none"> • AV communication circuits between AV control unit and the branch point multifunction switch and AV control unit are malfunctioning. • AV communication circuits are malfunctioning. 	<ul style="list-style-type: none"> • AV communication circuits between AV control unit and the branch point multifunction switch and AV control unit. • Check and repair the short circuit in AV communication circuits.
<ul style="list-style-type: none"> • AV COMM CIRCUIT • Switches Connection Error • Video Distributor Connection Error • DVD Deck Connection Error • Rearview Camera Connection Error • iPod Connection Error • H/F Unit Connection Error 		

*: Non-equipped item is not displayed.

Camera Cont.

The two functions of “Connection Confirmation” and “Adjust Offset of Rear View Camera” are available.

CONNECTION CONFIRMATION

The steering angle sensor, reverse signal and vehicle speed sensor can be inspected.

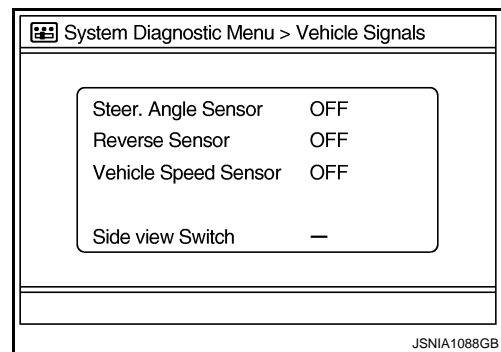

Diagnosis item	Display	Vehicle status
Steer. Angle Sensor	ON	When steering the vehicle with ignition switch ON (remains ON until connection mode is stopped when it is turned ON).
	OFF	<ul style="list-style-type: none"> • Ignition switch at ACC. • No steering with ignition switch ON.
	—	Malfunction detected in camera connection recognition signal.
Reverse Sensor	ON	Selector lever is in “R” with ignition switch ON.
	OFF	<ul style="list-style-type: none"> • Ignition switch at ACC. • Selector lever is in position other than “R” with ignition switch ON.
	—	Malfunction detected in camera-connection recognition signal.
Vehicle Speed Sensor	ON	Vehicle speed is more than 0 km/h (0 MPH) with ignition switch ON.
	OFF	<ul style="list-style-type: none"> • Ignition switch at ACC. • Vehicle speed is 0 km/h (0 MPH) with ignition switch ON.
	—	Malfunction detected in camera connection recognition signal.
Side view Switch	—	Not used.

DIAGNOSIS SYSTEM (AV CONTROL UNIT)

[BOSE AUDIO WITHOUT NAVIGATION]

< FUNCTION DIAGNOSIS >

ADJUST OFFSET OF REAR VIEW CAMERA

Use this mode to adjust the guide line display position of the rear-view monitor if necessary after removing the rear view monitor camera.

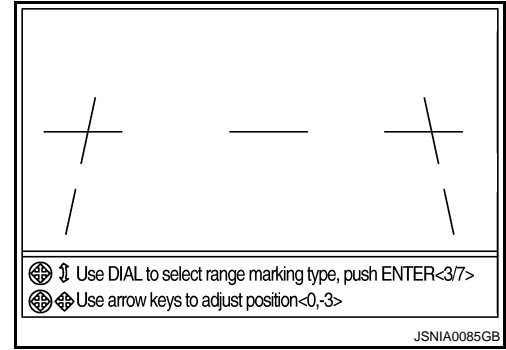

Vehicle CAN Diagnosis

- CAN communication status and error counter is displayed.
- The error counter displays “OK” if any malfunction was not detected in the past and displays “0” if a malfunction is detected. It increases by 1 if the status is normal at the next ignition switch ON cycle. The upper limit of the counter is 39.
- The error counter is erased if reset.

Items	Display (Current)	Malfunction counter (Past)
Tx (HVAC)	OK / UNKWN	OK / 0 - 39
Rx (ECM)	OK / UNKWN	OK / 0 - 39
Rx (Cluster)	OK / UNKWN	OK / 0 - 39
Rx (BCM)	OK / UNKWN	OK / 0 - 39
Rx (HVAC)	OK / UNKWN	OK / 0 - 39
Rx (USM)	OK / UNKWN	OK / 0 - 39

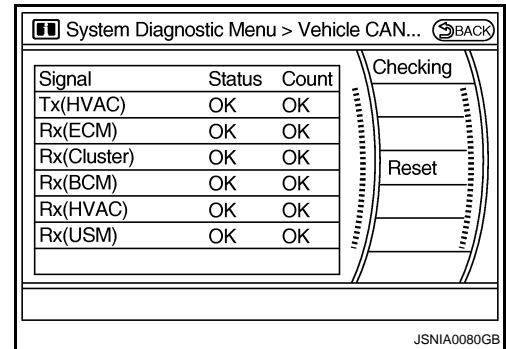

AV COMM Diagnosis

- Displays the communication status between AV control unit (master unit) and each unit.
- The error counter displays “OK” if any malfunction was not detected in the past and displays “0” if a malfunction is detected. It increases by 1 if the condition is normal at the next ignition switch ON cycle. The upper limit of the counter is 39.
- If it resets, the error counter is erased.

Items	Status (Current)	Counter (Past)
C Tx(ITM-SW)	OK / UNKWN	OK / 0 - 39
C Rx(PrimarySW-ITM)	OK / UNKWN	OK / 0 - 39
C Rx(RearCamera-ITM)	OK / UNKWN	OK / 0 - 39
C Rx(DVD-ITM)	OK / UNKWN	OK / 0 - 39
C Rx(Video Dist-ITM)	OK / UNKWN	OK / 0 - 39
C Rx(Remote Cont-ITM)	OK / UNKWN	OK / 0 - 39
C Rx(BTHF-ITM)	OK / UNKWN	OK / 0 - 39
C Rx(iPod Adpt.-ITM)	OK / UNKWN	OK / 0 - 39
C Rx(DVDAudio-ITM)	OK / UNKWN	OK / 0 - 39

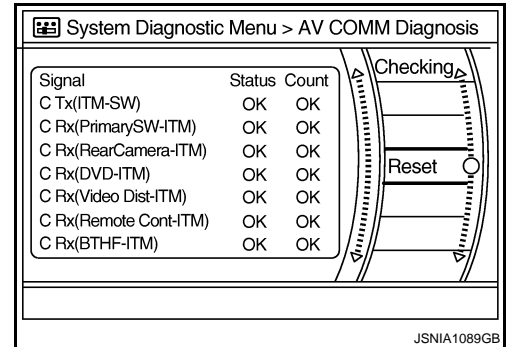

Delete Unit Connection Log

DIAGNOSIS SYSTEM (AV CONTROL UNIT)

[BOSE AUDIO WITHOUT NAVIGATION]

< FUNCTION DIAGNOSIS >

Deletes any unit connection records and error records from the AV control unit memory. (Clear the records of the unit that has been removed)

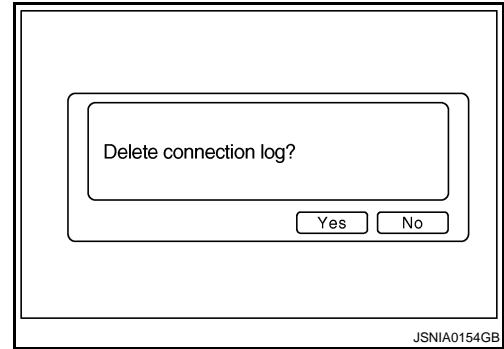

Initialize Settings

Initializes the AV control unit memory.

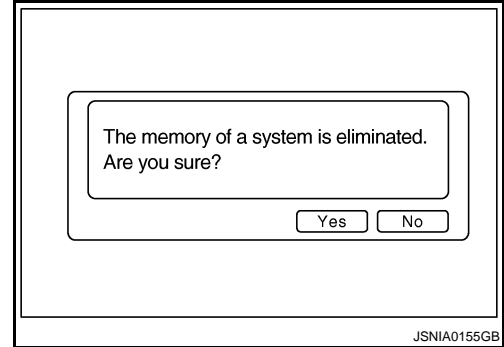

CONSULT-III Function (MULTI AV)

INFOID:000000003356761

CONSULT-III functions

CONSULT-III performs the following functions via communication with the AV control unit.

Diagnosis mode	Description
Ecu Identification	The part number of AV control unit can be checked.
Self Diagnostic Result	Performs a diagnosis on the AV control unit. A connection diagnosis for the communication circuit of the MULTI AV system and displays the current and past malfunctions collectively.
Data Monitor	The diagnosis of vehicle signal that is input to the AV control unit can be performed.

AV COMMUNICATION

When "AV communication" of "CAN Diag Support Monitor" is selected, the following function will be performed.

AV communication	AV&NAVI C/U	Displays the communication status from AV control unit to each unit as well as the error counter.
	AUDIO	Displays the AV control unit communication status and the error counter.

ECU IDENTIFICATION

The part number of AV control unit is displayed.

SELF DIAGNOSIS RESULT

- In CONSULT-III self-diagnosis, self-diagnosis results and error history are displayed collectively.
- The current malfunction indicates "CRNT". The past malfunction indicates "PAST".
- The timing is displayed as "0" if any of the error codes [U1000], [U1010], [U1300] and [U1310] is detected. The counter increases by 1 if the condition is normal at the next ignition switch ON cycle.

Self-diagnosis Results Display Item

Error item	Description	Possible malfunction factor/Action to take
CAN COMM CIRCUIT [U1000]	CAN communication malfunction is detected.	Refer to AV-89, "Description" .

DIAGNOSIS SYSTEM (AV CONTROL UNIT)

< FUNCTION DIAGNOSIS >

[BOSE AUDIO WITHOUT NAVIGATION]

Error item	Description	Possible malfunction factor/Action to take
CONTROL UNIT (CAN) [U1010]	CAN initial diagnosis malfunction is detected.	Replace the AV control unit
CONTROL UNIT (AV) [U1310]	AV communication circuit initial diagnosis malfunction is detected.	
Cont Unit FLASH-ROM [U1200] CAN CONT [U1216]	AV control unit malfunction is detected.	
FRONT DISP CONN [U1243]	When either one of the following items are detected: <ul style="list-style-type: none"> • front display unit power supply and ground circuits are malfunctioning. • serial communication circuits between AV control unit and front display unit are malfunctioning. • serial communication signal between AV control unit and front display unit is malfunctioning. 	<ul style="list-style-type: none"> • Front display unit power supply and ground circuits. • Serial communication circuits between AV control unit and front display unit.
REAR DISP CONN [U1247]	When either one of the following items are detected: <ul style="list-style-type: none"> • rear display unit power supply and ground circuits are malfunctioning. • serial communication circuits between video distributor and rear display unit are malfunctioning. • serial communication signal between video distributor and rear display unit is malfunctioning. 	<ul style="list-style-type: none"> • Rear display unit power supply and ground circuits. • Serial communication circuits between video distributor and rear display unit.
CAMERA CONT CONN [U1250]	Malfunction is detected in camera connection recognition circuit between AV control unit and camera control unit.	Camera-connection recognition circuit between AV control unit and camera control unit.
SAT CONN [U1255]	When either one of the following items are detected: <ul style="list-style-type: none"> • satellite radio tuner power supply and ground circuits are malfunctioning. • serial communication circuits between AV control unit and satellite radio tuner are malfunctioning. • serial communication or request signal between AV control unit and satellite radio tuner is malfunctioning. • request signal circuit between AV control unit and satellite radio tuner is malfunctioning. 	<ul style="list-style-type: none"> • Satellite radio tuner power supply and ground circuits. • Serial communication circuits between AV control unit and satellite radio tuner. • Request signal circuit between AV control unit and satellite radio tuner.
<ul style="list-style-type: none"> • AV COMM CIRCUIT [U1300] • SWITCH CONN [U1240] 	When either one of the following items are detected: <ul style="list-style-type: none"> • multifunction switch power supply and ground circuits are malfunctioning. • AV communication circuits between AV control unit and multifunction switch are malfunctioning. • AV communication signal between AV control unit and multifunction switch is malfunctioning. 	<ul style="list-style-type: none"> • Multifunction switch power supply and ground circuits. • AV communication circuits between AV control unit and multifunction switch.
<ul style="list-style-type: none"> • AV COMM CIRCUIT [U1300] • VIDEO DIST CONN [U1246] 	When either one of the following items are detected: <ul style="list-style-type: none"> • video distributor power supply and ground circuits are malfunctioning. • AV communication signal between AV control unit and video distributor is malfunctioning. 	Video distributor power supply and ground circuits.

DIAGNOSIS SYSTEM (AV CONTROL UNIT)

[BOSE AUDIO WITHOUT NAVIGATION]

< FUNCTION DIAGNOSIS >

Error item	Description	Possible malfunction factor/Action to take
<ul style="list-style-type: none"> • AV COMM CIRCUIT [U1300] • DVD DECK CONN [U1248] 	<p>When either one of the following items are detected:</p> <ul style="list-style-type: none"> • DVD player power supply and ground circuits are malfunctioning. • AV communication signal between AV control unit and DVD player is malfunctioning. 	DVD player power supply and ground circuits.
<ul style="list-style-type: none"> • AV COMM CIRCUIT [U1300] • REAR CAMERA LAN CONN [U1252] 	<p>When either one of the following items are detected:</p> <ul style="list-style-type: none"> • camera control unit power supply and ground circuits are malfunctioning. • AV communication signal between AV control unit and camera control unit is malfunctioning. • AV communication circuits between multifunction switch and camera control unit is malfunctioning. (Without DVD entertainment system models) 	<ul style="list-style-type: none"> • Camera control unit power supply and ground circuits. • AV communication circuits between multifunction switch and camera control unit. (Without DVD entertainment system models)
<ul style="list-style-type: none"> • AV COMM CIRCUIT [U1300] • IPod CONN [U1254] 	<p>When either one of the following items are detected:</p> <ul style="list-style-type: none"> • iPod adapter power supply and ground circuits are malfunctioning. • AV communication circuits between multifunction switch and iPod adapter are malfunctioning. • AV communication signal between AV control unit and iPod adapter is malfunctioning. 	<ul style="list-style-type: none"> • iPod adapter power supply and ground circuits. • AV communication circuits between multifunction switch unit and iPod adapter.
<ul style="list-style-type: none"> • AV COMM CIRCUIT [U1300] • HAND FREE CONN [U1256] 	<p>When either one of the following items are detected:</p> <ul style="list-style-type: none"> • TEL adapter unit power supply and ground circuits are malfunctioning. • AV communication circuits between camera control unit and TEL adapter unit are malfunctioning. • AV communication signal between AV control unit and TEL adapter unit is malfunctioning. 	<ul style="list-style-type: none"> • TEL adapter unit power supply and ground circuits. • AV communication circuits between camera control unit and TEL adapter unit. • AV communication circuits between multifunction switch and TEL adapter unit. (without rear view camera models)
<ul style="list-style-type: none"> • AV COMM CIRCUIT [U1300] • REAR CAMERA LAN CONN [U1252] • HAND FREE CONN [U1256]* 	<p>When either one of the following items are detected:</p> <ul style="list-style-type: none"> • AV communication circuits between multifunction switch and camera control unit are malfunctioning. (without DVD player models) • AV communication circuits between DVD player and camera control unit are malfunctioning. (with DVD player models) 	<ul style="list-style-type: none"> • AV communication circuits between multifunction switch and camera control unit. (without DVD player models) • AV communication circuits between DVD player and camera control unit. (with DVD player models)
<ul style="list-style-type: none"> • AV COMM CIRCUIT [U1300] • DVD DECK CONN [U1248] • REAR CAMERA LAN CONN [U1252] • HAND FREE CONN [U1256] 	Malfunction is detected in AV communication circuits between video distributor and DVD player.	AV communication circuits between video distributor and DVD player.
<ul style="list-style-type: none"> • AV COMM CIRCUIT [U1300] • VIDEO DIST CONN [U1246] • DVD DECK CONN [U1248] • REAR CAMERA LAN CONN [U1252] • IPod CONN [U1254] • HAND FREE CONN [U1256] 	Malfunction is detected in AV communication circuits between multifunction switch and iPod adapter.	AV communication circuits between multifunction switch and iPod adapter.
<ul style="list-style-type: none"> • AV COMM CIRCUIT [U1300] • VIDEO DIST CONN [U1246] • DVD DECK CONN [U1248] • REAR CAMERA LAN CONN [U1252] • HAND FREE CONN [U1256] 	Malfunction is detected in AV communication circuits between multifunction switch and video distributor.	AV communication circuits between multifunction switch and video distributor.

A
B
C
D
E
F
G
H
I
J
K
L
M
AV

DIAGNOSIS SYSTEM (AV CONTROL UNIT)

< FUNCTION DIAGNOSIS >

[BOSE AUDIO WITHOUT NAVIGATION]

Error item	Description	Possible malfunction factor/Action to take
<ul style="list-style-type: none"> • AV COMM CIRCUIT [U1300] • SWITCH CONN [U1240] • IPod CONN [U1254]* • HAND FREE CONN [U1256]* 	When either one of the following items are detected: <ul style="list-style-type: none"> • AV communication circuits between AV control unit and the branch point multi-function switch. • AV communication circuits are malfunctioning. 	<ul style="list-style-type: none"> • AV communication circuits between AV control unit and the branch point multi-function switch. • Check and repair the short circuit in AV communication circuits.
<ul style="list-style-type: none"> • AV COMM CIRCUIT [U1300] • SWITCH CONN [U1240] • VIDEO DIST CONN [U1246] • DVD DECK CONN [U1248] • REAR CAMERA LAN CONN [U1252] • IPod CONN [U1254] • HAND FREE CONN [U1256] 		

NOTE:

*: Non-equipped item is not displayed.

DATA MONITOR

ALL SIGNALS

- Displays the status of the following vehicle signals inputted into the AV control unit.
- For each signal, the actual signal can be compared the condition recognized on the system.

Display Item	Display	Vehicle status	Remarks	
VHCL SPD SIG	On	Vehicle speed >0 km/h (0 MPH)	Changes in indication may be delayed. This is normal.	
	Off	Vehicle speed =0 km/h (0 MPH)		
PKB SIG	On	Parking brake is applied.		
	Off	Parking brake is released.		
ILLUM SIG	On	Light switch ON		—
	Off	Light switch OFF		
IGN SIG	On	Ignition switch ON		
	Off	Ignition switch in ACC position		
REV SIG	On	Shift the selector lever to the "R" position	Changes in indication may be delayed. This is normal.	
	Off	Shift the selector lever other than the "R" position		

SELECTION FROM MENU

Allows the technician to select which vehicle signals should be displayed and displays the status of the selected vehicle signals.

Item to be selected	Description
VHCL SPD SIG	The same as when "ALL SIGNALS" is selected.
PKB SIG	
ILLUM SIG	
IGN SIG	
REV SIG	

DIAGNOSIS SYSTEM (TEL ADAPTER UNIT)

< FUNCTION DIAGNOSIS >

[BOSE AUDIO WITHOUT NAVIGATION]

DIAGNOSIS SYSTEM (TEL ADAPTER UNIT)

Diagnosis Description

INFOID:000000003356762

HANDS-FREE PHONE SYSTEM ON BOARD DIAGNOSIS

During on board diagnosis the diagnosis function of TEL adapter unit starts with the operation of the steering switch and performs the diagnosis when ignition switch ACC.

On board diagnosis item

The on board diagnosis has 3 modes: the self-diagnosis mode that performs the trouble diagnosis, the speaker adaptation data deleting mode and the hands-free phone system initialization mode.

CAUTION:

- Perform the diagnosis with the vehicle stopped.
- Perform STEP2 if necessary.

STEP	MODE	Description
STEP1	Self-diagnosis	<ul style="list-style-type: none">• The self-diagnosis mode performs the microphone test.• The self-diagnosis mode also diagnoses TEL adapter unit, TEL antenna and steering switch.• Those results are indicated with voice guidance and displayed on the screen.
STEP2	Speaker adaptation data deleting	The speaker adaptation data deleting mode can delete the speaker adaptation data.
	Hands-free phone system initialization	Hands-free phone system initialization mode can perform the initialization of hands-free phone system.

Self-diagnosis results

Self-diagnosis mode reads out the self-diagnosis results and indicates DTC on the display.

NOTE:

- Error count is read out simultaneously when reading out the DTC name.
- The errors are read out continuously when some errors occur at the same time. The DTC displays are combined and displayed. For example, DTC 01100 is displayed when DTC 01000 and DTC 00100 are indicated at the same time.

Self-diagnosis results

DTC	DTC name	Possible causes
DTC 10000	INTERNAL FAILURE	TEL adapter unit
DTC 01000	ANT. SHORT TO BATT OR OPEN	TEL antenna
DTC 00100	ANT. SHORT TO GROUND	
DTC 00010	STEERING REMOTE BUTTON STUCK A	Steering switch
DTC 00001	STEERING REMOTE BUTTON STUCK B	
DTC 00000	THERE ARE NO FAILURE RECORDS TO REPORT	—

The details of error count

The error count guides "0" when the error occurs. The next time it counts up "1" if it is normal with the ignition switch ON. It continues the count up unless the initialization of hands-free phone system is performed.

DIAGNOSIS SYSTEM (TEL ADAPTER UNIT)

[BOSE AUDIO WITHOUT NAVIGATION]

< FUNCTION DIAGNOSIS >

FLOW CHART OF TROUBLE DIAGNOSIS

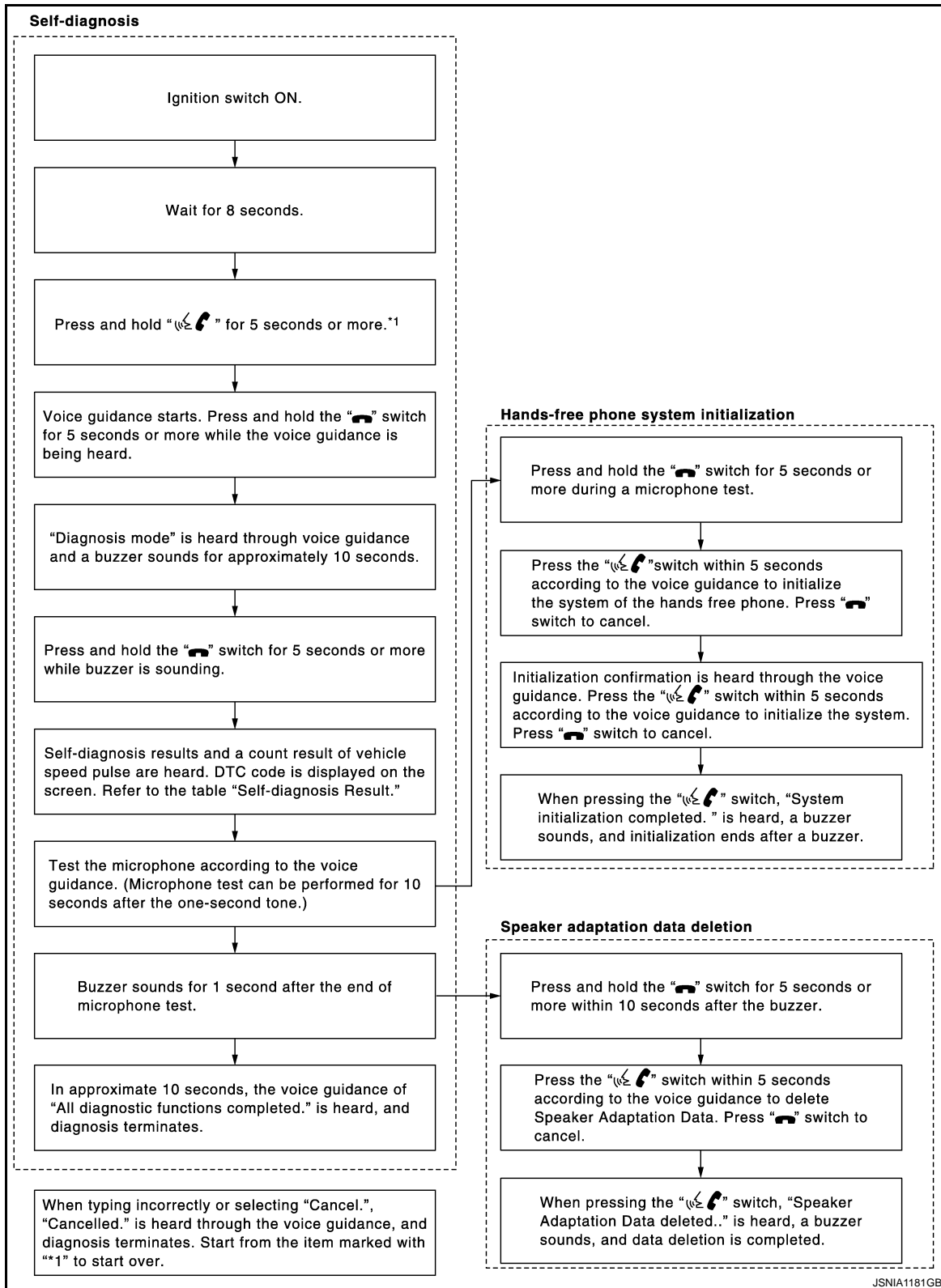

U1000 CAN COMM CIRCUIT

< COMPONENT DIAGNOSIS >

[BOSE AUDIO WITHOUT NAVIGATION]

COMPONENT DIAGNOSIS

U1000 CAN COMM CIRCUIT

Description

INFOID:0000000003356763

CAN (Controller Area Network) is a serial communication line for real-time application. It is an on-vehicle multiplex communication line with high data communication speed and excellent error detection ability. Many electronic control units are equipped onto a vehicle, and each control unit shares information and links with other control units during operation (not independently). In CAN communication, control units are connected with 2 communication lines (CAN-H, CAN-L) allowing a high rate of information transmission with less wiring. Each control unit transmits/receives data but selectively reads required data only.

CAN Communication Signal Chart. Refer to [LAN-25, "CAN Communication Signal Chart"](#).

DTC Logic

INFOID:0000000003356764

DTC DETECTION LOGIC

DTC	Display contents of CONSULT-III	Diagnostic item is detected when...	Probable malfunction location
U1000	CAN COMM CIRCUIT	AV control unit is not transmitting or receiving CAN communication signal for 2 seconds or more.	CAN communication system.

Diagnosis Procedure

INFOID:0000000003356765

1.PERFORM SELF-DIAGNOSTIC

1. Turn ignition switch ON and wait for 2 seconds or more.
2. Check "Self Diagnostic Result" of "MULTI AV".

Is "CAN COMM CIRCUIT" displayed?

- YES >> Refer to "LAN system". Refer to [LAN-16, "Trouble Diagnosis Flow Chart"](#).
NO >> Refer to GI section. Refer to [GI-40, "Intermittent Incident"](#).

A
B
C
D
E
F
G
H
I
J
K
L
M
O
P

AV

U1010 CONTROL UNIT (CAN)

< COMPONENT DIAGNOSIS >

[BOSE AUDIO WITHOUT NAVIGATION]

U1010 CONTROL UNIT (CAN)

Description

INFOID:000000003356766

Initial diagnosis of AV control unit.

DTC Logic

INFOID:000000003356767

DTC DETECTION LOGIC

DTC	Display contents of CONSULT-III	Diagnostic item is detected when...	Probable malfunction location
U1010	CONTROL UNIT (CAN)	CAN initial diagnosis malfunction is detected.	AV control unit.

Diagnosis Procedure

INFOID:000000003356768

1. REPLACE AV CONTROL UNIT

When DTC U1010 is detected, replace AV control unit.

>> INSPECTION END

U1310 AV CONTROL UNIT

< COMPONENT DIAGNOSIS >

[BOSE AUDIO WITHOUT NAVIGATION]

U1310 AV CONTROL UNIT

Description

INFOID:000000003356769

Replace the AV control unit if this DTC is displayed. Refer to [AV-522. "Exploded View"](#).

Part name	Description
AV CONTROL UNIT	<ul style="list-style-type: none">• It is the master unit of the MULTI AV system, and it is connected to each control unit by communication. It operates each system according to communication signals from the AV control unit.• AV control unit includes audio function and vehicle information function.• It is connected to ECM, A/C auto amp. and combination meter via CAN communication to obtain necessary information for the vehicle information function.• It is connected to BCM via CAN communication transmitting/receiving for the vehicle settings function.• It inputs the illumination signals that are required for the display dimming control.• It inputs the signals for driving status recognition (vehicle speed, reverse and parking brake).• The camera image signal is input from the camera control unit. The AV control unit outputs camera image signal to the front display unit.• BOSE amp. ON signal and sound signal are transmitted to BOSE amp.• Power (signal VCC and inverter VCC) is transmitted to front display. Without DVD entertainment system• Auxiliary image and auxiliary sound signals are input from the auxiliary input jacks. With DVD entertainment system• Composite image signal (auxiliary and DVD images) is input from the video distributor.• Sound signal (DVD and auxiliary sounds) is input from the DVD player.

DTC Logic

INFOID:000000003356770

DTC	Display contents of CONSULT-III	DTC Detection Condition	Action to take
U1310	CONTROL UNIT (AV) [U1310]	An initial diagnosis error is detected in AV communication circuit.	Replace AV control unit.

A
B
C
D
E
F
G
H
I
J
K
L
M

AV

O
P

U1200 AV CONTROL UNIT

< COMPONENT DIAGNOSIS >

[BOSE AUDIO WITHOUT NAVIGATION]

U1200 AV CONTROL UNIT

Description

INFOID:000000003470017

Replace the AV control unit if this DTC is displayed. Refer to [AV-522. "Exploded View"](#).

Part name	Description
AV CONTROL UNIT	<ul style="list-style-type: none">• It is the master unit of the MULTI AV system, and it is connected to each control unit by communication. It operates each system according to communication signals from the AV control unit.• AV control unit includes audio function and vehicle information function.• It is connected to ECM, A/C auto amp. and combination meter via CAN communication to obtain necessary information for the vehicle information function.• It is connected to BCM via CAN communication transmitting/receiving for the vehicle settings function.• It inputs the illumination signals that are required for the display dimming control.• It inputs the signals for driving status recognition (vehicle speed, reverse and parking brake).• The camera image signal is input from the camera control unit. The AV control unit outputs camera image signal to the front display unit.• BOSE amp. ON signal and sound signal are transmitted to BOSE amp.• Power (signal VCC and inverter VCC) is transmitted to front display. Without DVD entertainment system• Auxiliary image and auxiliary sound signals are input from the auxiliary input jacks. With DVD entertainment system• Composite image signal (auxiliary and DVD images) is input from the video distributor.• Sound signal (DVD and auxiliary sounds) is input from the DVD player.

DTC Logic

INFOID:000000003356772

DTC	Display contents of CONSULT-III	DTC Detection Condition	Action to take
U1200	Cont Unit FLASH- ROM [U1200]	An internal malfunction is detected in AV control unit (FLASH-ROM).	Replace AV control unit.

U1216 AV CONTROL UNIT

< COMPONENT DIAGNOSIS >

[BOSE AUDIO WITHOUT NAVIGATION]

U1216 AV CONTROL UNIT

Description

INFOID:000000003470018

Replace the AV control unit if this DTC is displayed. Refer to [AV-522. "Exploded View"](#).

Part name	Description
AV CONTROL UNIT	<ul style="list-style-type: none">• It is the master unit of the MULTI AV system, and it is connected to each control unit by communication. It operates each system according to communication signals from the AV control unit.• AV control unit includes audio function and vehicle information function.• It is connected to ECM, A/C auto amp. and combination meter via CAN communication to obtain necessary information for the vehicle information function.• It is connected to BCM via CAN communication transmitting/receiving for the vehicle settings function.• It inputs the illumination signals that are required for the display dimming control.• It inputs the signals for driving status recognition (vehicle speed, reverse and parking brake).• The camera image signal is input from the camera control unit. The AV control unit outputs camera image signal to the front display unit.• BOSE amp. ON signal and sound signal are transmitted to BOSE amp.• Power (signal VCC and inverter VCC) is transmitted to front display. Without DVD entertainment system• Auxiliary image and auxiliary sound signals are input from the auxiliary input jacks. With DVD entertainment system• Composite image signal (auxiliary and DVD images) is input from the video distributor.• Sound signal (DVD and auxiliary sounds) is input from the DVD player.

DTC Logic

INFOID:000000003356774

DTC	Display contents of CONSULT-III	DTC Detection Condition	Action to take
U1216	CAN CONT [U1216]	Internal malfunction of AV control unit (CAN controller) is detected.	Replace AV control unit.

A
B
C
D
E
F
G
H
I
J
K
L
M

AV

O
P

U1243 DISPLAY UNIT

< COMPONENT DIAGNOSIS >

[BOSE AUDIO WITHOUT NAVIGATION]

U1243 DISPLAY UNIT

Description

INFOID:000000003356775

Part name	Description
FRONT DISPLAY UNIT	<ul style="list-style-type: none"> • Front display image is controlled by the serial communication from AV control unit. • It receives the power (signal VCC and inverter VCC) from the AV control unit and operates. • RGB image signal is input from AV control unit (RGB, RGB area and RGB synchronizing). • Synchronizing signal (HP, VP) is output to AV control unit. • Camera image signal is input from AV control unit. Without DVD entertainment system • Auxiliary image signal is input from AV control unit. With DVD entertainment system • Composite image signal (auxiliary and DVD images) is input from the AV control unit.

DTC Logic

INFOID:000000003356776

DTC	Display contents of CONSULT-III	DTC Detection Condition	Possible causes
U1243	FRONT DISP CONN [U1243]	When either one of the following items are detected: <ul style="list-style-type: none"> • front display unit power supply and ground circuits are malfunctioning. • serial communication circuits between AV control unit and front display unit are malfunctioning. • serial communication signal between AV control unit and front display unit is malfunctioning. 	<ul style="list-style-type: none"> • Front display unit power supply and ground circuits. • Serial communication circuits between AV control unit and front display unit.

Diagnosis Procedure

INFOID:000000003356777

1. CHECK DISPLAY UNIT POWER SUPPLY AND GROUND CIRCUIT

Check front display unit power supply and ground circuit. Refer to [AV-103, "FRONT DISPLAY UNIT : Diagnosis Procedure"](#).

Is the inspection result normal?

YES >> GO TO 2.

NO >> Repair malfunctioning parts.

2. CHECK CONTINUITY COMMUNICATION CIRCUIT

1. Turn ignition switch OFF.
2. Disconnect front display unit connector and AV control unit connector.
3. Check continuity between front display unit harness connector and AV control unit harness connector.

Front display unit		AV control unit		Continuity
Connector	Terminals	Connector	Terminals	
M49	11	M129	56	Existed
	22		44	

4. Check continuity between front display unit harness connector and ground.

Front display unit		Ground	Continuity
Connector	Terminals		
M49	11		Not existed
	22		

U1243 DISPLAY UNIT

[BOSE AUDIO WITHOUT NAVIGATION]

< COMPONENT DIAGNOSIS >

Is the inspection result normal?

- YES >> GO TO 3.
- NO >> Repair harness or connector.

3.CHECK COMMUNICATION SIGNAL

1. Connect front display unit connector and AV control unit connector.
2. Turn ignition switch ON.
3. Check signal between front display unit harness connector and ground using an oscilloscope.

(+)		(-)	Condition	Signal
Front display unit				
Connector	Terminal			
M49	11	Ground	When adjusting display brightness.	

Is the inspection result normal?

- YES >> GO TO 4.
- NO >> Replace AV control unit.

4.CHECK COMMUNICATION SIGNAL

Check signal between front display unit harness connector and ground using an oscilloscope.

(+)		(-)	Condition	Signal
Front display unit				
Connector	Terminal			
M49	22	Ground	When adjusting display brightness.	

Is the inspection result normal?

- YES >> INSPECTION END
- NO >> Replace front display unit.

A
B
C
D
E
F
G
H
I
J
K
L
M

AV

O
P

U1247 REAR DISP CONN

< COMPONENT DIAGNOSIS >

[BOSE AUDIO WITHOUT NAVIGATION]

U1247 REAR DISP CONN

Description

INFOID:000000003470084

Part name	Description
REAR DISPLAY UNIT	<ul style="list-style-type: none"> The rear display unit has functions of remote control receiver and headphone amp. Transmits the headphone sound signal when receiving headphone ON signal from the video distributor. Headphone sound signal is input from DVD player via hard wires and outputs the signal to headphones via infrared wireless communication. Receives the operation signal from the remote controller and transmits the signal to the video distributor via serial communication. Rear display image is controlled by the serial communication from video distributor. RGB image signal is input from video distributor (RGB image and RGB area). Composite image signal (DVD and auxiliary images) is input from the video distributor. Synchronize signal (HP, VP) is output to video distributor.

DTC Logic

INFOID:000000003470085

DTC	Display contents of CONSULT-III	DTC Detection Condition	Possible causes
U1247	REAR DISP CONN [U1247]	When either one of the following items are detected: <ul style="list-style-type: none"> rear display unit power supply and ground circuits are malfunctioning. serial communication circuits between video distributor and rear display unit are malfunctioning. serial communication signal between video distributor and rear display unit is malfunctioning. 	<ul style="list-style-type: none"> Rear display unit power supply and ground circuits. Serial communication circuits between video distributor and rear display unit.

Diagnosis Procedure

INFOID:000000003470086

1. CHECK REAR DISPLAY UNIT POWER SUPPLY AND GROUND CIRCUIT

Check rear display unit power supply and ground circuits. Refer to [AV-104, "REAR DISPLAY UNIT : Diagnosis Procedure"](#).

Is the inspection result normal?

YES >> GO TO 2.

NO >> Repair malfunctioning parts.

2. CHECK CONTINUITY SERIAL COMMUNICATION CIRCUIT

- Turn ignition switch OFF.
- Disconnect rear display unit connector and video distributor connector.
- Check continuity between rear display unit harness connector and video distributor harness connector.

Rear display unit		Video distributor		Continuity
Connector	Terminals	Connector	Terminals	
R152	9	M257	39	Existed
	10		40	

- Check continuity between rear display unit harness connector and ground.

U1247 REAR DISP CONN

[BOSE AUDIO WITHOUT NAVIGATION]

< COMPONENT DIAGNOSIS >

Rear display unit		Ground	Continuity
Connector	Terminals		
R152	9		Not existed
	10		

Is the inspection result normal?

YES >> GO TO 3.

NO >> Repair harness or connector.

3. CHECK SERIAL COMMUNICATION SIGNAL

1. Connect rear display unit connector and video distributor connector.
2. Turn ignition switch ON.
3. Check signal between rear display unit harness connector and ground using an oscilloscope.

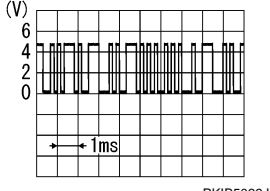
(+)		(-)	Condition	Signal
Front display unit				
Connector	Terminal			
R152	9	Ground	Rear seat remote controller operation.	

Is the inspection result normal?

YES >> GO TO 4.

NO >> Replace rear display unit.

4. CHECK SERIAL COMMUNICATION SIGNAL

Check signal between rear display unit harness connector and ground using an oscilloscope.

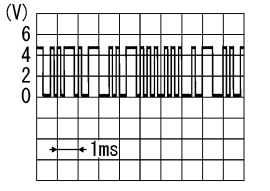
(+)		(-)	Condition	Signal
Front display unit				
Connector	Terminal			
R152	10	Ground	Rear seat remote controller operation.	

Is the inspection result normal?

YES >> INSPECTION END

NO >> Replace video distributor.

A
B
C
D
E
F
G
H
I
J
K
L
M
AV
O
P

U1250 CAMERA CONTROL UNIT

< COMPONENT DIAGNOSIS >

[BOSE AUDIO WITHOUT NAVIGATION]

U1250 CAMERA CONTROL UNIT

Description

INFOID:000000003470087

Part name	Description
CAMERA CONTROL UNIT	<ul style="list-style-type: none">• Camera image signal is input from rear view camera. Camera image signal output to AV control unit.• Power (camera ON signal) is transmitted to rear view camera.• AV control unit recognizes the presence of camera system with camera connection recognition signal.• Camera control unit is connected via AV communication.

DTC Logic

INFOID:000000003470088

DTC	Display contents of CONSULT-III	DTC Detection Condition	Possible causes
U1250	CAMERA CONT. CONN [U1250]	Malfunction is detected in camera-connection recognition signal circuit.	Camera-connection recognition signal circuit.

Diagnosis Procedure

INFOID:000000003470089

1. CHECK CAMERA-CONNECTION RECOGNITION SIGNAL CIRCUIT

1. Turn ignition switch OFF.
2. Disconnect AV control unit connector and camera control unit connector.
3. Check continuity between AV control unit harness connector and camera control unit harness connector.

AV control unit		Camera control unit		Continuity
Connector	Terminal	Connector	Terminal	
M130	68	B60	14	Existed

Is the inspection result normal?

- YES >> GO TO 2.
NO >> Repair harness or connector.

2. CHECK AV CONTROL UNIT VOLTAGE

1. Connect AV control unit connector.
2. Turn ignition switch ON.
3. Check voltage between AV control unit harness connector and ground.

(+)		(-)	Voltage (Approx.)
AV control unit			
Connector	Terminal		
M130	68	Ground	5.0 V

Is the inspection result normal?

- YES >> Replace camera control unit.
NO >> Replace AV control unit.

U1255 SATELLITE RADIO TUNER

< COMPONENT DIAGNOSIS >

[BOSE AUDIO WITHOUT NAVIGATION]

U1255 SATELLITE RADIO TUNER

Description

INFOID:000000003356778

Part name	Description
SATELLITE RADIO TUNER	<ul style="list-style-type: none"> Inputs the satellite radio signal from satellite radio antenna and outputs the sound signal to the AV control unit. It is controlled with the AV control unit and serial communication (communication signal and request signal).

DTC Logic

INFOID:000000003356779

DTC	Display contents of CONSULT-III	DTC Detection Condition	Possible causes
U1255	SAT CONN [U1255]	When either one of the following items are detected: <ul style="list-style-type: none"> satellite radio tuner power supply and ground circuits are malfunctioning. serial communication circuits between AV control unit and satellite radio tuner are malfunctioning. serial communication or request signal between AV control unit and satellite radio tuner is malfunctioning. request signal circuit between AV control unit and satellite radio tuner is malfunctioning. 	<ul style="list-style-type: none"> Satellite radio tuner power supply and ground circuits. Serial communication circuits between AV control unit and satellite radio tuner. Request signal circuit between AV control unit and satellite radio tuner.

Diagnosis Procedure

INFOID:000000003356780

1. CHECK SATELLITE RADIO TUNER POWER SUPPLY AND GROUND CIRCUIT

Check satellite radio tuner power supply and ground circuit. Refer to [AV-109, "SATELLITE RADIO TUNER : Diagnosis Procedure"](#).

Is the inspection result normal?

YES >> GO TO 2.

NO >> Repair malfunctioning parts.

2. CHECK CONTINUITY COMMUNICATION CIRCUIT AND REQUEST SIGNAL CIRCUIT

- Turn ignition switch OFF.
- Disconnect AV control unit connector and satellite radio tuner connector.
- Check continuity between AV control unit harness connector terminals and satellite radio tuner harness connector terminals.

AV control unit		Satellite radio tuner		Continuity
Connector	Terminals	Connector	Terminals	
M128	28	B48	8	Existed
	29		9	
	30		10	

- Check continuity between AV control unit harness connector terminals and ground.

AV control unit		Ground	Continuity
Connector	Terminals		
M128	28		Not existed
	29		
	30		

Is the inspection result normal?

YES >> GO TO 3.

U1255 SATELLITE RADIO TUNER

[BOSE AUDIO WITHOUT NAVIGATION]

< COMPONENT DIAGNOSIS >

NO >> Repair harness or connector.

3. CHECK AV CONTROL UNIT VOLTAGE

1. Connect AV control unit connector.
2. Turn ignition switch ON.
3. Check voltage between AV control unit harness connector terminal and ground.

(+)		(-)	Voltage (Approx.)
AV control unit			
Connector	Terminals		
M128	28	Ground	7.0 V
	29		

Is the inspection result normal?

YES >> GO TO 4.

NO >> Replace AV control unit.

4. CHECK SATELLITE RADIO TUNER

1. Turn ignition switch OFF.
2. Disconnect AV control unit connector.
3. Connect satellite radio tuner.
4. Turn ignition switch ON.
5. Check voltage between satellite radio tuner harness connector terminal ground.

(+)		(-)	Voltage (Approx.)
Satellite radio tuner			
Connector	Terminal		
B48	10	Ground	7.0 V

Is the inspection result normal?

YES >> INSPECTION END

NO >> Replace satellite radio tuner.

U1300 AV COMM CIRCUIT

< COMPONENT DIAGNOSIS >

[BOSE AUDIO WITHOUT NAVIGATION]

U1300 AV COMM CIRCUIT

Description

INFOID:000000003356781

U1300 is indicated when malfunction occurs in communication signal of multi AV system. Indicated simultaneously, without fail, with the malfunction of control units connected to AV control unit with communication line. Determine the possible malfunction cause from the table below.

SELF-DIAGNOSIS RESULTS DISPLAY ITEM

DTC	Display contents of CONSULT-III	DTC Detection Condition	Possible causes
U1300 U1240	<ul style="list-style-type: none"> AV COMM CIRCUIT [U1300] SWITCH CONN [U1240] 	When either one of the following items are detected: <ul style="list-style-type: none"> multifunction switch power supply and ground circuits are malfunctioning. AV communication circuits between AV control unit and multifunction switch are malfunctioning. AV communication signal between AV control unit and multifunction switch is malfunctioning. 	<ul style="list-style-type: none"> Multifunction switch power supply and ground circuits. AV communication circuits between AV control unit and multifunction switch.
U1300 U1246	<ul style="list-style-type: none"> AV COMM CIRCUIT [U1300] VIDEO DIST CONN [U1246] 	When either one of the following items are detected: <ul style="list-style-type: none"> video distributor power supply and ground circuits are malfunctioning. AV communication signal between AV control unit and video distributor is malfunctioning. 	Video distributor power supply and ground circuits.
U1300 U1248	<ul style="list-style-type: none"> AV COMM CIRCUIT [U1300] DVD DECK CONN [U1248] 	When either one of the following items are detected: <ul style="list-style-type: none"> DVD player power supply and ground circuits are malfunctioning. AV communication signal between AV control unit and DVD player is malfunctioning. 	DVD player power supply and ground circuits.
U1300 U1252	<ul style="list-style-type: none"> AV COMM CIRCUIT [U1300] REAR CAMERA LAN CONN [U1252] 	When either one of the following items are detected: <ul style="list-style-type: none"> camera control unit power supply and ground circuits are malfunctioning. AV communication signal between AV control unit and camera control unit is malfunctioning. AV communication circuits between multifunction and camera control unit is malfunctioning. (Without DVD entertainment system models) 	<ul style="list-style-type: none"> Camera control unit power supply and ground circuits. AV communication circuits between multifunction and camera control unit. (Without DVD entertainment system models)
U1300 U1254	<ul style="list-style-type: none"> AV COMM CIRCUIT [U1300] iPod CONN [U1254] 	When either one of the following items are detected: <ul style="list-style-type: none"> iPod adapter power supply and ground circuits are malfunctioning. AV communication circuits between multifunction switch and iPod adapter are malfunctioning. AV communication signal between AV control unit and iPod adapter is malfunctioning. 	<ul style="list-style-type: none"> iPod adapter power supply and ground circuits. AV communication circuits between multifunction switch unit and iPod adapter.
U1300 U1256	<ul style="list-style-type: none"> AV COMM CIRCUIT [U1300] HAND FREE CONN [U1256] 	When either one of the following items are detected: <ul style="list-style-type: none"> TEL adapter unit power supply and ground circuits are malfunctioning. AV communication circuits between camera control unit and TEL adapter unit are malfunctioning. AV communication signal between AV control unit and TEL adapter unit is malfunctioning. 	<ul style="list-style-type: none"> TEL adapter unit power supply and ground circuits. AV communication circuits between camera control unit and TEL adapter unit. AV communication circuits between multifunction switch and TEL adapter unit. (without rear view camera models)
U1300 U1252 U1256*	<ul style="list-style-type: none"> AV COMM CIRCUIT [U1300] REAR CAMERA LAN CONN [U1252] HAND FREE CONN [U1256]* 	When either one of the following items are detected: <ul style="list-style-type: none"> AV communication circuits between multifunction switch and camera control unit are malfunctioning. (without DVD player models) AV communication circuits between DVD player and camera control unit are malfunctioning. (with DVD player models) 	<ul style="list-style-type: none"> AV communication circuits between multifunction switch and camera control unit. (without DVD player models) AV communication circuits between DVD player and camera control unit. (with DVD player models)

A

B

C

D

E

F

G

H

I

J

K

L

M

AV

O

P

U1300 AV COMM CIRCUIT

< COMPONENT DIAGNOSIS >

[BOSE AUDIO WITHOUT NAVIGATION]

DTC	Display contents of CONSULT-III	DTC Detection Condition	Possible causes
U1300 U1248 U1252 U1256	<ul style="list-style-type: none"> • AV COMM CIRCUIT [U1300] • DVD DECK CONN [U1248] • REAR CAMERA LAN CONN [U1252] • HAND FREE CONN [U1256] 	Malfunction is detected in AV communication circuits between video distributor and DVD player.	AV communication circuits between video distributor and DVD player.
U1300 U1246 U1248 U1252 U1256	<ul style="list-style-type: none"> • AV COMM CIRCUIT [U1300] • VIDEO DIST CONN [U1246] • DVD DECK CONN [U1248] • REAR CAMERA LAN CONN [U1252] • HAND FREE CONN [U1256] 	Malfunction is detected in AV communication circuits between multifunction switch and video distributor.	AV communication circuits between multifunction switch and video distributor.
U1300 U1246 U1248 U1252 U1254 U1256	<ul style="list-style-type: none"> • AV COMM CIRCUIT [U1300] • VIDEO DIST CONN [U1246] • DVD DECK CONN [U1248] • REAR CAMERA LAN CONN [U1252] • IPod CONN [U1254] • HAND FREE CONN [U1256] 	Malfunction is detected in AV communication circuits between multifunction switch and iPod adapter.	AV communication circuits between multifunction switch and iPod adapter.
U1300 U1240 U1254* U1256*	<ul style="list-style-type: none"> • AV COMM CIRCUIT [U1300] • SWITCH CONN [U1240] • IPod CONN [U1254]* • HAND FREE CONN [U1256]* 	When either one of the following items are detected: <ul style="list-style-type: none"> • AV communication circuits between AV control unit and the branch point multifunction switch. • AV communication circuits are malfunctioning. 	<ul style="list-style-type: none"> • AV communication circuits between AV control unit and the branch point multifunction switch. • Check and repair the short circuit in AV communication circuits.
U1300 U1240 U1246 U1248 U1252 U1254 U1256	<ul style="list-style-type: none"> • AV COMM CIRCUIT [U1300] • SWITCH CONN [U1240] • VIDEO DIST CONN [U1246] • DVD DECK CONN [U1248] • REAR CAMERA LAN CONN [U1252] • IPod CONN [U1254] • HAND FREE CONN [U1256] 		

NOTE:

*: Non-equipped item is not displayed.

POWER SUPPLY AND GROUND CIRCUIT

< COMPONENT DIAGNOSIS >

[BOSE AUDIO WITHOUT NAVIGATION]

POWER SUPPLY AND GROUND CIRCUIT

AV CONTROL UNIT

AV CONTROL UNIT : Diagnosis Procedure

INFOID:000000003356782

1.CHECK FUSE

Check for blown fuses.

Power source	Fuse No.
Battery	35
Ignition switch ACC or ON	19
Ignition switch ON or START	3

Is the inspection result normal?

YES >> GO TO 2.

NO >> Be sure to eliminate the cause of malfunction before installing new fuse.

2.CHECK POWER SUPPLY CIRCUIT

Check voltage between AV control unit harness connectors and ground.

Signal name	Connector No.	Terminal No.	Ignition switch position	Value (Approx.)
Battery power supply	M127	19	OFF	Battery voltage
ACC power supply		7	ACC	
Ignition signal	M131	104	ON	

Is the inspection result normal?

YES >> GO TO 3.

NO >> Check harness between AV control unit and fuse.

3.CHECK GROUND CIRCUIT

1. Turn ignition switch OFF.
2. Disconnect AV control unit connectors.
3. Check continuity between AV control unit harness connectors and ground.

Signal name	Connector No.	Terminal No.	Ignition switch position	Continuity
Ground	M127	20	OFF	Existed
	M131	85		

Is the inspection result normal?

YES >> INSPECTION END

NO >> Repair harness or connector.

FRONT DISPLAY UNIT

FRONT DISPLAY UNIT : Diagnosis Procedure

INFOID:000000003356783

1.CHECK POWER SUPPLY CIRCUIT (FRONT DISPLAY SIDE)

Check voltage between front display unit harness connector and ground.

Signal name	Connector No.	Terminal No.	Ignition switch position	Value (Approx.)
Inverter VCC	M49	2	ACC	9.0 V
Signal VCC		3		

Is the inspection result normal?

YES >> GO TO 4.

NO >> GO TO 2.

A
B
C
D
E
F
G
H
I
J
K
L
M
O
P

AV

POWER SUPPLY AND GROUND CIRCUIT

< COMPONENT DIAGNOSIS >

[BOSE AUDIO WITHOUT NAVIGATION]

2.CHECK POWER SUPPLY CIRCUIT (CONTINUITY)

1. Turn ignition switch OFF.
2. Disconnect the harness connector between front display unit and AV control unit.
3. Check continuity between front display unit harness connector M49 and AV control unit harness connector M129.

Signal name	Display unit (M49)	AV control unit (M129)	Continuity
Inverter VCC	2	59	Existed
Signal VCC	3	47	Existed

4. Check continuity between front display unit harness connector M49 and ground.

Signal name	Display unit (M49)	—	Continuity
Inverter VCC	2	Ground	Not existed
Signal VCC	3	Ground	Not existed

Is the inspection result normal?

YES >> GO TO 3.

NO >> Repair harness or connector.

3.CHECK POWER SUPPLY CIRCUIT (AV CONTROL UNIT SIDE)

1. Connect the AV control unit harness connector.
2. Turn ignition switch ACC.
3. Check voltage between AV control unit harness connector and ground.

Signal name	Connector No.	Terminal No.	Ignition switch position	Value (Approx.)
Inverter VCC	M129	59	ACC	9.0 V
Signal VCC		47		

Is the inspection result normal?

YES >> INSPECTION END

NO >> Replace AV control unit.

4.CHECK GROUND CIRCUIT

1. Turn ignition switch OFF.
2. Disconnect front display unit connector.
3. Check continuity between front display unit harness connectors and ground.

Signal name	Connector No.	Terminal No.	Ignition switch position	Continuity
Ground	M49	1	OFF	Existed

Is the inspection result normal?

YES >> INSPECTION END

NO >> Repair harness or connector.

REAR DISPLAY UNIT

REAR DISPLAY UNIT : Diagnosis Procedure

INFOID:000000003509245

1.CHECK FUSE

Check for blown fuses.

Power source	Fuse No.
Battery	35
Ignition switch ACC or ON	19

Is the inspection result normal?

YES >> GO TO 2.

POWER SUPPLY AND GROUND CIRCUIT

< COMPONENT DIAGNOSIS >

[BOSE AUDIO WITHOUT NAVIGATION]

NO >> Be sure to eliminate the cause of malfunction before installing new fuse.

2.CHECK POWER SUPPLY CIRCUIT

Check voltage between rear display unit harness connector and ground.

Signal name	Connector No.	Terminal No.	Ignition switch position	Value (Approx.)
Battery power supply	R152	3	OFF	Battery voltage
		4		
ACC power supply	R152	6	ACC	

Is the inspection result normal?

YES >> GO TO 3.

NO >> Check harness between rear display unit and fuse.

3.CHECK GROUND CIRCUIT

1. Turn ignition switch OFF.
2. Disconnect rear display unit connector.
3. Check continuity between rear display unit harness connector and ground.

Signal name	Connector No.	Terminal No.	Ignition switch position	Continuity
Ground	R152	1	OFF	Existed
		2		

Is the inspection result normal?

YES >> INSPECTION END

NO >> Repair harness or connector.

VIDEO DISTRIBUTOR

VIDEO DISTRIBUTOR : Diagnosis Procedure

INFOID:000000003509246

1.CHECK FUSE

Check for blown fuses.

Power source	Fuse No.
Battery	35
Ignition switch ACC or ON	19
Ignition switch ON or START	3

Is the inspection result normal?

YES >> GO TO 2.

NO >> Be sure to eliminate the cause of malfunction before installing new fuse.

2.CHECK POWER SUPPLY CIRCUIT

Check voltage between video distributor harness connector and ground.

Signal name	Connector No.	Terminal No.	Ignition switch position	Value (Approx.)
Battery power supply	M255	54	OFF	Battery voltage
ACC power supply		55	ACC	
Ignition signal		56	ON	

Is the inspection result normal?

YES >> GO TO 3.

NO >> Check harness between video distributor and fuse.

3.CHECK GROUND CIRCUIT

1. Turn ignition switch OFF.
2. Disconnect video distributor connector.

POWER SUPPLY AND GROUND CIRCUIT

< COMPONENT DIAGNOSIS >

[BOSE AUDIO WITHOUT NAVIGATION]

3. Check continuity between video distributor harness connector and ground.

Signal name	Connector No.	Terminal No.	Ignition switch position	Continuity
Ground	M258	15	OFF	Existed
		16		
	M256	51		
	M255	53		

Is the inspection result normal?

YES >> INSPECTION END

NO >> Repair harness or connector.

DVD PLAYER

DVD PLAYER : Diagnosis Procedure

INFOID:000000003509247

1.CHECK FUSE

Check for blown fuses.

Power source	Fuse No.
Battery	35
Ignition switch ACC or ON	19

Is the inspection result normal?

YES >> GO TO 2.

NO >> Be sure to eliminate the cause of malfunction before installing new fuse.

2.CHECK POWER SUPPLY CIRCUIT

Check voltage between DVD player harness connector and ground.

Signal name	Connector No.	Terminal No.	Ignition switch position	Value (Approx.)
Battery power supply	M254	2	OFF	Battery voltage
ACC power supply		4	ACC	

Is the inspection result normal?

YES >> GO TO 3.

NO >> Check harness between DVD player and fuse.

3.CHECK GROUND CIRCUIT

1. Turn ignition switch OFF.
2. Disconnect DVD player connector.
3. Check continuity between DVD player harness connector and ground.

Signal name	Connector No.	Terminal No.	Ignition switch position	Continuity
Ground	M254	1	OFF	Existed

Is the inspection result normal?

YES >> INSPECTION END

NO >> Repair harness or connector.

MULTIFUNCTION SWITCH

MULTIFUNCTION SWITCH : Diagnosis Procedure

INFOID:000000003356784

1.CHECK FUSE

Check for blown fuses.

POWER SUPPLY AND GROUND CIRCUIT

< COMPONENT DIAGNOSIS >

[BOSE AUDIO WITHOUT NAVIGATION]

Power source	Fuse No.
Ignition switch ACC or ON	19

Is the inspection result normal?

YES >> GO TO 2.

NO >> Be sure to eliminate the cause of malfunction before installing new fuse.

2.CHECK POWER SUPPLY CIRCUIT

Check voltage between multifunction switch harness connector and ground.

Signal name	Connector No.	Terminal No.	Ignition switch position	Value (Approx.)
ACC power supply	M125	3	ACC	Battery voltage

Is the inspection result normal?

YES >> GO TO 3.

NO >> Check harness between multifunction switch and fuse.

3.CHECK GROUND CIRCUIT

1. Turn ignition switch OFF.
2. Disconnect multifunction switch connector.
3. Check continuity between multifunction switch harness connector and ground.

Signal name	Connector No.	Terminal No.	Ignition switch position	Continuity
Ground	M125	1	OFF	Existed

Is the inspection result normal?

YES >> INSPECTION END

NO >> Repair harness or connector.

BOSE AMP.

BOSE AMP. : Diagnosis Procedure

INFOID:000000003509248

1.CHECK FUSE

Check for blown fuses.

Power source	Fuse No.
Battery	23, 24

Is the inspection result normal?

YES >> GO TO 2.

NO >> Be sure to eliminate the cause of malfunction before installing new fuse.

2.CHECK POWER SUPPLY CIRCUIT

Check voltage between BOSE amp. harness connector and ground.

Signal name	Connector No.	Terminal No.	Ignition switch position	Value (Approx.)
Battery power supply	B224	10	OFF	Battery voltage
		11		

Is the inspection result normal?

YES >> GO TO 3.

NO >> Check harness between BOSE amp. and fuse.

3.CHECK GROUND CIRCUIT

1. Turn ignition switch OFF.
2. Disconnect BOSE amp. connector.
3. Check continuity between BOSE amp. harness connector and ground.

POWER SUPPLY AND GROUND CIRCUIT

< COMPONENT DIAGNOSIS >

[BOSE AUDIO WITHOUT NAVIGATION]

Signal name	Connector No.	Terminal No.	Ignition switch position	Continuity
Ground	B224	7	OFF	Existed
		12		

Is the inspection result normal?

YES >> INSPECTION END

NO >> Repair harness or connector.

WOOFER

WOOFER : Diagnosis Procedure

INFOID:000000003509249

1.CHECK FUSE

Check for blown fuses.

Power source	Fuse No.
Battery	25

Is the inspection result normal?

YES >> GO TO 2.

NO >> Be sure to eliminate the cause of malfunction before installing new fuse.

2.CHECK POWER SUPPLY CIRCUIT

Check voltage between woofer amp. harness connector and ground.

Signal name	Connector No.	Terminal No.	Ignition switch position	Value (Approx.)
Battery power supply	B28	6	OFF	Battery voltage

Is the inspection result normal?

YES >> GO TO 3.

NO >> Check harness between woofer amp. and fuse.

3.CHECK GROUND CIRCUIT

1. Turn ignition switch OFF.
2. Disconnect woofer amp. connector.
3. Check continuity between woofer amp. harness connector and ground.

Signal name	Connector No.	Terminal No.	Ignition switch position	Continuity
Ground	B28	5	OFF	Existed

Is the inspection result normal?

YES >> INSPECTION END

NO >> Repair harness or connector.

iPod ADAPTER

iPod ADAPTER : Diagnosis Procedure

INFOID:000000003509250

1.CHECK FUSE

Check for blown fuses.

Power source	Fuse No.
Battery	35
Ignition switch ACC or ON	19

Is the inspection result normal?

YES >> GO TO 2.

NO >> Be sure to eliminate the cause of malfunction before installing new fuse.

POWER SUPPLY AND GROUND CIRCUIT

< COMPONENT DIAGNOSIS >

[BOSE AUDIO WITHOUT NAVIGATION]

2.CHECK POWER SUPPLY CIRCUIT

Check voltage between iPod adapter harness connector and ground.

Signal name	Connector No.	Terminal No.	Ignition switch position	Value (Approx.)
Battery power supply	M148	5	OFF	Battery voltage
ACC power supply		3	ACC	

Is the inspection result normal?

YES >> INSPECTION END

NO >> Check harness between iPod adapter and fuse.

SATELLITE RADIO TUNER

SATELLITE RADIO TUNER : Diagnosis Procedure

INFOID:000000003356788

1.CHECK FUSE

Check for blown fuses.

Power source	Fuse No.
Battery	35
Ignition switch ACC or ON	19

Is the inspection result normal?

YES >> GO TO 2.

NO >> Be sure to eliminate the cause of malfunction before installing new fuse.

2.CHECK POWER SUPPLY CIRCUIT

Check voltage between satellite radio tuner harness connector and ground.

Signal name	Connector No.	Terminal No.	Ignition switch position	Value (Approx.)
Battery power supply	B48	12	OFF	Battery voltage
ACC power supply		16	ACC	

Is the inspection result normal?

YES >> GO TO 3.

NO >> Check harness between satellite radio tuner and fuse.

3.CHECK GROUND CIRCUIT

1. Turn ignition switch OFF.
2. Disconnect satellite radio tuner.
3. Check continuity between satellite radio tuner harness connector and ground.

Signal name	Connector No.	Terminal No.	Ignition switch position	Continuity
Ground	B48	15	OFF	Existed

Is the inspection result normal?

YES >> INSPECTION END

NO >> Repair harness or connector.

TEL ADAPTER UNIT

TEL ADAPTER UNIT : Diagnosis Procedure

INFOID:000000003356789

1.CHECK FUSE

Check for blown fuses.

POWER SUPPLY AND GROUND CIRCUIT

< COMPONENT DIAGNOSIS >

[BOSE AUDIO WITHOUT NAVIGATION]

Power source	Fuse No.
Battery	35
Ignition switch ACC or ON	19
Ignition switch ON or START	3

Is the inspection result normal?

YES >> GO TO 2.

NO >> Be sure to eliminate the cause of malfunction before installing new fuse.

2.CHECK POWER SUPPLY CIRCUIT

Check voltage between TEL adapter unit harness connector and ground.

Signal name	Connector No.	Terminal No.	Ignition switch position	Value (Approx.)
Battery power supply	B39	1	OFF	Battery voltage
ACC power supply		2	ACC	
Ignition signal		3	ON	

Is the inspection result normal?

YES >> GO TO 3.

NO >> Check harness between TEL adapter unit and fuse.

3.CHECK GROUND CIRCUIT

1. Turn ignition switch OFF.
2. Disconnect TEL adapter unit connector.
3. Check continuity between TEL adapter unit harness connector and ground.

Signal name	Connector No.	Terminal No.	Ignition switch position	Continuity
Ground	B39	4, 14, 20, 24	OFF	Existed

Is the inspection result normal?

YES >> INSPECTION END

NO >> Repair harness or connector.

RGB (R: RED) SIGNAL CIRCUIT (AV CONTROL UNIT TO FRONT DISPLAY UNIT)

< COMPONENT DIAGNOSIS >

[BOSE AUDIO WITHOUT NAVIGATION]

RGB (R: RED) SIGNAL CIRCUIT (AV CONTROL UNIT TO FRONT DISPLAY UNIT)

Description

INFOID:000000003509176

Transmit the image displayed with AV control unit with RGB image signal to the front display unit.

Diagnosis Procedure

INFOID:000000003509177

1. CHECK CONTINUITY RGB (R: RED) SIGNAL CIRCUIT

1. Turn ignition switch OFF.
2. Disconnect front display unit connector and AV control unit connector.
3. Check continuity between front display unit harness connector and AV control unit harness connector.

Front display unit		AV control unit		Continuity
Connector	Terminal	Connector	Terminal	
M49	17	M129	40	Existed

4. Check continuity between front display unit harness connector and ground.

Front display unit		Ground	Continuity
Connector	Terminal		
M49	17		Not existed

Is the inspection result normal?

YES >> GO TO 2.

NO >> Repair harness or connector.

2. CHECK RGB (R: RED) SIGNAL

1. Connect front display unit connector and AV control unit connector.
2. Turn ignition switch ON.
3. Check signal between front display unit harness connector and ground using an oscilloscope.

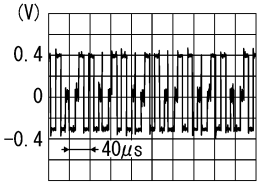
(+) Front display unit		(-)	Condition	Signal
Connector	Terminal			
M49	17	Ground	Start confirmation/adjustment mode, and then display color bar by selecting "Color Spectrum Bar" on DISPLAY DIAGNOSIS screen.	 <p>SKIB2238J</p>

Is the inspection result normal?

YES >> Replace front display unit.

NO >> Replace AV control unit.

RGB (G: GREEN) SIGNAL CIRCUIT (AV CONTROL UNIT TO FRONT DISPLAY UNIT)

< COMPONENT DIAGNOSIS >

[BOSE AUDIO WITHOUT NAVIGATION]

RGB (G: GREEN) SIGNAL CIRCUIT (AV CONTROL UNIT TO FRONT DISPLAY UNIT)

Description

INFOID:000000003509180

Transmit the image displayed with AV control unit with RGB image signal to the front display unit.

Diagnosis Procedure

INFOID:000000003509181

1. CHECK CONTINUITY RGB (G: GREEN) SIGNAL CIRCUIT

1. Turn ignition switch OFF.
2. Disconnect front display unit connector and AV control unit connector.
3. Check continuity between front display unit harness connector and AV control unit harness connector.

Front display unit		AV control unit		Continuity
Connector	Terminal	Connector	Terminal	
M49	6	M129	39	Existed

4. Check continuity between front display unit harness connector and ground.

Front display unit		Ground	Continuity
Connector	Terminal		
M49	6		Not existed

Is the inspection result normal?

YES >> GO TO 2.

NO >> Repair harness or connector.

2. CHECK RGB (G: GREEN) SIGNAL

1. Connect front display unit connector and AV control unit connector.
2. Turn ignition switch ON.
3. Check signal between front display unit harness connector and ground using an oscilloscope.

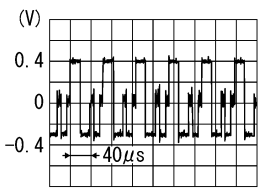
(+)		(-)	Condition	Signal
Front display unit				
Connector	Terminal			
M49	6	Ground	Start confirmation/adjustment mode, and then display color bar by selecting "Color Spectrum Bar" on DISPLAY DIAGNOSIS screen.	 <p style="text-align: right;">SKIB2236J</p>

Is the inspection result normal?

YES >> Replace front display unit.

NO >> Replace AV control unit.

RGB (B: BLUE) SIGNAL CIRCUIT (AV CONTROL UNIT TO FRONT DISPLAY UNIT)

< COMPONENT DIAGNOSIS >

[BOSE AUDIO WITHOUT NAVIGATION]

RGB (B: BLUE) SIGNAL CIRCUIT (AV CONTROL UNIT TO FRONT DISPLAY UNIT)

Description

INFOID:000000003509184

Transmit the image displayed with AV control unit with RGB image signal to the front display unit.

Diagnosis Procedure

INFOID:000000003509185

1. CHECK CONTINUITY RGB (B: BLUE) SIGNAL CIRCUIT

1. Turn ignition switch OFF.
2. Disconnect front display unit connector and AV control unit connector.
3. Check continuity between front display unit harness connector and AV control unit harness connector.

Front display unit		AV control unit		Continuity
Connector	Terminal	Connector	Terminal	
M49	18	M129	38	Existed

4. Check continuity between front display unit harness connector and ground.

Front display unit		Ground	Continuity
Connector	Terminal		
M49	18		Not existed

Is the inspection result normal?

YES >> GO TO 2.

NO >> Repair harness or connector.

2. CHECK RGB (B: BLUE) SIGNAL

1. Connect front display unit connector and AV control unit connector.
2. Turn ignition switch ON.
3. Check signal between front display unit harness connector and ground using an oscilloscope.

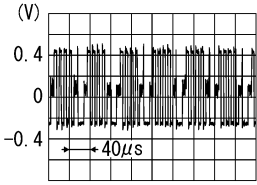
(+)		(-)	Condition	Signal
Front display unit				
Connector	Terminal			
M49	18	Ground	Start confirmation/adjustment mode, and then display color bar by selecting "Color Spectrum Bar" on DISPLAY DIAGNOSIS screen.	 <p>SKIB2237J</p>

Is the inspection result normal?

YES >> Replace front display unit.

NO >> Replace AV control unit.

RGB SYNCHRONIZING SIGNAL CIRCUIT

< COMPONENT DIAGNOSIS >

[BOSE AUDIO WITHOUT NAVIGATION]

RGB SYNCHRONIZING SIGNAL CIRCUIT

Description

INFOID:000000003356796

Transmit the RGB synchronizing signal to the front display unit so as to synchronize the RGB image displayed with AV control unit.

Diagnosis Procedure

INFOID:000000003356797

1. CHECK CONTINUITY RGB SYNCHRONIZING SIGNAL CIRCUIT

1. Turn ignition switch OFF.
2. Disconnect front display unit connector and AV control unit connector.
3. Check continuity between front display unit harness connector and AV control unit harness connector.

Front display unit		AV control unit		Continuity
Connector	Terminal	Connector	Terminal	
M49	19	M129	41	Existed

4. Check continuity between front display unit harness connector and ground.

Front display unit		Ground	Continuity
Connector	Terminal		
M49	19		Not existed

Is the inspection result normal?

- YES >> GO TO 2.
 NO >> Repair harness or connector.

2. CHECK RGB SYNCHRONIZING SIGNAL

1. Connect front display unit connector and AV control unit connector.
2. Turn ignition switch ON.
3. Check signal between front display unit harness connector and ground using an oscilloscope.

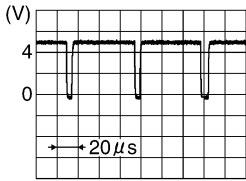
(+)		(-)	Condition	Signal
Front display unit				
Connector	Terminal			
M49	19	Ground	—	 <p>SKIB3603E</p>

Is the inspection result normal?

- YES >> Replace front display unit.
 NO >> Replace AV control unit.

RGB AREA (YS) SIGNAL CIRCUIT (AV CONTROL UNIT TO FRONT DISPLAY UNIT)

< COMPONENT DIAGNOSIS >

[BOSE AUDIO WITHOUT NAVIGATION]

RGB AREA (YS) SIGNAL CIRCUIT (AV CONTROL UNIT TO FRONT DISPLAY UNIT)

Description

INFOID:000000003509188

Transmits the display area of RGB image displayed by AV control unit with RGB area (YS) signal to front display unit.

Diagnosis Procedure

INFOID:000000003509189

1. CHECK CONTINUITY RGB AREA (YS) SIGNAL CIRCUIT

1. Turn ignition switch OFF.
2. Disconnect front display unit connector and AV control unit connector.
3. Check continuity between front display unit harness connector and AV control unit harness connector.

Front display unit		AV control unit		Continuity
Connector	Terminal	Connector	Terminal	
M49	9	M129	43	Existed

4. Check continuity between front display unit harness connector and ground.

Front display unit		Ground	Continuity
Connector	Terminal		
M49	9		Not existed

Is the inspection result normal?

YES >> GO TO 2.

NO >> Repair harness or connector.

2. CHECK RGB AREA (YS) SIGNAL

1. Connect front display unit connector and AV control unit connector.
2. Turn ignition switch ON.
3. Check signal between front display unit harness connector and ground using an oscilloscope.

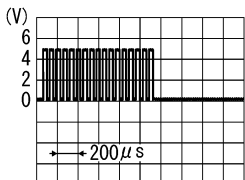
(+)		(-)	Condition	Signal
Front display unit				
Connector	Terminal			
M49	9	Ground	When RGB image is displayed.	Approx. 5.0 V
			When AUX image is displayed.	

PKIB4948J

Is the inspection result normal?

YES >> Replace front display unit.

NO >> Replace AV control unit.

HP SIGNAL CIRCUIT (FRONT DISPLAY UNIT TO AV CONTROL UNIT)

< COMPONENT DIAGNOSIS >

[BOSE AUDIO WITHOUT NAVIGATION]

HP SIGNAL CIRCUIT (FRONT DISPLAY UNIT TO AV CONTROL UNIT)

Description

INFOID:000000003509192

In composite image (DVD image, AUX image, camera image), transmit the vertical synchronizing (VP) signal and horizontal synchronizing (HP) signal from front display unit to AV control unit so as to synchronize the RGB images displayed with AV control unit such as the image quality adjusting menu, etc.

Diagnosis Procedure

INFOID:000000003509193

1. CHECK CONTINUITY HORIZONTAL SYNCHRONIZING (HP) SIGNAL CIRCUIT

1. Turn ignition switch OFF.
2. Disconnect front display unit connector and AV control unit connector.
3. Check continuity between front display unit harness connector and AV control unit harness connector.

Front display unit		AV control unit		Continuity
Connector	Terminal	Connector	Terminal	
M49	8	M129	45	Existed

4. Check continuity between front display unit harness connector and ground.

Front display unit		Ground	Continuity
Connector	Terminal		
M49	8		Not existed

Is the inspection result normal?

- YES >> GO TO 2.
 NO >> Repair harness or connector.

2. CHECK HORIZONTAL SYNCHRONIZING (HP) SIGNAL

1. Connect front display unit connector and AV control unit connector.
2. Turn ignition switch ON.
3. Check signal between front display unit harness connector and ground using an oscilloscope.

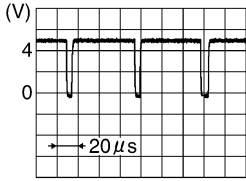
(+)		(-)	Condition	Signal
Front display unit				
Connector	Terminal			
M49	8	Ground	—	 <p>SKIB3603E</p>

Is the inspection result normal?

- YES >> Replace AV control unit.
 NO >> Replace front display unit.

VP SIGNAL CIRCUIT (FRONT DISPLAY UNIT TO AV CONTROL UNIT)

< COMPONENT DIAGNOSIS >

[BOSE AUDIO WITHOUT NAVIGATION]

VP SIGNAL CIRCUIT (FRONT DISPLAY UNIT TO AV CONTROL UNIT)

Description

INFOID:000000003509196

In composite image (DVD, AUX and camera image), transmit the vertical synchronizing (VP) signal and horizontal synchronizing (HP) signal from front display unit to AV control unit so as to synchronize the RGB images displayed with AV control unit such as the image quality adjusting menu, etc.

Diagnosis Procedure

INFOID:000000003509197

1. CHECK CONTINUITY VERTICAL SYNCHRONIZING (VP) SIGNAL CIRCUIT

1. Turn ignition switch OFF.
2. Disconnect front display unit connector and AV control unit connector.
3. Check continuity between front display unit harness connector and AV control unit harness connector.

Front display unit		AV control unit		Continuity
Connector	Terminal	Connector	Terminal	
M49	20	M129	57	Existed

4. Check continuity between front display unit harness connector and ground.

Front display unit		Ground	Continuity
Connector	Terminal		
M49	20		Not existed

Is the inspection result normal?

- YES >> GO TO 2.
 NO >> Repair harness or connector.

2. CHECK VERTICAL SYNCHRONIZING (VP) SIGNAL

1. Connect front display unit connector and AV control unit connector.
2. Turn ignition switch ON.
3. Check signal between front display unit harness connector and ground using an oscilloscope.

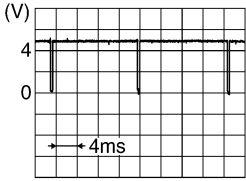
(+)		(-)	Condition	Signal
Front display unit				
Connector	Terminal			
M49	20	Ground	—	

Is the inspection result normal?

- YES >> Replace AV control unit.
 NO >> Replace front display unit.

COMPOSITE IMAGE SIGNAL CIRCUIT (AV CONTROL UNIT TO FRONT DISPLAY UNIT)

< COMPONENT DIAGNOSIS >

[BOSE AUDIO WITHOUT NAVIGATION]

COMPOSITE IMAGE SIGNAL CIRCUIT (AV CONTROL UNIT TO FRONT DISPLAY UNIT)

Description

INFOID:000000003510959

WITHOUT DVD ENTERTAINMENT SYSTEM

AV control unit that inputs the camera image signal and AUX image signal transmits the composite image signal to the front display unit.

WITH DVD ENTERTAINMENT SYSTEM

AV control unit receives the image signal from the video distributor and camera control unit and then transmits the composite image signal (AUX, DVD and camera image) to the front display unit.

Diagnosis Procedure

INFOID:000000003510960

1. CHECK CONTINUITY COMPOSITE IMAGE SIGNAL CIRCUIT

1. Turn ignition switch OFF.
2. Disconnect AV control unit connector and front display unit connector.
3. Check continuity between AV control unit harness connector and front display unit harness connector.

AV control unit		Front display unit		Continuity
Connector	Terminals	Connector	Terminals	
M129	36	M49	15	Existed
	37		4	

4. Check continuity between front display unit harness connector and ground.

Front display unit		Ground	Continuity
Connector	Terminal		
M49	15		Not existed

Is the inspection result normal?

YES >> GO TO 2.

NO >> Repair harness or connector.

2. CHECK COMPOSITE IMAGE SIGNAL

1. Connect AV control unit connector and front display unit connector.
2. Turn ignition switch ON.
3. Check signal between front display harness connector using an oscilloscope.

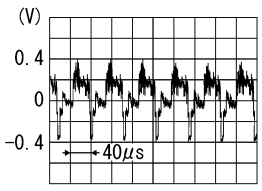
(+)		(-)		Condition	Signal
Front display unit		Front display unit			
Connector	Terminal	Connector	Terminal		
M49	15	M49	4	When AUX, DVD or camera image is displayed on front display.	 <p style="text-align: right; font-size: small;">SKIB2251J</p>

Is the inspection result normal?

YES >> Replace front display unit.

NO >> Replace AV control unit.

COMPOSITE IMAGE SIGNAL CIRCUIT (VIDEO DISTRIBUTOR TO AV CONTROL UNIT)

< COMPONENT DIAGNOSIS >

[BOSE AUDIO WITHOUT NAVIGATION]

COMPOSITE IMAGE SIGNAL CIRCUIT (VIDEO DISTRIBUTOR TO AV CONTROL UNIT)

Description

INFOID:000000003509204

Video distributor receives the image signal from the DVD player and auxiliary input jack and then transmits it to the AV control unit and rear display unit.

Diagnosis Procedure

INFOID:000000003509205

1. CHECK CONTINUITY COMPOSITE IMAGE SIGNAL CIRCUIT

1. Turn ignition switch OFF.
2. Disconnect video distributor connector and AV control unit connector.
3. Check continuity between video distributor harness connector and AV control unit harness connector.

Video distributor		AV control unit		Continuity
Connector	Terminals	Connector	Terminals	
M258	8	M130	66	Existed
	6		74	

4. Check continuity between AV control unit harness connector and ground.

AV control unit		Ground	Continuity
Connector	Terminal		
M130	66		Not existed

Is the inspection result normal?

YES >> GO TO 2.

NO >> Repair harness or connector.

2. CHECK COMPOSITE IMAGE SIGNAL

1. Connect video distributor connector and AV control unit connector.
2. Turn ignition switch ON.
3. Check signal between AV control unit harness connector using an oscilloscope.

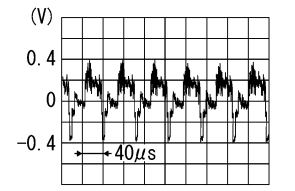
(+)		(-)		Condition	Signal
AV control unit		AV control unit			
Connector	Terminal	Connector	Terminal		
M130	66	M130	74	When AUX, DVD or camera image is displayed on front display.	

Is the inspection result normal?

YES >> Replace AV control unit.

NO >> Replace video distributor.

COMPOSITE IMAGE SIGNAL CIRCUIT (VIDEO DISTRIBUTOR TO REAR DISPLAY UNIT)

< COMPONENT DIAGNOSIS >

[BOSE AUDIO WITHOUT NAVIGATION]

COMPOSITE IMAGE SIGNAL CIRCUIT (VIDEO DISTRIBUTOR TO REAR DISPLAY UNIT)

Description

INFOID:000000003580075

Video distributor receives the image signal from the DVD player and auxiliary input jack and then transmits it to the AV control unit and rear display unit.

Diagnosis Procedure

INFOID:000000003580076

1. CHECK CONTINUITY COMPOSITE IMAGE SIGNAL CIRCUIT

1. Turn ignition switch OFF.
2. Disconnect video distributor connector and rear display unit connector.
3. Check continuity between video distributor harness connector and rear display unit harness connector.

Video distributor		Rear display unit		Continuity
Connector	Terminal	Connector	Terminal	
M257	34	R152	14	Existed

4. Check continuity between rear display unit harness connector and ground.

Rear display unit		Ground	Continuity
Connector	Terminal		
R152	14		Not existed

Is the inspection result normal?

YES >> GO TO 2.

NO >> Repair harness or connector.

2. CHECK COMPOSITE IMAGE SIGNAL

1. Connect video distributor connector and rear display unit connector.
2. Turn ignition switch ON.
3. Check signal between rear display unit harness connector using an oscilloscope.

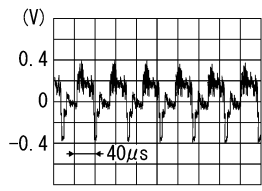
(+)		(-)	Condition	Signal
Rear display unit				
Connector	Terminal			
R152	14	Ground	When AUX, DVD or camera image is displayed on front display.	 <p>SKIB2251J</p>

Is the inspection result normal?

YES >> Replace rear display unit.

NO >> Replace video distributor.

RGB (R: RED) SIGNAL CIRCUIT (VIDEO DISTRIBUTOR TO REAR DISPLAY UNIT)

< COMPONENT DIAGNOSIS >

[BOSE AUDIO WITHOUT NAVIGATION]

RGB (R: RED) SIGNAL CIRCUIT (VIDEO DISTRIBUTOR TO REAR DISPLAY UNIT)

Description

INFOID:000000003509227

Transmit the image displayed with video distributor with RGB signal to the rear display unit.

Diagnosis Procedure

INFOID:000000003509228

1. CHECK CONTINUITY RGB (R: RED) SIGNAL CIRCUIT

1. Turn ignition switch OFF.
2. Disconnect rear display unit connector and video distributor connector.
3. Check continuity between rear display unit harness connector and video distributor harness connector.

Rear display unit		Video distributor		Continuity
Connector	Terminal	Connector	Terminal	
R152	22	M257	25	Existed

4. Check continuity between rear display unit harness connector and ground.

Rear display unit		Ground	Continuity
Connector	Terminal		
R152	22		Not existed

Is the inspection result normal?

- YES >> GO TO 2.
 NO >> Repair harness or connector.

2. CHECK RGB (R: RED) SIGNAL

1. Connect rear display unit connector and video distributor connector.
2. Turn ignition switch ON.
3. Check signal between rear display unit harness connector and ground using an oscilloscope.

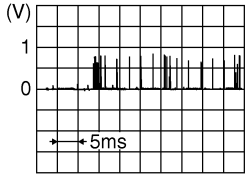
(+)		(-)	Condition	Signal
Rear display unit				
Connector	Terminal			
R152	22	Ground	Rear seat remote controller operation when AUX or DVD image is displayed on rear display unit.	 <p style="text-align: right; font-size: small;">JSNIA0984ZZ</p>

Is the inspection result normal?

- YES >> Replace rear display unit.
 NO >> Replace video distributor.

RGB (G: GREEN) SIGNAL CIRCUIT (VIDEO DISTRIBUTOR TO REAR DISPLAY UNIT)

< COMPONENT DIAGNOSIS >

[BOSE AUDIO WITHOUT NAVIGATION]

RGB (G: GREEN) SIGNAL CIRCUIT (VIDEO DISTRIBUTOR TO REAR DISPLAY UNIT)

Description

INFOID:000000003509229

Transmit the image displayed with video distributor with RGB signal to the rear display unit.

Diagnosis Procedure

INFOID:000000003509230

1. CHECK CONTINUITY RGB (G: GREEN) SIGNAL CIRCUIT

1. Turn ignition switch OFF.
2. Disconnect rear display unit connector and video distributor connector.
3. Check continuity between rear display unit harness connector and video distributor harness connector.

Rear display unit		Video distributor		Continuity
Connector	Terminal	Connector	Terminal	
R152	21	M257	26	Existed

4. Check continuity between rear display unit harness connector and ground.

Rear display unit		Ground	Continuity
Connector	Terminal		
R152	21		Not existed

Is the inspection result normal?

- YES >> GO TO 2.
 NO >> Repair harness or connector.

2. CHECK RGB (G: GREEN) SIGNAL

1. Connect rear display unit connector and video distributor connector.
2. Turn ignition switch ON.
3. Check signal between rear display unit harness connector and ground using an oscilloscope.

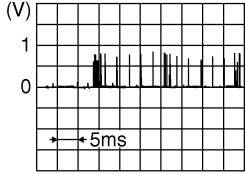
(+)		(-)	Condition	Signal
Rear display unit				
Connector	Terminal			
R152	21	Ground	Rear seat remote controller operation when AUX or DVD image is displayed on rear display unit.	 <p style="text-align: right;">JSNIA0984ZZ</p>

Is the inspection result normal?

- YES >> Replace rear display unit.
 NO >> Replace video distributor.

RGB (B: BLUE) SIGNAL CIRCUIT (VIDEO DISTRIBUTOR TO REAR DISPLAY UNIT)

< COMPONENT DIAGNOSIS >

[BOSE AUDIO WITHOUT NAVIGATION]

RGB (B: BLUE) SIGNAL CIRCUIT (VIDEO DISTRIBUTOR TO REAR DISPLAY UNIT)

Description

INFOID:000000003509231

Transmit the image displayed with video distributor with RGB signal to the rear display unit.

Diagnosis Procedure

INFOID:000000003509232

1. CHECK CONTINUITY RGB (B: BLUE) SIGNAL CIRCUIT

1. Turn ignition switch OFF.
2. Disconnect rear display unit connector and video distributor connector.
3. Check continuity between rear display unit harness connector and video distributor harness connector.

Rear display unit		Video distributor		Continuity
Connector	Terminal	Connector	Terminal	
R152	20	M257	28	Existed

4. Check continuity between rear display unit harness connector and ground.

Rear display unit		Ground	Continuity
Connector	Terminal		
R152	20		Not existed

Is the inspection result normal?

YES >> GO TO 2.

NO >> Repair harness or connector.

2. CHECK RGB (B: BLUE) SIGNAL

1. Connect rear display unit connector and video distributor connector.
2. Turn ignition switch ON.
3. Check signal between rear display unit harness connector and ground using an oscilloscope.

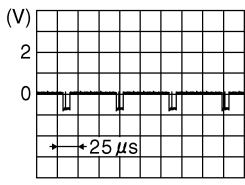
(+)		(-)	Condition	Signal
Rear display unit				
Connector	Terminal			
R152	20	Ground	Rear seat remote controller operation when AUX or DVD image is displayed on rear display unit.	 <p style="text-align: right;">JSNIA1090ZZ</p>

Is the inspection result normal?

YES >> Replace rear display unit.

NO >> Replace video distributor.

COMPOSITE SYNCHRONIZING SIGNAL CIRCUIT (VIDEO DISTRIBUTOR TO REAR DISPLAY UNIT)

< COMPONENT DIAGNOSIS >

[BOSE AUDIO WITHOUT NAVIGATION]

COMPOSITE SYNCHRONIZING SIGNAL CIRCUIT (VIDEO DISTRIBUTOR TO REAR DISPLAY UNIT)

Description

INFOID:000000003509233

Transmit the composite synchronizing signal to the rear display unit so as to synchronize the composite image displayed with video distributor.

Diagnosis Procedure

INFOID:000000003509234

1. CHECK CONTINUITY COMPOSITE SYNCHRONIZING SIGNAL CIRCUIT

1. Turn ignition switch OFF.
2. Disconnect rear display unit connector and video distributor connector.
3. Check continuity between rear display unit harness connector and video distributor harness connector.

Rear display unit		Video distributor		Continuity
Connector	Terminal	Connector	Terminal	
R152	13	M257	33	Existed

4. Check continuity between rear display unit harness connector and ground.

Rear display unit		Ground	Continuity
Connector	Terminal		
R152	13		Not existed

Is the inspection result normal?

YES >> GO TO 2.

NO >> Repair harness or connector.

2. CHECK COMPOSITE SYNCHRONIZING SIGNAL

1. Connect rear display unit connector and video distributor connector.
2. Turn ignition switch ON.
3. Check signal between rear display unit harness connector and ground using an oscilloscope.

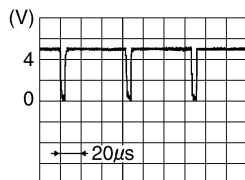
(+)		(-)	Condition	Signal
Rear display unit				
Connector	Terminal			
R152	13	Ground	When AUX or DVD image is displayed on rear display unit.	 <p style="text-align: right;">SKIB0825E</p>

Is the inspection result normal?

YES >> Replace rear display unit.

NO >> Replace video distributor.

RGB AREA (YS) SIGNAL CIRCUIT (VIDEO DISTRIBUTOR TO REAR DISPLAY UNIT)

< COMPONENT DIAGNOSIS >

[BOSE AUDIO WITHOUT NAVIGATION]

RGB AREA (YS) SIGNAL CIRCUIT (VIDEO DISTRIBUTOR TO REAR DISPLAY UNIT)

Description

INFOID:000000003580023

Transmits the display area of RGB image displayed by video distributor with RGB area (YS) signal to rear display unit.

Diagnosis Procedure

INFOID:000000003580024

1. CHECK CONTINUITY RGB AREA (YS) SIGNAL CIRCUIT

1. Turn ignition switch OFF.
2. Disconnect rear display unit connector and video distributor connector.
3. Check continuity between rear display unit harness connector and video distributor harness connector.

Rear display unit		Video distributor		Continuity
Connector	Terminal	Connector	Terminal	
R152	15	M257	32	Existed

4. Check continuity between rear display unit harness connector and ground.

Rear display unit		Ground	Continuity
Connector	Terminal		
R152	15		Not existed

Is the inspection result normal?

YES >> GO TO 2.

NO >> Repair harness or connector.

2. CHECK RGB AREA (YS) SIGNAL

1. Connect rear display unit connector and video distributor connector.
2. Turn ignition switch ON.
3. Check signal between rear display unit harness connector and ground using an oscilloscope.

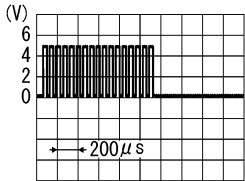
(+)		(-)	Condition	Signal
Rear display unit				
Connector	Terminal			
R152	15	Ground	When AUX or DVD image is displayed on rear display unit.	0 V
			Rear seat remote controller operation when AUX or DVD image is displayed on rear display unit.	 <p style="text-align: right;">PKIB4948J</p>

Is the inspection result normal?

YES >> Replace rear display unit.

NO >> Replace video distributor.

VP SIGNAL CIRCUIT (REAR DISPLAY UNIT TO VIDEO DISTRIBUTOR)

< COMPONENT DIAGNOSIS >

[BOSE AUDIO WITHOUT NAVIGATION]

VP SIGNAL CIRCUIT (REAR DISPLAY UNIT TO VIDEO DISTRIBUTOR)

Description

INFOID:000000003509235

In composite image (DVD and AUX images), transmit the vertical synchronizing (VP) signal and horizontal synchronizing (HP) signal from rear display unit to video distributor so as to synchronize the RGB images displayed with video distributor such as the image quality adjusting menu, etc.

Diagnosis Procedure

INFOID:000000003509236

1. CHECK CONTINUITY VERTICAL SYNCHRONIZING (VP) SIGNAL CIRCUIT

1. Turn ignition switch OFF.
2. Disconnect rear display unit connector and video distributor connector.
3. Check continuity between rear display unit harness connector and video distributor harness connector.

Rear display unit		Video distributor		Continuity
Connector	Terminal	Connector	Terminal	
R152	17	M257	29	Existed

4. Check continuity between rear display unit harness connector and ground.

Rear display unit		Ground	Continuity
Connector	Terminal		
R152	17		Not existed

Is the inspection result normal?

YES >> GO TO 2.

NO >> Repair harness or connector.

2. CHECK VERTICAL SYNCHRONIZING (VP) SIGNAL

1. Connect rear display unit connector and video distributor connector.
2. Turn ignition switch ON.
3. Check signal between rear display unit harness connector and ground using an oscilloscope.

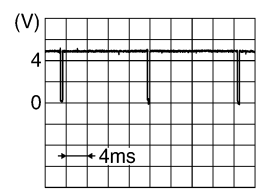
(+) Rear display unit		(-)	Condition	Signal
Connector	Terminal			
R152	17	Ground	—	 SKIB3598E

Is the inspection result normal?

YES >> Replace video distributor.

NO >> Replace rear display unit.

HP SIGNAL CIRCUIT (REAR DISPLAY UNIT TO VIDEO DISTRIBUTOR)

< COMPONENT DIAGNOSIS >

[BOSE AUDIO WITHOUT NAVIGATION]

HP SIGNAL CIRCUIT (REAR DISPLAY UNIT TO VIDEO DISTRIBUTOR)

Description

INFOID:000000003509237

In composite image (DVD and AUX images), transmit the vertical synchronizing (VP) signal and horizontal synchronizing (HP) signal from rear display unit to video distributor so as to synchronize the RGB images displayed with video distributor such as the image quality adjusting menu, etc.

Diagnosis Procedure

INFOID:000000003509238

1. CHECK CONTINUITY HORIZONTAL SYNCHRONIZING (HP) SIGNAL CIRCUIT

1. Turn ignition switch OFF.
2. Disconnect rear display unit connector and video distributor connector.
3. Check continuity between rear display unit harness connector and video distributor harness connector.

Rear display unit		Video distributor		Continuity
Connector	Terminal	Connector	Terminal	
R152	18	M257	30	Existed

4. Check continuity between rear display unit harness connector and ground.

Rear display unit		Ground	Continuity
Connector	Terminal		
R152	18		Not existed

Is the inspection result normal?

- YES >> GO TO 2.
 NO >> Repair harness or connector.

2. CHECK HORIZONTAL SYNCHRONIZING (HP) SIGNAL

1. Connect rear display unit connector and video distributor connector.
2. Turn ignition switch ON.
3. Check signal between rear display unit harness connector and ground using an oscilloscope.

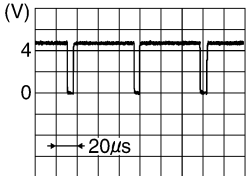
(+)		(-)	Condition	Signal
Rear display unit				
Connector	Terminal			
R152	18	Ground	—	 <p style="text-align: right;">SKIB3601E</p>

Is the inspection result normal?

- YES >> Replace video distributor.
 NO >> Replace rear display unit.

A
B
C
D
E
F
G
H
I
J
K
L
M
O
P

AV

AUX IMAGE SIGNAL CIRCUIT

< COMPONENT DIAGNOSIS >

[BOSE AUDIO WITHOUT NAVIGATION]

AUX IMAGE SIGNAL CIRCUIT WITHOUT DVD ENTERTAINMENT SYSTEM

WITHOUT DVD ENTERTAINMENT SYSTEM : Description

INFOID:000000003509223

- Transmits the image signal of AUX device from auxiliary input jacks to AV control unit.
- AV control unit transmits the image signal that is input to the front display unit.

WITHOUT DVD ENTERTAINMENT SYSTEM : Diagnosis Procedure

INFOID:000000003509224

1. CHECK CONTINUITY AUX IMAGE SIGNAL CIRCUIT (AUX INPUT JACKS AND AV CONTROL UNIT)

1. Turn ignition switch OFF.
2. Disconnect auxiliary input jacks connector and AV control unit connector.
3. Check continuity between auxiliary input jacks harness connector and AV control unit harness connector.

Auxiliary input jacks		AV control unit		Continuity
Connector	Terminals	Connector	Terminals	
M253	7	M130	66	Existed
	8		74	

4. Check continuity between AV control unit harness connector and ground.

AV control unit		Ground	Continuity
Connector	Terminal		
M130	66		Not existed

Is the inspection result normal?

YES >> GO TO 2.

NO >> Repair harness or connector.

2. CHECK AUX IMAGE SIGNAL (AUX INPUT JACKS TO AV CONTROL UNIT)

1. Connect auxiliary connector and AV control unit connector.
2. Turn ignition switch ON.
3. Check signal between AV control unit harness connector using an oscilloscope.

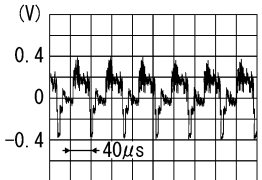
(+)		(-)		Condition	Signal
AV control unit		AV control unit			
Connector	Terminal	Connector	Terminal		
M130	66	M130	74	When AUX image is displayed on front display.	 <p>SKIB2251J</p>

Is the inspection result normal?

YES >> GO TO 3.

NO >> Check that there is no malfunction in the external device.

3. CHECK CONTINUITY AUX IMAGE SIGNAL CIRCUIT (AV CONTROL UNIT AND FRONT DISPLAY UNIT)

1. Turn ignition switch OFF.
2. Disconnect front display unit connector and AV control unit connector.
3. Check continuity between front display unit harness connector and AV control unit harness connector.

AUX IMAGE SIGNAL CIRCUIT

< COMPONENT DIAGNOSIS >

[BOSE AUDIO WITHOUT NAVIGATION]

AV control unit		Front display unit		Continuity
Connector	Terminals	Connector	Terminals	
M129	36	M49	15	Existed
	37		4	

4. Check continuity between front display unit harness connector and ground.

Front display unit		Ground	Continuity
Connector	Terminal		
M49	15		Not existed

Is the inspection result normal?

YES >> GO TO 4.

NO >> Repair harness or connector.

4.CHECK AUX IMAGE SIGNAL

1. Connect AV control unit connector and front display unit connector.
2. Turn ignition switch ON.
3. Check signal between front display unit harness connector using an oscilloscope.

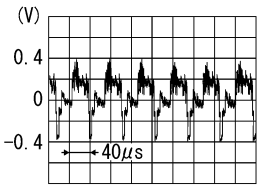
(+)		(-)		Condition	Signal
Front display unit		Front display unit			
Connector	Terminal	Connector	Terminal		
M49	15	M49	4	When AUX image is displayed on front display.	 <p style="text-align: right; font-size: small;">SKIB2251J</p>

Is the inspection result normal?

YES >> Replace front display unit.

NO >> Replace AV control unit.

WITH DVD ENTERTAINMENT SYSTEM

WITH DVD ENTERTAINMENT SYSTEM : Description

INFOID:000000003509221

Transmits the image signal of external device from auxiliary input jacks to video distributor.

WITH DVD ENTERTAINMENT SYSTEM : Diagnosis Procedure

INFOID:000000003509222

1.CHECK CONTINUITY AUX IMAGE SIGNAL CIRCUIT

1. Turn ignition switch OFF.
2. Disconnect auxiliary input jacks connector and video distributor connector.
3. Check continuity between auxiliary input jacks harness connector and video distributor harness connector.

Auxiliary input jacks		Video distributor		Continuity
Connector	Terminals	Connector	Terminals	
M253	7	M258	19	Existed
	8		21	

4. Check continuity between video distributor harness connector and ground.

A
B
C
D
E
F
G
H
I
J
K
L
M
N
O
P

AV

AUX IMAGE SIGNAL CIRCUIT

[BOSE AUDIO WITHOUT NAVIGATION]

< COMPONENT DIAGNOSIS >

Video distributor		Ground	Continuity
Connector	Terminal		
M258	19		Not existed

Is the inspection result normal?

YES >> GO TO 2.

NO >> Repair harness or connector.

2. CHECK AUX IMAGE SIGNAL

1. Connect auxiliary input jacks connector and video distributor connector.
2. Turn ignition switch ON.
3. Check signal between video distributor harness connector using an oscilloscope.

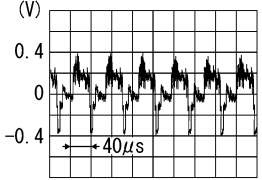
(+)		(-)		Condition	Signal
Video distributor		Video distributor			
Connector	Terminal	Connector	Terminal		
M258	19	M258	21	When AUX image is displayed.	 <p style="text-align: right; font-size: small;">SKIB2251J</p>

Is the inspection result normal?

YES >> Replace video distributor.

NO >> Check that there is no malfunction in the external device.

DVD IMAGE SIGNAL CIRCUIT

< COMPONENT DIAGNOSIS >

[BOSE AUDIO WITHOUT NAVIGATION]

DVD IMAGE SIGNAL CIRCUIT

Description

INFOID:000000003509225

The DVD player transmits the playback DVD image signal to the video distributor. The video distributor receives the image signal from the DVD player, and auxiliary input jack, and then transmits it to the AV control unit and rear display.

Diagnosis Procedure

INFOID:000000003509226

1. CHECK CONTINUITY DVD IMAGE SIGNAL CIRCUIT

1. Turn ignition switch OFF.
2. Disconnect DVD player connector and video distributor connector.
3. Check continuity between DVD player harness connector and video distributor harness connector.

DVD player		Video distributor		Continuity
Connector	Terminals	Connector	Terminals	
M254	7	M258	23	Existed
	5		22	

4. Check continuity between video distributor harness connector and ground.

Video distributor		Ground	Continuity
Connector	Terminal		
M258	23		Not existed

Is the inspection result normal?

YES >> GO TO 2.

NO >> Repair harness or connector.

2. CHECK DVD IMAGE SIGNAL

1. Connect DVD player connector and video distributor connector.
2. Turn ignition switch ON.
3. Check signal between video distributor harness connector and ground using an oscilloscope.

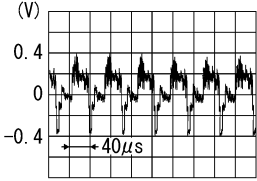
(+) Video distributor		(-)	Condition	Signal
Connector	Terminal			
M258	23	Ground	When DVD image is displayed.	 <p>SKIB2251J</p>

Is the inspection result normal?

YES >> Replace video distributor.

NO >> Replace DVD player.

A
B
C
D
E
F
G
H
I
J
K
L
M
O
P

AV

DISK EJECT SIGNAL CIRCUIT

< COMPONENT DIAGNOSIS >

[BOSE AUDIO WITHOUT NAVIGATION]

DISK EJECT SIGNAL CIRCUIT

Description

INFOID:000000003356806

The eject signal is output to AV control unit when the eject switch of multifunction switch is pressed.

Diagnosis Procedure

INFOID:000000003356807

1. CHECK CONTINUITY DISK EJECT SIGNAL CIRCUIT

1. Turn ignition switch OFF.
2. Disconnect multifunction switch connector and AV control unit connector.
3. Check continuity between multifunction switch harness connector and AV control unit harness connector.

Multifunction switch		AV control unit		Continuity
Connector	Terminal	Connector	Terminal	
M125	14	M131	103	Existed

4. Check continuity between multifunction switch harness connector and ground.

Multifunction switch		Ground	Continuity
Connector	Terminal		
M125	14		Not existed

Is the inspection result normal?

- YES >> GO TO 2.
NO >> Repair harness or connector.

2. CHECK AV CONTROL UNIT VOLTAGE

1. Connect AV control unit connector.
2. Turn ignition switch ON.
3. Check voltage between AV control unit harness connector and ground.

(+)		(-)	Voltage (Approx.)
AV control unit			
Connector	Terminal		
M131	103	Ground	3.3 V

Is the inspection result normal?

- YES >> Replace preset switch.
NO >> Replace AV control unit.

MICROPHONE SIGNAL CIRCUIT

< COMPONENT DIAGNOSIS >

[BOSE AUDIO WITHOUT NAVIGATION]

MICROPHONE SIGNAL CIRCUIT

Description

INFOID:000000003356808

Supply power from TEL adapter unit to microphone. The microphone transmits the sound/voice to the microphone.

Diagnosis Procedure

INFOID:000000003356809

1.CHECK CONTINUITY BETWEEN TEL ADAPTER UNIT AND MICROPHONE CIRCUIT

1. Turn ignition switch OFF.
2. Disconnect TEL adapter unit connector and microphone connector.
3. Check continuity between TEL adapter unit harness connector and microphone harness connector.

TEL adapter unit		Microphone		Continuity
Connector	Terminals	Connector	Terminals	
B39	7	R20	1	Existed
	8		2	
	29		4	

4. Check continuity between TEL adapter unit harness connector and ground.

TEL adapter unit		Ground	Continuity
Connector	Terminals		
B39	7		Not existed
	29		

Is the inspection result normal?

YES >> GO TO 2.

NO >> Repair harness or connector.

2.CHECK VOLTAGE MICROPHONE VCC

1. Connect TEL adapter unit connector.
2. Turn ignition switch ON.
3. Check voltage between TEL adapter unit harness connector.

(+)		(-)		Voltage (Approx.)
TEL adapter unit		TEL adapter unit		
Connector	Terminal	Connector	Terminal	
B39	29	B39	8	5.0 V

Is the inspection result normal?

YES >> GO TO 3.

NO >> Replace TEL adapter unit.

3.CHECK MICROPHONE SIGNAL

1. Connect microphone connector.
2. Check signal between TEL adapter unit harness connector using an oscilloscope.

A
B
C
D
E
F
G
H
I
J
K
L
M
AV
O
P

MICROPHONE SIGNAL CIRCUIT

< COMPONENT DIAGNOSIS >

[BOSE AUDIO WITHOUT NAVIGATION]

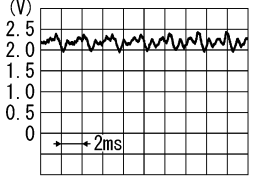
(+)		(-)		Condition	Signal
TEL adapter unit		TEL adapter unit			
Connector	Terminal	Connector	Terminal		
B39	7	B39	8	Give a voice	 <p style="text-align: right; font-size: small;">PKIB5037J</p>

Is the inspection result normal?

- YES >> Replace TEL adapter unit.
- NO >> Replace microphone.

CONTROL SIGNAL CIRCUIT

< COMPONENT DIAGNOSIS >

[BOSE AUDIO WITHOUT NAVIGATION]

CONTROL SIGNAL CIRCUIT

Description

INFOID:000000003356810

TEL adapter unit identifies the vehicle model according to the control signal and performs the control.

Diagnosis Procedure

INFOID:000000003356811

1. CHECK CONTINUITY CONTROL SIGNAL CIRCUIT

1. Turn ignition switch OFF.
2. Disconnect TEL adapter unit connector.
3. Check continuity between TEL adapter unit harness connector and ground.

TEL adapter unit		Ground	Continuity
Connector	Terminals		
B39	20		Existed
	24		

Is the inspection result normal?

- YES >> Replace TEL adapter unit.
NO >> Repair harness or connector.

A
B
C
D
E
F
G
H
I
J
K
L
M

AV

O
P

CAMERA IMAGE SIGNAL CIRCUIT (REAR VIEW CAMERA TO CAMERA CONTROL UNIT)

< COMPONENT DIAGNOSIS >

[BOSE AUDIO WITHOUT NAVIGATION]

CAMERA IMAGE SIGNAL CIRCUIT (REAR VIEW CAMERA TO CAMERA CONTROL UNIT)

Description

INFOID:000000003509239

- Camera control unit outputs camera ON signal to rear view camera and inputs rear view camera image signal from rear view camera when the reverse signal is input.
- The camera control unit that inputs the camera image signal transmits the camera image signal to the AV control unit.

Diagnosis Procedure

INFOID:000000003509240

1. CHECK CONTINUITY CAMERA IMAGE SIGNAL CIRCUIT

1. Turn ignition switch OFF.
2. Disconnect camera control unit connector and rear view camera connector.
3. Check continuity between camera control unit harness connector and rear view camera harness connector.

Camera control unit		Rear view camera		Continuity
Connector	Terminal	Connector	Terminal	
B60	6	D192	3	Existed

4. Check continuity between camera control unit harness connector and ground.

Camera control unit		Ground	Continuity
Connector	Terminal		
B60	6		Not existed

Is the inspection result normal?

- YES >> GO TO 2.
 NO >> Repair harness or connector.

2. CHECK CAMERA IMAGE SIGNAL

1. Connect camera control unit connector and rear view camera connector.
2. Turn ignition switch ON.
3. Check signal between camera control unit harness connector and ground using an oscilloscope.

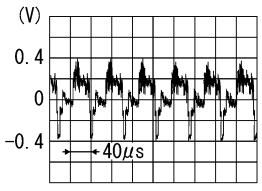
(+)		(-)	Condition	Signal
Camera control unit				
Connector	Terminal			
B60	6	Ground	Shift the selector lever to "R" position.	 <p style="text-align: right; font-size: small;">SKIB2251J</p>

Is the inspection result normal?

- YES >> Replace camera control unit.
 NO >> Replace rear view camera.

CAMERA ON SIGNAL CIRCUIT

< COMPONENT DIAGNOSIS >

[BOSE AUDIO WITHOUT NAVIGATION]

CAMERA ON SIGNAL CIRCUIT

Description

INFOID:000000003509241

- Camera control unit outputs camera ON signal to rear view camera and inputs rear view camera image signal from rear view camera when the reverse signal is input.
- The camera control unit that inputs the camera image signal transmits the camera image signal to the AV control unit.

Diagnosis Procedure

INFOID:000000003509242

1. CHECK CONTINUITY CAMERA ON SIGNAL CIRCUIT

1. Turn ignition switch OFF.
2. Disconnect camera control unit connector and rear view camera connector.
3. Check continuity between camera control unit harness connector and rear view camera harness connector.

Camera control unit		Rear view camera		Continuity
Connector	Terminal	Connector	Terminal	
B60	8	D192	1	Existed

4. Check continuity between camera control unit harness connector and ground.

Camera control unit		Ground	Continuity
Connector	Terminal		
B60	8		Not existed

Is the inspection result normal?

YES >> GO TO 2.

NO >> Repair harness or connector.

2. CHECK VOLTAGE CAMERA ON SIGNAL

1. Connect camera control unit connector and rear view camera connector.
2. Turn ignition switch ON.
3. Check signal between camera control unit harness connector and ground.

(+) Camera control unit		(-)	Condition	Voltage (Approx.)
Connector	Terminal			
B60	8	Ground	Shift the selector lever to "R" position.	6.0 V

Is the inspection result normal?

YES >> Replace rear view camera.

NO >> Replace camera control unit.

A
B
C
D
E
F
G
H
I
J
K
L
M
AV
O
P

CAMERA IMAGE SIGNAL CIRCUIT (CAMERA CONTROL UNIT TO AV CONTROL UNIT)

< COMPONENT DIAGNOSIS >

[BOSE AUDIO WITHOUT NAVIGATION]

CAMERA IMAGE SIGNAL CIRCUIT (CAMERA CONTROL UNIT TO AV CONTROL UNIT)

Description

INFOID:000000003509243

- Camera control unit outputs camera ON signal to rear view camera and inputs rear view camera image signal from rear view camera when the reverse signal is input.
- The camera control unit that inputs the camera image signal transmits the camera image signal to the AV control unit.

Diagnosis Procedure

INFOID:000000003509244

1. CHECK CONTINUITY CAMERA IMAGE SIGNAL CIRCUIT

1. Turn ignition switch OFF.
2. Disconnect camera control unit connector and AV control unit connector.
3. Check continuity between camera control unit harness connector and AV control unit harness connector.

Camera control unit		AV control unit		Continuity
Connector	Terminal	Connector	Terminal	
B60	12	M130	65	Existed
	11		64	

4. Check continuity between camera control unit harness connector and ground.

Camera control unit		Ground	Continuity
Connector	Terminal		
B60	12		Not existed

Is the inspection result normal?

- YES >> GO TO 2.
 NO >> Repair harness or connector.

2. CHECK CAMERA IMAGE SIGNAL

1. Connect camera control unit connector and AV control unit connector.
2. Turn ignition switch ON.
3. Check signal between camera control unit harness connector and ground using an oscilloscope.

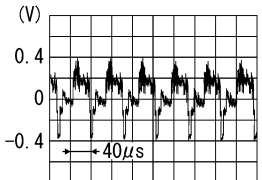
(+)		(-)	Condition	Signal
Camera control unit				
Connector	Terminal			
B60	12	Ground	Shift the selector lever to "R" position.	 <p style="text-align: right; font-size: small;">SKI B2251J</p>

Is the inspection result normal?

- YES >> Replace AV control unit.
 NO >> Replace camera control unit.

STEERING ANGLE SENSOR SIGNAL CIRCUIT

< COMPONENT DIAGNOSIS >

[BOSE AUDIO WITHOUT NAVIGATION]

STEERING ANGLE SENSOR SIGNAL CIRCUIT

Description

INFOID:000000003566415

- Steering angle sensor signal 1, 2 detects the turning direction and quantity of the steering and transmits it to the camera control unit.
- Steering angle sensor signal 3 detects the neutral position of the steering and transmits it to the camera control unit.
- Camera control unit performs the correction of neutral position with sensor signal 1, 2, 3 and vehicle speed signal.

Diagnosis Procedure

INFOID:000000003566416

1. CHECK CONTINUITY STEERING ANGLE SENSOR SIGNAL CIRCUIT

1. Turn ignition switch OFF.
2. Disconnect camera control unit connector and steering angle sensor connector.
3. Check continuity between camera control unit harness connector and steering angle sensor harness connector.

Camera control unit		Steering angle sensor		Continuity
Connector	Terminals	Connector	Terminals	
B60	23	M30	3	Existed
	24		6	
	25		8	

4. Check continuity between camera control unit harness connector and ground.

Camera control unit		Ground	Continuity
Connector	Terminals		
B60	23	Ground	Not existed
	24		
	25		

Is the inspection result normal?

YES >> GO TO 2.

NO >> Repair harness or connector.

2. CHECK VOLTAGE CAMERA CONTROL UNIT

1. Connect camera control unit connector.
2. Turn ignition switch ON.
3. Check voltage between camera control unit harness connector and ground.

(+)		(-)	Reference value (Approx.)
Connector	Terminals		
B60	23	Ground	5.0 V
	24		
	25		

Is the inspection result normal?

YES >> GO TO 3.

NO >> Replace camera control unit.

3. CHECK STEERING ANGLE SENSOR SIGNAL

1. Turn ignition switch OFF.
2. Connect steering angle sensor connector.

A
B
C
D
E
F
G
H
I
J
K
L
M
O
P

AV

STEERING ANGLE SENSOR SIGNAL CIRCUIT

[BOSE AUDIO WITHOUT NAVIGATION]

< COMPONENT DIAGNOSIS >

3. Turn ignition switch ON.
4. Check signal between camera control unit harness connector and ground.

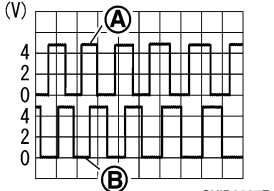
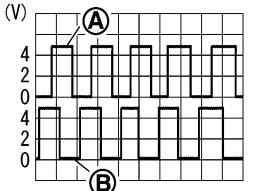
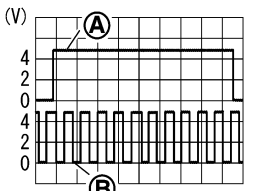
(+)		(-)	Condition	Reference value
Camera control unit				
Connector	Terminals			
B60	23, 24	Ground	Turn the steering to the right	 <p style="text-align: right; font-size: small;">SKIB3827E</p> <p>A: Sensor signal 1 B: Sensor signal 2</p>
			Turn the steering to the left	 <p style="text-align: right; font-size: small;">SKIB3828E</p> <p>A: Sensor signal 1 B: Sensor signal 2</p>
	25	Ground	Turn the steering around the neutral position	 <p style="text-align: right; font-size: small;">SKIB3829E</p> <p>A: Sensor signal 3 B: Sensor signal 1</p>

Is the inspection result normal?

- YES >> INSPECTION END
 NO >> Replace steering angle sensor.

STEERING SWITCH SIGNAL A CIRCUIT

< COMPONENT DIAGNOSIS >

[BOSE AUDIO WITHOUT NAVIGATION]

STEERING SWITCH SIGNAL A CIRCUIT

Description

INFOID:000000003356818

Transmits the steering switch signal to AV control unit.

Diagnosis Procedure

INFOID:000000003356819

1. CHECK STEERING SWITCH SIGNAL A CIRCUIT

1. Disconnect AV control unit connector and spiral cable connector.
2. Check continuity between AV control unit harness connector and spiral cable harness connector.

AV control unit		Spiral cable		Continuity
Connector	Terminal	Connector	Terminal	
M127	6	M33	24	Existed

3. Check continuity between AV control unit harness connector and ground.

AV control unit		Ground	Continuity
Connector	Terminal		
M127	6		Not existed

Is the inspection result normal?

- YES >> GO TO 2.
NO >> Repair harness or connector.

2. CHECK SPIRAL CABLE

Check spiral cable.

Is the inspection result normal?

- YES >> GO TO 3.
NO >> Replace spiral cable.

3. CHECK AV CONTROL UNIT VOLTAGE

1. Connect AV control unit connector and spiral cable connector.
2. Turn ignition switch ON.
3. Check voltage between AV control unit harness connector.

(+)		(-)		Voltage (Approx.)
AV control unit		AV control unit		
Connector	Terminal	Connector	Terminal	
M127	6	M127	15	3.3 V

Is the inspection result normal?

- YES >> GO TO 4.
NO >> Replace AV control unit.

4. CHECK STEERING SWITCH

1. Turn ignition switch OFF.
2. Check steering switch. Refer to [AV-142, "Component Inspection"](#).

Is the inspection result normal?

- YES >> INSPECTION END
NO >> Replace steering switch.

A
B
C
D
E
F
G
H
I
J
K
L
M
O
P

AV

STEERING SWITCH SIGNAL A CIRCUIT

[BOSE AUDIO WITHOUT NAVIGATION]

< COMPONENT DIAGNOSIS >

INFOID:000000003356820

Component Inspection

Measure the resistance between the steering switch connector terminals 14 to 17 and 15 to 17.

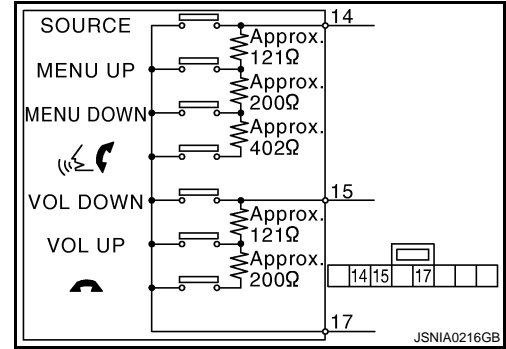

Standard

Steering switch				Condition	Resistance Ω
Con- nector	Termi- nal	Con- nector	Termi- nal		
M303	14	M303	17	☰ switch ON	709 – 737
				MENU DOWN switch ON	315 – 327
				MENU UP switch ON	119 – 123
				SOURCE switch ON	0
	15			☷ switch ON	315 – 327
				VOL UP switch ON	119 – 123
				VOL DOWN switch ON	0

STEERING SWITCH SIGNAL B CIRCUIT

< COMPONENT DIAGNOSIS >

[BOSE AUDIO WITHOUT NAVIGATION]

STEERING SWITCH SIGNAL B CIRCUIT

Description

INFOID:000000003356821

Transmits the steering switch signal to AV control unit.

Diagnosis Procedure

INFOID:000000003356822

1. CHECK STEERING SWITCH SIGNAL B CIRCUIT

1. Disconnect AV control unit connector and spiral cable connector.
2. Check continuity between AV control unit harness connector and spiral cable harness connector.

AV control unit		Spiral cable		Continuity
Connector	Terminal	Connector	Terminal	
M127	16	M33	31	Existed

3. Check continuity between AV control unit harness connector and ground.

AV control unit		Ground	Continuity
Connector	Terminal		
M127	16		Not existed

Is the inspection result normal?

- YES >> GO TO 2.
NO >> Repair harness or connector.

2. CHECK SPIRAL CABLE

Check spiral cable.

Is the inspection result normal?

- YES >> GO TO 3.
NO >> Replace spiral cable.

3. CHECK AV CONTROL UNIT VOLTAGE

1. Connect AV control unit connector and spiral cable connector.
2. Turn ignition switch ON.
3. Check voltage between AV control unit harness connector.

(+)		(-)		Voltage (Approx.)
AV control unit		AV control unit		
Connector	Terminal	Connector	Terminal	
M127	16	M127	15	3.3 V

Is the inspection result normal?

- YES >> GO TO 4.
NO >> Replace AV control unit.

4. CHECK STEERING SWITCH

1. Turn ignition switch OFF.
2. Check steering switch. Refer to [AV-144, "Component Inspection"](#).

Is the inspection result normal?

- YES >> INSPECTION END
NO >> Replace steering switch.

A
B
C
D
E
F
G
H
I
J
K
L
M
O
P

AV

STEERING SWITCH SIGNAL B CIRCUIT

< COMPONENT DIAGNOSIS >

[BOSE AUDIO WITHOUT NAVIGATION]

INFOID:000000003470186

Component Inspection

Measure the resistance between the steering switch connector terminals 14 to 17 and 15 to 17.

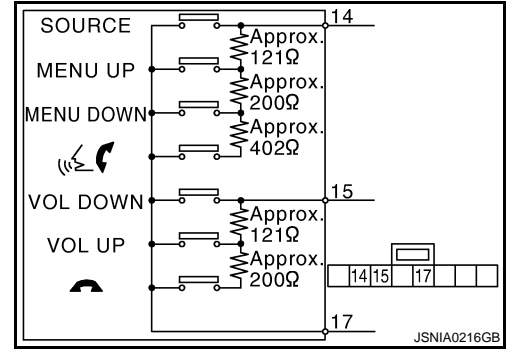

Standard

Steering switch				Condition	Resistance Ω
Con- nector	Termi- nal	Con- nector	Termi- nal		
M303	14	M303	17	☰ switch ON	709 – 737
				MENU DOWN switch ON	315 – 327
				MENU UP switch ON	119 – 123
				SOURCE switch ON	0
	15			☷ switch ON	315 – 327
				VOL UP switch ON	119 – 123
				VOL DOWN switch ON	0

STEERING SWITCH SIGNAL GND CIRCUIT

< COMPONENT DIAGNOSIS >

[BOSE AUDIO WITHOUT NAVIGATION]

STEERING SWITCH SIGNAL GND CIRCUIT

Description

INFOID:000000003356824

Transmits the steering switch signal to AV control unit.

Diagnosis Procedure

INFOID:000000003356825

1.CHECK STEERING SWITCH SIGNAL GND CIRCUIT

1. Disconnect AV control unit connector and spiral cable connector.
2. Check continuity between AV control unit harness connector and spiral cable harness connector.

AV control unit		Spiral cable		Continuity
Connector	Terminal	Connector	Terminal	
M127	15	M33	33	Existed

3. Connect AV control unit connector.

Is the inspection result normal?

- YES >> GO TO 2.
NO >> Repair harness or connector.

2.CHECK SPIRAL CABLE

Check spiral cable.

Is the inspection result normal?

- YES >> GO TO 3.
NO >> Replace spiral cable.

3.CHECK GROUND CIRCUIT

1. Connect AV control unit connector.
2. Check continuity between AV control unit harness connector and ground.

AV control unit		Ground	Continuity
Connector	Terminal		
M127	15		Existed

Is the inspection result normal?

- YES >> GO TO 4.
NO >> Replace AV control unit.

4.CHECK STEERING SWITCH

1. Turn ignition switch OFF.
2. Check steering switch. Refer to [AV-146, "Component Inspection"](#).

Is the inspection result normal?

- YES >> INSPECTION END
NO >> Replace steering switch.

A
B
C
D
E
F
G
H
I
J
K
L
M
O
P

AV

STEERING SWITCH SIGNAL GND CIRCUIT

[BOSE AUDIO WITHOUT NAVIGATION]

< COMPONENT DIAGNOSIS >

INFOID:000000003470187

Component Inspection

Measure the resistance between the steering switch connector terminals 14 to 17 and 15 to 17.

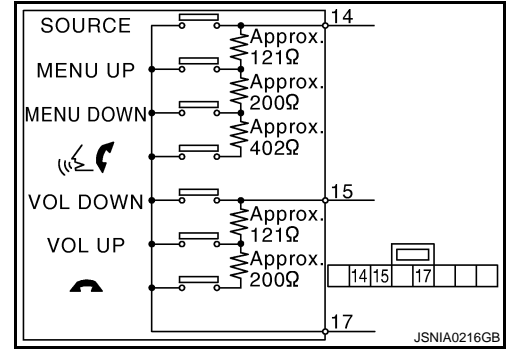

Standard

Steering switch				Condition	Resistance Ω
Con- nector	Termi- nal	Con- nector	Termi- nal		
M303	14	M303	17	☰ switch ON	709 – 737
				MENU DOWN switch ON	315 – 327
				MENU UP switch ON	119 – 123
				SOURCE switch ON	0
	15			☷ switch ON	315 – 327
				VOL UP switch ON	119 – 123
				VOL DOWN switch ON	0

AV CONTROL UNIT

[BOSE AUDIO WITHOUT NAVIGATION]

< ECU DIAGNOSIS >

ECU DIAGNOSIS

AV CONTROL UNIT

Reference Values

INFOID:000000003478347

VALUES ON THE DIAGNOSIS TOOL

CONSULT-III MONITOR ITEM

Monitor Item	Condition		Value/Status
VHCL SPD SIG	Ignition switch ON	Vehicle speed > 0 km/h (0 MPH)	On
		Vehicle speed = 0 km/h (0 MPH)	Off
PKB SIG	Ignition switch ON	Parking brake is applied.	On
		Parking brake is released.	Off
ILLUM SIG	Ignition switch ON	Light switch ON	On
		Light switch OFF	Off
IGN SIG	Ignition switch ON	—	On
	Ignition switch ACC	—	Off
REV SIG	Ignition switch ON	Selector lever in R position	On
		Selector lever in any position other than R	Off

TERMINAL LAYOUT

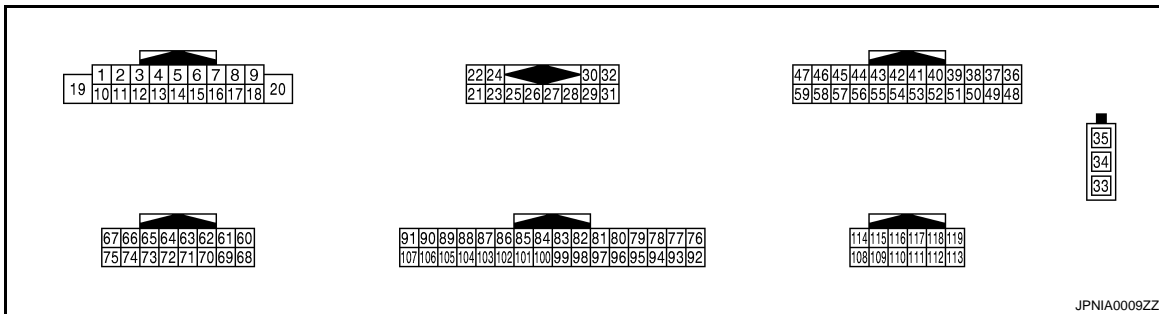

PHYSICAL VALUES

Terminal (Wire color)		Description		Condition	Reference value (Approx.)	
+	-	Signal name	Input/Output			
6 (BR)	15 (L)	Steering switch signal A	Input	Ignition switch ON	Keep pressing SOURCE switch.	0 V
				Keep pressing Δ switch.	0.7 V	
				Keep pressing ∇ switch.	1.3 V	
				Keep pressing ω switch.	2.0 V	
				Except for above.	3.3 V	
7 (R)	Ground	ACC power supply	Input	Ignition switch ACC	—	Battery voltage
9 (R)	Ground	Illumination signal	Input	OFF	Lighting switch is OFF.	0 V
				Lighting switch is ON.	12.0 V	

AV CONTROL UNIT

< ECU DIAGNOSIS >

[BOSE AUDIO WITHOUT NAVIGATION]

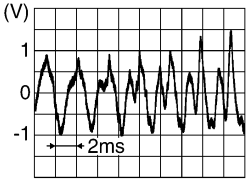
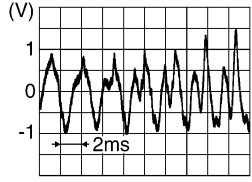
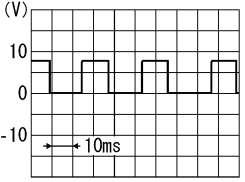
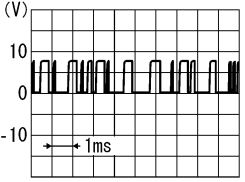
Terminal (Wire color)		Description		Condition		Reference value (Approx.)
+	-	Signal name	Input/ Output			
15 (L)	Ground	Steering switch signal GND	—	Ignition switch ON	—	0 V
16 (G)	15 (L)	Steering switch signal B	Input	Ignition switch ON	Keep pressing VOL DOWN switch.	0 V
					Keep pressing VOL UP switch.	0.7 V
					Keep pressing  switch.	1.3 V
					Except for above.	3.3 V
19 (Y)	Ground	Battery power supply	Input	Ignition switch OFF	—	Battery voltage
20 (B)	Ground	Ground	—	Ignition switch ON	—	0 V
22 (G)	21 (B)	Satellite radio sound signal LH	Input	Ignition switch ON	When satellite radio mode is selected.	 <small>SKIB3609E</small>
24 (W)	23 (R)	Satellite radio sound signal RH	Input	Ignition switch ON	When satellite radio mode is selected.	 <small>SKIB3609E</small>
25	—	Shield	—	—	—	—
26	—	Shield	—	—	—	—
28 (R)	Ground	Request signal (SAT→CONT)	Input	Ignition switch ON	When satellite radio mode is selected.	 <small>SKIA9299J</small>
29 (W)	Ground	Communication signal (SAT→CONT)	Input	Ignition switch ON	When satellite radio mode is selected.	 <small>SKIA9300J</small>

AV CONTROL UNIT

[BOSE AUDIO WITHOUT NAVIGATION]

< ECU DIAGNOSIS >

Terminal (Wire color)		Description		Condition		Reference value (Approx.)
+	-	Signal name	Input/ Output	Ignition switch		
30 (B)	Ground	Communication signal (CONT→SAT)	Output	ON	When satellite radio mode is selected.	<p style="text-align: right; font-size: small;">SKIA9301J</p>
33	—	FM sub	Input	—	—	—
34	—	AM-FM main	Input	—	—	—
35	Ground	Antenna amp. ON signal	Output	ACC	—	12.0 V
36 (L)	37 (P)	Without DVD player models • Composite image signal (AUX/Camera image) With DVD player models • Composite image signal (DVD/AUX/Camera im- age)	Output	ON	When composite image is displayed.	<p style="text-align: right; font-size: small;">SKIB2251J</p>
37 (P)	Ground	Composite image ground	—	ON	—	0 V
38 (Y)	Ground	RGB image signal (B: blue)	Output	ON	Start confirmation/adjust- ment mode, and then dis- play color bar by selecting “Color Spectrum Bar” on DISPLAY DIAGNOSIS screen.	<p style="text-align: right; font-size: small;">SKIB2237J</p>
39 (L)	Ground	RGB image signal (G: green)	Output	ON	Start confirmation/adjust- ment mode, and then dis- play color bar by selecting “Color Spectrum Bar” on DISPLAY DIAGNOSIS screen.	<p style="text-align: right; font-size: small;">SKIB2236J</p>
40 (G)	Ground	RGB image signal (R: red)	Output	ON	Start confirmation/adjust- ment mode, and then dis- play color bar by selecting “Color Spectrum Bar” on DISPLAY DIAGNOSIS screen.	<p style="text-align: right; font-size: small;">SKIB2238J</p>

A
B
C
D
E
F
G
H
I
J
K
L
M
AV
O
P

AV CONTROL UNIT

< ECU DIAGNOSIS >

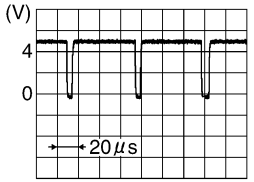
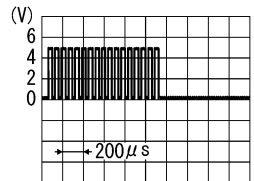
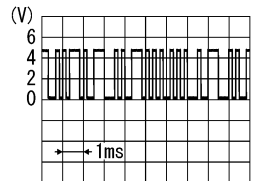
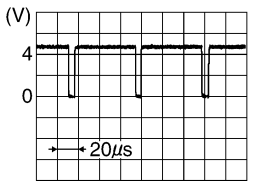
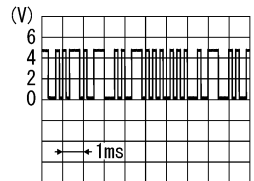

[BOSE AUDIO WITHOUT NAVIGATION]

Terminal (Wire color)		Description		Condition		Reference value (Approx.)
+	-	Signal name	Input/ Output			
41 (B)	Ground	RGB synchronizing signal	Output	Ignition switch ON	—	 <p style="text-align: right; font-size: small;">SKIB3603E</p>
42	—	Shield	—	—	—	—
43 (W)	Ground	RGB area (YS) signal	Output	Ignition switch ON	When RGB image is displayed.	5.0 V
				Ignition switch ON	When AUX or camera image is displayed.	 <p style="text-align: right; font-size: small;">PKIB4948J</p>
44 (G)	Ground	Communication signal (DISP→CONT)	Input	Ignition switch ON	When adjusting display brightness.	 <p style="text-align: right; font-size: small;">PKIB5039J</p>
45 (G)	Ground	Horizontal synchronizing (HP) signal	Input	Ignition switch ON	—	 <p style="text-align: right; font-size: small;">SKIB3601E</p>
46 (LG)	Ground	Signal GND	—	Ignition switch ON	—	0 V
47 (O)	Ground	Signal VCC (front display unit power supply)	Output	Ignition switch ACC	—	9.0 V
49	—	Shield	—	—	—	—
50	—	Shield	—	—	—	—
55	—	Shield	—	—	—	—
56 (R)	Ground	Communication signal (CONT→DISP)	Output	Ignition switch ON	When adjusting display brightness.	 <p style="text-align: right; font-size: small;">PKIB5039J</p>

AV CONTROL UNIT

[BOSE AUDIO WITHOUT NAVIGATION]

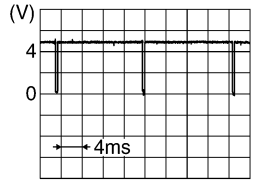
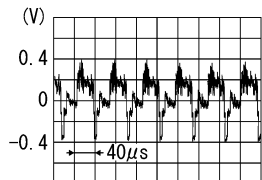
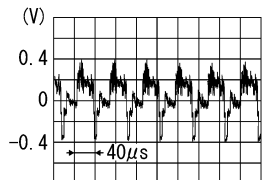
< ECU DIAGNOSIS >

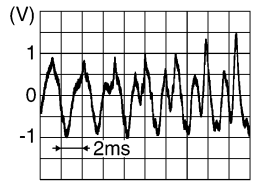
Terminal (Wire color)		Description		Condition		Reference value (Approx.)
+	-	Signal name	Input/ Output			
57 (R)	Ground	Vertical synchronizing (VP) signal	Input	Ignition switch ON	—	 <p style="text-align: right; font-size: small;">SKIB3598E</p>
58 (BR)	Ground	Inverter GND	—	Ignition switch ON	—	0 V
59 (Y)	Ground	Inverter VCC (front display unit power supply)	Output	Ignition switch ACC	—	9.0 V
64	Ground	Shield (camera image ground)	—	Ignition switch ON	—	0 V
65 (W)	64	Camera image signal	Input	Ignition switch ON	when rear view camera image is displayed.	 <p style="text-align: right; font-size: small;">SKIB2251J</p>
66 (Y) ^{*1} (L) ^{*3}	74 (B) ^{*1} (R) ^{*3}	Without DVD player models • AUX image signal	Input	Ignition switch ON	When AUX image is displayed.	 <p style="text-align: right; font-size: small;">SKIB2251J</p>
		With DVD player models • Composite image signal (DVD/AUX image)			When DVD or AUX image is displayed.	
68 (P)	Ground	Camera-connection recognition signal	Input	Ignition switch ON	Connected to camera control unit connector.	0 V
					Not connected to camera control unit connector.	5.0 V
73	—	Shield	—	—	—	—
74 (B) ^{*1} (BR) ^{*2} (R) ^{*3}	Ground	Without DVD player models • AUX image signal ground	—	Ignition switch ON	—	0 V
		With DVD player models • Composite image signal ground (DVD/AUX image)				
80 (R)	79 (L)	TEL voice signal	Input	Ignition switch ON	During voice guide output with the  switch pressed.	 <p style="text-align: right; font-size: small;">SKIB3609E</p>

A
B
C
D
E
F
G
H
I
J
K
L
M
O
P

AV

AV CONTROL UNIT

< ECU DIAGNOSIS >

[BOSE AUDIO WITHOUT NAVIGATION]

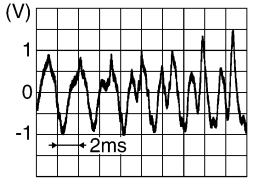
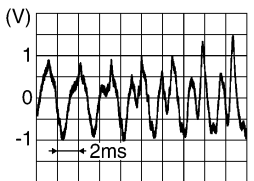
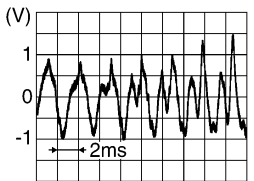
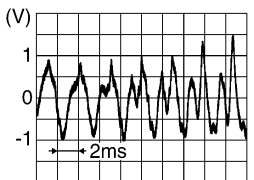
Terminal (Wire color)		Description		Condition		Reference value (Approx.)
+	-	Signal name	Input/ Output			
81	—	Shield	—	—	—	—
83 (R)	82 (W)	Without DVD player models • Sound signal RH (iPod sound)	Input	Ignition switch ON	When iPod mode is selected	 <small>SKIB3609E</small>
		With DVD player models • Sound signal RH (iPod, DVD and AUX sound)			When iPod, DVD or AUX mode is selected	
85 (B)	Ground	Ground	—	Ignition switch ON	—	0 V
86 (L)	—	CAN-H	Input/ Output	—	—	—
87 (P)	—	CAN-L	Input/ Output	—	—	—
88 (R)	—	AV communication signal (H)	Input/ Output	—	—	—
89 (L)	—	AV communication signal (L)	Input/ Output	—	—	—
90 (G)	—	AV communication signal (H)	Input/ Output	—	—	—
91 (L)	—	AV communication signal (L)	Input/ Output	—	—	—
95*4 (R)	97*4 (W)	AUX sound signal RH	Input	Ignition switch ON	When AUX mode is selected	 <small>SKIB3609E</small>
96*4 (B)	97*4 (W)	AUX sound signal LH	Input	Ignition switch ON	When AUX mode is selected	 <small>SKIB3609E</small>
97*4 (W)	Ground	AUX sound signal ground	—	Ignition switch ON	—	0 V
99 (BR)*4 (B)*3	98 (L)*4 (G)*3	Without DVD player models • Sound signal RH (iPod sound)	Input	Ignition switch ON	When iPod mode is selected	 <small>SKIB3609E</small>
		With DVD player models • Sound signal RH (iPod, DVD and AUX sound)			When iPod, DVD or AUX mode is selected	
100	—	Shield	—	—	—	—

AV CONTROL UNIT

[BOSE AUDIO WITHOUT NAVIGATION]

< ECU DIAGNOSIS >

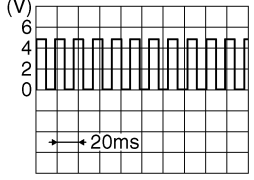
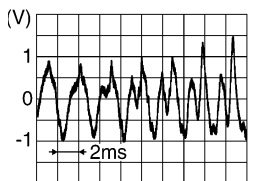
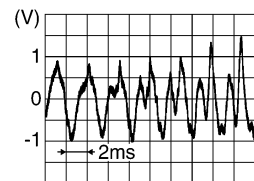
Terminal (Wire color)		Description		Condition		Reference value (Approx.)
+	-	Signal name	Input/ Output			
101 (V)	Ground	SW ground	—	Ignition switch ON	—	0 V
103 (W)	Ground	Eject signal	Input	—	Pressing the eject switch	0 V
					Except for above	3.3 V
104 (G)	Ground	Ignition signal	Input	Ignition switch ON	—	Battery voltage
105 (SB)	Ground	Reverse signal	Input	Ignition switch ON	The "R" position	12.0 V
					Other than the "R" position	0 V
106 (G)	Ground	Parking brake signal	Input	Ignition switch ON	Parking brake ON	0 V
					Parking brake OFF	5.0 V
107 (V)	Ground	Vehicle speed signal (8-pulse)	Input	Ignition switch ON	When vehicle speed is ap- prox. 40 km/h (25 MPH)	<p>NOTE: Maximum voltage may be 12 V due to specifications (connected units).</p>  <p style="text-align: right; font-size: small;">SKIA6649J</p>
108 (V)	114 (LG)	Sound signal rear RH	Output	Ignition switch ON	Voice output	 <p style="text-align: right; font-size: small;">SKIB3609E</p>
109 (B)	115 (W)	Sound signal front RH	Output	Ignition switch ON	Voice output	 <p style="text-align: right; font-size: small;">SKIB3609E</p>
110 (P)	Ground	Amp. ON signal	Output	Ignition switch ON	—	10.0 V
111	—	Shield	—	—	—	—

A
B
C
D
E
F
G
H
I
J
K
L
M
AV
O
P

AV

AV CONTROL UNIT

< ECU DIAGNOSIS >

[BOSE AUDIO WITHOUT NAVIGATION]

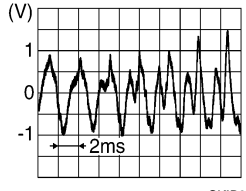
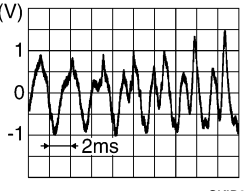
Terminal (Wire color)		Description		Condition		Reference value (Approx.)
+	-	Signal name	Input/ Output			
112 (O) ^{*1} (L) ^{*2}	118 (SB) ^{*1} (R) ^{*2}	Sound signal rear LH	Output	Ignition switch ON	Voice output	
113 (G)	119 (R)	Sound signal front LH	Output	Ignition switch ON	Voice output	

NOTE:

- *1: Without DVD player models (Type A).
- *2: Without DVD player models (Type B).
- *3: With DVD player models.
- *4: Only for models without DVD player.

Wiring Diagram - BOSE AUDIO WITHOUT NAVIGATION WITHOUT DVD ENTERTAINMENT SYSTEM -

INFOID:000000003457756

NOTE:

- In this section, PRESET SWITCH and MULTIFUNCTION SWITCH are written as the MULTIFUNCTION SWITCH.
- Type A: Up to VIN: JN8AZ18U*9W100000, JN8AZ18W*9W200000 (EXCEPT FOR MEXICO), JN8AZ18U*9W710000, JN8AZ18W*9W810000 (FOR MEXICO)

AV CONTROL UNIT

[BOSE AUDIO WITHOUT NAVIGATION]

< ECU DIAGNOSIS >

TA : Type A
TB : Type B

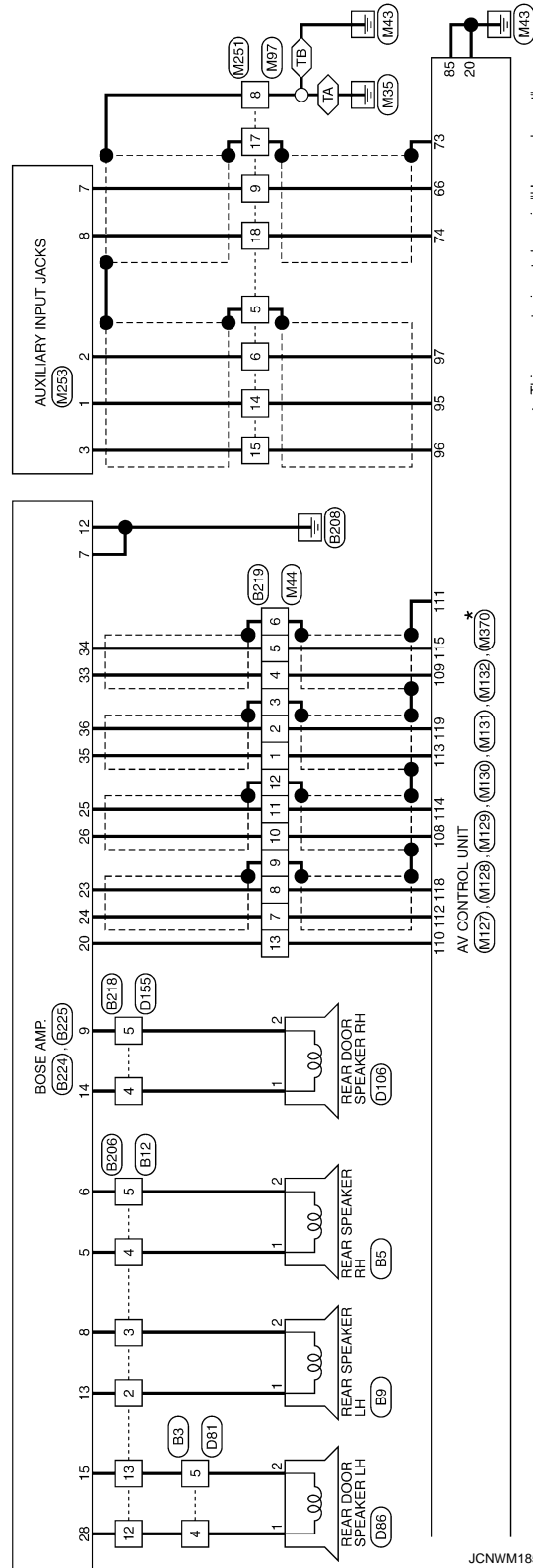

*: This connector is not shown in "Harness Layout".

JCNWM1858GI



AV CONTROL UNIT

[BOSE AUDIO WITHOUT NAVIGATION]

< ECU DIAGNOSIS >



BOSE AUDIO WITHOUT NAVIGATION WITHOUT DVD ENTERTAINMENT SYSTEM

Connector No.	B3
Connector Name	WIRE TO WIRE
Connector Type	TK0DFW-ANS8



Terminal No.	Color of Wire	Signal Name [Specification]
4	LG	-
5	O	-

Connector No.	B4
Connector Name	WIRE TO WIRE
Connector Type	NS16MWH-CS



Terminal No.	Color of Wire	Signal Name [Specification]
4	R	-
5	O	-
6	P	-
7	L	-

Connector No.	B5
Connector Name	REAR SPEAKER RH
Connector Type	TK02FBR



Terminal No.	Color of Wire	Signal Name [Specification]
1	V	-
2	LG	-

Connector No.	B6
Connector Name	REAR SPEAKER LH
Connector Type	TK02FBR



Terminal No.	Color of Wire	Signal Name [Specification]
1	SB	-
2	GR	-

Connector No.	B7
Connector Name	WIRE TO WIRE
Connector Type	NS18FW-CS

Terminal No.	Color of Wire	Signal Name [Specification]
43	G	-
44	BR	-
45	L	-
46	GR	-
47	V	-
48	GR	-(With rear view camera and telephone)
48	BR	-(With rear view camera without telephone)
49	Y	-
50	SHIELD	-
51	B	-
56	P	-
57	L	-
58	R	-
59	SHIELD	-
60	B	-
61	R/L	-
62	R/W	-
66	GR	-
67	G	-
68	R	-
69	SHIELD	-
70	W/R	-
71	B/R	-

Connector No.	B8
Connector Name	WOOFER
Connector Type	RS08FGY-PR

Terminal No.	Color of Wire	Signal Name [Specification]
1	W/R	SOUND SIGNAL WOOFER (-)
2	B/R	SOUND SIGNAL WOOFER (+)
4	W	WOOFER AMP- ON SIGNAL
5	B/W	GND
6	O	BAT

Connector No.	B9
Connector Name	WIRE TO WIRE
Connector Type	TH80MW-CS19

Terminal No.	Color of Wire	Signal Name [Specification]
1	SHIELD	-
2	B	-
3	R/L	-
4	R/W	-
8	SHIELD	-
9	BR/L	-
10	Y/G	-
11	Y/L	-
12	W/L	-
41	O	-
42	SB	-

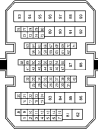
A B C D E F G H I J K L M O P

AV

JCNWM1859GI

AV CONTROL UNIT

[BOSE AUDIO WITHOUT NAVIGATION]

< ECU DIAGNOSIS >

BOSE AUDIO WITHOUT NAVIGATION WITHOUT DVD ENTERTAINMENT SYSTEM

Connector No.	B33
Connector Name	TEL ADAPTER UNIT
Connector Type	TH32FW-NH

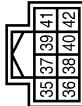

Terminal No.	Color of Wire	Signal Name [Specification]
35	Y	AV COMM (H)
36	BR	AV COMM (L)
40	G	AV COMM (H)
42	GR	AV COMM (L)

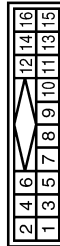

Connector No.	B48
Connector Name	SATELLITE RADIO TUNER
Connector Type	A18FW

Connector No.	B39
Connector Name	TEL ADAPTER UNIT
Connector Type	TH32FW-NH

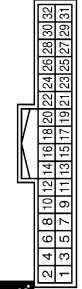

Terminal No.	Color of Wire	Signal Name [Specification]
1	V	BATTERY
2	GR	ACC
3	R	IGNITION
4	B/W	GND
5	SHIELD	SHIELD
6	SHIELD	SHIELD
7	R/W	MICROPHONE SIGNAL
8	R/L	MICROPHONE GND
9	B/R	TEL VOICE SIGNAL (+)
10	W/R	TEL VOICE SIGNAL (-)
14	B	GND

Terminal No.	16
Color of Wire	GR
Signal Name [Specification]	ACC

Terminal No.	20
Color of Wire	B
Signal Name [Specification]	CONTROL SIGNAL
Terminal No.	24
Color of Wire	B/W
Signal Name [Specification]	CONTROL SIGNAL
Terminal No.	28
Color of Wire	BR
Signal Name [Specification]	VEHICLE SPEED (8-PULSE)
Terminal No.	29
Color of Wire	B
Signal Name [Specification]	MICROPHONE VCC

Connector No.	B60
Connector Name	CAMERA CONTROL UNIT
Connector Type	TH32FW-NH

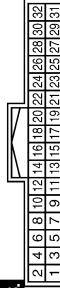

Terminal No.	22
Color of Wire	R
Signal Name [Specification]	REVERSE
Terminal No.	23
Color of Wire	G
Signal Name [Specification]	SENSOR SIGNAL 1
Terminal No.	24
Color of Wire	SB
Signal Name [Specification]	SENSOR SIGNAL 2
Terminal No.	25
Color of Wire	O
Signal Name [Specification]	SENSOR SIGNAL 3
Terminal No.	26
Color of Wire	BR
Signal Name [Specification]	VEHICLE SPEED (8-PULSE)
Terminal No.	30
Color of Wire	GR
Signal Name [Specification]	ACC
Terminal No.	31
Color of Wire	B
Signal Name [Specification]	GND
Terminal No.	32
Color of Wire	V
Signal Name [Specification]	BATTERY

Terminal No.	Color of Wire	Signal Name [Specification]
1	W/L	SOUND SIGNAL LH (-)
2	Y/L	SOUND SIGNAL LH (+)
3	Y/G	SOUND SIGNAL RH (-)
4	BR/L	SOUND SIGNAL RH (+)
5	SHIELD	SHIELD
6	SHIELD	SHIELD
8	R/W	REQUEST (SAT->CONT)
9	R/L	COMM (SAT->CONT)
10	B	COMM (CONT->SAT)
12	V	BATTERY
15	B	GND

Terminal No.	Color of Wire	Signal Name [Specification]
5	SHIELD	SHIELD
6	B	CAMERA IMAGE SIGNAL
7	R/W	GND
8	R/L	CAMERA ON SIGNAL
11	SHIELD	SHIELD
12	B	CAMERA IMAGE SIGNAL
14	L	CONNECTION RECOGNITION
17	BR	AV COMM (L)
18	Y	AV COMM (H)
19	GR	AV COMM (L)
20	G	AV COMM (H)

AV CONTROL UNIT

[BOSE AUDIO WITHOUT NAVIGATION]

< ECU DIAGNOSIS >

BOSE AUDIO WITHOUT NAVIGATION WITHOUT DVD ENTERTAINMENT SYSTEM

Connector No.	B77
Connector Name	WIRE TO WIRE
Connector Type	TK12MW

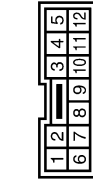

Terminal No.	Color of Wire	Signal Name [Specification]
6	R/L	-
7	R/W	-
8	B	-
9	SHIELD	-

Connector No.	B219
Connector Name	WIRE TO WIRE
Connector Type	TH22MW-NH



Terminal No.	Color of Wire	Signal Name [Specification]
1	W/R	-
2	B/R	-
3	SHIELD	-
4	W/R	-
5	B/R	-
6	SHIELD	-
7	GR/V	-
8	W/L	-
9	SHIELD	-
10	GR/V	-
11	W/L	-

Connector No.	B206
Connector Name	WIRE TO WIRE
Connector Type	NS16MH-CS

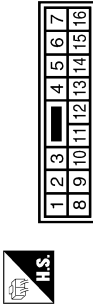

Terminal No.	Color of Wire	Signal Name [Specification]
1	W	-
2	GR	-
3	BR	-
4	Y	-
5	BR	-
7	SHIELD	-
12	G	-
13	R	-
14	W/R	-
15	B/R	-

Terminal No.	12	SHIELD	-
Terminal No.	13	SB	-

Connector No.	B218
Connector Name	WIRE TO WIRE
Connector Type	TK16FH-NSB



Terminal No.	Color of Wire	Signal Name [Specification]
4	L	- [With BOSE system]
5	O	- [With BOSE system]

Connector No.	B224
Connector Name	BOSE AMP.
Connector Type	SGA12FBR-SJA2

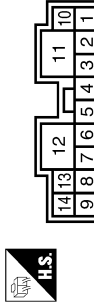

Terminal No.	Color of Wire	Signal Name [Specification]
1	LG	SOUND SIGNAL FRONT SQUAWKER LH (+)
2	V	SOUND SIGNAL FRONT SQUAWKER LH (-)
3	L	SOUND SIGNAL FRONT SQUAWKER RH (-)
4	P	SOUND SIGNAL FRONT SQUAWKER RH (+)
5	Y	SOUND SIGNAL REAR SQUAWKER RH (+)
6	BR	SOUND SIGNAL REAR SQUAWKER RH (-)
7	B	GND
8	BR	SOUND SIGNAL REAR SPEAKER LH (-)
9	O	SOUND SIGNAL REAR DOOR SPEAKER RH (-)
10	SB	BATTERY
11	GR	BATTERY

Terminal No.	12	B	GND
Terminal No.	13	GR	SOUND SIGNAL REAR DOOR SPEAKER RH (+)
Terminal No.	14	L	SOUND SIGNAL REAR DOOR SPEAKER RH (-)

JCNWM1861G1

A
B
C
D
E
F
G
H
I
J
K
L
M
N
O
P

AV

AV CONTROL UNIT

[BOSE AUDIO WITHOUT NAVIGATION]

< ECU DIAGNOSIS >

BOSE AUDIO WITHOUT NAVIGATION WITHOUT DVD ENTERTAINMENT SYSTEM

Connector No.	B225
Connector Name	BOSE AMP.
Connector Type	SCA19FBR-SGA4

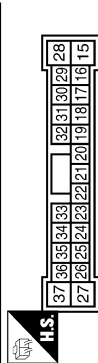

Terminal No.	Color of Wire	Signal Name [Specification]
15	R	SOUND SIGNAL REAR DOOR SPEAKER LH (-)
16	B/R	SOUND SIGNAL REAR DOOR SPEAKER LH (+)
17	W/R	SOUND SIGNAL WOOFER (+)
18	W	SOUND SIGNAL FRONT DOOR SPEAKER LH (+)
19	B	SOUND SIGNAL FRONT DOOR SPEAKER LH (-)
20	SB	AMP ON SIGNAL
21	SHIELD	SHIELD
22	W	WOOFER AMP ON SIGNAL
23	W/L	SOUND SIGNAL REAR LH (-)
24	GR/V	SOUND SIGNAL REAR LH (+)
25	W/L	SOUND SIGNAL REAR RH (-)

Connector No.	B471
Connector Name	TEL ADAPTER UNIT
Connector Type	GT18C-IS-HU

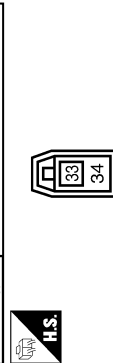

Terminal No.	Color of Wire	Signal Name [Specification]
33	-	TEL ANTENNA
34	SHIELD	SHIELD

26	GR/V	SOUND SIGNAL REAR RH (+)
28	G	SOUND SIGNAL REAR DOOR SPEAKER LH (+)
29	V	SOUND SIGNAL CENTER SPEAKER (+)
30	P	SOUND SIGNAL CENTER SPEAKER (-)
31	BR	SOUND SIGNAL FRONT DOOR SPEAKER RH (+)
32	Y	SOUND SIGNAL FRONT DOOR SPEAKER RH (-)
33	W/R	SOUND SIGNAL FRONT RH (+)
34	B/R	SOUND SIGNAL FRONT RH (-)
35	W/R	SOUND SIGNAL FRONT LH (+)
36	B/R	SOUND SIGNAL FRONT LH (-)



Terminal No.	Color of Wire	Signal Name [Specification]
1	V	-
2	BR	-
3	W	-
4	V	-
5	SB	-
6	P	-
7	Y	-
8	B	-
9	L	-
10	P	-
11	LG	-

Connector No.	B485
Connector Name	ANTENNA BASE (SATELLITE ANTENNA) (WITH BOSE SYSTEM WITHOUT NAVIGATION SYSTEM)
Connector Type	GT18C-1PP-HU

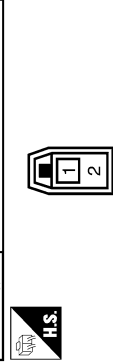

Terminal No.	Color of Wire	Signal Name [Specification]
1	-	SATELLITE ANTENNA

12	GR	-
----	----	---

Connector No.	B326
Connector Name	WIRE TO WIRE
Connector Type	NS12MR-CS

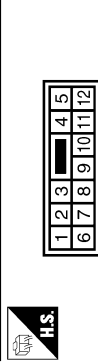

Connector No.	D15
Connector Name	FRONT DOOR SPEAKER LH (WITH BOSE SYSTEM)
Connector Type	NS02FBR-CS

Connector No.	B482
Connector Name	SATELLITE RADIO TUNER
Connector Type	FAKRA

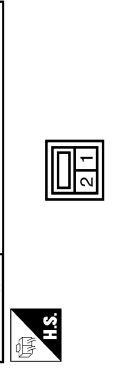

Terminal No.	Color of Wire	Signal Name [Specification]
1	L	-[Type A]
1	W	-[Type B]
2	B/W	-[Type A]
2	B	-[Type B]

JCNWM1862GI

AV CONTROL UNIT

[BOSE AUDIO WITHOUT NAVIGATION]

< ECU DIAGNOSIS >

BOSE AUDIO WITHOUT NAVIGATION WITHOUT DVD ENTERTAINMENT SYSTEM

Connector No.	D81
Connector Name	WIRE TO WIRE
Connector Type	TK10MW-NS8



Terminal No.	Color of Wire	Signal Name [Specification]
4	L	-
5	W	-

Connector No.	D53
Connector Name	FRONT DOOR SPEAKER RH (WITH BOSE SYSTEM)
Connector Type	NS2ZFBF-CS



Terminal No.	Color of Wire	Signal Name [Specification]
1	BR	-[Type A]
1	W	-[Type B]
2	B/R	-[Type A]
2	B	-[Type B]

Connector No.	D41
Connector Name	WIRE TO WIRE
Connector Type	TH4QFW-CS15

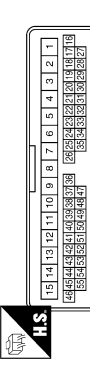

Terminal No.	Color of Wire	Signal Name [Specification]
4	B/R	-[Type A]
4	B	-[Type B]
5	BR	-[Type A]
5	W	-[Type B]

Connector No.	D21
Connector Name	WIRE TO WIRE
Connector Type	TH4QFW-CS15

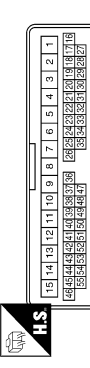

Terminal No.	Color of Wire	Signal Name [Specification]
4	B/W	-[Type A]
4	B	-[Type B]
5	L	-[Type A]
5	W	-[Type B]

Connector No.	D182
Connector Name	WIRE TO WIRE
Connector Type	TK12FW

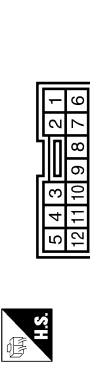

Terminal No.	Color of Wire	Signal Name [Specification]
6	R	-
7	G	-
8	B	-
9	SHIELD	-

Connector No.	D155
Connector Name	WIRE TO WIRE
Connector Type	TK10MW-NS8



Terminal No.	Color of Wire	Signal Name [Specification]
4	O	-[Type A]
4	L	-[Type B]
5	B/P	-[Type A]
5	W	-[Type B]

Connector No.	D108
Connector Name	REAR DOOR SPEAKER RH (WITH BOSE SYSTEM)
Connector Type	NS2ZFBF-CS



Terminal No.	Color of Wire	Signal Name [Specification]
1	O	-[Type A]
1	L	-[Type B]
2	B/P	-[Type A]
2	W	-[Type B]

Connector No.	D86
Connector Name	REAR DOOR SPEAKER LH (WITH BOSE SYSTEM)
Connector Type	NS2ZFBF-CS



Terminal No.	Color of Wire	Signal Name [Specification]
1	L	-
2	W	-

JCNWM1863GI

A
B
C
D
E
F
G
H
I
J
K
L
M
N
O
P

AV

AV CONTROL UNIT

[BOSE AUDIO WITHOUT NAVIGATION]

< ECU DIAGNOSIS >

BOSE AUDIO WITHOUT NAVIGATION WITHOUT DVD ENTERTAINMENT SYSTEM

Connector No.	D192
Connector Name	REAR VIEW CAMERA
Connector Type	TH70MW-NH



Terminal No.	Color of Wire	Signal Name [Specification]
1	R	CAMERA ON SIGNAL
2	G	GND
3	B	CAMERA IMAGE SIGNAL
4	SHIELD	SHIELD

Connector No.	E6
Connector Name	WIRE TO WIRE
Connector Type	TK18MGY-TV

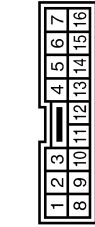

Terminal No.	Color of Wire	Signal Name [Specification]
4	R	-

Connector No.	E16
Connector Name	ECM
Connector Type	RH4ZFB-R2B-L-LH

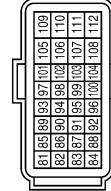

Terminal No.	Color of Wire	Signal Name [Specification]
97	P	VEHCAN-L
98	L	VEHCAN-H

Connector No.	E18
Connector Name	BACK-UP LAMP RELAY
Connector Type	MS02FL-M2-LC

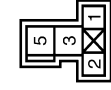

Terminal No.	Color of Wire	Signal Name [Specification]
1	LG	-
2	R	-
3	LG	-
5	R	-

Connector No.	E27
Connector Name	PARKING BRAKE SWITCH
Connector Type	P01FE-A



Terminal No.	Color of Wire	Signal Name [Specification]
1	P	-

Connector No.	E104
Connector Name	WIRE TO WIRE
Connector Type	NS16FW-CS

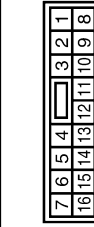

Terminal No.	Color of Wire	Signal Name [Specification]
4	R	-
5	L	-
6	P	-
7	L	-

Connector No.	E105
Connector Name	WIRE TO WIRE
Connector Type	TH70MW-CS10-M3

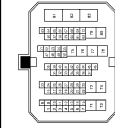

Terminal No.	Color of Wire	Signal Name [Specification]
5	LG	-
22	P	-
47	P	-
48	L	-
75	BR	-
76	GR	-
78	V	-

Connector No.	F23
Connector Name	TOM (TRANSMISSION CONTROL MODULE)
Connector Type	RH40FB-R2B-L-RH

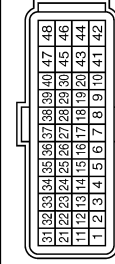

Terminal No.	Color of Wire	Signal Name [Specification]
19	G/B	REV LAMP RELAY

JCNWM1864GI

AV CONTROL UNIT

[BOSE AUDIO WITHOUT NAVIGATION]

< ECU DIAGNOSIS >

BOSE AUDIO WITHOUT NAVIGATION WITHOUT DVD ENTERTAINMENT SYSTEM

Connector No.	F123
Connector Name	WIRE TO WIRE
Connector Type	TK16FY-TV

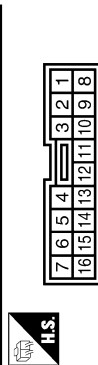

Terminal No.	Color of Wire	Signal Name [Specification]
4	G/B	-

Connector No.	M1
Connector Name	FUSE BLOCK (J/B)
Connector Type	NSGFW-M2



Terminal No.	Color of Wire	Signal Name [Specification]
2A	G	-
5A	R	-

Connector No.	M3
Connector Name	FUSE BLOCK (J/B)
Connector Type	NS12FW-CS

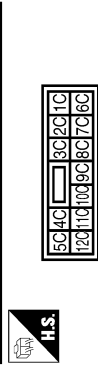

Terminal No.	Color of Wire	Signal Name [Specification]
12C	O	-

Connector No.	M4
Connector Name	DATA LINK CONNECTOR
Connector Type	BD16FW

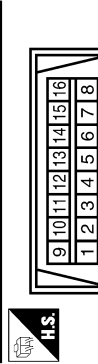

Terminal No.	Color of Wire	Signal Name [Specification]
6	L	-
14	P	-

Connector No.	M11
Connector Name	WIRE TO WIRE
Connector Type	TH70FW-CS10-M3

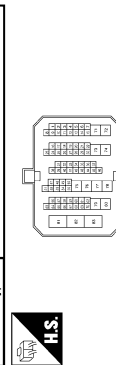

Terminal No.	Color of Wire	Signal Name [Specification]
5	O	-
22	G	-
47	P	-
48	L	-
75	BR	-
76	R	-
78	Y	-

Connector No.	M18
Connector Name	WIRE TO WIRE
Connector Type	TH40MW-CS15

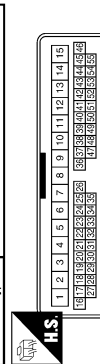

Terminal No.	Color of Wire	Signal Name [Specification]
4	W	-
5	BR	- [Type A and without BOSE system type B]
5	B	- [With BOSE system type B]

Connector No.	M20
Connector Name	WIRE TO WIRE
Connector Type	TH40MW-CS15

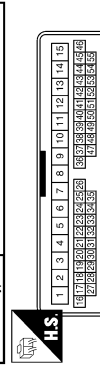

Terminal No.	Color of Wire	Signal Name [Specification]
4	B	-
5	L	-

A
B
C
D
E
F
G
H
I
J
K
L
M
AV
O
P

AV CONTROL UNIT

[BOSE AUDIO WITHOUT NAVIGATION]

< ECU DIAGNOSIS >

BOSE AUDIO WITHOUT NAVIGATION WITHOUT DVD ENTERTAINMENT SYSTEM

Connector No.	M22
Connector Name	WIRE TO WIRE
Connector Type	TH12FW-NH

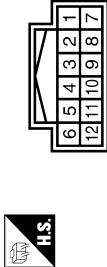

Terminal No.	Color of Wire	Signal Name [Specification]
1	V	-
2	R	-
3	R	-
4	G	-
5	W	-
6	SHIELD	-
7	LG	-
8	SHIELD	-
9	BR	-
10	SHIELD	-
11	L	-

Connector No.	M33
Connector Name	COMBINATION SWITCH (SPIRAL CABLE)
Connector Type	TK08FGY-IV

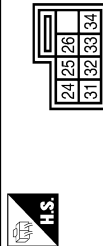

Terminal No.	Color of Wire	Signal Name [Specification]
24	BR	- [With audio steering switch and telephone]
31	G	- [With audio steering switch and telephone]
33	L	- [With audio steering switch and telephone]

12	R
----	---

Connector No.	M23
Connector Name	WIRE TO WIRE
Connector Type	TH16MW-NH

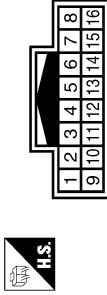

Terminal No.	Color of Wire	Signal Name [Specification]
1	W	-
2	R	- [With telephone without navigation system]
3	B	-
4	SHIELD	-

Connector No.	M44
Connector Name	WIRE TO WIRE
Connector Type	TH32FW-NH

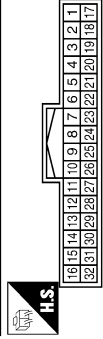

Terminal No.	Color of Wire	Signal Name [Specification]
1	G	-
2	R	-
3	SHIELD	-
4	B	-
5	W	-
6	SHIELD	-
7	L	- [Type A]
8	SB	- [Type B]
9	R	- [Type A]
		- [Type B]
		- [Type B]

Connector No.	M30
Connector Name	STEERING ANGLE SENSOR
Connector Type	TH08FW-NH



Terminal No.	Color of Wire	Signal Name [Specification]
1	B	-
3	L	-
4	G	-
6	SB	-
8	O	-

Terminal No.	10	V
	11	LG
	12	SHIELD
	13	P

JCNWM1866GI

AV CONTROL UNIT

[BOSE AUDIO WITHOUT NAVIGATION]

< ECU DIAGNOSIS >

BOSE AUDIO WITHOUT NAVIGATION WITHOUT DVD ENTERTAINMENT SYSTEM

Connector No.	M4B
Connector Name	FRONT DISPLAY UNIT
Connector Type	TH24FW-NH

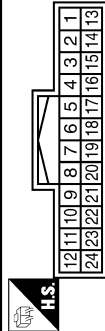

Terminal No.	Color of Wire	Signal Name [Specification]
1	B	GND
2	Y	INVERTER VCGI[Without navigation system]
3	O	SIGNAL VCGI[Without navigation system]
4	P	COMPOSITE IMAGE CHN[Without navigation system]
5	SHIELD	SHIELD[Without navigation system]
6	SHIELD	SHIELD[Without navigation system]
7	SHIELD	SHIELD
8	G	HP[Without navigation system]
9	W	RGB AREA (YS) SIGNAL
11	R	COMM (CONT->DISP)
13	BR	INVERTER GNDI[Without navigation system]

Connector No.	M67
Connector Name	FRONT SQUAWKER RH
Connector Type	TK02FBR

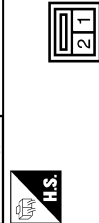

Terminal No.	Color of Wire	Signal Name [Specification]
1	BR	-
2	R	-[With BOSE system]

14	LG	SIGNAL GNDI[Without navigation system]
15	L	COMPOSITE IMAGE SIGNAL[Without navigation system]
17	G	RGB (RED) SIGNAL
18	Y	RGB (BLUE) SIGNAL[Without navigation system]
19	B	RGB SYNC
20	R	VP
21	SHIELD	SHIELD
22	G	COMM (DISP->CONT)
23	SHIELD	SHIELD



Terminal No.	Color of Wire	Signal Name [Specification]
1	LG	-[With BOSE system]
2	Y	-[With BOSE system]

Terminal No.	Color of Wire	Signal Name [Specification]
43	L	-
44	V	-
45	P	-
46	R	-
47	Y	-
48	L	-
49	G	-
50	SHIELD	-
51	W	-
53	P	-
57	L	-
58	SB	-
59	SHIELD	-
60	B	-
61	R	-
62	W	-
66	L	-
67	R	-
68	G	-
69	SHIELD	-
70	L	-
71	R	-

Connector No.	M77
Connector Name	WIRE TO WIRE
Connector Type	TH80FW-CS19

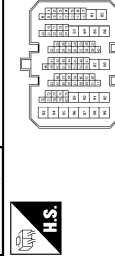

Terminal No.	Color of Wire	Signal Name [Specification]
1	SHIELD	-
2	B	-
3	W	-
4	R	-
8	SHIELD	-
9	W	-
10	R	-
11	G	-
12	B	-
41	O	-
42	SB	-

Connector No.	M66
Connector Name	CENTER SPEAKER
Connector Type	TK02FBR



Terminal No.	Color of Wire	Signal Name [Specification]
1	P	-
2	O	-

Connector No.	M97
Connector Name	WIRE TO WIRE
Connector Type	TH18FW-CS2

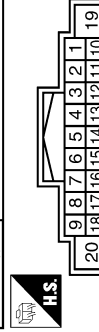

Terminal No.	Color of Wire	Signal Name [Specification]
5	SHIELD	-
6	W	-
8	B	-
9	Y	-
14	R	-
15	B	-
17	SHIELD	-
18	B	-[Type A and With navigation system type B]
18	BR	-[Without navigation system type B]

A
B
C
D
E
F
G
H
I
J
K
L
M
N
O
P

AV

AV CONTROL UNIT

[BOSE AUDIO WITHOUT NAVIGATION]

< ECU DIAGNOSIS >

BOSE AUDIO WITHOUT NAVIGATION WITHOUT DVD ENTERTAINMENT SYSTEM

Connector No.	M122
Connector Name	BCM BODY CONTROL MODULE
Connector Type	TH40FB-NH

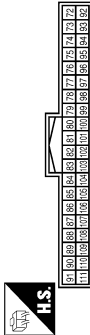

Terminal No.	Color of Wire	Signal Name [Specification]
90	P	CAN-L
91	L	CAN-H

Connector No.	M124
Connector Name	WIRE TO WIRE
Connector Type	NS12FBR-CS



Terminal No.	Color of Wire	Signal Name [Specification]
1	P	-
2	BR	- [Type A]
3	B	- [Type B]
4	Y	-
5	BR	-
6	O	-
7	W	-
8	B	-
9	R	-
10	BR	-

11	LG
12	R

Connector No.	M125
Connector Name	MULTIFUNCTION SWITCH
Connector Type	TH16FW-NH

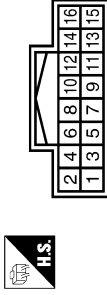

Terminal No.	Color of Wire	Signal Name [Specification]
1	B	GND
3	R	ACC
6	R	AV COMM (H)
8	L	AV COMM (L)
9	V	SW GND
14	W	EJECT SIGNAL

Connector No.	M127
Connector Name	AV CONTROL UNIT (WITH BOSE SYSTEM WITHOUT NAVIGATION SYSTEM)
Connector Type	TH18FW-CS2

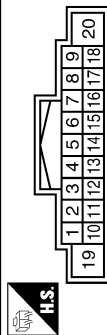

Terminal No.	Color of Wire	Signal Name [Specification]
6	BR	STRG SW A
7	R	ACC
9	R	ILLUMINATION
15	L	STRG SW GND
16	G	STRG SW B
19	Y	BATTERY
20	B	GND

Connector No.	M128
Connector Name	AV CONTROL UNIT (WITH BOSE SYSTEM WITHOUT NAVIGATION SYSTEM)
Connector Type	A12FW

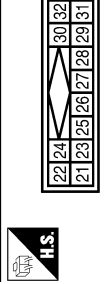

Terminal No.	Color of Wire	Signal Name [Specification]
21	B	SATELLITE RADIO SOUND SIGNAL LH (-)
22	G	SATELLITE RADIO SOUND SIGNAL LH (+)
23	R	SATELLITE RADIO SOUND SIGNAL RH (-)
24	W	SATELLITE RADIO SOUND SIGNAL RH (+)
25	SHIELD	SHIELD
26	SHIELD	SHIELD
28	R	REQUEST (SAT->CONT)
29	W	COMM (SAT->CONT)
30	B	COMM (CONT->SAT)

Connector No.	M129
Connector Name	AV CONTROL UNIT (WITH BOSE SYSTEM WITHOUT NAVIGATION SYSTEM)
Connector Type	TH24FW-NH

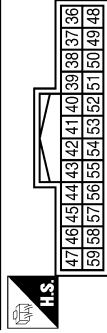

Terminal No.	Color of Wire	Signal Name [Specification]
36	L	COMPOSITE IMAGE SIGNAL
37	P	COMPOSITE IMAGE GND
38	Y	RGB (B/BLUE) SIGNAL
39	L	RGB (G/GREEN) SIGNAL
40	G	RGB (R/RED) SIGNAL
41	B	RGB SYNC
42	SHIELD	SHIELD
43	W	RGB AREA (YS) SIGNAL
44	G	COMM (DISP->CONT)
45	G	HP
46	LG	SIGNAL GND

JCNWM1868G1

AV CONTROL UNIT

[BOSE AUDIO WITHOUT NAVIGATION]

< ECU DIAGNOSIS >

BOSE AUDIO WITHOUT NAVIGATION WITHOUT DVD ENTERTAINMENT SYSTEM

Connector No.	M130
Connector Name	AV CONTROL UNIT (WITH BOSE SYSTEM WITHOUT NAVIGATION SYSTEM)
Connector Type	TH116FW-NH



67	66	65	64	63	62	61	60
75	74	73	72	71	70	69	68

Terminal No.	Color of Wire	Signal Name [Specification]
64	SHIELD	SHIELD
65	W	CAMERA IMAGE SIGNAL
66	Y	AUX IMAGE SIGNAL (Without DVD player)
68	P	CONNECTION RECOGNITION
72	SHIELD	SHIELD (Without DVD player)
74	B	AUX IMAGE GND (Without DVD player (Type A))
74	BR	AUX IMAGE GND (Without DVD player (Type B))

Connector No.	M132
Connector Name	AV CONTROL UNIT (WITH BOSE SYSTEM WITHOUT NAVIGATION SYSTEM)
Connector Type	TH121FW-NH



114	115	116	117	118	119
108	109	110	111	112	113

Terminal No.	Color of Wire	Signal Name [Specification]
108	V	SOUND SIGNAL REAR RH (+)
109	B	SOUND SIGNAL FRONT RH (+)
110	P	AMP. ON SIGNAL
111	SHIELD	SHIELD
112	O	SOUND SIGNAL REAR LH (+) (Type A)
112	L	SOUND SIGNAL REAR LH (+) (Type B)
113	G	SOUND SIGNAL FRONT LH (+)
114	LG	SOUND SIGNAL REAR RH (-)
115	W	SOUND SIGNAL FRONT RH (-)
118	SB	SOUND SIGNAL REAR LH (-) (Type A)
118	R	SOUND SIGNAL REAR LH (-) (Type B)

Connector No.	M131
Connector Name	AV CONTROL UNIT (WITH BOSE SYSTEM WITHOUT NAVIGATION SYSTEM)
Connector Type	TH132FW-NH



91	90	89	88	87	86	85	84	83	82	81	80	79	78	77	76
107	106	105	104	103	102	101	100	99	98	97	96	95	94	93	92

Terminal No.	Color of Wire	Signal Name [Specification]
79	L	TEL VOICE SIGNAL (-)
80	R	TEL VOICE SIGNAL (+)
81	SHIELD	SHIELD
82	W	iPod SOUND SIGNAL RH (-) (Without DVD player)
83	R	iPod SOUND SIGNAL RH (+) (Without DVD player)
85	B	GND
86	L	CAN-H
87	P	CAN-L
88	R	AV COMM (H)
89	L	AV COMM (L)
90	G	AV COMM (H)

Terminal No.	119	R	SOUND SIGNAL FRONT LH (-)
--------------	-----	---	---------------------------

91	L	AV COMM (L)
95	R	AUX SOUND SIGNAL RH (+)
96	B	AUX SOUND SIGNAL LH (-)
97	W	AUX SOUND SIGNAL GND
98	L	iPod SOUND SIGNAL LH (-) (Without DVD player)
99	BR	iPod SOUND SIGNAL LH (+) (Without DVD player)
100	SHIELD	SHIELD (Without DVD player)
101	V	SW GND
103	W	EJECT SIGNAL
104	G	IGNITION
105	SB	REVERSE
106	G	PARKING BRAKE
107	V	VEHICLE SPEED (8-PULSE)

Connector No.	M148
Connector Name	iPod ADAPTER
Connector Type	TH24FW-NH



1	2	3	4	5	6	7	8	9	10	11	12
13	14	15	16	17	18	19	20	21	22	23	24

Terminal No.	Color of Wire	Signal Name [Specification]
1	BR	iPod SOUND SIGNAL LH (+)
2	R	iPod SOUND SIGNAL RH (+)
3	R	ACC
4	L	AV COMM (L)
5	Y	BATTERY
8	W	CHARGE POWER
9	G	COMM (iPod ADAPTER->iPod)
10	R	COMM (iPod->iPod ADAPTER)
11	R	ACCESSORY IDENTIFY
12	V	iPod SOUND SIGNAL RH (+)
13	L	iPod SOUND SIGNAL LH (-)

14	W	iPod SOUND SIGNAL RH (-)
15	SHIELD	SHIELD
16	R	AV COMM (H)
17	SHIELD	GND
19	SHIELD	SHIELD
21	L	iPod CONNECTION RECOGNITION
22	BR	ACCESSORY DETECT
23	R	iPod SOUND SIGNAL GND
24	LG	iPod SOUND SIGNAL LH (+)

A
B
C
D
E
F
G
H
I
J
K
L
M
N
O
P

AV

JCNWM1869GI

AV CONTROL UNIT

[BOSE AUDIO WITHOUT NAVIGATION]

< ECU DIAGNOSIS >

BOSE AUDIO WITHOUT NAVIGATION WITHOUT DVD ENTERTAINMENT SYSTEM

Connector No.	M204
Connector Name	WIRE TO WIRE
Connector Type	TH12MW-NH

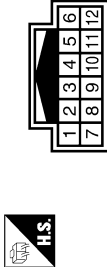

Terminal No.	Color of Wire	Signal Name [Specification]
1	V	-
2	R	-
3	R	-
4	G	-
5	W	-
6	SHIELD	-
7	LG	-
8	SHIELD	-
9	BR	-
10	SHIELD	-
11	L	-

Connector No.	M260
Connector Name	iPod SIDE
Connector Type	IP10F3GY

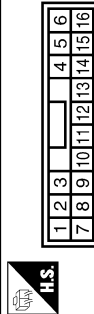

Terminal No.	Color of Wire	Signal Name [Specification]
1	LG	iPod SOUND SIGNAL LH (+)
2	R	iPod SOUND SIGNAL GND
5	R	COMM (iPod->iPod ADAPTER)
6	G	COMM (iPod ADAPTER->iPod)
7	V	iPod SOUND SIGNAL RH (+)
9	L	iPod CONNECTION RECOGNITION GND
10	SHIELD	CHARGE POWER
12	W	SHIELD
14	SHIELD	ACCESSORY DETECT
15	BR	ACCESSORY IDENTIFY
16	R	ACCESSORY IDENTIFY

Connector No.	M251
Connector Name	WIRE TO WIRE
Connector Type	TH18MW-CSZ

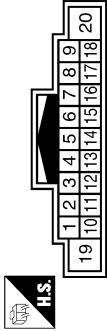

Terminal No.	Color of Wire	Signal Name [Specification]
5	SHIELD	-
6	W	-
8	SHIELD	-
9	G	-
14	R	-
15	B	-
17	SHIELD	-
18	R	-

Connector No.	M370
Connector Name	AV CONTROL UNIT (WITH BOSE SYSTEM WITHOUT NAVIGATION SYSTEM)
Connector Type	GT13SH-2/1S-HU



Terminal No.	Color of Wire	Signal Name [Specification]
33	-	FM SUB
34	-	AM-FM MAIN
35	-	ANTENNA AMP. ON SIGNAL

Connector No.	M253
Connector Name	AUXILIARY INPUT JACKS
Connector Type	A08FW

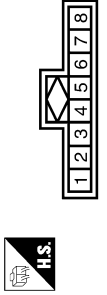

Terminal No.	Color of Wire	Signal Name [Specification]
1	R	SOUND SIGNAL RH (+)
2	W	SOUND SIGNAL GND
3	B	SOUND SIGNAL LH (-) [Without DVD player]
7	G	AUX IMAGE SIGNAL
8	R	AUX IMAGE GND [Without DVD player]

Connector No.	M275
Connector Name	WIRE TO WIRE
Connector Type	GT13SH-2/1S-HU



Terminal No.	Color of Wire	Signal Name [Specification]
1	-	-
2	-	-
3	-	-

JCNWM1870GI

AV CONTROL UNIT

[BOSE AUDIO WITHOUT NAVIGATION]

< ECU DIAGNOSIS >

BOSE AUDIO WITHOUT NAVIGATION WITHOUT DVD ENTERTAINMENT SYSTEM

Connector No.	M376	Connector No.	M378	Connector No.	M379	Connector No.	RT
Connector Name	WIRE TO WIRE	Connector Name	ANTENNA BASE (ANTENNA AMP.)	Connector Name	GLASS ANTENNA	Connector Name	WIRE TO WIRE
Connector Type	GT13SCH-2/1PP-HU	Connector Type	GT13SCH-1/1PP-HU	Connector Type	GT13SCH-1/1PP-HU	Connector Type	TH18FW-NH

Terminal No.	1	2	3	Terminal No.	1	2	3	4
Color of Wire	-	-	-	Color of Wire	-	-	R/W	R/L
Signal Name [Specification]	-	-	-	Signal Name [Specification]	-	-	-	- [With telephone without navigation system]

Terminal No.	1	2	3	Terminal No.	1	2	3	4
Color of Wire	-	-	-	Color of Wire	-	-	B	SHIELD
Signal Name [Specification]	-	-	-	Signal Name [Specification]	-	FM SUB	-	-

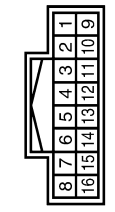
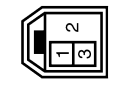

Connector No.	R20
Connector Name	MICROPHONE
Connector Type	TK04FW



Terminal No.	1	2	4	Terminal No.	1	2	4
Color of Wire	R/W	R/L	B	Color of Wire	-	-	-
Signal Name [Specification]	MICROPHONE SIGNAL (+)	MICROPHONE SIGNAL (-) (Only telephones without navigation system)	MICROPHONE POWER	Signal Name [Specification]	-	-	-

Wiring Diagram - BOSE AUDIO WITHOUT NAVIGATION WITH DVD ENTERTAINMENT SYSTEM -

NOTE:

JCNWM1871GI

INFOID:000000003557518

A
B
C
D
E
F
G
H
I
J
K
L
M
N
O
P

AV

AV CONTROL UNIT

[BOSE AUDIO WITHOUT NAVIGATION]

< ECU DIAGNOSIS >

In this section, PRESET SWITCH and MULTIFUNCTION SWITCH are written as the MULTIFUNCTION SWITCH.

BOSE AUDIO WITHOUT NAVIGATION WITH DVD ENTERTAINMENT SYSTEM

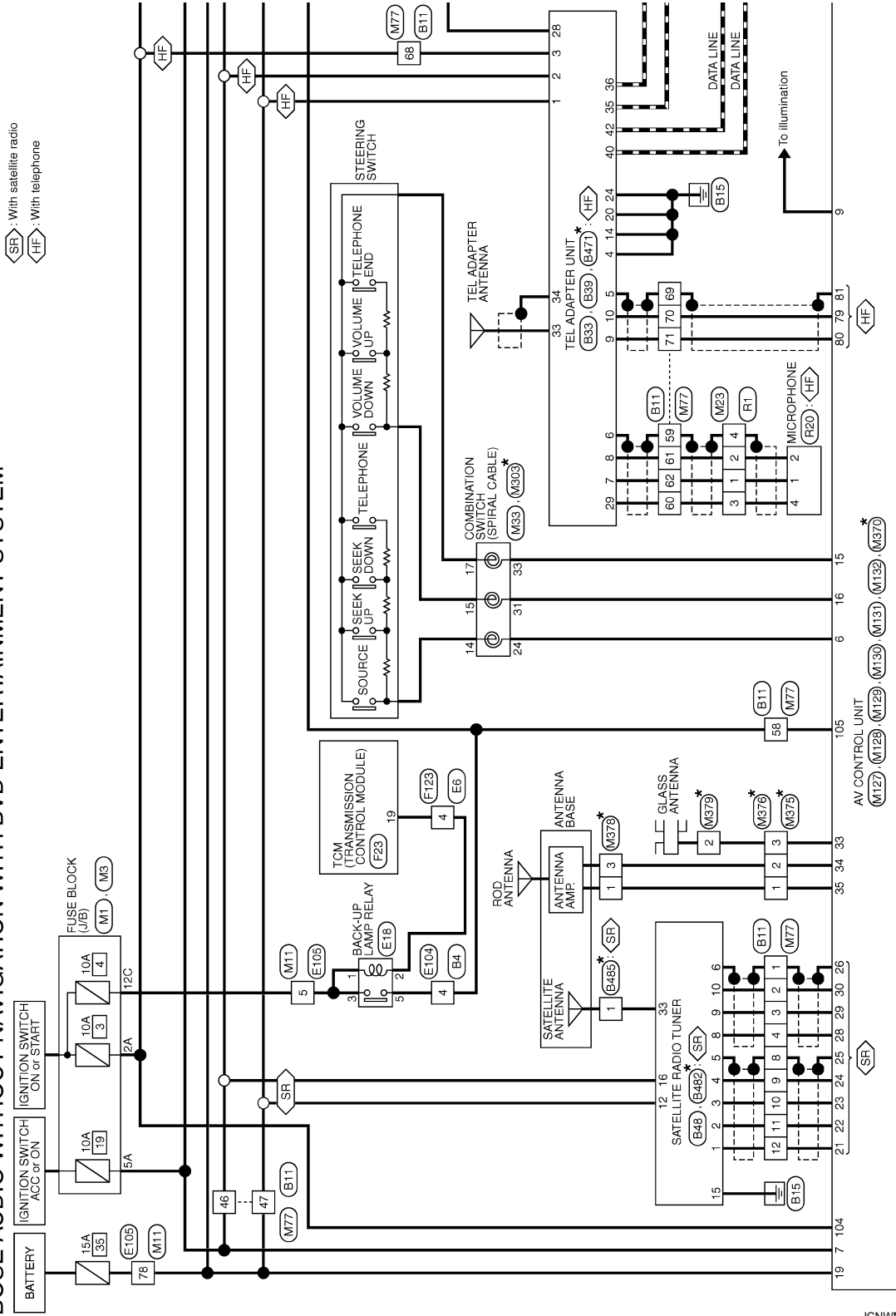

*: This connector is not shown in "Harness Layout".

2008/09/23

JCNWM1872GI

AV CONTROL UNIT

[BOSE AUDIO WITHOUT NAVIGATION]

< ECU DIAGNOSIS >

- WI: With iPod
- HF: With telephone
- OF: Without telephone

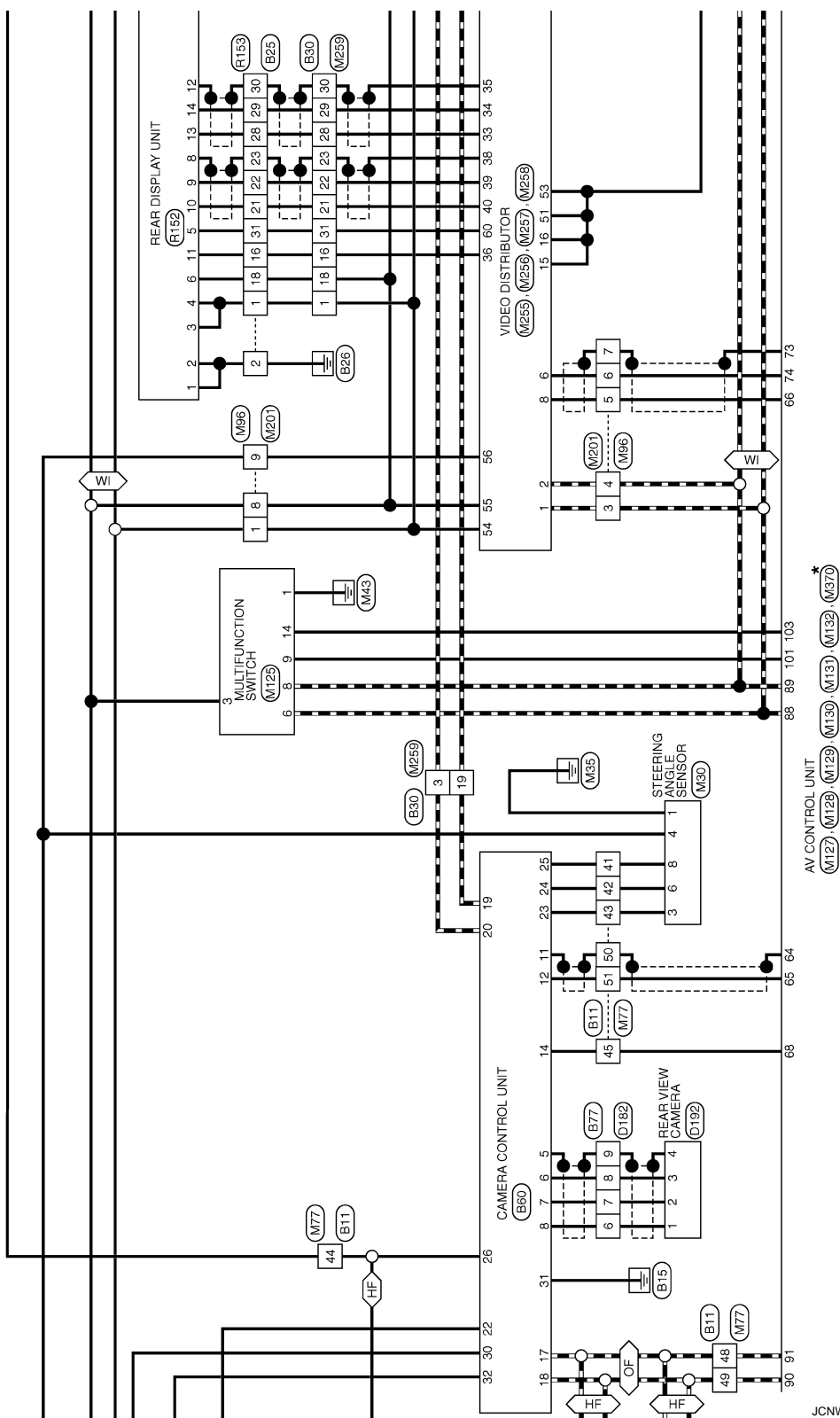

JCNWM1873GI

*: This connector is not shown in "Harness Layout".

A
B
C
D
E
F
G
H
I
J
K
L
M
AV
O
P

AV CONTROL UNIT

[BOSE AUDIO WITHOUT NAVIGATION]

< ECU DIAGNOSIS >

WI: With iPod

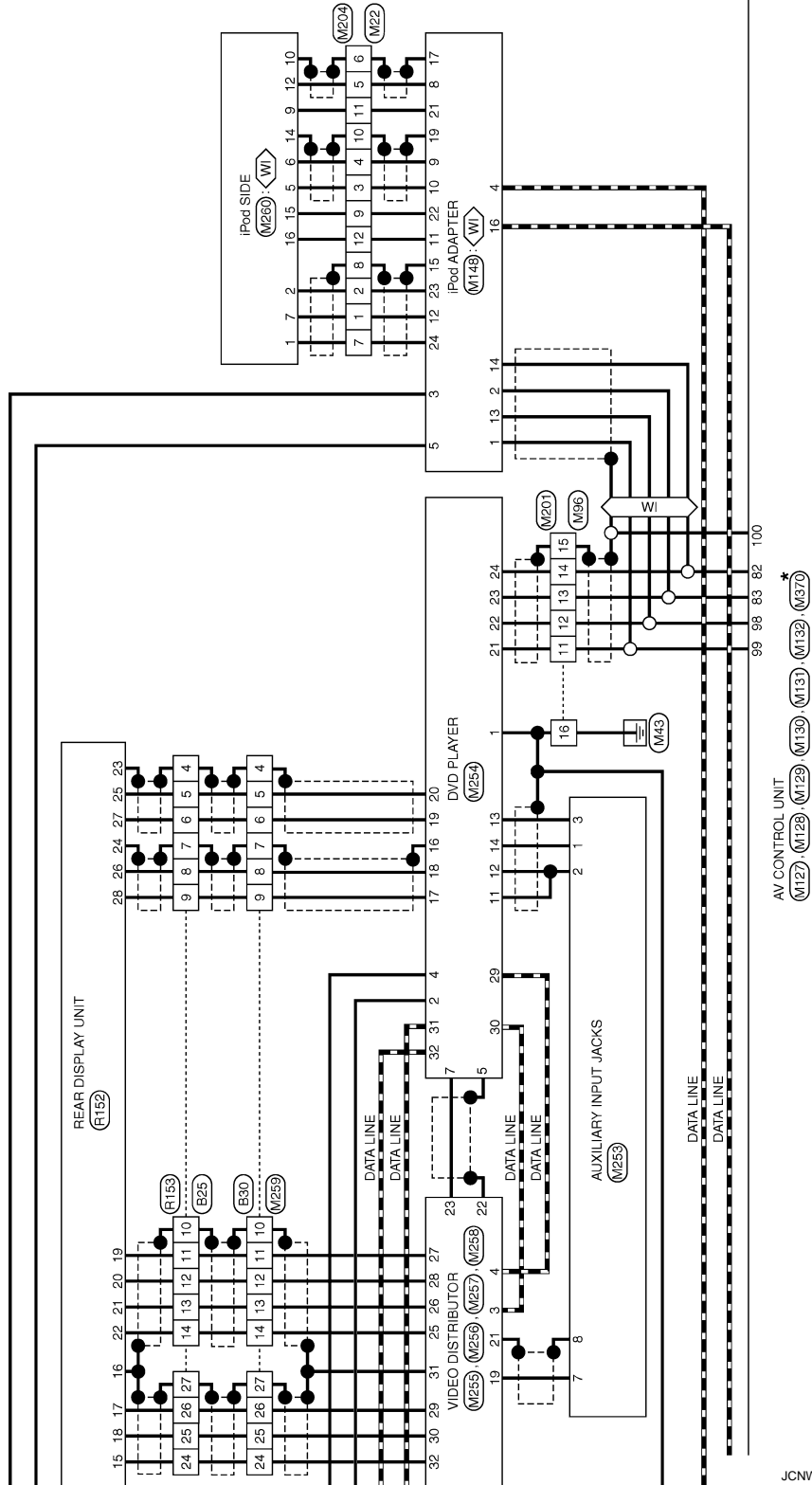

JCNWM1874GI

*: This connector is not shown in "Harness Layout".

AV CONTROL UNIT

[BOSE AUDIO WITHOUT NAVIGATION]

< ECU DIAGNOSIS >

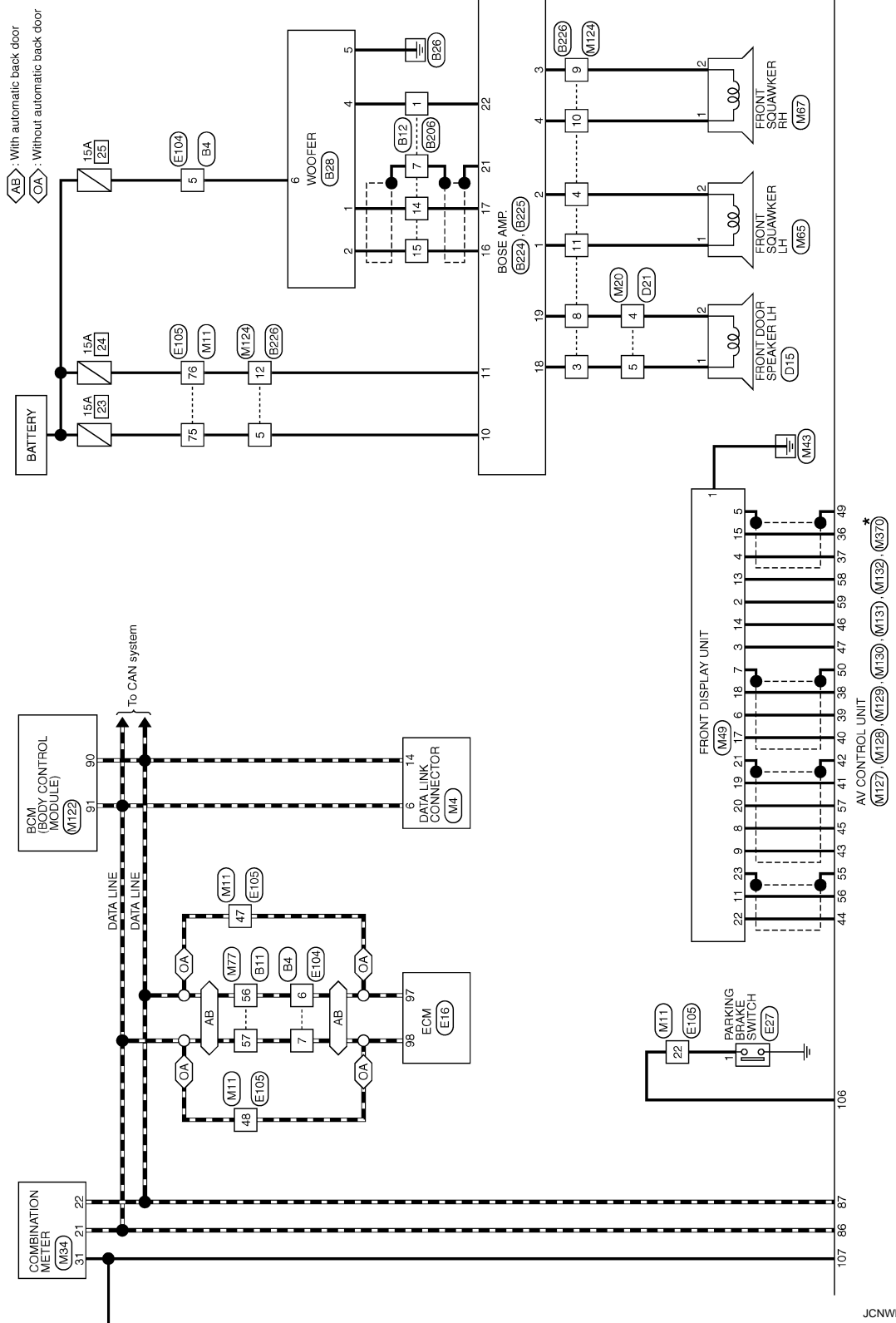

*: This connector is not shown in "Harness Layout".

JCNWM1875GI

A
B
C
D
E
F
G
H
I
J
K
L
M
N
O
P

AV

AV CONTROL UNIT

[BOSE AUDIO WITHOUT NAVIGATION]

< ECU DIAGNOSIS >

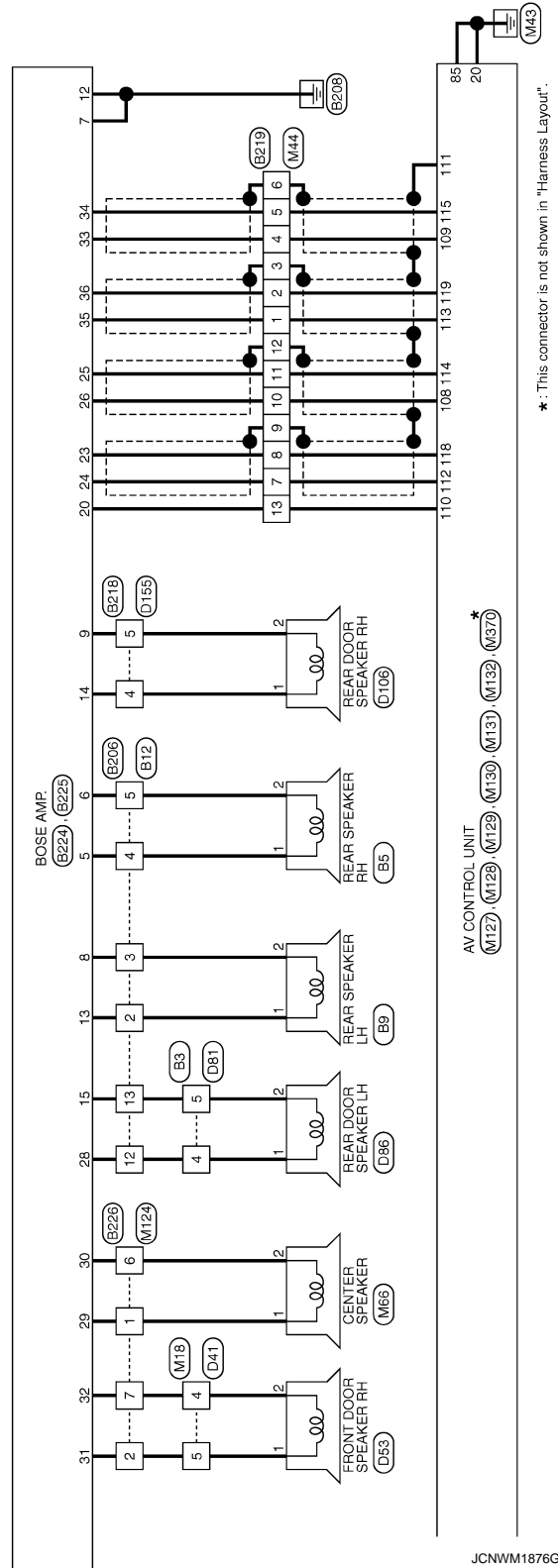

AV CONTROL UNIT

[BOSE AUDIO WITHOUT NAVIGATION]

< ECU DIAGNOSIS >

BOSE AUDIO WITHOUT NAVIGATION WITH DVD ENTERTAINMENT SYSTEM

Connector No.	B3
Connector Name	WIRE TO WIRE
Connector Type	TK0DFW-ANS8



Terminal No.	Color of Wire	Signal Name [Specification]
4	LG	-
5	O	-

Connector No.	B4
Connector Name	WIRE TO WIRE
Connector Type	NS16MHW-CS



Terminal No.	Color of Wire	Signal Name [Specification]
4	R	-
5	O	-
6	P	-
7	L	-

Connector No.	B5
Connector Name	REAR SPEAKER RH
Connector Type	TK02FBR



Terminal No.	Color of Wire	Signal Name [Specification]
1	V	-
2	LG	-

Connector No.	B9
Connector Name	REAR SPEAKER LH
Connector Type	TK02FBR

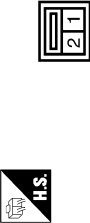

Terminal No.	Color of Wire	Signal Name [Specification]
1	SB	-
2	GR	-

Connector No.	B11
Connector Name	WIRE TO WIRE
Connector Type	TH80MW-CS19

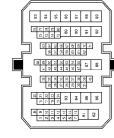

Terminal No.	Color of Wire	Signal Name [Specification]
1	SHIELD	-
2	B	-
3	R/L	-
4	R/W	-
8	SHIELD	-
9	BR/L	-
10	Y/G	-
11	Y/L	-
12	W/L	-
41	O	-
42	SB	-

43	G	-
44	BR	-
45	L	-
46	GR	-
47	V	-
48	GR	-(With rear view camera and telephone)
48	BR	-(With rear view camera without telephone)
49	Y	-
50	SHIELD	-
51	B	-
56	P	-
57	L	-
58	R	-
59	SHIELD	-
60	B	-
61	R/L	-
62	R/W	-
68	R	-
69	SHIELD	-
70	W/R	-
71	B/R	-

Connector No.	B12
Connector Name	WIRE TO WIRE
Connector Type	NS18FW-CS

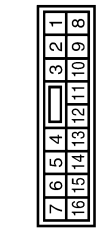

Terminal No.	Color of Wire	Signal Name [Specification]
1	W	-
2	SB	-
3	GR	-
4	V	-
5	LG	-
7	SHIELD	-
12	LG	-
13	O	-
14	W/R	-
15	B/R	-

A
B
C
D
E
F
G
H
I
J
K
L
M
O
P

AV

AV CONTROL UNIT

[BOSE AUDIO WITHOUT NAVIGATION]

< ECU DIAGNOSIS >

BOSE AUDIO WITHOUT NAVIGATION WITH DVD ENTERTAINMENT SYSTEM

Connector No.	B25
Connector Name	WIRE TO WIRE
Connector Type	TH22MW-NH



Terminal No.	Color of Wire	Signal Name [Specification]
1	SB	-
2	B	-
4	SHIELD	-
5	W/R	-
6	W/L	-
7	SHIELD	-
8	GR/V	-
9	W/L	-
10	SHIELD	-
11	W/L	-
12	Y/G	-

Connector No.	B30
Connector Name	WIRE TO WIRE
Connector Type	TH32FW-NH

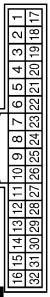

Terminal No.	Color of Wire	Signal Name [Specification]
1	SB	-
3	G	-
4	SHIELD	-
5	W/R	-
6	W/L	-
7	SHIELD	-
8	GR/V	-
9	W/L	-
10	SHIELD	-
11	W/L	-
12	Y/G	-

Terminal No.	Color of Wire	Signal Name [Specification]
13	Y/L	-
14	BR/L	-
16	V	-
18	O	-
21	B/R	-
22	W/R	-
23	SHIELD	-
24	B	-
25	R/L	-
26	R/W	-
27	SHIELD	-
28	B	-
29	W	-
30	SHIELD	-
31	P	-

Connector No.	B28
Connector Name	WOOFER
Connector Type	RS08FGY-PR



Terminal No.	Color of Wire	Signal Name [Specification]
1	W/R	SOUND SIGNAL WOOFER (-)
2	B/R	SOUND SIGNAL WOOFER (+)
4	W	WOOFER AMP. ON SIGNAL
5	B/W	GND
6	O	BAT

Connector No.	B33
Connector Name	TEL ADAPTER UNIT
Connector Type	TH08FW-NH



Terminal No.	Color of Wire	Signal Name [Specification]
35	Y	AV COMM (H)
36	BR	AV COMM (L)
40	G	AV COMM (H)
42	GR	AV COMM (L)

AV CONTROL UNIT

[BOSE AUDIO WITHOUT NAVIGATION]

< ECU DIAGNOSIS >

BOSE AUDIO WITHOUT NAVIGATION WITH DVD ENTERTAINMENT SYSTEM

Connector No.	B48
Connector Name	SATELLITE RADIO TUNER
Connector Type	A18FW

Terminal No.	Color of Wire	Signal Name [Specification]
1	W/L	SOUND SIGNAL LH (-)
2	Y/L	SOUND SIGNAL LH (+)
3	Y/G	SOUND SIGNAL RH (-)
4	BR/L	SOUND SIGNAL RH (+)
5	SHIELD	SHIELD
8	SHIELD	SHIELD
9	R/W	REQUEST (SAT->CONT)
10	B	COMM (SAT->CONT)
12	V	BATTERY
15	B	GND

20	B	CONTROL SIGNAL
24	B/W	CONTROL SIGNAL
26	BR	VEHICLE SPEED (8-PULSE)
29	B	MICROPHONE VCC

Connector No.	B38
Connector Name	TEL ADAPTER UNIT
Connector Type	TH22FW-NH

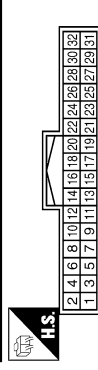
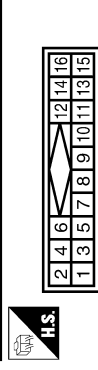

Connector No.	B206
Connector Name	WIRE TO WIRE
Connector Type	NS16MW-CS

Terminal No.	Color of Wire	Signal Name [Specification]
1	W/L	SOUND SIGNAL LH (-)
2	Y/L	SOUND SIGNAL LH (+)
3	Y/G	SOUND SIGNAL RH (-)
4	BR/L	SOUND SIGNAL RH (+)
5	SHIELD	SHIELD
8	SHIELD	SHIELD
9	R/W	REQUEST (SAT->CONT)
10	B	COMM (SAT->CONT)
12	V	BATTERY
15	B	GND

22	R	REVERSE
23	G	SENSOR SIGNAL 1
24	SB	SENSOR SIGNAL 2
25	O	SENSOR SIGNAL 3
26	BR	VEHICLE SPEED (8-PULSE)
30	GR	ACC
31	B	GND
32	V	BATTERY

Terminal No.	Color of Wire	Signal Name [Specification]
1	V	BATTERY
2	GR	ACC
3	R	IGNITION
4	B/W	GND
5	SHIELD	SHIELD
8	SHIELD	SHIELD
7	R/W	MICROPHONE SIGNAL
8	R/L	MICROPHONE GND
9	B/R	TEL VOICE SIGNAL (+)
10	W/R	TEL VOICE SIGNAL (-)
14	B	GND

Connector No.	B80
Connector Name	CAMERA CONTROL UNIT
Connector Type	TH22FW-NH

Terminal No.	Color of Wire	Signal Name [Specification]
5	SHIELD	SHIELD
6	B	CAMERA IMAGE SIGNAL
7	R/W	GND
8	R/L	CAMERA ON SIGNAL
11	SHIELD	SHIELD
12	B	CAMERA IMAGE SIGNAL
14	L	CONNECTION RECOGNITION
17	BR	AV COMM (L)
18	Y	AV COMM (H)
19	GR	AV COMM (L)
20	G	AV COMM (H)

Connector No.	B77
Connector Name	WIRE TO WIRE
Connector Type	TK12MW

Terminal No.	Color of Wire	Signal Name [Specification]
6	R/L	-
7	R/W	-
8	B	-
9	SHIELD	-

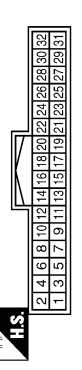
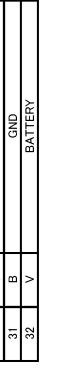
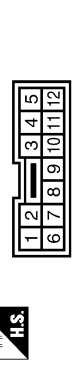

Terminal No.	Color of Wire	Signal Name [Specification]
1	W	-
2	GR	-
3	BR	-
4	Y	-
5	BR	-
7	SHIELD	-
12	G	-
13	R	-
14	W/R	-
15	B/R	-

Terminal No.	Color of Wire	Signal Name [Specification]
6	R/L	-
7	R/W	-
8	B	-
9	SHIELD	-

Terminal No.	Color of Wire	Signal Name [Specification]
5	SHIELD	SHIELD
6	B	CAMERA IMAGE SIGNAL
7	R/W	GND
8	R/L	CAMERA ON SIGNAL
11	SHIELD	SHIELD
12	B	CAMERA IMAGE SIGNAL
14	L	CONNECTION RECOGNITION
17	BR	AV COMM (L)
18	Y	AV COMM (H)
19	GR	AV COMM (L)
20	G	AV COMM (H)

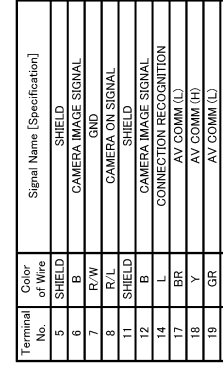

JCNWM1879GI

A
B
C
D
E
F
G
H
I
J
K
L
M
N
O
P

AV

AV CONTROL UNIT

[BOSE AUDIO WITHOUT NAVIGATION]

< ECU DIAGNOSIS >

BOSE AUDIO WITHOUT NAVIGATION WITH DVD ENTERTAINMENT SYSTEM

Connector No.	B218
Connector Name	WIRE TO WIRE
Connector Type	TK10FW-NSB



Terminal No.	Color of Wire	Signal Name [Specification]
4	L	-[With BOSE system]
5	O	-[With BOSE system]

Connector No.	B219
Connector Name	WIRE TO WIRE
Connector Type	TK132MF-NH



Terminal No.	Color of Wire	Signal Name [Specification]
1	W/R	-
2	B/R	-
3	SHIELD	-
4	W/R	-
5	B/R	-
6	SHIELD	-
7	GR/V	-
8	W/L	-
9	SHIELD	-
10	GR/V	-
11	W/L	-

Connector No.	B224
Connector Name	BOSE AMP.
Connector Type	SGA12FBR-SJAZ

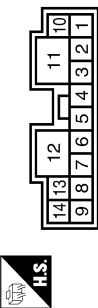

Terminal No.	Color of Wire	Signal Name [Specification]
1	LG	SOUND SIGNAL FRONT SQUAWKER LH (+)
2	V	SOUND SIGNAL FRONT SQUAWKER LH (-)
3	L	SOUND SIGNAL FRONT SQUAWKER RH (-)
4	P	SOUND SIGNAL FRONT SQUAWKER RH (+)
5	Y	SOUND SIGNAL REAR SQUAWKER LH (+)
6	BR	SOUND SIGNAL REAR SQUAWKER RH (-)
7	B	GND
8	BR	SOUND SIGNAL REAR SQUAWKER LH (-)
9	O	SOUND SIGNAL REAR DOOR SPEAKER RH (-)
10	SB	BATTERY
11	GR	BATTERY

Connector No.	B225
Connector Name	BOSE AMP.
Connector Type	SCA19FBR-SGA4

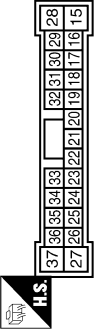

Terminal No.	Color of Wire	Signal Name [Specification]
15	R	SOUND SIGNAL REAR DOOR SPEAKER LH (-)
16	B/R	SOUND SIGNAL WOOFER (+)
17	W/R	SOUND SIGNAL WOOFER (-)
18	W	SOUND SIGNAL FRONT DOOR SPEAKER LH (+)
19	B	SOUND SIGNAL FRONT DOOR SPEAKER LH (-)
20	SB	AMP. ON SIGNAL
21	SHIELD	SHIELD
22	W	WOOFER AMP. ON SIGNAL
23	W/L	SOUND SIGNAL REAR LH (-)
24	GR/V	SOUND SIGNAL REAR LH (+)
25	W/L	SOUND SIGNAL REAR RH (-)

12	SHIELD
13	SB

26	GR/V	SOUND SIGNAL REAR RH (+)
28	G	SOUND SIGNAL REAR DOOR SPEAKER LH (+)
29	V	SOUND SIGNAL CENTER SPEAKER (+)
30	P	SOUND SIGNAL CENTER SPEAKER (-)
31	BR	SOUND SIGNAL FRONT DOOR SPEAKER RH (+)
32	Y	SOUND SIGNAL FRONT DOOR SPEAKER RH (-)
33	W/R	SOUND SIGNAL FRONT RH (+)
34	B/R	SOUND SIGNAL FRONT RH (-)
35	W/R	SOUND SIGNAL FRONT LH (+)
36	B/R	SOUND SIGNAL FRONT LH (-)

AV CONTROL UNIT

[BOSE AUDIO WITHOUT NAVIGATION]

< ECU DIAGNOSIS >

BOSE AUDIO WITHOUT NAVIGATION WITH DVD ENTERTAINMENT SYSTEM

Connector No.	B226
Connector Name	WIRE TO WIRE
Connector Type	NS2MBR-CS

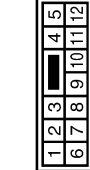

Terminal No.	Color of Wire	Signal Name [Specification]
1	V	
2	BR	
3	W	
4	V	
5	SB	
6	P	
7	Y	
8	B	
9	L	
10	P	
11	LG	

12	GR
----	----

Connector No.	B471
Connector Name	TEL ADAPTER UNIT
Connector Type	GT18C-1S-HU



Terminal No.	Color of Wire	Signal Name [Specification]
33	-	TEL ANTENNA
34	SHIELD	SHIELD

Connector No.	B482
Connector Name	SATELLITE RADIO TUNER
Connector Type	FAK8A



Terminal No.	Color of Wire	Signal Name [Specification]
33	-	SATELLITE ANTENNA

Connector No.	B485
Connector Name	ANTENNA BASE (SATELLITE ANTENNA) WITH BOSE SYSTEM WITHOUT NAVIGATION SYSTEM
Connector Type	GT18C-1PP-HU



Connector No.	D15
Connector Name	FRONT DOOR SPEAKER LH (WITH BOSE SYSTEM)
Connector Type	NS02FBR-CS



Connector No.	D21
Connector Name	WIRE TO WIRE
Connector Type	TH40FW-CS15

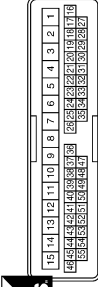

Connector No.	D41
Connector Name	WIRE TO WIRE
Connector Type	TH40FW-CS15

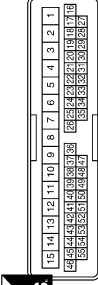

Terminal No.	Color of Wire	Signal Name [Specification]
1	-	SATELLITE ANTENNA

Terminal No.	Color of Wire	Signal Name [Specification]
1	L	-[Type A]
1	W	-[Type B]
2	B/W	-[Type A]
2	B	-[Type B]

Terminal No.	Color of Wire	Signal Name [Specification]
4	B/W	-[Type A]
4	B	-[Type B]
5	L	-[Type A]
5	W	-[Type B]

Terminal No.	Color of Wire	Signal Name [Specification]
4	B/R	-[Type A]
4	B	-[Type B]
5	BR	-[Type A]
5	W	-[Type B]

JCNWM1881GI

A
B
C
D
E
F
G
H
I
J
K
L
M
O
P

AV

AV CONTROL UNIT

[BOSE AUDIO WITHOUT NAVIGATION]

< ECU DIAGNOSIS >

BOSE AUDIO WITHOUT NAVIGATION WITH DVD ENTERTAINMENT SYSTEM

Connector No.	D153
Connector Name	FRONT DOOR SPEAKER RH (WITH BOSE SYSTEM)
Connector Type	NS02FBR-CS



Terminal No.	Color of Wire	Signal Name [Specification]
1	BR	-[Type A]
2	W	-[Type B]
3	B/R	-[Type A]
4	B	-[Type B]
5	B	-[Type B]

Connector No.	D181
Connector Name	WIRE TO WIRE
Connector Type	TK10MW-NS8

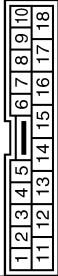

Terminal No.	Color of Wire	Signal Name [Specification]
4	L	-
5	W	-

Connector No.	D186
Connector Name	REAR DOOR SPEAKER LH (WITH BOSE SYSTEM)
Connector Type	NS02FBR-CS



Terminal No.	Color of Wire	Signal Name [Specification]
1	L	-
2	W	-

Connector No.	D106
Connector Name	REAR DOOR SPEAKER RH (WITH BOSE SYSTEM)
Connector Type	NS02FBR-CS



Terminal No.	Color of Wire	Signal Name [Specification]
1	O	-[Type A]
2	L	-[Type B]
2	B/P	-[Type A]
2	W	-[Type B]

Connector No.	D155
Connector Name	WIRE TO WIRE
Connector Type	TK10MW-NS8



Terminal No.	Color of Wire	Signal Name [Specification]
4	O	-[Type A]
4	L	-[Type B]
5	B/P	-[Type A]
5	W	-[Type B]

Connector No.	D182
Connector Name	WIRE TO WIRE
Connector Type	TK12FW

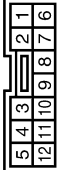

Terminal No.	Color of Wire	Signal Name [Specification]
6	R	-
7	G	-
8	B	-
9	SHIELD	-

Connector No.	D192
Connector Name	REAR VIEW CAMERA
Connector Type	TK4MMW-NH



Terminal No.	Color of Wire	Signal Name [Specification]
1	R	CAMERA ON SIGNAL
2	G	GND
3	B	CAMERA IMAGE SIGNAL
4	SHIELD	SHIELD

Connector No.	E6
Connector Name	WIRE TO WIRE
Connector Type	TK16MGY-TV



Terminal No.	Color of Wire	Signal Name [Specification]
4	R	-

JCNWM1882GI

AV CONTROL UNIT

[BOSE AUDIO WITHOUT NAVIGATION]

< ECU DIAGNOSIS >

BOSE AUDIO WITHOUT NAVIGATION WITH DVD ENTERTAINMENT SYSTEM

Connector No.	E18
Connector Name	ECM
Connector Type	RH24FB-RZ8-L-LH

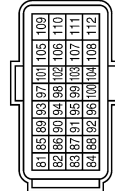

Terminal No.	Color of Wire	Signal Name [Specification]
97	P	VEHGAN-L
98	L	VEHGAN-H

Connector No.	E18
Connector Name	BACK-UP LAMP RELAY
Connector Type	MS02FL-M2-LC

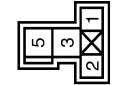

Terminal No.	Color of Wire	Signal Name [Specification]
1	LG	-
2	R	-
3	LG	-
5	R	-

Connector No.	E27
Connector Name	PARKING BRAKE SWITCH
Connector Type	F01FB-A



Terminal No.	Color of Wire	Signal Name [Specification]
1	P	-

Connector No.	E104
Connector Name	WIRE TO WIRE
Connector Type	NS38FW-CS

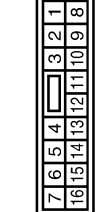

Terminal No.	Color of Wire	Signal Name [Specification]
4	R	-
5	L	-
6	P	-
7	L	-

Connector No.	E105
Connector Name	WIRE TO WIRE
Connector Type	TH170MW-CS10-M3

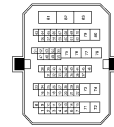

Terminal No.	Color of Wire	Signal Name [Specification]
5	LG	-
22	P	-
47	P	-
48	L	-
75	BR	-
76	GR	-
78	V	-

Connector No.	F23
Connector Name	TOM (TRANSMISSION CONTROL MODULE)
Connector Type	RH40FB-RZ8-L-RH

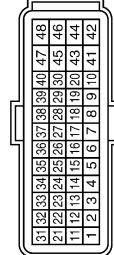

Terminal No.	Color of Wire	Signal Name [Specification]
19	G/B	REV LAMP RELAY

Connector No.	F123
Connector Name	WIRE TO WIRE
Connector Type	TK18FGY-1V

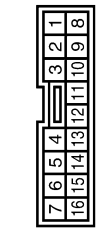

Terminal No.	Color of Wire	Signal Name [Specification]
4	G/B	-

Connector No.	M1
Connector Name	FUSE BLOCK (J/B)
Connector Type	NS308FW-M2

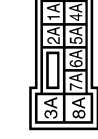

Terminal No.	Color of Wire	Signal Name [Specification]
2A	G	-
5A	R	-

A
B
C
D
E
F
G
H
I
J
K
L
M
AV
O
P

AV CONTROL UNIT

[BOSE AUDIO WITHOUT NAVIGATION]

< ECU DIAGNOSIS >

BOSE AUDIO WITHOUT NAVIGATION WITH DVD ENTERTAINMENT SYSTEM

Connector No.	M3
Connector Name	FUSE BLOCK (J/B)
Connector Type	HS12FW-CS

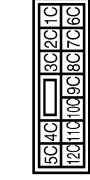

Terminal No.	Color of Wire	Signal Name [Specification]
12C	O	-

Connector No.	M4
Connector Name	DATA LINK CONNECTOR
Connector Type	BD16FW



Terminal No.	Color of Wire	Signal Name [Specification]
6	L	-
14	P	-

Connector No.	M11
Connector Name	WIRE TO WIRE
Connector Type	TH10FW-CS10-M3

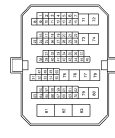

Terminal No.	Color of Wire	Signal Name [Specification]
5	O	-
22	G	-
47	P	-
48	L	-
75	BR	-
76	R	-
78	Y	-

Connector No.	M18
Connector Name	WIRE TO WIRE
Connector Type	TH40MW-CS15

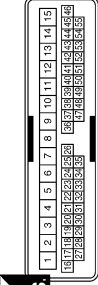

Terminal No.	Color of Wire	Signal Name [Specification]
4	W	-
5	BR	- [Type A and without BOSE system type B]
5	B	- [With BOSE system type B]

Connector No.	M20
Connector Name	WIRE TO WIRE
Connector Type	TH40MW-CS15

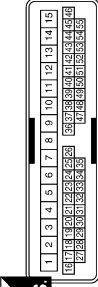

Terminal No.	Color of Wire	Signal Name [Specification]
4	B	-
5	L	-

Connector No.	M22
Connector Name	WIRE TO WIRE
Connector Type	TH12FW-NH

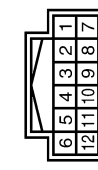

Terminal No.	Color of Wire	Signal Name [Specification]
1	V	-
2	R	-
3	R	-
4	G	-
5	W	-
6	SHIELD	-
7	LG	-
8	SHIELD	-
9	BR	-
10	SHIELD	-
11	L	-

Connector No.	M23
Connector Name	WIRE TO WIRE
Connector Type	TH16MW-NH

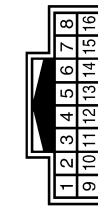

Terminal No.	Color of Wire	Signal Name [Specification]
1	W	-
2	R	- [With telephones without navigation system]
3	B	-
4	SHIELD	-

AV CONTROL UNIT

[BOSE AUDIO WITHOUT NAVIGATION]

< ECU DIAGNOSIS >

BOSE AUDIO WITHOUT NAVIGATION WITH DVD ENTERTAINMENT SYSTEM

Connector No.	M33
Connector Name	STEERING ANGLE SENSOR
Connector Type	TH08FW-NH

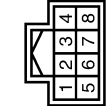

Connector No.	M33
Connector Name	COMBINATION SWITCH (SPIRAL CABLE)
Connector Type	TH08FGY-1V

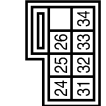

Connector No.	M34
Connector Name	COMBINATION METER
Connector Type	TH46FW-NH

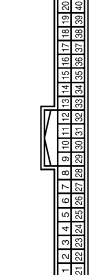

Terminal No.	Color of Wire	Signal Name [Specification]
1	B	-
3	L	-
4	G	-
6	SB	-
8	O	-

Terminal No.	Color of Wire	Signal Name [Specification]
24	BR	- [With audio steering switch and telephone]
31	G	- [With audio steering switch and telephone]
33	L	- [With audio steering switch and telephone]

Terminal No.	Color of Wire	Signal Name [Specification]
21	L	CAN-H
22	P	CAN-L
31	V	VEHICLE SPEED (8-PULSE)

Connector No.	M44
Connector Name	WIRE TO WIRE
Connector Type	TH22FW-NH

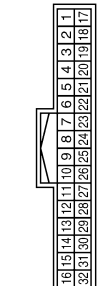

Terminal No.	10	V	-
Terminal No.	11	LG	-
Terminal No.	12	SHIELD	-
Terminal No.	13	P	-

Connector No.	M49
Connector Name	FRONT DISPLAY UNIT
Connector Type	TH24FW-NH

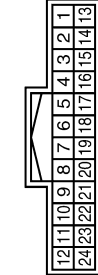

Terminal No.	14	LG	SIGNAL GND [Without navigation system]
Terminal No.	15	L	COMPOSITE IMAGE SIGNAL [Without navigation system]
Terminal No.	17	G	RGB (RED) SIGNAL
Terminal No.	18	Y	RGB (BLUE) SIGNAL [Without navigation system]
Terminal No.	19	B	RGB SYNC
Terminal No.	20	R	VP
Terminal No.	21	SHIELD	SHIELD
Terminal No.	22	G	COMM (DISEP->CONT)
Terminal No.	23	SHIELD	SHIELD

Terminal No.	Color of Wire	Signal Name [Specification]
1	G	-
2	R	-
3	SHIELD	-
4	B	-
5	W	-
6	SHIELD	-
7	O	- [Type A]
7	L	- [Type B]
8	SB	- [Type A]
8	R	- [Type B]
9	SHIELD	-

Terminal No.	Color of Wire	Signal Name [Specification]
1	B	GND
2	Y	INVERTER VCCI [Without navigation system]
3	O	SIGNAL VCCI [Without navigation system]
4	P	COMPOSITE IMAGE GND [Without navigation system]
5	SHIELD	SHIELD [Without navigation system]
6	L	RGB (GREEN) SIGNAL [Without navigation system]
7	SHIELD	SHIELD
8	G	HP [Without navigation system]
9	W	RGB AREA (YS) SIGNAL
11	R	COMM (CONT->DISEP)
13	BR	INVERTER GND [Without navigation system]

JCNWM1885GI

A
B
C
D
E
F
G
H
I
J
K
L
M
N
O
P

AV

AV CONTROL UNIT

[BOSE AUDIO WITHOUT NAVIGATION]

< ECU DIAGNOSIS >

BOSE AUDIO WITHOUT NAVIGATION WITH DVD ENTERTAINMENT SYSTEM

Connector No.	M65
Connector Name	FRONT SQUAWKER LH
Connector Type	TK02FBR



Terminal No.	Color of Wire	Signal Name [Specification]
1	LG	- [With BOSE system]
2	Y	- [With BOSE system]

Connector No.	M66
Connector Name	CENTER SPEAKER
Connector Type	TK02FBR



Terminal No.	Color of Wire	Signal Name [Specification]
1	P	-
2	O	-

Connector No.	M67
Connector Name	FRONT SQUAWKER RH
Connector Type	TK02FBR



Terminal No.	Color of Wire	Signal Name [Specification]
1	BR	-
2	R	- [With BOSE system]

Connector No.	M77
Connector Name	WIRE TO WIRE
Connector Type	TH80FW-CS19

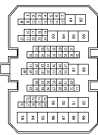

Terminal No.	Color of Wire	Signal Name [Specification]
1	SHIELD	-
2	B	-
3	W	-
4	R	-
8	SHIELD	-
9	W	-
10	R	-
11	G	-
12	B	-
41	O	-
42	SB	-

43	L	-
44	V	-
45	P	-
46	R	-
47	Y	-
48	L	-
49	G	-
50	SHIELD	-
51	W	-
56	P	-
57	L	-
58	SB	-
59	SHIELD	-
60	B	-
61	R	-
62	W	-
68	G	-
69	SHIELD	-
70	L	-
71	R	-

Connector No.	M96
Connector Name	WIRE TO WIRE
Connector Type	TH18FW-NH

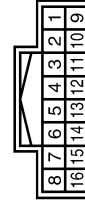

Terminal No.	Color of Wire	Signal Name [Specification]
1	Y	-
3	R	-
4	L	-
5	L	-
6	R	-
7	SHIELD	-
8	R	-
9	G	-
11	B	-
12	G	-
13	R	-

14	W	-
15	SHIELD	-
16	B	-

JCNWM1886G1

AV CONTROL UNIT

[BOSE AUDIO WITHOUT NAVIGATION]

< ECU DIAGNOSIS >

BOSE AUDIO WITHOUT NAVIGATION WITH DVD ENTERTAINMENT SYSTEM

Connector No.	M122
Connector Name	BCM (BODY CONTROL MODULE)
Connector Type	TH40FB-NH

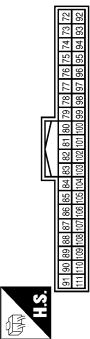

Terminal No.	Color of Wire	Signal Name [Specification]
90	P	CAN-L
91	L	CAN-H

11	LG	-
12	R	-



Terminal No.	Color of Wire	Signal Name [Specification]
1	P	-
2	BR	- [Type A]
3	B	- [Type B]
4	L	-
5	Y	-
6	BR	-
7	W	-
8	B	-
9	R	-
10	BR	-

Connector No.	M125
Connector Name	MULTIFUNCTION SWITCH
Connector Type	TH18FW-NH



Terminal No.	Color of Wire	Signal Name [Specification]
1	B	GND
3	R	ACC
6	R	AV COMM (H)
8	L	AV COMM (L)
9	V	SW GND
14	W	EJECT SIGNAL

Connector No.	M127
Connector Name	AV CONTROL UNIT (WITH BOSE SYSTEM WITHOUT NAVIGATION SYSTEM)
Connector Type	TH18FW-CS2



Terminal No.	Color of Wire	Signal Name [Specification]
6	BR	STRG SW A
7	R	ACC
9	R	ILLUMINATION
15	L	STRG SW GND
16	G	STRG SW B
19	Y	BATTERY
20	B	GND

Connector No.	M128
Connector Name	AV CONTROL UNIT (WITH BOSE SYSTEM WITHOUT NAVIGATION SYSTEM)
Connector Type	A12FW



Terminal No.	Color of Wire	Signal Name [Specification]
21	B	SATELLITE RADIO SOUND SIGNAL LH (-)
22	G	SATELLITE RADIO SOUND SIGNAL LH (+)
23	R	SATELLITE RADIO SOUND SIGNAL RH (-)
24	W	SATELLITE RADIO SOUND SIGNAL RH (+)
25	SHIELD	SHIELD
26	SHIELD	SHIELD
28	R	REQUEST (SAT->CONT)
29	W	COMM (SAT->CONT)
30	B	COMM (CONT->SAT)

Connector No.	M129
Connector Name	AV CONTROL UNIT (WITH BOSE SYSTEM WITHOUT NAVIGATION SYSTEM)
Connector Type	TH24FW-NH



Terminal No.	Color of Wire	Signal Name [Specification]
36	L	COMPOSITE IMAGE SIGNAL
37	P	COMPOSITE IMAGE GND
38	Y	RGB (B/BLUE) SIGNAL
39	L	RGB (G/GREEN) SIGNAL
40	G	RGB (R/RED) SIGNAL
41	B	RGB SYNC
42	SHIELD	SHIELD
43	W	RGB AREA (YS) SIGNAL
44	G	COMM (DISP->CONT)
45	G	HP
46	LG	SIGNAL GND

A
B
C
D
E
F
G
H
I
J
K
L
M
N
O
P

AV

AV CONTROL UNIT

[BOSE AUDIO WITHOUT NAVIGATION]

< ECU DIAGNOSIS >

BOSE AUDIO WITHOUT NAVIGATION WITH DVD ENTERTAINMENT SYSTEM

Connector No.	M130
Connector Name	AV CONTROL UNIT (WITH BOSE SYSTEM WITHOUT NAVIGATION SYSTEM)
Connector Type	TH16FW-NH



67	66	65	64	63	62	61	60
75	74	73	72	71	70	69	68

Terminal No.	Color of Wire	Signal Name [Specification]
64	SHIELD	SHIELD
65	W	CAMERA IMAGE SIGNAL
66	L	COMPOSITE IMAGE SIGNAL(With DVD player)
68	P	CONNECTION RECOGNITION SHIELD(With DVD player)
73	SHIELD	SHIELD(With DVD player)
74	R	COMPOSITE IMAGE_GND(With DVD player)

Connector No.	M131
Connector Name	AV CONTROL UNIT (WITH BOSE SYSTEM WITH NAVIGATION SYSTEM)
Connector Type	TH24FW-NH



71	70	69	68	67	66	65	64	63	62	61	60	59	58	57	56	55	54	53	52	51	50	49	48	47	46	45	44	43	42	41	40	39	38	37	36	35	34	33	32	31	30	29	28	27	26	25	24	23	22	21	20	19	18	17	16	15	14	13	12	11	10	9	8	7	6	5	4	3	2	1
----	----	----	----	----	----	----	----	----	----	----	----	----	----	----	----	----	----	----	----	----	----	----	----	----	----	----	----	----	----	----	----	----	----	----	----	----	----	----	----	----	----	----	----	----	----	----	----	----	----	----	----	----	----	----	----	----	----	----	----	----	----	---	---	---	---	---	---	---	---	---

Terminal No.	Color of Wire	Signal Name [Specification]
79	L	TEL VOICE SIGNAL (-)
80	R	TEL VOICE SIGNAL (+)
81	SHIELD	SHIELD
82	W	SOUND SIGNAL RH (-)(With DVD player)
83	R	SOUND SIGNAL RH (+)(With DVD player)
85	B	GND
86	L	CAN-H
87	P	CAN-L
88	R	AV COMM (H)
89	L	AV COMM (L)
90	G	AV COMM (H)

Terminal No.	119	R	SOUND SIGNAL FRONT LH (-)
--------------	-----	---	---------------------------

91	L	AV COMM (L)
98	G	SOUND SIGNAL LH (-)(With DVD player)
99	B	SOUND SIGNAL LH (+)(With DVD player)
100	SHIELD	SHIELD(With DVD player)
101	V	SW GND
103	W	EJECT SIGNAL
104	G	IGNITION
105	SB	REVERSE
106	G	PARKING BRAKE
107	V	VEHICLE SPEED (8-PULSE)

Connector No.	M148
Connector Name	iPod ADAPTER
Connector Type	TH24FW-NH



1	2	3	4	5	6	7	8	9	10	11	12
13	14	15	16	17	18	19	20	21	22	23	24

Terminal No.	Color of Wire	Signal Name [Specification]
108	V	SOUND SIGNAL REAR RH (+)
109	B	SOUND SIGNAL FRONT RH (+)
110	P	AMP_ON SIGNAL
111	SHIELD	SHIELD
112	O	SOUND SIGNAL REAR LH (+)(Type A)
112	L	SOUND SIGNAL REAR LH (+)(Type B)
113	G	SOUND SIGNAL FRONT LH (+)
114	LG	SOUND SIGNAL REAR RH (-)
115	W	SOUND SIGNAL FRONT RH (-)
118	SB	SOUND SIGNAL REAR LH (-)(Type A)
118	R	SOUND SIGNAL REAR LH (-)(Type B)

14	W	iPod SOUND SIGNAL RH (-)
15	SHIELD	SHIELD
16	R	AV COMM (H)
17	SHIELD	GND
19	SHIELD	SHIELD
21	L	iPod CONNECTION RECOGNITION
22	BR	ACCESSORY DETECT
23	R	iPod SOUND SIGNAL GND
24	LG	iPod SOUND SIGNAL LH (+)

Terminal No.	Color of Wire	Signal Name [Specification]
1	BR	iPod SOUND SIGNAL LH (+)
2	R	iPod SOUND SIGNAL RH (+)
3	R	ACC
4	L	AV COMM (L)
5	Y	BATTERY
8	W	CHARGE POWER
9	G	COMM (iPod ADAPTER->iPod)
10	R	COMM (iPod->iPod ADAPTER)
11	R	ACCESSORY IDENTIFY
12	V	iPod SOUND SIGNAL RH (+)
13	L	iPod SOUND SIGNAL LH (-)

AV CONTROL UNIT

[BOSE AUDIO WITHOUT NAVIGATION]

< ECU DIAGNOSIS >

BOSE AUDIO WITHOUT NAVIGATION WITH DVD ENTERTAINMENT SYSTEM

Connector No.	M201
Connector Name	WIRE TO WIRE
Connector Type	TH181MW-NH



Terminal No.	Color of Wire	Signal Name [Specification]
1	Y	-
3	R	-
4	G	-
5	L	-
6	P	-
7	SHIELD	-
8	V	-
9	G	-
11	B	-
12	G	-
13	R	-

Terminal No.	14	W
Terminal No.	15	SHIELD
Terminal No.	16	B



Terminal No.	Color of Wire	Signal Name [Specification]
1	V	-
2	R	-
3	R	-
4	G	-
5	W	-
8	SHIELD	-
7	LG	-
8	SHIELD	-
9	BR	-
10	SHIELD	-
11	L	-

Connector No.	M204
Connector Name	WIRE TO WIRE
Connector Type	TH12MW-NH



Connector No.	M254
Connector Name	DVD PLAYER
Connector Type	TH32FW-NH



Terminal No.	Color of Wire	Signal Name [Specification]
18	R	HEADPHONE SOUNDSIGNAL SIGNAL LH (-)
19	V	HEADPHONE SOUNDSIGNAL SIGNAL RH (+)
20	LG	HEADPHONE SOUNDSIGNAL SIGNAL RH (-)
21	B	SOUND SIGNAL LH (+)
22	G	SOUND SIGNAL LH (-)
23	R	SOUND SIGNAL RH (+)
24	W	SOUND SIGNAL RH (-)
29	L	AV COMM (L)
30	R	AV COMM (H)
31	L	AV COMM (L)
32	R	AV COMM (H)

Connector No.	M253
Connector Name	AUXILIARY INPUT JACKS
Connector Type	A08FW



Terminal No.	Color of Wire	Signal Name [Specification]
1	R	SOUND SIGNAL RH (+)
2	W	SOUND SIGNAL GND
3	G	SOUND SIGNAL LH (-) [With DVD player]
7	G	AUX IMAGE SIGNAL
8	SHIELD	SHIELD [With DVD player]

Connector No.	M255
Connector Name	VIDEO DISTRIBUTOR
Connector Type	TH08FW-NH



Terminal No.	Color of Wire	Signal Name [Specification]
53	B	GND
54	Y	BATTERY
55	V	ACC
56	G	IGNITION
60	R	HEADPHONE ON SIGNAL

JCNWM1889GI

A
B
C
D
E
F
G
H
I
J
K
L
M
O
P

AV

AV CONTROL UNIT

[BOSE AUDIO WITHOUT NAVIGATION]

< ECU DIAGNOSIS >

BOSE AUDIO WITHOUT NAVIGATION WITH DVD ENTERTAINMENT SYSTEM

Connector No.	M256
Connector Name	VIDEO DISTRIBUTOR
Connector Type	TH12FW-NH



Connector No.	M257
Connector Name	VIDEO DISTRIBUTOR
Connector Type	TH11FW-NH

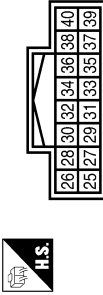

Terminal No.	Color of Wire	Signal Name [Specification]
51	B	GND

Terminal No.	Color of Wire	Signal Name [Specification]
25	R	RGB (R/RED) SIGNAL
26	L	RGB (G/GREEN) SIGNAL
27	W	RGB GND
28	G	RGB (B/B/LUE) SIGNAL
29	R	YP
30	W	HP
31	SHIELD	SHIELD
32	B	RGB AREA (S) SIGNAL
33	G	COMPOSITE SYNC
34	R	COMPOSITE IMAGE SIGNAL
35	SHIELD	SHIELD

Connector No.	M258
Connector Name	VIDEO DISTRIBUTOR
Connector Type	TH124FW-NH

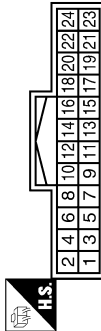

Terminal No.	Color of Wire	Signal Name [Specification]
1	R	AV COMM (H)
2	G	AV COMM (L)
3	R	AV COMM (H)
4	L	AV COMM (L)
6	R	COMPOSITE IMAGE GND
8	L	COMPOSITE IMAGE SIGNAL
15	B	GND
16	B	GND
19	G	AUX IMAGE SIGNAL
21	SHIELD	SHIELD
22	SHIELD	SHIELD

36	G	IGNITION
38	SHIELD	SHIELD
39	V	COMM (DISP->DIST)
40	LG	COMM (DIST->DISP)

Connector No.	M259
Connector Name	WIRES TO WIRE
Connector Type	TH32MW-NH

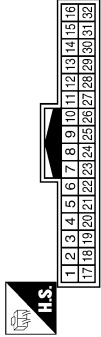

Terminal No.	Color of Wire	Signal Name [Specification]
1	Y	-
3	R	-
4	SHIELD	-
5	LG	-
6	V	-
7	SHIELD	-
8	R	-
9	G	-
10	SHIELD	-
11	W	-
12	G	-

13	L	-
14	R	-
16	G	-
18	V	-
19	L	-
21	LG	-
22	V	-
23	SHIELD	-
24	B	-
25	W	-
26	R	-
27	SHIELD	-
28	G	-
29	R	-
30	SHIELD	-
31	R	-

JCNWM1890GI

AV CONTROL UNIT

[BOSE AUDIO WITHOUT NAVIGATION]

< ECU DIAGNOSIS >

BOSE AUDIO WITHOUT NAVIGATION WITH DVD ENTERTAINMENT SYSTEM

Connector No.	M280
Connector Name	iPod SIDE
Connector Type	IP16FGY

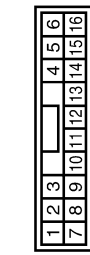

Terminal No.	Color of Wire	Signal Name [Specification]
1	LG	iPod SOUND SIGNAL LH (+)
2	R	iPod SOUND SIGNAL LH (-)
5	R	COMM (iPod->iPod ADAPTER)
6	G	COMM (iPod ADAPTER->iPod)
7	V	iPod SOUND SIGNAL RH (+)
8	Y	iPod SOUND SIGNAL RH (-)
10	SHIELD	GROUND
12	W	CHARGE POWER
14	SHIELD	SHIELD
15	BR	ACCESSORY DETECT
16	R	ACCESSORY IDENTIFY

Connector No.	M303
Connector Name	COMBINATION SWITCH (SPIRAL CABLE)
Connector Type	TK08FGY



Terminal No.	Color of Wire	Signal Name [Specification]
14	-	-
15	-	-
17	-	-

Connector No.	M370
Connector Name	AV CONTROL UNIT (WITH BOSE SYSTEM WITHOUT NAVIGATION SYSTEM)
Connector Type	GT13SC-2/IS-HU



Terminal No.	Color of Wire	Signal Name [Specification]
33	-	FM SUB
34	-	AM-FM MAIN
35	-	ANTENNA AMP. ON SIGNAL

Connector No.	M375
Connector Name	WIRE TO WIRE
Connector Type	GT13SH-2/IS-HU



Terminal No.	Color of Wire	Signal Name [Specification]
1	-	-
2	-	-
3	-	-

Connector No.	M376
Connector Name	WIRE TO WIRE
Connector Type	GT13SCN-2/1PP-HU



Connector No.	M378
Connector Name	ANTENNA BASE (ANTENNA AMP.)
Connector Type	GT13SSN-1/1PP-HU

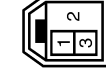

Connector No.	M379
Connector Name	GLASS ANTENNA
Connector Type	GT13SSCN-1/1PP-HU



Connector No.	RT
Connector Name	WIRE TO WIRE
Connector Type	TH16FW-NH

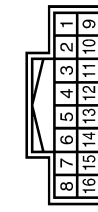

Terminal No.	Color of Wire	Signal Name [Specification]
1	-	-
2	-	-
3	-	-

Terminal No.	Color of Wire	Signal Name [Specification]
1	-	-
3	-	-

Terminal No.	Color of Wire	Signal Name [Specification]
2	-	FM SUB

Terminal No.	Color of Wire	Signal Name [Specification]
1	R/W	-
2	R/L	- [With telephone without navigation system]
3	B	-
4	SHIELD	-

A
B
C
D
E
F
G
H
I
J
K
L
M
N
O
P

AV

JCNWM1891GI

AV CONTROL UNIT

[BOSE AUDIO WITHOUT NAVIGATION]

< ECU DIAGNOSIS >

BOSE AUDIO WITHOUT NAVIGATION WITH DVD ENTERTAINMENT SYSTEM

Connector No.	R20
Connector Name	MICROPHONE
Connector Type	TK04FW



Terminal No.	Color of Wire	Signal Name [Specification]
1	R/W	MICROPHONE SIGNAL (+)
2	R/L	MICROPHONE SIGNAL (-) (BOTH MICROPHONE WITHOUT NAVIGATION SYSTEM)
4	B	MICROPHONE POWER

Connector No.	R152
Connector Name	REAR DISPLAY UNIT
Connector Type	TH02FW-NH

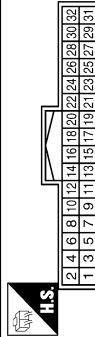

Terminal No.	Color of Wire	Signal Name [Specification]
1	B	GND
2	B	GND
3	Y/R	BATTERY
4	Y/R	BATTERY
5	R	HEADPHONE ON SIGNAL
6	V/Y	ACC
8	SHIELD	SHIELD
9	V	COMM (DISP->DISP)
10	LG	COMM (DISP->DISP)
11	G	IGNITION
12	SHIELD	SHIELD

Connector No.	R153
Connector Name	WIRE TO WIRE
Connector Type	TH02FW-NH

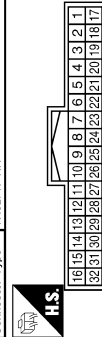

Terminal No.	Color of Wire	Signal Name [Specification]
1	Y/R	-
2	B	-
4	SHIELD	-
5	LG	-
6	V	-
7	SHIELD	-
8	BR	-
9	Y	-
10	SHIELD	-
11	W/L	-
12	Y/G	-

13	Y/L	-
14	BR/L	-
16	G	-
18	V/Y	-
21	LG	-
22	V	-
23	SHIELD	-
24	B	-
25	W	-
26	R	-
27	SHIELD	-
28	G	-
29	R	-
30	SHIELD	-
31	R	-

13	G	COMPOSITE SYNC
14	R	COMPOSITE IMAGE SIGNAL
15	B	RGB AREA (Y/S) SIGNAL
16	SHIELD	GND
17	R	VP
18	W	HP
19	W/L	RGB GND
20	Y/G	RGB (B/BLUE) SIGNAL
21	Y/L	RGB (G/GREEN) SIGNAL
22	BR/L	RGB (R/RED) SIGNAL
23	SHIELD	SHIELD
24	SHIELD	SHIELD
25	LG	HEADPHONE SOUND SIGNAL RH (-)
26	BR	HEADPHONE SOUND SIGNAL LH (-)
27	V	HEADPHONE SOUND SIGNAL RH (+)
28	Y	HEADPHONE SOUND SIGNAL LH (+)

DTC Index

SELF-DIAGNOSIS RESULTS DISPLAY ITEM

DTC	Display item	Refer to
U1000	CAN COMM CIRCUIT [U1000]	AV-89, "Diagnosis Procedure"
U1010	CONTROL UNIT (CAN) [U1010]	AV-90, "Diagnosis Procedure"

JCNWM1892GI

INFOID:000000003457508

AV CONTROL UNIT

< ECU DIAGNOSIS >

[BOSE AUDIO WITHOUT NAVIGATION]

DTC	Display item	Refer to	
U1310	CONTROL UNIT (AV) [U1310]	AV-91, "DTC Logic"	A
U1200	Control Unit FLASH-ROM [U1200]	AV-92, "DTC Logic"	
U1216	CAN CONT [U1216]	AV-93, "DTC Logic"	B
U1243	FRONT DISP CONN [U1243]	AV-94, "Diagnosis Procedure"	
U1247	REAR DISP CONN [U1247]	AV-96, "Diagnosis Procedure"	
U1250	CAMERA CONT CONN [U1250]	AV-98, "Diagnosis Procedure"	C
U1255	SAT CONN [U1255]	AV-99, "Diagnosis Procedure"	
U1300 U1240	<ul style="list-style-type: none"> • AV COMM CIRCUIT [U1300] • SWITCH CONN [U1240] 	AV-101, "Description"	D
U1300 U1246	<ul style="list-style-type: none"> • AV COMM CIRCUIT [U1300] • VIDEO DIST CONN [U1246] 	AV-101, "Description"	E
U1300 U1248	<ul style="list-style-type: none"> • AV COMM CIRCUIT [U1300] • DVD DECK CONN [U1248] 	AV-101, "Description"	E
U1300 U1252	<ul style="list-style-type: none"> • AV COMM CIRCUIT [U1300] • REAR CAMERA LAN CONN [U1252] 	AV-101, "Description"	F
U1300 U1254	<ul style="list-style-type: none"> • AV COMM CIRCUIT [U1300] • IPod CONN [U1254] 	AV-101, "Description"	G
U1300 U1256	<ul style="list-style-type: none"> • AV COMM CIRCUIT [U1300] • HAND FREE CONN [U1256] 	AV-101, "Description"	G
U1300 U1252 U1256*	<ul style="list-style-type: none"> • AV COMM CIRCUIT [U1300] • REAR CAMERA LAN CONN [U1252] • HAND FREE CONN [U1256]* 	AV-101, "Description"	H
U1300 U1248 U1252 U1256	<ul style="list-style-type: none"> • AV COMM CIRCUIT [U1300] • DVD DECK CONN [U1248] • REAR CAMERA LAN CONN [U1252] • HAND FREE CONN [U1256] 	AV-101, "Description"	I
U1300 U1246 U1248 U1252 U1254 U1256	<ul style="list-style-type: none"> • AV COMM CIRCUIT [U1300] • VIDEO DIST CONN [U1246] • DVD DECK CONN [U1248] • REAR CAMERA LAN CONN [U1252] • IPod CONN [U1254] • HAND FREE CONN [U1256] 	AV-101, "Description"	J
U1300 U1246 U1248 U1252 U1256	<ul style="list-style-type: none"> • AV COMM CIRCUIT [U1300] • VIDEO DIST CONN [U1246] • DVD DECK CONN [U1248] • REAR CAMERA LAN CONN [U1252] • HAND FREE CONN [U1256] 	AV-101, "Description"	L
U1300 U1240 U1254* U1256*	<ul style="list-style-type: none"> • AV COMM CIRCUIT [U1300] • SWITCH CONN [U1240] • IPod CONN [U1254]* • HAND FREE CONN [U1256]* 	AV-101, "Description"	M
U1300 U1240 U1246 U1248 U1252 U1254 U1256	<ul style="list-style-type: none"> • AV COMM CIRCUIT [U1300] • SWITCH CONN [U1240] • VIDEO DIST CONN [U1246] • DVD DECK CONN [U1248] • REAR CAMERA LAN CONN [U1252] • IPod CONN [U1254] • HAND FREE CONN [U1256] 	AV-101, "Description"	O
U1300 U1240 U1246 U1248 U1252 U1254 U1256	<ul style="list-style-type: none"> • AV COMM CIRCUIT [U1300] • SWITCH CONN [U1240] • VIDEO DIST CONN [U1246] • DVD DECK CONN [U1248] • REAR CAMERA LAN CONN [U1252] • IPod CONN [U1254] • HAND FREE CONN [U1256] 	AV-101, "Description"	P

NOTE:

*: Non-equipped item is not displayed.

AV

FRONT DISPLAY UNIT

[BOSE AUDIO WITHOUT NAVIGATION]

< ECU DIAGNOSIS >

FRONT DISPLAY UNIT

Reference Values

INFOID:000000003457745

TERMINAL LAYOUT

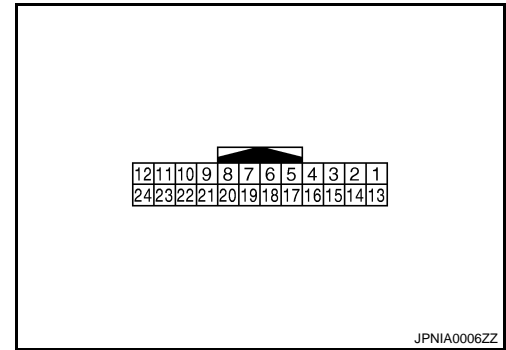

PHYSICAL VALUES

Terminal (Wire color)		Description		Condition		Reference value (Approx.)
+	-	Signal name	Input/ Output			
1 (B)	Ground	Ground	—	Ignition switch ON	—	0 V
2 (Y)	Ground	Inverter VCC	Input	Ignition switch ACC	—	9.0 V
3 (O)	Ground	Signal VCC	Input	Ignition switch ACC	—	9.0 V
4 (P)	Ground	Composite image GND	—	Ignition switch ON	—	0 V
5	—	Shield	—	—	—	—
6 (L)	Ground	RGB signal (G: green)	Input	Ignition switch ON	Start confirmation/adjust- ment mode, and then dis- play color bar by selecting “Color Spectrum Bar” on DISPLAY DIAGNOSIS screen.	<p style="text-align: right;">SKIB2236J</p>
7	—	Shield	—	—	—	—
8 (G)	Ground	Horizontal synchronizing (HP) signal	Output	Ignition switch ON	—	<p style="text-align: right;">SKIB3601E</p>

FRONT DISPLAY UNIT

< ECU DIAGNOSIS >

[BOSE AUDIO WITHOUT NAVIGATION]

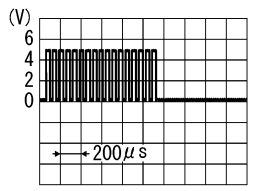
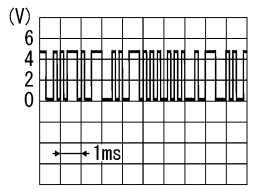
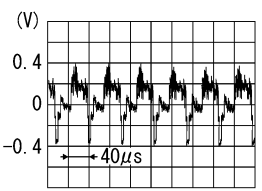
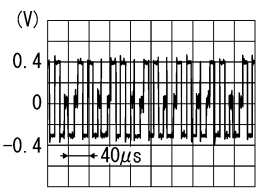
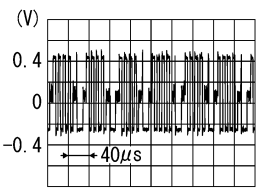
Terminal (Wire color)		Description		Condition	Reference value (Approx.)	
+	-	Signal name	Input/ Output			
9 (W)	Ground	RGB area (YS) signal	Input	Ignition switch ON	When RGB image is displayed	5.0 V
				Ignition switch ON	When AUX image is displayed	 <p style="text-align: right; font-size: small;">PKIB4948J</p>
11 (R)	Ground	Communication signal (CONT→DISP)	Input	Ignition switch ON	When adjusting display brightness.	 <p style="text-align: right; font-size: small;">PKIB5039J</p>
13 (BR)	Ground	Inverter GND	—	Ignition switch ON	—	0 V
14 (LG)	Ground	Signal GND	—	Ignition switch ON	—	0 V
15 (L)	4 (P)	Composite image signal	Input	Ignition switch ON	When AUX image is displayed	 <p style="text-align: right; font-size: small;">SKIB2251J</p>
17 (G)	Ground	RGB signal (R: red)	Input	Ignition switch ON	Start confirmation/adjustment mode, and then display color bar by selecting "Color Spectrum Bar" on DISPLAY DIAGNOSIS screen.	 <p style="text-align: right; font-size: small;">SKIB2238J</p>
18 (Y)	Ground	RGB signal (B: blue)	Input	Ignition switch ON	Start confirmation/adjustment mode, and then display color bar by selecting "Color Spectrum Bar" on DISPLAY DIAGNOSIS screen.	 <p style="text-align: right; font-size: small;">SKIB2237J</p>

A
B
C
D
E
F
G
H
I
J
K
L
M
AV
O
P

FRONT DISPLAY UNIT

< ECU DIAGNOSIS >

[BOSE AUDIO WITHOUT NAVIGATION]

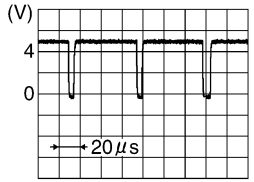
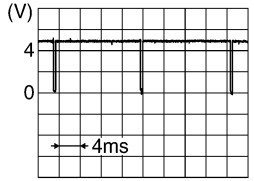
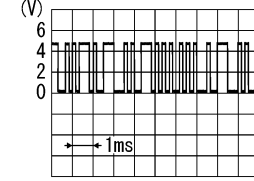
Terminal (Wire color)		Description		Condition		Reference value (Approx.)
+	-	Signal name	Input/ Output			
19 (B)	Ground	RGB synchronizing signal	Input	Ignition switch ON	—	 <p style="text-align: right; font-size: small;">SKIB3603E</p>
20 (R)	Ground	Vertical synchronizing (VP) signal	Output	Ignition switch On	—	 <p style="text-align: right; font-size: small;">SKIB3598E</p>
21	—	Shield	—	—	—	—
22 (G)	Ground	Communication signal (DISP→CONT)	Output	Ignition switch ON	When adjusting display brightness.	 <p style="text-align: right; font-size: small;">PKIB5039J</p>
23	—	Shield	—	—	—	—

Wiring Diagram - BOSE AUDIO WITHOUT NAVIGATION WITHOUT DVD ENTERTAINMENT SYSTEM -

INFOID:000000003702907

NOTE:

- In this section, PRESET SWITCH and MULTIFUNCTION SWITCH are written as the MULTIFUNCTION SWITCH.
- Type A: Up to VIN: JN8AZ18U*9W100000, JN8AZ18W*9W200000 (EXCEPT FOR MEXICO), JN8AZ18U*9W710000, JN8AZ18W*9W810000 (FOR MEXICO)

FRONT DISPLAY UNIT

[BOSE AUDIO WITHOUT NAVIGATION]

< ECU DIAGNOSIS >

- Type B: From VIN: JN8AZ18U*9W10001, JN8AZ18W*9W20001 (EXCEPT FOR MEXICO), JN8AZ18U*9W710001, JN8AZ18W*9W810001 (FOR MEXICO)

BOSE AUDIO WITHOUT NAVIGATION WITHOUT DVD ENTERTAINMENT SYSTEM

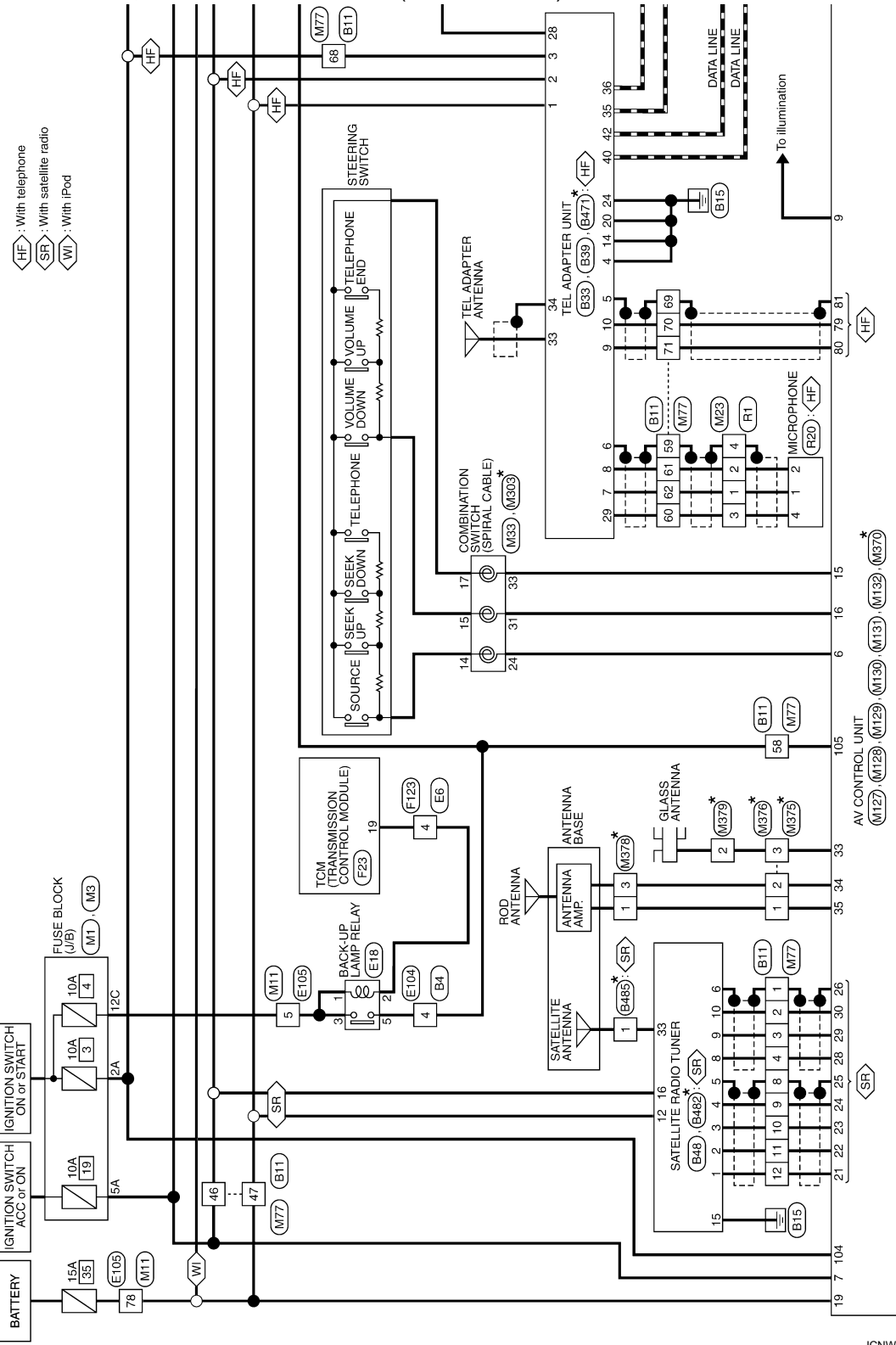

*: This connector is not shown in "Harness Layout".

2008/09/23

JCNWM1855GI

A
B
C
D
E
F
G
H
I
J
K
L
M
N
O
P

AV

FRONT DISPLAY UNIT

[BOSE AUDIO WITHOUT NAVIGATION]

< ECU DIAGNOSIS >

- HF : With telephone
- OF : Without telephone
- WI : With iPod

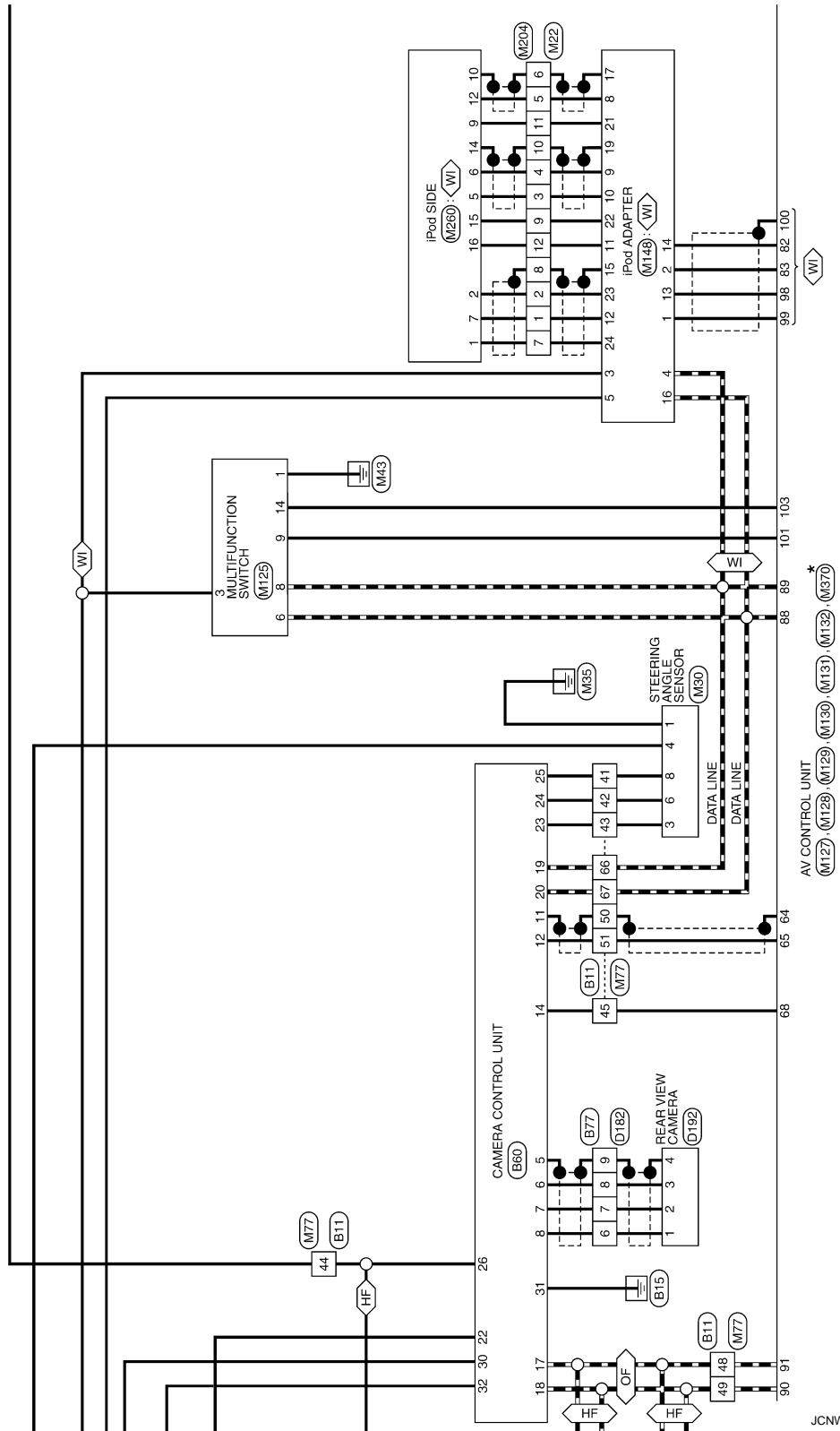

*: This connector is not shown in "Harness Layout".

JCNWM1856GI

FRONT DISPLAY UNIT

[BOSE AUDIO WITHOUT NAVIGATION]

< ECU DIAGNOSIS >

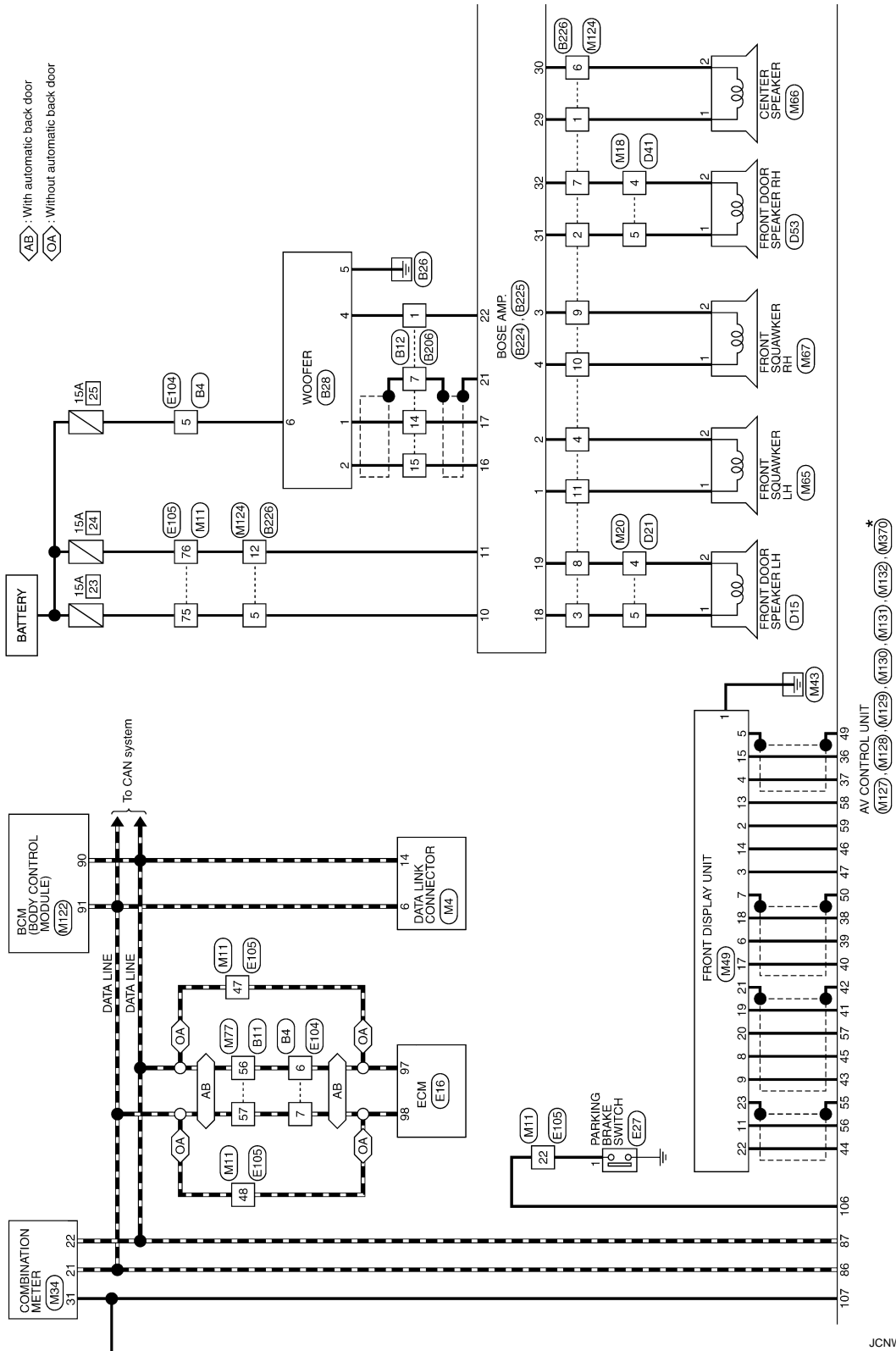

*: This connector is not shown in "Harness Layout".

JCNWM1857GI

A
B
C
D
E
F
G
H
I
J
K
L
M
N
O
P

AV

FRONT DISPLAY UNIT

[BOSE AUDIO WITHOUT NAVIGATION]

< ECU DIAGNOSIS >

TA : Type A
TB : Type B

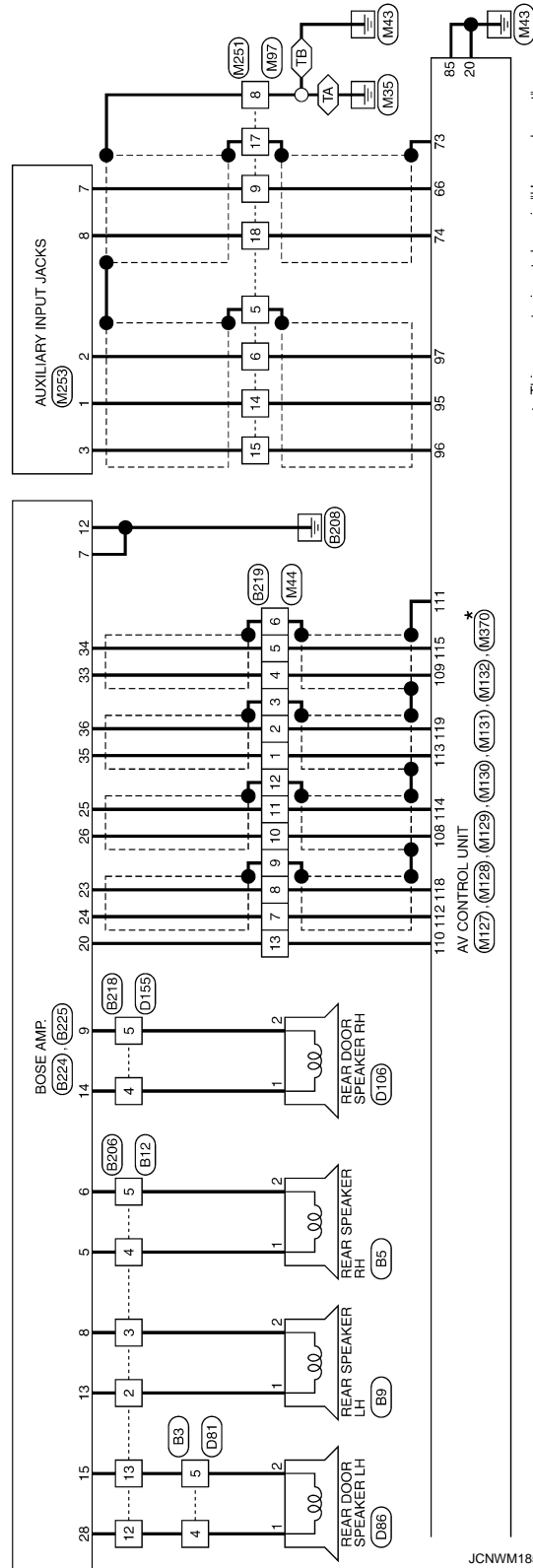

*: This connector is not shown in "Harness Layout".

JCNW118586I



FRONT DISPLAY UNIT

[BOSE AUDIO WITHOUT NAVIGATION]

< ECU DIAGNOSIS >



BOSE AUDIO WITHOUT NAVIGATION WITHOUT DVD ENTERTAINMENT SYSTEM

Connector No.	B3
Connector Name	WIRE TO WIRE
Connector Type	TK0DFW-ANS



Terminal No.	Color of Wire	Signal Name [Specification]
4	LG	-
5	O	-

Connector No.	B4
Connector Name	WIRE TO WIRE
Connector Type	NS16MHW-CS



Terminal No.	Color of Wire	Signal Name [Specification]
4	R	-
5	O	-
6	P	-
7	L	-

Connector No.	B5
Connector Name	REAR SPEAKER RH
Connector Type	TK02FBR



Terminal No.	Color of Wire	Signal Name [Specification]
1	V	-
2	LG	-

Connector No.	B6
Connector Name	REAR SPEAKER LH
Connector Type	TK02FBR



Terminal No.	Color of Wire	Signal Name [Specification]
1	SB	-
2	GR	-

Connector No.	B7
Connector Name	WIRE TO WIRE
Connector Type	NS18FW-CS

Terminal No.	Color of Wire	Signal Name [Specification]
43	G	-
44	BR	-
45	L	-
46	GR	-
47	V	-
48	GR	-(With rear view camera and telephone)
48	BR	-(With rear view camera without telephone)
49	Y	-
50	SHIELD	-
51	B	-
56	P	-
57	L	-
58	R	-
59	SHIELD	-
60	B	-
61	R/L	-
62	R/W	-
66	GR	-
67	G	-
68	R	-
69	SHIELD	-
70	W/R	-
71	B/R	-

Connector No.	B8
Connector Name	WOOFER
Connector Type	RS08FGY-PR

Terminal No.	Color of Wire	Signal Name [Specification]
1	W/R	SOUND SIGNAL WOOFER (-)
2	B/R	SOUND SIGNAL WOOFER (+)
4	W	WOOFER AMP- ON SIGNAL
5	B/W	GND
6	O	BAT

Connector No.	B9
Connector Name	WIRE TO WIRE
Connector Type	TH80MW-CS19

Terminal No.	Color of Wire	Signal Name [Specification]
1	SHIELD	-
2	B	-
3	R/L	-
4	R/W	-
8	SHIELD	-
9	BR/L	-
10	Y/G	-
11	Y/L	-
12	W/L	-
41	O	-
42	SB	-

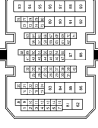
A B C D E F G H I J K L M O P

AV

JCNWM1859GI

FRONT DISPLAY UNIT

[BOSE AUDIO WITHOUT NAVIGATION]

< ECU DIAGNOSIS >

BOSE AUDIO WITHOUT NAVIGATION WITHOUT DVD ENTERTAINMENT SYSTEM

Connector No.	B33
Connector Name	TEL ADAPTER UNIT
Connector Type	TH82FW-NH

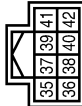

Terminal No.	Color of Wire	Signal Name [Specification]
35	Y	AV COMM (H)
36	BR	AV COMM (L)
40	G	AV COMM (H)
42	GR	AV COMM (L)

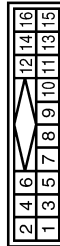

Connector No.	B48
Connector Name	SATELLITE RADIO TUNER
Connector Type	A18FW

Terminal No.	Color of Wire	Signal Name [Specification]
1	W/L	SOUND SIGNAL LH (-)
2	Y/L	SOUND SIGNAL LH (+)
3	Y/G	SOUND SIGNAL RH (-)
4	BR/L	SOUND SIGNAL RH (+)
5	SHIELD	SHIELD
6	SHIELD	SHIELD
8	R/W	REQUEST (SAT->CONT)
9	R/L	COMM (SAT->CONT)
10	B	COMM (CONT->SAT)
12	V	BATTERY
15	B	GND

Connector No.	B39
Connector Name	TEL ADAPTER UNIT
Connector Type	TH32FW-NH

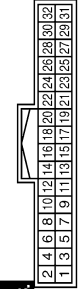

Terminal No.	Color of Wire	Signal Name [Specification]
1	V	BATTERY
2	GR	ACC
3	R	IGNITION
4	B/W	GND
5	SHIELD	SHIELD
6	SHIELD	SHIELD
7	R/W	MICROPHONE SIGNAL
8	R/L	MICROPHONE GND
9	B/R	TEL VOICE SIGNAL (+)
10	W/R	TEL VOICE SIGNAL (-)
14	B	GND

Terminal No.	16
Color of Wire	GR
Signal Name [Specification]	ACC

Terminal No.	20
Color of Wire	B
Signal Name [Specification]	CONTROL SIGNAL
Terminal No.	24
Color of Wire	B/W
Signal Name [Specification]	CONTROL SIGNAL
Terminal No.	28
Color of Wire	BR
Signal Name [Specification]	VEHICLE SPEED (8-PULSE)
Terminal No.	29
Color of Wire	B
Signal Name [Specification]	MICROPHONE VCC

Connector No.	B60
Connector Name	CAMERA CONTROL UNIT
Connector Type	TH32FW-NH

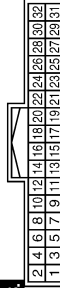

Terminal No.	22
Color of Wire	R
Signal Name [Specification]	REVERSE
Terminal No.	23
Color of Wire	G
Signal Name [Specification]	SENSOR SIGNAL 1
Terminal No.	24
Color of Wire	SB
Signal Name [Specification]	SENSOR SIGNAL 2
Terminal No.	25
Color of Wire	O
Signal Name [Specification]	SENSOR SIGNAL 3
Terminal No.	26
Color of Wire	BR
Signal Name [Specification]	VEHICLE SPEED (8-PULSE)
Terminal No.	30
Color of Wire	GR
Signal Name [Specification]	ACC
Terminal No.	31
Color of Wire	B
Signal Name [Specification]	GND
Terminal No.	32
Color of Wire	V
Signal Name [Specification]	BATTERY

Terminal No.	Color of Wire	Signal Name [Specification]
5	SHIELD	SHIELD
6	B	CAMERA IMAGE SIGNAL
7	R/W	GND
8	R/L	CAMERA ON SIGNAL
11	SHIELD	SHIELD
12	B	CAMERA IMAGE SIGNAL
14	L	CONNECTION RECOGNITION
17	BR	AV COMM (L)
18	Y	AV COMM (H)
19	GR	AV COMM (L)
20	G	AV COMM (H)

FRONT DISPLAY UNIT

[BOSE AUDIO WITHOUT NAVIGATION]

< ECU DIAGNOSIS >

BOSE AUDIO WITHOUT NAVIGATION WITHOUT DVD ENTERTAINMENT SYSTEM

Connector No.	B77
Connector Name	WIRE TO WIRE
Connector Type	TK12MW

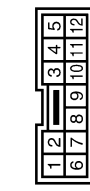

Terminal No.	Color of Wire	Signal Name [Specification]
6	R/L	-
7	R/W	-
8	B	-
9	SHIELD	-

Connector No.	B206
Connector Name	WIRE TO WIRE
Connector Type	NS16MH-CS

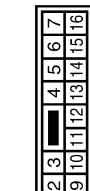

Terminal No.	Color of Wire	Signal Name [Specification]
1	W	-
2	GR	-
3	BR	-
4	Y	-
5	BR	-
7	SHIELD	-
12	G	-
13	R	-
14	W/R	-
15	B/R	-

Connector No.	B218
Connector Name	WIRE TO WIRE
Connector Type	TK16FW-NSB

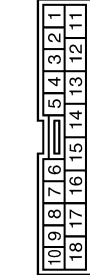

Terminal No.	Color of Wire	Signal Name [Specification]
4	L	- [With BOSE system]
5	O	- [With BOSE system]

Connector No.	B219
Connector Name	WIRE TO WIRE
Connector Type	TH22MW-NH

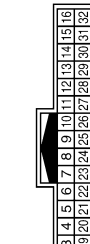

Terminal No.	Color of Wire	Signal Name [Specification]
1	W/R	-
2	B/R	-
3	SHIELD	-
4	W/R	-
5	B/R	-
6	SHIELD	-
7	GR/V	-
8	W/L	-
9	SHIELD	-
10	GR/V	-
11	W/L	-

Terminal No.	12	SHIELD	-
Terminal No.	13	SB	-

Connector No.	B224
Connector Name	BOSE AMP.
Connector Type	SGA12FBR-SJA2

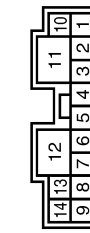

Terminal No.	12	B	GND
Terminal No.	13	GR	SOUND SIGNAL REAR SPEAKER LH (+)
Terminal No.	14	L	SOUND SIGNAL REAR DOOR SPEAKER RH (+)

JCNWM1861GI

A
B
C
D
E
F
G
H
I
J
K
L
M
AV
O
P

FRONT DISPLAY UNIT

[BOSE AUDIO WITHOUT NAVIGATION]

< ECU DIAGNOSIS >

BOSE AUDIO WITHOUT NAVIGATION WITHOUT DVD ENTERTAINMENT SYSTEM

Connector No.	B225
Connector Name	BOSE AMP.
Connector Type	SCA19FBR-SGA4

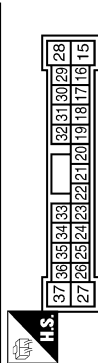

Terminal No.	Color of Wire	Signal Name [Specification]
15	R	SOUND SIGNAL REAR DOOR SPEAKER LH (-)
16	B/R	SOUND SIGNAL REAR DOOR SPEAKER RH (-)
17	W/R	SOUND SIGNAL WOOFER (+)
18	W	SOUND SIGNAL FRONT DOOR SPEAKER LH (+)
19	B	SOUND SIGNAL FRONT DOOR SPEAKER LH (-)
20	SB	AMP ON SIGNAL
21	SHIELD	SHIELD
22	W	WOOFER AMP ON SIGNAL
23	W/L	SOUND SIGNAL REAR LH (-)
24	GR/V	SOUND SIGNAL REAR LH (+)
25	W/L	SOUND SIGNAL REAR RH (-)

Connector No.	B471
Connector Name	TEL ADAPTER UNIT
Connector Type	GT16C-IS-HU

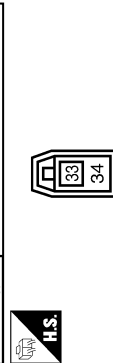

Terminal No.	Color of Wire	Signal Name [Specification]
33	-	TEL ANTENNA SHIELD
34	SHIELD	SHIELD

26	GR/V	SOUND SIGNAL REAR RH (+)
28	G	SOUND SIGNAL REAR DOOR SPEAKER LH (+)
29	V	SOUND SIGNAL CENTER SPEAKER (+)
30	P	SOUND SIGNAL CENTER SPEAKER (-)
31	BR	SOUND SIGNAL FRONT DOOR SPEAKER RH (+)
32	Y	SOUND SIGNAL FRONT DOOR SPEAKER RH (-)
33	W/R	SOUND SIGNAL FRONT RH (+)
34	B/R	SOUND SIGNAL FRONT LH (-)
35	W/R	SOUND SIGNAL FRONT LH (+)
36	B/R	SOUND SIGNAL FRONT LH (-)

Terminal No.	Color of Wire	Signal Name [Specification]
1	V	-
2	BR	-
3	W	-
4	V	-
5	SB	-
6	P	-
7	Y	-
8	B	-
9	L	-
10	P	-
11	LG	-
12	-	-

Connector No.	B482
Connector Name	SATELLITE RADIO TUNER
Connector Type	FAKRA



Terminal No.	Color of Wire	Signal Name [Specification]
33	-	SATELLITE ANTENNA
34	-	SATELLITE ANTENNA

Connector No.	B326
Connector Name	WIRE TO WIRE
Connector Type	NS12MR-CS

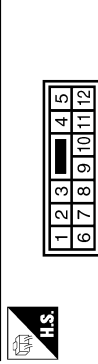

Connector No.	B485
Connector Name	ANTENNA BASE (SATELLITE ANTENNA) (WITH BOSE SYSTEM WITHOUT NAVIGATION SYSTEM)
Connector Type	GT16C-1PP-HU

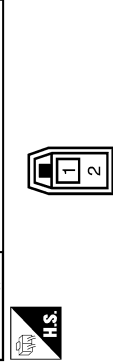

Terminal No.	Color of Wire	Signal Name [Specification]
1	-	SATELLITE ANTENNA
2	-	SATELLITE ANTENNA

12	GR	-
----	----	---

Connector No.	DI5
Connector Name	FRONT DOOR SPEAKER LH (WITH BOSE SYSTEM)
Connector Type	NS02FBR-CS

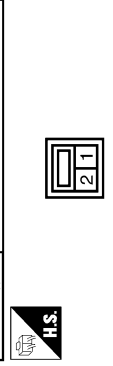

Terminal No.	Color of Wire	Signal Name [Specification]
1	L	-[Type A]
1	W	-[Type B]
2	B/W	-[Type A]
2	B	-[Type B]

JCNWM1862GI

BOSE AUDIO WITHOUT NAVIGATION WITHOUT DVD ENTERTAINMENT SYSTEM

Connector No.	D81
Connector Name	WIRE TO WIRE
Connector Type	TK10MW-NS8



Terminal No.	Color of Wire	Signal Name [Specification]
4	L	-
5	W	-

Connector No.	D53
Connector Name	FRONT DOOR SPEAKER RH (WITH BOSE SYSTEM)
Connector Type	NS2ZFBF-CS



Terminal No.	Color of Wire	Signal Name [Specification]
1	BR	-[Type A]
2	W	-[Type B]

Connector No.	D41
Connector Name	WIRE TO WIRE
Connector Type	TH4QFW-CS15

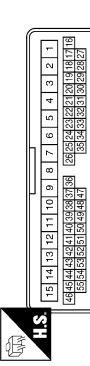

Terminal No.	Color of Wire	Signal Name [Specification]
4	B/R	-[Type A]
4	B	-[Type B]
5	BR	-[Type A]
5	W	-[Type B]

Connector No.	D21
Connector Name	WIRE TO WIRE
Connector Type	TH4QFW-CS15

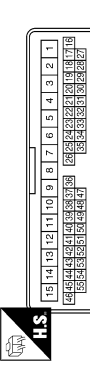

Terminal No.	Color of Wire	Signal Name [Specification]
4	B/W	-[Type A]
4	B	-[Type B]
5	L	-[Type A]
5	W	-[Type B]

Connector No.	D182
Connector Name	WIRE TO WIRE
Connector Type	TK12FW

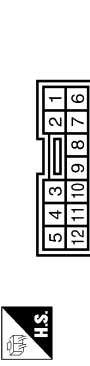

Terminal No.	Color of Wire	Signal Name [Specification]
6	R	-
7	G	-
8	B	-
9	SHIELD	-

Connector No.	D155
Connector Name	WIRE TO WIRE
Connector Type	TK10MW-NS8



Terminal No.	Color of Wire	Signal Name [Specification]
4	O	-[Type A]
4	L	-[Type B]
5	B/P	-[Type A]
5	W	-[Type B]

Connector No.	D108
Connector Name	REAR DOOR SPEAKER RH (WITH BOSE SYSTEM)
Connector Type	NS2ZFBF-CS



Terminal No.	Color of Wire	Signal Name [Specification]
1	O	-[Type A]
1	L	-[Type B]
2	B/P	-[Type A]
2	W	-[Type B]

Connector No.	D86
Connector Name	REAR DOOR SPEAKER LH (WITH BOSE SYSTEM)
Connector Type	NS2ZFBF-CS



Terminal No.	Color of Wire	Signal Name [Specification]
1	L	-
2	W	-

JCNWM1863GI

A
B
C
D
E
F
G
H
I
J
K
L
M
AV
O
P

FRONT DISPLAY UNIT

[BOSE AUDIO WITHOUT NAVIGATION]

< ECU DIAGNOSIS >

BOSE AUDIO WITHOUT NAVIGATION WITHOUT DVD ENTERTAINMENT SYSTEM

Connector No.	D192
Connector Name	REAR VIEW CAMERA
Connector Type	TH70MW-NH



Terminal No.	Color of Wire	Signal Name [Specification]
1	R	CAMERA ON SIGNAL
2	G	GND
3	B	CAMERA IMAGE SIGNAL
4	SHIELD	SHIELD

Connector No.	E6
Connector Name	WIRE TO WIRE
Connector Type	TK18MGY-TV

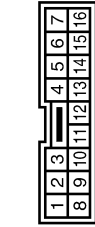

Terminal No.	Color of Wire	Signal Name [Specification]
4	R	-

Connector No.	E16
Connector Name	ECM
Connector Type	RH424FB-R28-L-LH

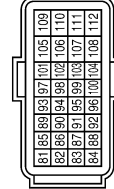

Terminal No.	Color of Wire	Signal Name [Specification]
97	P	VEHCAN-L
98	L	VEHCAN-H

Connector No.	E18
Connector Name	BACK-UP LAMP RELAY
Connector Type	MS02FL-M2-LC

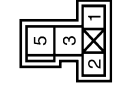

Terminal No.	Color of Wire	Signal Name [Specification]
1	LG	-
2	R	-
3	LG	-
5	R	-

Connector No.	E27
Connector Name	PARKING BRAKE SWITCH
Connector Type	P01FE-A



Terminal No.	Color of Wire	Signal Name [Specification]
1	P	-

Connector No.	E104
Connector Name	WIRE TO WIRE
Connector Type	NS16FW-CS

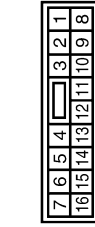

Terminal No.	Color of Wire	Signal Name [Specification]
4	R	-
5	L	-
6	P	-
7	L	-

Connector No.	E105
Connector Name	WIRE TO WIRE
Connector Type	TH70MW-CS10-M3

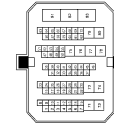

Terminal No.	Color of Wire	Signal Name [Specification]
5	LG	-
22	P	-
47	P	-
48	L	-
75	BR	-
76	GR	-
78	V	-

Connector No.	F23
Connector Name	TOM (TRANSMISSION CONTROL MODULE)
Connector Type	RH40FB-R28-L-RH

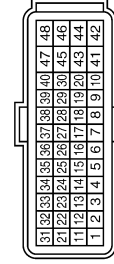

Terminal No.	Color of Wire	Signal Name [Specification]
19	G/B	REV LAMP RELAY

JCNWM1864GI

FRONT DISPLAY UNIT

[BOSE AUDIO WITHOUT NAVIGATION]

< ECU DIAGNOSIS >

BOSE AUDIO WITHOUT NAVIGATION WITHOUT DVD ENTERTAINMENT SYSTEM

Connector No.	F123	Connector No.	M1	Connector No.	M3	Connector No.	M4
Connector Name	WIRE TO WIRE	Connector Name	FUSE BLOCK (J/B)	Connector Name	FUSE BLOCK (J/B)	Connector Name	DATA LINK CONNECTOR
Connector Type	TK18FY-TV	Connector Type	NSGFP-M2	Connector Type	NS12FW-CS	Connector Type	BD18FW

Terminal No.	7	8	9	10	11	12	13	14	15	16
Color of Wire	G/B									
Signal Name [Specification]										

Terminal No.	2A	5A
Color of Wire	G	R
Signal Name [Specification]		

Terminal No.	12C
Color of Wire	O
Signal Name [Specification]	

Terminal No.	6	14
Color of Wire	L	P
Signal Name [Specification]		

Connector No.	M18	Connector No.	M20
Connector Name	WIRE TO WIRE	Connector Name	WIRE TO WIRE
Connector Type	TH40MW-CS15	Connector Type	TH40MW-CS15

Terminal No.	1	2	3	4	5	6	7	8	9	10	11	12	13	14	15
Color of Wire	W														
Signal Name [Specification]															

Terminal No.	4	5
Color of Wire	W	B
Signal Name [Specification]		

Terminal No.	4	5
Color of Wire	B	L
Signal Name [Specification]		

JCNWM1865GI

A
B
C
D
E
F
G
H
I
J
K
L
M
AV
O
P

FRONT DISPLAY UNIT

[BOSE AUDIO WITHOUT NAVIGATION]

< ECU DIAGNOSIS >

BOSE AUDIO WITHOUT NAVIGATION WITHOUT DVD ENTERTAINMENT SYSTEM

Connector No.	M22
Connector Name	WIRE TO WIRE
Connector Type	TH12FW-NH

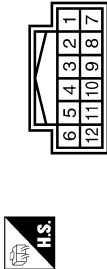

Terminal No.	Color of Wire	Signal Name [Specification]
1	V	-
2	R	-
3	R	-
4	G	-
5	W	-
6	SHIELD	-
7	LG	-
8	SHIELD	-
9	BR	-
10	SHIELD	-
11	L	-

Connector No.	M33
Connector Name	COMBINATION SWITCH (SPIRAL CABLE)
Connector Type	TK08FGY-TV

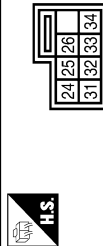

Terminal No.	Color of Wire	Signal Name [Specification]
24	BR	- [With audio steering switch and telephone]
31	G	- [With audio steering switch and telephone]
33	L	- [With audio steering switch and telephone]

12	R	-
----	---	---

Connector No.	M23
Connector Name	WIRE TO WIRE
Connector Type	TH16MW-NH

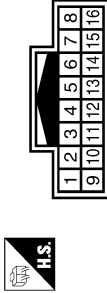

Terminal No.	Color of Wire	Signal Name [Specification]
1	W	-
2	R	- [With telephone without navigation system]
3	B	-
4	SHIELD	-

Connector No.	M44
Connector Name	WIRE TO WIRE
Connector Type	TH32FW-NH

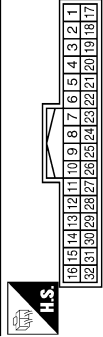

Terminal No.	Color of Wire	Signal Name [Specification]
1	G	-
2	R	-
3	SHIELD	-
4	B	-
5	W	-
6	SHIELD	-
7	L	- [Type A]
7	L	- [Type B]
8	SB	- [Type A]
8	R	- [Type B]
9	SHIELD	-

Connector No.	M30
Connector Name	STEERING ANGLE SENSOR
Connector Type	TH08FW-NH



Terminal No.	Color of Wire	Signal Name [Specification]
1	B	-
3	L	-
4	G	-
6	SB	-
8	O	-

Terminal No.	10	V
Terminal No.	11	LG
Terminal No.	12	SHIELD
Terminal No.	13	P

JCNWM1866GI

FRONT DISPLAY UNIT

[BOSE AUDIO WITHOUT NAVIGATION]

< ECU DIAGNOSIS >

BOSE AUDIO WITHOUT NAVIGATION WITHOUT DVD ENTERTAINMENT SYSTEM

Connector No.	M4B
Connector Name	FRONT DISPLAY UNIT
Connector Type	TH24FW-NH

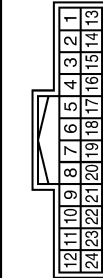

Terminal No.	Color of Wire	Signal Name [Specification]
1	B	GND
2	Y	INVERTER VCC[Without navigation system]
3	O	SIGNAL VCC[Without navigation system]
4	P	COMPOSITE IMAGE CHN[Without navigation system]
5	SHIELD	SHIELD[Without navigation system]
6	SHIELD	SHIELD[Without navigation system]
7	G	RGB (GREEN) SIGNAL[Without navigation system]
8	G	HP[Without navigation system]
9	W	RGB AREA (YS) SIGNAL
11	R	COMM (CONT->DISP)
13	BR	INVERTER GND[Without navigation system]

Connector No.	M67
Connector Name	FRONT SQUAWKER RH
Connector Type	TK02FBR



Terminal No.	Color of Wire	Signal Name [Specification]
1	BR	WIRE TO WIRE
2	R	SHIELD

14	LG	SIGNAL GND[Without navigation system]
15	L	COMPOSITE IMAGE SIGNAL[Without navigation system]
17	G	RGB (RED) SIGNAL
18	Y	RGB (BLUE) SIGNAL[Without navigation system]
19	B	RGB SYNC
20	R	VP
21	SHIELD	SHIELD
22	G	COMM (DISP->CONT)
23	SHIELD	SHIELD

Terminal No.	Color of Wire	Signal Name [Specification]
1	LG	Signal Name [Specification] -[With BOSE system]
2	Y	Signal Name [Specification] -[With BOSE system]

Connector No.	M77
Connector Name	WIRE TO WIRE
Connector Type	TH80FW-CS19

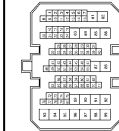

Terminal No.	Color of Wire	Signal Name [Specification]
1	SHIELD	Signal Name [Specification]
2	B	Signal Name [Specification]
3	W	Signal Name [Specification]
4	R	Signal Name [Specification]
8	SHIELD	Signal Name [Specification]
9	W	Signal Name [Specification]
10	R	Signal Name [Specification]
11	G	Signal Name [Specification]
12	B	Signal Name [Specification]
14	O	Signal Name [Specification]
42	SB	Signal Name [Specification]

Connector No.	M65
Connector Name	FRONT SQUAWKER LH
Connector Type	TK02FBR



Terminal No.	Color of Wire	Signal Name [Specification]
1	LG	Signal Name [Specification] -[With BOSE system]
2	Y	Signal Name [Specification] -[With BOSE system]

Connector No.	M97
Connector Name	WIRE TO WIRE
Connector Type	TH18FW-CS2

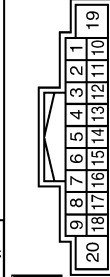

Terminal No.	Color of Wire	Signal Name [Specification]
5	SHIELD	Signal Name [Specification]
6	W	Signal Name [Specification]
8	B	Signal Name [Specification]
9	Y	Signal Name [Specification]
14	R	Signal Name [Specification]
15	B	Signal Name [Specification]
17	SHIELD	Signal Name [Specification]
18	B	Signal Name [Specification] -[Type A and With navigation system type B]
18	BR	Signal Name [Specification] -[Without navigation system type B]

A B C D E F G H I J K L M N O P

AV

FRONT DISPLAY UNIT

[BOSE AUDIO WITHOUT NAVIGATION]

< ECU DIAGNOSIS >

BOSE AUDIO WITHOUT NAVIGATION WITHOUT DVD ENTERTAINMENT SYSTEM

Connector No.	M122
Connector Name	BCM BODY CONTROL MODULE
Connector Type	TH40FB-NH

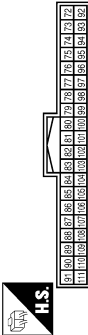

Terminal No.	Color of Wire	Signal Name [Specification]
90	P	CAN-L
91	L	CAN-H

Connector No.	M124
Connector Name	WIRE TO WIRE
Connector Type	NS12FBR-CS



Terminal No.	Color of Wire	Signal Name [Specification]
1	P	-
2	BR	- [Type A]
3	B	- [Type B]
4	Y	-
5	BR	-
6	O	-
7	W	-
8	B	-
9	R	-
10	BR	-

Connector No.	M125
Connector Name	MULTIFUNCTION SWITCH
Connector Type	TH16FW-NH

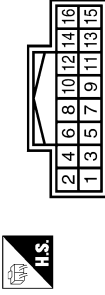

Terminal No.	Color of Wire	Signal Name [Specification]
1	B	GND
3	R	ACC
6	R	AV COMM (H)
8	L	AV COMM (L)
9	V	SW GND
14	W	EJECT SIGNAL

Connector No.	M127
Connector Name	AV CONTROL UNIT (WITH BOSE SYSTEM WITHOUT NAVIGATION SYSTEM)
Connector Type	TH18FW-CS2

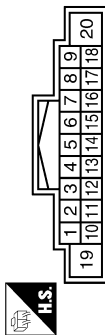

Terminal No.	Color of Wire	Signal Name [Specification]
6	BR	STRG SW A
7	R	ACC
9	R	ILLUMINATION
15	L	STRG SW GND
16	G	STRG SW B
19	Y	BATTERY
20	B	GND

Connector No.	M128
Connector Name	AV CONTROL UNIT (WITH BOSE SYSTEM WITHOUT NAVIGATION SYSTEM)
Connector Type	A12FW

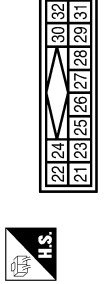

Terminal No.	Color of Wire	Signal Name [Specification]
21	B	SATELLITE RADIO SOUND SIGNAL LH (-)
22	G	SATELLITE RADIO SOUND SIGNAL LH (+)
23	R	SATELLITE RADIO SOUND SIGNAL RH (-)
24	W	SATELLITE RADIO SOUND SIGNAL RH (+)
25	SHIELD	SHIELD
26	SHIELD	SHIELD
28	R	REQUEST (SAT->CONT)
29	W	COMM (SAT->CONT)
30	B	COMM (CONT->SAT)

Connector No.	M129
Connector Name	AV CONTROL UNIT (WITH BOSE SYSTEM WITHOUT NAVIGATION SYSTEM)
Connector Type	TH24FW-NH

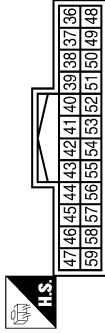

Terminal No.	Color of Wire	Signal Name [Specification]
36	L	COMPOSITE IMAGE SIGNAL
37	P	COMPOSITE IMAGE GND
38	Y	RGB (B/BLUE) SIGNAL
39	L	RGB (G/GREEN) SIGNAL
40	G	RGB (R/RED) SIGNAL
41	B	RGB SYNC
42	SHIELD	SHIELD
43	W	RGB AREA (YS) SIGNAL
44	G	COMM (DISP->CONT)
45	G	HP
46	LG	SIGNAL GND

JCNWM1868G1

FRONT DISPLAY UNIT

[BOSE AUDIO WITHOUT NAVIGATION]

< ECU DIAGNOSIS >

BOSE AUDIO WITHOUT NAVIGATION WITHOUT DVD ENTERTAINMENT SYSTEM

Connector No.	M130
Connector Name	AV CONTROL UNIT (WITH BOSE SYSTEM WITHOUT NAVIGATION SYSTEM)
Connector Type	TH116FW-NH



67	66	65	64	63	62	61	60
75	74	73	72	71	70	69	68

Terminal No.	Color of Wire	Signal Name [Specification]
64	SHIELD	SHIELD
65	W	CAMERA IMAGE SIGNAL
66	Y	AUX IMAGE SIGNAL (Without DVD player)
68	P	CONNECTION RECOGNITION
72	SHIELD	SHIELD (Without DVD player)
74	B	AUX IMAGE GND (Without DVD player (Type A))
74	BR	AUX IMAGE GND (Without DVD player (Type B))

Connector No.	M132
Connector Name	AV CONTROL UNIT (WITH BOSE SYSTEM WITHOUT NAVIGATION SYSTEM)
Connector Type	TH12FW-NH



114	115	116	117	118	119
108	109	110	111	112	113

Terminal No.	Color of Wire	Signal Name [Specification]
108	V	SOUND SIGNAL REAR RH (+)
109	B	SOUND SIGNAL FRONT RH (+)
110	P	AMP. ON SIGNAL
111	SHIELD	SHIELD
112	O	SOUND SIGNAL REAR LH (+) (Type A)
112	L	SOUND SIGNAL REAR LH (+) (Type B)
113	G	SOUND SIGNAL FRONT LH (+)
114	LG	SOUND SIGNAL REAR RH (-)
115	W	SOUND SIGNAL FRONT RH (-)
118	SB	SOUND SIGNAL REAR LH (-) (Type A)
118	R	SOUND SIGNAL REAR LH (-) (Type B)

Connector No.	M131
Connector Name	AV CONTROL UNIT (WITH BOSE SYSTEM WITHOUT NAVIGATION SYSTEM)
Connector Type	TH32FW-NH



91	90	89	88	87	86	85	84	83	82	81	80	79	78	77	76
107	106	105	104	103	102	101	100	99	98	97	96	95	94	93	92

Terminal No.	Color of Wire	Signal Name [Specification]
79	L	TEL VOICE SIGNAL (-)
80	R	TEL VOICE SIGNAL (+)
81	SHIELD	SHIELD
82	W	iPod SOUND SIGNAL RH (-) (Without DVD player)
83	R	iPod SOUND SIGNAL RH (+) (Without DVD player)
85	B	GND
86	L	CAN-H
87	P	CAN-L
88	R	AV COMM (H)
88	L	AV COMM (L)
90	G	AV COMM (H)

Terminal No.	119	R	SOUND SIGNAL FRONT LH (-)
--------------	-----	---	---------------------------

91	L	AV COMM (L)
95	R	AUX SOUND SIGNAL RH (+)
96	B	AUX SOUND SIGNAL LH (-)
97	W	AUX SOUND SIGNAL GND
98	L	iPod SOUND SIGNAL LH (-) (Without DVD player)
99	BR	iPod SOUND SIGNAL LH (+) (Without DVD player)
100	SHIELD	SHIELD (Without DVD player)
101	V	SW GND
103	W	EJECT SIGNAL
104	G	IGNITION
105	SB	REVERSE
106	G	PARKING BRAKE
107	V	VEHICLE SPEED (8-PULSE)

Connector No.	M148
Connector Name	iPod ADAPTER
Connector Type	TH24FW-NH



1	2	3	4	5	6	7	8	9	10	11	12
13	14	15	16	17	18	19	20	21	22	23	24

Terminal No.	Color of Wire	Signal Name [Specification]
1	BR	iPod SOUND SIGNAL LH (+)
2	R	iPod SOUND SIGNAL RH (+)
3	R	ACC
4	L	AV COMM (L)
5	Y	BATTERY
8	W	CHARGE POWER
9	G	COMM (iPod ADAPTER->iPod)
10	R	COMM (iPod->iPod ADAPTER)
11	R	ACCESSORY IDENTIFY
12	V	iPod SOUND SIGNAL RH (+)
13	L	iPod SOUND SIGNAL LH (-)

14	W	iPod SOUND SIGNAL RH (-)
15	SHIELD	SHIELD
16	R	AV COMM (H)
17	SHIELD	GND
19	SHIELD	SHIELD
21	L	iPod CONNECTION RECOGNITION
22	BR	ACCESSORY DETECT
23	R	iPod SOUND SIGNAL GND
24	LG	iPod SOUND SIGNAL LH (+)

A
B
C
D
E
F
G
H
I
J
K
L
M
N
O
P

AV

FRONT DISPLAY UNIT

[BOSE AUDIO WITHOUT NAVIGATION]

< ECU DIAGNOSIS >

BOSE AUDIO WITHOUT NAVIGATION WITHOUT DVD ENTERTAINMENT SYSTEM

Connector No.	M204
Connector Name	WIRE TO WIRE
Connector Type	TH12MW-NH

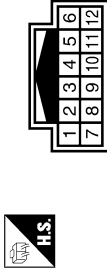

Terminal No.	Color of Wire	Signal Name [Specification]
1	V	-
2	R	-
3	R	-
4	G	-
5	W	-
6	SHIELD	-
7	LG	-
8	SHIELD	-
9	BR	-
10	SHIELD	-
11	L	-

Connector No.	M260
Connector Name	iPod SIDE
Connector Type	IP10F3GY

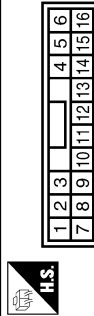

Terminal No.	Color of Wire	Signal Name [Specification]
1	LG	iPod SOUND SIGNAL LH (+)
2	R	iPod SOUND SIGNAL GND
5	R	COMM (iPod->iPod ADAPTER)
6	G	COMM (iPod ADAPTER->iPod)
7	V	iPod SOUND SIGNAL RH (+)
9	L	iPod CONNECTION RECOGNITION GND
10	SHIELD	CHARGE POWER
12	W	SHIELD
14	SHIELD	ACCESSORY DETECT
15	BR	ACCESSORY IDENTIFY
16	R	ACCESSORY IDENTIFY

Connector No.	M251
Connector Name	WIRE TO WIRE
Connector Type	TH18MW-CSZ

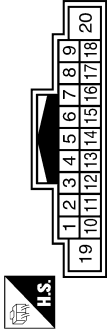

Terminal No.	Color of Wire	Signal Name [Specification]
5	SHIELD	-
6	W	-
8	SHIELD	-
9	G	-
14	R	-
15	B	-
17	SHIELD	-
18	R	-

Connector No.	M370
Connector Name	AV CONTROL UNIT (WITH BOSE SYSTEM WITHOUT NAVIGATION SYSTEM)
Connector Type	GT13SH-2/1S-HU



Terminal No.	Color of Wire	Signal Name [Specification]
33	-	FM SUB
34	-	AM-FM MAIN
35	-	ANTENNA AMP. ON SIGNAL

Connector No.	M253
Connector Name	AUXILIARY INPUT JACKS
Connector Type	A08FW

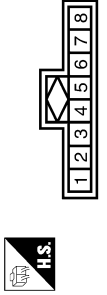

Terminal No.	Color of Wire	Signal Name [Specification]
1	R	SOUND SIGNAL RH (+)
2	W	SOUND SIGNAL GND
3	B	SOUND SIGNAL LH (-) [Without DVD player]
7	G	AUX IMAGE SIGNAL
8	R	AUX IMAGE GND [Without DVD player]

Connector No.	M275
Connector Name	WIRE TO WIRE
Connector Type	GT13SH-2/1S-HU



Terminal No.	Color of Wire	Signal Name [Specification]
1	-	-
2	-	-
3	-	-

JCNWM1870GI

FRONT DISPLAY UNIT

[BOSE AUDIO WITHOUT NAVIGATION]

< ECU DIAGNOSIS >

BOSE AUDIO WITHOUT NAVIGATION WITHOUT DVD ENTERTAINMENT SYSTEM

Connector No.	M376	Connector No.	M378	Connector No.	M379	Connector No.	RT
Connector Name	WIRE TO WIRE	Connector Name	ANTENNA BASE (ANTENNA AMP.)	Connector Name	GLASS ANTENNA	Connector Name	WIRE TO WIRE
Connector Type	GT13SCH-2/1PP-HU	Connector Type	GT13SCH-1/1PP-HU	Connector Type	GT13SCH-1/1PP-HU	Connector Type	TH18FW-NH

Terminal No.	1	2	3	Terminal No.	1	2	3	4
Color of Wire	-	-	-	Color of Wire	-	-	R/W	R/L
Signal Name [Specification]	-	-	-	Signal Name [Specification]	-	-	B	- [With telephone without navigation system]
							SHIELD	-

Terminal No.	1	2	3	Terminal No.	1	2	3	4
Color of Wire	-	-	-	Color of Wire	-	-	-	-
Signal Name [Specification]	-	-	-	Signal Name [Specification]	-	-	FM SUB	-

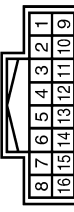

Connector No.	R20
Connector Name	MICROPHONE
Connector Type	TK04FW

Terminal No.	1	2	4
Color of Wire	-	-	B
Signal Name [Specification]	MICROPHONE SIGNAL (+)		
	MICROPHONE SIGNAL (-) (Only telephone without navigation system)		
	MICROPHONE POWER		



Wiring Diagram - BOSE AUDIO WITHOUT NAVIGATION WITH DVD ENTERTAINMENT SYSTEM -

NOTE:

JCNWM1871G1

INFOID:000000003702908

A
B
C
D
E
F
G
H
I
J
K
L
M
AV
O
P

FRONT DISPLAY UNIT

[BOSE AUDIO WITHOUT NAVIGATION]

< ECU DIAGNOSIS >

In this section, PRESET SWITCH and MULTIFUNCTION SWITCH are written as the MULTIFUNCTION SWITCH.

BOSE AUDIO WITHOUT NAVIGATION WITH DVD ENTERTAINMENT SYSTEM

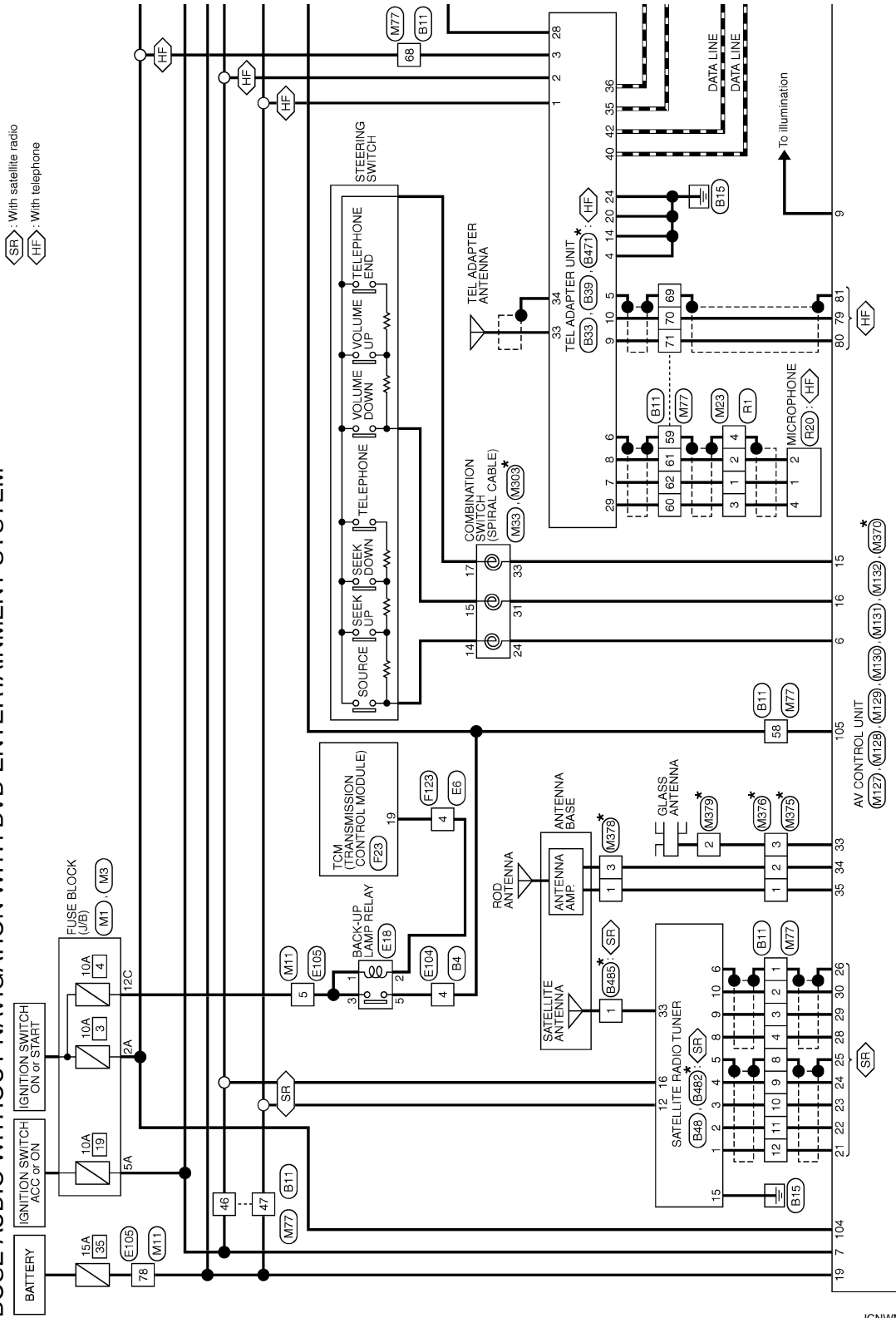

*: This connector is not shown in "Harness Layout".

2008/09/23

JCNWM1872GI

FRONT DISPLAY UNIT

[BOSE AUDIO WITHOUT NAVIGATION]

< ECU DIAGNOSIS >

- WI: With iPod
- HF: With telephone
- OF: Without telephone

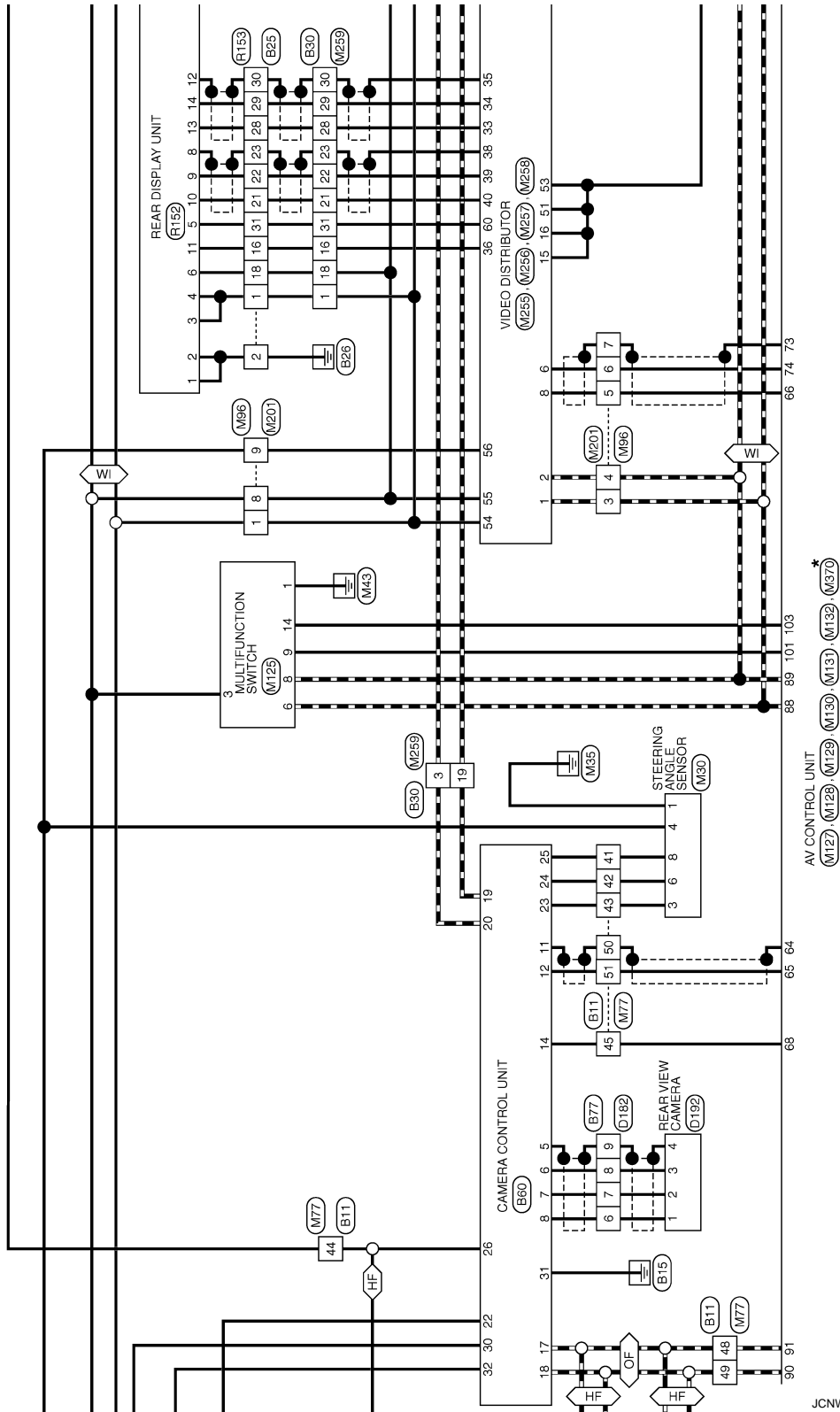

*: This connector is not shown in "Harness Layout".

- A
- B
- C
- D
- E
- F
- G
- H
- I
- J
- K
- L
- M
- AV
- O
- P

FRONT DISPLAY UNIT

[BOSE AUDIO WITHOUT NAVIGATION]

< ECU DIAGNOSIS >

WI: With iPod

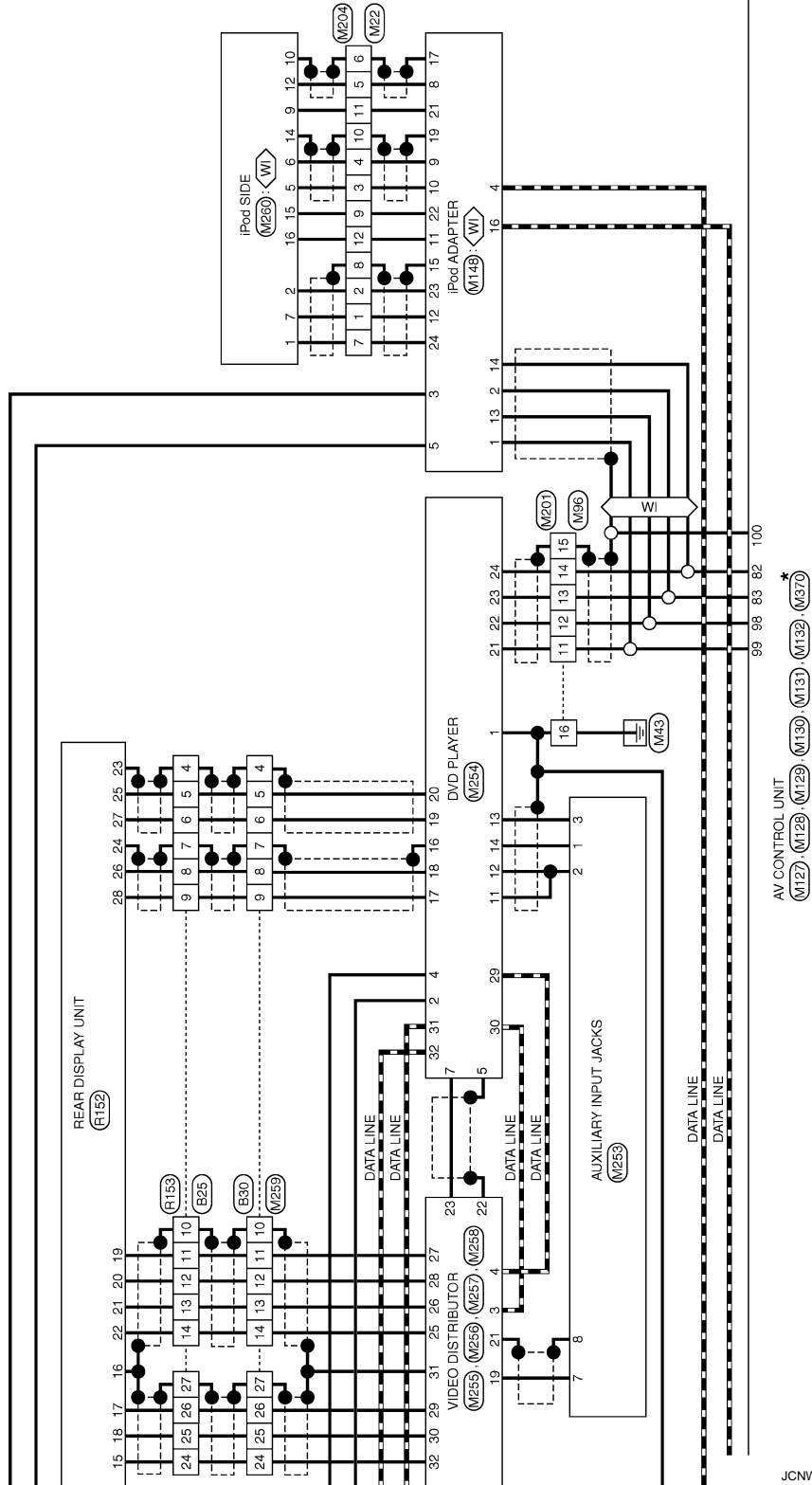

JCNWM1874GI

*: This connector is not shown in "Harness Layout".

FRONT DISPLAY UNIT

[BOSE AUDIO WITHOUT NAVIGATION]

< ECU DIAGNOSIS >

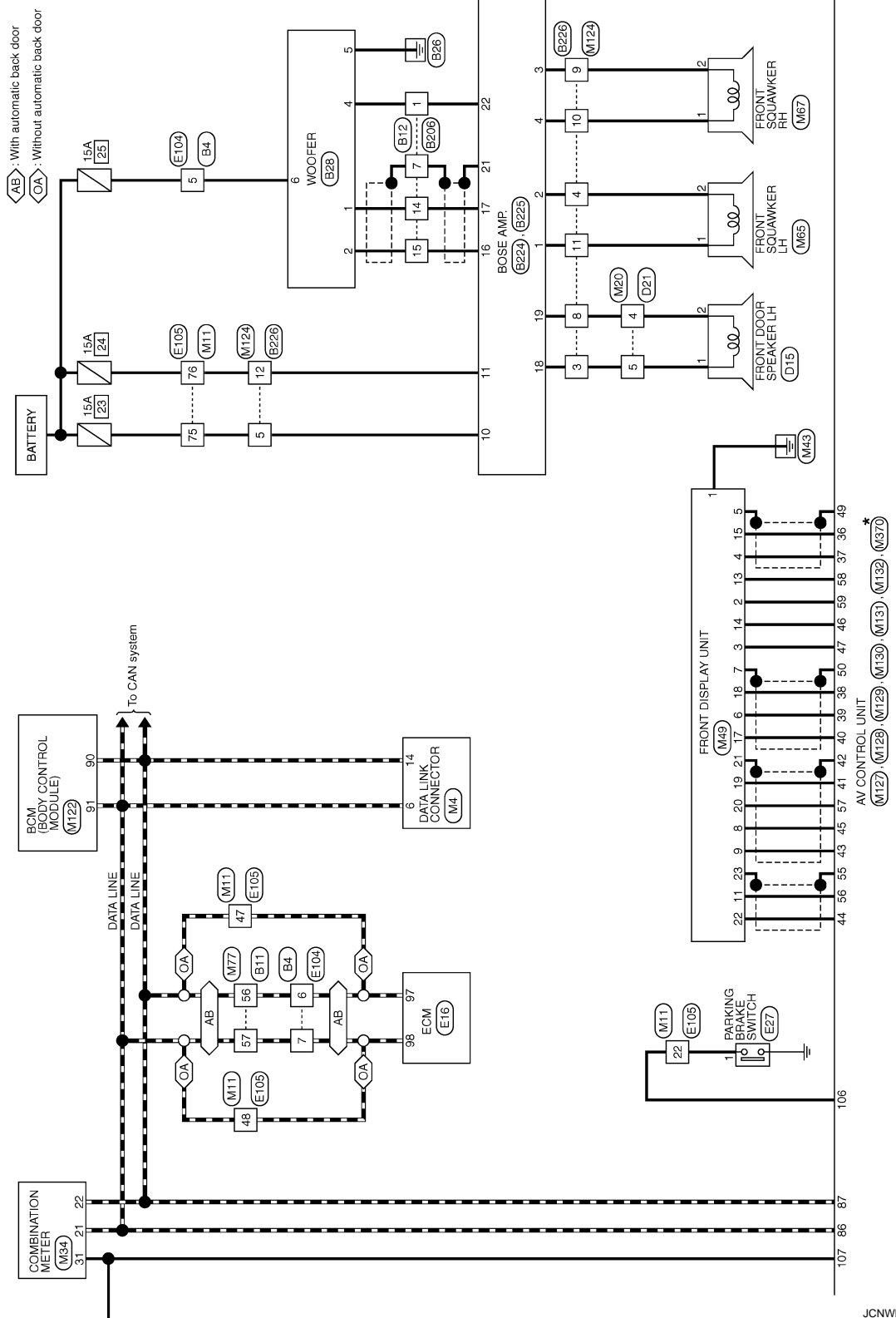

*: This connector is not shown in "Harness Layout".

A
B
C
D
E
F
G
H
I
J
K
L
M
AV
O
P

FRONT DISPLAY UNIT

[BOSE AUDIO WITHOUT NAVIGATION]

< ECU DIAGNOSIS >

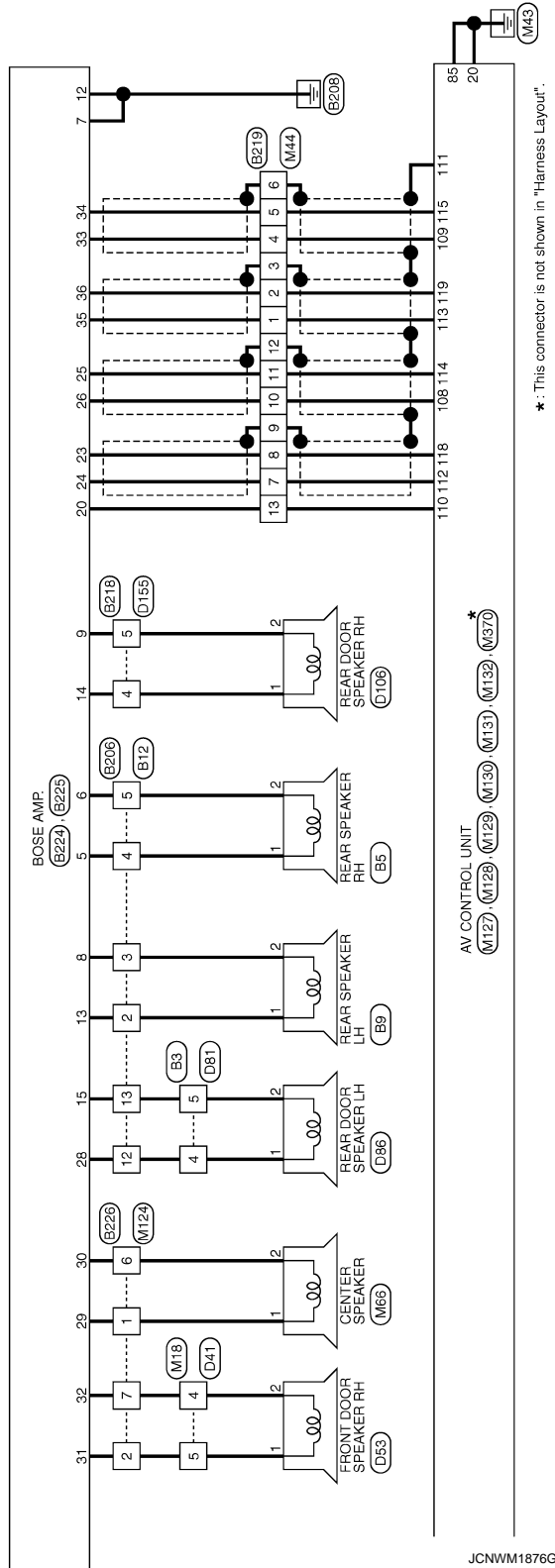

FRONT DISPLAY UNIT

[BOSE AUDIO WITHOUT NAVIGATION]

< ECU DIAGNOSIS >

BOSE AUDIO WITHOUT NAVIGATION WITH DVD ENTERTAINMENT SYSTEM

Connector No.	B3
Connector Name	WIRE TO WIRE
Connector Type	TK0DFW-ANS8



Terminal No.	Color of Wire	Signal Name [Specification]
4	LG	-
5	O	-

Connector No.	B4
Connector Name	WIRE TO WIRE
Connector Type	NS16MW-CS



Terminal No.	Color of Wire	Signal Name [Specification]
4	R	-
5	O	-
6	P	-
7	L	-

Connector No.	B5
Connector Name	REAR SPEAKER RH
Connector Type	TK02FBR



Terminal No.	Color of Wire	Signal Name [Specification]
1	V	-
2	LG	-

Connector No.	B9
Connector Name	REAR SPEAKER LH
Connector Type	TK02FBR



Terminal No.	Color of Wire	Signal Name [Specification]
1	SB	-
2	GR	-

Connector No.	B11
Connector Name	WIRE TO WIRE
Connector Type	TH80MW-CS19

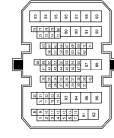

Terminal No.	Color of Wire	Signal Name [Specification]
1	SHIELD	-
2	B	-
3	R/L	-
4	R/W	-
8	SHIELD	-
9	BR/L	-
10	Y/G	-
11	Y/L	-
12	W/L	-
41	O	-
42	SB	-

43	G	-
44	BR	-
45	L	-
46	GR	-
47	V	-
48	GR	-(With rear view camera and telephone)
48	BR	-(With rear view camera without telephone)
49	Y	-
50	SHIELD	-
51	B	-
56	P	-
57	L	-
58	R	-
59	SHIELD	-
60	B	-
61	R/L	-
62	R/W	-
68	R	-
69	SHIELD	-
70	W/R	-
71	B/R	-

Connector No.	B12
Connector Name	WIRE TO WIRE
Connector Type	NS18FW-CS

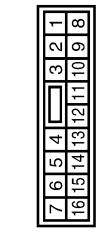

Terminal No.	Color of Wire	Signal Name [Specification]
1	W	-
2	SB	-
3	GR	-
4	V	-
5	LG	-
7	SHIELD	-
12	LG	-
13	O	-
14	W/R	-
15	B/R	-

A B C D E F G H I J K L M O P

AV

JCNWM1877G1

FRONT DISPLAY UNIT

[BOSE AUDIO WITHOUT NAVIGATION]

< ECU DIAGNOSIS >

BOSE AUDIO WITHOUT NAVIGATION WITH DVD ENTERTAINMENT SYSTEM

Connector No.	B25
Connector Name	WIRE TO WIRE
Connector Type	TH22MW-NH



Terminal No.	Color of Wire	Signal Name [Specification]
1	SB	
2	B	
4	SHIELD	
5	W/R	
6	W/L	
7	SHIELD	
8	GR/V	
9	W/L	
10	SHIELD	
11	W/L	
12	Y/G	

Connector No.	B30
Connector Name	WIRE TO WIRE
Connector Type	TH32FW-NH

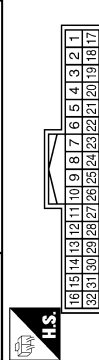

Terminal No.	Color of Wire	Signal Name [Specification]
1	SB	
3	G	
4	SHIELD	
5	W/R	
6	W/L	
7	SHIELD	
8	GR/V	
9	W/L	
10	SHIELD	
11	W/L	
12	Y/G	

Terminal No.	Color of Wire	Signal Name [Specification]
13	Y/L	
14	BR/L	
16	V	
18	O	
21	B/R	
22	W/R	
23	SHIELD	
24	B	
25	R/L	
26	R/W	
27	SHIELD	
28	B	
29	W	
30	SHIELD	
31	P	

Terminal No.	Color of Wire	Signal Name [Specification]
13	Y/L	
14	BR/L	
16	V	
18	O	
19	GR	
21	B/R	
22	W/R	
23	SHIELD	
24	B	
25	R/L	
26	R/W	
27	SHIELD	
28	B	
29	W	
30	SHIELD	
31	P	

Connector No.	B28
Connector Name	WOOFER
Connector Type	RS08FGY-PR

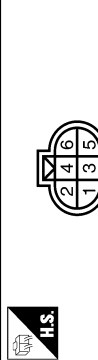

Terminal No.	Color of Wire	Signal Name [Specification]
1	W/R	SOUND SIGNAL WOOFER (-)
2	B/R	SOUND SIGNAL WOOFER (+)
4	W	WOOFER AMP. ON SIGNAL
5	B/W	GND
6	O	BAT

Connector No.	B33
Connector Name	TEL ADAPTER UNIT
Connector Type	TH08FW-NH

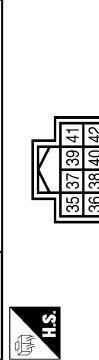

Terminal No.	Color of Wire	Signal Name [Specification]
35	Y	AV COMM (H)
36	BR	AV COMM (L)
40	G	AV COMM (H)
42	GR	AV COMM (L)

FRONT DISPLAY UNIT

[BOSE AUDIO WITHOUT NAVIGATION]

< ECU DIAGNOSIS >

BOSE AUDIO WITHOUT NAVIGATION WITH DVD ENTERTAINMENT SYSTEM

Connector No.	B38
Connector Name	TEL ADAPTER UNIT
Connector Type	TH2FW-NH



2	4	6	8	10	12	14	16	18	20	22	24	26	28	30	32
1	3	5	7	9	11	13	15	17	19	21	23	25	27	29	31

Terminal No.	Color of Wire	Signal Name [Specification]
1	V	BATTERY
2	GR	ACC
3	R	IGNITION
4	B/W	GND
5	SHIELD	SHIELD
6	SHIELD	SHIELD
7	R/W	MICROPHONE SIGNAL
8	R/L	MICROPHONE GND
9	B/R	TEL VOICE SIGNAL (+)
10	W/R	TEL VOICE SIGNAL (-)
14	B	GND

Connector No.	B80
Connector Name	CAMERA CONTROL UNIT
Connector Type	TH2FW-NH



2	4	6	8	10	12	14	16	18	20	22	24	26	28	30	32
1	3	5	7	9	11	13	15	17	19	21	23	25	27	29	31

Terminal No.	Color of Wire	Signal Name [Specification]
5	SHIELD	SHIELD
6	B	CAMERA IMAGE SIGNAL
7	R/W	GND
8	R/L	CAMERA ON SIGNAL
11	SHIELD	SHIELD
12	B	CAMERA IMAGE SIGNAL
14	L	CONNECTION RECOGNITION
17	BR	AV COMM (L)
18	Y	AV COMM (H)
19	GR	AV COMM (L)
20	G	AV COMM (H)

Connector No.	B48
Connector Name	SATELLITE RADIO TUNER
Connector Type	A18FW



2	4	6	8	10	12	14	16
1	3	5	7	9	11	13	15

Terminal No.	Color of Wire	Signal Name [Specification]
1	W/L	SOUND SIGNAL LH (-)
2	Y/L	SOUND SIGNAL LH (+)
3	Y/G	SOUND SIGNAL RH (-)
4	BR/L	SOUND SIGNAL RH (+)
5	SHIELD	SHIELD
6	SHIELD	SHIELD
8	R/W	REQUEST (SAT->CONT)
9	R/L	COMM (SAT->CONT)
10	B	COMM (CONT->SAT)
12	V	BATTERY
15	B	GND

Connector No.	B77
Connector Name	WIRE TO WIRE
Connector Type	TK12MW



1	2	3	4	5
6	7	8	9	10
11	12	13	14	15
16	17	18	19	20

Terminal No.	Color of Wire	Signal Name [Specification]
6	R/L	-
7	R/W	-
8	B	-
9	SHIELD	-

16	GR	ACC
----	----	-----

Connector No.	B206
Connector Name	WIRE TO WIRE
Connector Type	NS16MW-CS



1	2	3	4	5	6	7
8	9	10	11	12	13	14
15	16	17	18	19	20	21

Terminal No.	Color of Wire	Signal Name [Specification]
1	W	-
2	GR	-
3	BR	-
4	Y	-
5	BR	-
7	SHIELD	-
12	G	-
13	R	-
14	W/R	-
15	B/R	-

JCNWM1879GI

A
B
C
D
E
F
G
H
I
J
K
L
M
N
O
P

AV

FRONT DISPLAY UNIT

[BOSE AUDIO WITHOUT NAVIGATION]

< ECU DIAGNOSIS >

BOSE AUDIO WITHOUT NAVIGATION WITH DVD ENTERTAINMENT SYSTEM

Connector No.	B218
Connector Name	WIRE TO WIRE
Connector Type	TK10FW-NSB



Terminal No.	Color of Wire	Signal Name [Specification]
4	L	-[With BOSE system]
5	O	-[With BOSE system]

Connector No.	B219
Connector Name	WIRE TO WIRE
Connector Type	TK132MF-NH



Terminal No.	Color of Wire	Signal Name [Specification]
1	W/R	-
2	B/R	-
3	SHIELD	-
4	W/R	-
5	B/R	-
6	SHIELD	-
7	GR/V	-
8	W/L	-
9	SHIELD	-
10	GR/V	-
11	W/L	-

Connector No.	B224
Connector Name	BOSE AMP.
Connector Type	SGA12FBR-SJAZ

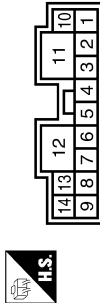

Terminal No.	Color of Wire	Signal Name [Specification]
1	LG	SOUND SIGNAL FRONT SQUAWKER LH (+)
2	V	SOUND SIGNAL FRONT SQUAWKER LH (-)
3	L	SOUND SIGNAL FRONT SQUAWKER RH (-)
4	P	SOUND SIGNAL FRONT SQUAWKER RH (+)
5	Y	SOUND SIGNAL REAR SPEAKER RH (+)
6	BR	SOUND SIGNAL REAR SPEAKER RH (-)
7	B	GND
8	BR	SOUND SIGNAL REAR SPEAKER LH (-)
9	O	SOUND SIGNAL REAR DOOR SPEAKER RH (-)
10	SB	BATTERY
11	GR	BATTERY

12	SHIELD
13	SB

Connector No.	B225
Connector Name	BOSE AMP.
Connector Type	SCA19FBR-SGA4

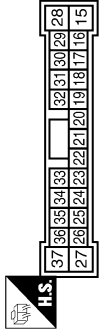

Terminal No.	Color of Wire	Signal Name [Specification]
15	R	SOUND SIGNAL REAR DOOR SPEAKER LH (-)
16	B/R	SOUND SIGNAL WOOFER (+)
17	W/R	SOUND SIGNAL WOOFER (-)
18	W	SOUND SIGNAL FRONT DOOR SPEAKER LH (+)
19	B	SOUND SIGNAL FRONT DOOR SPEAKER LH (-)
20	SB	AMP. ON SIGNAL
21	SHIELD	SHIELD
22	W	WOOFER AMP. ON SIGNAL
23	W/L	SOUND SIGNAL REAR LH (-)
24	GR/V	SOUND SIGNAL REAR LH (+)
25	W/L	SOUND SIGNAL REAR RH (-)

26	GR/V	SOUND SIGNAL REAR RH (+)
28	G	SOUND SIGNAL REAR DOOR SPEAKER LH (+)
29	V	SOUND SIGNAL CENTER SPEAKER (+)
30	P	SOUND SIGNAL CENTER SPEAKER (-)
31	BR	SOUND SIGNAL FRONT DOOR SPEAKER RH (+)
32	Y	SOUND SIGNAL FRONT DOOR SPEAKER RH (-)
33	W/R	SOUND SIGNAL FRONT RH (+)
34	B/R	SOUND SIGNAL FRONT RH (-)
35	W/R	SOUND SIGNAL FRONT LH (-)
36	B/R	SOUND SIGNAL FRONT LH (+)

JCNWM1880GI

FRONT DISPLAY UNIT

[BOSE AUDIO WITHOUT NAVIGATION]

< ECU DIAGNOSIS >

BOSE AUDIO WITHOUT NAVIGATION WITH DVD ENTERTAINMENT SYSTEM

Connector No.	B226
Connector Name	WIRE TO WIRE
Connector Type	NS2MFR-CS

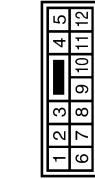

Terminal No.	Color of Wire	Signal Name [Specification]
1	V	
2	BR	
3	W	
4	V	
5	SB	
6	P	
7	Y	
8	B	
9	L	
10	P	
11	LG	

Connector No.	B465
Connector Name	ANTENNA BASE (SATELLITE ANTENNA) WITH BOSE SYSTEM WITHOUT NAVIGATION SYSTEM
Connector Type	GT18C-1PP-HU



Terminal No.	1	Color of Wire	—	Signal Name [Specification]	SATELLITE ANTENNA
--------------	---	---------------	---	-----------------------------	-------------------

12	GR	—
----	----	---

Connector No.	B471
Connector Name	TEL ADAPTER UNIT
Connector Type	GT18C-1S-HU



Terminal No.	33	Color of Wire	—	Signal Name [Specification]	TEL ANTENNA SHIELD
	34	SHIELD			

Connector No.	D21
Connector Name	WIRE TO WIRE
Connector Type	TH40FW-CS15

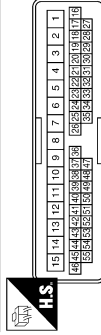

Terminal No.	4	Color of Wire	B/W	Signal Name [Specification]	— [Type A]
	4	B			— [Type B]
	5	L			— [Type A]
	5	W			— [Type B]

Connector No.	B482
Connector Name	SATELLITE RADIO TUNER
Connector Type	FAK8A



Terminal No.	33	Color of Wire	—	Signal Name [Specification]	SATELLITE ANTENNA
--------------	----	---------------	---	-----------------------------	-------------------

Connector No.	D41
Connector Name	WIRE TO WIRE
Connector Type	TH40FW-CS15

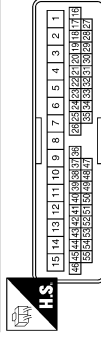

Terminal No.	4	Color of Wire	B/R	Signal Name [Specification]	— [Type A]
	4	B			— [Type B]
	5	BR			— [Type A]
	5	W			— [Type B]

A
B
C
D
E
F
G
H
I
J
K
L
M
O
P

AV

JCNWM1881G1

FRONT DISPLAY UNIT

[BOSE AUDIO WITHOUT NAVIGATION]

< ECU DIAGNOSIS >

BOSE AUDIO WITHOUT NAVIGATION WITH DVD ENTERTAINMENT SYSTEM

Connector No.	D106
Connector Name	REAR DOOR SPEAKER RH (WITH BOSE SYSTEM)
Connector Type	NS02FBR-CS



Terminal No.	Color of Wire	Signal Name [Specification]
1	O	-[Type A]
1	L	-[Type B]
2	B/P	-[Type A]
2	W	-[Type B]

Connector No.	D36
Connector Name	REAR DOOR SPEAKER LH (WITH BOSE SYSTEM)
Connector Type	NS02FBR-CS



Terminal No.	Color of Wire	Signal Name [Specification]
1	L	-
2	W	-

Connector No.	D81
Connector Name	WIRE TO WIRE
Connector Type	TK10MW-NS

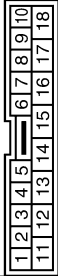

Terminal No.	Color of Wire	Signal Name [Specification]
4	L	-
5	W	-

Connector No.	D53
Connector Name	FRONT DOOR SPEAKER RH (WITH BOSE SYSTEM)
Connector Type	NS02FBR-CS



Terminal No.	Color of Wire	Signal Name [Specification]
1	BR	-[Type A]
1	W	-[Type B]
2	B/R	-[Type A]
2	B	-[Type B]

Connector No.	E6
Connector Name	WIRE TO WIRE
Connector Type	TK16MGY-TV



Connector No.	D192
Connector Name	REAR VIEW CAMERA
Connector Type	TH4MW-NH



Connector No.	D182
Connector Name	WIRE TO WIRE
Connector Type	TK12FW

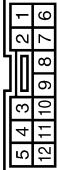

Connector No.	D155
Connector Name	WIRE TO WIRE
Connector Type	TK10MW-NS



Terminal No.	Color of Wire	Signal Name [Specification]
4	R	-

Terminal No.	Color of Wire	Signal Name [Specification]
1	R	CAMERA ON SIGNAL
2	G	GND
3	B	CAMERA IMAGE SIGNAL
4	SHIELD	SHIELD

Terminal No.	Color of Wire	Signal Name [Specification]
6	R	-
7	G	-
8	B	-
9	SHIELD	-

Terminal No.	Color of Wire	Signal Name [Specification]
4	O	-[Type A]
4	L	-[Type B]
5	B/P	-[Type A]
5	W	-[Type B]

JCNWM1882GI

FRONT DISPLAY UNIT

[BOSE AUDIO WITHOUT NAVIGATION]

< ECU DIAGNOSIS >

BOSE AUDIO WITHOUT NAVIGATION WITH DVD ENTERTAINMENT SYSTEM

Connector No.	E18
Connector Name	ECM
Connector Type	RH24FB-RZ8-L-LH

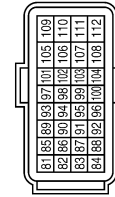

Terminal No.	Color of Wire	Signal Name [Specification]
97	P	VEHGAN-L
98	L	VEHGAN-H

Connector No.	E18
Connector Name	BACK-UP LAMP RELAY
Connector Type	MS02FL-M2-LC

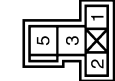

Terminal No.	Color of Wire	Signal Name [Specification]
1	LG	-
2	R	-
3	LG	-
5	R	-

Connector No.	E27
Connector Name	PARKING BRAKE SWITCH
Connector Type	F01FB-A



Terminal No.	Color of Wire	Signal Name [Specification]
1	P	-

Connector No.	E104
Connector Name	WIRE TO WIRE
Connector Type	NS38FW-CS

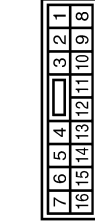

Terminal No.	Color of Wire	Signal Name [Specification]
4	R	-
5	L	-
6	P	-
7	L	-

Connector No.	E105
Connector Name	WIRE TO WIRE
Connector Type	TH170MW-CS10-M3



Terminal No.	Color of Wire	Signal Name [Specification]
5	LG	-
22	P	-
47	P	-
48	L	-
75	BR	-
76	GR	-
78	V	-

Connector No.	F23
Connector Name	TOM (TRANSMISSION CONTROL MODULE)
Connector Type	RH40FB-RZ8-L-RH

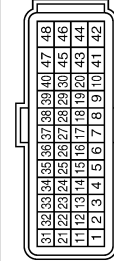

Terminal No.	Color of Wire	Signal Name [Specification]
19	G/B	REV LAMP RELAY

Connector No.	F123
Connector Name	WIRE TO WIRE
Connector Type	TK18FGY-1V

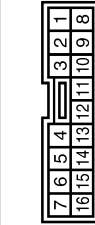

Terminal No.	Color of Wire	Signal Name [Specification]
4	G/B	-

Connector No.	M1
Connector Name	FUSE BLOK (J/B)
Connector Type	NS08FW-M2



Terminal No.	Color of Wire	Signal Name [Specification]
2A	G	-
5A	R	-

A
B
C
D
E
F
G
H
I
J
K
L
M
AV
O
P

FRONT DISPLAY UNIT

[BOSE AUDIO WITHOUT NAVIGATION]

< ECU DIAGNOSIS >

BOSE AUDIO WITHOUT NAVIGATION WITH DVD ENTERTAINMENT SYSTEM

Connector No.	M3
Connector Name	FUSE BLOCK (J/B)
Connector Type	HS12FW-CS

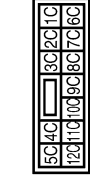

Terminal No.	Color of Wire	Signal Name [Specification]
12C	O	-

Connector No.	M4
Connector Name	DATA LINK CONNECTOR
Connector Type	BD16FW



Terminal No.	Color of Wire	Signal Name [Specification]
6	L	-
14	P	-

Connector No.	M11
Connector Name	WIRE TO WIRE
Connector Type	TH10FW-CS10-M3

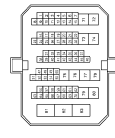

Terminal No.	Color of Wire	Signal Name [Specification]
5	O	-
22	G	-
47	P	-
48	L	-
75	BR	-
76	R	-
78	Y	-

Connector No.	M18
Connector Name	WIRE TO WIRE
Connector Type	TH40MW-CS15

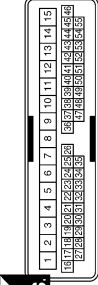

Terminal No.	Color of Wire	Signal Name [Specification]
4	W	-
5	BR	- [Type A and without BOSE system type B]
	B	- [With BOSE system type B]

Connector No.	M20
Connector Name	WIRE TO WIRE
Connector Type	TH40MW-CS15

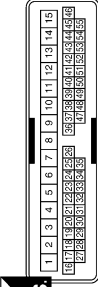

Terminal No.	Color of Wire	Signal Name [Specification]
4	B	-
5	L	-

Connector No.	M22
Connector Name	WIRE TO WIRE
Connector Type	TH12FW-NH

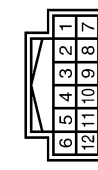

Terminal No.	Color of Wire	Signal Name [Specification]
1	V	-
2	R	-
3	R	-
4	G	-
5	W	-
6	SHIELD	-
7	LG	-
8	SHIELD	-
9	BR	-
10	SHIELD	-
11	L	-

Connector No.	M23
Connector Name	WIRE TO WIRE
Connector Type	TH16MW-NH

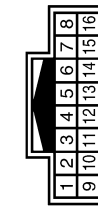

Terminal No.	Color of Wire	Signal Name [Specification]
1	W	-
2	R	- [With telephones without navigation system]
3	B	-
4	SHIELD	-

JCNWM1884GI

FRONT DISPLAY UNIT

[BOSE AUDIO WITHOUT NAVIGATION]

< ECU DIAGNOSIS >

BOSE AUDIO WITHOUT NAVIGATION WITH DVD ENTERTAINMENT SYSTEM

Connector No.	M33
Connector Name	STEERING ANGLE SENSOR
Connector Type	TH08FW-NH

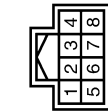

Terminal No.	Color of Wire	Signal Name [Specification]
1	B	-
3	L	-
4	G	-
6	SB	-
8	O	-

Connector No.	M33
Connector Name	COMBINATION SWITCH (SPIRAL CABLE)
Connector Type	TH08FGY-1V

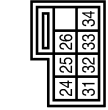

Terminal No.	Color of Wire	Signal Name [Specification]
24	BR	- [With audio steering switch and telephone]
31	G	- [With audio steering switch and telephone]
33	L	- [With audio steering switch and telephone]

Connector No.	M34
Connector Name	COMBINATION METER
Connector Type	TH46FW-NH

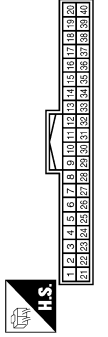

Terminal No.	Color of Wire	Signal Name [Specification]
21	L	CAN-H
22	P	CAN-L
31	V	VEHICLE SPEED (8-PULSE)

Connector No.	M44
Connector Name	WIRE TO WIRE
Connector Type	TH22FW-NH

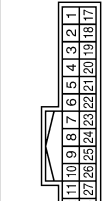

Terminal No.	10	V	-
11	LG	-	-
12	SHIELD	-	-
13	P	-	-

Connector No.	M49
Connector Name	FRONT DISPLAY UNIT
Connector Type	TH24FW-NH

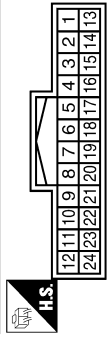

14	LG	SIGNAL GND [Without navigation system]
15	L	COMPOSITE IMAGE SIGNAL [Without navigation system]
17	G	RGB (RED) SIGNAL
18	Y	RGB (BLUE) SIGNAL [Without navigation system]
19	B	RGB SYNC
20	R	VP
21	SHIELD	SHIELD
22	G	COMM (DISEP->CONT)
23	SHIELD	SHIELD

Terminal No.	Color of Wire	Signal Name [Specification]
1	G	-
2	R	-
3	SHIELD	-
4	B	-
5	W	-
6	SHIELD	-
7	O	- [Type A]
7	L	- [Type B]
8	SB	- [Type A]
8	R	- [Type B]
9	SHIELD	-

Terminal No.	Color of Wire	Signal Name [Specification]
1	B	GND
2	Y	INVERTER VCCI [Without navigation system]
3	O	SIGNAL VCCI [Without navigation system]
4	P	COMPOSITE IMAGE GND [Without navigation system]
5	SHIELD	SHIELD [Without navigation system]
6	L	RGB (GREEN) SIGNAL [Without navigation system]
7	SHIELD	SHIELD
8	G	HP [Without navigation system]
9	W	RGB AREA (YS) SIGNAL
11	R	COMM (CONT->DISEP)
13	BR	INVERTER GND [Without navigation system]

A
B
C
D
E
F
G
H
I
J
K
L
M
N
O
P

AV

JCNWM1885GI

FRONT DISPLAY UNIT

[BOSE AUDIO WITHOUT NAVIGATION]

< ECU DIAGNOSIS >

BOSE AUDIO WITHOUT NAVIGATION WITH DVD ENTERTAINMENT SYSTEM

Connector No.	M65
Connector Name	FRONT SQUAWKER LH
Connector Type	TK02FBR



Terminal No.	Color of Wire	Signal Name [Specification]
1	LG	[With BOSE system]
2	Y	[With BOSE system]

Connector No.	M66
Connector Name	CENTER SPEAKER
Connector Type	TK02FBR



Terminal No.	Color of Wire	Signal Name [Specification]
1	P	-
2	O	-

Connector No.	M67
Connector Name	FRONT SQUAWKER RH
Connector Type	TK02FBR



Terminal No.	Color of Wire	Signal Name [Specification]
1	BR	-
2	R	[With BOSE system]

Connector No.	M77
Connector Name	WIRE TO WIRE
Connector Type	TH80FW-CS19

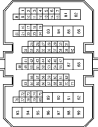

Terminal No.	Color of Wire	Signal Name [Specification]
1	SHIELD	-
2	B	-
3	W	-
4	R	-
8	SHIELD	-
9	W	-
10	R	-
11	G	-
12	B	-
41	O	-
42	SB	-

43	L	-
44	V	-
45	P	-
46	R	-
47	Y	-
48	L	-
49	G	-
50	SHIELD	-
51	W	-
56	P	-
57	L	-
58	SB	-
59	SHIELD	-
60	B	-
61	R	-
62	W	-
68	G	-
69	SHIELD	-
70	L	-
71	R	-

Connector No.	M66
Connector Name	WIRE TO WIRE
Connector Type	TH18FW-NH

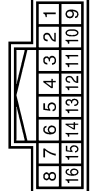

Terminal No.	Color of Wire	Signal Name [Specification]
1	Y	-
3	R	-
4	L	-
5	L	-
6	R	-
7	SHIELD	-
8	R	-
9	G	-
11	B	-
12	G	-
13	R	-

14	W	-
15	SHIELD	-
16	B	-

JCNWM1886GI

FRONT DISPLAY UNIT

[BOSE AUDIO WITHOUT NAVIGATION]

< ECU DIAGNOSIS >

BOSE AUDIO WITHOUT NAVIGATION WITH DVD ENTERTAINMENT SYSTEM

Connector No.	M122
Connector Name	BCM (BODY CONTROL MODULE)
Connector Type	TH40FB-NH

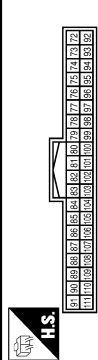

Terminal No.	Color of Wire	Signal Name [Specification]
90	P	CAN-L
91	L	CAN-H

Connector No.	M124
Connector Name	WIRE TO WIRE
Connector Type	NS12FER-CS

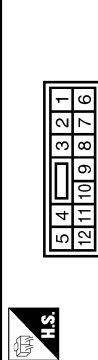

Terminal No.	Color of Wire	Signal Name [Specification]
1	P	-
2	BR	- [Type A]
3	B	- [Type B]
4	L	-
5	Y	-
6	BR	-
7	O	-
8	W	-
9	B	-
10	R	-
11	BR	-

Connector No.	M127
Connector Name	AV CONTROL UNIT (WITH BOSE SYSTEM WITHOUT NAVIGATION SYSTEM)
Connector Type	TH18FW-CS2

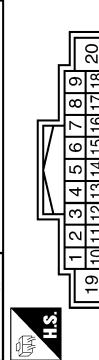

Terminal No.	Color of Wire	Signal Name [Specification]
6	BR	STRG SW A
7	R	ACC
9	R	ILLUMINATION
15	L	STRG SW GND
16	G	STRG SW B
19	Y	BATTERY
20	B	GND

Connector No.	M128
Connector Name	AV CONTROL UNIT (WITH BOSE SYSTEM WITHOUT NAVIGATION SYSTEM)
Connector Type	A12FW

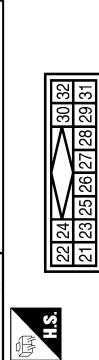

Terminal No.	Color of Wire	Signal Name [Specification]
21	B	SATELLITE RADIO SOUND SIGNAL LH (-)
22	G	SATELLITE RADIO SOUND SIGNAL LH (+)
23	R	SATELLITE RADIO SOUND SIGNAL RH (-)
24	W	SATELLITE RADIO SOUND SIGNAL RH (+)
25	SHIELD	SHIELD
26	SHIELD	SHIELD
28	R	REQUEST (SAT->CONT)
29	W	COMM (SAT->CONT)
30	B	COMM (CONT->SAT)

11	LG
12	R

Connector No.	M125
Connector Name	MULTIFUNCTION SWITCH
Connector Type	TH18FW-NH

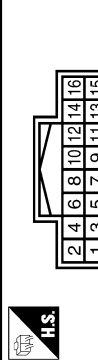

Terminal No.	Color of Wire	Signal Name [Specification]
1	B	GND
3	R	ACC
6	R	AV COMM (H)
8	L	AV COMM (L)
9	V	SW GND
14	W	EJECT SIGNAL

Connector No.	M129
Connector Name	AV CONTROL UNIT (WITH BOSE SYSTEM WITHOUT NAVIGATION SYSTEM)
Connector Type	TH24FW-NH

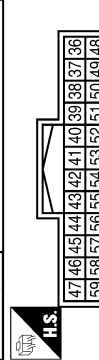

Terminal No.	Color of Wire	Signal Name [Specification]
36	L	COMPOSITE IMAGE SIGNAL
37	P	COMPOSITE IMAGE GND
38	Y	RGB (B/BLUE) SIGNAL
39	L	RGB (G/GREEN) SIGNAL
40	G	RGB (R/RED) SIGNAL
41	B	RGB SYNC
42	SHIELD	SHIELD
43	W	RGB AREA (YS) SIGNAL
44	G	COMM (DISP->CONT)
45	G	HP
46	LG	SIGNAL GND

47	O	SIGNAL VCC
49	SHIELD	SHIELD
50	SHIELD	SHIELD
55	SHIELD	SHIELD
56	R	COMM (CONT->DISP)
57	R	VP
58	BR	INVERTER GND
59	Y	INVERTER VCC

JCNWM1887GI

A
B
C
D
E
F
G
H
I
J
K
L
M
N
O
P

AV

FRONT DISPLAY UNIT

[BOSE AUDIO WITHOUT NAVIGATION]

< ECU DIAGNOSIS >

BOSE AUDIO WITHOUT NAVIGATION WITH DVD ENTERTAINMENT SYSTEM

Connector No.	M130
Connector Name	AV CONTROL UNIT (WITH BOSE SYSTEM WITHOUT NAVIGATION SYSTEM)
Connector Type	TH16FW-NH



67	66	65	64	63	62	61	60
75	74	73	72	71	70	69	68

Terminal No.	Color of Wire	Signal Name [Specification]
64	SHIELD	SHIELD
65	W	CAMERA IMAGE SIGNAL
66	L	COMPOSITE IMAGE SIGNAL (With DVD player)
68	P	CONNECTION RECOGNITION SHIELD (With DVD player)
74	R	COMPOSITE IMAGE GND (With DVD player)

Connector No.	M131
Connector Name	AV CONTROL UNIT (WITH BOSE SYSTEM WITH NAVIGATION SYSTEM)
Connector Type	TH24FW-NH



71	70	69	68	67	66	65	64	63	62	61	60	59	58	57	56	55	54	53	52	51	50	49	48	47	46	45	44	43	42	41	40	39	38	37	36	35	34	33	32	31	30	29	28	27	26	25	24	23	22	21	20	19	18	17	16	15	14	13	12	11	10	9	8	7	6	5	4	3	2	1
----	----	----	----	----	----	----	----	----	----	----	----	----	----	----	----	----	----	----	----	----	----	----	----	----	----	----	----	----	----	----	----	----	----	----	----	----	----	----	----	----	----	----	----	----	----	----	----	----	----	----	----	----	----	----	----	----	----	----	----	----	----	---	---	---	---	---	---	---	---	---

Terminal No.	Color of Wire	Signal Name [Specification]
79	L	TEL VOICE SIGNAL (-)
80	R	TEL VOICE SIGNAL (+)
81	SHIELD	SHIELD
82	W	SOUND SIGNAL RH (-) (With DVD player)
83	R	SOUND SIGNAL RH (+) (With DVD player)
85	B	GND
86	L	CAN-H
87	P	CAN-L
88	R	AV COMM (H)
89	L	AV COMM (L)
90	G	AV COMM (H)

Terminal No.	119	R	SOUND SIGNAL FRONT LH (-)
--------------	-----	---	---------------------------



114	115	116	117	118	119
108	109	110	111	112	113

Terminal No.	Color of Wire	Signal Name [Specification]
108	V	SOUND SIGNAL REAR RH (+)
109	B	SOUND SIGNAL FRONT RH (+)
110	P	AMP ON SIGNAL
111	SHIELD	SHIELD
112	O	SOUND SIGNAL REAR LH (+) (Type A)
112	L	SOUND SIGNAL REAR LH (+) (Type B)
113	G	SOUND SIGNAL FRONT LH (+)
114	LG	SOUND SIGNAL REAR RH (-)
115	W	SOUND SIGNAL FRONT RH (-)
118	SB	SOUND SIGNAL REAR LH (-) (Type A)
118	R	SOUND SIGNAL REAR LH (-) (Type B)

91	L	AV COMM (L)
98	G	SOUND SIGNAL LH (-) (With DVD player)
99	B	SOUND SIGNAL LH (+) (With DVD player)
100	SHIELD	SHIELD (With DVD player)
101	V	SW GND
103	W	EJECT SIGNAL
104	G	IGNITION
105	SB	REVERSE
106	G	PARKING BRAKE
107	V	VEHICLE SPEED (8-PULSE)

Connector No.	M148
Connector Name	iPod ADAPTER
Connector Type	TH24FW-NH



1	2	3	4	5	6	7	8	9	10	11	12
13	14	15	16	17	18	19	20	21	22	23	24

Terminal No.	Color of Wire	Signal Name [Specification]
1	BR	iPod SOUND SIGNAL LH (+)
2	R	iPod SOUND SIGNAL RH (+)
3	R	ACC
4	L	AV COMM (L)
5	Y	BATTERY
8	W	CHARGE POWER
9	G	COMM (iPod ADAPTER->iPod)
10	R	COMM (iPod->iPod ADAPTER)
11	R	ACCESSORY IDENTIFY
12	V	iPod SOUND SIGNAL RH (+)
13	L	iPod SOUND SIGNAL LH (+)

14	W	iPod SOUND SIGNAL RH (-)
15	SHIELD	SHIELD
16	R	AV COMM (H)
17	SHIELD	GND
19	SHIELD	SHIELD
21	L	iPod CONNECTION RECOGNITION
22	BR	ACCESSORY DETECT
23	R	iPod SOUND SIGNAL GND
24	LG	iPod SOUND SIGNAL LH (+)

FRONT DISPLAY UNIT

[BOSE AUDIO WITHOUT NAVIGATION]

< ECU DIAGNOSIS >

BOSE AUDIO WITHOUT NAVIGATION WITH DVD ENTERTAINMENT SYSTEM

Connector No.	M201
Connector Name	WIRE TO WIRE
Connector Type	TH181MW-NH



Terminal No.	Color of Wire	Signal Name [Specification]
1	Y	-
2	R	-
3	R	-
4	G	-
5	L	-
6	P	-
7	SHIELD	-
8	V	-
9	G	-
10	B	-
11	B	-
12	G	-
13	R	-

Terminal No.	14	W
Terminal No.	15	SHIELD
Terminal No.	16	B



Terminal No.	Color of Wire	Signal Name [Specification]
1	V	-
2	R	-
3	R	-
4	G	-
5	W	-
6	SHIELD	-
7	LG	-
8	SHIELD	-
9	BR	-
10	SHIELD	-
11	L	-
12	-	-

Terminal No.	12	R
Terminal No.	-	-



Connector No.	M253
Connector Name	AUXILIARY INPUT JACKS
Connector Type	A08FW

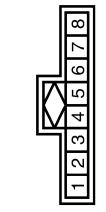

Terminal No.	Color of Wire	Signal Name [Specification]
1	R	SOUND SIGNAL RH (+)
2	W	SOUND SIGNAL GND
3	G	SOUND SIGNAL LH (-) [With DVD player]
7	G	AUX IMAGE SIGNAL
8	SHIELD	SHIELD [With DVD player]

Connector No.	M254
Connector Name	DVD PLAYER
Connector Type	TH432FW-NH

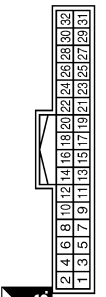

Terminal No.	Color of Wire	Signal Name [Specification]
1	B	GND
2	Y	BATTERY
4	V	ACC
5	SHIELD	SHIELD
7	P	DVD IMAGE SIGNAL
11	B	AUX SOUND SIGNAL LH (-)
12	W	AUX SOUND SIGNAL RH (+)
13	G	AUX SOUND SIGNAL LH (+)
14	R	AUX SOUND SIGNAL RH (-)
16	SHIELD	SHIELD
17	G	HEADPHONE SOUND SIGNAL LH (+)

Terminal No.	Color of Wire	Signal Name [Specification]
18	R	HEADPHONE SOUND SIGNAL LH (-)
19	V	HEADPHONE SOUND SIGNAL RH (+)
20	LG	HEADPHONE SOUND SIGNAL RH (-)
21	B	SOUND SIGNAL LH (+)
22	G	SOUND SIGNAL LH (-)
23	R	SOUND SIGNAL RH (+)
24	W	SOUND SIGNAL RH (-)
26	L	AV COMM (L)
30	R	AV COMM (H)
31	L	AV COMM (L)
32	R	AV COMM (H)

Connector No.	M255
Connector Name	VIDEO DISTRIBUTOR
Connector Type	TH08FW-NH

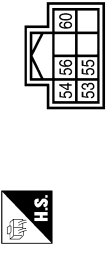

Terminal No.	Color of Wire	Signal Name [Specification]
53	B	GND
54	Y	BATTERY
55	V	ACC
56	G	IGNITION
60	R	HEADPHONE ON SIGNAL

A
B
C
D
E
F
G
H
I
J
K
L
M
O
P

AV

JCNWM1889GI

FRONT DISPLAY UNIT

[BOSE AUDIO WITHOUT NAVIGATION]

< ECU DIAGNOSIS >

BOSE AUDIO WITHOUT NAVIGATION WITH DVD ENTERTAINMENT SYSTEM

Connector No.	M256
Connector Name	VIDEO DISTRIBUTOR
Connector Type	TH12FW-NH



Connector No.	M257
Connector Name	VIDEO DISTRIBUTOR
Connector Type	TH11FW-NH

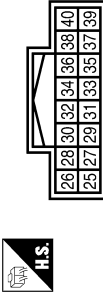

Terminal No.	Color of Wire	Signal Name [Specification]
51	B	GND

Terminal No.	Color of Wire	Signal Name [Specification]
25	R	RGB (R/RED) SIGNAL
26	L	RGB (G/GREEN) SIGNAL
27	W	RGB GND
28	G	RGB (B/BLUE) SIGNAL
29	R	YP
30	W	HP
31	SHIELD	SHIELD
32	B	RGB AREA (S) SIGNAL
33	G	COMPOSITE SYNC
34	R	COMPOSITE IMAGE SIGNAL
35	SHIELD	SHIELD

Connector No.	M258
Connector Name	VIDEO DISTRIBUTOR
Connector Type	TH124FW-NH

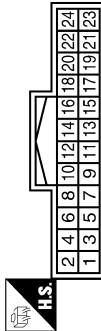

Terminal No.	Color of Wire	Signal Name [Specification]
1	R	AV COMM (H)
2	G	AV COMM (L)
3	R	AV COMM (H)
4	L	AV COMM (L)
6	R	COMPOSITE IMAGE GND
8	L	COMPOSITE IMAGE SIGNAL
15	B	GND
16	B	GND
19	G	AUX IMAGE SIGNAL
21	SHIELD	SHIELD
22	SHIELD	SHIELD

36	G	IGNITION
38	SHIELD	SHIELD
39	V	COMM (DISP->DIST)
40	LG	COMM (DIST->DISP)

Connector No.	M259
Connector Name	WIRES TO WIRE
Connector Type	TH32MW-NH

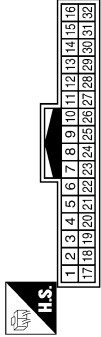

Terminal No.	Color of Wire	Signal Name [Specification]
1	Y	-
3	R	-
4	SHIELD	-
5	LG	-
6	V	-
7	SHIELD	-
8	R	-
9	G	-
10	SHIELD	-
11	W	-
12	G	-

13	L	-
14	R	-
16	G	-
18	V	-
19	L	-
21	LG	-
22	V	-
23	SHIELD	-
24	B	-
25	W	-
26	R	-
27	SHIELD	-
28	G	-
29	R	-
30	SHIELD	-
31	R	-

JCNWM1890GI

FRONT DISPLAY UNIT

[BOSE AUDIO WITHOUT NAVIGATION]

< ECU DIAGNOSIS >

BOSE AUDIO WITHOUT NAVIGATION WITH DVD ENTERTAINMENT SYSTEM

Connector No.	M376
Connector Name	POD SIDE
Connector Type	IP16FGY

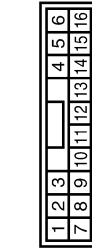

Terminal No.	Color of Wire	Signal Name [Specification]
1	LG	POD SOUND SIGNAL LH (+)
2	R	POD SOUND SIGNAL LH (-)
5	R	COMM (POD->POD ADAPTER)
6	G	COMM (POD ADAPTER->POD)
7	V	POD SOUND SIGNAL RH (+)
8	Y	POD SOUND SIGNAL RH (-)
10	SHIELD	GND
12	W	CHARGE POWER
14	SHIELD	SHIELD
15	BR	ACCESSORY DETECT
16	R	ACCESSORY IDENTIFY

Connector No.	M376
Connector Name	WIRE TO WIRE
Connector Type	GT13SON-2/1PP-HU

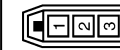

Terminal No.	Color of Wire	Signal Name [Specification]
1	-	-
2	-	-
3	-	-

Connector No.	M303
Connector Name	COMBINATION SWITCH (SPIRAL CABLE)
Connector Type	TK08FGY



Terminal No.	Color of Wire	Signal Name [Specification]
14	-	-
15	-	-
17	-	-

Connector No.	M378
Connector Name	ANTENNA BASE (ANTENNA AMP.)
Connector Type	GT13SSN-1/1PP-HU

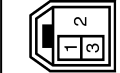

Terminal No.	Color of Wire	Signal Name [Specification]
1	-	-
3	-	-

Connector No.	M370
Connector Name	AV CONTROL UNIT (WITH BOSE SYSTEM WITHOUT NAVIGATION SYSTEM)
Connector Type	GT13SC-2/1S-HU



Terminal No.	Color of Wire	Signal Name [Specification]
33	-	FM SUB
34	-	AM-FM MAIN
35	-	ANTENNA AMP. ON SIGNAL

Connector No.	M379
Connector Name	GLASS ANTENNA
Connector Type	GT13SSN-1/1PP-HU



Terminal No.	Color of Wire	Signal Name [Specification]
2	-	FM SUB

Connector No.	M375
Connector Name	WIRE TO WIRE
Connector Type	GT13SH-2/1S-HU



Terminal No.	Color of Wire	Signal Name [Specification]
1	-	-
2	-	-
3	-	-

Connector No.	RT
Connector Name	WIRE TO WIRE
Connector Type	TH16FW-NH

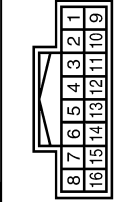

Terminal No.	Color of Wire	Signal Name [Specification]
1	R/W	-
2	R/L	- [With telephone without navigation system]
3	B	-
4	SHIELD	-

A
B
C
D
E
F
G
H
I
J
K
L
M
O
P

AV

JCNWM1891GI

FRONT DISPLAY UNIT

[BOSE AUDIO WITHOUT NAVIGATION]

< ECU DIAGNOSIS >

BOSE AUDIO WITHOUT NAVIGATION WITH DVD ENTERTAINMENT SYSTEM

Connector No.	R20
Connector Name	MICROPHONE
Connector Type	TK04FW



Terminal No.	Color of Wire	Signal Name [Specification]
1	R/W	MICROPHONE SIGNAL (+)
2	R/L	MICROPHONE SIGNAL (-) (Bose system without navigation system)
4	B	MICROPHONE POWER

Connector No.	R152
Connector Name	REAR DISPLAY UNIT
Connector Type	TH02FW-NH

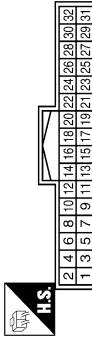

Terminal No.	Color of Wire	Signal Name [Specification]
1	B	GND
2	B	GND
3	Y/R	BATTERY
4	Y/R	BATTERY
5	R	HEADPHONE ON SIGNAL
6	V/Y	ACC
8	SHIELD	SHIELD
9	V	COMM (DISP->DIST)
10	LG	COMM (DIST->DISP)
11	G	IGNITION
12	SHIELD	SHIELD

Connector No.	R153
Connector Name	WIRE TO WIRE
Connector Type	TH02FW-NH

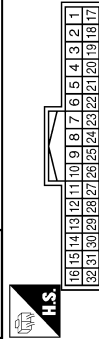

Terminal No.	Color of Wire	Signal Name [Specification]
1	Y/R	-
2	B	-
4	SHIELD	-
5	LG	-
6	V	-
7	SHIELD	-
8	BR	-
9	Y	-
10	SHIELD	-
11	W/L	-
12	Y/G	-

13	G	COMPOSITE SYNC
14	R	COMPOSITE IMAGE SIGNAL
15	B	RGB AREA (Y/S) SIGNAL
16	SHIELD	GND
17	R	V/P
18	W	HP
19	W/L	RGB GND
20	Y/G	RGB (B/BLUE) SIGNAL
21	Y/L	RGB (G/GREEN) SIGNAL
22	BR/L	RGB (R/RED) SIGNAL
23	SHIELD	SHIELD
24	SHIELD	SHIELD
25	LG	HEADPHONE SOUND SIGNAL RH (-)
26	BR	HEADPHONE SOUND SIGNAL LH (-)
27	V	HEADPHONE SOUND SIGNAL RH (+)
28	Y	HEADPHONE SOUND SIGNAL LH (+)

13	Y/L	-
14	BR/L	-
16	G	-
18	V/Y	-
21	LG	-
22	V	-
23	SHIELD	-
24	B	-
25	W	-
26	R	-
27	SHIELD	-
28	G	-
29	R	-
30	SHIELD	-
31	R	-

BOSE AMP.

< ECU DIAGNOSIS >

[BOSE AUDIO WITHOUT NAVIGATION]

BOSE AMP.

Reference Values

INFOID:000000003457776

TERMINAL LAYOUT

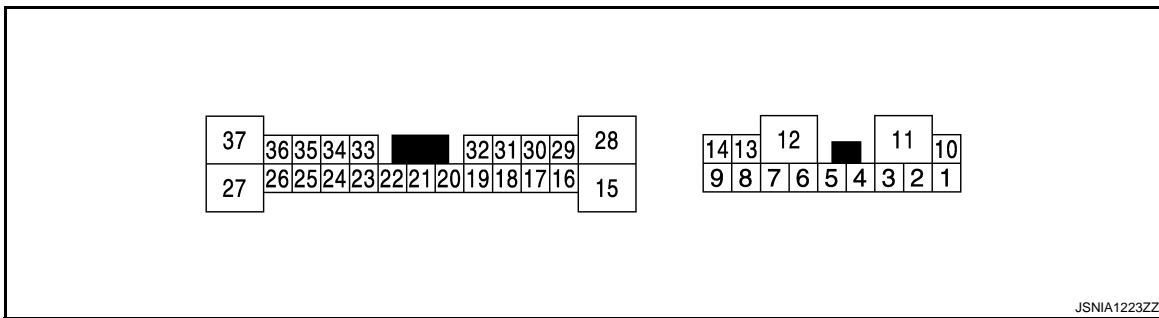

PHYSICAL VALUES

Terminal (Wire color)		Description		Condition		Reference value (Approx.)
+	-	Signal name	Input/ Output			
1 (LG)	2 (V)	Sound signal front squawker LH	Output	Ignition switch ON	Sound output.	 SKIB3609E
4 (P)	3 (L)	Sound signal front squawker RH	Output	Ignition switch ON	Sound output.	 SKIB3609E
5 (Y)	6 (BR)	Sound signal rear speaker RH	Output	Ignition switch ON	Sound output.	 SKIB3609E
7 (B)	Ground	Ground	—	Ignition switch ON	—	0 V
10 (SB)	Ground	Battery power supply	Input	Ignition switch OFF	—	Battery voltage
11 (GR)	Ground	Battery power supply	Input	Ignition switch OFF	—	Battery voltage
12 (B)	Ground	Ground	—	Ignition switch ON	—	0 V

A
B
C
D
E
F
G
H
I
J
K
L
M
O
P

AV

BOSE AMP.

< ECU DIAGNOSIS >

[BOSE AUDIO WITHOUT NAVIGATION]

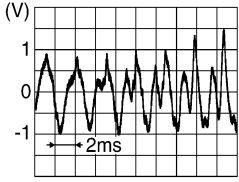
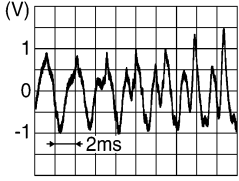
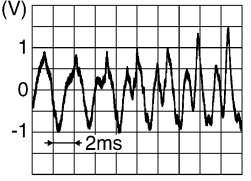
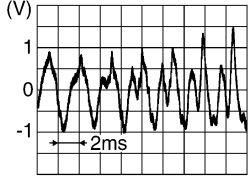
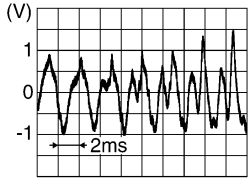
Terminal (Wire color)		Description		Condition		Reference value (Approx.)
+	-	Signal name	Input/ Output			
13 (GR)	8 (BR)	Sound signal rear speaker LH	Output	Ignition switch ON	Sound output.	 <p style="text-align: right; font-size: small;">SKIB3609E</p>
14 (L)	9 (O)	Sound signal rear door speaker RH	Output	Ignition switch ON	Sound output.	 <p style="text-align: right; font-size: small;">SKIB3609E</p>
16 (B/R)	17 (W/R)	Sound signal woofer	Output	Ignition switch ON	Sound output.	 <p style="text-align: right; font-size: small;">SKIB3609E</p>
18 (W)	19 (B)	Sound signal front door speaker LH	Output	Ignition switch ON	Sound output.	 <p style="text-align: right; font-size: small;">SKIB3609E</p>
20 (SB)	Ground	Amp. ON signal	Input	Ignition switch ACC	—	12.0 V
21	—	Shield	—	—	—	—
22 (W)	Ground	Woofer Amp. ON signal	Output	Ignition switch ACC	—	12.0 V
24 (GR/V)	23 (W/L)	Sound signal rear LH	Input	Ignition switch ON	Sound output.	 <p style="text-align: right; font-size: small;">SKIB3609E</p>

BOSE AMP.

< ECU DIAGNOSIS >

[BOSE AUDIO WITHOUT NAVIGATION]

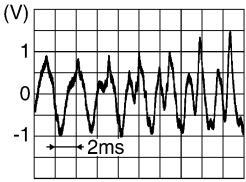
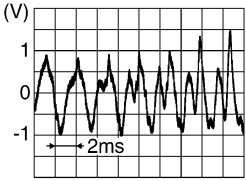
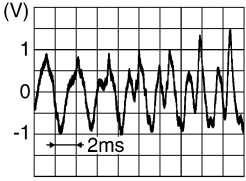
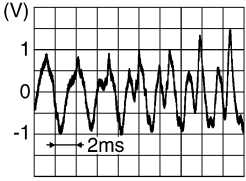
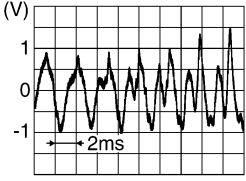
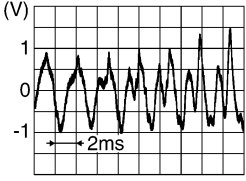
Terminal (Wire color)		Description		Condition		Reference value (Approx.)
+	-	Signal name	Input/ Output			
26 (GR/V)	25 (W/L)	Sound signal rear RH	Input	Ignition switch ON	Sound output.	 SKIB3609E
28 (G)	15 (R)	Sound signal rear door speaker LH	Output	Ignition switch ON	Sound output.	 SKIB3609E
29 (V)	30 (P)	Sound signal center speak- er	Output	Ignition switch ON	Sound output.	 SKIB3609E
31 (BR)	32 (Y)	Sound signal front door speaker RH	Output	Ignition switch ON	Sound output.	 SKIB3609E
33 (W/R)	34 (B/R)	Sound signal front RH	Input	Ignition switch ON	Sound output.	 SKIB3609E
35 (W/R)	36 (B/R)	Sound signal front LH	Input	Ignition switch ON	Sound output.	 SKIB3609E

A
B
C
D
E
F
G
H
I
J
K
L
M
AV
O
P

Wiring Diagram - BOSE AUDIO WITHOUT NAVIGATION WITHOUT DVD ENTERTAINMENT SYSTEM -

INFOID:000000003702909

NOTE:

- In this section, PRESET SWITCH and MULTIFUNCTION SWITCH are written as the MULTIFUNCTION SWITCH.

BOSE AMP.

[BOSE AUDIO WITHOUT NAVIGATION]

< ECU DIAGNOSIS >

- Type A: Up to VIN: JN8AZ18U*9W100000, JN8AZ18W*9W200000 (EXCEPT FOR MEXICO), JN8AZ18U*9W710000, JN8AZ18W*9W810000 (FOR MEXICO)
- Type B: From VIN: JN8AZ18U*9W100001, JN8AZ18W*9W200001 (EXCEPT FOR MEXICO), JN8AZ18U*9W710001, JN8AZ18W*9W810001 (FOR MEXICO)

BOSE AUDIO WITHOUT NAVIGATION WITHOUT DVD ENTERTAINMENT SYSTEM

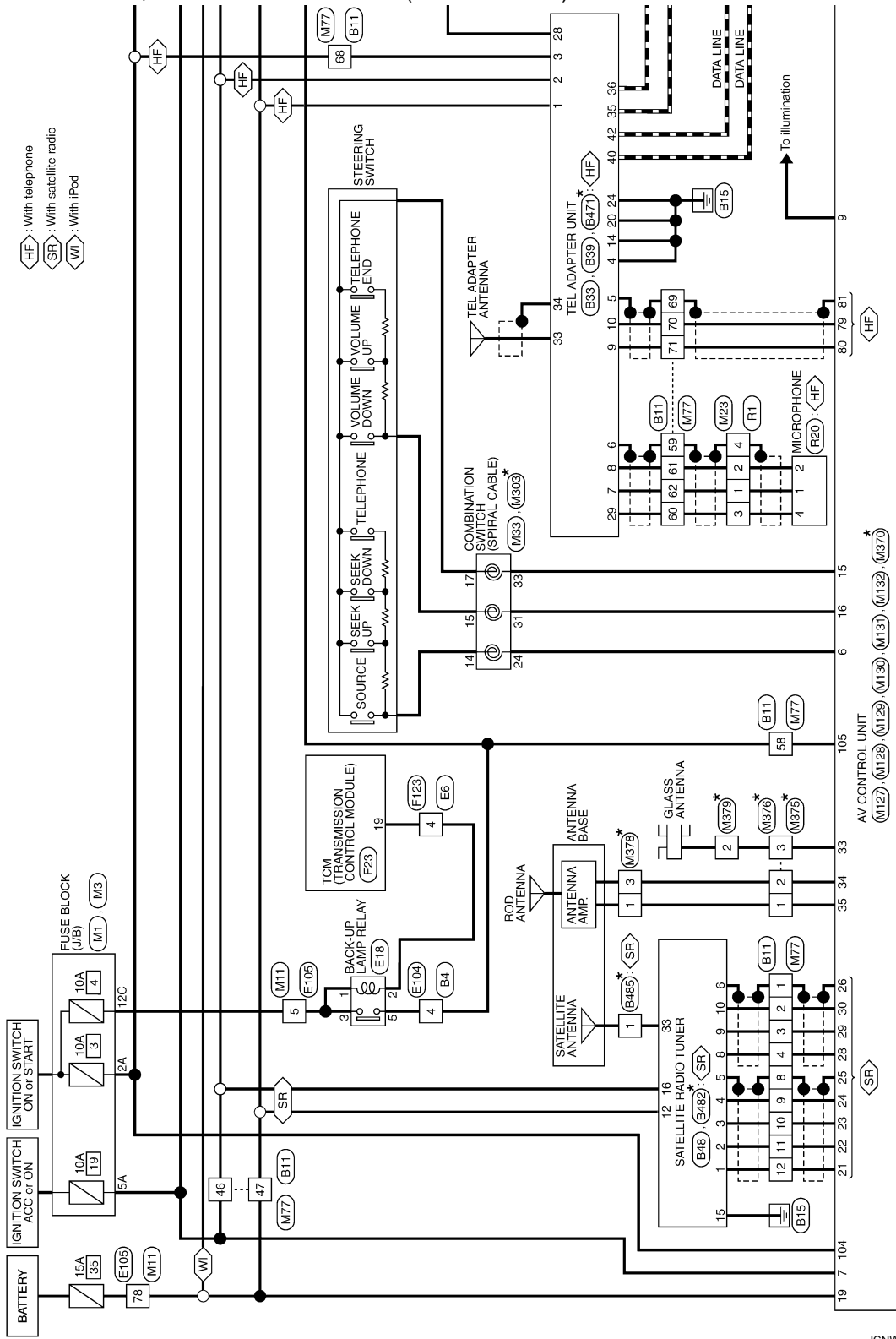

*: This connector is not shown in "Harness Layout".

2008/09/23

JCNWM1855GI

BOSE AMP.

[BOSE AUDIO WITHOUT NAVIGATION]

< ECU DIAGNOSIS >

- HF : With telephone
- OF : Without telephone
- WI : With iPod

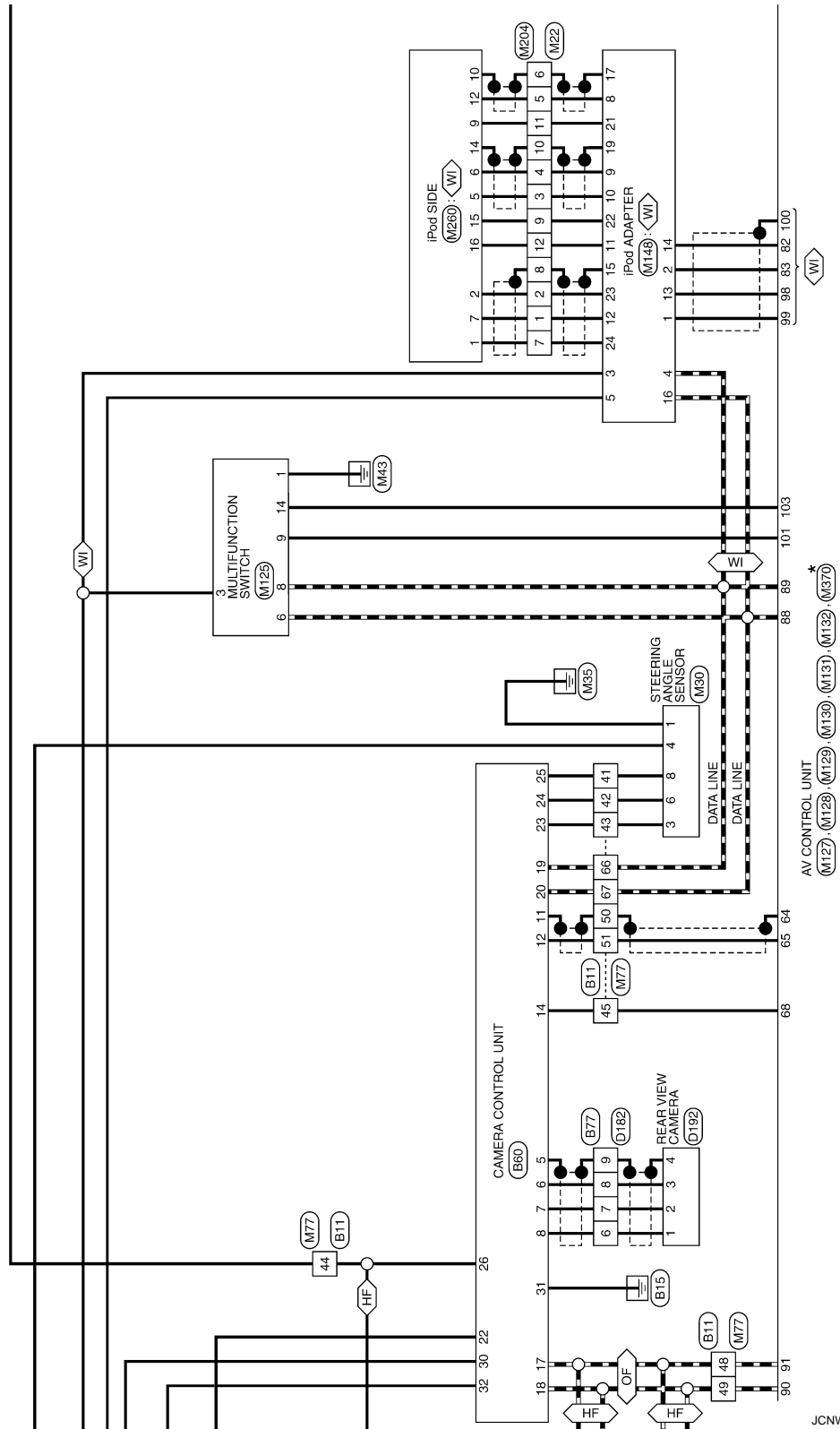

*: This connector is not shown in "Harness Layout".

JCNWM1856GI

A
B
C
D
E
F
G
H
I
J
K
L
M
N
O
P

AV

BOSE AMP.

< ECU DIAGNOSIS >

[BOSE AUDIO WITHOUT NAVIGATION]

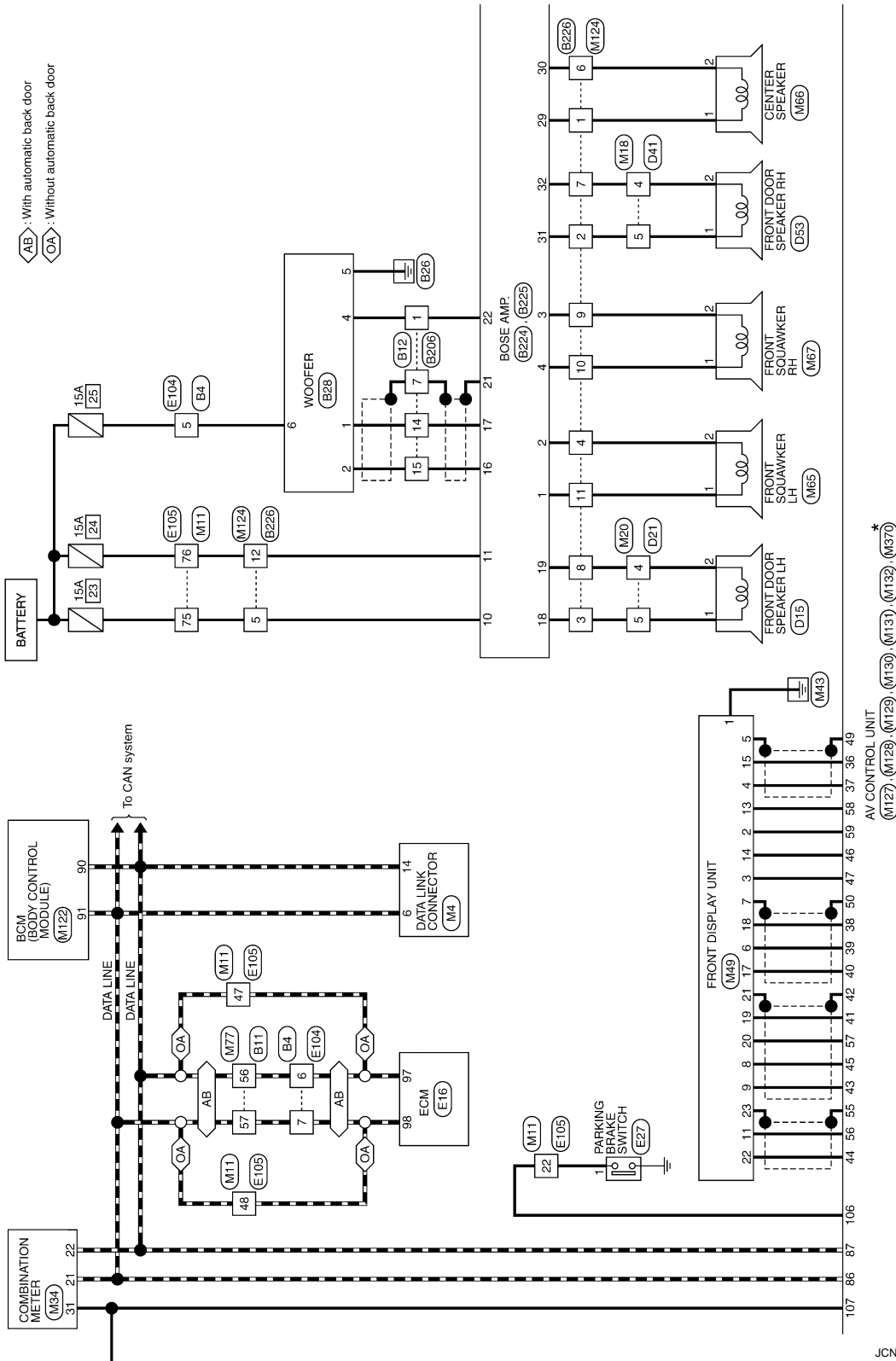

*: This connector is not shown in "Harness Layout".

JCNWM1857GI

BOSE AMP.

[BOSE AUDIO WITHOUT NAVIGATION]

< ECU DIAGNOSIS >

TA : Type A
TB : Type B

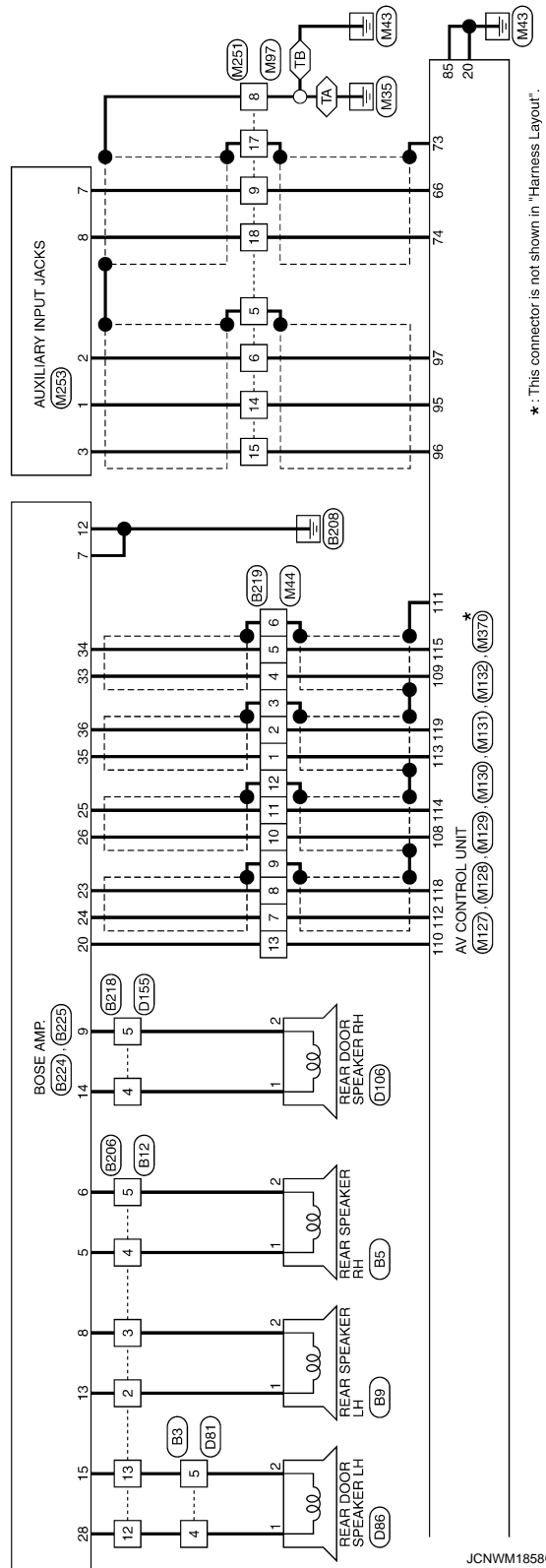

*: This connector is not shown in "Harness Layout".

JCNWM1858GI

A
B
C
D
E
F
G
H
I
J
K
L
M
AV
O
P

BOSE AUDIO WITHOUT NAVIGATION WITHOUT DVD ENTERTAINMENT SYSTEM

Connector No.	B3
Connector Name	WIRE TO WIRE
Connector Type	TK10FW-NS8



Terminal No.	Color of Wire	Signal Name [Specification]
4	LG	-
5	O	-

Connector No.	B4
Connector Name	WIRE TO WIRE
Connector Type	NS16MW-CS



Terminal No.	Color of Wire	Signal Name [Specification]
4	R	-
5	O	-
6	P	-
7	L	-

Connector No.	B5
Connector Name	REAR SPEAKER RH
Connector Type	TK2FBR

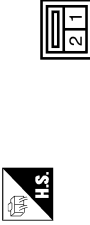

Terminal No.	Color of Wire	Signal Name [Specification]
1	V	-
2	LG	-

Connector No.	B9
Connector Name	REAR SPEAKER LH
Connector Type	TK2FBR



Terminal No.	Color of Wire	Signal Name [Specification]
1	SB	-
2	GR	-

Connector No.	B11
Connector Name	WIRE TO WIRE
Connector Type	TH80MW-CS19

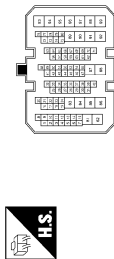

Terminal No.	Color of Wire	Signal Name [Specification]
1	SHIELD	-
2	B	-
3	R/L	-
4	R/W	-
8	SHIELD	-
9	BR/L	-
10	Y/G	-
11	Y/L	-
12	W/L	-
41	O	-
42	SB	-

43	G	-
44	BR	-
45	L	-
46	GR	-
47	V	-
48	GR	- [With rear view camera and telephone]
48	BR	- [With rear view camera without telephone]
49	Y	-
50	SHIELD	-
51	B	-
56	P	-
57	L	-
58	R	-
59	SHIELD	-
60	B	-
61	R/L	-
62	R/W	-
66	GR	-
67	G	-
68	R	-
69	SHIELD	-
70	W/R	-
71	B/R	-

Connector No.	B12
Connector Name	WIRE TO WIRE
Connector Type	NS18FW-CS

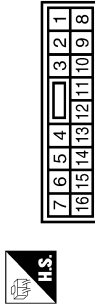

Terminal No.	Color of Wire	Signal Name [Specification]
1	W	-
2	SB	-
3	GR	-
4	V	-
5	LG	-
7	SHIELD	-
12	LG	-
13	O	-
14	W/R	-
15	B/R	-

Connector No.	B28
Connector Name	WOOFER
Connector Type	RS38FGY-PR



Terminal No.	Color of Wire	Signal Name [Specification]
1	W/R	SOUND SIGNAL WOOFER (-)
2	B/R	SOUND SIGNAL WOOFER (+)
4	W	WOOFER AMP. ON SIGNAL
5	B/W	GND
6	O	BAT

JCNWM1859GI

BOSE AUDIO WITHOUT NAVIGATION WITHOUT DVD ENTERTAINMENT SYSTEM

Connector No.	B33
Connector Name	TEL ADAPTER UNIT
Connector Type	TH88FW-NH



Terminal No.	Color of Wire	Signal Name [Specification]
35	Y	AV COMM (H)
36	BR	AV COMM (L)
40	G	AV COMM (H)
42	GR	AV COMM (L)

Connector No.	B39
Connector Name	TEL ADAPTER UNIT
Connector Type	TH32FW-NH

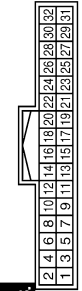

Terminal No.	Color of Wire	Signal Name [Specification]
1	V	BATTERY
2	GR	ACC
3	R	IGNITION
4	B/W	GND
5	SHIELD	SHIELD
6	SHIELD	SHIELD
7	R/W	MICROPHONE SIGNAL
8	R/L	MICROPHONE GND
9	B/R	TEL VOICE SIGNAL (+)
10	W/R	TEL VOICE SIGNAL (-)
14	B	GND

Connector No.	B48
Connector Name	SATELLITE RADIO TUNER
Connector Type	A18FW

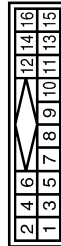

Terminal No.	Color of Wire	Signal Name [Specification]
1	W/L	SOUND SIGNAL LH (-)
2	Y/L	SOUND SIGNAL LH (+)
3	Y/G	SOUND SIGNAL RH (-)
4	BR/L	SOUND SIGNAL RH (+)
5	SHIELD	SHIELD
6	SHIELD	SHIELD
8	R/W	REQUEST (SAT->CONT)
9	R/L	COMM (SAT->CONT)
10	B	COMM (CONT->SAT)
12	V	BATTERY
15	B	GND

20	B	CONTROL SIGNAL
24	B/W	CONTROL SIGNAL
28	BR	VEHICLE SPEED (8-PULSE)
29	B	MICROPHONE VCC

Connector No.	B60
Connector Name	CAMERA CONTROL UNIT
Connector Type	TH32FW-NH

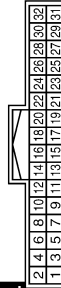

Terminal No.	Color of Wire	Signal Name [Specification]
5	SHIELD	SHIELD
6	B	CAMERA IMAGE SIGNAL
7	R/W	GND
8	R/L	CAMERA ON SIGNAL
11	SHIELD	SHIELD
12	B	CAMERA IMAGE SIGNAL
14	L	CONNECTION RECOGNITION
17	BR	AV COMM (L)
18	Y	AV COMM (H)
19	GR	AV COMM (L)
20	G	AV COMM (H)

22	R	REVERSE
23	G	SENSOR SIGNAL 1
24	SB	SENSOR SIGNAL 2
25	O	SENSOR SIGNAL 3
26	BR	VEHICLE SPEED (8-PULSE)
30	GR	ACC
31	B	GND
32	V	BATTERY

JCNWM1860GI

A
B
C
D
E
F
G
H
I
J
K
L
M
N
O
P

AV

BOSE AUDIO WITHOUT NAVIGATION WITHOUT DVD ENTERTAINMENT SYSTEM

Connector No.	B77
Connector Name	WIRE TO WIRE
Connector Type	TK12MW



Terminal No.	Color of Wire	Signal Name [Specification]
6	R/L	-
7	R/W	-
8	B	-
9	SHIELD	-

Connector No.	B219
Connector Name	WIRE TO WIRE
Connector Type	TH82MW-NH



Terminal No.	Color of Wire	Signal Name [Specification]
1	W/R	-
2	B/R	-
3	SHIELD	-
4	W/R	-
5	B/R	-
6	SHIELD	-
7	GR/V	-
8	W/L	-
9	SHIELD	-
10	GR/V	-
11	W/L	-

Connector No.	B706
Connector Name	WIRE TO WIRE
Connector Type	NS16MW-CS



Terminal No.	Color of Wire	Signal Name [Specification]
1	W	-
2	GR	-
3	BR	-
4	Y	-
5	BR	-
7	SHIELD	-
12	G	-
13	R	-
14	W/R	-
15	B/R	-

Terminal No.	12	SHIELD	-
Terminal No.	13	SB	-

Connector No.	B218
Connector Name	WIRE TO WIRE
Connector Type	TK10FW-NSB



Terminal No.	Color of Wire	Signal Name [Specification]
4	L	- [With BOSE system]
5	O	- [With BOSE system]

Connector No.	B224
Connector Name	BOSE AMP.
Connector Type	SGA12FBR-SJA2

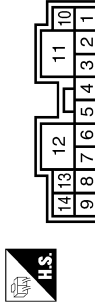

Terminal No.	Color of Wire	Signal Name [Specification]
1	LG	SOUND SIGNAL FRONT SQUAWKER LH (+)
2	V	SOUND SIGNAL FRONT SQUAWKER LH (-)
3	L	SOUND SIGNAL FRONT SQUAWKER RH (-)
4	P	SOUND SIGNAL FRONT SQUAWKER RH (+)
5	Y	SOUND SIGNAL REAR SPEAKER RH (+)
6	BR	SOUND SIGNAL REAR SPEAKER RH (-)
7	B	GND
8	BR	SOUND SIGNAL REAR SPEAKER LH (-)
9	O	SOUND SIGNAL REAR DOOR SPEAKER RH (-)
10	SB	BATTERY
11	GR	BATTERY

Terminal No.	12	B	GND
Terminal No.	13	GR	SOUND SIGNAL REAR DOOR SPEAKER LH (+)
Terminal No.	14	L	SOUND SIGNAL REAR DOOR SPEAKER RH (+)

JCNW1861G1

BOSE AMP.

< ECU DIAGNOSIS >

[BOSE AUDIO WITHOUT NAVIGATION]

BOSE AUDIO WITHOUT NAVIGATION WITHOUT DVD ENTERTAINMENT SYSTEM

Connector No.	B225
Connector Name	BOSE AMP.
Connector Type	SCA1PBR-SGA4

37	36	35	34	33	32	31	30	29	28			
27	26	25	24	23	22	21	20	19	18	17	16	15

Terminal No.	Color of Wire	Signal Name [Specification]
15	R	SOUND SIGNAL REAR DOOR SPEAKER LH (-)
16	B/R	SOUND SIGNAL REAR DOOR SPEAKER LH (+)
17	W/R	SOUND SIGNAL WOOFER (+)
18	W	SOUND SIGNAL FRONT DOOR SPEAKER LH (+)
18	B	SOUND SIGNAL FRONT DOOR SPEAKER LH (-)
20	SB	AMP ON SIGNAL
21	SHIELD	SHIELD
22	W	WOOFER AMP-ON SIGNAL
23	W/L	SOUND SIGNAL REAR LH (-)
24	GR/V	SOUND SIGNAL REAR LH (+)
25	W/L	SOUND SIGNAL REAR RH (-)

Connector No.	B471
Connector Name	TEL ADAPTER UNIT
Connector Type	GT1BC-1S-HU

33	34
33	34

Terminal No.	Color of Wire	Signal Name [Specification]
33	-	TEL ANTENNA
34	SHIELD	SHIELD

26	GR/V	SOUND SIGNAL REAR RH (+)
28	G	SOUND SIGNAL REAR DOOR SPEAKER LH (+)
29	V	SOUND SIGNAL CENTER SPEAKER (+)
30	P	SOUND SIGNAL CENTER SPEAKER (-)
31	BR	SOUND SIGNAL FRONT DOOR SPEAKER RH (+)
32	Y	SOUND SIGNAL FRONT DOOR SPEAKER RH (-)
33	W/R	SOUND SIGNAL FRONT RH (+)
34	B/R	SOUND SIGNAL FRONT LH (+)
35	W/R	SOUND SIGNAL FRONT LH (-)
36	B/R	SOUND SIGNAL FRONT LH (-)

1	2	3	4	5		
6	7	8	9	10	11	12

Terminal No.	Color of Wire	Signal Name [Specification]
1	V	-
2	BR	-
3	W	-
4	V	-
5	SB	-
8	P	-
7	Y	-
8	B	-
9	L	-
10	P	-
11	LG	-

Connector No.	B485
Connector Name	ANTENNA BASE (SATELLITE ANTENNA) (WITH BOSE SYSTEM WITHOUT NAVIGATION SYSTEM)
Connector Type	GT1BC-1PP-HU

1	2
1	2

Terminal No.	Color of Wire	Signal Name [Specification]
1	-	SATELLITE ANTENNA

12	GR	-
----	----	---

Connector No.	D15
Connector Name	FRONT DOOR SPEAKER LH (WITH BOSE SYSTEM)
Connector Type	NS02FBR-CS

2	1
2	1

Terminal No.	Color of Wire	Signal Name [Specification]
1	L	-[Type A]
1	W	-[Type B]
2	B/W	-[Type A]
2	B	-[Type B]

JCNWM1862GI

A
B
C
D
E
F
G
H
I
J
K
L
M
O
P

AV

BOSE AUDIO WITHOUT NAVIGATION WITHOUT DVD ENTERTAINMENT SYSTEM

Connector No.	D81
Connector Name	WIRE TO WIRE
Connector Type	TK10MW-NS8



Terminal No.	Color of Wire	Signal Name [Specification]
4	L	-
5	W	-

Connector No.	D53
Connector Name	FRONT DOOR SPEAKER RH (WITH BOSE SYSTEM)
Connector Type	NS02FBR-CS



Terminal No.	Color of Wire	Signal Name [Specification]
1	BR	-[Type A]
2	W	-[Type B]

Connector No.	D41
Connector Name	WIRE TO WIRE
Connector Type	TH40FW-CS15

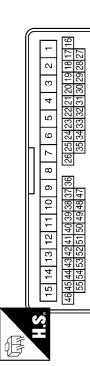

Terminal No.	Color of Wire	Signal Name [Specification]
4	B/R	-[Type A]
4	B	-[Type B]
5	BR	-[Type A]
5	W	-[Type B]

Connector No.	D21
Connector Name	WIRE TO WIRE
Connector Type	TH40FW-CS15

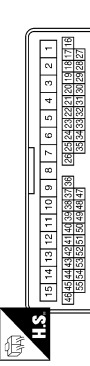

Terminal No.	Color of Wire	Signal Name [Specification]
4	B/W	-[Type A]
4	B	-[Type B]
5	L	-[Type A]
5	W	-[Type B]

Connector No.	D182
Connector Name	WIRE TO WIRE
Connector Type	TK12ZFV

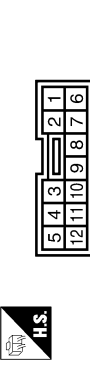

Terminal No.	Color of Wire	Signal Name [Specification]
6	R	-
7	G	-
8	B	-
9	SHIELD	-

Connector No.	D155
Connector Name	WIRE TO WIRE
Connector Type	TK10MW-NS8



Terminal No.	Color of Wire	Signal Name [Specification]
4	O	-[Type A]
4	L	-[Type B]
5	B/P	-[Type A]
5	W	-[Type B]

Connector No.	D106
Connector Name	REAR DOOR SPEAKER RH (WITH BOSE SYSTEM)
Connector Type	NS02FBR-CS



Terminal No.	Color of Wire	Signal Name [Specification]
1	O	-[Type A]
1	L	-[Type B]
2	B/P	-[Type A]
2	W	-[Type B]

Connector No.	D86
Connector Name	REAR DOOR SPEAKER LH (WITH BOSE SYSTEM)
Connector Type	NS02FBR-CS



Terminal No.	Color of Wire	Signal Name [Specification]
1	L	-
2	W	-

JCNWM1863GI

BOSE AUDIO WITHOUT NAVIGATION WITHOUT DVD ENTERTAINMENT SYSTEM

Connector No.	D132
Connector Name	REAR VIEW CAMERA
Connector Type	TH04MW-NH



Terminal No.	Color of Wire	Signal Name [Specification]
1	R	CAMERA ON SIGNAL
2	G	GND
3	B	CAMERA IMAGE SIGNAL
4	SHIELD	SHIELD

Connector No.	E6
Connector Name	WIRE TO WIRE
Connector Type	TK18MGY-1V

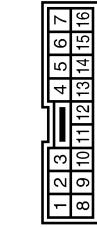

Terminal No.	Color of Wire	Signal Name [Specification]
4	R	-

Connector No.	E16
Connector Name	ECM
Connector Type	RI124FB-R2B-L-LH

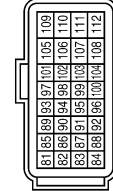

Terminal No.	Color of Wire	Signal Name [Specification]
97	P	VEHCAN-L
98	L	VEHCAN-H

Connector No.	E18
Connector Name	BACK-UP LAMP RELAY
Connector Type	MS02FL-M2-LC

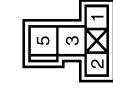

Terminal No.	Color of Wire	Signal Name [Specification]
1	LG	-
2	R	-
3	LG	-
5	R	-

Connector No.	E27
Connector Name	PARKING BRAKE SWITCH
Connector Type	P01FE-A



Terminal No.	Color of Wire	Signal Name [Specification]
1	P	-

Connector No.	E104
Connector Name	WIRE TO WIRE
Connector Type	NS16FW-CS

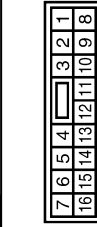

Terminal No.	Color of Wire	Signal Name [Specification]
4	R	-
5	L	-
6	P	-
7	L	-

Connector No.	E105
Connector Name	WIRE TO WIRE
Connector Type	TH10MW-CS10-M3

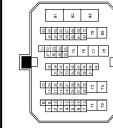

Terminal No.	Color of Wire	Signal Name [Specification]
5	LG	-
22	P	-
47	P	-
48	L	-
75	BR	-
76	GR	-
78	V	-

Connector No.	F23
Connector Name	TOM (TRANSMISSION CONTROL MODULE)
Connector Type	RH40FB-R2B-L-RH

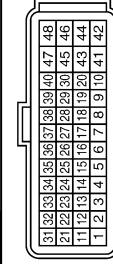

Terminal No.	Color of Wire	Signal Name [Specification]
19	G/B	REV LAMP RELAY

A
B
C
D
E
F
G
H
I
J
K
L
M
AV
O
P

BOSE AUDIO WITHOUT NAVIGATION WITHOUT DVD ENTERTAINMENT SYSTEM

Connector No.	F123
Connector Name	WIRE TO WIRE
Connector Type	TK16GY-IV

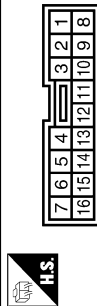

Terminal No.	Color of Wire	Signal Name [Specification]
4	G/B	-

Connector No.	M1
Connector Name	FUSE BLOCK (J/B)
Connector Type	NS0FW-M2



Terminal No.	Color of Wire	Signal Name [Specification]
2A	G	-
5A	R	-

Connector No.	M3
Connector Name	FUSE BLOCK (J/B)
Connector Type	NS12FW-CS

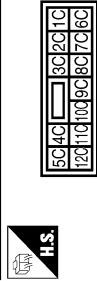

Terminal No.	Color of Wire	Signal Name [Specification]
12C	O	-

Connector No.	M4
Connector Name	DATA LINK CONNECTOR
Connector Type	BD16FW

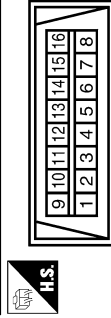

Terminal No.	Color of Wire	Signal Name [Specification]
6	L	-
14	P	-

Connector No.	M11
Connector Name	WIRE TO WIRE
Connector Type	TH10FW-CS10-M3

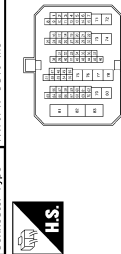

Terminal No.	Color of Wire	Signal Name [Specification]
5	O	-
22	G	-
47	P	-
48	L	-
75	BR	-
76	R	-
78	Y	-

Connector No.	M18
Connector Name	WIRE TO WIRE
Connector Type	TH40MW-CS15

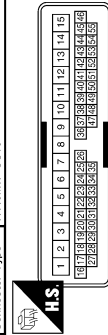

Terminal No.	Color of Wire	Signal Name [Specification]
4	W	-
5	BR	- [Type A and without BOSE system type B]
5	B	- [With BOSE system type B]

Connector No.	M20
Connector Name	WIRE TO WIRE
Connector Type	TH40MW-CS15

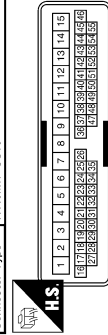

Terminal No.	Color of Wire	Signal Name [Specification]
4	B	-
5	L	-

BOSE AUDIO WITHOUT NAVIGATION WITHOUT DVD ENTERTAINMENT SYSTEM

Connector No.	M22
Connector Name	WIRE TO WIRE
Connector Type	TH12FW-NH

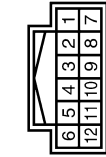

Terminal No.	Color of Wire	Signal Name [Specification]
1	V	-
2	R	-
3	R	-
4	G	-
5	W	-
6	SHIELD	-
7	LG	-
8	SHIELD	-
9	BR	-
10	SHIELD	-
11	L	-

Connector No.	M33
Connector Name	COMBINATION SWITCH (SPIRAL CABLE)
Connector Type	TK08FGY-IV

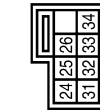

Terminal No.	Color of Wire	Signal Name [Specification]
24	BR	- [With audio steering switch and telephone]
31	G	- [With audio steering switch and telephone]
33	L	- [With audio steering switch and telephone]

12	R
----	---

Connector No.	M23
Connector Name	WIRE TO WIRE
Connector Type	TH18MW-NH

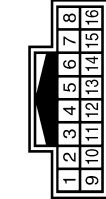

Terminal No.	Color of Wire	Signal Name [Specification]
1	W	-
2	R	- [With telephone without navigation system]
3	B	-
4	SHIELD	-

Connector No.	M34
Connector Name	COMBINATION METER
Connector Type	TH40FW-NH

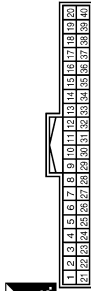

Terminal No.	Color of Wire	Signal Name [Specification]
21	L	CAN-H
22	P	CAN-L
31	V	VEHICLE SPEED (8-PULSE)

Connector No.	M30
Connector Name	STEERING ANGLE SENSOR
Connector Type	TH08FW-NH

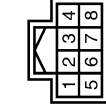

Terminal No.	Color of Wire	Signal Name [Specification]
1	B	-
3	L	-
4	G	-
6	SB	-
8	O	-

Connector No.	M44
Connector Name	WIRE TO WIRE
Connector Type	TH32FW-NH

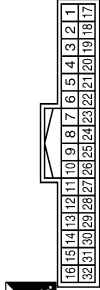

Terminal No.	Color of Wire	Signal Name [Specification]
1	G	-
2	R	-
3	SHIELD	-
4	B	-
5	W	-
6	SHIELD	-
7	O	- [Type A]
7	L	- [Type B]
8	SB	- [Type A]
8	R	- [Type B]
9	SHIELD	-

A
B
C
D
E
F
G
H
I
J
K
L
M
AV
O
P

BOSE AUDIO WITHOUT NAVIGATION WITHOUT DVD ENTERTAINMENT SYSTEM

Connector No.	M49
Connector Name	FRONT DISPLAY UNIT
Connector Type	TH24FW-NH

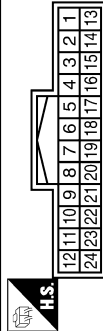

Terminal No.	Color of Wire	Signal Name [Specification]
1	B	GND
2	Y	INVERTER VCC1[Without navigation system]
3	O	SIGNAL VCC1[Without navigation system]
4	P	COMPOSITE IMAGE GND[Without navigation system]
5	SHIELD	SHIELD[Without navigation system]
6	L	RGB (GREEN) SIGNAL [Without navigation system]
7	SHIELD	SHIELD
8	G	HP[Without navigation system]
9	W	RGB AREA (YS) SIGNAL
11	R	COMM (CONT->DISP)
13	BR	INVERTER GND[Without navigation system]

Connector No.	M67
Connector Name	FRONT SQUAWKER RH
Connector Type	TK02FBR

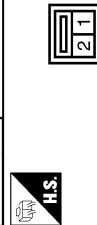

Terminal No.	Color of Wire	Signal Name [Specification]
1	BR	-
2	R	-[With BOSE system]

14	LG	SIGNAL GND[Without navigation system]
15	L	COMPOSITE IMAGE SIGNAL [Without navigation system]
17	G	RGB (RED) SIGNAL
18	Y	RGB (BLUE) SIGNAL [Without navigation system]
19	B	RGB SYNC
20	R	VP
21	SHIELD	SHIELD
22	G	COMM (DISP->CONT)
23	SHIELD	SHIELD

Terminal No.	Color of Wire	Signal Name [Specification]
1	LG	-[With BOSE system]
2	Y	-[With BOSE system]

Connector No.	M77
Connector Name	WIRE TO WIRE
Connector Type	TH80FW-CS19

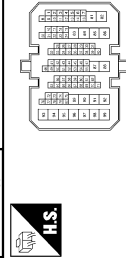

Terminal No.	Color of Wire	Signal Name [Specification]
1	SHIELD	-
2	B	-
3	W	-
4	R	-
8	SHIELD	-
9	W	-
10	R	-
11	G	-
12	B	-
41	O	-
42	SB	-

Connector No.	M65
Connector Name	FRONT SQUAWKER LH
Connector Type	TK02FBR



Terminal No.	Color of Wire	Signal Name [Specification]
1	LG	-[With BOSE system]
2	Y	-[With BOSE system]

Connector No.	M97
Connector Name	WIRE TO WIRE
Connector Type	TH18FW-CS2

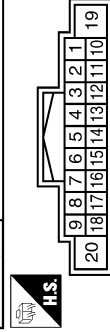

Terminal No.	Color of Wire	Signal Name [Specification]
5	SHIELD	-
6	W	-
8	B	-
9	Y	-
14	R	-
15	B	-
17	SHIELD	-
18	B	-[Type A and With navigation system type B]
18	BR	-[Without navigation system type B]

Connector No.	M66
Connector Name	CENTER SPEAKER
Connector Type	TK02FBR



Terminal No.	Color of Wire	Signal Name [Specification]
1	P	-
2	O	-

BOSE AUDIO WITHOUT NAVIGATION WITHOUT DVD ENTERTAINMENT SYSTEM

Connector No.	M122
Connector Name	BCM (BODY CONTROL MODULE)
Connector Type	TH40FB-NH

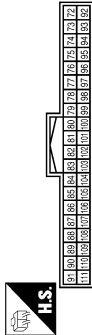

Connector No.	M124
Connector Name	WIRE TO WIRE
Connector Type	NS12FER-CS

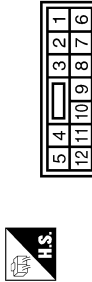

11	12
LG	R

Connector No.	M125
Connector Name	MULTIFUNCTION SWITCH
Connector Type	TH18FW-NH

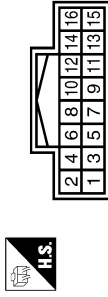

Terminal No.	Color of Wire	Signal Name [Specification]
90	P	CAN-L
91	L	CAN-H

Terminal No.	Color of Wire	Signal Name [Specification]
1	P	-
2	BR	- [Type A]
3	B	- [Type B]
4	L	-
5	Y	-
6	BR	-
7	W	-
8	B	-
9	R	-
10	BR	-

Terminal No.	Color of Wire	Signal Name [Specification]
1	B	GND
3	R	ACC
6	R	AV COMM (H)
8	L	AV COMM (L)
9	Y	SW GND
14	W	EJECT SIGNAL

Connector No.	M127
Connector Name	AV CONTROL UNIT (WITH BOSE SYSTEM WITHOUT NAVIGATION SYSTEM)
Connector Type	TH18FW-CS2



Connector No.	M128
Connector Name	AV CONTROL UNIT (WITH BOSE SYSTEM WITHOUT NAVIGATION SYSTEM)
Connector Type	A12FW

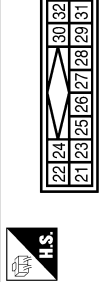

Connector No.	M129
Connector Name	AV CONTROL UNIT (WITH BOSE SYSTEM WITHOUT NAVIGATION SYSTEM)
Connector Type	TH24FW-NH

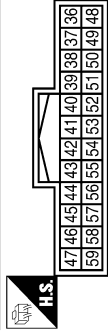

Terminal No.	Color of Wire	Signal Name [Specification]
47	O	SIGNAL VCC
49	SHIELD	SHIELD
50	SHIELD	SHIELD
55	SHIELD	SHIELD
56	R	COMM (CONT->DISP)
57	R	VP
58	BR	INVERTER GND
59	Y	INVERTER VCC

Terminal No.	Color of Wire	Signal Name [Specification]
6	BR	STRG SW A
7	R	ACC
9	R	ILLUMINATION
15	L	STRG SW GND
16	G	STRG SW B
19	Y	BATTERY
20	B	GND

Terminal No.	Color of Wire	Signal Name [Specification]
21	B	SATELLITE RADIO SOUND SIGNAL LH (-)
22	G	SATELLITE RADIO SOUND SIGNAL LH (+)
23	R	SATELLITE RADIO SOUND SIGNAL RH (-)
24	W	SATELLITE RADIO SOUND SIGNAL RH (+)
25	SHIELD	SHIELD
26	SHIELD	SHIELD
28	R	REQUEST (SAT->CONT)
29	W	COMM (SAT->CONT)
30	B	COMM (CONT->SAT)

Terminal No.	Color of Wire	Signal Name [Specification]
36	L	COMPOSITE IMAGE SIGNAL
37	P	COMPOSITE IMAGE GND
38	Y	RGB (B/BLUE) SIGNAL
39	L	RGB (G/GREEN) SIGNAL
40	G	RGB (R/RED) SIGNAL
41	B	RGB SYNC
42	SHIELD	SHIELD
43	W	RGB AREA (YS) SIGNAL
44	G	COMM (DISP->CONT)
45	G	HP
46	LG	SIGNAL GND

A B C D E F G H I J K L M N O P

AV

BOSE AUDIO WITHOUT NAVIGATION WITHOUT DVD ENTERTAINMENT SYSTEM

Connector No.	M130
Connector Name	AV CONTROL UNIT (WITH BOSE SYSTEM WITHOUT NAVIGATION SYSTEM)
Connector Type	TH16FW-NH



Terminal No.	Color of Wire	Signal Name [Specification]
64	SHIELD	SHIELD
65	W	CAMERA IMAGE SIGNAL
66	Y	AUX IMAGE SIGNAL [Without DVD player]
68	P	CONNECTION RECOGNITION
73	SHIELD	SHIELD [Without DVD player]
74	B	AUX IMAGE GND [Without DVD player (type A)]
74	BR	AUX IMAGE GND [Without DVD player (type B)]

Connector No.	M132
Connector Name	AV CONTROL UNIT (WITH BOSE SYSTEM WITHOUT NAVIGATION SYSTEM)
Connector Type	TH12FW-NH



Terminal No.	Color of Wire	Signal Name [Specification]
108	V	SOUND SIGNAL REAR RH (+)
109	B	SOUND SIGNAL FRONT RH (+)
110	P	AMP ON SIGNAL
111	SHIELD	SHIELD
112	O	SOUND SIGNAL REAR LH (+) [Type A]
112	L	SOUND SIGNAL REAR LH (+) [Type B]
113	G	SOUND SIGNAL FRONT LH (+)
114	LG	SOUND SIGNAL REAR RH (-)
115	W	SOUND SIGNAL FRONT RH (-)
118	SR	SOUND SIGNAL REAR LH (-) [Type A]
118	R	SOUND SIGNAL REAR LH (-) [Type B]

Connector No.	M131
Connector Name	AV CONTROL UNIT (WITH BOSE SYSTEM WITH NAVIGATION SYSTEM)
Connector Type	TH24FW-NH

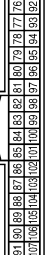

Terminal No.	Color of Wire	Signal Name [Specification]
79	L	TEL VOICE SIGNAL (-)
80	R	TEL VOICE SIGNAL (+)
81	SHIELD	SHIELD
82	W	iPod SOUND SIGNAL RH (-) [Without DVD player]
83	R	iPod SOUND SIGNAL RH (+) [Without DVD player]
85	B	GND
86	L	CAN-H
87	P	CAN-L
88	R	AV COMM (H)
89	L	AV COMM (L)
90	G	AV COMM (H)

Terminal No.	119	R	SOUND SIGNAL FRONT LH (-)
--------------	-----	---	---------------------------

91	L	AV COMM (L)
95	R	AUX SOUND SIGNAL RH (+)
96	B	AUX SOUND SIGNAL LH (+)
97	W	AUX SOUND SIGNAL GND
98	L	iPod SOUND SIGNAL LH (-) [Without DVD player]
99	BR	iPod SOUND SIGNAL LH (+) [Without DVD player]
100	SHIELD	SHIELD [Without DVD player]
101	V	SW GND
103	W	EJECT SIGNAL
104	G	IGNITION
105	SB	REVERSE
106	G	PARKING BRAKE
107	V	VEHICLE SPEED (8-PULSE)

Connector No.	M148
Connector Name	iPod ADAPTER
Connector Type	TH24FW-NH



Terminal No.	Color of Wire	Signal Name [Specification]
1	BR	iPod SOUND SIGNAL LH (+)
2	R	iPod SOUND SIGNAL RH (+)
3	R	ACC
4	L	AV COMM (L)
5	Y	BATTERY
8	W	CHARGE POWER
9	G	COMM (iPod ADAPTER->iPod)
10	R	COMM (iPod->iPod ADAPTER)
11	R	ACCESSORY IDENTIFY
12	V	iPod SOUND SIGNAL RH (+)
13	L	iPod SOUND SIGNAL LH (-)

14	W	iPod SOUND SIGNAL RH (-)
15	SHIELD	SHIELD
16	R	AV COMM (H)
17	SHIELD	GND
19	SHIELD	SHIELD
21	L	iPod CONNECTION RECOGNITION
22	BR	ACCESSORY DETECT
23	R	iPod SOUND SIGNAL GND
24	LG	iPod SOUND SIGNAL LH (+)

BOSE AMP.

[BOSE AUDIO WITHOUT NAVIGATION]

< ECU DIAGNOSIS >

BOSE AUDIO WITHOUT NAVIGATION WITHOUT DVD ENTERTAINMENT SYSTEM

Connector No.	M253
Connector Name	AUXILIARY INPUT JACKS
Connector Type	A08FW



Terminal No.	Color of Wire	Signal Name [Specification]
1	R	SOUND SIGNAL RH (+)
2	W	SOUND SIGNAL GND
3	B	SOUND SIGNAL LH (-) [Without DVD player]
7	G	AUX IMAGE SIGNAL
8	R	AUX IMAGE GND [Without DVD player]

Connector No.	M251
Connector Name	WIRE TO WIRE
Connector Type	TH1BMW-CS2



Terminal No.	Color of Wire	Signal Name [Specification]
5	SHIELD	-
6	W	-
8	SHIELD	-
9	G	-
14	R	-
15	B	-
17	SHIELD	-
18	R	-

12	R	-
----	---	---

Connector No.	M204
Connector Name	WIRE TO WIRE
Connector Type	TH12MW-NH

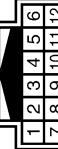

Terminal No.	Color of Wire	Signal Name [Specification]
1	V	-
2	R	-
3	R	-
4	G	-
5	W	-
6	SHIELD	-
7	LG	-
8	SHIELD	-
9	BR	-
10	SHIELD	-
11	L	-

Connector No.	M275
Connector Name	WIRE TO WIRE
Connector Type	GT13SH-2/1S-HU

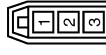

Terminal No.	Color of Wire	Signal Name [Specification]
1	-	-
2	-	-
3	-	-

Connector No.	M370
Connector Name	AV CONTROL UNIT (WITH BOSE SYSTEM WITHOUT NAVIGATION SYSTEM)
Connector Type	GT135C-2/1S-HU



Terminal No.	Color of Wire	Signal Name [Specification]
33	-	FM SUB
34	-	AM-FM MAIN
35	-	ANTENNA AMP. ON SIGNAL

Connector No.	M303
Connector Name	COMBINATION SWITCH (SPIRAL CABLE)
Connector Type	TK08FGY



Terminal No.	Color of Wire	Signal Name [Specification]
14	-	-
15	-	-
17	-	-

Connector No.	M260
Connector Name	iPod SIDE
Connector Type	IP18FGY



Terminal No.	Color of Wire	Signal Name [Specification]
1	LG	iPod SOUND SIGNAL LH (+)
2	R	iPod SOUND SIGNAL GND
5	R	COMM (iPod->iPod ADAPTER)
6	G	COMM (iPod ADAPTER->iPod)
7	V	iPod SOUND SIGNAL RH (+)
9	L	iPod CONNECTION RECOGNITION GND
10	SHIELD	CHARGE POWER
12	W	SHIELD
14	SHIELD	ACCESSORY DETECT
15	BR	ACCESSORY DETECT
16	R	ACCESSORY IDENTITY

JCNWM1870GI

A
B
C
D
E
F
G
H
I
J
K
L
M
N
O
P

AV

BOSE AUDIO WITHOUT NAVIGATION WITHOUT DVD ENTERTAINMENT SYSTEM

Connector No.	M376
Connector Name	WIRE TO WIRE
Connector Type	GT13SCW-2/1PP-HU

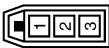

Terminal No.	Color of Wire	Signal Name [Specification]
1	-	-
2	-	-
3	-	-

Connector No.	M378
Connector Name	ANTENNA BASE (ANTENNA AMP.)
Connector Type	GT13SSN-1/1PP-HU

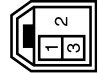

Terminal No.	Color of Wire	Signal Name [Specification]
1	-	-
3	-	-

Connector No.	M379
Connector Name	GLASS ANTENNA
Connector Type	GT13SSN-1/1PP-HU

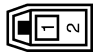

Terminal No.	Color of Wire	Signal Name [Specification]
2	-	FM SUB

Connector No.	R1
Connector Name	WIRE TO WIRE
Connector Type	TH16FW-NH

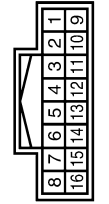

Terminal No.	Color of Wire	Signal Name [Specification]
1	R/W	-
2	R/L	- [With telephones without navigation system]
3	B	-
4	SHIELD	-

Connector No.	R20
Connector Name	MICROPHONE
Connector Type	TK04FW



Terminal No.	Color of Wire	Signal Name [Specification]
1	R/W	MICROPHONE SIGNAL (+)
2	R/L	MICROPHONE SIGNAL (-) [With telephones without navigation system]
4	B	MICROPHONE POWER

JCNWM1871GI

Wiring Diagram - BOSE AUDIO WITHOUT NAVIGATION WITH DVD ENTERTAINMENT SYSTEM -

INFOID:000000003702910

NOTE:

BOSE AMP.

[BOSE AUDIO WITHOUT NAVIGATION]

< ECU DIAGNOSIS >

In this section, PRESET SWITCH and MULTIFUNCTION SWITCH are written as the MULTIFUNCTION SWITCH.

BOSE AUDIO WITHOUT NAVIGATION WITH DVD ENTERTAINMENT SYSTEM

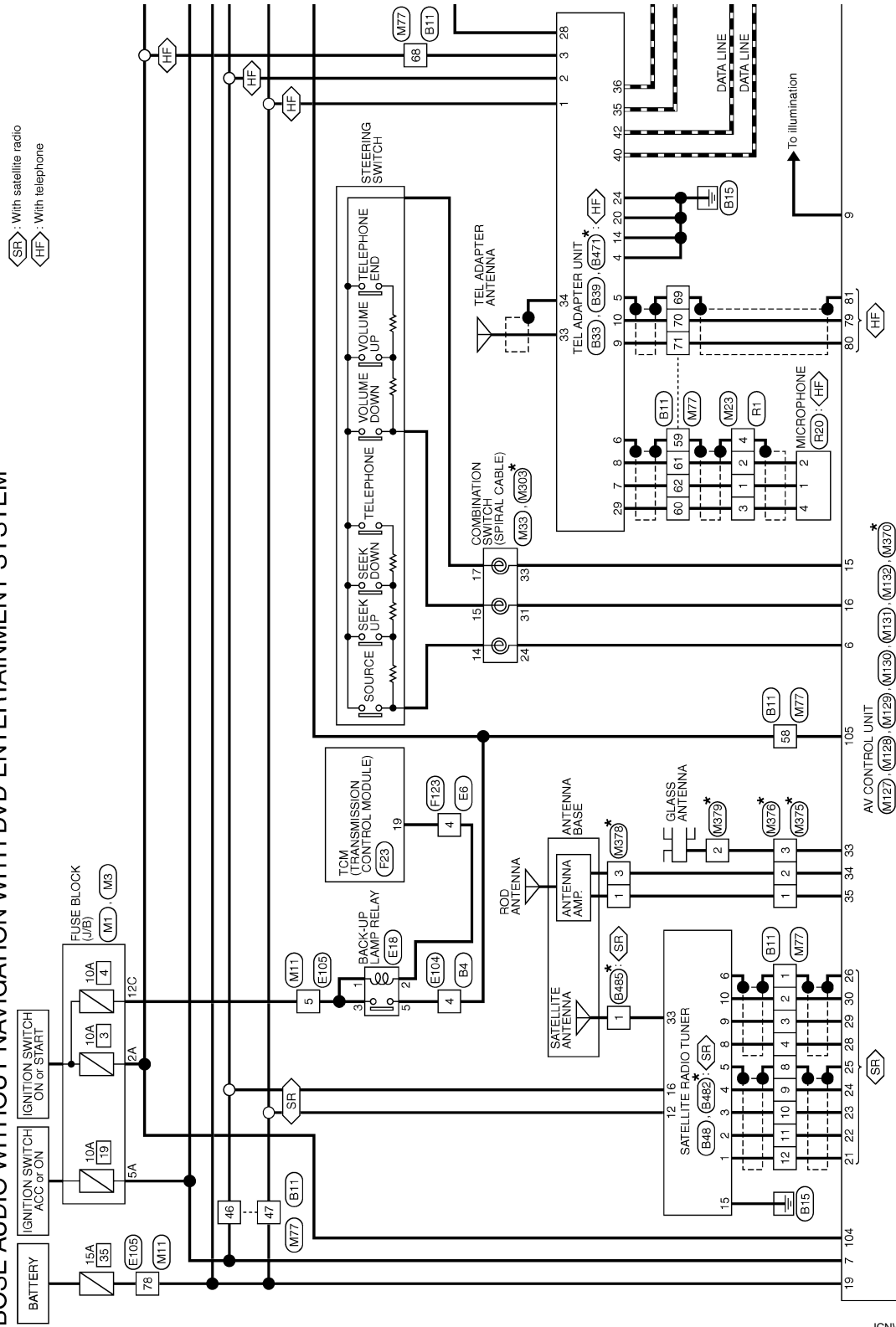

2008/09/23

JCNWM1872GI

A
B
C
D
E
F
G
H
I
J
K
L
M
N
O
P

AV

BOSE AMP.

< ECU DIAGNOSIS >

[BOSE AUDIO WITHOUT NAVIGATION]

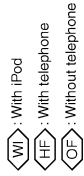

 WI : With iPod
 HF : With telephone
 OF : Without telephone

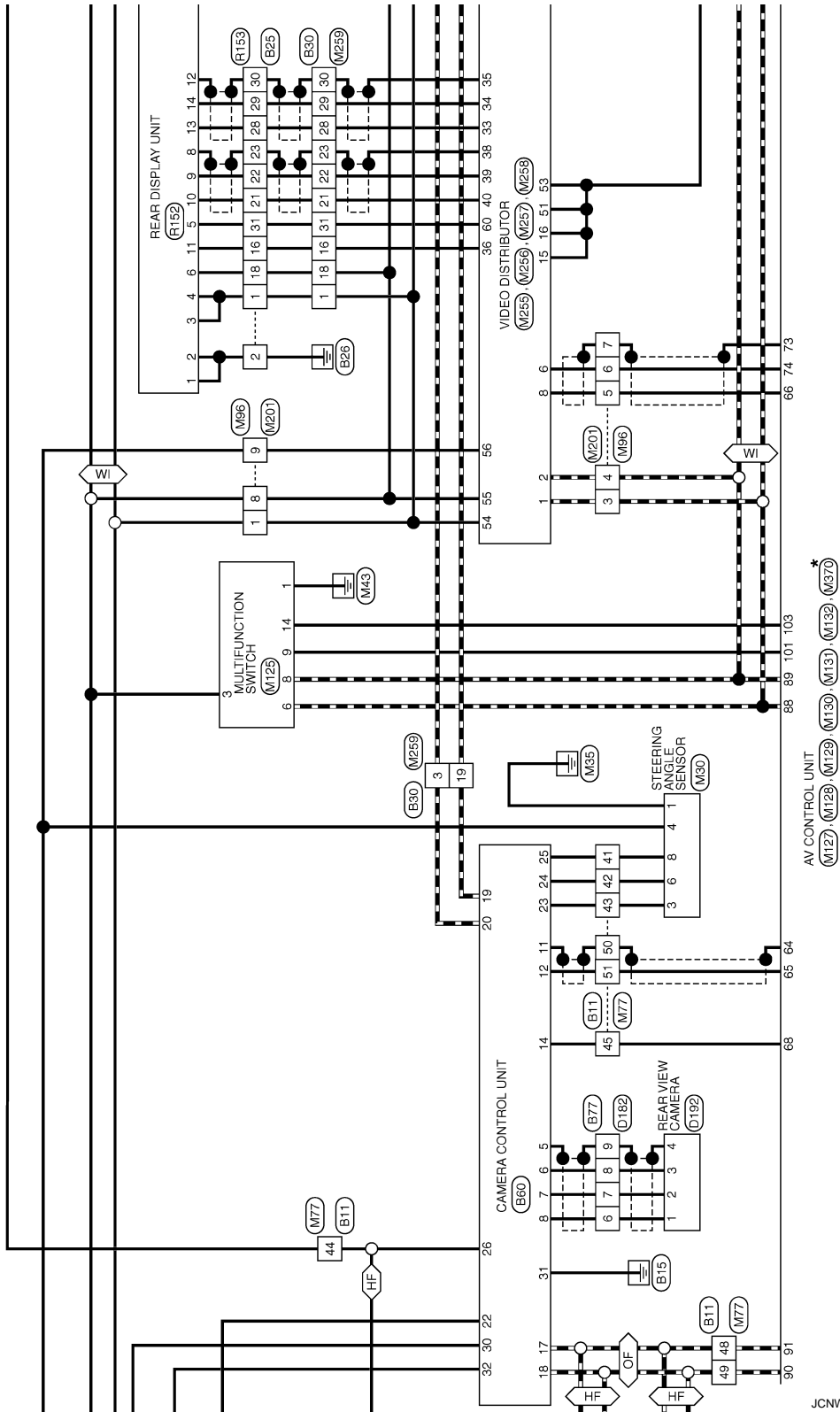

*: This connector is not shown in "Harness Layout".

JCNWM1873GI

BOSE AMP.

[BOSE AUDIO WITHOUT NAVIGATION]

< ECU DIAGNOSIS >

WI: With iPod

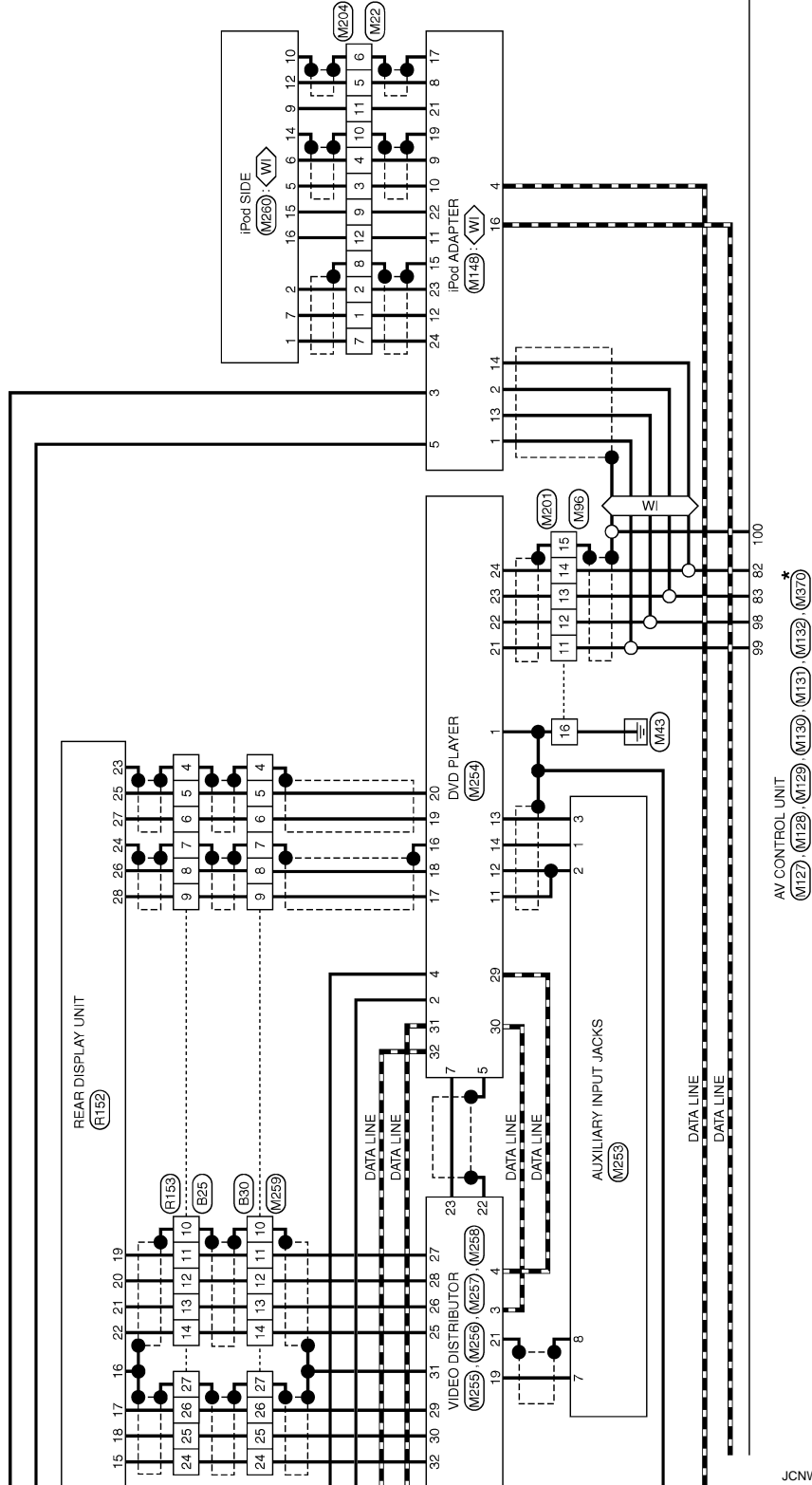

*: This connector is not shown in "Harness Layout".

JCNWM1874GI

A
B
C
D
E
F
G
H
I
J
K
L
M
N
O
P

AV

BOSE AMP.

< ECU DIAGNOSIS >

[BOSE AUDIO WITHOUT NAVIGATION]

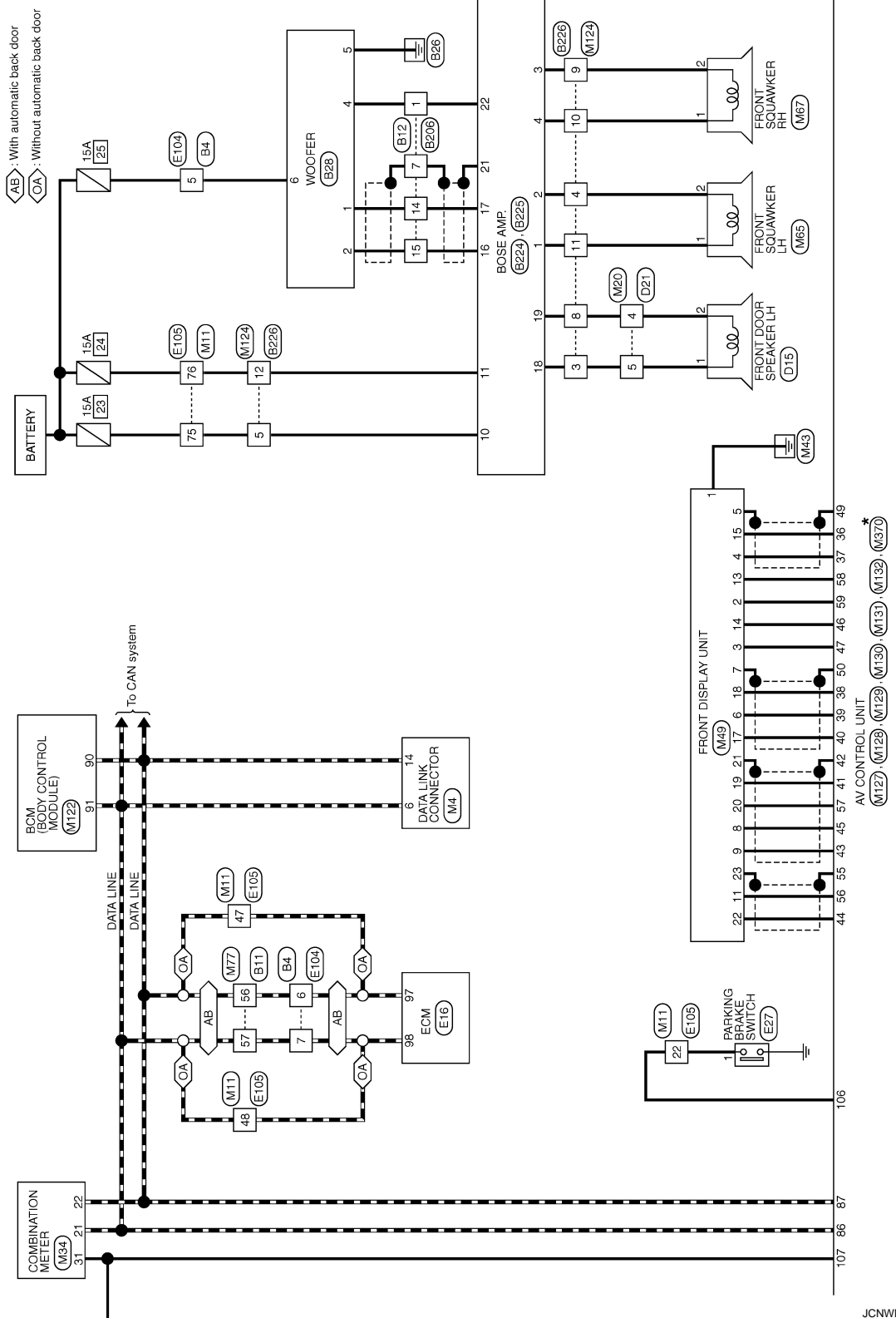

*: This connector is not shown in "Harness Layout".

JCNWM1875GI

BOSE AMP.

< ECU DIAGNOSIS >

[BOSE AUDIO WITHOUT NAVIGATION]

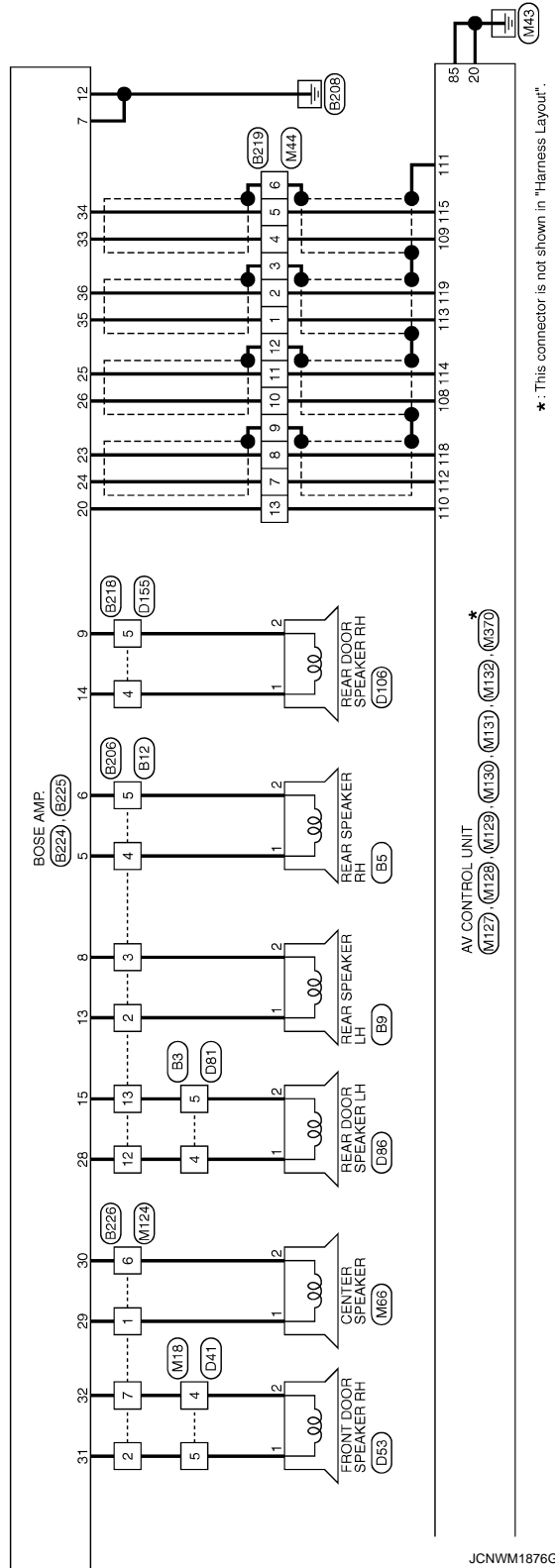

A
B
C
D
E
F
G
H
I
J
K
L
M
AV
O
P

BOSE AMP.

< ECU DIAGNOSIS >

[BOSE AUDIO WITHOUT NAVIGATION]

BOSE AUDIO WITHOUT NAVIGATION WITH DVD ENTERTAINMENT SYSTEM

Connector No.	B3
Connector Name	WIRE TO WIRE
Connector Type	TK10FW-NS8



Terminal No.	Color of Wire	Signal Name [Specification]
4	LG	-
5	O	-

Connector No.	B4
Connector Name	WIRE TO WIRE
Connector Type	NS16MW-CS



Terminal No.	Color of Wire	Signal Name [Specification]
4	R	-
5	O	-
6	P	-
7	L	-

Connector No.	B5
Connector Name	REAR SPEAKER RH
Connector Type	TK02FBR



Terminal No.	Color of Wire	Signal Name [Specification]
1	V	-
2	LG	-

Connector No.	B9
Connector Name	REAR SPEAKER LH
Connector Type	TK02FBR



Terminal No.	Color of Wire	Signal Name [Specification]
1	SB	-
2	GR	-

Connector No.	B11
Connector Name	WIRE TO WIRE
Connector Type	TH80MW-CS19

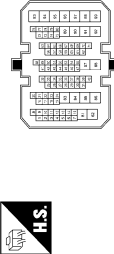

Terminal No.	Color of Wire	Signal Name [Specification]
1	SHIELD	-
2	B	-
3	R/L	-
4	R/W	-
8	SHIELD	-
9	BR/L	-
10	Y/G	-
11	Y/L	-
12	W/L	-
41	O	-
42	SB	-

43	G	-
44	BR	-
45	L	-
46	GR	-
47	V	-
48	GR	- [With rear view camera and telephone]
48	BR	- [With rear view camera without telephone]
49	Y	-
50	SHIELD	-
51	B	-
56	P	-
57	L	-
58	R	-
59	SHIELD	-
60	B	-
61	R/L	-
62	R/W	-
68	R	-
69	SHIELD	-
70	W/R	-
71	B/R	-

Connector No.	B12
Connector Name	WIRE TO WIRE
Connector Type	NS16FW-CS

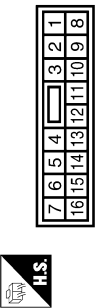

Terminal No.	Color of Wire	Signal Name [Specification]
1	W	-
2	SB	-
3	GR	-
4	V	-
5	LG	-
7	SHIELD	-
12	LG	-
13	O	-
14	W/R	-
15	B/R	-

BOSE AUDIO WITHOUT NAVIGATION WITH DVD ENTERTAINMENT SYSTEM

Connector No.	B25
Connector Name	WIRE TO WIRE
Connector Type	TH22MW-NH



1	2	3	4	5	6	7	8	9	10	11	12	13	14	15	16
17	18	19	20	21	22	23	24	25	26	27	28	29	30	31	32

Terminal No.	Color of Wire	Signal Name [Specification]
1	SB	-
2	B	-
4	SHIELD	-
5	W/R	-
6	W/L	-
7	SHIELD	-
8	GR/V	-
9	W/L	-
10	SHIELD	-
11	W/L	-
12	Y/G	-

Connector No.	B30
Connector Name	WIRE TO WIRE
Connector Type	TH22FW-NH



16	15	14	13	12	11	10	9	8	7	6	5	4	3	2	1
32	31	30	29	28	27	26	25	24	23	22	21	20	19	18	17

Terminal No.	Color of Wire	Signal Name [Specification]
1	SB	-
3	G	-
4	SHIELD	-
5	W/R	-
6	W/L	-
7	SHIELD	-
8	GR/V	-
9	W/L	-
10	SHIELD	-
11	W/L	-
12	Y/G	-

13	Y/L	-
14	BR/L	-
16	V	-
18	O	-
21	B/R	-
22	W/R	-
23	SHIELD	-
24	B	-
25	R/L	-
26	R/W	-
27	SHIELD	-
28	B	-
29	W	-
30	SHIELD	-
31	P	-

Connector No.	B28
Connector Name	WOOFER
Connector Type	RS28FGY-PR



Terminal No.	Color of Wire	Signal Name [Specification]
1	W/R	SOUND SIGNAL WOOFER (-)
2	B/R	SOUND SIGNAL WOOFER (+)
4	W	WOOFER AMP. ON SIGNAL
5	B/W	GND
6	O	BAT

Connector No.	B33
Connector Name	TEL ADAPTER UNIT
Connector Type	TH33FW-NH

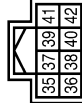

Terminal No.	Color of Wire	Signal Name [Specification]
35	Y	AV COMM (H)
36	BR	AV COMM (L)
40	G	AV COMM (H)
42	GR	AV COMM (L)

A
B
C
D
E
F
G
H
I
J
K
L
M
N
O
P

AV

JCNWM1878GI

BOSE AMP.

< ECU DIAGNOSIS >

[BOSE AUDIO WITHOUT NAVIGATION]

BOSE AUDIO WITHOUT NAVIGATION WITH DVD ENTERTAINMENT SYSTEM

Connector No.	B39
Connector Name	TEL ADAPTER UNIT
Connector Type	TH22FW-NH

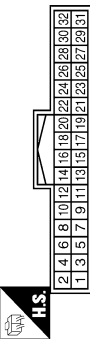

Terminal No.	Color of Wire	Signal Name [Specification]
1	V	BATTERY
2	GR	ACC
3	R	IGNITION
4	B/W	GND
5	SHIELD	SHIELD
6	SHIELD	SHIELD
7	R/W	MICROPHONE SIGNAL
8	R/L	MICROPHONE GND
9	B/R	TEL VOICE SIGNAL (+)
10	W/R	TEL VOICE SIGNAL (-)
14	B	GND

Connector No.	B80
Connector Name	CAMERA CONTROL UNIT
Connector Type	TH22FW-NH

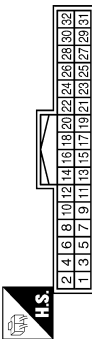

Terminal No.	Color of Wire	Signal Name [Specification]
5	SHIELD	SHIELD
6	B	CAMERA IMAGE SIGNAL
7	R/W	GND
8	R/L	CAMERA ON SIGNAL
11	SHIELD	SHIELD
12	B	CAMERA IMAGE SIGNAL
14	L	CONNECTION RECOGNITION
17	BR	AV COMM (L)
18	Y	AV COMM (H)
19	GR	AV COMM (L)
20	G	AV COMM (H)

20	B	CONTROL SIGNAL
24	B/W	CONTROL SIGNAL
28	BR	VEHICLE SPEED (8-PULSE)
29	B	MICROPHONE YCC



Terminal No.	Color of Wire	Signal Name [Specification]
1	W/L	SOUND SIGNAL LH (-)
2	Y/L	SOUND SIGNAL LH (+)
3	Y/G	SOUND SIGNAL RH (-)
4	BR/L	SOUND SIGNAL RH (+)
5	SHIELD	SHIELD
6	SHIELD	SHIELD
8	R/W	REQUEST (SAT->CONT)
9	R/L	COMM (SAT->CONT)
10	B	COMM (CONT->SAT)
12	V	BATTERY
15	B	GND

Connector No.	B77
Connector Name	WIRE TO WIRE
Connector Type	TK2MW

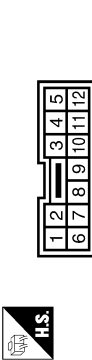

Terminal No.	Color of Wire	Signal Name [Specification]
6	R/L	-
7	R/W	-
8	B	-
9	SHIELD	-

16	GR	ACC
----	----	-----

Connector No.	B206
Connector Name	WIRE TO WIRE
Connector Type	NS16MW-CS



Terminal No.	Color of Wire	Signal Name [Specification]
1	W	-
2	GR	-
3	BR	-
4	Y	-
5	BR	-
7	SHIELD	-
12	G	-
13	R	-
14	W/R	-
15	B/R	-

BOSE AUDIO WITHOUT NAVIGATION WITH DVD ENTERTAINMENT SYSTEM

Connector No.	B218
Connector Name	WIRE TO WIRE
Connector Type	TK10FW-ANS



Connector No.	B219
Connector Name	WIRE TO WIRE
Connector Type	TH32MP-NH



Terminal No.	Color of Wire	Signal Name [Specification]
4	L	[With BOSE system]
5	O	[With BOSE system]

Terminal No.	Color of Wire	Signal Name [Specification]
1	W/R	
2	B/R	
3	SHIELD	
4	W/R	
5	B/R	
6	SHIELD	
7	GR/V	
8	W/L	
9	SHIELD	
10	GR/V	
11	W/L	

Connector No.	B224
Connector Name	BOSE AMP.
Connector Type	SGA12FBR-SJAZ

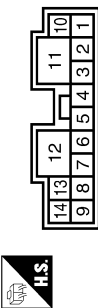

Connector No.	B225
Connector Name	BOSE AMP.
Connector Type	SCA19FBR-SGA4

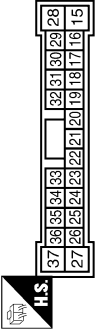

Terminal No.	Color of Wire	Signal Name [Specification]
1	LG	SOUND SIGNAL FRONT SQUAWKER LH (+)
2	V	SOUND SIGNAL FRONT SQUAWKER LH (-)
3	L	SOUND SIGNAL FRONT SQUAWKER RH (-)
4	P	SOUND SIGNAL FRONT SQUAWKER RH (+)
5	Y	SOUND SIGNAL REAR SPEAKER RH (+)
6	BR	SOUND SIGNAL REAR SPEAKER RH (-)
7	B	GND
8	BR	SOUND SIGNAL REAR SPEAKER LH (-)
9	O	SOUND SIGNAL REAR DOOR SPEAKER RH (-)
10	SB	BATTERY
11	GR	BATTERY

Terminal No.	Color of Wire	Signal Name [Specification]
15	R	SOUND SIGNAL REAR DOOR SPEAKER LH (-)
16	B/R	SOUND SIGNAL WOOFER (+)
17	W/R	SOUND SIGNAL WOOFER (-)
18	W	SOUND SIGNAL FRONT DOOR SPEAKER LH (-)
19	B	SOUND SIGNAL FRONT DOOR SPEAKER LH (+)
20	SB	AMP_ON SIGNAL
21	SHIELD	SHIELD
22	W	WOOFER AMP_ON SIGNAL
23	W/L	SOUND SIGNAL REAR LH (-)
24	GR/V	SOUND SIGNAL REAR LH (+)
25	W/L	SOUND SIGNAL REAR RH (-)

26	GR/V	SOUND SIGNAL REAR RH (+)
28	G	SOUND SIGNAL REAR DOOR SPEAKER LH (+)
29	V	SOUND SIGNAL CENTER SPEAKER (+)
30	P	SOUND SIGNAL CENTER SPEAKER (-)
31	BR	SOUND SIGNAL FRONT DOOR SPEAKER RH (+)
32	Y	SOUND SIGNAL FRONT DOOR SPEAKER RH (-)
33	W/R	SOUND SIGNAL FRONT RH (+)
34	B/R	SOUND SIGNAL FRONT RH (-)
35	W/R	SOUND SIGNAL FRONT LH (-)
36	B/R	SOUND SIGNAL FRONT LH (+)

12	SHIELD
13	SB

A B C D E F G H I J K L M O P

AV

JCNWM1880GI

BOSE AUDIO WITHOUT NAVIGATION WITH DVD ENTERTAINMENT SYSTEM

Connector No.	B226
Connector Name	WIRE TO WIRE
Connector Type	NS2MBR-CS

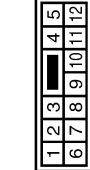

Terminal No.	Color of Wire	Signal Name [Specification]
1	V	-
2	BR	-
3	W	-
4	V	-
5	SB	-
6	P	-
7	Y	-
8	B	-
9	L	-
10	P	-
11	LG	-
12	-	-

Connector No.	B465
Connector Name	ANTENNA BASE (SATELLITE ANTENNA) WITH BOSE SYSTEM WITHOUT NAVIGATION SYSTEM
Connector Type	GT16C-1PP-HU



Terminal No.	Color of Wire	Signal Name [Specification]
1	-	SATELLITE ANTENNA

Connector No.	B471
Connector Name	TEL ADAPTER UNIT
Connector Type	GT16C-1S-HU



Terminal No.	Color of Wire	Signal Name [Specification]
33	-	TEL ANTENNA
34	SHIELD	SHIELD

Connector No.	D21
Connector Name	WIRE TO WIRE
Connector Type	TH40FW-CS15

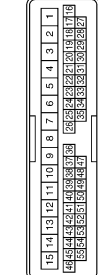

Terminal No.	Color of Wire	Signal Name [Specification]
4	B/W	-[Type A]
4	B	-[Type B]
5	L	-[Type A]
5	W	-[Type B]

Connector No.	B482
Connector Name	SATELLITE RADIO TUNER
Connector Type	FAK6A



Terminal No.	Color of Wire	Signal Name [Specification]
33	-	SATELLITE ANTENNA

Connector No.	D41
Connector Name	WIRE TO WIRE
Connector Type	TH40FW-CS15

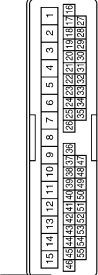

Terminal No.	Color of Wire	Signal Name [Specification]
4	B/R	-[Type A]
4	B	-[Type B]
5	BR	-[Type A]
5	W	-[Type B]

BOSE AUDIO WITHOUT NAVIGATION WITH DVD ENTERTAINMENT SYSTEM

Connector No.	D153
Connector Name	FRONT DOOR SPEAKER RH (WITH BOSE SYSTEM)
Connector Type	NS2ZFBF-CS



Terminal No.	Color of Wire	Signal Name [Specification]
1	BR	- [Type A]
1	W	- [Type B]
2	B/R	- [Type A]
2	B	- [Type B]

Connector No.	D181
Connector Name	WIRE TO WIRE
Connector Type	TK10MW-NS3

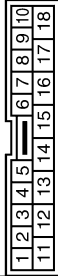

Terminal No.	Color of Wire	Signal Name [Specification]
4	L	-
5	W	-

Connector No.	D198
Connector Name	REAR DOOR SPEAKER LH (WITH BOSE SYSTEM)
Connector Type	NS2ZFBF-CS



Terminal No.	Color of Wire	Signal Name [Specification]
1	L	-
2	W	-

Connector No.	D106
Connector Name	REAR DOOR SPEAKER RH (WITH BOSE SYSTEM)
Connector Type	NS2ZFBF-CS



Terminal No.	Color of Wire	Signal Name [Specification]
1	O	- [Type A]
1	L	- [Type B]
2	B/P	- [Type A]
2	W	- [Type B]

Connector No.	D155
Connector Name	WIRE TO WIRE
Connector Type	TK10MW-NS3

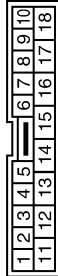

Terminal No.	Color of Wire	Signal Name [Specification]
4	O	- [Type A]
4	L	- [Type B]
5	B/P	- [Type A]
5	W	- [Type B]

Connector No.	D182
Connector Name	WIRE TO WIRE
Connector Type	TK12FW

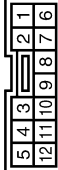

Terminal No.	Color of Wire	Signal Name [Specification]
6	R	-
7	G	-
8	B	-
9	SHIELD	-

Connector No.	D192
Connector Name	REAR VIEW CAMERA
Connector Type	TK16MGY-TV



Terminal No.	Color of Wire	Signal Name [Specification]
1	R	CAMERA ON SIGNAL
2	G	GND
3	B	CAMERA IMAGE SIGNAL
4	SHIELD	SHIELD

Connector No.	EB
Connector Name	WIRE TO WIRE
Connector Type	TK16MGY-TV



Terminal No.	Color of Wire	Signal Name [Specification]
4	R	-

JCNWM1882GI

A
B
C
D
E
F
G
H
I
J
K
L
M
O
P

AV

BOSE AUDIO WITHOUT NAVIGATION WITH DVD ENTERTAINMENT SYSTEM

Connector No.	E18
Connector Name	ECM
Connector Type	RH24FB-R28-L-LH

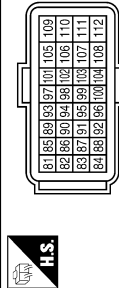

Terminal No.	Color of Wire	Signal Name [Specification]
97	P	VEHGAN-L
98	L	VEHGAN-H

Connector No.	E18
Connector Name	BACK-UP LAMP RELAY
Connector Type	MS02FL-M2-LC

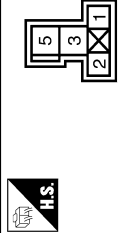

Terminal No.	Color of Wire	Signal Name [Specification]
1	LG	-
2	R	-
3	LG	-
5	R	-

Connector No.	E27
Connector Name	PARKING BRAKE SWITCH
Connector Type	F01FB-A



Terminal No.	Color of Wire	Signal Name [Specification]
1	P	-

Connector No.	E104
Connector Name	WIRE TO WIRE
Connector Type	NS36FW-CS

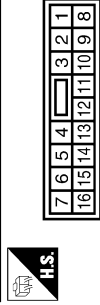

Terminal No.	Color of Wire	Signal Name [Specification]
4	R	-
5	L	-
6	P	-
7	L	-

Connector No.	E105
Connector Name	WIRE TO WIRE
Connector Type	TH70MW-CS10-M3

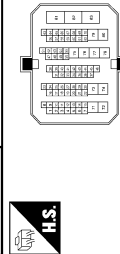

Terminal No.	Color of Wire	Signal Name [Specification]
5	LG	-
22	P	-
47	P	-
48	L	-
75	BR	-
76	GR	-
78	V	-

Connector No.	F23
Connector Name	TCM (TRANSMISSION CONTROL MODULE)
Connector Type	RH40FB-R28-L-RH

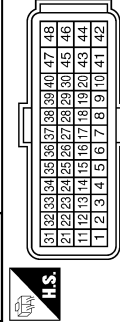

Terminal No.	Color of Wire	Signal Name [Specification]
19	G/B	REV LAMP RELAY

Connector No.	F123
Connector Name	WIRE TO WIRE
Connector Type	TK 6FGY-1V



Terminal No.	Color of Wire	Signal Name [Specification]
4	G/B	-

Connector No.	M1
Connector Name	FUSE BLOCK (J/B)
Connector Type	NS06FW-M2

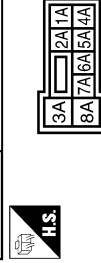

Terminal No.	Color of Wire	Signal Name [Specification]
2A	G	-
5A	R	-

BOSE AUDIO WITHOUT NAVIGATION WITH DVD ENTERTAINMENT SYSTEM

Connector No.	M3
Connector Name	FUSE BLOCK (J/B)
Connector Type	NS12FW-CS

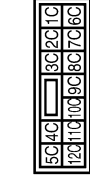

Terminal No.	Color of Wire	Signal Name [Specification]
12C	O	-

Connector No.	M4
Connector Name	DATA LINK CONNECTOR
Connector Type	BD16FW

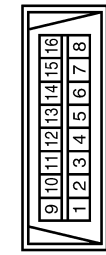

Terminal No.	Color of Wire	Signal Name [Specification]
6	L	-
14	P	-

Connector No.	M11
Connector Name	WIRE TO WIRE
Connector Type	TH10FW-CS10-M3

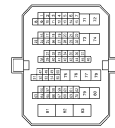

Terminal No.	Color of Wire	Signal Name [Specification]
5	O	-
22	G	-
47	P	-
48	L	-
75	BR	-
76	R	-
78	Y	-

Connector No.	M18
Connector Name	WIRE TO WIRE
Connector Type	TH40MW-CS15

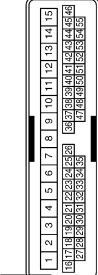

Terminal No.	Color of Wire	Signal Name [Specification]
4	W	-
5	BR	- [Type A and without BOSE system type B]
5	B	- [With BOSE system type B]

Connector No.	M20
Connector Name	WIRE TO WIRE
Connector Type	TH40MW-CS15

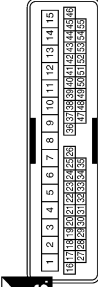

Terminal No.	Color of Wire	Signal Name [Specification]
4	B	-
5	L	-

Connector No.	M22
Connector Name	WIRE TO WIRE
Connector Type	TH12FW-NH

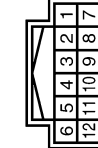

Terminal No.	Color of Wire	Signal Name [Specification]
1	V	-
2	R	-
3	R	-
4	G	-
5	W	-
6	SHIELD	-
7	LG	-
8	SHIELD	-
9	BR	-
10	SHIELD	-
11	L	-

Connector No.	M23
Connector Name	WIRE TO WIRE
Connector Type	TH16MW-NH



Terminal No.	Color of Wire	Signal Name [Specification]
1	W	-
2	R	- [With telephone without navigation system]
3	B	-
4	SHIELD	-

JCNWM1884GI

A
B
C
D
E
F
G
H
I
J
K
L
M
N
O
P

AV

BOSE AUDIO WITHOUT NAVIGATION WITH DVD ENTERTAINMENT SYSTEM

Connector No.	M30
Connector Name	STEERING ANGLE SENSOR
Connector Type	TH08FW-NH

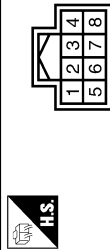

Terminal No.	Color of Wire	Signal Name [Specification]
1	B	-
3	L	-
4	G	-
6	SB	-
8	O	-

Connector No.	M33
Connector Name	COMBINATION SWITCH (SPIRAL CABLE)
Connector Type	TH08FGY-1V

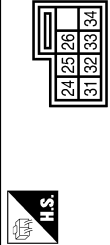

Terminal No.	Color of Wire	Signal Name [Specification]
24	BR	- [With audio steering switch and telephone]
31	G	- [With audio steering switch and telephone]
33	L	- [With audio steering switch and telephone]

Connector No.	M44
Connector Name	WIRE TO WIRE
Connector Type	TH02FW-NH

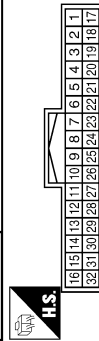

Terminal No.	Color of Wire	Signal Name [Specification]
1	G	-
2	R	-
3	SHIELD	-
4	B	-
5	W	-
6	SHIELD	-
7	O	- [Type A]
7	L	- [Type B]
8	SB	- [Type A]
8	R	- [Type B]
9	SHIELD	-

Connector No.	M34
Connector Name	COMBINATION METER
Connector Type	TH06FW-NH

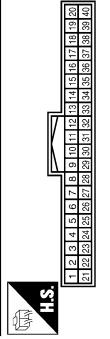

Terminal No.	Color of Wire	Signal Name [Specification]
21	L	CAN-H
22	P	CAN-L
31	V	VEHICLE SPEED (8-PULSE)

Connector No.	M49
Connector Name	FRONT DISPLAY UNIT
Connector Type	TH24FW-NH

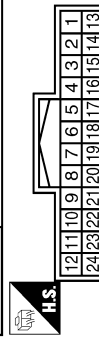

Terminal No.	Color of Wire	Signal Name [Specification]
1	B	GND
2	Y	INVERTER VCCI[Without navigation system]
3	O	SIGNAL VCCI[Without navigation system]
4	P	COMPOSITE IMAGE GND[Without navigation system]
5	SHIELD	SHIELD[Without navigation system]
6	L	RGB (GREEN) SIGNAL[Without navigation system]
7	SHIELD	SHIELD
8	G	HP[Without navigation system]
9	W	RGB AREA (YS) SIGNAL
11	R	COMM (CONT->DISP)
13	BR	INVERTER GND[Without navigation system]

14	LG	SIGNAL GND[Without navigation system]
15	L	COMPOSITE IMAGE SIGNAL[Without navigation system]
17	G	RGB (RED) SIGNAL
18	Y	RGB (BLUE) SIGNAL[Without navigation system]
19	B	RGB SYNC
20	R	VP
21	SHIELD	SHIELD
22	G	COMM (DISP->CONT)
23	SHIELD	SHIELD

BOSE AUDIO WITHOUT NAVIGATION WITH DVD ENTERTAINMENT SYSTEM

Connector No.	M65
Connector Name	FRONT SQUAWKER LH
Connector Type	TK02FBR



Terminal No.	Color of Wire	Signal Name [Specification]
1	LG	[With BOSE system]
2	Y	[With BOSE system]

Connector No.	M66
Connector Name	CENTER SPEAKER
Connector Type	TK02FBR



Terminal No.	Color of Wire	Signal Name [Specification]
1	P	
2	O	

Connector No.	M67
Connector Name	FRONT SQUAWKER RH
Connector Type	TK02FBR



Terminal No.	Color of Wire	Signal Name [Specification]
1	BR	
2	R	[With BOSE system]

Connector No.	M77
Connector Name	WIRE TO WIRE
Connector Type	TH80FW-C519

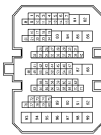

Terminal No.	Color of Wire	Signal Name [Specification]
1	SHIELD	
2	B	
3	W	
4	R	
8	SHIELD	
9	W	
10	R	
11	G	
12	B	
41	O	
42	SB	

43	L	
44	V	
45	P	
46	R	
47	Y	
48	L	
49	G	
50	SHIELD	
51	W	
56	P	
57	L	
58	SS	
59	SHIELD	
60	B	
61	R	
62	W	
68	G	
69	SHIELD	
70	L	
71	R	

Connector No.	M66
Connector Name	WIRE TO WIRE
Connector Type	TH18FW-NH

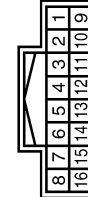

Terminal No.	Color of Wire	Signal Name [Specification]
1	Y	
3	R	
4	L	
5	L	
6	R	
7	SHIELD	
8	R	
9	G	
11	B	
12	G	
13	R	

14	W	
15	SHIELD	
16	B	

A
B
C
D
E
F
G
H
I
J
K
L
M
AV
O
P

BOSE AMP.

< ECU DIAGNOSIS >

[BOSE AUDIO WITHOUT NAVIGATION]

BOSE AUDIO WITHOUT NAVIGATION WITH DVD ENTERTAINMENT SYSTEM

Connector No.	M122
Connector Name	BCM BODY CONTROL MODULE
Connector Type	TH40FB-NH

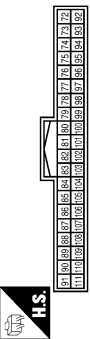

Terminal No.	Color of Wire	Signal Name [Specification]
90	P	CAN-L
91	L	CAN-H

Connector No.	M124
Connector Name	WIRE TO WIRE
Connector Type	NS12FBR-CS



Terminal No.	Color of Wire	Signal Name [Specification]
1	P	-
2	BR	- [Type A]
3	B	- [Type B]
4	Y	-
5	BR	-
6	O	-
7	W	-
8	B	-
9	R	-
10	BR	-

Connector No.	M127
Connector Name	AV CONTROL UNIT (WITH BOSE SYSTEM WITHOUT NAVIGATION SYSTEM)
Connector Type	TH18FW-CS2

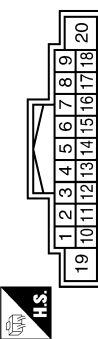

Terminal No.	Color of Wire	Signal Name [Specification]
6	BR	STRG SW A
7	R	ACC
9	R	ILLUMINATION
15	L	STRG SW GND
16	G	STRG SW B
19	Y	BATTERY
20	B	GND

Connector No.	M128
Connector Name	AV CONTROL UNIT (WITH BOSE SYSTEM WITHOUT NAVIGATION SYSTEM)
Connector Type	A12FW

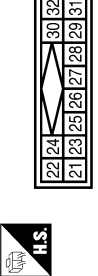

Terminal No.	Color of Wire	Signal Name [Specification]
21	B	SATELLITE RADIO SOUND SIGNAL LH (-)
22	G	SATELLITE RADIO SOUND SIGNAL LH (+)
23	R	SATELLITE RADIO SOUND SIGNAL RH (-)
24	W	SATELLITE RADIO SOUND SIGNAL RH (+)
25	SHIELD	SHIELD
26	SHIELD	SHIELD
28	R	REQUEST (SAT->CONT)
29	W	COMM (SAT->CONT)
30	B	COMM (CONT->SAT)

11	LG
12	R

Connector No.	M125
Connector Name	MULTIFUNCTION SWITCH
Connector Type	TH16FW-NH

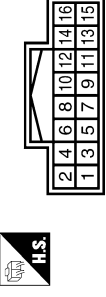

Terminal No.	Color of Wire	Signal Name [Specification]
1	B	GND
3	R	ACC
6	R	AV COMM (H)
8	L	AV COMM (L)
9	V	SW GND
14	W	EJECT SIGNAL

Connector No.	M129
Connector Name	AV CONTROL UNIT (WITH BOSE SYSTEM WITHOUT NAVIGATION SYSTEM)
Connector Type	TH24FW-NH

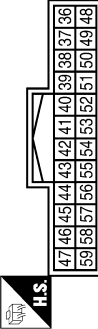

Terminal No.	Color of Wire	Signal Name [Specification]
36	L	COMPOSITE IMAGE SIGNAL
37	P	COMPOSITE IMAGE GND
38	Y	RGB (B/BLUE) SIGNAL
39	L	RGB (G/GREEN) SIGNAL
40	G	RGB (R/RED) SIGNAL
41	B	RGB SYNC
42	SHIELD	SHIELD
43	W	RGB AREA (YS) SIGNAL
44	G	COMM (DISP->CONT)
45	G	HP
46	LG	SIGNAL GND

Terminal No.	Color of Wire	Signal Name [Specification]
47	O	SIGNAL VCC
49	SHIELD	SHIELD
50	SHIELD	SHIELD
55	SHIELD	SHIELD
56	R	COMM (CONT->DISP)
57	R	VP
58	BR	INVERTER GND
59	Y	INVERTER VCC

BOSE AUDIO WITHOUT NAVIGATION WITH DVD ENTERTAINMENT SYSTEM

Connector No.	M130
Connector Name	AV CONTROL UNIT (WITH BOSE SYSTEM WITHOUT NAVIGATION SYSTEM)
Connector Type	TH116FW-NH

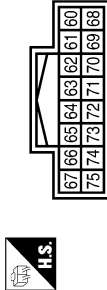

Connector No.	M131
Connector Name	AV CONTROL UNIT (WITH BOSE SYSTEM WITHOUT NAVIGATION SYSTEM)
Connector Type	TH122FW-NH

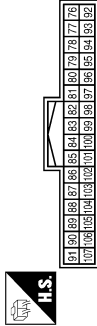

Terminal No.	Color of Wire	Signal Name [Specification]
64	SHIELD	SHIELD
65	W	CAMERA IMAGE SIGNAL
66	L	COMPOSITE IMAGE SIGNAL (With DVD player)
68	P	CONNECTION RECOGNITION SHIELD (With DVD player)
72	SHIELD	SHIELD (With DVD player)
74	R	COMPOSITE IMAGE GND (With DVD player)

Terminal No.	Color of Wire	Signal Name [Specification]
79	L	TEL VOICE SIGNAL (-)
80	R	TEL VOICE SIGNAL (+)
81	SHIELD	SHIELD
82	W	SOUND SIGNAL RH (-) (With DVD player)
83	R	SOUND SIGNAL RH (+) (With DVD player)
85	B	GND
86	L	CAN-H
87	P	CAN-L
88	R	AV COMM (H)
89	L	AV COMM (L)
90	G	AV COMM (H)

Connector No.	M132
Connector Name	AV CONTROL UNIT (WITH BOSE SYSTEM WITHOUT NAVIGATION SYSTEM)
Connector Type	TH121FW-NH



Terminal No.	Color of Wire	Signal Name [Specification]
108	V	SOUND SIGNAL REAR RH (+)
109	B	SOUND SIGNAL FRONT RH (+)
110	P	AMP. ON SIGNAL
111	SHIELD	SHIELD
112	O	SOUND SIGNAL REAR LH (+) (Type A)
112	L	SOUND SIGNAL REAR LH (+) (Type B)
113	G	SOUND SIGNAL FRONT LH (+)
114	LG	SOUND SIGNAL REAR RH (-)
115	W	SOUND SIGNAL FRONT RH (-)
118	SB	SOUND SIGNAL REAR LH (-) (Type A)
118	R	SOUND SIGNAL REAR LH (-) (Type B)

91	L	AV COMM (L)
98	G	SOUND SIGNAL LH (-) (With DVD player)
99	B	SOUND SIGNAL LH (+) (With DVD player)
100	SHIELD	SHIELD (With DVD player)
101	V	SW GND
103	W	EJECT SIGNAL
104	G	IGNITION
105	SB	REVERSE
106	G	PARKING BRAKE
107	V	VEHICLE SPEED (8-PULSE)

119	R	SOUND SIGNAL FRONT LH (-)
-----	---	---------------------------

Connector No.	M148
Connector Name	iPod ADAPTER
Connector Type	TH224FW-NH

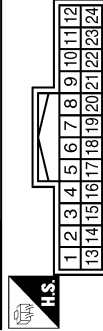

Terminal No.	Color of Wire	Signal Name [Specification]
1	BR	iPod SOUND SIGNAL LH (+)
2	R	iPod SOUND SIGNAL RH (+)
3	R	ACC
4	L	AV COMM (L)
5	Y	BATTERY
8	W	CHARGE POWER
9	G	COMM (iPod ADAPTER->iPod)
10	R	COMM (iPod->iPod ADAPTER)
11	R	ACCESSORY IDENTIFY
12	V	iPod SOUND SIGNAL RH (+)
13	L	iPod SOUND SIGNAL LH (-)

14	W	iPod SOUND SIGNAL RH (-)
15	SHIELD	SHIELD
16	R	AV COMM (H)
17	SHIELD	GND
19	SHIELD	SHIELD
21	L	iPod CONNECTION RECOGNITION
22	BR	ACCESSORY DETECT
23	R	iPod SOUND SIGNAL GND
24	LG	iPod SOUND SIGNAL LH (+)

A
B
C
D
E
F
G
H
I
J
K
L
M
N
O
P

AV

BOSE AMP.

< ECU DIAGNOSIS >

[BOSE AUDIO WITHOUT NAVIGATION]

BOSE AUDIO WITHOUT NAVIGATION WITH DVD ENTERTAINMENT SYSTEM

Connector No.	M204
Connector Name	WIRE TO WIRE
Connector Type	TH12MW-NH

Terminal No.	Color of Wire	Signal Name [Specification]
1	V	-
2	R	-
3	R	-
4	G	-
5	W	-
6	SHIELD	-
7	LG	-
8	SHIELD	-
9	BR	-
10	SHIELD	-
11	L	-

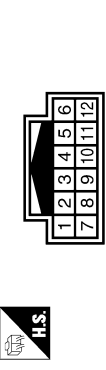

Connector No.	M254
Connector Name	DVD PLAYER
Connector Type	TH32FW-NH

Terminal No.	Color of Wire	Signal Name [Specification]
1	B	GND
2	Y	BATTERY
4	V	ACC
5	SHIELD	SHIELD
7	P	DVD IMAGE SIGNAL
11	B	AUX SOUND SIGNAL LH (-)
12	W	AUX SOUND SIGNAL RH (-)
13	G	AUX SOUND SIGNAL LH (+)
14	R	AUX SOUND SIGNAL RH (+)
16	SHIELD	SHIELD
17	G	HEADPHONE SOUND SIGNAL LH (+)

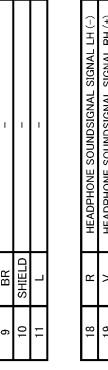
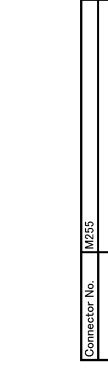

Connector No.	M253
Connector Name	AUXILIARY INPUT JACKS
Connector Type	A08FW

Terminal No.	Color of Wire	Signal Name [Specification]
1	R	SOUND SIGNAL RH (+)
2	W	SOUND SIGNAL GND
3	G	SOUND SIGNAL LH (-) [With DVD player]
7	G	AUX IMAGE SIGNAL
8	SHIELD	SHIELD [With DVD player]

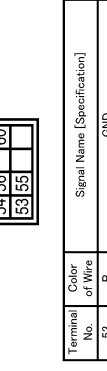

Connector No.	M255
Connector Name	VIDEO DISTRIBUTOR
Connector Type	TH08FW-NH

Terminal No.	Color of Wire	Signal Name [Specification]
18	R	HEADPHONE SOUND SIGNAL LH (-)
19	V	HEADPHONE SOUND SIGNAL RH (+)
20	LG	HEADPHONE SOUND SIGNAL RH (-)
21	B	SOUND SIGNAL LH (+)
22	G	SOUND SIGNAL LH (-)
23	R	SOUND SIGNAL RH (+)
24	W	SOUND SIGNAL RH (-)
29	L	AV COMM (L)
30	R	AV COMM (H)
31	L	AV COMM (L)
32	R	AV COMM (H)



JCNW11889GI

BOSE AUDIO WITHOUT NAVIGATION WITH DVD ENTERTAINMENT SYSTEM

Connector No.	M256
Connector Name	VIDEO DISTRIBUTOR
Connector Type	TH12FW-NH



26	28	30	32	34	36	38	40
25	27	29	31	33	35	37	39



Connector No.	M257
Connector Name	VIDEO DISTRIBUTOR
Connector Type	TH11FW-NH



26	28	30	32	34	36	38	40
25	27	29	31	33	35	37	39



36	G	IGNITION
38	SHIELD	SHIELD
39	V	COMM (DISP->DIST)
40	LG	COMM (DIST->DISP)

Terminal No.	Color of Wire	Signal Name [Specification]
51	B	GND

Terminal No.	Color of Wire	Signal Name [Specification]
25	R	RGB (R/RED) SIGNAL
26	L	RGB (G/GREEN) SIGNAL
27	W	RGB GND
28	G	RGB (B/BLUE) SIGNAL
29	R	YP
30	W	HP
31	SHIELD	SHIELD
32	B	RGB AREA (Y/S) SIGNAL
33	G	COMPOSITE SYNC
34	R	COMPOSITE IMAGE SIGNAL
35	SHIELD	SHIELD

Connector No.	M258
Connector Name	VIDEO DISTRIBUTOR
Connector Type	TH12FW-NH

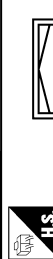

2	4	6	8	10	12	14	16	18	20	22	24
1	3	5	7	9	11	13	15	17	19	21	23



Terminal No.	Color of Wire	Signal Name [Specification]
1	R	AV COMM (H)
2	G	AV COMM (L)
3	R	AV COMM (H)
4	L	AV COMM (L)
6	R	COMPOSITE IMAGE GND
8	L	COMPOSITE IMAGE SIGNAL
15	B	GND
16	B	GND
19	G	AUX IMAGE SIGNAL
21	SHIELD	SHIELD
22	SHIELD	SHIELD

Connector No.	M259
Connector Name	WIRE TO WIRE
Connector Type	TH32MW-NH



1	2	3	4	5	6	7	8	9	10	11	12	13	14	15	16
17	18	19	20	21	22	23	24	25	26	27	28	29	30	31	32

Terminal No.	Color of Wire	Signal Name [Specification]
1	Y	-
3	R	-
4	SHIELD	-
5	LG	-
6	V	-
7	SHIELD	-
8	R	-
9	G	-
10	SHIELD	-
11	W	-
12	G	-

13	L	-
14	R	-
16	G	-
18	V	-
19	L	-
21	LG	-
22	V	-
23	SHIELD	-
24	B	-
25	W	-
26	R	-
27	SHIELD	-
28	G	-
29	R	-
30	SHIELD	-
31	R	-

A
B
C
D
E
F
G
H
I
J
K
L
M
N
O
P

AV

BOSE AUDIO WITHOUT NAVIGATION WITH DVD ENTERTAINMENT SYSTEM

Connector No.	M370
Connector Name	iPod SIDE
Connector Type	IP18FGY

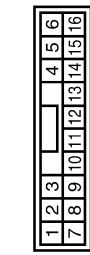

Terminal No.	Color of Wire	Signal Name [Specification]
1	LG	iPod SOUND SIGNAL LH (+)
2	R	iPod SOUND SIGNAL LH (-)
5	R	COMM (iPod->iPod ADAPTER)
6	G	COMM (iPod ADAPTER->iPod)
7	V	iPod SOUND SIGNAL RH (+)
8	L	iPod SOUND SIGNAL RH (-)
9	SHIELD	GROUND
10	SHIELD	CHARGE POWER
12	W	SHIELD
14	SHIELD	SHIELD
15	BR	ACCESSORY DETECT
16	R	ACCESSORY IDENTIFY

Connector No.	M303
Connector Name	COMBINATION SWITCH (SPIRAL CABLE)
Connector Type	TK08FGY



Terminal No.	Color of Wire	Signal Name [Specification]
14	-	-
15	-	-
17	-	-

Connector No.	M370
Connector Name	AV CONTROL UNIT (WITH BOSE SYSTEM WITHOUT NAVIGATION SYSTEM)
Connector Type	GT13SC-2/1S-HU



Terminal No.	Color of Wire	Signal Name [Specification]
33	-	FM SUB
34	-	AM-FM MAIN
35	-	ANTENNA AMP. ON SIGNAL

Connector No.	M375
Connector Name	WIRE TO WIRE
Connector Type	GT13SH-2/1S-HU



Terminal No.	Color of Wire	Signal Name [Specification]
1	-	-
2	-	-
3	-	-

Connector No.	M376
Connector Name	WIRE TO WIRE
Connector Type	GT13SCN-2/1PP-HU



Terminal No.	Color of Wire	Signal Name [Specification]
1	-	-
2	-	-
3	-	-

Connector No.	M378
Connector Name	ANTENNA BASE (ANTENNA AMP.)
Connector Type	GT13SSN-1/1PP-HU

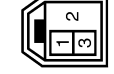

Terminal No.	Color of Wire	Signal Name [Specification]
1	-	-
3	-	-

Connector No.	M379
Connector Name	GLASS ANTENNA
Connector Type	GT13SCN-1/1PP-HU



Terminal No.	Color of Wire	Signal Name [Specification]
2	-	FM SUB

Connector No.	FT
Connector Name	WIRE TO WIRE
Connector Type	TH16FW-NH

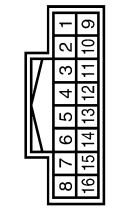

Terminal No.	Color of Wire	Signal Name [Specification]
1	R/W	-
2	R/L	-(With telephones without navigation system)
3	B	-
4	SHIELD	-

BOSE AUDIO WITHOUT NAVIGATION WITH DVD ENTERTAINMENT SYSTEM

Connector No.	R20
Connector Name	MICROPHONE
Connector Type	TH24FW



Terminal No.	Color of Wire	Signal Name [Specification]
1	R/W	MICROPHONE SIGNAL (+)
2	R/L	MICROPHONE SIGNAL (-) (Only in vehicle with navigation system)
4	B	MICROPHONE POWER

Connector No.	R152
Connector Name	REAR DISPLAY UNIT
Connector Type	TH32FW-NH



Terminal No.	Color of Wire	Signal Name [Specification]
1	B	GND
2	B	GND
3	Y/R	BATTERY
4	Y/R	BATTERY
5	R	HEADPHONE ON SIGNAL
6	V/Y	ACC
8	SHIELD	SHIELD
9	V	COMM (DISP->DISP)
10	LG	COMM (DISP->DISP)
11	G	IGNITION
12	SHIELD	SHIELD

Connector No.	R153
Connector Name	WIRE TO WIRE
Connector Type	TH32FW-NH

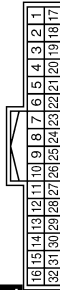

Terminal No.	Color of Wire	Signal Name [Specification]
1	Y/R	-
2	B	-
4	SHIELD	-
5	LG	-
6	V	-
7	SHIELD	-
8	BR	-
9	Y	-
10	SHIELD	-
11	W/L	-
12	Y/G	-

13	G	COMPOSITE SYNC
14	R	COMPOSITE IMAGE SIGNAL
15	B	RGB AREA (V/S) SIGNAL
16	SHIELD	GND
17	R	VP
18	W	HP
19	W/L	RGB GND
20	Y/G	RGR (B/BLUE) SIGNAL
21	Y/L	RGB (G/GREEN) SIGNAL
22	BR/L	RGB (R/RED) SIGNAL
23	SHIELD	SHIELD
24	SHIELD	SHIELD
25	LG	HEADPHONE SOUND SIGNAL RH (-)
26	BR	HEADPHONE SOUND SIGNAL LH (-)
27	V	HEADPHONE SOUND SIGNAL RH (+)
28	Y	HEADPHONE SOUND SIGNAL LH (+)

13	Y/L	-
14	BR/L	-
16	G	-
18	V/Y	-
21	LG	-
22	V	-
23	SHIELD	-
24	B	-
25	W	-
26	R	-
27	SHIELD	-
28	G	-
29	R	-
30	SHIELD	-
31	R	-

A
B
C
D
E
F
G
H
I
J
K
L
M
N
O
P



REAR DISPLAY UNIT

[BOSE AUDIO WITHOUT NAVIGATION]

< ECU DIAGNOSIS >

REAR DISPLAY UNIT

Reference Values

INFOID:000000003457757

TERMINAL LAYOUT

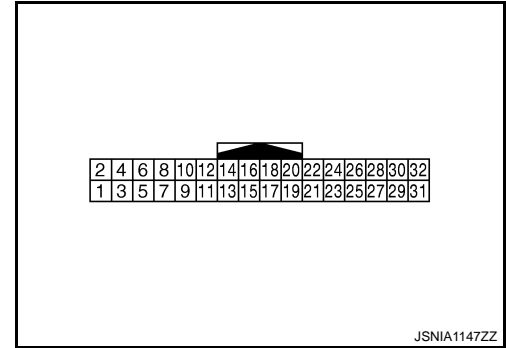

PHYSICAL VALUES

Terminal (Wire color)		Description		Condition		Reference value (Approx.)
+	-	Signal name	Input/ Output			
1 (B)	Ground	Ground	—	Ignition switch ON	—	0 V
2 (B)	Ground	Ground	—	Ignition switch ON	—	0 V
3 (Y/R)	Ground	Battery power supply	Input	Ignition switch ON	—	Battery voltage
4 (Y/R)	Ground	Battery power supply	Input	Ignition switch ON	—	Battery voltage
5 (R)	Ground	Headphone amp. ON sig- nal	Input	Ignition switch ON	Headphone mode is ON.	4.5 V
					Headphone mode is OFF.	0 V
6 (V/Y)	Ground	ACC power supply	Input	Ignition switch ACC	—	Battery voltage
8	—	Shield	—	—	—	—
9 (V)	Ground	Communication signal (DISP→DIST)	Output	Ignition switch ON	Rear seat remote controller operation when AUX or DVD image is displayed on rear displayed.	<p style="text-align: right;">PKIB5039J</p>
10 (LG)	Ground	Communication signal (DIST→DISP)	Input	Ignition switch ON	Rear seat remote controller operation when AUX or DVD image is displayed on rear displayed.	<p style="text-align: right;">PKIB5039J</p>

REAR DISPLAY UNIT

[BOSE AUDIO WITHOUT NAVIGATION]

< ECU DIAGNOSIS >

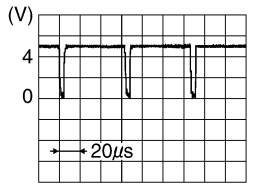
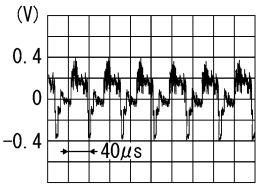
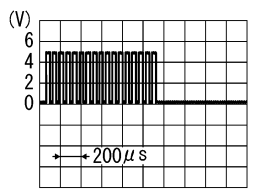
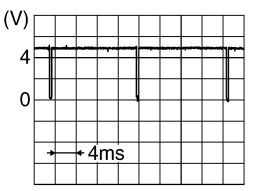
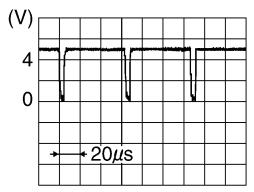
Terminal (Wire color)		Description		Condition		Reference value (Approx.)
+	-	Signal name	Input/ Output			
11 (G)	Ground	Ignition signal	Input	Ignition switch ON	—	0 V
				Ignition switch OFF	—	3.3 V
12	—	Shield	—	—	—	—
13 (G)	Ground	Composite and RGB image synchronizing signal for rear display	Input	Ignition switch ON	When AUX or DVD image is displayed on rear display unit.	 <p style="text-align: right; font-size: small;">SKIB0825E</p>
14 (R)	Ground	Composite image signal	Input	Ignition switch ON	When AUX or DVD image is displayed on rear display unit.	 <p style="text-align: right; font-size: small;">SKIB2251J</p>
15 (B)	Ground	RGB area (YS) signal	Input	Ignition switch ON	When AUX or DVD image is displayed.	0 V
				Ignition switch ON	Rear seat remote controller operation when AUX or DVD image is displayed on rear display.	 <p style="text-align: right; font-size: small;">PKIB4948J</p>
16	—	Shield	—	—	—	—
17 (R)	Ground	Vertical synchronizing (VP) signal	Output	Ignition switch ON	—	 <p style="text-align: right; font-size: small;">SKIB3598E</p>
18 (W)	Ground	Horizontal synchronizing (HP) signal	Output	Ignition switch ON	—	 <p style="text-align: right; font-size: small;">SKIB0825E</p>
19 (W/L)	Ground	RGB ground	—	Ignition switch ON	—	0 V

A
B
C
D
E
F
G
H
I
J
K
L
M
O
P

AV

REAR DISPLAY UNIT

[BOSE AUDIO WITHOUT NAVIGATION]

< ECU DIAGNOSIS >

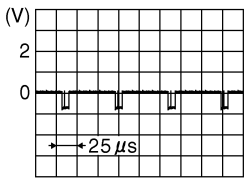
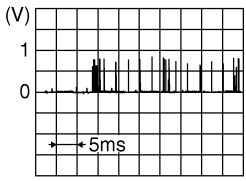
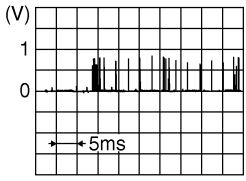
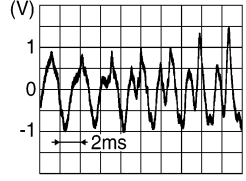
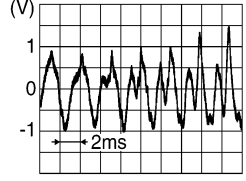
Terminal (Wire color)		Description		Condition		Reference value (Approx.)
+	-	Signal name	Input/ Output			
20 (Y/G)	Ground	RGB image signal (B: blue)	Input	Ignition switch ON	Rear seat remote controller operation when AUX or DVD image is displayed on rear display unit.	 <p style="text-align: right; font-size: small;">JSNIA1090ZZ</p>
21 (Y/L)	Ground	RGB image signal (G: green)	Input	Ignition switch ON	Rear seat remote controller operation when AUX or DVD image is displayed on rear display unit.	 <p style="text-align: right; font-size: small;">JSNIA0984ZZ</p>
22 (BR/L)	Ground	RGB image signal (R: red)	Input	Ignition switch ON	Rear seat remote controller operation when AUX or DVD image is displayed on rear display unit.	 <p style="text-align: right; font-size: small;">JSNIA0984ZZ</p>
23	—	Shield	—	—	—	—
24	—	Shield	—	—	—	—
27 (V)	25 (LG)	Headphone sound signal LH	Input	Ignition switch ON	Headphone sound output.	 <p style="text-align: right; font-size: small;">SKIB3609E</p>
28 (Y)	26 (BR)	Headphone sound signal RH	Input	Ignition switch ON	Headphone sound output.	 <p style="text-align: right; font-size: small;">SKIB3609E</p>

Wiring Diagram - BOSE AUDIO WITHOUT NAVIGATION WITH DVD ENTERTAINMENT SYSTEM -

INFOID:000000003702912

NOTE:

REAR DISPLAY UNIT

[BOSE AUDIO WITHOUT NAVIGATION]

< ECU DIAGNOSIS >

In this section, PRESET SWITCH and MULTIFUNCTION SWITCH are written as the MULTIFUNCTION SWITCH.

BOSE AUDIO WITHOUT NAVIGATION WITH DVD ENTERTAINMENT SYSTEM

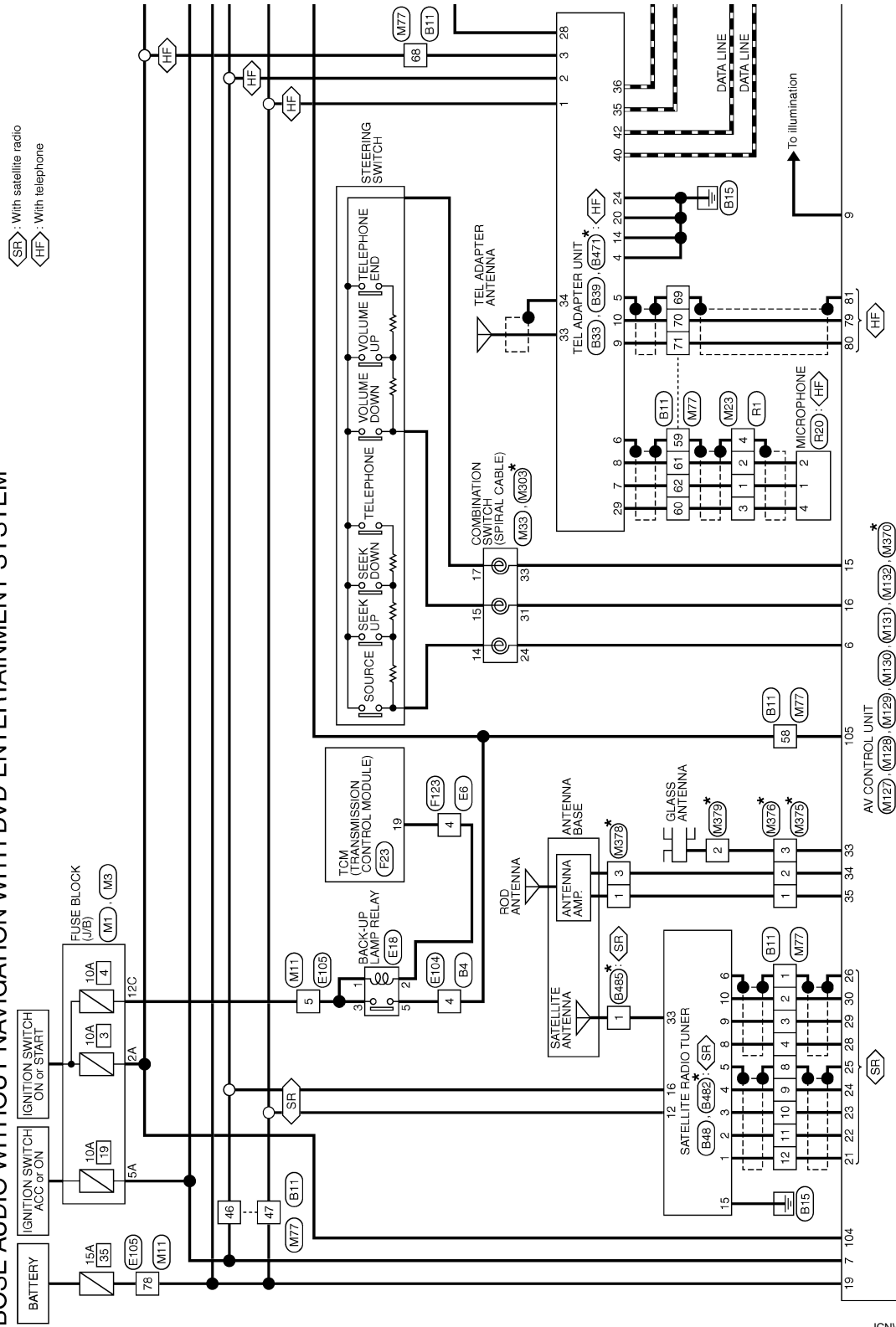

*: This connector is not shown in "Harness layout".

2008/09/23

JCNWM1872GI

A
B
C
D
E
F
G
H
I
J
K
L
M
N
O
P

AV

REAR DISPLAY UNIT

[BOSE AUDIO WITHOUT NAVIGATION]

< ECU DIAGNOSIS >

- : With iPod
- : With telephone
- : Without telephone

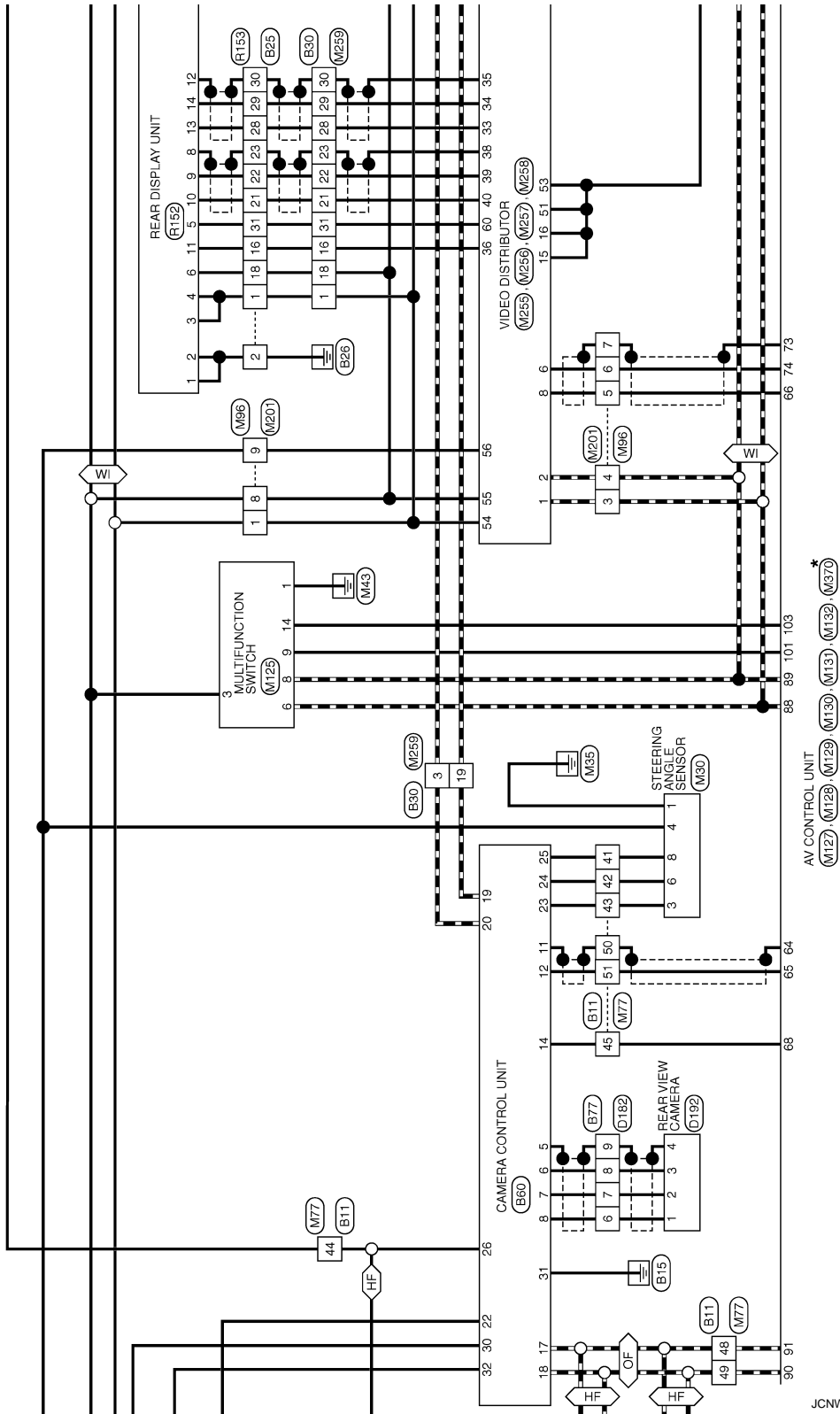

*: This connector is not shown in "Harness Layout".

JCNWM1873GI

REAR DISPLAY UNIT

[BOSE AUDIO WITHOUT NAVIGATION]

< ECU DIAGNOSIS >

WI: With iPod

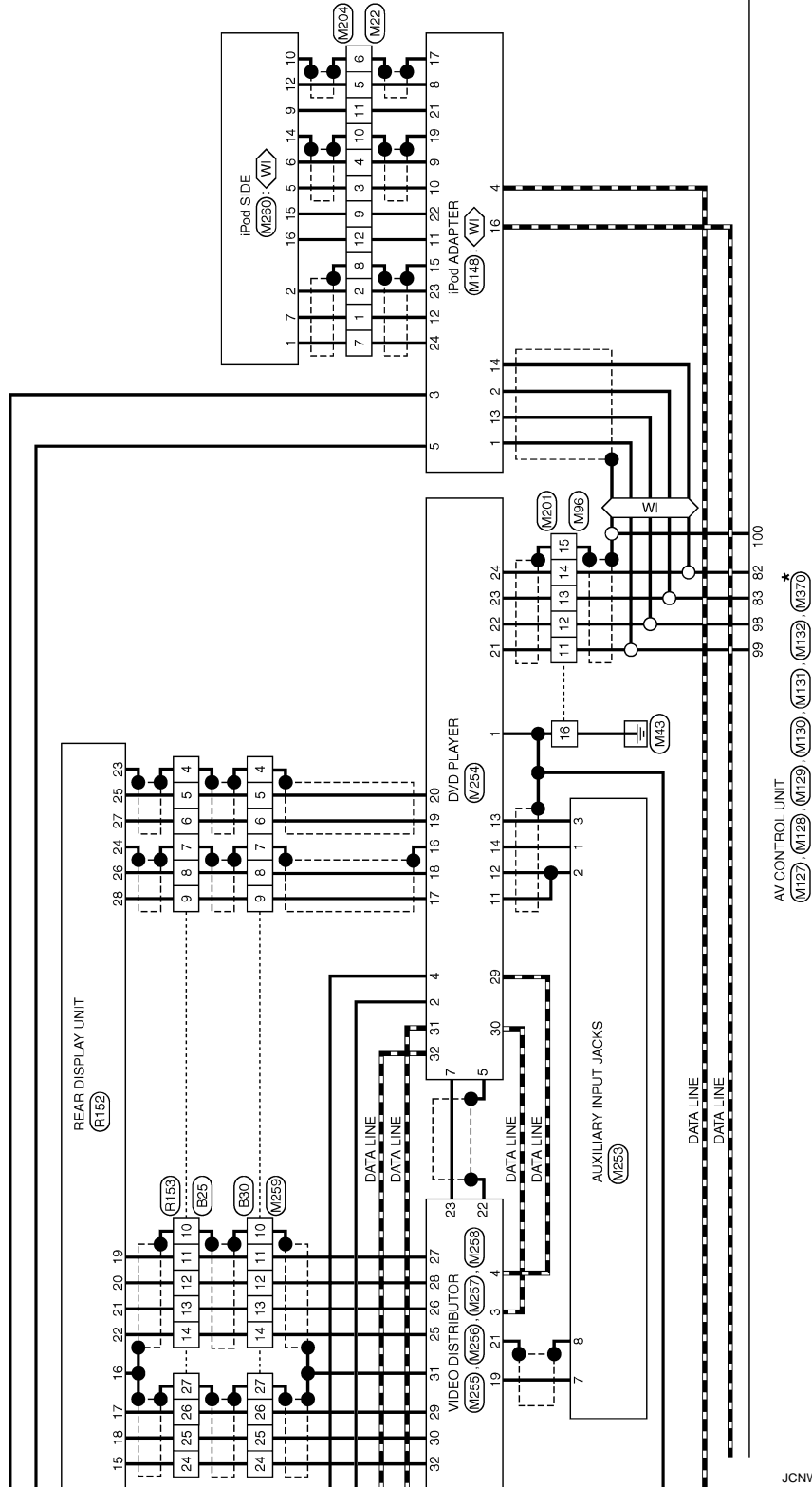

*: This connector is not shown in "Harness Layout".

JCNWM1874GI

A
B
C
D
E
F
G
H
I
J
K
L
M
N
O
P

AV

REAR DISPLAY UNIT

[BOSE AUDIO WITHOUT NAVIGATION]

< ECU DIAGNOSIS >

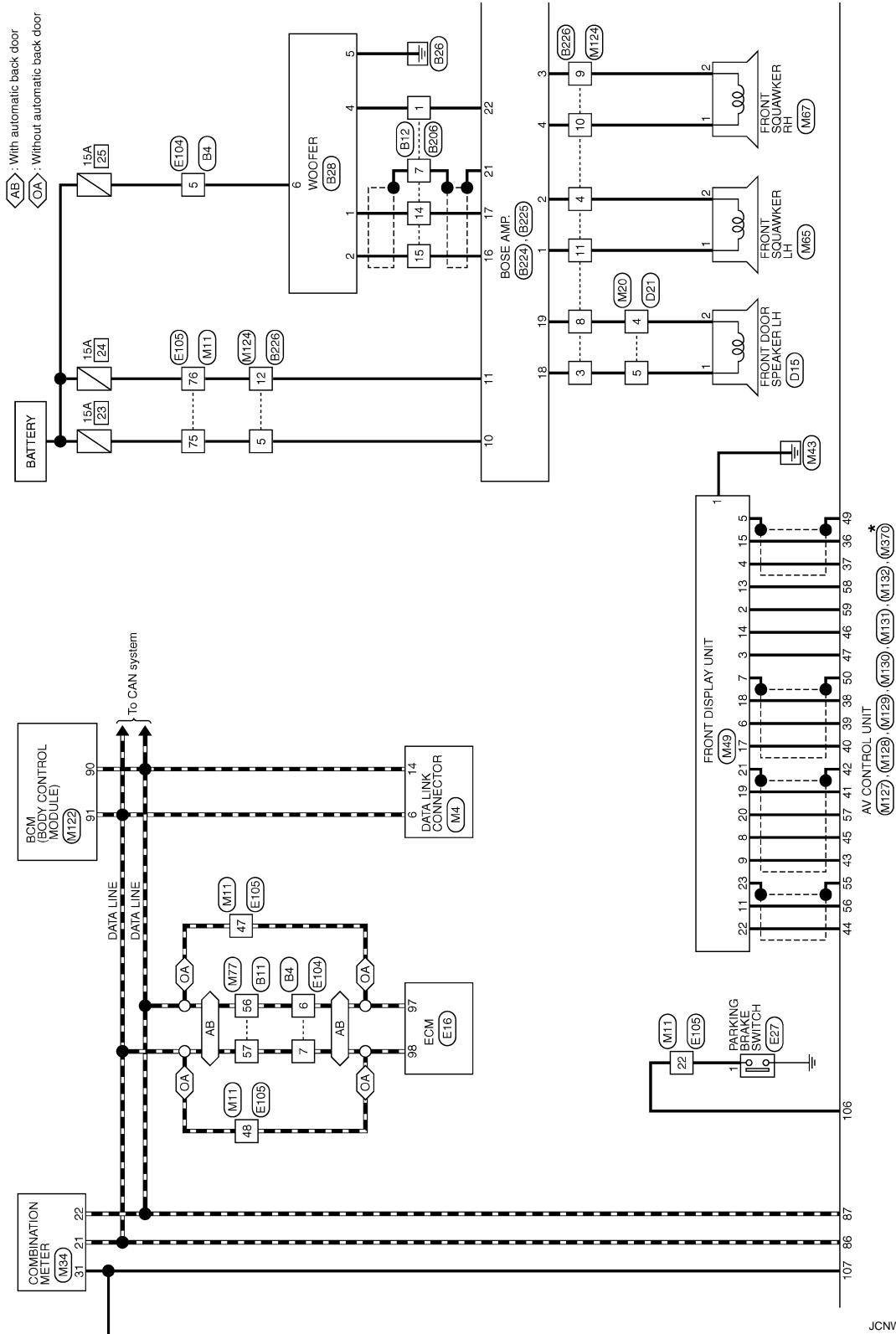

*: This connector is not shown in "Harness Layout".

JCNWM1875GI

REAR DISPLAY UNIT

[BOSE AUDIO WITHOUT NAVIGATION]

< ECU DIAGNOSIS >

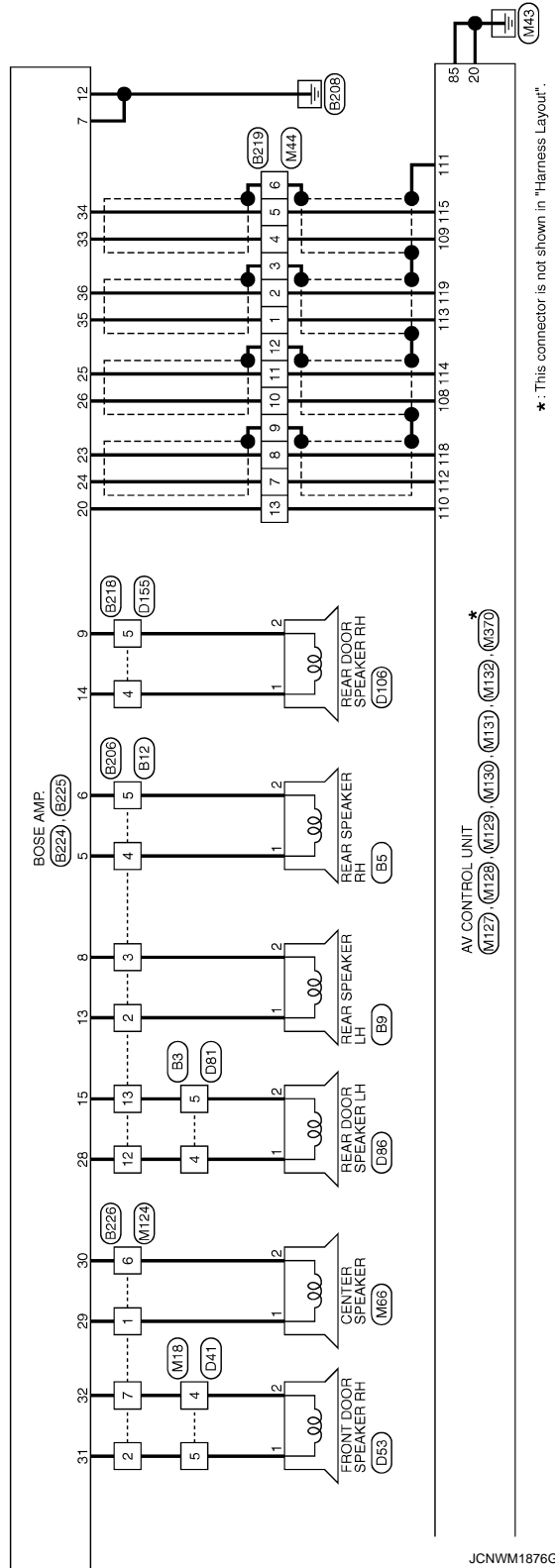

A
B
C
D
E
F
G
H
I
J
K
L
M
AV
O
P

JCNWM1876GI

REAR DISPLAY UNIT

[BOSE AUDIO WITHOUT NAVIGATION]

< ECU DIAGNOSIS >

BOSE AUDIO WITHOUT NAVIGATION WITH DVD ENTERTAINMENT SYSTEM

Connector No.	B3
Connector Name	WIRE TO WIRE
Connector Type	TK10FW-NS8



Terminal No.	Color of Wire	Signal Name [Specification]
4	LG	-
5	O	-

Connector No.	B4
Connector Name	WIRE TO WIRE
Connector Type	NS16MW-CS



Terminal No.	Color of Wire	Signal Name [Specification]
4	R	-
5	O	-
6	P	-
7	L	-

Connector No.	B5
Connector Name	REAR SPEAKER RH
Connector Type	TK02FBR



Terminal No.	Color of Wire	Signal Name [Specification]
1	V	-
2	LG	-

Connector No.	B9
Connector Name	REAR SPEAKER LH
Connector Type	TK02FBR



Terminal No.	Color of Wire	Signal Name [Specification]
1	SB	-
2	GR	-

Connector No.	B11
Connector Name	WIRE TO WIRE
Connector Type	TH80MW-CS19

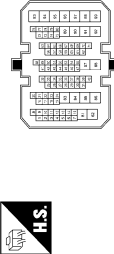

Terminal No.	Color of Wire	Signal Name [Specification]
1	SHIELD	-
2	B	-
3	R/L	-
4	R/W	-
8	SHIELD	-
9	BR/L	-
10	Y/G	-
11	Y/L	-
12	W/L	-
41	O	-
42	SB	-

43	G	-
44	BR	-
45	L	-
46	GR	-
47	V	-
48	GR	- [With rear view camera and telephone]
48	BR	- [With rear view camera without telephone]
49	Y	-
50	SHIELD	-
51	B	-
56	P	-
57	L	-
58	R	-
59	SHIELD	-
60	B	-
61	R/L	-
62	R/W	-
68	R	-
69	SHIELD	-
70	W/R	-
71	B/R	-

Connector No.	B12
Connector Name	WIRE TO WIRE
Connector Type	NS16FW-CS

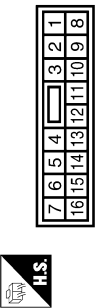

Terminal No.	Color of Wire	Signal Name [Specification]
1	W	-
2	SB	-
3	GR	-
4	V	-
5	LG	-
7	SHIELD	-
12	LG	-
13	O	-
14	W/R	-
15	B/R	-

REAR DISPLAY UNIT

[BOSE AUDIO WITHOUT NAVIGATION]

< ECU DIAGNOSIS >

BOSE AUDIO WITHOUT NAVIGATION WITH DVD ENTERTAINMENT SYSTEM

Connector No.	B25
Connector Name	WIRE TO WIRE
Connector Type	TH22MW-NH



1	2	3	4	5	6	7	8	9	10	11	12	13	14	15	16
17	18	19	20	21	22	23	24	25	26	27	28	29	30	31	32

Terminal No.	Color of Wire	Signal Name [Specification]
1	SB	-
2	B	-
4	SHIELD	-
5	W/R	-
6	W/L	-
7	SHIELD	-
8	GR/V	-
9	W/L	-
10	SHIELD	-
11	W/L	-
12	Y/G	-

Connector No.	B30
Connector Name	WIRE TO WIRE
Connector Type	TH22FW-NH



16	15	14	13	12	11	10	9	8	7	6	5	4	3	2	1
32	31	30	29	28	27	26	25	24	23	22	21	20	19	18	17

Terminal No.	Color of Wire	Signal Name [Specification]
1	SB	-
3	G	-
4	SHIELD	-
5	W/R	-
6	W/L	-
7	SHIELD	-
8	GR/V	-
9	W/L	-
10	SHIELD	-
11	W/L	-
12	Y/G	-

13	Y/L	-
14	BR/L	-
16	V	-
18	O	-
21	B/R	-
22	W/R	-
23	SHIELD	-
24	B	-
25	R/L	-
26	R/W	-
27	SHIELD	-
28	B	-
29	W	-
30	SHIELD	-
31	P	-

Connector No.	B28
Connector Name	WOOFER
Connector Type	RS28FGY-PR



Terminal No.	Color of Wire	Signal Name [Specification]
1	W/R	SOUND SIGNAL WOOFER (-)
2	B/R	SOUND SIGNAL WOOFER (+)
4	W	WOOFER AMP ON SIGNAL
5	B/W	GND
6	O	BAT

Connector No.	B33
Connector Name	TEL ADAPTER UNIT
Connector Type	TH33FW-NH

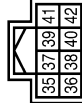

Terminal No.	Color of Wire	Signal Name [Specification]
35	Y	AV COMM (H)
36	BR	AV COMM (L)
40	G	AV COMM (H)
42	GR	AV COMM (L)

A
B
C
D
E
F
G
H
I
J
K
L
M
N
O
P

AV

JCNWM1878GI

REAR DISPLAY UNIT

[BOSE AUDIO WITHOUT NAVIGATION]

< ECU DIAGNOSIS >

BOSE AUDIO WITHOUT NAVIGATION WITH DVD ENTERTAINMENT SYSTEM

Connector No.	B48
Connector Name	SATELLITE RADIO TUNER
Connector Type	A16FW

Terminal No.	16	GR	ACC
--------------	----	----	-----



Connector No.	B39
Connector Name	TEL ADAPTER UNIT
Connector Type	TH22FW-NH

Terminal No.	20	B	CONTROL SIGNAL
Terminal No.	24	B/W	CONTROL SIGNAL
Terminal No.	28	BR	VEHICLE SPEED (8-PULSE)
Terminal No.	29	B	MICROPHONE VCC

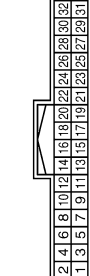

Terminal No.	Color of Wire	Signal Name [Specification]
1	W/L	SOUND SIGNAL LH (-)
2	Y/L	SOUND SIGNAL LH (+)
3	Y/G	SOUND SIGNAL RH (-)
4	BR/L	SOUND SIGNAL RH (+)
5	SHIELD	SHIELD
6	SHIELD	SHIELD
8	R/W	REQUEST (SAT->CONT)
9	R/L	COMM (SAT->CONT)
10	B	COMM (CONT->SAT)
12	V	BATTERY
15	B	GND

Connector No.	B206
Connector Name	WIRE TO WIRE
Connector Type	NS16MW-CS

Terminal No.	12	G	WIRE TO WIRE
Terminal No.	13	R	WIRE TO WIRE
Terminal No.	14	Y	WIRE TO WIRE
Terminal No.	15	B/R	WIRE TO WIRE
Terminal No.	16	B/R	WIRE TO WIRE



Connector No.	B77
Connector Name	WIRE TO WIRE
Connector Type	TK2MW

Terminal No.	22	R	REVERSE
Terminal No.	23	G	SENSOR SIGNAL 1
Terminal No.	24	SB	SENSOR SIGNAL 2
Terminal No.	25	O	SENSOR SIGNAL 3
Terminal No.	26	BR	VEHICLE SPEED (8-PULSE)
Terminal No.	30	GR	ACC
Terminal No.	31	B	GND
Terminal No.	32	V	BATTERY

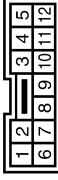

Terminal No.	5	SHIELD	SHIELD
Terminal No.	6	B	CAMERA IMAGE SIGNAL
Terminal No.	7	R/W	GND
Terminal No.	8	R/L	CAMERA ON SIGNAL
Terminal No.	11	SHIELD	SHIELD
Terminal No.	12	B	CAMERA IMAGE SIGNAL
Terminal No.	14	L	CONNECTION RECOGNITION
Terminal No.	17	BR	AV COMM (L)
Terminal No.	18	Y	AV COMM (H)
Terminal No.	19	GR	AV COMM (L)
Terminal No.	20	G	AV COMM (H)

Terminal No.	6	R/L	SHIELD
Terminal No.	7	R/W	SHIELD
Terminal No.	8	B	SHIELD
Terminal No.	9	SHIELD	SHIELD

Terminal No.	22	R	REVERSE
Terminal No.	23	G	SENSOR SIGNAL 1
Terminal No.	24	SB	SENSOR SIGNAL 2
Terminal No.	25	O	SENSOR SIGNAL 3
Terminal No.	26	BR	VEHICLE SPEED (8-PULSE)
Terminal No.	30	GR	ACC
Terminal No.	31	B	GND
Terminal No.	32	V	BATTERY

Terminal No.	5	SHIELD	SHIELD
Terminal No.	6	B	CAMERA IMAGE SIGNAL
Terminal No.	7	R/W	GND
Terminal No.	8	R/L	CAMERA ON SIGNAL
Terminal No.	11	SHIELD	SHIELD
Terminal No.	12	B	CAMERA IMAGE SIGNAL
Terminal No.	14	L	CONNECTION RECOGNITION
Terminal No.	17	BR	AV COMM (L)
Terminal No.	18	Y	AV COMM (H)
Terminal No.	19	GR	AV COMM (L)
Terminal No.	20	G	AV COMM (H)

JCNWM1879GI

REAR DISPLAY UNIT

[BOSE AUDIO WITHOUT NAVIGATION]

< ECU DIAGNOSIS >

BOSE AUDIO WITHOUT NAVIGATION WITH DVD ENTERTAINMENT SYSTEM

Connector No.	B218
Connector Name	WIRE TO WIRE
Connector Type	TK10FW-ANS

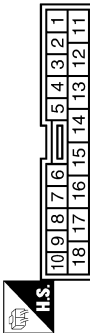

Connector No.	B219
Connector Name	WIRE TO WIRE
Connector Type	TH32MP-NH



Terminal No.	Color of Wire	Signal Name [Specification]
4	L	[With BOSE system]
5	O	[With BOSE system]

Terminal No.	Color of Wire	Signal Name [Specification]
1	W/R	
2	B/R	
3	SHIELD	
4	W/R	
5	B/R	
6	SHIELD	
7	GR/V	
8	W/L	
9	SHIELD	
10	GR/V	
11	W/L	

Connector No.	B224
Connector Name	BOSE AMP.
Connector Type	SGA12FBR-SJAZ

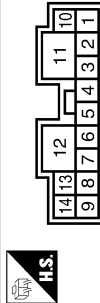

Connector No.	B225
Connector Name	BOSE AMP.
Connector Type	SCA19FBR-SGA4

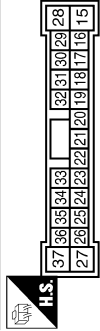

Terminal No.	Color of Wire	Signal Name [Specification]
1	LG	SOUND SIGNAL FRONT SQUAWKER LH (+)
2	V	SOUND SIGNAL FRONT SQUAWKER LH (-)
3	L	SOUND SIGNAL FRONT SQUAWKER RH (-)
4	P	SOUND SIGNAL FRONT SQUAWKER RH (+)
5	Y	SOUND SIGNAL REAR SPEAKER RH (+)
6	BR	SOUND SIGNAL REAR SPEAKER RH (-)
7	B	GND
8	BR	SOUND SIGNAL REAR SPEAKER LH (-)
9	O	SOUND SIGNAL REAR DOOR SPEAKER RH (-)
10	SB	BATTERY
11	GR	BATTERY

Terminal No.	Color of Wire	Signal Name [Specification]
15	R	SOUND SIGNAL REAR DOOR SPEAKER LH (-)
16	B/R	SOUND SIGNAL WOOFER (+)
17	W/R	SOUND SIGNAL WOOFER (-)
18	W	SOUND SIGNAL FRONT DOOR SPEAKER LH (-)
19	B	SOUND SIGNAL FRONT DOOR SPEAKER LH (-)
20	SB	AMP. ON SIGNAL
21	SHIELD	SHIELD
22	W	WOOFER AMP. ON SIGNAL
23	W/L	SOUND SIGNAL REAR LH (-)
24	GR/V	SOUND SIGNAL REAR LH (+)
25	W/L	SOUND SIGNAL REAR RH (-)

12	SHIELD
13	SB

26	GR/V	SOUND SIGNAL REAR RH (+)
28	G	SOUND SIGNAL REAR DOOR SPEAKER LH (+)
29	V	SOUND SIGNAL CENTER SPEAKER (+)
30	P	SOUND SIGNAL CENTER SPEAKER (-)
31	BR	SOUND SIGNAL FRONT DOOR SPEAKER RH (+)
32	Y	SOUND SIGNAL FRONT DOOR SPEAKER RH (-)
33	W/R	SOUND SIGNAL FRONT RH (+)
34	B/R	SOUND SIGNAL FRONT RH (-)
35	W/R	SOUND SIGNAL FRONT LH (-)
36	B/R	SOUND SIGNAL FRONT LH (-)

JCNWM1880GI

A B C D E F G H I J K L M N O P

AV

REAR DISPLAY UNIT

[BOSE AUDIO WITHOUT NAVIGATION]

< ECU DIAGNOSIS >

BOSE AUDIO WITHOUT NAVIGATION WITH DVD ENTERTAINMENT SYSTEM

Connector No.	B226
Connector Name	WIRE TO WIRE
Connector Type	NS2MBR-CS

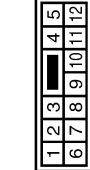

Terminal No.	Color of Wire	Signal Name [Specification]
1	V	
2	BR	
3	W	
4	V	
5	SB	
6	P	
7	Y	
8	B	
9	L	
10	P	
11	LG	
12		

Connector No.	B465
Connector Name	ANTENNA BASE (SATELLITE ANTENNA) WITH BOSE SYSTEM WITHOUT NAVIGATION SYSTEM
Connector Type	GT16C-1PP-HU



Terminal No.	1	Color of Wire	-	Signal Name [Specification]	SATELLITE ANTENNA
--------------	---	---------------	---	-----------------------------	-------------------

Terminal No.	12	GR	-
--------------	----	----	---

Connector No.	B471
Connector Name	TEL ADAPTER UNIT
Connector Type	GT16C-1S-HU



Terminal No.	33	Color of Wire	-	Signal Name [Specification]	TEL ANTENNA
Terminal No.	34	Color of Wire	SHIELD	Signal Name [Specification]	SHIELD

Connector No.	D15
Connector Name	FRONT DOOR SPEAKER LH (WITH BOSE SYSTEM)
Connector Type	NS02FBR-CS



Terminal No.	1	Color of Wire	L	Signal Name [Specification]	-[Type A]
Terminal No.	2	Color of Wire	B	Signal Name [Specification]	-[Type B]

Connector No.	B482
Connector Name	SATELLITE RADIO TUNER
Connector Type	FAK6A



Terminal No.	33	Color of Wire	-	Signal Name [Specification]	SATELLITE ANTENNA
--------------	----	---------------	---	-----------------------------	-------------------

Connector No.	D41
Connector Name	WIRE TO WIRE
Connector Type	TH4DFW-CS15

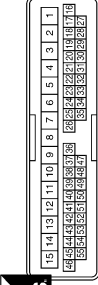

Terminal No.	4	Color of Wire	B/R	Signal Name [Specification]	-[Type A]
Terminal No.	4	Color of Wire	B	Signal Name [Specification]	-[Type B]
Terminal No.	5	Color of Wire	BR	Signal Name [Specification]	-[Type A]
Terminal No.	5	Color of Wire	W	Signal Name [Specification]	-[Type B]

JCNWM1881GI

REAR DISPLAY UNIT

[BOSE AUDIO WITHOUT NAVIGATION]

< ECU DIAGNOSIS >

BOSE AUDIO WITHOUT NAVIGATION WITH DVD ENTERTAINMENT SYSTEM

Connector No.	D53
Connector Name	FRONT DOOR SPEAKER RH (WITH BOSE SYSTEM)
Connector Type	NS2ZFB-CS



Terminal No.	Color of Wire	Signal Name [Specification]
1	BR	- [Type A]
1	W	- [Type B]
2	B/R	- [Type A]
2	B	- [Type B]

Connector No.	D81
Connector Name	WIRE TO WIRE
Connector Type	TK10MW-NS3

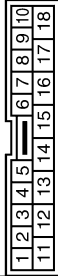

Terminal No.	Color of Wire	Signal Name [Specification]
4	L	-
5	W	-

Connector No.	D98
Connector Name	REAR DOOR SPEAKER LH (WITH BOSE SYSTEM)
Connector Type	NS2ZFB-CS



Terminal No.	Color of Wire	Signal Name [Specification]
1	L	-
2	W	-

Connector No.	D106
Connector Name	REAR DOOR SPEAKER RH (WITH BOSE SYSTEM)
Connector Type	NS2ZFB-CS



Terminal No.	Color of Wire	Signal Name [Specification]
1	O	- [Type A]
1	L	- [Type B]
2	B/P	- [Type A]
2	W	- [Type B]

Connector No.	D155
Connector Name	WIRE TO WIRE
Connector Type	TK10MW-NS3

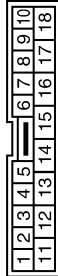

Connector No.	D182
Connector Name	WIRE TO WIRE
Connector Type	TK12FW

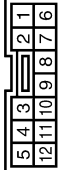

Connector No.	D192
Connector Name	REAR VIEW CAMERA
Connector Type	TK16MGY-TV



Terminal No.	Color of Wire	Signal Name [Specification]
4	O	- [Type A]
4	L	- [Type B]
5	B/P	- [Type A]
5	W	- [Type B]

Terminal No.	Color of Wire	Signal Name [Specification]
6	R	-
7	G	-
8	B	-
9	SHIELD	-

Terminal No.	Color of Wire	Signal Name [Specification]
1	R	CAMERA ON SIGNAL
2	G	GND
3	B	CAMERA IMAGE SIGNAL
4	SHIELD	SHIELD

Connector No.	EB
Connector Name	WIRE TO WIRE
Connector Type	TK16MGY-TV



Terminal No.	Color of Wire	Signal Name [Specification]
4	R	-

JCNWM1882GI

A
B
C
D
E
F
G
H
I
J
K
L
M
O
P

AV

REAR DISPLAY UNIT

[BOSE AUDIO WITHOUT NAVIGATION]

< ECU DIAGNOSIS >

BOSE AUDIO WITHOUT NAVIGATION WITH DVD ENTERTAINMENT SYSTEM

Connector No.	E18
Connector Name	ECM
Connector Type	RH24FB-RZ8-L-LH

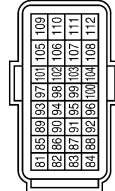

Terminal No.	Color of Wire	Signal Name [Specification]
97	P	VEHGAN-L
98	L	VEHGAN-H

Connector No.	E18
Connector Name	BACK-UP LAMP RELAY
Connector Type	MS02FL-M2-LC

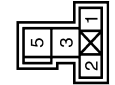

Terminal No.	Color of Wire	Signal Name [Specification]
1	LG	-
2	R	-
3	LG	-
5	R	-

Connector No.	E27
Connector Name	PARKING BRAKE SWITCH
Connector Type	F01FB-A



Terminal No.	Color of Wire	Signal Name [Specification]
1	P	-

Connector No.	E104
Connector Name	WIRE TO WIRE
Connector Type	NSJ6FW-CS

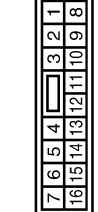

Terminal No.	Color of Wire	Signal Name [Specification]
4	R	-
5	L	-
6	P	-
7	L	-

Connector No.	E105
Connector Name	WIRE TO WIRE
Connector Type	TH70MW-CS10-M3

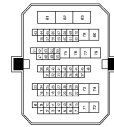

Terminal No.	Color of Wire	Signal Name [Specification]
5	LG	-
22	P	-
47	P	-
48	L	-
75	BR	-
76	GR	-
78	V	-

Connector No.	F23
Connector Name	TCM (TRANSMISSION CONTROL MODULE)
Connector Type	RH40FB-RZ6-L-RH

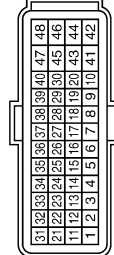

Terminal No.	Color of Wire	Signal Name [Specification]
19	G/B	REV LAMP RELAY

Connector No.	F123
Connector Name	WIRE TO WIRE
Connector Type	TK6FGY-1V

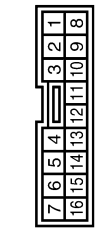

Terminal No.	Color of Wire	Signal Name [Specification]
4	G/B	-

Connector No.	M1
Connector Name	FUSE BLOCK (J/B)
Connector Type	NSJ0FW-M2

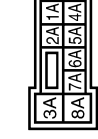

Terminal No.	Color of Wire	Signal Name [Specification]
2A	G	-
5A	R	-

JCNWM1883GI

REAR DISPLAY UNIT

[BOSE AUDIO WITHOUT NAVIGATION]

< ECU DIAGNOSIS >

BOSE AUDIO WITHOUT NAVIGATION WITH DVD ENTERTAINMENT SYSTEM

Connector No.	M3
Connector Name	FUSE BLOCK (J/B)
Connector Type	NS12FW-CS

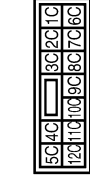

Terminal No.	Color of Wire	Signal Name [Specification]
12C	O	-

Connector No.	M4
Connector Name	DATA LINK CONNECTOR
Connector Type	BD16FW

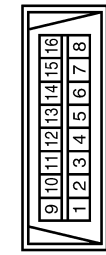

Terminal No.	Color of Wire	Signal Name [Specification]
6	L	-
14	P	-

Connector No.	M11
Connector Name	WIRE TO WIRE
Connector Type	TH10FW-CS10-M3

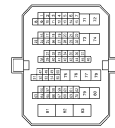

Terminal No.	Color of Wire	Signal Name [Specification]
5	O	-
22	G	-
47	P	-
48	L	-
75	BR	-
76	R	-
78	Y	-

Connector No.	M18
Connector Name	WIRE TO WIRE
Connector Type	TH40MW-CS15

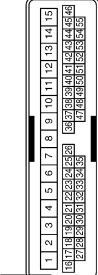

Terminal No.	Color of Wire	Signal Name [Specification]
4	W	-
5	BR	- [Type A and without BOSE system type B]
5	B	- [With BOSE system type B]

Connector No.	M20
Connector Name	WIRE TO WIRE
Connector Type	TH40MW-CS15

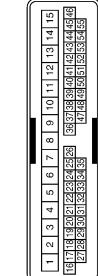

Terminal No.	Color of Wire	Signal Name [Specification]
4	B	-
5	L	-

Connector No.	M22
Connector Name	WIRE TO WIRE
Connector Type	TH12FW-NH

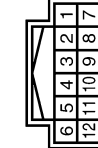

Terminal No.	Color of Wire	Signal Name [Specification]
1	V	-
2	R	-
3	R	-
4	G	-
5	W	-
6	SHIELD	-
7	LG	-
8	SHIELD	-
9	BR	-
10	SHIELD	-
11	L	-

Connector No.	M23
Connector Name	WIRE TO WIRE
Connector Type	TH16MW-NH



Terminal No.	Color of Wire	Signal Name [Specification]
1	W	-
2	R	- [With telephone without navigation system]
3	B	-
4	SHIELD	-

JCNWM1884GI

A
B
C
D
E
F
G
H
I
J
K
L
M
N
O
P

AV

REAR DISPLAY UNIT

[BOSE AUDIO WITHOUT NAVIGATION]

< ECU DIAGNOSIS >

BOSE AUDIO WITHOUT NAVIGATION WITH DVD ENTERTAINMENT SYSTEM

Connector No.	M30
Connector Name	STEERING ANGLE SENSOR
Connector Type	TH08FW-NH

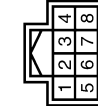

Terminal No.	Color of Wire	Signal Name [Specification]
1	B	-
3	L	-
4	G	-
6	SB	-
8	O	-

Connector No.	M33
Connector Name	COMBINATION SWITCH (SPIRAL CABLE)
Connector Type	TH08FGY-1V

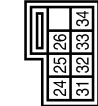

Terminal No.	Color of Wire	Signal Name [Specification]
24	BR	- [With audio steering switch and telephone]
31	G	- [With audio steering switch and telephone]
33	L	- [With audio steering switch and telephone]

Connector No.	M34
Connector Name	COMBINATION METER
Connector Type	TH40FW-NH

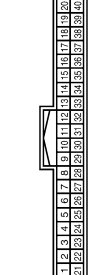

Terminal No.	Color of Wire	Signal Name [Specification]
21	L	CAN-H
22	P	CAN-L
31	V	VEHICLE SPEED (8-PULSE)

Connector No.	M44
Connector Name	WIRE TO WIRE
Connector Type	TH42FW-NH

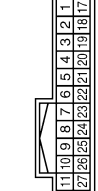

Terminal No.	Color of Wire	Signal Name [Specification]
1	G	-
2	R	-
3	SHIELD	-
4	B	-
5	W	-
6	SHIELD	-
7	O	- [Type A]
7	L	- [Type B]
8	SB	- [Type A]
8	R	- [Type B]
9	SHIELD	-

Terminal No.	10	V
11	LG	-
12	SHIELD	-
13	P	-

Connector No.	M49
Connector Name	FRONT DISPLAY UNIT
Connector Type	TH24FW-NH

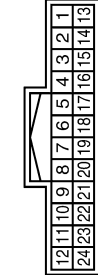

Terminal No.	Color of Wire	Signal Name [Specification]
1	B	GND
2	Y	INVERTER VCCI [Without navigation system]
3	O	SIGNAL VCCI [Without navigation system]
4	P	COMPOSITE IMAGE GND [Without navigation system]
5	SHIELD	SHIELD [Without navigation system]
6	L	RGB (G-GREEN) SIGNAL [Without navigation system]
7	SHIELD	SHIELD
8	G	HP [Without navigation system]
9	W	RGB AREA (YS) SIGNAL
11	R	COMM (CONT->DISP)
13	BR	INVERTER GND [Without navigation system]

14	LG	SIGNAL GND [Without navigation system]
15	L	COMPOSITE IMAGE SIGNAL [Without navigation system]
17	G	RGB (RED) SIGNAL
18	Y	RGB (BLUE) SIGNAL [Without navigation system]
19	B	RGB SYNC
20	R	VP
21	SHIELD	SHIELD
22	G	COMM (DISP->CONT)
23	SHIELD	SHIELD

JCNWM1885G1

REAR DISPLAY UNIT

[BOSE AUDIO WITHOUT NAVIGATION]

< ECU DIAGNOSIS >

BOSE AUDIO WITHOUT NAVIGATION WITH DVD ENTERTAINMENT SYSTEM

Connector No.	M65
Connector Name	FRONT SQUAWKER LH
Connector Type	TK02FBR



Terminal No.	Color of Wire	Signal Name [Specification]
1	LG	[With BOSE system]
2	Y	[With BOSE system]

Connector No.	M66
Connector Name	CENTER SPEAKER
Connector Type	TK02FBR



Terminal No.	Color of Wire	Signal Name [Specification]
1	P	
2	O	

Connector No.	M67
Connector Name	FRONT SQUAWKER RH
Connector Type	TK02FBR



Terminal No.	Color of Wire	Signal Name [Specification]
1	BR	
2	R	[With BOSE system]

Connector No.	M77
Connector Name	WIRE TO WIRE
Connector Type	TH80FW-C519

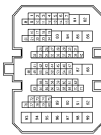

Terminal No.	Color of Wire	Signal Name [Specification]
1	SHIELD	
2	B	
3	W	
4	R	
8	SHIELD	
9	W	
10	R	
11	G	
12	B	
41	O	
42	SB	

43	L	
44	V	
45	P	
46	R	
47	Y	
48	L	
49	G	
50	SHIELD	
51	W	
56	P	
57	L	
58	SS	
59	SHIELD	
60	B	
61	R	
62	W	
68	G	
69	SHIELD	
70	L	
71	R	

Connector No.	M66
Connector Name	WIRE TO WIRE
Connector Type	TH18FW-NH

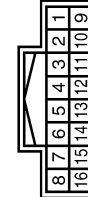

Terminal No.	Color of Wire	Signal Name [Specification]
1	Y	
3	R	
4	L	
5	L	
6	R	
7	SHIELD	
8	R	
9	G	
11	B	
12	G	
13	R	

14	W
15	SHIELD
16	B

A
B
C
D
E
F
G
H
I
J
K
L
M
N
O
P

AV

JCNWM1886G1

REAR DISPLAY UNIT

[BOSE AUDIO WITHOUT NAVIGATION]

< ECU DIAGNOSIS >

BOSE AUDIO WITHOUT NAVIGATION WITH DVD ENTERTAINMENT SYSTEM

Connector No.	M122
Connector Name	BCM BODY CONTROL MODULE
Connector Type	TH40FB-NH

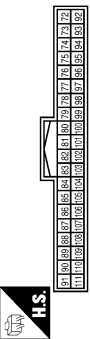

Terminal No.	Color of Wire	Signal Name [Specification]
90	P	CAN-L
91	L	CAN-H

Connector No.	M124
Connector Name	WIRE TO WIRE
Connector Type	NS12FBR-CS

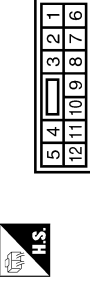

Terminal No.	Color of Wire	Signal Name [Specification]
1	P	-
2	BR	- [Type A]
2	B	- [Type B]
3	L	-
4	Y	-
5	BR	-
6	O	-
7	W	-
8	B	-
9	R	-
10	BR	-

Connector No.	M127
Connector Name	AV CONTROL UNIT (WITH BOSE SYSTEM WITHOUT NAVIGATION SYSTEM)
Connector Type	TH18FW-CS2

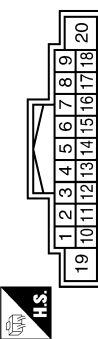

Terminal No.	Color of Wire	Signal Name [Specification]
6	BR	STRG SW A
7	R	ACC
9	R	ILLUMINATION
15	L	STRG SW GND
16	G	STRG SW B
19	Y	BATTERY
20	B	GND

Connector No.	M128
Connector Name	AV CONTROL UNIT (WITH BOSE SYSTEM WITHOUT NAVIGATION SYSTEM)
Connector Type	A12FW



Terminal No.	Color of Wire	Signal Name [Specification]
21	B	SATELLITE RADIO SOUND SIGNAL LH (-)
22	G	SATELLITE RADIO SOUND SIGNAL LH (+)
23	R	SATELLITE RADIO SOUND SIGNAL RH (-)
24	W	SATELLITE RADIO SOUND SIGNAL RH (+)
25	SHIELD	SHIELD
26	SHIELD	SHIELD
28	R	REQUEST (SAT->CONT)
29	W	COMM (SAT->CONT)
30	B	COMM (CONT->SAT)

11	LG
12	R

Connector No.	M125
Connector Name	MULTIFUNCTION SWITCH
Connector Type	TH16FW-NH

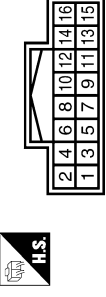

Terminal No.	Color of Wire	Signal Name [Specification]
1	B	GND
3	R	ACC
6	R	AV COMM (H)
8	L	AV COMM (L)
9	V	SW GND
14	W	EJECT SIGNAL

Connector No.	M129
Connector Name	AV CONTROL UNIT (WITH BOSE SYSTEM WITHOUT NAVIGATION SYSTEM)
Connector Type	TH24FW-NH

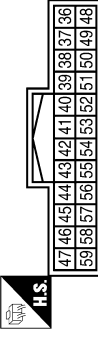

Terminal No.	Color of Wire	Signal Name [Specification]
36	L	COMPOSITE IMAGE SIGNAL
37	P	COMPOSITE IMAGE GND
38	Y	RGB (B:BLUE) SIGNAL
39	L	RGB (G:GREEN) SIGNAL
40	G	RGB (R:RED) SIGNAL
41	B	RGB SYNC
42	SHIELD	SHIELD
43	W	RGB AREA (YS) SIGNAL
44	G	COMM (DISP->CONT)
45	G	HP
46	LG	SIGNAL GND

Terminal No.	Color of Wire	Signal Name [Specification]
47	O	SIGNAL VCC
49	SHIELD	SHIELD
50	SHIELD	SHIELD
55	SHIELD	SHIELD
56	R	COMM (CONT->DISP)
57	R	VP
58	BR	INVERTER GND
59	Y	INVERTER VCC

REAR DISPLAY UNIT

[BOSE AUDIO WITHOUT NAVIGATION]

< ECU DIAGNOSIS >

BOSE AUDIO WITHOUT NAVIGATION WITH DVD ENTERTAINMENT SYSTEM

Connector No.	M130
Connector Name	AV CONTROL UNIT (WITH BOSE SYSTEM WITHOUT NAVIGATION SYSTEM)
Connector Type	TH116FW-NH

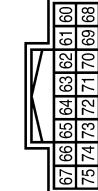

Connector No.	M131
Connector Name	AV CONTROL UNIT (WITH BOSE SYSTEM WITHOUT NAVIGATION SYSTEM)
Connector Type	TH122FW-NH

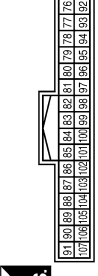

Terminal No.	Color of Wire	Signal Name [Specification]
64	SHIELD	SHIELD
65	W	CAMERA IMAGE SIGNAL
66	L	COMPOSITE IMAGE SIGNAL (With DVD player)
68	P	CONNECTION RECOGNITION SHIELD (With DVD player)
72	SHIELD	SHIELD (With DVD player)
74	R	COMPOSITE IMAGE GND (With DVD player)

Connector No.	M132
Connector Name	AV CONTROL UNIT (WITH BOSE SYSTEM WITHOUT NAVIGATION SYSTEM)
Connector Type	TH121FW-NH



Terminal No.	Color of Wire	Signal Name [Specification]
79	L	TEL VOICE SIGNAL (-)
80	R	TEL VOICE SIGNAL (+)
81	SHIELD	SHIELD
82	W	SOUND SIGNAL RH (-) (With DVD player)
83	R	SOUND SIGNAL RH (+) (With DVD player)
85	B	GND
86	L	CAN-H
87	P	CAN-L
88	R	AV COMM (H)
89	L	AV COMM (L)
90	G	AV COMM (H)

Terminal No.	119	R	SOUND SIGNAL FRONT LH (-)
--------------	-----	---	---------------------------

91	L	AV COMM (L)
98	G	SOUND SIGNAL LH (-) (With DVD player)
99	B	SOUND SIGNAL LH (+) (With DVD player)
100	SHIELD	SHIELD (With DVD player)
101	V	SW GND
103	W	EJECT SIGNAL
104	G	IGNITION
105	SB	REVERSE
106	G	PARKING BRAKE
107	V	VEHICLE SPEED (8-PULSE)

Connector No.	M148
Connector Name	iPod ADAPTER
Connector Type	TH224FW-NH

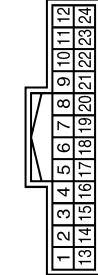

14	W	iPod SOUND SIGNAL RH (-)
15	SHIELD	SHIELD
16	R	AV COMM (H)
17	SHIELD	GND
19	SHIELD	SHIELD
21	L	iPod CONNECTION RECOGNITION
22	BR	ACCESSORY DETECT
23	R	iPod SOUND SIGNAL GND
24	LG	iPod SOUND SIGNAL LH (+)

Terminal No.	Color of Wire	Signal Name [Specification]
108	V	SOUND SIGNAL REAR RH (+)
109	B	SOUND SIGNAL FRONT RH (+)
110	P	AMP. ON SIGNAL
111	SHIELD	SHIELD
112	O	SOUND SIGNAL REAR LH (+) (Type A)
112	L	SOUND SIGNAL REAR LH (+) (Type B)
113	G	SOUND SIGNAL FRONT LH (+)
114	LG	SOUND SIGNAL REAR RH (-)
115	W	SOUND SIGNAL FRONT RH (-)
118	SB	SOUND SIGNAL REAR LH (-) (Type A)
118	R	SOUND SIGNAL REAR LH (-) (Type B)

Terminal No.	Color of Wire	Signal Name [Specification]
1	BR	iPod SOUND SIGNAL LH (+)
2	R	iPod SOUND SIGNAL RH (+)
3	R	ACC
4	L	AV COMM (L)
5	Y	BATTERY
8	W	CHARGE POWER
9	G	COMM (iPod ADAPTER->iPod)
10	R	COMM (iPod->iPod ADAPTER)
11	R	ACCESSORY IDENTIFY
12	V	iPod SOUND SIGNAL RH (+)
13	L	iPod SOUND SIGNAL LH (-)

JCNWM1888GI

A
B
C
D
E
F
G
H
I
J
K
L
M
N
O
P

AV

REAR DISPLAY UNIT

[BOSE AUDIO WITHOUT NAVIGATION]

< ECU DIAGNOSIS >

BOSE AUDIO WITHOUT NAVIGATION WITH DVD ENTERTAINMENT SYSTEM

Connector No.	M204
Connector Name	WIRE TO WIRE
Connector Type	TH12MW-NH

Terminal No.	Color of Wire	Signal Name [Specification]
1	V	-
2	R	-
3	R	-
4	G	-
5	W	-
6	SHIELD	-
7	LG	-
8	SHIELD	-
9	BR	-
10	SHIELD	-
11	L	-

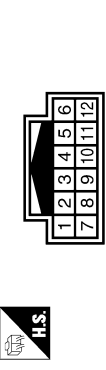

Connector No.	M251
Connector Name	WIRE TO WIRE
Connector Type	TH16MW-NH

Terminal No.	Color of Wire	Signal Name [Specification]
1	Y	-
3	R	-
4	G	-
5	L	-
6	R	-
7	SHIELD	-
8	V	-
9	G	-
11	B	-
12	G	-
13	R	-

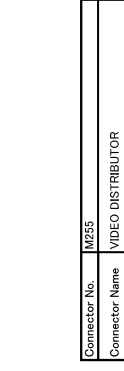

Connector No.	M254
Connector Name	DVD PLAYER
Connector Type	TH32FW-NH

Terminal No.	Color of Wire	Signal Name [Specification]
1	B	GND
2	Y	BATTERY
4	V	ACC
5	SHIELD	SHIELD
7	P	DVD IMAGE SIGNAL
11	B	AUX SOUND SIGNAL LH (-)
12	W	AUX SOUND SIGNAL RH (-)
13	G	AUX SOUND SIGNAL LH (+)
14	R	AUX SOUND SIGNAL RH (+)
16	SHIELD	SHIELD
17	G	HEADPHONE SOUND SIGNAL LH (+)

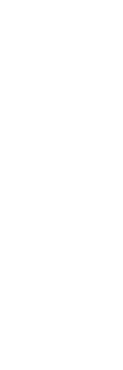
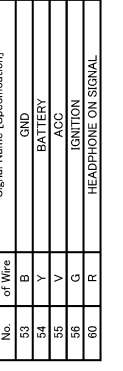

Connector No.	M255
Connector Name	VIDEO DISTRIBUTOR
Connector Type	TH08FW-NH

Terminal No.	Color of Wire	Signal Name [Specification]
53	B	GND
54	Y	BATTERY
55	V	ACC
56	G	IGNITION
60	R	HEADPHONE ON SIGNAL



Connector No.	M253
Connector Name	AUXILIARY INPUT JACKS
Connector Type	A08FW

Terminal No.	Color of Wire	Signal Name [Specification]
1	R	SOUND SIGNAL RH (+)
2	W	SOUND SIGNAL GND
3	G	SOUND SIGNAL LH (-) [Wth DVD player]
7	G	AUX IMAGE SIGNAL
8	SHIELD	SHIELD [Wth DVD player]



JCNWM1889GI

REAR DISPLAY UNIT

[BOSE AUDIO WITHOUT NAVIGATION]

< ECU DIAGNOSIS >

BOSE AUDIO WITHOUT NAVIGATION WITH DVD ENTERTAINMENT SYSTEM

Connector No.	M256
Connector Name	VIDEO DISTRIBUTOR
Connector Type	TH12FW-NH



26	28	30	32	34	36	38	40
25	27	29	31	33	35	37	39



Connector No.	M257
Connector Name	VIDEO DISTRIBUTOR
Connector Type	TH11FW-NH



26	28	30	32	34	36	38	40
25	27	29	31	33	35	37	39



36	G	IGNITION
38	SHIELD	SHIELD
39	V	COMM (DISP->DISP)
40	LG	COMM (DISP->DISP)

Terminal No.	Color of Wire	Signal Name [Specification]
51	B	GND

Terminal No.	Color of Wire	Signal Name [Specification]
25	R	RGB (R/RED) SIGNAL
26	L	RGB (G/GREEN) SIGNAL
27	W	RGB GND
28	G	RGB (B/BLUE) SIGNAL
29	R	YP
30	W	HP
31	SHIELD	SHIELD
32	B	RGB AREA (Y/S) SIGNAL
33	G	COMPOSITE SYNC
34	R	COMPOSITE IMAGE SIGNAL
35	SHIELD	SHIELD

Connector No.	M258
Connector Name	VIDEO DISTRIBUTOR
Connector Type	TH12FW-NH

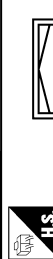

2	4	6	8	10	12	14	16	18	20	22	24
1	3	5	7	9	11	13	15	17	19	21	23



Terminal No.	Color of Wire	Signal Name [Specification]
1	R	AV COMM (H)
2	G	AV COMM (L)
3	R	AV COMM (H)
4	L	AV COMM (L)
6	R	COMPOSITE IMAGE GND
8	L	COMPOSITE IMAGE SIGNAL
15	B	GND
16	B	GND
19	G	AUX IMAGE SIGNAL
21	SHIELD	SHIELD
22	SHIELD	SHIELD

Connector No.	M259
Connector Name	WIRE TO WIRE
Connector Type	TH32MW-NH



1	2	3	4	5	6	7	8	9	10	11	12	13	14	15	16
17	18	19	20	21	22	23	24	25	26	27	28	29	30	31	32

Connector No.	M259
Connector Name	WIRE TO WIRE
Connector Type	TH32MW-NH

Terminal No.	Color of Wire	Signal Name [Specification]
1	Y	-
3	R	-
4	SHIELD	-
5	LG	-
6	V	-
7	SHIELD	-
8	R	-
9	G	-
10	SHIELD	-
11	W	-
12	G	-

13	L	-
14	R	-
16	G	-
18	V	-
19	L	-
21	LG	-
22	V	-
23	SHIELD	-
24	B	-
25	W	-
26	R	-
27	SHIELD	-
28	G	-
29	R	-
30	SHIELD	-
31	R	-

A
B
C
D
E
F
G
H
I
J
K
L
M
N
O
P

AV

JCNWM1890GI

REAR DISPLAY UNIT

[BOSE AUDIO WITHOUT NAVIGATION]

< ECU DIAGNOSIS >

BOSE AUDIO WITHOUT NAVIGATION WITH DVD ENTERTAINMENT SYSTEM

Connector No.	M370
Connector Name	AV CONTROL UNIT WITH BOSE SYSTEM WITHOUT NAVIGATION SYSTEM
Connector Type	GT13SCH-2/1S-HU

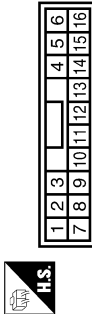

Terminal No.	Color of Wire	Signal Name [Specification]
1	LG	iPod SOUND SIGNAL LH (+)
2	R	iPod SOUND SIGNAL LH (-)
5	R	COMM (iPod->iPod ADAPTER)
6	G	COMM (iPod ADAPTER->iPod)
7	V	iPod SOUND SIGNAL RH (+)
8	L	iPod SOUND SIGNAL RH (-)
9	L	iPod CONNECTION RECOGNITION GND
10	SHIELD	CHARGE POWER
12	W	SHIELD
14	SHIELD	ACCESSORY DETECT
15	BR	ACCESSORY DETECT
16	R	ACCESSORY IDENTIFY

Connector No.	M303
Connector Name	COMBINATION SWITCH (SPIRAL CABLE)
Connector Type	TK08FGY



Terminal No.	Color of Wire	Signal Name [Specification]
14	-	-
15	-	-
17	-	-

Connector No.	M370
Connector Name	AV CONTROL UNIT WITH BOSE SYSTEM WITHOUT NAVIGATION SYSTEM
Connector Type	GT13SC-2/1S-HU



Terminal No.	Color of Wire	Signal Name [Specification]
33	-	FM SUB
34	-	AM-FM MAIN
35	-	ANTENNA AMP. ON SIGNAL

Connector No.	M375
Connector Name	WIRE TO WIRE
Connector Type	GT13SH-2/1S-HU



Terminal No.	Color of Wire	Signal Name [Specification]
1	-	-
2	-	-
3	-	-

Connector No.	M376
Connector Name	WIRE TO WIRE
Connector Type	GT13SCN-2/1PP-HU



Terminal No.	Color of Wire	Signal Name [Specification]
1	-	-
2	-	-
3	-	-

Connector No.	M378
Connector Name	ANTENNA BASE (ANTENNA AMP.)
Connector Type	GT13SSN-1/1PP-HU



Terminal No.	Color of Wire	Signal Name [Specification]
1	-	-
3	-	-

Connector No.	M379
Connector Name	GLASS ANTENNA
Connector Type	GT13SCN-1/1PP-HU



Terminal No.	Color of Wire	Signal Name [Specification]
2	-	FM SUB

Connector No.	FT
Connector Name	WIRE TO WIRE
Connector Type	TH16FW-NH

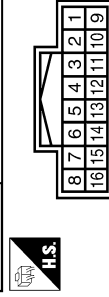

Terminal No.	Color of Wire	Signal Name [Specification]
1	R/W	-
2	R/L	- [With telephones without navigation system]
3	B	-
4	SHIELD	-

JCNWM1891GI

REAR DISPLAY UNIT

[BOSE AUDIO WITHOUT NAVIGATION]

< ECU DIAGNOSIS >

BOSE AUDIO WITHOUT NAVIGATION WITH DVD ENTERTAINMENT SYSTEM

Connector No.	R20
Connector Name	MICROPHONE
Connector Type	TH24FW



Terminal No.	Color of Wire	Signal Name [Specification]
1	R/W	MICROPHONE SIGNAL (+)
2	R/L	MICROPHONE SIGNAL (-) (Only in vehicle with navigation system)
4	B	MICROPHONE POWER

Connector No.	R152
Connector Name	REAR DISPLAY UNIT
Connector Type	TH32FW-NH



Terminal No.	Color of Wire	Signal Name [Specification]
1	B	GND
2	B	GND
3	Y/R	BATTERY
4	Y/R	BATTERY
5	R	HEADPHONE ON SIGNAL
6	V/Y	ACC
8	SHIELD	SHIELD
9	V	COMM (DISP->DIST)
10	LG	COMM (DIST->DISP)
11	G	IGNITION
12	SHIELD	SHIELD

Connector No.	R153
Connector Name	WIRE TO WIRE
Connector Type	TH32FW-NH



Terminal No.	Color of Wire	Signal Name [Specification]
1	Y/R	-
2	B	-
4	SHIELD	-
5	LG	-
6	V	-
7	SHIELD	-
8	BR	-
9	Y	-
10	SHIELD	-
11	W/L	-
12	Y/G	-

13	G	COMPOSITE SYNC
14	R	COMPOSITE IMAGE SIGNAL
15	B	RGB AREA (V/S) SIGNAL
16	SHIELD	GND
17	R	VP
18	W	HP
19	W/L	RGB GND
20	Y/G	RGR (B/BLUE) SIGNAL
21	Y/L	RGB (G/GREEN) SIGNAL
22	BR/L	RGB (R/RED) SIGNAL
23	SHIELD	SHIELD
24	SHIELD	SHIELD
25	LG	HEADPHONE SOUND SIGNAL RH (-)
26	BR	HEADPHONE SOUND SIGNAL LH (-)
27	V	HEADPHONE SOUND SIGNAL RH (+)
28	Y	HEADPHONE SOUND SIGNAL LH (+)

13	Y/L	-
14	BR/L	-
16	G	-
18	V/Y	-
21	LG	-
22	V	-
23	SHIELD	-
24	B	-
25	W	-
26	R	-
27	SHIELD	-
28	G	-
29	R	-
30	SHIELD	-
31	R	-

A
B
C
D
E
F
G
H
I
J
K
L
M
N
O
P

AV

VIDEO DISTRIBUTOR

< ECU DIAGNOSIS >

[BOSE AUDIO WITHOUT NAVIGATION]

VIDEO DISTRIBUTOR

Reference Values

INFOID:000000003457758

TERMINAL LAYOUT

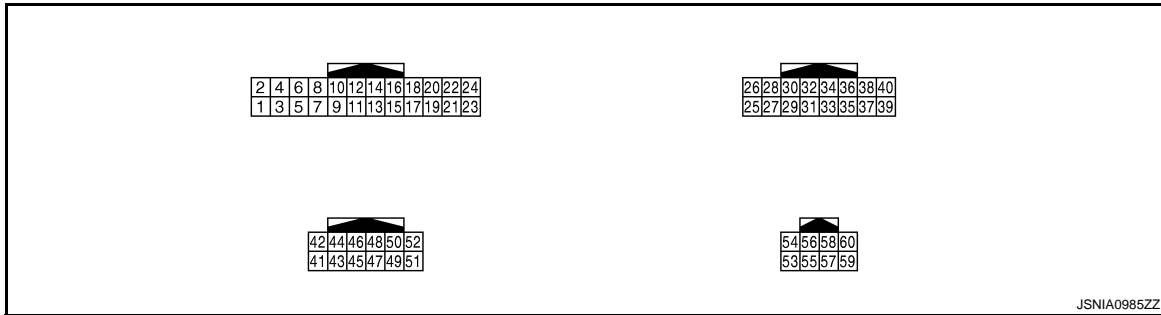

PHYSICAL VALUES

Terminal (Wire color)		Description		Condition		Reference value (Approx.)
+	-	Signal name	Input/ Output			
1 (R)	—	AV communication signal (H)	Input/ Output	—	—	—
2 (G)	—	AV communication signal (L)	Input/ Output	—	—	—
3 (R)	—	AV communication signal (H)	Input/ Output	—	—	—
4 (L)	—	AV communication signal (L)	Input/ Output	—	—	—
8 (L)	6 (R)	Composite image signal for AV control unit	Output	Ignition switch ON	When AUX or DVD image is displayed on front display unit.	 SKIB2251J
15 (B)	Ground	Ground	—	Ignition switch ON	—	0 V
16 (B)	Ground	Ground	—	Ignition switch ON	—	0 V
19 (G)	Ground	AUX image signal	Input	Ignition switch ON	When AUX image is dis- played.	 SKIB2251J
21	—	Shield (AUX image GND)	—	—	—	—
22	—	Shield (DVD image GND)	—	—	—	—

VIDEO DISTRIBUTOR

[BOSE AUDIO WITHOUT NAVIGATION]

< ECU DIAGNOSIS >

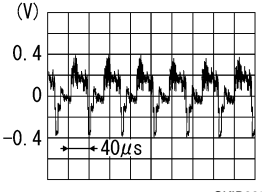
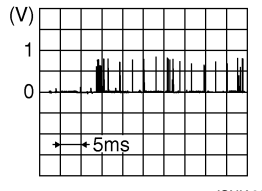
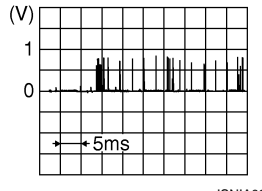
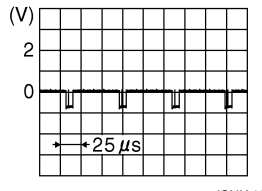
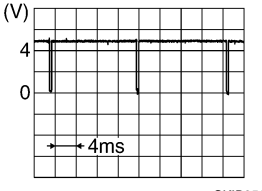
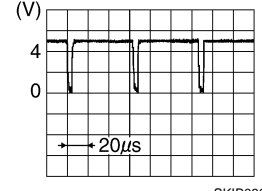
Terminal (Wire color)		Description		Condition		Reference value (Approx.)
+	-	Signal name	Input/ Output			
23 (P)	Ground	DVD image signal	Input	Ignition switch ON	When DVD image is displayed.	 <p style="text-align: right; font-size: small;">SKIB2251J</p>
25 (R)	Ground	RGB image signal (R: red) for rear display unit	Output	Ignition switch ON	Rear seat remote controller operation when AUX or DVD image is displayed on rear display unit.	 <p style="text-align: right; font-size: small;">JSNIA0984ZZ</p>
26 (L)	Ground	RGB image signal (G: green) for rear display unit	Output	Ignition switch ON	Rear seat remote controller operation when AUX or DVD image is displayed on rear display unit.	 <p style="text-align: right; font-size: small;">JSNIA0984ZZ</p>
27 (W)	Ground	RGB ground for rear display unit	—	Ignition switch ON	—	0 V
28 (G)	Ground	RGB image signal (B: blue) for rear display unit	Output	Ignition switch ON	Rear seat remote controller operation when AUX or DVD image is displayed on rear display unit.	 <p style="text-align: right; font-size: small;">JSNIA1090ZZ</p>
29 (R)	Ground	Vertical synchronizing (VP) signal for rear display unit	Input	Ignition switch ON	—	 <p style="text-align: right; font-size: small;">SKIB3598E</p>
30 (W)	Ground	Horizontal synchronizing (HP) signal for rear display	Input	Ignition switch ON	—	 <p style="text-align: right; font-size: small;">SKIB0825E</p>
31	—	Shield	—	—	—	—

A
B
C
D
E
F
G
H
I
J
K
L
M
O
P

AV

VIDEO DISTRIBUTOR

[BOSE AUDIO WITHOUT NAVIGATION]

< ECU DIAGNOSIS >

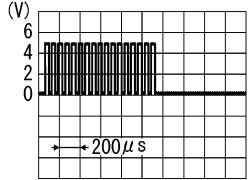
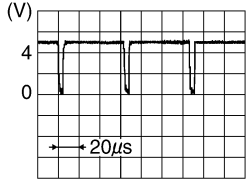
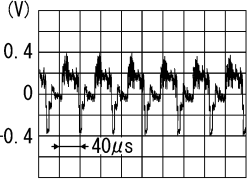
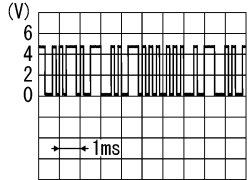
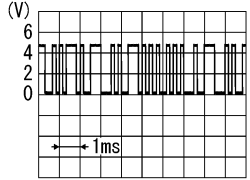
Terminal (Wire color)		Description		Condition		Reference value (Approx.)
+	-	Signal name	Input/ Output			
32 (B)	Ground	RGB area (YS) signal for rear display	Output	Ignition switch ON	When AUX or DVD image is displayed on rear display unit.	0 V
				Ignition switch OFF	Rear seat remote controller operation when AUX or DVD image is displayed on rear display unit.	 <p style="text-align: right; font-size: small;">PKIB4948J</p>
33 (G)	Ground	Composite and RGB image synchronizing signal for rear display	Output	Ignition switch ON	When AUX or DVD image is displayed on rear display unit.	 <p style="text-align: right; font-size: small;">SKIB0825E</p>
34 (R)	Ground	Composite image signal for rear display unit	Output	Ignition switch ON	When AUX or DVD image is displayed on rear display unit.	 <p style="text-align: right; font-size: small;">SKIB2251J</p>
35	—	Shield	—	—	—	—
36 (G)	Ground	Ignition signal	Output	Ignition switch ON	—	0 V
				Ignition switch OFF	—	3.3 V
38	—	Shield	—	—	—	—
39 (V)	Ground	Communication signal (DISP→DIST)	Input	Ignition switch ON	Rear seat remote controller operation when AUX or DVD image is displayed on rear display unit.	 <p style="text-align: right; font-size: small;">PKIB5039J</p>
40 (LG)	Ground	Communication signal (DIST→DISP)	Output	Ignition switch ON	Rear seat remote controller operation when AUX or DVD image is displayed on rear display unit.	 <p style="text-align: right; font-size: small;">PKIB5039J</p>
51 (B)	Ground	Ground	—	Ignition switch ON	—	0 V

VIDEO DISTRIBUTOR

< ECU DIAGNOSIS >

[BOSE AUDIO WITHOUT NAVIGATION]

Terminal (Wire color)		Description		Condition		Reference value (Approx.)
+	-	Signal name	Input/ Output			
53 (B)	Ground	Ground	—	Ignition switch ON	—	0 V
54 (Y)	Ground	Battery power supply	Input	Ignition switch OFF	—	Battery voltage
55 (V)	Ground	ACC power supply	Input	Ignition switch ACC	—	Battery voltage
56 (G)	Ground	Ignition signal	Input	Ignition switch ON	—	Battery voltage
60 (R)	Ground	Headphone amp. ON sig- nal	Output	Ignition switch ON	Headphone mode is ON.	4.5 V
					Headphone mode is OFF.	0 V

Wiring Diagram - BOSE AUDIO WITHOUT NAVIGATION WITH DVD ENTERTAIN-
MENT SYSTEM -

INFOID:000000003702913

NOTE:

A
B
C
D
E
F
G
H
I
J
K
L
M

AV

O
P

VIDEO DISTRIBUTOR

[BOSE AUDIO WITHOUT NAVIGATION]

< ECU DIAGNOSIS >

In this section, PRESET SWITCH and MULTIFUNCTION SWITCH are written as the MULTIFUNCTION SWITCH.

BOSE AUDIO WITHOUT NAVIGATION WITH DVD ENTERTAINMENT SYSTEM

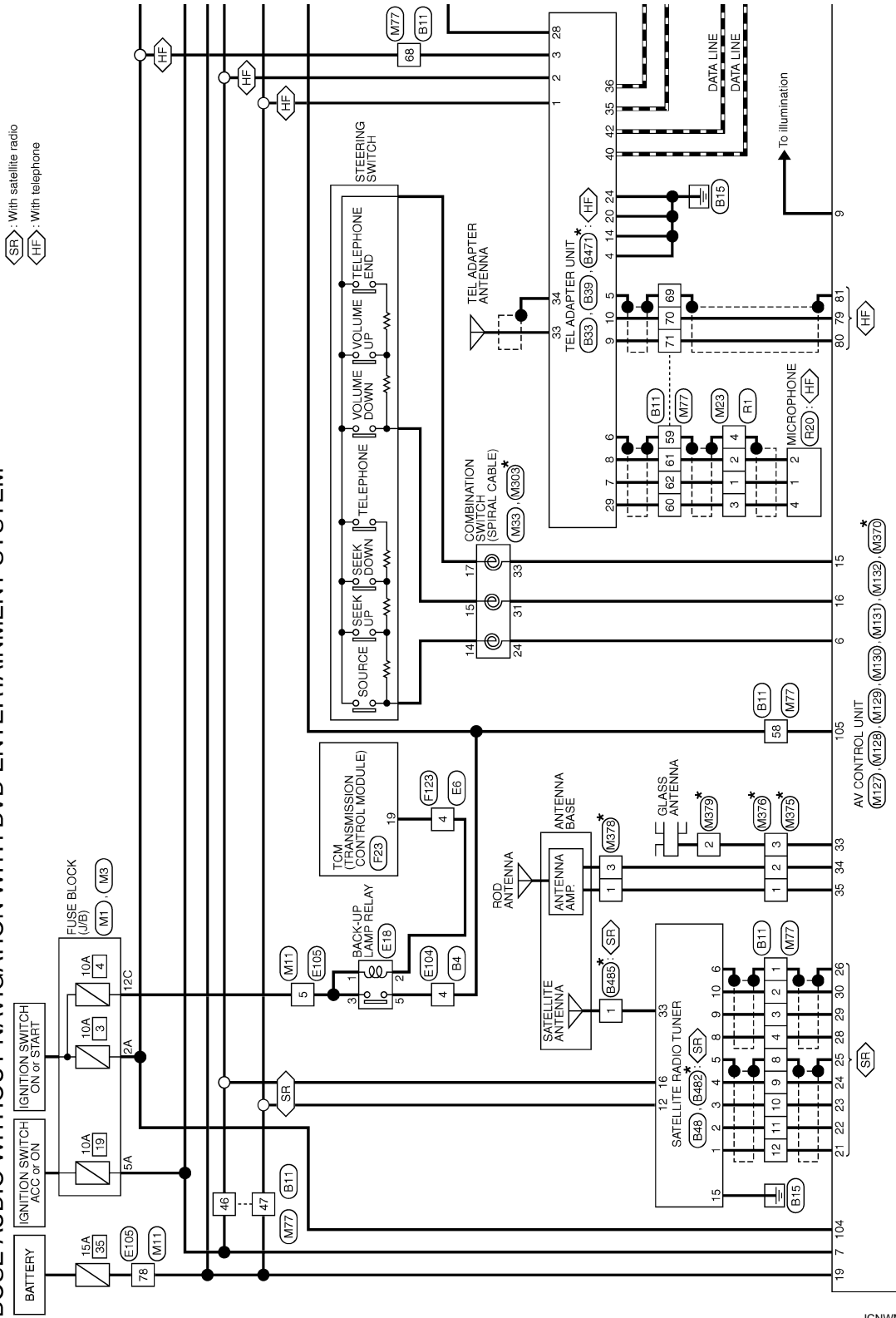

*: This connector is not shown in "Harness Layout".

2008/09/23

JCNWM1872GI

VIDEO DISTRIBUTOR

[BOSE AUDIO WITHOUT NAVIGATION]

< ECU DIAGNOSIS >

- WI: With iPod
- HF: With telephone
- OF: Without telephone

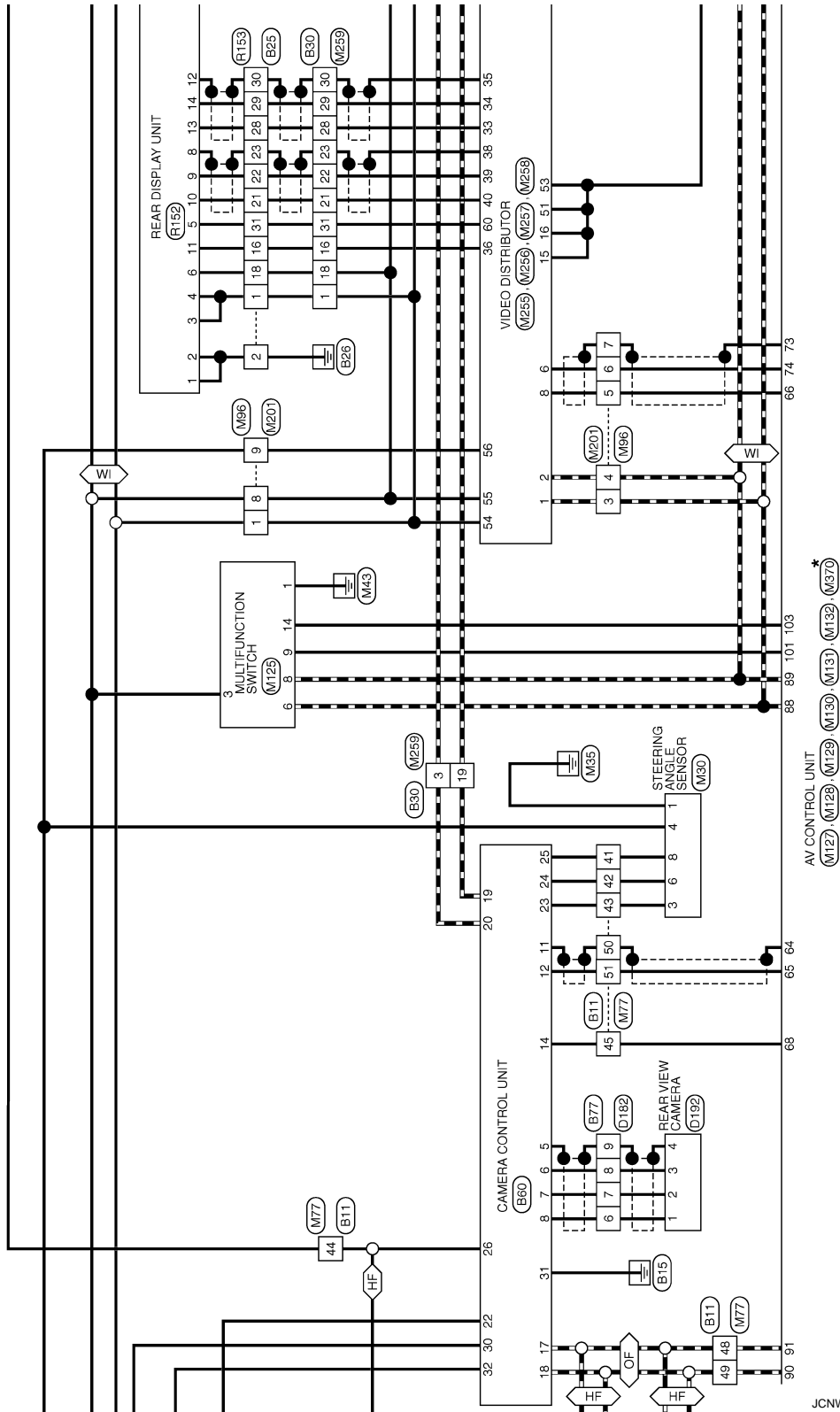

*: This connector is not shown in "Harness Layout".

JCNWM1873GI

A
B
C
D
E
F
G
H
I
J
K
L
M
AV
O
P

VIDEO DISTRIBUTOR

[BOSE AUDIO WITHOUT NAVIGATION]

< ECU DIAGNOSIS >

WI: With iPod

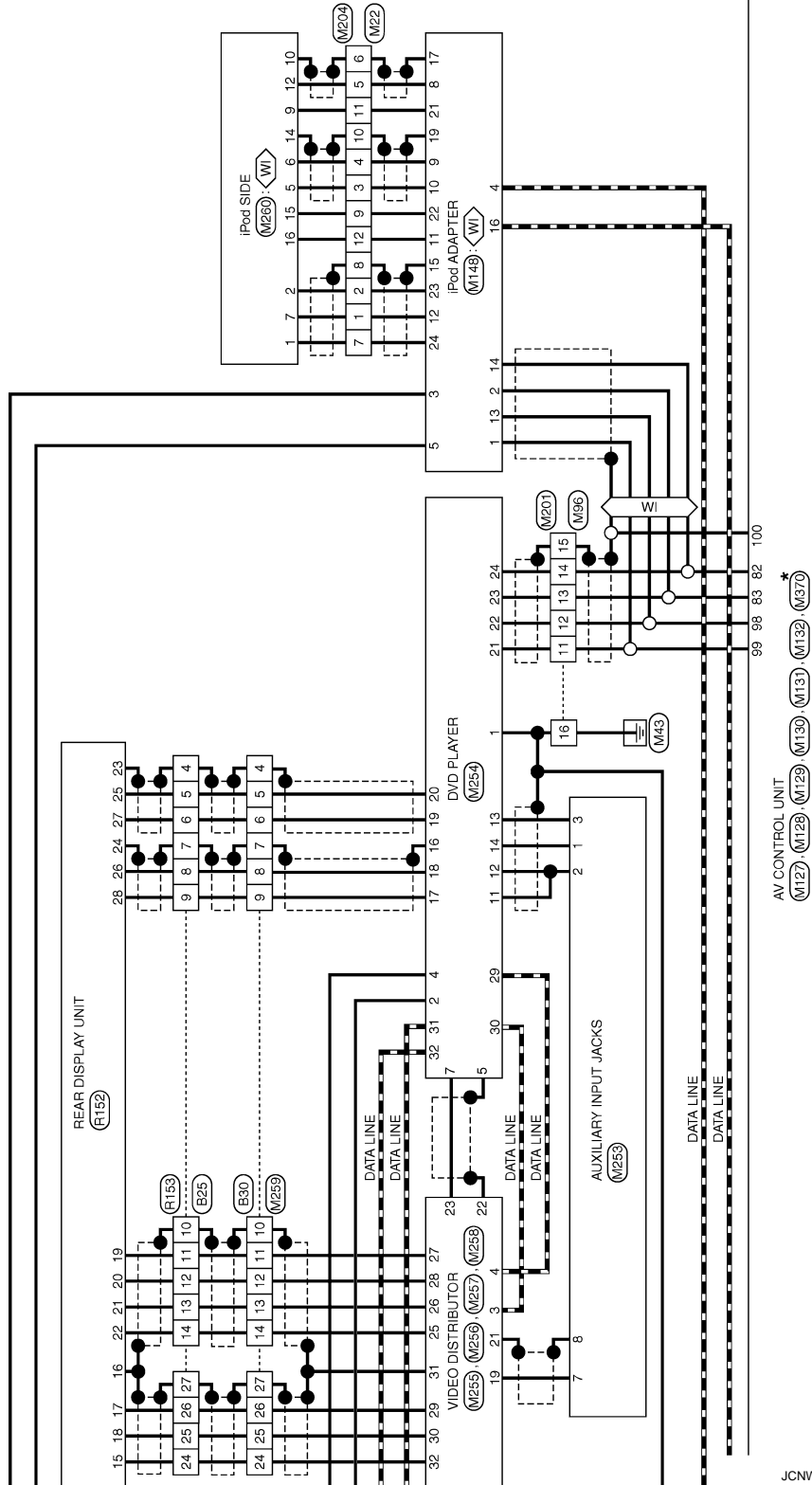

*: This connector is not shown in "Harness Layout".

JCNWM1874GI

VIDEO DISTRIBUTOR

[BOSE AUDIO WITHOUT NAVIGATION]

< ECU DIAGNOSIS >

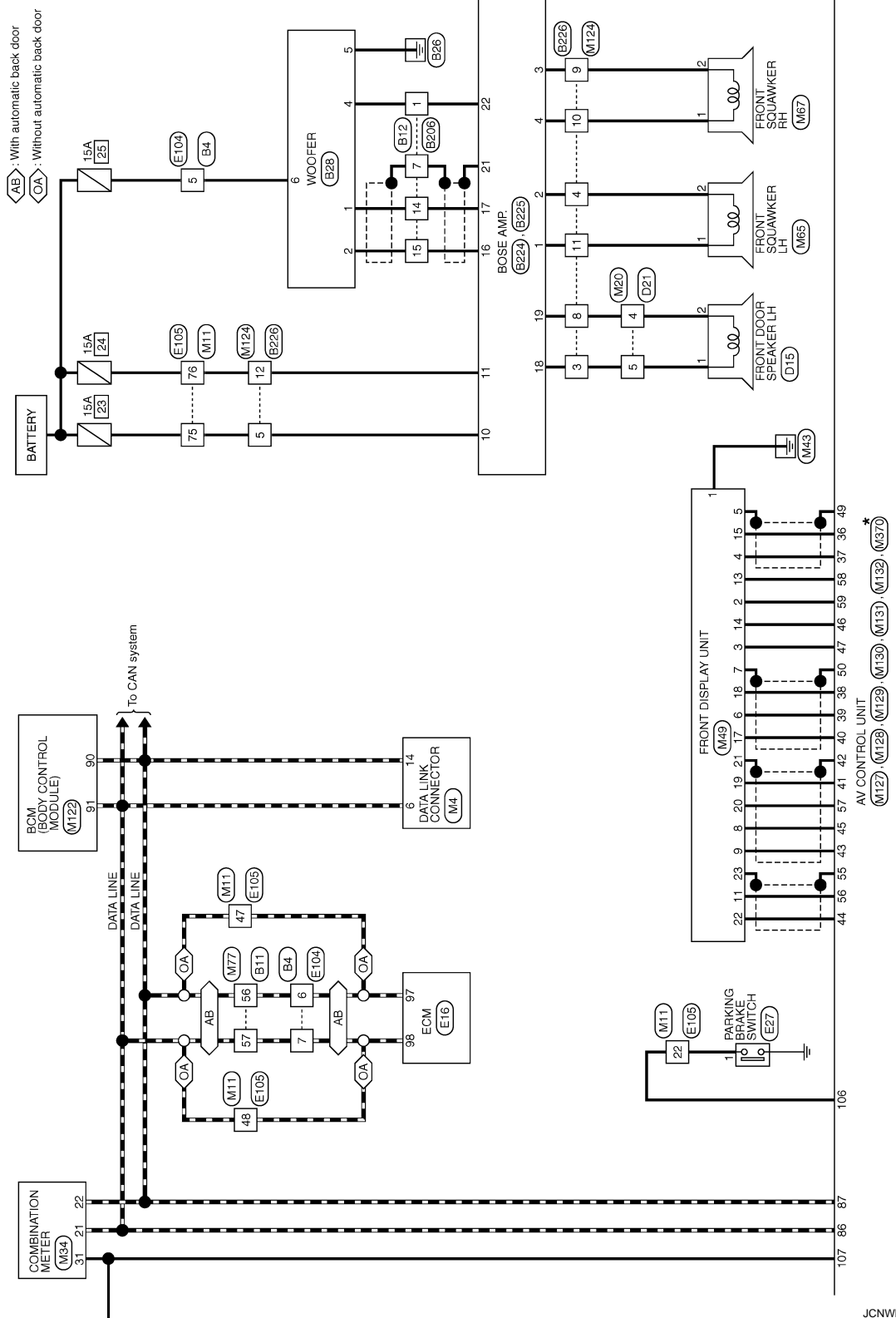

*: This connector is not shown in "Harness Layout".

JCNWM1875GI

A
B
C
D
E
F
G
H
I
J
K
L
M
N
O
P

AV

VIDEO DISTRIBUTOR

[BOSE AUDIO WITHOUT NAVIGATION]

< ECU DIAGNOSIS >

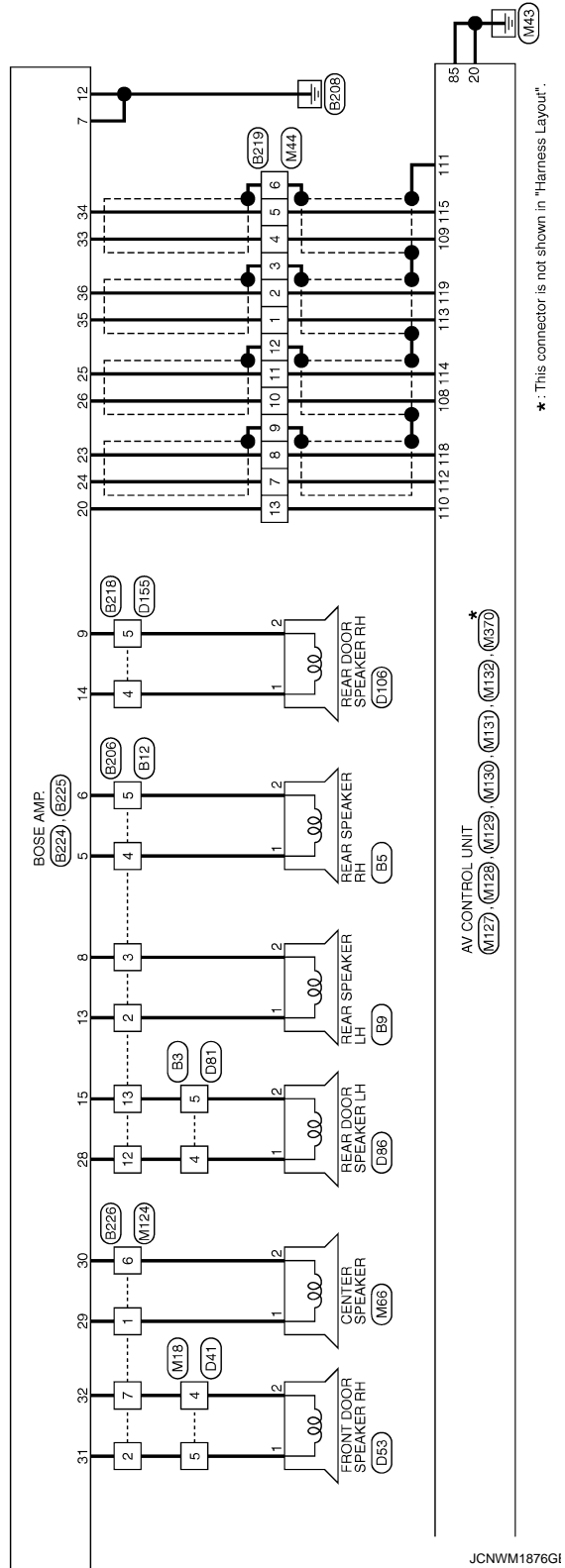

VIDEO DISTRIBUTOR

[BOSE AUDIO WITHOUT NAVIGATION]

< ECU DIAGNOSIS >

BOSE AUDIO WITHOUT NAVIGATION WITH DVD ENTERTAINMENT SYSTEM

Connector No.	B3
Connector Name	WIRE TO WIRE
Connector Type	TK0DFW-ANS8



Terminal No.	Color of Wire	Signal Name [Specification]
4	LG	-
5	O	-

Connector No.	B4
Connector Name	WIRE TO WIRE
Connector Type	NS16MHW-CS



Terminal No.	Color of Wire	Signal Name [Specification]
4	R	-
5	O	-
6	P	-
7	L	-

Connector No.	B5
Connector Name	REAR SPEAKER RH
Connector Type	TK02FBR



Terminal No.	Color of Wire	Signal Name [Specification]
1	V	-
2	LG	-

Connector No.	B9
Connector Name	REAR SPEAKER LH
Connector Type	TK02FBR



Terminal No.	Color of Wire	Signal Name [Specification]
1	SB	-
2	GR	-

Connector No.	B11
Connector Name	WIRE TO WIRE
Connector Type	TH80MW-CS19

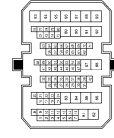

Terminal No.	Color of Wire	Signal Name [Specification]
1	SHIELD	-
2	B	-
3	R/L	-
4	R/W	-
8	SHIELD	-
9	BR/L	-
10	Y/G	-
11	Y/L	-
12	W/L	-
41	O	-
42	SB	-

43	G	-
44	BR	-
45	L	-
46	GR	-
47	V	-
48	GR	-(With rear view camera and telephone)
48	BR	-(With rear view camera without telephone)
49	Y	-
50	SHIELD	-
51	B	-
56	P	-
57	L	-
58	R	-
59	SHIELD	-
60	B	-
61	R/L	-
62	R/W	-
68	R	-
69	SHIELD	-
70	W/R	-
71	B/R	-

Connector No.	B12
Connector Name	WIRE TO WIRE
Connector Type	NS18FW-CS

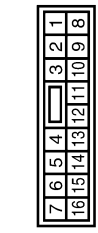

Terminal No.	Color of Wire	Signal Name [Specification]
1	W	-
2	SB	-
3	GR	-
4	V	-
5	LG	-
7	SHIELD	-
12	LG	-
13	O	-
14	W/R	-
15	B/R	-

A
B
C
D
E
F
G
H
I
J
K
L
M
O
P

AV

JCNWM1877GI

VIDEO DISTRIBUTOR

[BOSE AUDIO WITHOUT NAVIGATION]

< ECU DIAGNOSIS >

BOSE AUDIO WITHOUT NAVIGATION WITH DVD ENTERTAINMENT SYSTEM

Connector No.	B25
Connector Name	WIRE TO WIRE
Connector Type	TH22MW-NH



Terminal No.	Color of Wire	Signal Name [Specification]
1	SB	-
2	B	-
4	SHIELD	-
5	W/R	-
6	W/L	-
7	SHIELD	-
8	GR/V	-
9	W/L	-
10	SHIELD	-
11	W/L	-
12	Y/G	-

Connector No.	B30
Connector Name	WIRE TO WIRE
Connector Type	TH32FW-NH



Terminal No.	Color of Wire	Signal Name [Specification]
1	SB	-
3	G	-
4	SHIELD	-
5	W/R	-
6	W/L	-
7	SHIELD	-
8	GR/V	-
9	W/L	-
10	SHIELD	-
11	W/L	-
12	Y/G	-

Terminal No.	Color of Wire	Signal Name [Specification]
13	Y/L	-
14	BR/L	-
16	V	-
18	O	-
21	B/R	-
22	W/R	-
23	SHIELD	-
24	B	-
25	R/L	-
26	R/W	-
27	SHIELD	-
28	B	-
29	W	-
30	SHIELD	-
31	P	-

Connector No.	B28
Connector Name	WOOFER
Connector Type	RS08FGY-PR



Terminal No.	Color of Wire	Signal Name [Specification]
1	W/R	SOUND SIGNAL WOOFER (-)
2	B/R	SOUND SIGNAL WOOFER (+)
4	W	WOOFER AMP. ON SIGNAL
5	B/W	GND
6	O	BAT

Connector No.	B33
Connector Name	TEL ADAPTER UNIT
Connector Type	TH08FW-NH



Terminal No.	Color of Wire	Signal Name [Specification]
35	Y	AV COMM (H)
36	BR	AV COMM (L)
40	G	AV COMM (H)
42	GR	AV COMM (L)

VIDEO DISTRIBUTOR

[BOSE AUDIO WITHOUT NAVIGATION]

< ECU DIAGNOSIS >

BOSE AUDIO WITHOUT NAVIGATION WITH DVD ENTERTAINMENT SYSTEM

Connector No.	B48
Connector Name	SATELLITE RADIO TUNER
Connector Type	A18FW

Terminal No.	Color of Wire	Signal Name [Specification]
1	W/L	SOUND SIGNAL LH (-)
2	Y/L	SOUND SIGNAL LH (+)
3	Y/G	SOUND SIGNAL RH (-)
4	BR/L	SOUND SIGNAL RH (+)
5	SHIELD	SHIELD
8	SHIELD	SHIELD
8	R/W	REQUEST (SAT->CONT)
9	R/L	COMM (SAT->CONT)
10	B	COMM (CONT->SAT)
12	V	BATTERY
15	B	GND

Connector No.	B38
Connector Name	TEL ADAPTER UNIT
Connector Type	TH22FW-NH

Terminal No.	Color of Wire	Signal Name [Specification]
1	V	BATTERY
2	GR	ACC
3	R	IGNITION
4	B/W	GND
5	SHIELD	SHIELD
8	SHIELD	SHIELD
7	R/W	MICROPHONE SIGNAL
8	R/L	MICROPHONE GND
9	B/R	TEL VOICE SIGNAL (+)
10	W/R	TEL VOICE SIGNAL (-)
14	B	GND

Terminal No.	Color of Wire	Signal Name [Specification]
22	R	REVERSE
23	G	SENSOR SIGNAL 1
24	SB	SENSOR SIGNAL 2
25	O	SENSOR SIGNAL 3
26	BR	VEHICLE SPEED (8-PULSE)
30	GR	ACC
31	B	GND
32	V	BATTERY

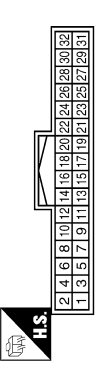
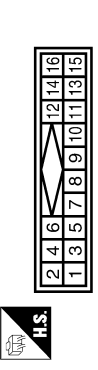

Connector No.	B206
Connector Name	WIRE TO WIRE
Connector Type	NS16MW-CS

Terminal No.	Color of Wire	Signal Name [Specification]
1	W	
2	GR	
3	BR	
4	Y	
5	BR	
7	SHIELD	
12	G	
13	R	
14	W/R	
15	B/R	

Connector No.	B77
Connector Name	WIRE TO WIRE
Connector Type	TK12MW

Terminal No.	Color of Wire	Signal Name [Specification]
6	R/L	
7	R/W	
8	B	
9	SHIELD	

Terminal No.	Color of Wire	Signal Name [Specification]
5	SHIELD	SHIELD
6	B	CAMERA IMAGE SIGNAL
7	R/W	GND
8	R/L	CAMERA ON SIGNAL
11	SHIELD	SHIELD
12	B	CAMERA IMAGE SIGNAL
14	L	CONNECTION RECOGNITION
17	BR	AV COMM (L)
18	Y	AV COMM (H)
19	GR	AV COMM (L)
20	G	AV COMM (H)

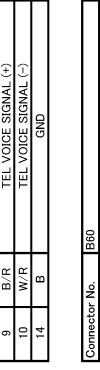
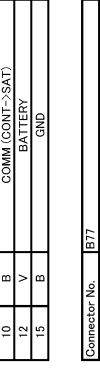
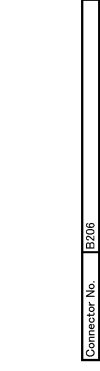

Terminal No.	Color of Wire	Signal Name [Specification]
1	W	
2	GR	
3	BR	
4	Y	
5	BR	
7	SHIELD	
12	G	
13	R	
14	W/R	
15	B/R	

Terminal No.	Color of Wire	Signal Name [Specification]
6	R/L	
7	R/W	
8	B	
9	SHIELD	

Terminal No.	Color of Wire	Signal Name [Specification]					
2	4	6	8	10	12	14	16
1	3	5	7	9	11	13	15

Terminal No.	Color of Wire	Signal Name [Specification]					
2	4	6	8	10	12	14	16
1	3	5	7	9	11	13	15

Terminal No.	Color of Wire	Signal Name [Specification]				
1	2	3	4	5	6	7
8	9	10	11	12	13	14
15	16					

JCNWM1879GI

A
B
C
D
E
F
G
H
I
J
K
L
M
N
O
P

AV

VIDEO DISTRIBUTOR

[BOSE AUDIO WITHOUT NAVIGATION]

< ECU DIAGNOSIS >

BOSE AUDIO WITHOUT NAVIGATION WITH DVD ENTERTAINMENT SYSTEM

Connector No.	B218
Connector Name	WIRE TO WIRE
Connector Type	TK10FW-NSB



Connector No.	B219
Connector Name	WIRE TO WIRE
Connector Type	TK132MF-NH



Terminal No.	Color of Wire	Signal Name [Specification]
4	L	-[With BOSE system]
5	O	-[With BOSE system]

Terminal No.	Color of Wire	Signal Name [Specification]
1	W/R	-
2	B/R	-
3	SHIELD	-
4	W/R	-
5	B/R	-
6	SHIELD	-
7	GR/V	-
8	W/L	-
9	SHIELD	-
10	GR/V	-
11	W/L	-

Connector No.	B224
Connector Name	BOSE AMP.
Connector Type	SGA12FBR-SJAZ

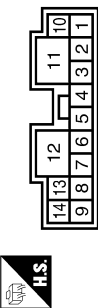

Terminal No.	12	B	GND
13	GR	SOUND SIGNAL REAR SPEAKER LH (+)	
14	L	SOUND SIGNAL REAR DOOR SPEAKER RH (+)	

12	SHIELD
13	SB

Connector No.	B225
Connector Name	BOSE AMP.
Connector Type	SCA19FBR-SGA4

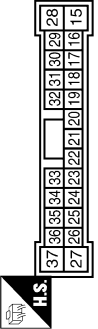

26	GR/V	SOUND SIGNAL REAR RH (+)
28	G	SOUND SIGNAL REAR DOOR SPEAKER LH (+)
29	V	SOUND SIGNAL CENTER SPEAKER (+)
30	P	SOUND SIGNAL CENTER SPEAKER (-)
31	BR	SOUND SIGNAL FRONT DOOR SPEAKER RH (+)
32	Y	SOUND SIGNAL FRONT DOOR SPEAKER RH (-)
33	W/R	SOUND SIGNAL FRONT RH (+)
34	B/R	SOUND SIGNAL FRONT RH (-)
35	W/R	SOUND SIGNAL FRONT LH (+)
36	B/R	SOUND SIGNAL FRONT LH (-)

Terminal No.	Color of Wire	Signal Name [Specification]
1	LG	SOUND SIGNAL FRONT SQUAWKER LH (+)
2	V	SOUND SIGNAL FRONT SQUAWKER LH (-)
3	L	SOUND SIGNAL FRONT SQUAWKER RH (-)
4	P	SOUND SIGNAL FRONT SQUAWKER RH (+)
5	Y	SOUND SIGNAL REAR SPEAKER RH (+)
6	BR	SOUND SIGNAL REAR SPEAKER RH (-)
7	B	GND
8	BR	SOUND SIGNAL REAR SPEAKER LH (-)
9	O	SOUND SIGNAL REAR DOOR SPEAKER RH (-)
10	SB	BATTERY
11	GR	BATTERY

Terminal No.	Color of Wire	Signal Name [Specification]
15	R	SOUND SIGNAL REAR DOOR SPEAKER LH (-)
16	B/R	SOUND SIGNAL WOOFER (+)
17	W/R	SOUND SIGNAL WOOFER (-)
18	W	SOUND SIGNAL FRONT DOOR SPEAKER LH (+)
19	B	SOUND SIGNAL FRONT DOOR SPEAKER LH (-)
20	SB	AMP. ON SIGNAL
21	SHIELD	SHIELD
22	W	WOOFER AMP. ON SIGNAL
23	W/L	SOUND SIGNAL REAR LH (-)
24	GR/V	SOUND SIGNAL REAR LH (+)
25	W/L	SOUND SIGNAL REAR RH (-)

VIDEO DISTRIBUTOR

[BOSE AUDIO WITHOUT NAVIGATION]

< ECU DIAGNOSIS >

BOSE AUDIO WITHOUT NAVIGATION WITH DVD ENTERTAINMENT SYSTEM

Connector No.	B226
Connector Name	WIRE TO WIRE
Connector Type	NS2MFR-CS

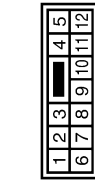

Terminal No.	Color of Wire	Signal Name [Specification]
1	V	
2	BR	
3	W	
4	V	
5	SB	
6	P	
7	Y	
8	B	
9	L	
10	P	
11	LG	

Connector No.	B465
Connector Name	ANTENNA BASE (SATELLITE ANTENNA) WITH BOSE SYSTEM WITHOUT NAVIGATION SYSTEM
Connector Type	GT1BC-1PP-HU



Terminal No.	1	Color of Wire	-	Signal Name [Specification]	SATELLITE ANTENNA
--------------	---	---------------	---	-----------------------------	-------------------

12	GR	-
----	----	---

Connector No.	B471
Connector Name	TEL ADAPTER UNIT
Connector Type	GT1BC-1S-HU



Terminal No.	33	Color of Wire	-	Signal Name [Specification]	TEL ANTENNA
	34	SHIELD	-	SHIELD	

Connector No.	D21
Connector Name	WIRE TO WIRE
Connector Type	TH4DFW-CS15

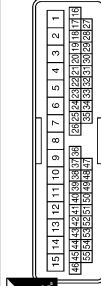

Terminal No.	4	Color of Wire	B/W	Signal Name [Specification]	-[Type A]
	4	B	-	-[Type B]	
	5	L	-	-[Type A]	
	5	W	-	-[Type B]	

Connector No.	B482
Connector Name	SATELLITE RADIO TUNER
Connector Type	FAKRA



Terminal No.	33	Color of Wire	-	Signal Name [Specification]	SATELLITE ANTENNA
--------------	----	---------------	---	-----------------------------	-------------------

Connector No.	D41
Connector Name	WIRE TO WIRE
Connector Type	TH4DFW-CS15

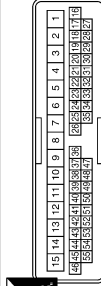

Terminal No.	4	Color of Wire	B/R	Signal Name [Specification]	-[Type A]
	4	B	-	-[Type B]	
	5	BR	-	-[Type A]	
	5	W	-	-[Type B]	

A
B
C
D
E
F
G
H
I
J
K
L
M
N
O
P

AV

JCNWM1881G1

VIDEO DISTRIBUTOR

[BOSE AUDIO WITHOUT NAVIGATION]

< ECU DIAGNOSIS >

BOSE AUDIO WITHOUT NAVIGATION WITH DVD ENTERTAINMENT SYSTEM

Connector No.	D53
Connector Name	FRONT DOOR SPEAKER RH (WITH BOSE SYSTEM)
Connector Type	NS02FBR-CS



Terminal No.	Color of Wire	Signal Name [Specification]
1	BR	-[Type A]
1	W	-[Type B]
2	B/R	-[Type A]
2	B	-[Type B]

Connector No.	D81
Connector Name	WIRE TO WIRE
Connector Type	TK10MW-NS8

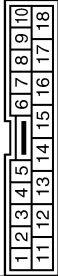

Terminal No.	Color of Wire	Signal Name [Specification]
4	L	-
5	W	-

Connector No.	D36
Connector Name	REAR DOOR SPEAKER LH (WITH BOSE SYSTEM)
Connector Type	NS02FBR-CS



Terminal No.	Color of Wire	Signal Name [Specification]
1	L	-
2	W	-

Connector No.	D106
Connector Name	REAR DOOR SPEAKER RH (WITH BOSE SYSTEM)
Connector Type	NS02FBR-CS



Terminal No.	Color of Wire	Signal Name [Specification]
1	O	-[Type A]
1	L	-[Type B]
2	B/P	-[Type A]
2	W	-[Type B]

Connector No.	D155
Connector Name	WIRE TO WIRE
Connector Type	TK10MW-NS8



Connector No.	D182
Connector Name	WIRE TO WIRE
Connector Type	TK12FW

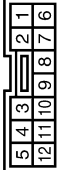

Connector No.	D192
Connector Name	REAR VIEW CAMERA
Connector Type	TK4MMW-NH



Connector No.	E6
Connector Name	WIRE TO WIRE
Connector Type	TK16MGY-TV



Terminal No.	Color of Wire	Signal Name [Specification]
4	O	-[Type A]
4	L	-[Type B]
5	B/P	-[Type A]
5	W	-[Type B]

Terminal No.	Color of Wire	Signal Name [Specification]
6	R	-
7	G	-
8	B	-
9	SHIELD	-

Terminal No.	Color of Wire	Signal Name [Specification]
1	R	CAMERA ON SIGNAL
2	G	GND
3	B	CAMERA IMAGE SIGNAL
4	SHIELD	SHIELD

Terminal No.	Color of Wire	Signal Name [Specification]
4	R	-

VIDEO DISTRIBUTOR

[BOSE AUDIO WITHOUT NAVIGATION]

< ECU DIAGNOSIS >

BOSE AUDIO WITHOUT NAVIGATION WITH DVD ENTERTAINMENT SYSTEM

Connector No.	E18
Connector Name	ECM
Connector Type	RH24FB-RZ8-L-LH

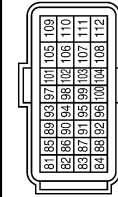

Terminal No.	Color of Wire	Signal Name [Specification]
97	P	VEHGAN-L
98	L	VEHGAN-H

Connector No.	E18
Connector Name	BACK-UP LAMP RELAY
Connector Type	MS02FL-M2-LC

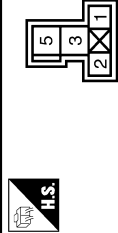

Terminal No.	Color of Wire	Signal Name [Specification]
1	LG	-
2	R	-
3	LG	-
5	R	-

Connector No.	E27
Connector Name	PARKING BRAKE SWITCH
Connector Type	F01FB-A



Terminal No.	Color of Wire	Signal Name [Specification]
1	P	-

Connector No.	E104
Connector Name	WIRE TO WIRE
Connector Type	NS38FW-CS

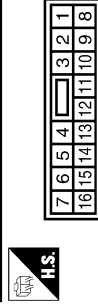

Terminal No.	Color of Wire	Signal Name [Specification]
4	R	-
5	L	-
6	P	-
7	L	-

Connector No.	E105
Connector Name	WIRE TO WIRE
Connector Type	TH170MW-CS10-M3

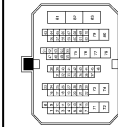

Terminal No.	Color of Wire	Signal Name [Specification]
5	LG	-
22	P	-
47	P	-
48	L	-
75	BR	-
76	GR	-
78	V	-

Connector No.	F23
Connector Name	TOM (TRANSMISSION CONTROL MODULE)
Connector Type	RH40FB-RZ8-L-RH

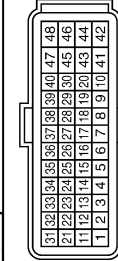

Terminal No.	Color of Wire	Signal Name [Specification]
19	G/B	REV LAMP RELAY

Connector No.	F123
Connector Name	WIRE TO WIRE
Connector Type	TK18FGY-1V

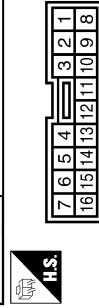

Terminal No.	Color of Wire	Signal Name [Specification]
4	G/B	-

Connector No.	M1
Connector Name	FUSE BLOK (J/B)
Connector Type	NS30FW-M2



Terminal No.	Color of Wire	Signal Name [Specification]
2A	G	-
5A	R	-

A
B
C
D
E
F
G
H
I
J
K
L
M
AV
O
P

VIDEO DISTRIBUTOR

[BOSE AUDIO WITHOUT NAVIGATION]

< ECU DIAGNOSIS >

BOSE AUDIO WITHOUT NAVIGATION WITH DVD ENTERTAINMENT SYSTEM

Connector No.	M3
Connector Name	FUSE BLOCK (J/B)
Connector Type	HS12FW-CS

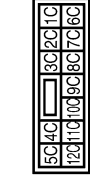

Terminal No.	Color of Wire	Signal Name [Specification]
12C	O	-

Connector No.	M4
Connector Name	DATA LINK CONNECTOR
Connector Type	BD16FW



Terminal No.	Color of Wire	Signal Name [Specification]
6	L	-
14	P	-

Connector No.	M11
Connector Name	WIRE TO WIRE
Connector Type	TH10FW-CS10-M3

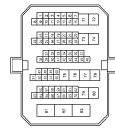

Terminal No.	Color of Wire	Signal Name [Specification]
5	O	-
22	G	-
47	P	-
48	L	-
75	BR	-
76	R	-
78	Y	-

Connector No.	M18
Connector Name	WIRE TO WIRE
Connector Type	TH40MW-CS15

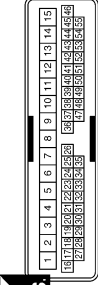

Terminal No.	Color of Wire	Signal Name [Specification]
4	W	-
5	BR	- [Type A and without BOSE system type B]
	B	- [With BOSE system type B]

Connector No.	M20
Connector Name	WIRE TO WIRE
Connector Type	TH40MW-CS15

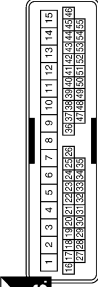

Terminal No.	Color of Wire	Signal Name [Specification]
4	B	-
5	L	-

Connector No.	M22
Connector Name	WIRE TO WIRE
Connector Type	TH12FW-NH

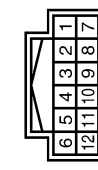

Terminal No.	Color of Wire	Signal Name [Specification]
1	V	-
2	R	-
3	R	-
4	G	-
5	W	-
6	SHIELD	-
7	LG	-
8	SHIELD	-
9	BR	-
10	SHIELD	-
11	L	-

Connector No.	M23
Connector Name	WIRE TO WIRE
Connector Type	TH16MW-NH



Terminal No.	Color of Wire	Signal Name [Specification]
1	W	-
2	R	- [With telephones without navigation system]
3	B	-
4	SHIELD	-

VIDEO DISTRIBUTOR

[BOSE AUDIO WITHOUT NAVIGATION]

< ECU DIAGNOSIS >

BOSE AUDIO WITHOUT NAVIGATION WITH DVD ENTERTAINMENT SYSTEM

Connector No.	M33
Connector Name	STEERING ANGLE SENSOR
Connector Type	TH08FW-NH



Connector No.	M33
Connector Name	COMBINATION SWITCH (SPIRAL CABLE)
Connector Type	TH08FGY-1V

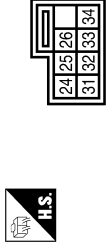

Connector No.	M34
Connector Name	COMBINATION METER
Connector Type	TH46FW-NH

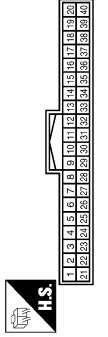

Terminal No.	Color of Wire	Signal Name [Specification]
1	B	-
3	L	-
4	G	-
6	SB	-
8	O	-

Terminal No.	Color of Wire	Signal Name [Specification]
24	BR	- [With audio steering switch and telephone]
31	G	- [With audio steering switch and telephone]
33	L	- [With audio steering switch and telephone]

Terminal No.	Color of Wire	Signal Name [Specification]
21	L	CAN-H
22	P	CAN-L
31	V	VEHICLE SPEED (8-PULSE)

Connector No.	M44
Connector Name	WIRE TO WIRE
Connector Type	TH22FW-NH

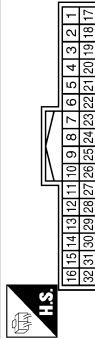

Terminal No.	10	V	-
Terminal No.	11	LG	-
Terminal No.	12	SHIELD	-
Terminal No.	13	P	-

Connector No.	M49
Connector Name	FRONT DISPLAY UNIT
Connector Type	TH24FW-NH



Terminal No.	14	LG	SIGNAL GND [Without navigation system]
Terminal No.	15	L	COMPOSITE IMAGE SIGNAL [Without navigation system]
Terminal No.	17	G	RGB (RED) SIGNAL
Terminal No.	18	Y	RGB (BLUE) SIGNAL [Without navigation system]
Terminal No.	19	B	RGB SYNC
Terminal No.	20	R	VP
Terminal No.	21	SHIELD	SHIELD
Terminal No.	22	G	COMM (DISEP->CONT)
Terminal No.	23	SHIELD	SHIELD

Terminal No.	Color of Wire	Signal Name [Specification]
1	G	-
2	R	-
3	SHIELD	-
4	B	-
5	W	-
6	SHIELD	-
7	O	- [Type A]
7	L	- [Type B]
8	SB	- [Type A]
8	R	- [Type B]
9	SHIELD	-

Terminal No.	Color of Wire	Signal Name [Specification]
1	B	GND
2	Y	INVERTER VCCI [Without navigation system]
3	O	SIGNAL VCCI [Without navigation system]
4	P	COMPOSITE IMAGE GND [Without navigation system]
5	SHIELD	SHIELD [Without navigation system]
6	L	RGB (GREEN) SIGNAL [Without navigation system]
7	SHIELD	SHIELD
8	G	HP [Without navigation system]
9	W	RGB AREA (YS) SIGNAL
11	R	COMM (CONT->DISEP)
13	BR	INVERTER GND [Without navigation system]

A
B
C
D
E
F
G
H
I
J
K
L
M
N
O
P

AV

JCNWM1885GI

VIDEO DISTRIBUTOR

[BOSE AUDIO WITHOUT NAVIGATION]

< ECU DIAGNOSIS >

BOSE AUDIO WITHOUT NAVIGATION WITH DVD ENTERTAINMENT SYSTEM

Connector No.	M65
Connector Name	FRONT SQUAWKER LH
Connector Type	TK02FBR



Terminal No.	Color of Wire	Signal Name [Specification]
1	LG	- [With BOSE system]
2	Y	- [With BOSE system]

Connector No.	M66
Connector Name	CENTER SPEAKER
Connector Type	TK02FBR



Terminal No.	Color of Wire	Signal Name [Specification]
1	P	-
2	O	-

Connector No.	M67
Connector Name	FRONT SQUAWKER RH
Connector Type	TK02FBR



Terminal No.	Color of Wire	Signal Name [Specification]
1	BR	-
2	R	- [With BOSE system]

Connector No.	M77
Connector Name	WIRE TO WIRE
Connector Type	TH80FW-CS19

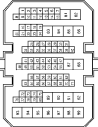

Terminal No.	Color of Wire	Signal Name [Specification]
1	SHIELD	-
2	B	-
3	W	-
4	R	-
8	SHIELD	-
9	W	-
10	R	-
11	G	-
12	B	-
41	O	-
42	SB	-

43	L	-
44	V	-
45	P	-
46	R	-
47	Y	-
48	L	-
49	G	-
50	SHIELD	-
51	W	-
56	P	-
57	L	-
58	SB	-
59	SHIELD	-
60	B	-
61	R	-
62	W	-
68	G	-
69	SHIELD	-
70	L	-
71	R	-

Connector No.	M96
Connector Name	WIRE TO WIRE
Connector Type	TH18FW-NH

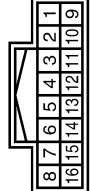

Terminal No.	Color of Wire	Signal Name [Specification]
1	Y	-
3	R	-
4	L	-
5	L	-
6	R	-
7	SHIELD	-
8	R	-
9	G	-
11	B	-
12	G	-
13	R	-

14	W	-
15	SHIELD	-
16	B	-

JCNWM1886GI

VIDEO DISTRIBUTOR

[BOSE AUDIO WITHOUT NAVIGATION]

< ECU DIAGNOSIS >

BOSE AUDIO WITHOUT NAVIGATION WITH DVD ENTERTAINMENT SYSTEM

Connector No.	M122
Connector Name	BCM BODY CONTROL MODULE
Connector Type	TH40FB-NH

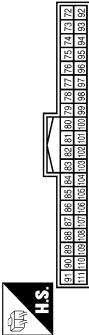

Connector No.	M124
Connector Name	WIRE TO WIRE
Connector Type	NS12FER-CS



11	LG	-
12	R	-

Connector No.	M125
Connector Name	MULTIFUNCTION SWITCH
Connector Type	TH18FW-NH

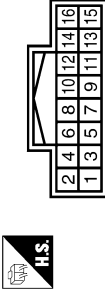

Terminal No.	Color of Wire	Signal Name [Specification]
90	P	CAN-L
91	L	CAN-H

Terminal No.	Color of Wire	Signal Name [Specification]
1	P	-
2	BR	- [Type A]
3	B	- [Type B]
4	L	-
5	Y	-
6	BR	-
7	O	-
8	W	-
9	B	-
10	R	-
11	BR	-

Connector No.	M127
Connector Name	AV CONTROL UNIT (WITH BOSE SYSTEM WITHOUT NAVIGATION SYSTEM)
Connector Type	TH18FW-CS2

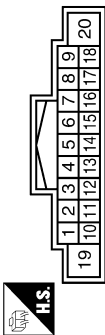

Connector No.	M128
Connector Name	AV CONTROL UNIT (WITH BOSE SYSTEM WITHOUT NAVIGATION SYSTEM)
Connector Type	A12FW



Connector No.	M129
Connector Name	AV CONTROL UNIT (WITH BOSE SYSTEM WITHOUT NAVIGATION SYSTEM)
Connector Type	TH24FW-NH

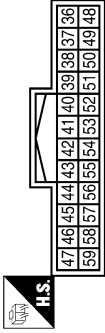

Terminal No.	Color of Wire	Signal Name [Specification]
6	BR	STRG SW A
7	R	ACC
9	R	ILLUMINATION
15	L	STRG SW GND
16	G	STRG SW B
19	Y	BATTERY
20	B	GND

Terminal No.	Color of Wire	Signal Name [Specification]
21	B	SATELLITE RADIO SOUND SIGNAL LH (-)
22	G	SATELLITE RADIO SOUND SIGNAL LH (+)
23	R	SATELLITE RADIO SOUND SIGNAL RH (-)
24	W	SATELLITE RADIO SOUND SIGNAL RH (+)
25	SHIELD	SHIELD
26	SHIELD	SHIELD
28	R	REQUEST (SAT->CONT)
29	W	COMM (SAT->CONT)
30	B	COMM (CONT->SAT)

Terminal No.	Color of Wire	Signal Name [Specification]
36	L	COMPOSITE IMAGE SIGNAL
37	P	COMPOSITE IMAGE GND
38	Y	RGB (B/BLUE) SIGNAL
39	L	RGB (G/GREEN) SIGNAL
40	G	RGB (R/RED) SIGNAL
41	B	RGB SYNC
42	SHIELD	SHIELD
43	W	RGB AREA (YS) SIGNAL
44	G	COMM (DISP->CONT)
45	G	HP
46	LG	SIGNAL GND

A
B
C
D
E
F
G
H
I
J
K
L
M
N
O
P

AV

BOSE AUDIO WITHOUT NAVIGATION WITH DVD ENTERTAINMENT SYSTEM

Connector No.	M130
Connector Name	AV CONTROL UNIT (WITH BOSE SYSTEM WITHOUT NAVIGATION SYSTEM)
Connector Type	TH16FW-NH



67	66	65	64	63	62	61	60
75	74	73	72	71	70	69	68

Connector No.	M131
Connector Name	AV CONTROL UNIT (WITH BOSE SYSTEM WITH NAVIGATION SYSTEM)
Connector Type	TH24FW-NH



71	70	69	68	67	66	65	64	63	62	61	60	77	76	75	74	73	72	71	70	69	68	67	66	65	64	63	62	61	60
----	----	----	----	----	----	----	----	----	----	----	----	----	----	----	----	----	----	----	----	----	----	----	----	----	----	----	----	----	----

91	L	AV COMM (L)
98	G	SOUND SIGNAL LH (-)[With DVD player]
99	B	SOUND SIGNAL LH (+)[With DVD player]
100	SHIELD	SHIELD[With DVD player]
101	V	SW GND
103	W	EJECT SIGNAL
104	G	IGNITION
105	SB	REVERSE
106	G	PARKING BRAKE
107	V	VEHICLE SPEED (8-PULSE)

Terminal No.	Color of Wire	Signal Name [Specification]
64	SHIELD	SHIELD
65	W	CAMERA IMAGE SIGNAL
66	L	COMPOSITE IMAGE SIGNAL[With DVD player]
68	P	CONNECTION RECOGNITION SHIELD[With DVD player]
73	SHIELD	SHIELD[With DVD player]
74	R	COMPOSITE IMAGE GND[With DVD player]

Terminal No.	Color of Wire	Signal Name [Specification]
79	L	TEL VOICE SIGNAL (-)
80	R	TEL VOICE SIGNAL (+)
81	SHIELD	SHIELD
82	W	SOUND SIGNAL RH (-)[With DVD player]
83	R	SOUND SIGNAL RH (+)[With DVD player]
85	B	GND
86	L	CAN-H
87	P	CAN-L
88	R	AV COMM (H)
89	L	AV COMM (L)
90	G	AV COMM (H)

Connector No.	M132
Connector Name	AV CONTROL UNIT (WITH BOSE SYSTEM WITHOUT NAVIGATION SYSTEM)
Connector Type	TH12FW-NH



114	115	116	117	118	119
108	109	110	111	112	113

Terminal No.	Color of Wire	Signal Name [Specification]
108	V	SOUND SIGNAL REAR RH (+)
109	B	SOUND SIGNAL FRONT RH (+)
110	P	AMP_ON SIGNAL
111	SHIELD	SHIELD
112	O	SOUND SIGNAL REAR LH (+)[Type A]
112	L	SOUND SIGNAL REAR LH (+)[Type B]
113	G	SOUND SIGNAL FRONT LH (+)
114	LG	SOUND SIGNAL REAR RH (-)
115	W	SOUND SIGNAL FRONT RH (-)
118	SB	SOUND SIGNAL REAR LH (-)[Type A]
118	R	SOUND SIGNAL REAR LH (-)[Type B]

Connector No.	M148
Connector Name	iPod ADAPTER
Connector Type	TH24FW-NH



1	2	3	4	5	6	7	8	9	10	11	12
13	14	15	16	17	18	19	20	21	22	23	24

Terminal No.	Color of Wire	Signal Name [Specification]
1	BR	iPod SOUND SIGNAL LH (+)
2	R	iPod SOUND SIGNAL RH (+)
3	R	ACC
4	L	AV COMM (L)
5	Y	BATTERY
8	W	CHARGE POWER
9	G	COMM (iPod ADAPTER->iPod)
10	R	COMM (iPod->iPod ADAPTER)
11	R	ACCESSORY IDENTIFY
12	V	iPod SOUND SIGNAL RH (+)
13	L	iPod SOUND SIGNAL LH (+)

14	W	iPod SOUND SIGNAL RH (-)
15	SHIELD	SHIELD
16	R	AV COMM (H)
17	SHIELD	GND
19	SHIELD	SHIELD
21	L	iPod CONNECTION RECOGNITION
22	BR	ACCESSORY DETECT
23	R	iPod SOUND SIGNAL GND
24	LG	iPod SOUND SIGNAL LH (+)

VIDEO DISTRIBUTOR

[BOSE AUDIO WITHOUT NAVIGATION]

< ECU DIAGNOSIS >

BOSE AUDIO WITHOUT NAVIGATION WITH DVD ENTERTAINMENT SYSTEM

Connector No.	M201
Connector Name	WIRE TO WIRE
Connector Type	TH181MW-NH



Terminal No.	14	15	16
Color of Wire	W	SHIELD	B



Connector No.	M204
Connector Name	WIRE TO WIRE
Connector Type	TH12MW-NH



Terminal No.	12
Color of Wire	R

Terminal No.	Color of Wire	Signal Name [Specification]
1	Y	-
2	R	-
3	R	-
4	G	-
5	L	-
6	R	-
7	SHIELD	-
8	V	-
9	G	-
10	B	-
11	B	-
12	G	-
13	R	-

Terminal No.	Color of Wire	Signal Name [Specification]
1	V	-
2	R	-
3	R	-
4	G	-
5	W	-
6	SHIELD	-
7	LG	-
8	SHIELD	-
9	BR	-
10	SHIELD	-
11	L	-

Connector No.	M253
Connector Name	AUXILIARY INPUT JACKS
Connector Type	A08FW

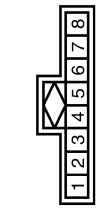

Connector No.	M254
Connector Name	DVD PLAYER
Connector Type	TH432FW-NH

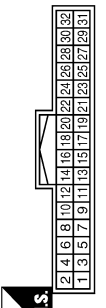

Terminal No.	Color of Wire	Signal Name [Specification]
18	R	HEADPHONE SOUND SIGNAL LH (-)
19	V	HEADPHONE SOUND SIGNAL RH (+)
20	LG	HEADPHONE SOUND SIGNAL RH (-)
21	B	SOUND SIGNAL LH (+)
22	G	SOUND SIGNAL LH (-)
23	R	SOUND SIGNAL RH (+)
24	W	SOUND SIGNAL RH (-)
25	L	AV COMM (L)
26	R	AV COMM (H)
27	L	AV COMM (L)
28	R	AV COMM (H)

Terminal No.	Color of Wire	Signal Name [Specification]
1	R	SOUND SIGNAL RH (+)
2	W	SOUND SIGNAL GND
3	G	SOUND SIGNAL LH (-) [With DVD player]
7	G	AUX IMAGE SIGNAL
8	SHIELD	SHIELD [With DVD player]

Terminal No.	Color of Wire	Signal Name [Specification]
1	B	GND
2	Y	BATTERY
4	V	ACC
5	SHIELD	SHIELD
7	P	DVD IMAGE SIGNAL
11	B	AUX SOUND SIGNAL LH (-)
12	W	AUX SOUND SIGNAL RH (+)
13	G	AUX SOUND SIGNAL LH (+)
14	R	AUX SOUND SIGNAL RH (-)
16	SHIELD	SHIELD
17	G	HEADPHONE SOUND SIGNAL LH (+)

Terminal No.	Color of Wire	Signal Name [Specification]
53	B	GND
54	Y	BATTERY
55	V	ACC
56	G	IGNITION
60	R	HEADPHONE ON SIGNAL

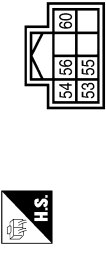

Connector No.	M255
Connector Name	VIDEO DISTRIBUTOR
Connector Type	TH08FW-NH

JCNWM1889GI

A
B
C
D
E
F
G
H
I
J
K
L
M
N
O
P

AV

VIDEO DISTRIBUTOR

[BOSE AUDIO WITHOUT NAVIGATION]

< ECU DIAGNOSIS >

BOSE AUDIO WITHOUT NAVIGATION WITH DVD ENTERTAINMENT SYSTEM

Connector No.	M256
Connector Name	VIDEO DISTRIBUTOR
Connector Type	TH12FW-NH



Connector No.	M257
Connector Name	VIDEO DISTRIBUTOR
Connector Type	TH11FW-NH

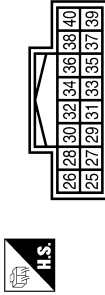

Terminal No.	Color of Wire	Signal Name [Specification]
51	B	GND

Terminal No.	Color of Wire	Signal Name [Specification]
25	R	RGB (R/RED) SIGNAL
26	L	RGB (G/GREEN) SIGNAL
27	W	RGB GND
28	G	RGB (B/BLUE) SIGNAL
29	R	YP
30	W	HP
31	SHIELD	SHIELD
32	B	RGB AREA (S) SIGNAL
33	G	COMPOSITE SYNC
34	R	COMPOSITE IMAGE SIGNAL
35	SHIELD	SHIELD

Connector No.	M258
Connector Name	VIDEO DISTRIBUTOR
Connector Type	TH12FW-NH

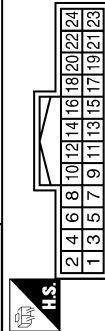

Terminal No.	Color of Wire	Signal Name [Specification]
1	R	AV COMM (H)
2	G	AV COMM (L)
3	R	AV COMM (H)
4	L	AV COMM (L)
6	R	COMPOSITE IMAGE GND
8	L	COMPOSITE IMAGE SIGNAL
15	B	GND
16	B	GND
19	G	AUX IMAGE SIGNAL
21	SHIELD	SHIELD
22	SHIELD	SHIELD

36	G	IGNITION
38	SHIELD	SHIELD
39	V	COMM (DISP->DIST)
40	LG	COMM (DIST->DISP)

Connector No.	M259
Connector Name	WIRE TO WIRE
Connector Type	TH32MW-NH

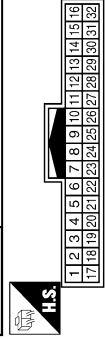

Terminal No.	Color of Wire	Signal Name [Specification]
1	Y	-
3	R	-
4	SHIELD	-
5	LG	-
6	V	-
7	SHIELD	-
8	R	-
9	G	-
10	SHIELD	-
11	W	-
12	G	-

13	L	-
14	R	-
16	G	-
18	V	-
19	L	-
21	LG	-
22	V	-
23	SHIELD	-
24	B	-
25	W	-
26	R	-
27	SHIELD	-
28	G	-
29	R	-
30	SHIELD	-
31	R	-

VIDEO DISTRIBUTOR

[BOSE AUDIO WITHOUT NAVIGATION]

< ECU DIAGNOSIS >

BOSE AUDIO WITHOUT NAVIGATION WITH DVD ENTERTAINMENT SYSTEM

Connector No.	M280
Connector Name	iPod SIDE
Connector Type	IP16FGY

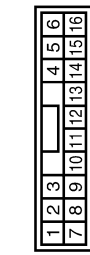

Terminal No.	Color of Wire	Signal Name [Specification]
1	LG	iPod SOUND SIGNAL LH (+)
2	R	iPod SOUND SIGNAL LND
5	R	COMM (iPod->iPod ADAPTER)
6	G	COMM (iPod ADAPTER->iPod)
7	V	iPod SOUND SIGNAL RH (+)
8	Y	iPod CONNECTION RECOGNITION
10	SHIELD	GND
12	W	CHARGE POWER
14	SHIELD	SHIELD
15	BR	ACCESSORY DETECT
16	R	ACCESSORY IDENTIFY

Connector No.	M303
Connector Name	COMBINATION SWITCH (SPIRAL CABLE)
Connector Type	TK08FGY



Terminal No.	Color of Wire	Signal Name [Specification]
14	-	-
15	-	-
17	-	-

Connector No.	M370
Connector Name	AV CONTROL UNIT (WITH BOSE SYSTEM WITHOUT NAVIGATION SYSTEM)
Connector Type	GT13SC-2/IS-HU



Terminal No.	Color of Wire	Signal Name [Specification]
33	-	FM SUB
34	-	AM-FM MAIN
35	-	ANTENNA AMP. ON SIGNAL

Connector No.	M375
Connector Name	WIRE TO WIRE
Connector Type	GT13SH-2/IS-HU



Terminal No.	Color of Wire	Signal Name [Specification]
1	-	-
2	-	-
3	-	-

Connector No.	M376
Connector Name	WIRE TO WIRE
Connector Type	GT13SON-2/1PP-HU



Connector No.	M378
Connector Name	ANTENNA BASE (ANTENNA AMP.)
Connector Type	GT13SSN-1/1PP-HU

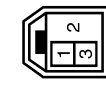

Connector No.	M379
Connector Name	GLASS ANTENNA
Connector Type	GT13SSN-1/1PP-HU



Connector No.	RT
Connector Name	WIRE TO WIRE
Connector Type	TH16FW-NH

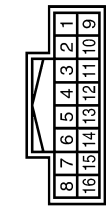

Terminal No.	Color of Wire	Signal Name [Specification]
1	-	-
2	-	-
3	-	-

Terminal No.	Color of Wire	Signal Name [Specification]
1	-	-
3	-	-

Terminal No.	Color of Wire	Signal Name [Specification]
2	-	FM SUB

Terminal No.	Color of Wire	Signal Name [Specification]
1	R/W	-
2	R/L	- [With telephone without navigation system]
3	B	-
4	SHIELD	-

A
B
C
D
E
F
G
H
I
J
K
L
M
O
P

AV

JCNWM1891GI

VIDEO DISTRIBUTOR

[BOSE AUDIO WITHOUT NAVIGATION]

< ECU DIAGNOSIS >

BOSE AUDIO WITHOUT NAVIGATION WITH DVD ENTERTAINMENT SYSTEM

Connector No.	R20
Connector Name	MICROPHONE
Connector Type	TK04FW



Terminal No.	Color of Wire	Signal Name [Specification]
1	R/W	MICROPHONE SIGNAL (+)
2	R/L	MICROPHONE SIGNAL (-) (Only installed without navigation system)
4	B	MICROPHONE POWER

Connector No.	R152
Connector Name	REAR DISPLAY UNIT
Connector Type	TH02FW-NH



Terminal No.	Color of Wire	Signal Name [Specification]
1	B	GND
2	B	GND
3	Y/R	BATTERY
4	Y/R	BATTERY
5	R	HEADPHONE ON SIGNAL
6	V/Y	ACC
8	SHIELD	SHIELD
9	V	COMM (DISP->DIST)
10	LG	COMM (DISP->DISP)
11	G	IGNITION
12	SHIELD	SHIELD

Connector No.	R153
Connector Name	WIRE TO WIRE
Connector Type	TH02FW-NH



Terminal No.	Color of Wire	Signal Name [Specification]
1	Y/R	-
2	B	-
4	SHIELD	-
5	LG	-
6	V	-
7	SHIELD	-
8	BR	-
9	Y	-
10	SHIELD	-
11	W/L	-
12	Y/G	-

13	G	COMPOSITE SYNC
14	R	COMPOSITE IMAGE SIGNAL
15	B	RGB AREA (Y/S) SIGNAL
16	SHIELD	GND
17	R	V/P
18	W	HP
19	W/L	RGB GND
20	Y/G	RGB (B/BLUE) SIGNAL
21	Y/L	RGB (G/GREEN) SIGNAL
22	BR/L	RGB (R/RED) SIGNAL
23	SHIELD	SHIELD
24	SHIELD	SHIELD
25	LG	HEADPHONE SOUND SIGNAL RH (-)
26	BR	HEADPHONE SOUND SIGNAL LH (-)
27	V	HEADPHONE SOUND SIGNAL RH (+)
28	Y	HEADPHONE SOUND SIGNAL LH (+)

13	Y/L	-
14	BR/L	-
16	G	-
18	V/Y	-
21	LG	-
22	V	-
23	SHIELD	-
24	B	-
25	W	-
26	R	-
27	SHIELD	-
28	G	-
29	R	-
30	SHIELD	-
31	R	-

JCNWM1892GI

DVD PLAYER

[BOSE AUDIO WITHOUT NAVIGATION]

< ECU DIAGNOSIS >

DVD PLAYER

Reference Values

INFOID:000000003457759

TERMINAL LAYOUT

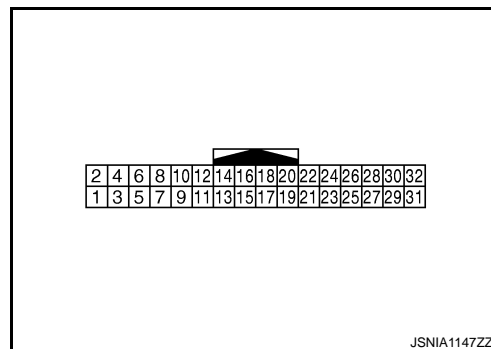

PHYSICAL VALUES

Terminal (Wire color)		Description		Condition		Reference value (Approx.)
+	-	Signal name	Input/ Output			
1 (B)	Ground	Ground	—	Ignition switch ON	—	0 V
2 (Y)	Ground	Battery power supply	Input	Ignition switch OFF	—	Battery voltage
4 (V)	Ground	ACC power supply	Input	Ignition switch ACC	—	Battery voltage
5	—	Shield (DVD image GND)	—	—	—	—
7 (P)	Ground	DVD image signal	Output	Ignition switch ON	When DVD image is displayed.	<p style="text-align: right;">SKIB2251J</p>
13 (G)	11 (B)	AUX sound signal RH	Input	Ignition switch ON	AUX sound output.	<p style="text-align: right;">SKIB3609E</p>
14 (R)	12 (W)	AUX sound signal RH	Input	Ignition switch ON	AUX sound output.	<p style="text-align: right;">SKIB3609E</p>
16	—	Shield	—	—	—	—

A
B
C
D
E
F
G
H
I
J
K
L
M
AV
O
P

DVD PLAYER

< ECU DIAGNOSIS >

[BOSE AUDIO WITHOUT NAVIGATION]

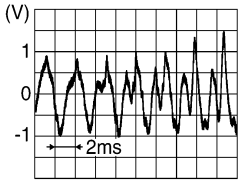
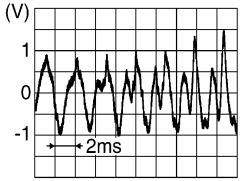
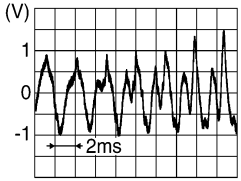
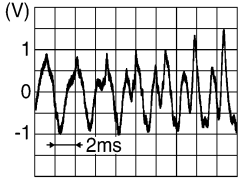
Terminal (Wire color)		Description		Condition		Reference value (Approx.)
+	-	Signal name	Input/ Output			
17 (G)	18 (R)	Headphone sound signal LH	Output	Ignition switch ON	Headphone sound output.	 <p style="text-align: right; font-size: small;">SKIB3609E</p>
19 (V)	20 (LG)	Headphone sound signal RH	Output	Ignition switch ON	Headphone sound output.	 <p style="text-align: right; font-size: small;">SKIB3609E</p>
21 (B)	22 (G)	Sound signal LH (DVD and AUX sound)	Output	Ignition switch ON	DVD or AUX sound output.	 <p style="text-align: right; font-size: small;">SKIB3609E</p>
23 (R)	24 (W)	Sound signal RH (DVD and AUX sound)	Output	Ignition switch ON	DVD or AUX sound output.	 <p style="text-align: right; font-size: small;">SKIB3609E</p>
29 (L)	—	AV communication signal (L)	Input/ Output	—	—	—
30 (R)	—	AV communication signal (H)	Input/ Output	—	—	—
31 (L)	—	AV communication signal (L)	Input/ Output	—	—	—
32 (R)	—	AV communication signal (H)	Input/ Output	—	—	—

Wiring Diagram - BOSE AUDIO WITHOUT NAVIGATION WITH DVD ENTERTAINMENT SYSTEM -

INFOID:000000003702914

NOTE:

DVD PLAYER

[BOSE AUDIO WITHOUT NAVIGATION]

< ECU DIAGNOSIS >

In this section, PRESET SWITCH and MULTIFUNCTION SWITCH are written as the MULTIFUNCTION SWITCH.

BOSE AUDIO WITHOUT NAVIGATION WITH DVD ENTERTAINMENT SYSTEM

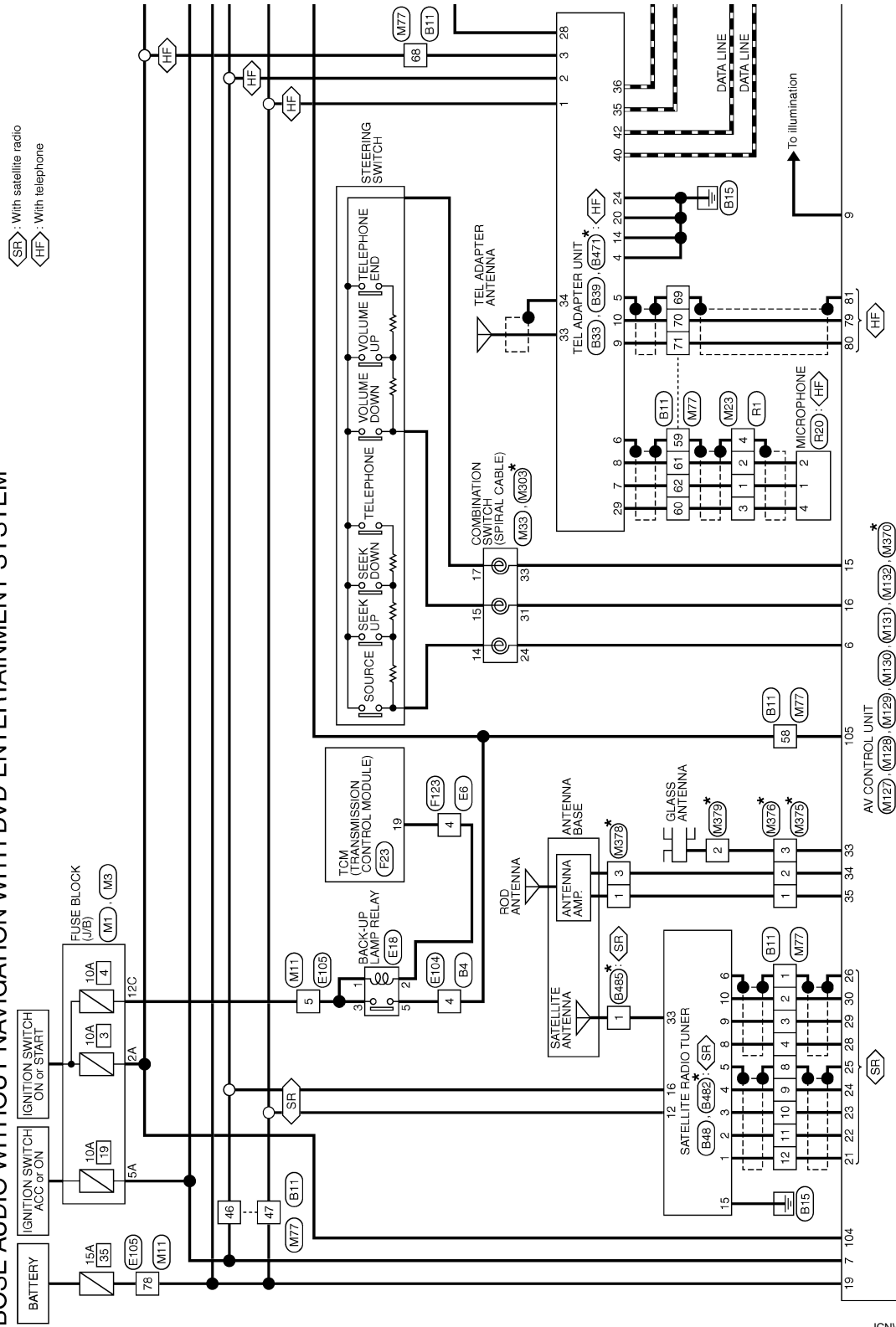

*: This connector is not shown in "Harness layout".

2008/09/23

JCNWM1872GI

A
B
C
D
E
F
G
H
I
J
K
L
M
N
O
P

AV

DVD PLAYER

[BOSE AUDIO WITHOUT NAVIGATION]

< ECU DIAGNOSIS >

- WI: With iPod
- HF: With telephone
- OF: Without telephone

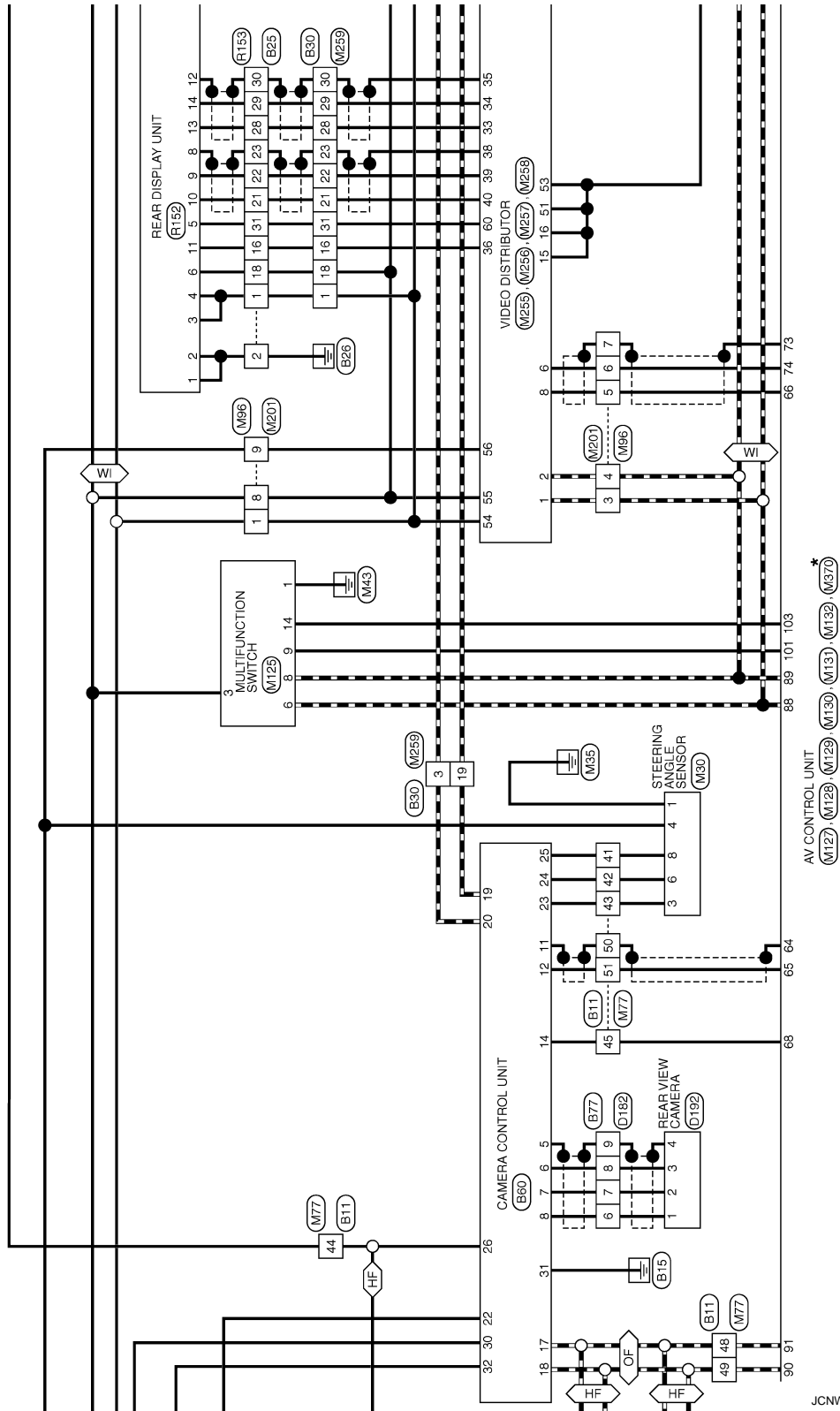

*: This connector is not shown in "Harness Layout".

JCNWM1873GI

DVD PLAYER

[BOSE AUDIO WITHOUT NAVIGATION]

< ECU DIAGNOSIS >

WI: With iPod

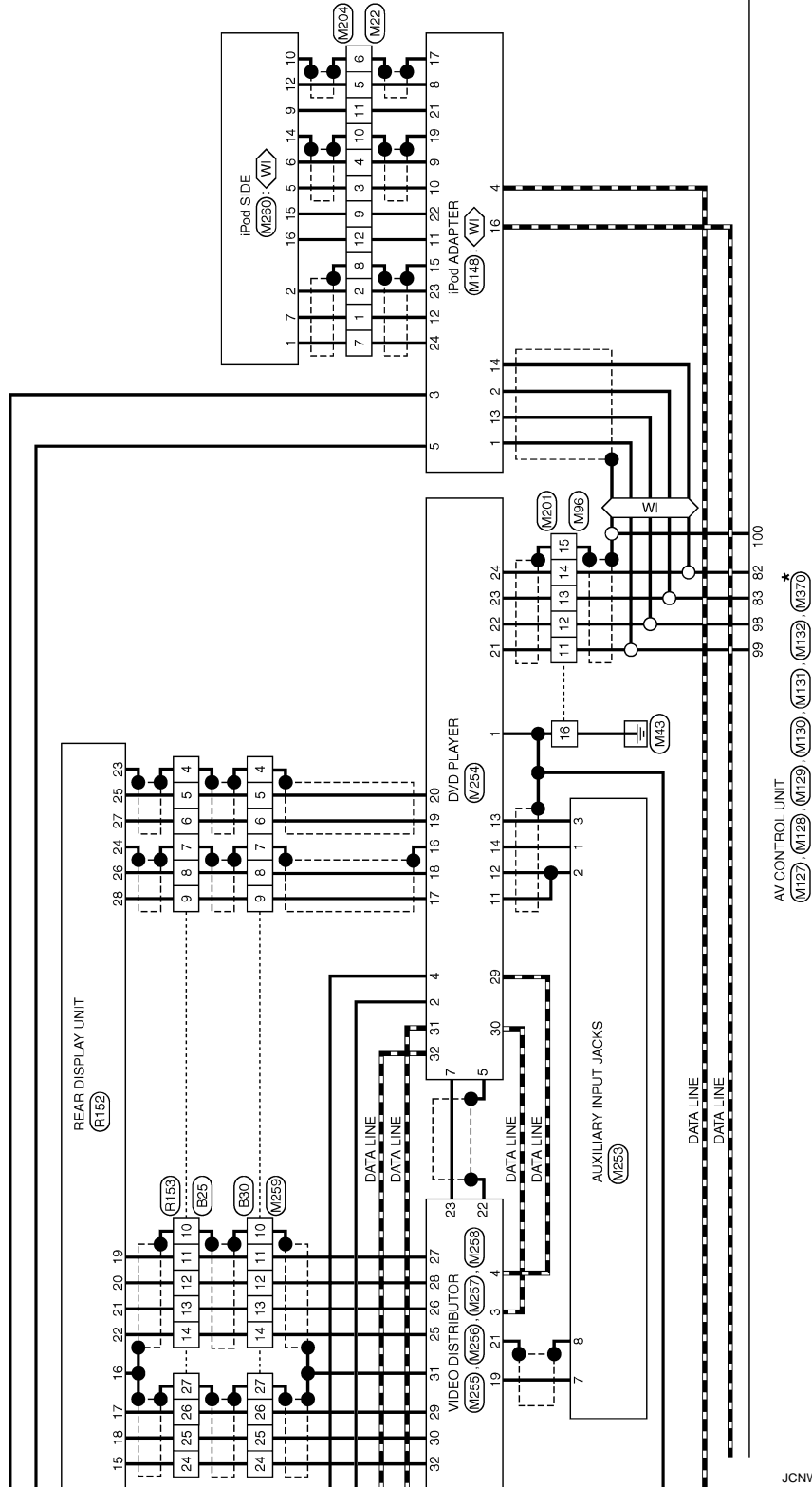

*: This connector is not shown in "Harness Layout".

JCNWM1874GI

A
B
C
D
E
F
G
H
I
J
K
L
M
N
O
P

AV

DVD PLAYER

[BOSE AUDIO WITHOUT NAVIGATION]

< ECU DIAGNOSIS >

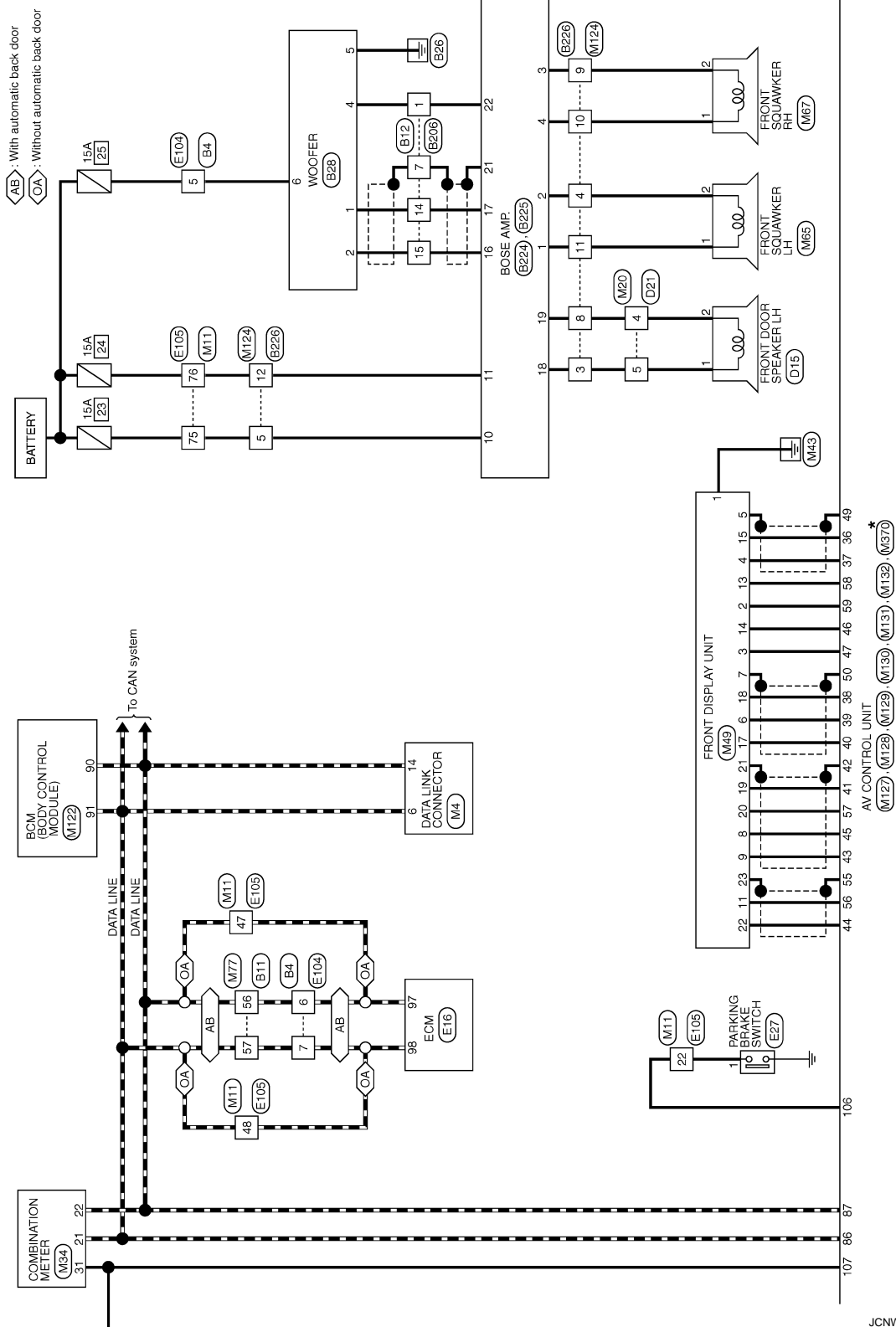

*: This connector is not shown in "Harness Layout".

JCNWM1875GI

DVD PLAYER

[BOSE AUDIO WITHOUT NAVIGATION]

< ECU DIAGNOSIS >

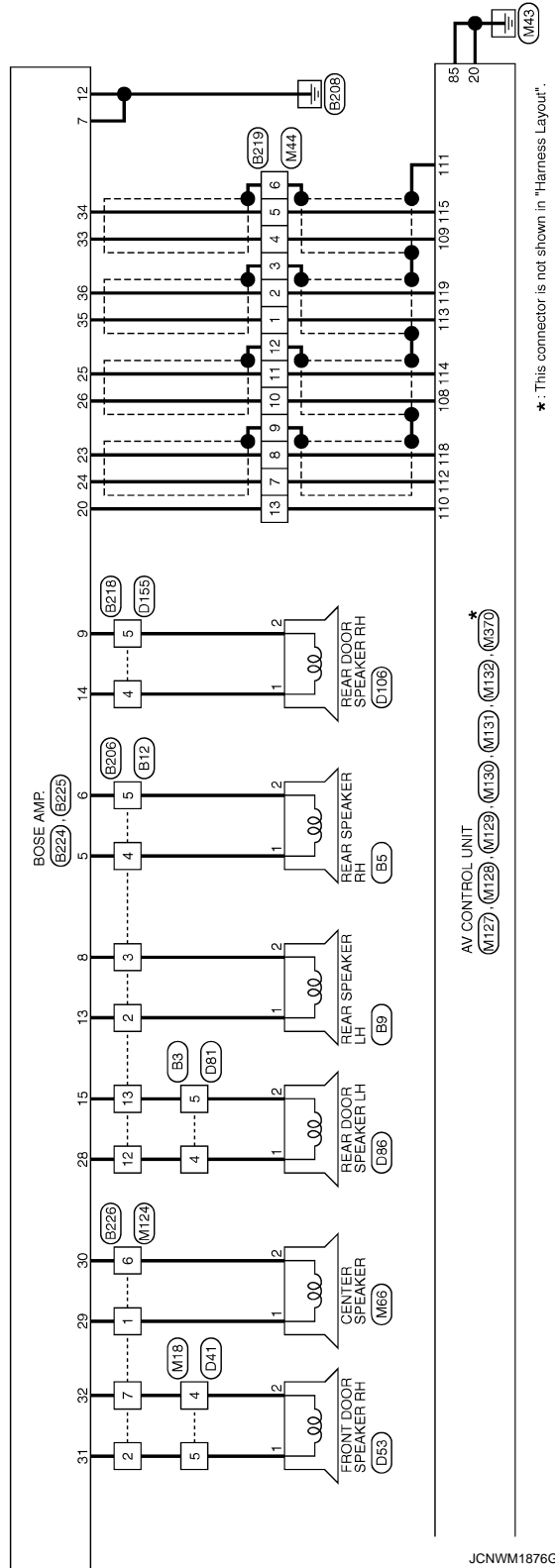

*: This connector is not shown in "Harness Layout".

JCNWM1876GI

A
B
C
D
E
F
G
H
I
J
K
L
M
N
O
P

AV

DVD PLAYER

[BOSE AUDIO WITHOUT NAVIGATION]

< ECU DIAGNOSIS >

BOSE AUDIO WITHOUT NAVIGATION WITH DVD ENTERTAINMENT SYSTEM

Connector No.	B3
Connector Name	WIRE TO WIRE
Connector Type	TK10FW-NS8



Terminal No.	Color of Wire	Signal Name [Specification]
4	LG	-
5	O	-

Connector No.	B4
Connector Name	WIRE TO WIRE
Connector Type	NS16MW-CS



Terminal No.	Color of Wire	Signal Name [Specification]
4	R	-
5	O	-
6	P	-
7	L	-

Connector No.	B5
Connector Name	REAR SPEAKER RH
Connector Type	TK02FBR



Terminal No.	Color of Wire	Signal Name [Specification]
1	V	-
2	LG	-

Connector No.	B9
Connector Name	REAR SPEAKER LH
Connector Type	TK02FBR



Terminal No.	Color of Wire	Signal Name [Specification]
1	SB	-
2	GR	-

Connector No.	B11
Connector Name	WIRE TO WIRE
Connector Type	TH80MW-CS19

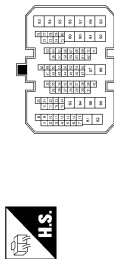

Terminal No.	Color of Wire	Signal Name [Specification]
1	SHIELD	-
2	B	-
3	R/L	-
4	R/W	-
8	SHIELD	-
9	BR/L	-
10	Y/G	-
11	Y/L	-
12	W/L	-
41	O	-
42	SB	-

43	G	-
44	BR	-
45	L	-
46	GR	-
47	V	-
48	GR	- [With rear view camera and telephone]
48	BR	- [With rear view camera without telephone]
49	Y	-
50	SHIELD	-
51	B	-
56	P	-
57	L	-
58	R	-
59	SHIELD	-
60	B	-
61	R/L	-
62	R/W	-
68	R	-
69	SHIELD	-
70	W/R	-
71	B/R	-

Connector No.	B12
Connector Name	WIRE TO WIRE
Connector Type	NS16FW-CS

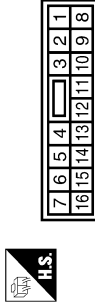

Terminal No.	Color of Wire	Signal Name [Specification]
1	W	-
2	SB	-
3	GR	-
4	V	-
5	LG	-
7	SHIELD	-
12	LG	-
13	O	-
14	W/R	-
15	B/R	-

BOSE AUDIO WITHOUT NAVIGATION WITH DVD ENTERTAINMENT SYSTEM

Connector No.	B25
Connector Name	WIRE TO WIRE
Connector Type	TH22MW-NH



1	2	3	4	5	6	7	8	9	10	11	12	13	14	15	16
17	18	19	20	21	22	23	24	25	26	27	28	29	30	31	32

Terminal No.	Color of Wire	Signal Name [Specification]
1	SB	-
2	B	-
4	SHIELD	-
5	W/R	-
6	W/L	-
7	SHIELD	-
8	GR/V	-
9	W/L	-
10	SHIELD	-
11	W/L	-
12	Y/G	-

Connector No.	B30
Connector Name	WIRE TO WIRE
Connector Type	TH22FW-NH



16	15	14	13	12	11	10	9	8	7	6	5	4	3	2	1
32	31	30	29	28	27	26	25	24	23	22	21	20	19	18	17

Terminal No.	Color of Wire	Signal Name [Specification]
1	SB	-
3	G	-
4	SHIELD	-
5	W/R	-
6	W/L	-
7	SHIELD	-
8	GR/V	-
9	W/L	-
10	SHIELD	-
11	W/L	-
12	Y/G	-

13	Y/L	-
14	BR/L	-
16	V	-
18	O	-
21	B/R	-
22	W/R	-
23	SHIELD	-
24	B	-
25	R/L	-
26	R/W	-
27	SHIELD	-
28	B	-
29	W	-
30	SHIELD	-
31	P	-

Connector No.	B28
Connector Name	WOOFER
Connector Type	RS28FGY-PR



Terminal No.	Color of Wire	Signal Name [Specification]
1	W/R	SOUND SIGNAL WOOFER (-)
2	B/R	SOUND SIGNAL WOOFER (+)
4	W	WOOFER AMP. ON SIGNAL
5	B/W	GND
6	O	BAT

Connector No.	B33
Connector Name	TEL ADAPTER UNIT
Connector Type	TH33FW-NH

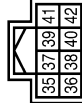

Terminal No.	Color of Wire	Signal Name [Specification]
35	Y	AV COMM (H)
36	BR	AV COMM (L)
40	G	AV COMM (H)
42	GR	AV COMM (L)

A
B
C
D
E
F
G
H
I
J
K
L
M
N
O
P

AV

DVD PLAYER

[BOSE AUDIO WITHOUT NAVIGATION]

< ECU DIAGNOSIS >

BOSE AUDIO WITHOUT NAVIGATION WITH DVD ENTERTAINMENT SYSTEM

Connector No.	B39
Connector Name	TEL ADAPTER UNIT
Connector Type	TH22FW-NH

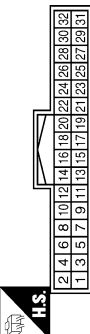

Terminal No.	Color of Wire	Signal Name [Specification]
1	V	BATTERY
2	GR	ACC
3	R	IGNITION
4	B/W	GND
5	SHIELD	SHIELD
6	SHIELD	SHIELD
7	R/W	MICROPHONE SIGNAL
8	R/L	MICROPHONE GND
9	B/R	TEL VOICE SIGNAL (+)
10	W/R	TEL VOICE SIGNAL (-)
14	B	GND

Connector No.	B80
Connector Name	CAMERA CONTROL UNIT
Connector Type	TH22FW-NH

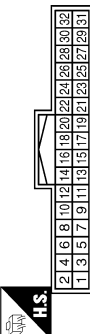

Terminal No.	Color of Wire	Signal Name [Specification]
5	SHIELD	SHIELD
6	B	CAMERA IMAGE SIGNAL
7	R/W	GND
8	R/L	CAMERA ON SIGNAL
9	SHIELD	SHIELD
10	B	CAMERA IMAGE SIGNAL
11	L	CONNECTION RECOGNITION
12	L	AV COMM (L)
13	Y	AV COMM (H)
14	GR	AV COMM (L)
15	GR	AV COMM (L)
16	G	AV COMM (H)

Connector No.	B48
Connector Name	SATELLITE RADIO TUNER
Connector Type	A16FW

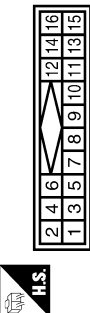

Terminal No.	Color of Wire	Signal Name [Specification]
1	W/L	SOUND SIGNAL LH (-)
2	Y/L	SOUND SIGNAL LH (+)
3	Y/G	SOUND SIGNAL RH (-)
4	BR/L	SOUND SIGNAL RH (+)
5	SHIELD	SHIELD
6	SHIELD	SHIELD
8	R/W	REQUEST (SAT->CONT)
9	R/L	COMM (SAT->CONT)
10	B	COMM (CONT->SAT)
12	V	BATTERY
15	B	GND

Connector No.	B77
Connector Name	WIRE TO WIRE
Connector Type	TK2MW

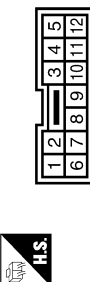

Terminal No.	Color of Wire	Signal Name [Specification]
22	R	REVERSE
23	G	SENSOR SIGNAL 1
24	SB	SENSOR SIGNAL 2
25	O	SENSOR SIGNAL 3
26	BR	VEHICLE SPEED (8-PULSE)
30	GR	ACC
31	B	GND
32	V	BATTERY

Terminal No.	16	GR	ACC
--------------	----	----	-----

Connector No.	B206
Connector Name	WIRE TO WIRE
Connector Type	NS16MW-CS



Terminal No.	Color of Wire	Signal Name [Specification]
1	W	
2	GR	
3	BR	
4	Y	
5	BR	
6	SHIELD	
7	G	
8	R	
9	W/R	
10	B/R	

BOSE AUDIO WITHOUT NAVIGATION WITH DVD ENTERTAINMENT SYSTEM

Connector No.	B218
Connector Name	WIRE TO WIRE
Connector Type	TK10FW-ANS

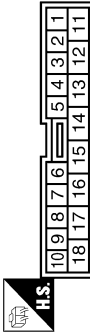

Connector No.	B219
Connector Name	WIRE TO WIRE
Connector Type	TH32MP-NH



Terminal No.	Color of Wire	Signal Name [Specification]
4	L	[With BOSE system]
5	O	[With BOSE system]

Terminal No.	Color of Wire	Signal Name [Specification]
1	W/R	
2	B/R	
3	SHIELD	
4	W/R	
5	B/R	
6	SHIELD	
7	GR/V	
8	W/L	
9	SHIELD	
10	GR/V	
11	W/L	

Connector No.	B224
Connector Name	BOSE AMP.
Connector Type	SGA12FBR-SJAZ

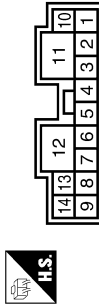

Connector No.	B225
Connector Name	BOSE AMP.
Connector Type	SCA19FBR-SGA4

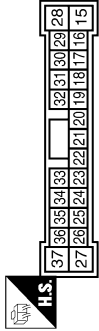

Terminal No.	Color of Wire	Signal Name [Specification]
1	LG	SOUND SIGNAL FRONT SQUAWKER LH (+)
2	V	SOUND SIGNAL FRONT SQUAWKER LH (-)
3	L	SOUND SIGNAL FRONT SQUAWKER RH (-)
4	P	SOUND SIGNAL FRONT SQUAWKER RH (+)
5	Y	SOUND SIGNAL REAR SPEAKER RH (+)
6	BR	SOUND SIGNAL REAR SPEAKER RH (-)
7	B	GND
8	BR	SOUND SIGNAL REAR SPEAKER LH (-)
9	O	SOUND SIGNAL REAR DOOR SPEAKER RH (-)
10	SB	BATTERY
11	GR	BATTERY

Terminal No.	Color of Wire	Signal Name [Specification]
15	R	SOUND SIGNAL REAR DOOR SPEAKER LH (-)
16	B/R	SOUND SIGNAL WOOFER (+)
17	W/R	SOUND SIGNAL WOOFER (-)
18	W	SOUND SIGNAL FRONT DOOR SPEAKER LH (-)
19	B	SOUND SIGNAL FRONT DOOR SPEAKER LH (+)
20	SB	AMP. ON SIGNAL
21	SHIELD	SHIELD
22	W	WOOFER AMP. ON SIGNAL
23	W/L	SOUND SIGNAL REAR LH (-)
24	GR/V	SOUND SIGNAL REAR LH (+)
25	W/L	SOUND SIGNAL REAR RH (-)

12	SHIELD
13	SB

26	GR/V	SOUND SIGNAL REAR RH (+)
28	G	SOUND SIGNAL REAR DOOR SPEAKER LH (+)
29	V	SOUND SIGNAL CENTER SPEAKER (+)
30	P	SOUND SIGNAL CENTER SPEAKER (-)
31	BR	SOUND SIGNAL FRONT DOOR SPEAKER RH (+)
32	Y	SOUND SIGNAL FRONT DOOR SPEAKER RH (-)
33	W/R	SOUND SIGNAL FRONT RH (+)
34	B/R	SOUND SIGNAL FRONT RH (-)
35	W/R	SOUND SIGNAL FRONT LH (-)
36	B/R	SOUND SIGNAL FRONT LH (+)

A
B
C
D
E
F
G
H
I
J
K
L
M
N
O
P

AV

JCNWM1880G1

BOSE AUDIO WITHOUT NAVIGATION WITH DVD ENTERTAINMENT SYSTEM

Connector No.	B226
Connector Name	WIRE TO WIRE
Connector Type	NS2MBR-CS

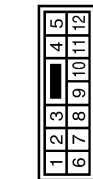

Terminal No.	Color of Wire	Signal Name [Specification]
1	V	
2	BR	
3	W	
4	V	
5	SB	
6	P	
7	Y	
8	B	
9	L	
10	P	
11	LG	
12	LG	

Connector No.	B465
Connector Name	ANTENNA BASE (SATELLITE ANTENNA) WITH BOSE SYSTEM WITHOUT NAVIGATION SYSTEM
Connector Type	GT16C-1PP-HU



Terminal No.	Color of Wire	Signal Name [Specification]
1	-	SATELLITE ANTENNA

Connector No.	B471
Connector Name	TEL ADAPTER UNIT
Connector Type	GT16C-1S-HU



Terminal No.	Color of Wire	Signal Name [Specification]
33	-	TEL ANTENNA
34	SHIELD	SHIELD

Connector No.	D21
Connector Name	WIRE TO WIRE
Connector Type	TH40FW-CS15

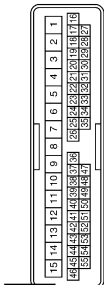

Terminal No.	Color of Wire	Signal Name [Specification]
4	B/W	-[Type A]
4	B	-[Type B]
5	L	-[Type A]
5	W	-[Type B]

Connector No.	B482
Connector Name	SATELLITE RADIO TUNER
Connector Type	FAK6A



Terminal No.	Color of Wire	Signal Name [Specification]
33	-	SATELLITE ANTENNA

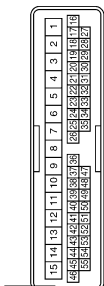

Connector No.	D41
Connector Name	WIRE TO WIRE
Connector Type	TH40FW-CS15



Terminal No.	Color of Wire	Signal Name [Specification]
4	B/R	-[Type A]
4	B	-[Type B]
5	BR	-[Type A]
5	W	-[Type B]



BOSE AUDIO WITHOUT NAVIGATION WITH DVD ENTERTAINMENT SYSTEM

Connector No.	D106
Connector Name	REAR DOOR SPEAKER RH (WITH BOSE SYSTEM)
Connector Type	NS2ZFBR-CS

Terminal No.	Color of Wire	Signal Name [Specification]
1	O	- [Type A]
1	L	- [Type B]
2	B/P	- [Type A]
2	W	- [Type B]

Connector No.	D98
Connector Name	REAR DOOR SPEAKER LH (WITH BOSE SYSTEM)
Connector Type	NS2ZFBR-CS



Terminal No.	Color of Wire	Signal Name [Specification]
1	L	-
2	W	-

Connector No.	D81
Connector Name	WIRE TO WIRE
Connector Type	TK10MW-NS

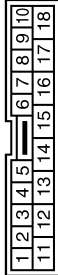

Terminal No.	Color of Wire	Signal Name [Specification]
4	L	-
5	W	-

Connector No.	D53
Connector Name	FRONT DOOR SPEAKER RH (WITH BOSE SYSTEM)
Connector Type	NS2ZFBR-CS



Terminal No.	Color of Wire	Signal Name [Specification]
1	BR	- [Type A]
1	W	- [Type B]
2	B/R	- [Type A]
2	B	- [Type B]

Connector No.	EB
Connector Name	WIRE TO WIRE
Connector Type	TK16MGY-TV

Terminal No.	Color of Wire	Signal Name [Specification]
4	R	-

Connector No.	D192
Connector Name	REAR VIEW CAMERA
Connector Type	TK4MMW-NH

Terminal No.	Color of Wire	Signal Name [Specification]
1	R	CAMERA ON SIGNAL
2	G	GND
3	B	CAMERA IMAGE SIGNAL
4	SHIELD	SHIELD

Connector No.	D182
Connector Name	WIRE TO WIRE
Connector Type	TK12FW

Terminal No.	Color of Wire	Signal Name [Specification]
6	R	-
7	G	-
8	B	-
9	SHIELD	-

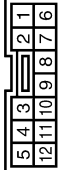
Connector No.	D155
Connector Name	WIRE TO WIRE
Connector Type	TK10MW-NS

Terminal No.	Color of Wire	Signal Name [Specification]
4	O	- [Type A]
4	L	- [Type B]
5	B/P	- [Type A]
5	W	- [Type B]

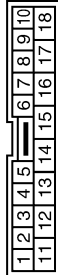
A
B
C
D
E
F
G
H
I
J
K
L
M
O
P

AV

JCNWM1882GI

BOSE AUDIO WITHOUT NAVIGATION WITH DVD ENTERTAINMENT SYSTEM

Connector No.	E18
Connector Name	ECM
Connector Type	RH24FB-R28-L-LH

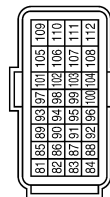

Terminal No.	Color of Wire	Signal Name [Specification]
97	P	VEHGAN-L
98	L	VEHGAN-H

Connector No.	E18
Connector Name	BACK-UP LAMP RELAY
Connector Type	MS02FL-M2-LC

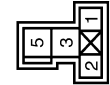

Terminal No.	Color of Wire	Signal Name [Specification]
1	LG	-
2	R	-
3	LG	-
5	R	-

Connector No.	E27
Connector Name	PARKING BRAKE SWITCH
Connector Type	F01FB-A



Terminal No.	Color of Wire	Signal Name [Specification]
1	P	-

Connector No.	E104
Connector Name	WIRE TO WIRE
Connector Type	NS36FW-CS



Terminal No.	Color of Wire	Signal Name [Specification]
4	R	-
5	L	-
6	P	-
7	L	-

Connector No.	E105
Connector Name	WIRE TO WIRE
Connector Type	TH70MW-CS10-M3

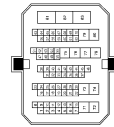

Terminal No.	Color of Wire	Signal Name [Specification]
5	LG	-
22	P	-
47	P	-
48	L	-
75	BR	-
76	GR	-
78	V	-

Connector No.	F23
Connector Name	TCM (TRANSMISSION CONTROL MODULE)
Connector Type	RH40FB-R28-L-RH

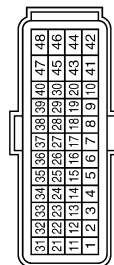

Terminal No.	Color of Wire	Signal Name [Specification]
19	G/B	REV LAMP RELAY

Connector No.	F123
Connector Name	WIRE TO WIRE
Connector Type	TK6FGY-1V

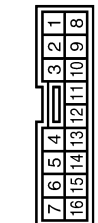

Terminal No.	Color of Wire	Signal Name [Specification]
4	G/B	-

Connector No.	M1
Connector Name	FUSE BLOCK (J/B)
Connector Type	NS06FW-M2



Terminal No.	Color of Wire	Signal Name [Specification]
2A	G	-
5A	R	-

BOSE AUDIO WITHOUT NAVIGATION WITH DVD ENTERTAINMENT SYSTEM

Connector No.	M3
Connector Name	FUSE BLOCK (J/B)
Connector Type	NS12FW-CS

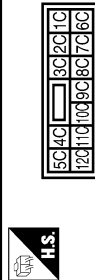

Terminal No.	Color of Wire	Signal Name [Specification]
12C	O	-

Connector No.	M4
Connector Name	DATA LINK CONNECTOR
Connector Type	BD16FW

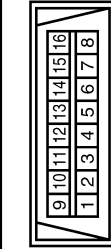

Terminal No.	Color of Wire	Signal Name [Specification]
6	L	-
14	P	-

Connector No.	M11
Connector Name	WIRE TO WIRE
Connector Type	TH10FW-CS10-M3

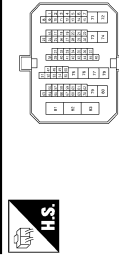

Terminal No.	Color of Wire	Signal Name [Specification]
5	O	-
22	G	-
47	P	-
48	L	-
75	BR	-
76	R	-
78	Y	-

Connector No.	M18
Connector Name	WIRE TO WIRE
Connector Type	TH40MW-CS15

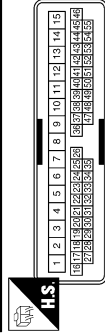

Terminal No.	Color of Wire	Signal Name [Specification]
4	W	-
5	BR	- [Type A and without BOSE system type B]
5	B	- [With BOSE system type B]

Connector No.	M20
Connector Name	WIRE TO WIRE
Connector Type	TH40MW-CS15

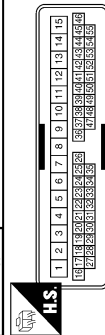

Terminal No.	Color of Wire	Signal Name [Specification]
4	B	-
5	L	-

Connector No.	M22
Connector Name	WIRE TO WIRE
Connector Type	TH12FW-NH

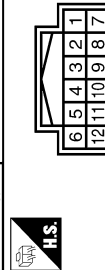

Terminal No.	Color of Wire	Signal Name [Specification]
1	V	-
2	R	-
3	R	-
4	G	-
5	W	-
6	SHIELD	-
7	LG	-
8	SHIELD	-
9	BR	-
10	SHIELD	-
11	L	-

Connector No.	M23
Connector Name	WIRE TO WIRE
Connector Type	TH16MW-NH

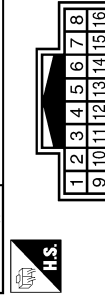

Terminal No.	Color of Wire	Signal Name [Specification]
1	W	-
2	R	- [With telephone without navigation system]
3	B	-
4	SHIELD	-

JCNWM1884GI

A
B
C
D
E
F
G
H
I
J
K
L
M
N
O
P

AV

BOSE AUDIO WITHOUT NAVIGATION WITH DVD ENTERTAINMENT SYSTEM

Connector No.	M30
Connector Name	STEERING ANGLE SENSOR
Connector Type	TH08FW-NH

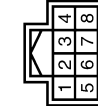

Terminal No.	Color of Wire	Signal Name [Specification]
1	B	-
3	L	-
4	G	-
6	SB	-
8	O	-

Connector No.	M33
Connector Name	COMBINATION SWITCH (SPIRAL CABLE)
Connector Type	TH08FGY-1V

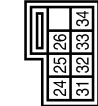

Terminal No.	Color of Wire	Signal Name [Specification]
24	BR	- [With audio steering switch and telephone]
31	G	- [With audio steering switch and telephone]
33	L	- [With audio steering switch and telephone]

Connector No.	M34
Connector Name	COMBINATION METER
Connector Type	TH40FW-NH

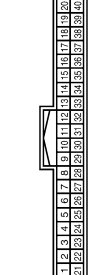

Terminal No.	Color of Wire	Signal Name [Specification]
21	L	CAN-H
22	P	CAN-L
31	V	VEHICLE SPEED (8-PULSE)

Connector No.	M44
Connector Name	WIRE TO WIRE
Connector Type	TH42FW-NH

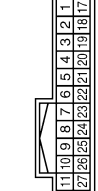

Terminal No.	Color of Wire	Signal Name [Specification]
1	G	-
2	R	-
3	SHIELD	-
4	B	-
5	W	-
6	SHIELD	-
7	O	- [Type A]
7	L	- [Type B]
8	SB	- [Type A]
8	R	- [Type B]
9	SHIELD	-

Terminal No.	10	V
11	LG	-
12	SHIELD	-
13	P	-

Connector No.	M49
Connector Name	FRONT DISPLAY UNIT
Connector Type	TH24FW-NH

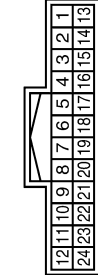

Terminal No.	Color of Wire	Signal Name [Specification]
1	B	GND
2	Y	INVERTER VCCI [Without navigation system]
3	O	SIGNAL VCCI [Without navigation system]
4	P	COMPOSITE IMAGE GND [Without navigation system]
5	SHIELD	SHIELD [Without navigation system]
6	L	RGB (GREEN) SIGNAL [Without navigation system]
7	SHIELD	SHIELD
8	G	HP [Without navigation system]
9	W	RGB AREA (YS) SIGNAL
11	R	COMM (CONT->DISP)
13	BR	INVERTER GND [Without navigation system]

14	LG	SIGNAL GND [Without navigation system]
15	L	COMPOSITE IMAGE SIGNAL [Without navigation system]
17	G	RGB (RED) SIGNAL
18	Y	RGB (BLUE) SIGNAL [Without navigation system]
19	B	RGB SYNC
20	R	VP
21	SHIELD	SHIELD
22	G	COMM (DISP->CONT)
23	SHIELD	SHIELD

BOSE AUDIO WITHOUT NAVIGATION WITH DVD ENTERTAINMENT SYSTEM

Connector No.	M65
Connector Name	FRONT SQUAWKER LH
Connector Type	TK02FBR



Terminal No.	Color of Wire	Signal Name [Specification]
1	LG	[With BOSE system]
2	Y	[With BOSE system]

Connector No.	M66
Connector Name	CENTER SPEAKER
Connector Type	TK02FBR



Terminal No.	Color of Wire	Signal Name [Specification]
1	P	
2	O	

Connector No.	M67
Connector Name	FRONT SQUAWKER RH
Connector Type	TK02FBR



Terminal No.	Color of Wire	Signal Name [Specification]
1	BR	
2	R	[With BOSE system]

Connector No.	M77
Connector Name	WIRE TO WIRE
Connector Type	TH80FW-C519

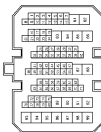

Terminal No.	Color of Wire	Signal Name [Specification]
1	SHIELD	
2	B	
3	W	
4	R	
8	SHIELD	
9	W	
10	R	
11	G	
12	B	
41	O	
42	SB	

43	L	
44	V	
45	P	
46	R	
47	Y	
48	L	
49	G	
50	SHIELD	
51	W	
56	P	
57	L	
58	SS	
59	SHIELD	
60	B	
61	R	
62	W	
68	G	
69	SHIELD	
70	L	
71	R	

Connector No.	M66
Connector Name	WIRE TO WIRE
Connector Type	TH18FW-NH

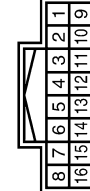

Terminal No.	Color of Wire	Signal Name [Specification]
1	Y	
3	R	
4	L	
5	L	
6	R	
7	SHIELD	
8	R	
9	G	
11	B	
12	G	
13	R	

14	W	
15	SHIELD	
16	B	

A
B
C
D
E
F
G
H
I
J
K
L
M
N
O
P

AV

JCNWM1886G1

DVD PLAYER

[BOSE AUDIO WITHOUT NAVIGATION]

< ECU DIAGNOSIS >

BOSE AUDIO WITHOUT NAVIGATION WITH DVD ENTERTAINMENT SYSTEM

Connector No.	M122
Connector Name	BCM BODY CONTROL MODULE
Connector Type	TH40FB-NH

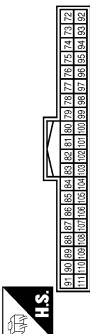

Terminal No.	Color of Wire	Signal Name [Specification]
90	P	CAN-L
91	L	CAN-H

11	LG	-
12	R	-

Connector No.	M125
Connector Name	MULTIFUNCTION SWITCH
Connector Type	TH16FW-NH

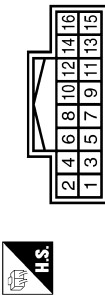

Terminal No.	Color of Wire	Signal Name [Specification]
1	B	GND
3	R	ACC
6	R	AV COMM (H)
8	L	AV COMM (L)
9	V	SW GND
14	W	EJECT SIGNAL

Connector No.	M127
Connector Name	AV CONTROL UNIT (WITH BOSE SYSTEM WITHOUT NAVIGATION SYSTEM)
Connector Type	TH18FW-CS2

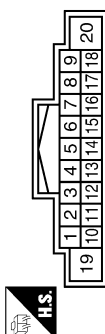

Connector No.	M128
Connector Name	AV CONTROL UNIT (WITH BOSE SYSTEM WITHOUT NAVIGATION SYSTEM)
Connector Type	A12FW

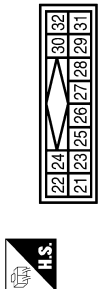

Connector No.	M129
Connector Name	AV CONTROL UNIT (WITH BOSE SYSTEM WITHOUT NAVIGATION SYSTEM)
Connector Type	TH24FW-NH



Terminal No.	Color of Wire	Signal Name [Specification]
47	O	SIGNAL VCC
49	SHIELD	SHIELD
50	SHIELD	SHIELD
55	SHIELD	SHIELD
56	R	COMM (CONT->DISP)
57	R	VP
58	BR	INVERTER GND
59	Y	INVERTER VCC

Terminal No.	Color of Wire	Signal Name [Specification]
6	BR	STRG SW A
7	R	ACC
9	R	ILLUMINATION
15	L	STRG SW GND
16	G	STRG SW B
19	Y	BATTERY
20	B	GND

Terminal No.	Color of Wire	Signal Name [Specification]
21	B	SATELLITE RADIO SOUND SIGNAL LH (-)
22	G	SATELLITE RADIO SOUND SIGNAL LH (+)
23	R	SATELLITE RADIO SOUND SIGNAL RH (-)
24	W	SATELLITE RADIO SOUND SIGNAL RH (+)
25	SHIELD	SHIELD
26	SHIELD	SHIELD
28	R	REQUEST (SAT->CONT)
29	W	COMM (SAT->CONT)
30	B	COMM (CONT->SAT)

Terminal No.	Color of Wire	Signal Name [Specification]
36	L	COMPOSITE IMAGE SIGNAL
37	P	COMPOSITE IMAGE GND
38	Y	RGB (B:BLUE) SIGNAL
39	L	RGB (G:GREEN) SIGNAL
40	G	RGB (R:RED) SIGNAL
41	B	RGB SYNC
42	SHIELD	SHIELD
43	W	RGB AREA (YS) SIGNAL
44	G	COMM (DISP->CONT)
45	G	HP
46	LG	SIGNAL GND

JCNWM1887GI

BOSE AUDIO WITHOUT NAVIGATION WITH DVD ENTERTAINMENT SYSTEM

Connector No.	M130
Connector Name	AV CONTROL UNIT (WITH BOSE SYSTEM WITHOUT NAVIGATION SYSTEM)
Connector Type	TH116FW-NH

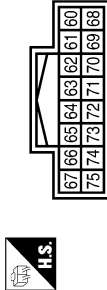

Connector No.	M131
Connector Name	AV CONTROL UNIT (WITH BOSE SYSTEM WITHOUT NAVIGATION SYSTEM)
Connector Type	TH122FW-NH

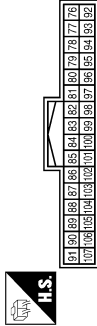

Terminal No.	Color of Wire	Signal Name [Specification]
64	SHIELD	SHIELD
65	W	CAMERA IMAGE SIGNAL
66	L	COMPOSITE IMAGE SIGNAL (With DVD player)
68	P	CONNECTION RECOGNITION SHIELD (With DVD player)
72	SHIELD	SHIELD (With DVD player)
74	R	COMPOSITE IMAGE GND (With DVD player)

Terminal No.	Color of Wire	Signal Name [Specification]
79	L	TEL VOICE SIGNAL (-)
80	R	TEL VOICE SIGNAL (+)
81	SHIELD	SHIELD
82	W	SOUND SIGNAL RH (-) (With DVD player)
83	R	SOUND SIGNAL RH (+) (With DVD player)
85	B	GND
86	L	CAN-H
87	P	CAN-L
88	R	AV COMM (H)
89	L	AV COMM (L)
90	G	AV COMM (H)

Connector No.	M132
Connector Name	AV CONTROL UNIT (WITH BOSE SYSTEM WITHOUT NAVIGATION SYSTEM)
Connector Type	TH121FW-NH

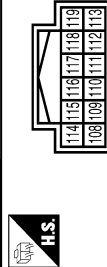

Terminal No.	Color of Wire	Signal Name [Specification]
108	V	SOUND SIGNAL REAR RH (+)
109	B	SOUND SIGNAL FRONT RH (+)
110	P	AMP. ON SIGNAL
111	SHIELD	SHIELD
112	O	SOUND SIGNAL REAR LH (+) (Type A)
112	L	SOUND SIGNAL REAR LH (+) (Type B)
113	G	SOUND SIGNAL FRONT LH (+)
114	LG	SOUND SIGNAL REAR RH (-)
115	W	SOUND SIGNAL FRONT RH (-)
118	SB	SOUND SIGNAL REAR LH (-) (Type A)
118	R	SOUND SIGNAL REAR LH (-) (Type B)

91	L	AV COMM (L)
98	G	SOUND SIGNAL LH (-) (With DVD player)
99	B	SOUND SIGNAL LH (+) (With DVD player)
100	SHIELD	SHIELD (With DVD player)
101	V	SW GND
103	W	EJECT SIGNAL
104	G	IGNITION
105	SB	REVERSE
106	G	PARKING BRAKE
107	V	VEHICLE SPEED (8-PULSE)

114	W	iPod SOUND SIGNAL RH (-)
15	SHIELD	SHIELD
16	R	AV COMM (H)
17	SHIELD	GND
19	SHIELD	SHIELD
21	L	iPod CONNECTION RECOGNITION
22	BR	ACCESSORY DETECT
23	R	iPod SOUND SIGNAL GND
24	LG	iPod SOUND SIGNAL LH (+)

Connector No.	M148
Connector Name	iPod ADAPTER
Connector Type	TH224FW-NH

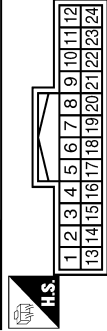

Terminal No.	Color of Wire	Signal Name [Specification]
1	BR	iPod SOUND SIGNAL LH (+)
2	R	iPod SOUND SIGNAL RH (+)
3	R	ACC
4	L	AV COMM (L)
5	Y	BATTERY
8	W	CHARGE POWER
9	G	COMM (iPod ADAPTER->iPod)
10	R	COMM (iPod->iPod ADAPTER)
11	R	ACCESSORY IDENTIFY
12	V	iPod SOUND SIGNAL RH (+)
13	L	iPod SOUND SIGNAL LH (-)

A
B
C
D
E
F
G
H
I
J
K
L
M
N
O
P

AV

DVD PLAYER

< ECU DIAGNOSIS >

[BOSE AUDIO WITHOUT NAVIGATION]

BOSE AUDIO WITHOUT NAVIGATION WITH DVD ENTERTAINMENT SYSTEM

Connector No.	M201
Connector Name	WIRE TO WIRE
Connector Type	TH16MW-NH

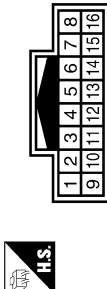

Terminal No.	Color of Wire	Signal Name [Specification]
1	Y	-
3	R	-
4	G	-
5	L	-
6	R	-
7	SHIELD	-
8	V	-
9	G	-
11	B	-
12	G	-
13	R	-

Connector No.	M253
Connector Name	AUXILIARY INPUT JACKS
Connector Type	A08FW



Terminal No.	Color of Wire	Signal Name [Specification]
1	R	SOUND SIGNAL RH (+)
2	W	SOUND SIGNAL GND
3	G	SOUND SIGNAL LH (-) [W/rr. DVD player]
7	G	AUX IMAGE SIGNAL
8	SHIELD	SHIELD [W/rr. DVD player]

Connector No.	M204
Connector Name	WIRE TO WIRE
Connector Type	TH12MW-NH



Terminal No.	Color of Wire	Signal Name [Specification]
1	V	-
2	R	-
3	R	-
4	G	-
5	W	-
6	SHIELD	-
7	LG	-
8	SHIELD	-
9	BR	-
10	SHIELD	-
11	L	-

Connector No.	M254
Connector Name	DVD PLAYER
Connector Type	TH32FW-NH

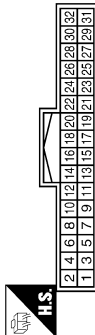

Terminal No.	Color of Wire	Signal Name [Specification]
1	B	GND
2	Y	BATTERY
4	V	ACC
5	SHIELD	SHIELD
7	P	DVD IMAGE SIGNAL
11	B	AUX SOUND SIGNAL LH (-)
12	W	AUX SOUND SIGNAL LH (+)
13	G	AUX SOUND SIGNAL RH (+)
14	R	AUX SOUND SIGNAL RH (-)
16	SHIELD	SHIELD
17	G	HEADPHONE SOUND SIGNAL LH (+)

12	R	-
----	---	---

Connector No.	M255
Connector Name	VIDEO DISTRIBUTOR
Connector Type	TH08FW-NH



Terminal No.	Color of Wire	Signal Name [Specification]
53	B	GND
54	Y	BATTERY
55	V	ACC
56	G	IGNITION
60	R	HEADPHONE ON SIGNAL

BOSE AUDIO WITHOUT NAVIGATION WITH DVD ENTERTAINMENT SYSTEM

Connector No.	M256
Connector Name	VIDEO DISTRIBUTOR
Connector Type	TH12FW-NH



Connector No.	M257
Connector Name	VIDEO DISTRIBUTOR
Connector Type	TH11FW-NH

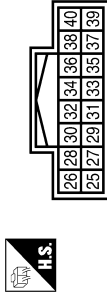

36	G	IGNITION
38	SHIELD	SHIELD
39	V	COMM (DISP->DIST)
40	LG	COMM (DIST->DISP)

Terminal No.	Color of Wire	Signal Name [Specification]
51	B	GND

Terminal No.	Color of Wire	Signal Name [Specification]
25	R	RGB (R(RED) SIGNAL
26	L	RGB (G(GREEN) SIGNAL
27	W	RGB GND
28	G	RGB (B(BLUE) SIGNAL
29	R	YP
30	W	HP
31	SHIELD	SHIELD
32	B	RGB AREA (Y/S) SIGNAL
33	G	COMPOSITE SYNC
34	R	COMPOSITE IMAGE SIGNAL
35	SHIELD	SHIELD

Connector No.	M258
Connector Name	VIDEO DISTRIBUTOR
Connector Type	TH12FW-NH

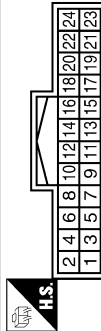

23	P	DVD IMAGE SIGNAL
----	---	------------------

Connector No.	M259
Connector Name	WIRE TO WIRE
Connector Type	TH32MW-NH

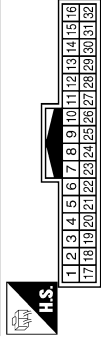

Terminal No.	Color of Wire	Signal Name [Specification]
1	R	AV COMM (H)
2	G	AV COMM (L)
3	R	AV COMM (H)
4	L	AV COMM (L)
6	R	COMPOSITE IMAGE GND
8	L	COMPOSITE IMAGE SIGNAL
15	B	GND
16	B	GND
19	G	AUX IMAGE SIGNAL
21	SHIELD	SHIELD
22	SHIELD	SHIELD

13	L	-
14	R	-
16	G	-
18	V	-
19	L	-
21	LG	-
22	V	-
23	SHIELD	-
24	B	-
25	W	-
26	R	-
27	SHIELD	-
28	G	-
29	R	-
30	SHIELD	-
31	R	-

Terminal No.	Color of Wire	Signal Name [Specification]
1	Y	-
3	R	-
4	SHIELD	-
5	LG	-
6	V	-
7	SHIELD	-
8	R	-
9	G	-
10	SHIELD	-
11	W	-
12	G	-

A
B
C
D
E
F
G
H
I
J
K
L
M
N
O
P

AV

BOSE AUDIO WITHOUT NAVIGATION WITH DVD ENTERTAINMENT SYSTEM

Connector No.	M376
Connector Name	iPod SIDE
Connector Type	IP16FGY

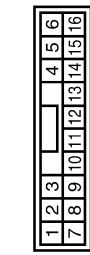

Terminal No.	Color of Wire	Signal Name [Specification]
1	LG	iPod SOUND SIGNAL LH (+)
2	R	iPod SOUND SIGNAL LH (-)
5	R	COMM (iPod->iPod ADAPTER)
6	G	COMM (iPod ADAPTER->iPod)
7	V	iPod SOUND SIGNAL RH (+)
8	L	iPod SOUND SIGNAL RH (-)
9	—	iPod CONNECTION RECOGNITION GND
10	—	SHIELD
12	W	CHARGE POWER
14	—	SHIELD
15	BR	ACCESSORY DETECT
16	R	ACCESSORY IDENTIFY

Connector No.	M303
Connector Name	COMBINATION SWITCH (SPIRAL CABLE)
Connector Type	TK08FGY



Terminal No.	Color of Wire	Signal Name [Specification]
14	—	—
15	—	—
17	—	—

Connector No.	M370
Connector Name	AV CONTROL UNIT (WITH BOSE SYSTEM WITHOUT NAVIGATION SYSTEM)
Connector Type	GT13SCH-2/1S-HU



Terminal No.	Color of Wire	Signal Name [Specification]
33	—	FM SUB
34	—	AM-FM MAIN
35	—	ANTENNA AMP. ON SIGNAL

Connector No.	M375
Connector Name	WIRE TO WIRE
Connector Type	GT13SCH-2/1S-HU

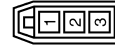

Terminal No.	Color of Wire	Signal Name [Specification]
1	—	—
2	—	—
3	—	—

Connector No.	M376
Connector Name	WIRE TO WIRE
Connector Type	GT13SCH-2/1PP-HU



Terminal No.	Color of Wire	Signal Name [Specification]
1	—	—
2	—	—
3	—	—

Connector No.	M378
Connector Name	ANTENNA BASE (ANTENNA AMP.)
Connector Type	GT13SSN-1/1PP-HU

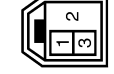

Terminal No.	Color of Wire	Signal Name [Specification]
1	—	—
3	—	—

Connector No.	M379
Connector Name	GLASS ANTENNA
Connector Type	GT13SCN-1/1PP-HU



Terminal No.	Color of Wire	Signal Name [Specification]
2	—	FM SUB

Connector No.	FT
Connector Name	WIRE TO WIRE
Connector Type	TH16FW-NH

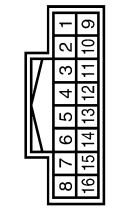

Terminal No.	Color of Wire	Signal Name [Specification]
1	R/W	—
2	R/L	— [With telephones without navigation system]
3	B	—
4	SHIELD	—

A
B
C
D
E
F
G
H
I
J
K
L
M
N
O
P

BOSE AUDIO WITHOUT NAVIGATION WITH DVD ENTERTAINMENT SYSTEM

Connector No.	R20
Connector Name	MICROPHONE
Connector Type	TH24FW



Connector No.	R152
Connector Name	REAR DISPLAY UNIT
Connector Type	TH32FW-NH

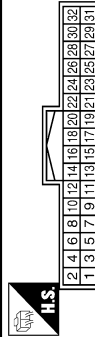

Terminal No.	Color of Wire	Signal Name [Specification]
1	R/W	MICROPHONE SIGNAL (+)
2	R/L	MICROPHONE SIGNAL (-) (Only in models with navigation system)
4	B	MICROPHONE POWER

Terminal No.	Color of Wire	Signal Name [Specification]
1	B	GND
2	B	GND
3	Y/R	BATTERY
4	Y/R	BATTERY
5	R	HEADPHONE ON SIGNAL
6	V/Y	ACC
8	SHIELD	SHIELD
9	V	COMM (DISP->DISP)
10	LG	COMM (DISP->DISP)
11	G	IGNITION
12	SHIELD	SHIELD

Connector No.	R153
Connector Name	WIRE TO WIRE
Connector Type	TH32FW-NH

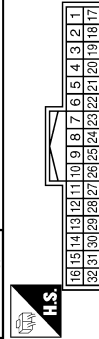

13	Y/L	-
14	BR/L	-
16	G	-
18	V/Y	-
21	LG	-
22	V	-
23	SHIELD	-
24	B	-
25	W	-
26	R	-
27	SHIELD	-
28	G	-
29	R	-
30	SHIELD	-
31	R	-

13	G	COMPOSITE SYNC
14	R	COMPOSITE IMAGE SIGNAL
15	B	RGB AREA (V/S) SIGNAL
16	SHIELD	RGB AREA (V/S) SIGNAL
17	R	GND
18	W	VP
19	W/L	HP
20	Y/G	RGB GND
21	Y/L	RGB (B/BLUE) SIGNAL
22	BR/L	RGB (G/GREEN) SIGNAL
23	SHIELD	RGB (R/RED) SIGNAL
24	SHIELD	SHIELD
25	LG	HEADPHONE SIGNAL SIGNAL RH (-)
26	BR	HEADPHONE SIGNAL SIGNAL LH (-)
27	V	HEADPHONE SOUND SIGNAL SIGNAL RH (+)
28	Y	HEADPHONE SOUND SIGNAL SIGNAL LH (+)

JCNWM1892GI

SATELLITE RADIO TUNER

[BOSE AUDIO WITHOUT NAVIGATION]

< ECU DIAGNOSIS >

SATELLITE RADIO TUNER

Reference Values

INFOID:000000003356838

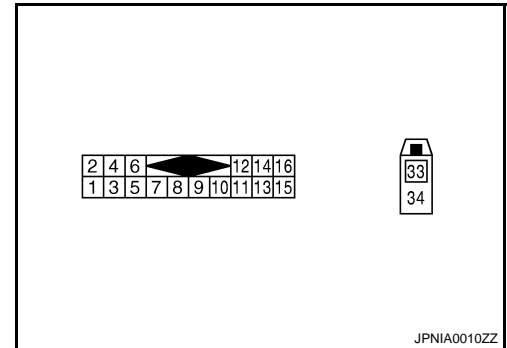

PHYSICAL VALUES

Terminal		Description		Condition		Reference value (Approx.)
+	-	Signal name	Input/Output			
2 (Y/L)	1 (W/L)	Satellite radio sound signal LH	Output	Ignition switch ON	When satellite radio mode is selected	<p style="text-align: right;">SKIB3609E</p>
4 (BR/L)	3 (Y/G)	Satellite radio sound signal RH	Output	Ignition switch ON	When satellite radio mode is selected	<p style="text-align: right;">SKIB3609E</p>
5	—	Shield	—	—	—	—
6	—	Shield	—	—	—	—
8 (R/W)	Ground	Request signal (SAT→CONT)	Output	Ignition switch ON	When satellite radio mode is selected	<p style="text-align: right;">SKIA9299J</p>
9 (R/L)	Ground	Communication signal (SAT→CONT)	Output	Ignition switch ON	When satellite radio mode is selected	<p style="text-align: right;">SKIA9300J</p>

SATELLITE RADIO TUNER

[BOSE AUDIO WITHOUT NAVIGATION]

< ECU DIAGNOSIS >

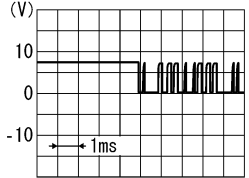
Terminal		Description		Condition		Reference value (Approx.)
+	-	Signal name	Input/Output			
10 (B)	Ground	Communication signal (CONT→SAT)	Input	Ignition switch ON	When satellite radio mode is selected	 <p style="text-align: right; font-size: small;">SKIA9301J</p>
12 (V)	Ground	Battery power supply	Input	Ignition switch OFF	—	Battery voltage
15 (B)	Ground	Ground	—	Ignition switch ON	—	0 V
16 (GR)	Ground	ACC power supply	Input	Ignition switch ACC	—	Battery voltage
33	—	Satellite antenna	Input	—	—	—

Wiring Diagram - BOSE AUDIO WITHOUT NAVIGATION WITHOUT DVD ENTERTAINMENT SYSTEM -

INFOID:000000003702915

NOTE:

- In this section, PRESET SWITCH and MULTIFUNCTION SWITCH are written as the MULTIFUNCTION SWITCH.
- Type A: Up to VIN: JN8AZ18U*9W100000, JN8AZ18W*9W200000 (EXCEPT FOR MEXICO), JN8AZ18U*9W710000, JN8AZ18W*9W810000 (FOR MEXICO)

A
B
C
D
E
F
G
H
I
J
K
L
M

AV

O
P

SATELLITE RADIO TUNER

[BOSE AUDIO WITHOUT NAVIGATION]

< ECU DIAGNOSIS >

- Type B: From VIN: JN8AZ18U*9W10001, JN8AZ18W*9W20001 (EXCEPT FOR MEXICO), JN8AZ18U*9W710001, JN8AZ18W*9W810001 (FOR MEXICO)

BOSE AUDIO WITHOUT NAVIGATION WITHOUT DVD ENTERTAINMENT SYSTEM

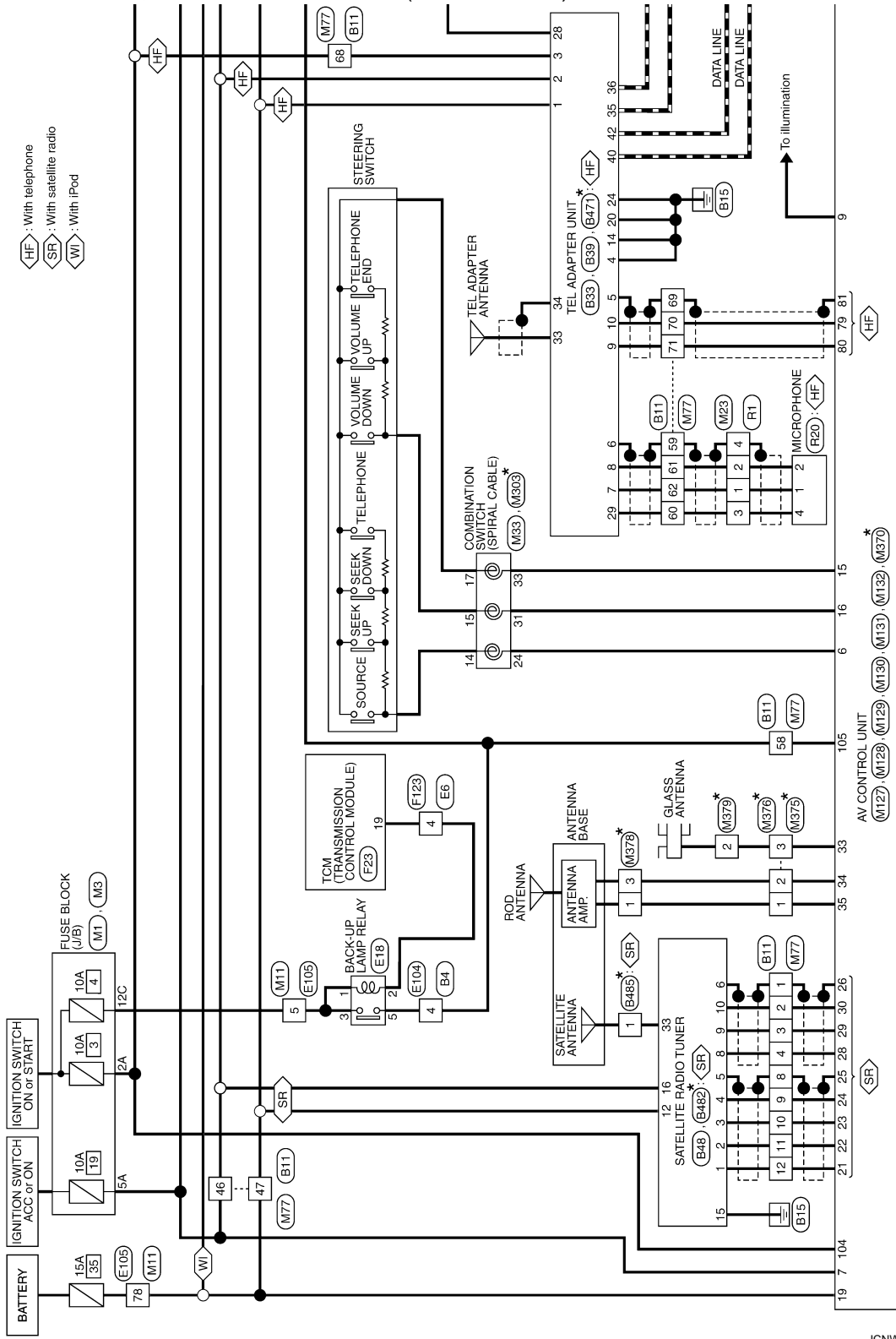

*: This connector is not shown in "Harness Layout".

2008/09/23

JCNWM1855GI

SATELLITE RADIO TUNER

[BOSE AUDIO WITHOUT NAVIGATION]

< ECU DIAGNOSIS >

- : With telephone
- : Without telephone
- : With iPod

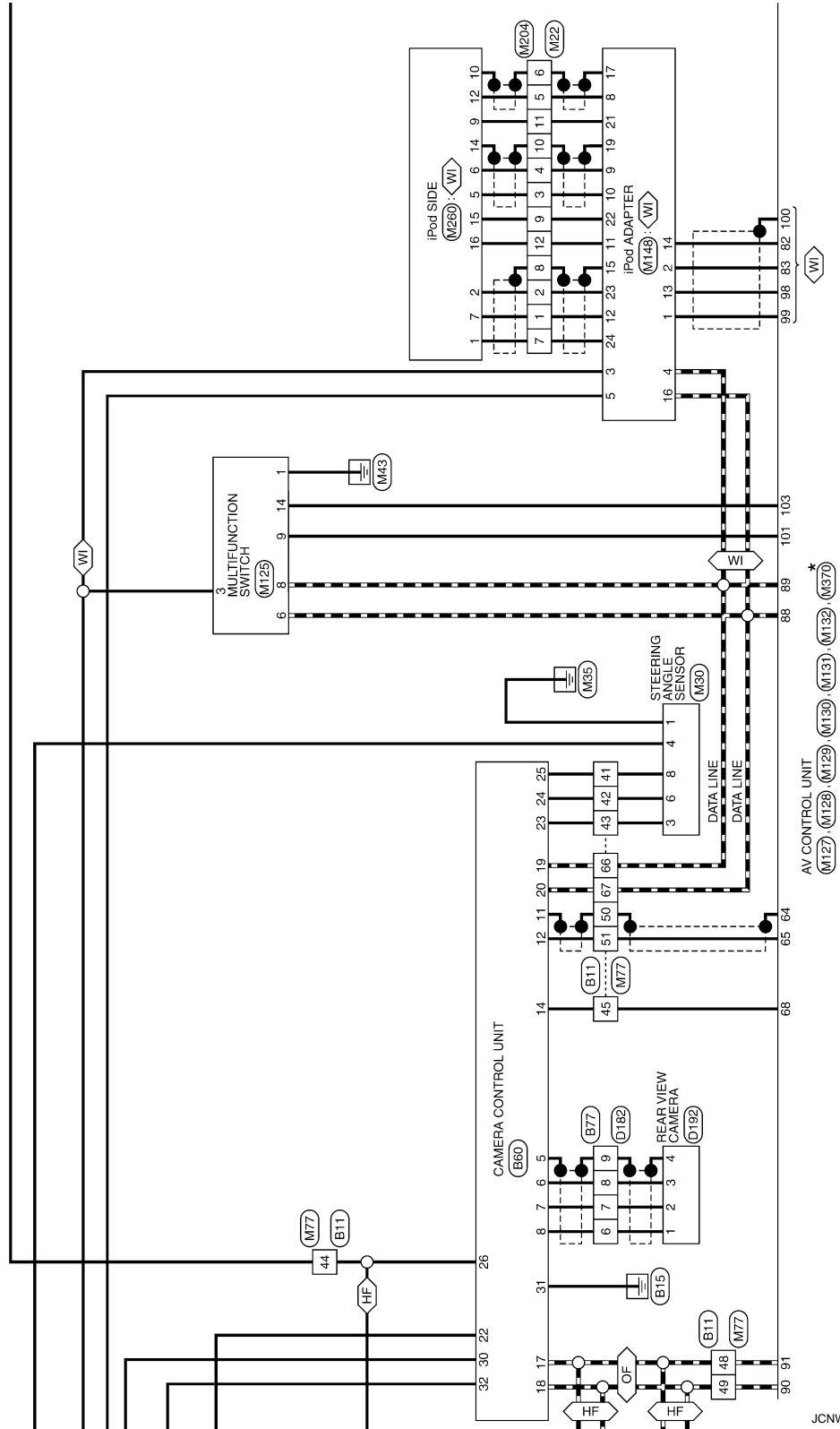

*: This connector is not shown in "Harness Layout".

JCNWM1856GI

A
B
C
D
E
F
G
H
I
J
K
L
M
N
O
P

AV

SATELLITE RADIO TUNER

[BOSE AUDIO WITHOUT NAVIGATION]

< ECU DIAGNOSIS >

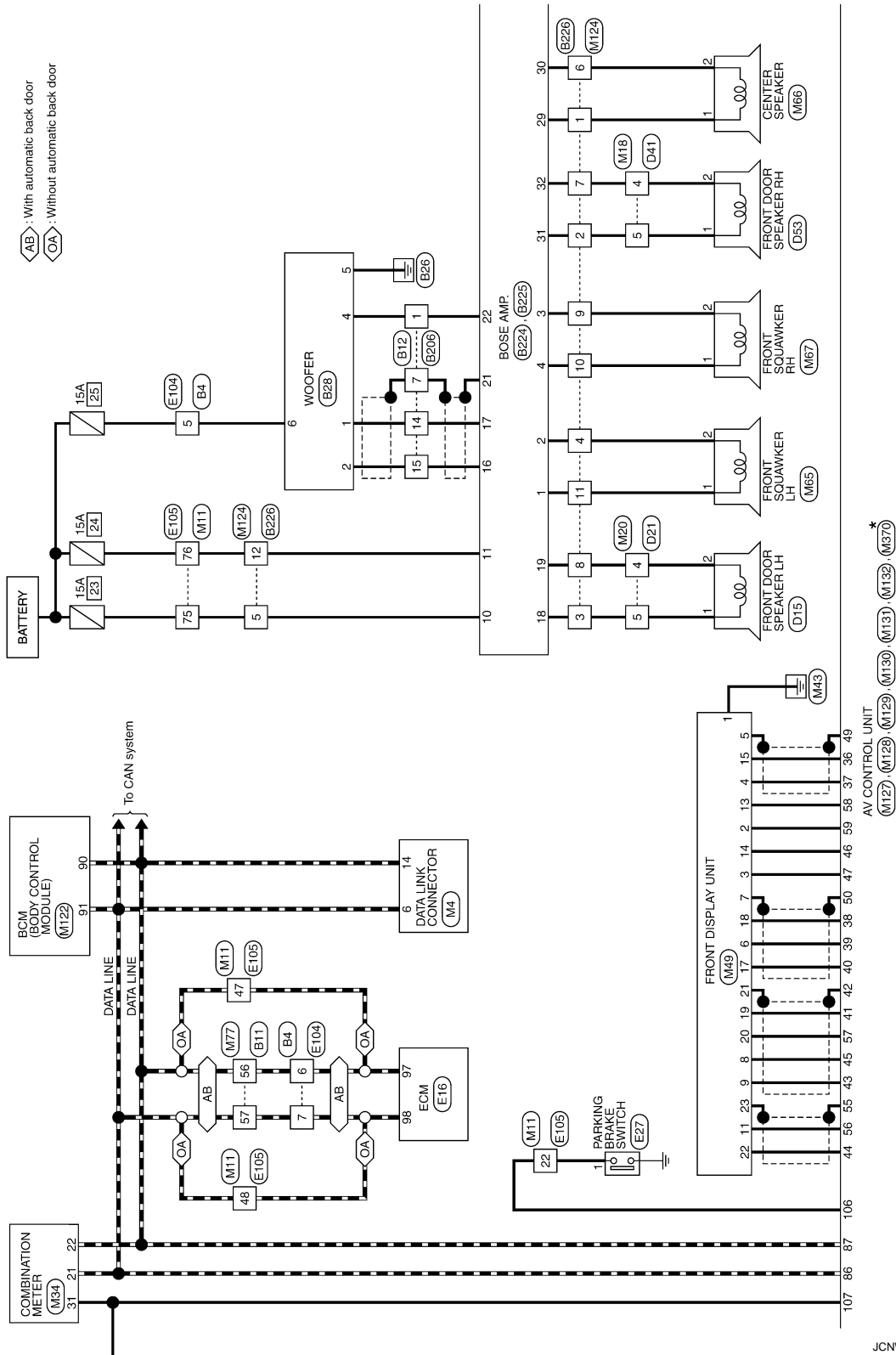

*: This connector is not shown in "Harness Layout".

JCNWM1857GI

SATELLITE RADIO TUNER

[BOSE AUDIO WITHOUT NAVIGATION]

< ECU DIAGNOSIS >

TA : Type A
TB : Type B

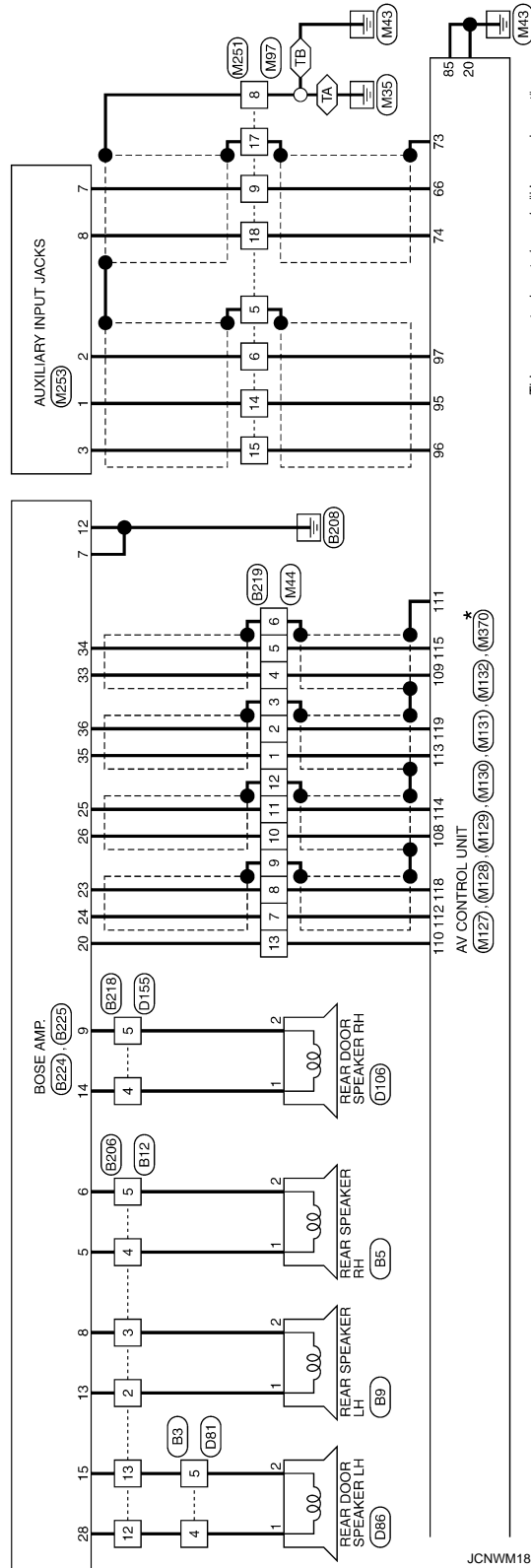

*: This connector is not shown in "Harness Layout".

JCNWM1858GI

A
B
C
D
E
F
G
H
I
J
K
L
M
AV
O
P

SATELLITE RADIO TUNER

[BOSE AUDIO WITHOUT NAVIGATION]

< ECU DIAGNOSIS >

BOSE AUDIO WITHOUT NAVIGATION WITHOUT DVD ENTERTAINMENT SYSTEM

Connector No.	B3
Connector Name	WIRE TO WIRE
Connector Type	TK07W-NS8



Terminal No.	Color of Wire	Signal Name [Specification]
4	LG	-
5	O	-

Connector No.	B4
Connector Name	WIRE TO WIRE
Connector Type	NS16MW-CS

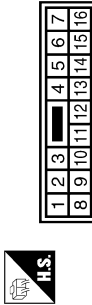

Terminal No.	Color of Wire	Signal Name [Specification]
4	R	-
5	O	-
6	P	-
7	L	-

Connector No.	B5
Connector Name	REAR SPEAKER RH
Connector Type	TK02FBR



Terminal No.	Color of Wire	Signal Name [Specification]
1	V	-
2	LG	-

Connector No.	B9
Connector Name	REAR SPEAKER LH
Connector Type	TK02FBR



Terminal No.	Color of Wire	Signal Name [Specification]
1	SB	-
2	GR	-

Connector No.	B11
Connector Name	WIRE TO WIRE
Connector Type	TH80MW-CS19

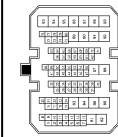

Terminal No.	Color of Wire	Signal Name [Specification]
1	SHIELD	-
2	B	-
3	R/L	-
4	R/W	-
8	SHIELD	-
9	BR/L	-
10	Y/G	-
11	Y/L	-
12	W/L	-
41	O	-
42	SB	-

43	G	-
44	BR	-
45	L	-
46	GR	-
47	V	-
48	GR	- [With rear view camera and telephone]
48	BR	- [With rear view camera without telephone]
49	Y	-
50	SHIELD	-
51	B	-
56	P	-
57	L	-
58	R	-
59	SHIELD	-
60	B	-
61	R/L	-
62	R/W	-
66	GR	-
67	G	-
68	R	-
69	SHIELD	-
70	W/R	-
71	B/R	-

Connector No.	B12
Connector Name	WIRE TO WIRE
Connector Type	NS18FW-CS

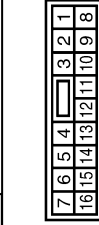

Terminal No.	Color of Wire	Signal Name [Specification]
1	W	-
2	SB	-
3	GR	-
4	V	-
5	LG	-
7	SHIELD	-
12	LG	-
13	O	-
14	W/R	-
15	B/R	-

Connector No.	B28
Connector Name	WOOFER
Connector Type	RS08FGY-PR



Terminal No.	Color of Wire	Signal Name [Specification]
1	W/R	SOUND SIGNAL WOOFER (-)
2	B/R	SOUND SIGNAL WOOFER (+)
4	W	WOOFER AMP. ON SIGNAL
5	B/W	GND
6	O	BAT

JCNWM1859G1

SATELLITE RADIO TUNER

[BOSE AUDIO WITHOUT NAVIGATION]

< ECU DIAGNOSIS >

BOSE AUDIO WITHOUT NAVIGATION WITHOUT DVD ENTERTAINMENT SYSTEM

Connector No.	B33
Connector Name	TEL ADAPTER UNIT
Connector Type	TH88FW-NH



Terminal No.	Color of Wire	Signal Name [Specification]
35	Y	AV COMM (H)
36	BR	AV COMM (L)
40	G	AV COMM (H)
42	GR	AV COMM (L)

Connector No.	B39
Connector Name	TEL ADAPTER UNIT
Connector Type	TH32FW-NH

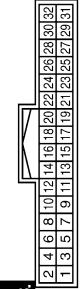

Terminal No.	Color of Wire	Signal Name [Specification]
1	V	BATTERY
2	GR	ACC
3	R	IGNITION
4	B/W	GND
5	SHIELD	SHIELD
6	SHIELD	SHIELD
7	R/W	MICROPHONE SIGNAL
8	R/L	MICROPHONE GND
9	B/R	TEL VOICE SIGNAL (+)
10	W/R	TEL VOICE SIGNAL (-)
14	B	GND

Connector No.	B48
Connector Name	SATELLITE RADIO TUNER
Connector Type	A18FW

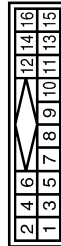

Terminal No.	Color of Wire	Signal Name [Specification]
1	W/L	SOUND SIGNAL LH (-)
2	Y/L	SOUND SIGNAL LH (+)
3	Y/G	SOUND SIGNAL RH (-)
4	BR/L	SOUND SIGNAL RH (+)
5	SHIELD	SHIELD
6	SHIELD	SHIELD
8	R/W	REQUEST (SAT->CONT)
9	R/L	COMM (SAT->CONT)
10	B	COMM (CONT->SAT)
12	V	BATTERY
15	B	GND

20	B	CONTROL SIGNAL
24	B/W	CONTROL SIGNAL
28	BR	VEHICLE SPEED (8-PULSE)
29	B	MICROPHONE VCC

22	R	REVERSE
23	G	SENSOR SIGNAL 1
24	SB	SENSOR SIGNAL 2
25	O	SENSOR SIGNAL 3
26	BR	VEHICLE SPEED (8-PULSE)
30	GR	ACC
31	B	GND
32	V	BATTERY

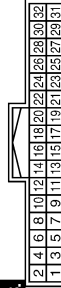

Terminal No.	Color of Wire	Signal Name [Specification]
5	SHIELD	SHIELD
6	B	CAMERA IMAGE SIGNAL
7	R/W	GND
8	R/L	CAMERA ON SIGNAL
11	SHIELD	SHIELD
12	B	CAMERA IMAGE SIGNAL
14	L	CONNECTION RECOGNITION
17	BR	AV COMM (L)
18	Y	AV COMM (H)
19	GR	AV COMM (L)
20	G	AV COMM (H)

A
B
C
D
E
F
G
H
I
J
K
L
M
N
O
P

AV

JCNWM1860GI

SATELLITE RADIO TUNER

[BOSE AUDIO WITHOUT NAVIGATION]

< ECU DIAGNOSIS >

BOSE AUDIO WITHOUT NAVIGATION WITHOUT DVD ENTERTAINMENT SYSTEM

Connector No.	B77
Connector Name	WIRE TO WIRE
Connector Type	TK12MW

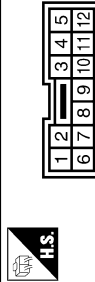

Terminal No.	Color of Wire	Signal Name [Specification]
6	R/L	-
7	R/W	-
8	B	-
9	SHIELD	-

Connector No.	B219
Connector Name	WIRE TO WIRE
Connector Type	TH82MW-NH

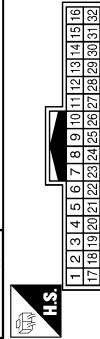

Terminal No.	Color of Wire	Signal Name [Specification]
1	W/R	-
2	B/R	-
3	SHIELD	-
4	W/R	-
5	B/R	-
6	SHIELD	-
7	GR/V	-
8	W/L	-
9	SHIELD	-
10	GR/V	-
11	W/L	-

Connector No.	B706
Connector Name	WIRE TO WIRE
Connector Type	NS16MW-CS

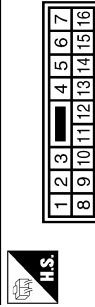

Terminal No.	Color of Wire	Signal Name [Specification]
1	W	-
2	GR	-
3	BR	-
4	Y	-
5	BR	-
7	SHIELD	-
12	G	-
13	R	-
14	W/R	-
15	B/R	-

Terminal No.	12	SHIELD	-
Terminal No.	13	SB	-

Connector No.	B218
Connector Name	WIRE TO WIRE
Connector Type	TK10FW-NSB

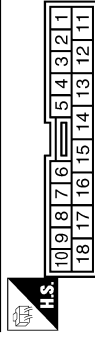

Terminal No.	Color of Wire	Signal Name [Specification]
4	L	- [With BOSE system]
5	O	- [With BOSE system]

Connector No.	B224
Connector Name	BOSE AMP.
Connector Type	SGA12FBR-SJA2

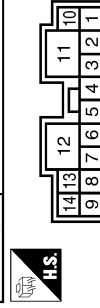

Terminal No.	Color of Wire	Signal Name [Specification]
1	LG	SOUND SIGNAL FRONT SQUAWKER LH (+)
2	V	SOUND SIGNAL FRONT SQUAWKER LH (-)
3	L	SOUND SIGNAL FRONT SQUAWKER RH (-)
4	P	SOUND SIGNAL FRONT SQUAWKER RH (+)
5	Y	SOUND SIGNAL REAR SPEAKER RH (+)
6	BR	SOUND SIGNAL REAR SPEAKER RH (-)
7	B	GND
8	BR	SOUND SIGNAL REAR SPEAKER LH (-)
9	O	SOUND SIGNAL REAR DOOR SPEAKER RH (-)
10	SB	BATTERY
11	GR	BATTERY

Terminal No.	12	B	GND
Terminal No.	13	GR	SOUND SIGNAL REAR DOOR SPEAKER LH (+)
Terminal No.	14	L	SOUND SIGNAL REAR DOOR SPEAKER RH (+)

JCNWM1861GI

SATELLITE RADIO TUNER

[BOSE AUDIO WITHOUT NAVIGATION]

< ECU DIAGNOSIS >

BOSE AUDIO WITHOUT NAVIGATION WITHOUT DVD ENTERTAINMENT SYSTEM

Connector No.	B225
Connector Name	BOSE AMP.
Connector Type	SCA1PBR-SGA4

Terminal No.	Color of Wire	Signal Name [Specification]
15	R	SOUND SIGNAL REAR DOOR SPEAKER LH (-)
16	B/R	SOUND SIGNAL REAR DOOR SPEAKER LH (+)
17	W/R	SOUND SIGNAL WOOFER (+)
18	W	SOUND SIGNAL FRONT DOOR SPEAKER LH (+)
18	B	SOUND SIGNAL FRONT DOOR SPEAKER LH (-)
20	SB	AMP ON SIGNAL
21	SHIELD	SHIELD
22	W	WOOFER AMP-ON SIGNAL
23	W/L	SOUND SIGNAL REAR LH (-)
24	GR/V	SOUND SIGNAL REAR LH (+)
25	W/L	SOUND SIGNAL REAR RH (-)

37	36	35	34	33
27	26	25	24	23
22	21	20	19	18
17	16	15		

26	GR/V	SOUND SIGNAL REAR RH (+)
28	G	SOUND SIGNAL REAR DOOR SPEAKER LH (+)
29	V	SOUND SIGNAL CENTER SPEAKER (+)
30	P	SOUND SIGNAL CENTER SPEAKER (-)
31	BR	SOUND SIGNAL FRONT DOOR SPEAKER RH (+)
32	Y	SOUND SIGNAL FRONT DOOR SPEAKER RH (-)
33	W/R	SOUND SIGNAL FRONT RH (+)
34	B/R	SOUND SIGNAL FRONT LH (+)
35	W/R	SOUND SIGNAL FRONT LH (-)
36	B/R	SOUND SIGNAL FRONT LH (-)

Connector No.	B226
Connector Name	WIRE TO WIRE
Connector Type	NS12MFR-CS

Terminal No.	Color of Wire	Signal Name [Specification]
1	V	-
2	BR	-
3	W	-
4	V	-
5	SB	-
8	P	-
7	Y	-
8	B	-
9	L	-
10	P	-
11	LG	-

1	2	3	4	5
6	7	8	9	10
11	12			

12	GR	-
----	----	---

Connector No.	B471
Connector Name	TEL ADAPTER UNIT
Connector Type	GT1BC-1S-HU

Terminal No.	Color of Wire	Signal Name [Specification]
33	-	TEL ANTENNA
34	SHIELD	SHIELD

33	34
----	----

Connector No.	B482
Connector Name	SATELLITE RADIO TUNER
Connector Type	FAKRA

Terminal No.	Color of Wire	Signal Name [Specification]
33	-	SATELLITE ANTENNA

33	34
----	----

Connector No.	B485
Connector Name	ANTENNA BASE (SATELLITE ANTENNA) (WITH BOSE SYSTEM WITHOUT NAVIGATION SYSTEM)
Connector Type	GT1BC-1PP-HU

Terminal No.	Color of Wire	Signal Name [Specification]
1	-	SATELLITE ANTENNA

1	2
---	---

Connector No.	D15
Connector Name	FRONT DOOR SPEAKER LH (WITH BOSE SYSTEM)
Connector Type	NS02FBR-CS

Terminal No.	Color of Wire	Signal Name [Specification]
1	L	-[Type A]
1	W	-[Type B]
2	B/W	-[Type A]
2	B	-[Type B]

2	1
---	---

JCNWM1862GI

A
B
C
D
E
F
G
H
I
J
K
L
M
O
P

AV

SATELLITE RADIO TUNER

[BOSE AUDIO WITHOUT NAVIGATION]

< ECU DIAGNOSIS >

BOSE AUDIO WITHOUT NAVIGATION WITHOUT DVD ENTERTAINMENT SYSTEM

Connector No.	D81
Connector Name	WIRE TO WIRE
Connector Type	TK10MW-NS8



Terminal No.	Color of Wire	Signal Name [Specification]
4	L	-
5	W	-

Connector No.	D53
Connector Name	FRONT DOOR SPEAKER RH (WITH BOSE SYSTEM)
Connector Type	NS02FBR-CS



Terminal No.	Color of Wire	Signal Name [Specification]
1	BR	-[Type A]
2	W	-[Type B]

Connector No.	D41
Connector Name	WIRE TO WIRE
Connector Type	TH40FW-CS15

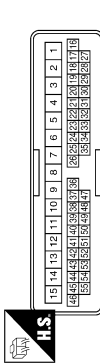

Terminal No.	Color of Wire	Signal Name [Specification]
4	B/R	-[Type A]
4	B	-[Type B]
5	BR	-[Type A]
5	W	-[Type B]

Connector No.	D21
Connector Name	WIRE TO WIRE
Connector Type	TH40FW-CS15

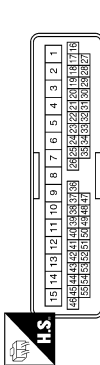

Terminal No.	Color of Wire	Signal Name [Specification]
4	B/W	-[Type A]
4	B	-[Type B]
5	L	-[Type A]
5	W	-[Type B]

Connector No.	D182
Connector Name	WIRE TO WIRE
Connector Type	TK12ZFV

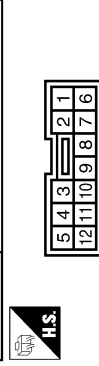

Terminal No.	Color of Wire	Signal Name [Specification]
6	R	-
7	G	-
8	B	-
9	SHIELD	-

Connector No.	D155
Connector Name	WIRE TO WIRE
Connector Type	TK10MW-NS8

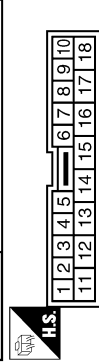

Terminal No.	Color of Wire	Signal Name [Specification]
4	O	-[Type A]
4	L	-[Type B]
5	B/P	-[Type A]
5	W	-[Type B]

Connector No.	D106
Connector Name	REAR DOOR SPEAKER RH (WITH BOSE SYSTEM)
Connector Type	NS02FBR-CS

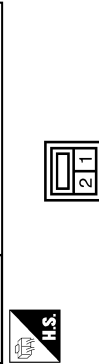

Terminal No.	Color of Wire	Signal Name [Specification]
1	O	-[Type A]
1	L	-[Type B]
2	B/P	-[Type A]
2	W	-[Type B]

Connector No.	D86
Connector Name	REAR DOOR SPEAKER LH (WITH BOSE SYSTEM)
Connector Type	NS02FBR-CS

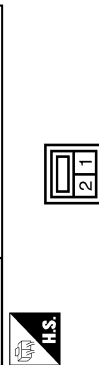

Terminal No.	Color of Wire	Signal Name [Specification]
1	L	-
2	W	-

JCNWM1863GI

SATELLITE RADIO TUNER

[BOSE AUDIO WITHOUT NAVIGATION]

< ECU DIAGNOSIS >

BOSE AUDIO WITHOUT NAVIGATION WITHOUT DVD ENTERTAINMENT SYSTEM

Connector No.	D132
Connector Name	REAR VIEW CAMERA
Connector Type	TH40MW-NH



H.S.

Terminal No.	Color of Wire	Signal Name [Specification]
1	R	CAMERA ON SIGNAL
2	G	GND
3	B	CAMERA IMAGE SIGNAL
4	SHIELD	SHIELD

Connector No.	E6
Connector Name	WIRE TO WIRE
Connector Type	TK18MGY-1V

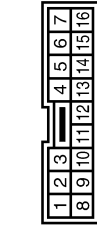

H.S.

Terminal No.	Color of Wire	Signal Name [Specification]
4	R	-

Connector No.	E16
Connector Name	ECM
Connector Type	RI24FB-R2B-L-LH

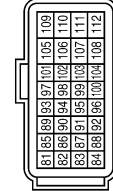

H.S.

Terminal No.	Color of Wire	Signal Name [Specification]
97	P	VEHCAN-L
98	L	VEHCAN-H

Connector No.	E18
Connector Name	BACK-UP LAMP RELAY
Connector Type	MS22FL-M2-LC

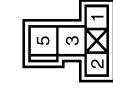

H.S.

Terminal No.	Color of Wire	Signal Name [Specification]
1	LG	-
2	R	-
3	LG	-
5	R	-

Connector No.	E27
Connector Name	PARKING BRAKE SWITCH
Connector Type	P01FE-A



H.S.

Terminal No.	Color of Wire	Signal Name [Specification]
1	P	-

Connector No.	E104
Connector Name	WIRE TO WIRE
Connector Type	NS16FW-CS

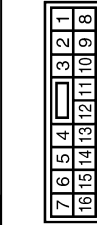

H.S.

Terminal No.	Color of Wire	Signal Name [Specification]
4	R	-
5	L	-
6	P	-
7	L	-

Connector No.	E105
Connector Name	WIRE TO WIRE
Connector Type	TH70MW-CS10-M3

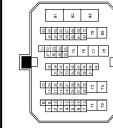

H.S.

Terminal No.	Color of Wire	Signal Name [Specification]
5	LG	-
22	P	-
47	P	-
48	L	-
75	BR	-
76	GR	-
78	V	-

Connector No.	F23
Connector Name	TOM (TRANSMISSION CONTROL MODULE)
Connector Type	RH40FB-R2B-L-RH

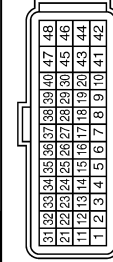

H.S.

Terminal No.	Color of Wire	Signal Name [Specification]
19	G/B	REV LAMP RELAY

JCNWM1864GI

A
B
C
D
E
F
G
H
I
J
K
L
M
N
O
P

AV

SATELLITE RADIO TUNER

[BOSE AUDIO WITHOUT NAVIGATION]

< ECU DIAGNOSIS >

BOSE AUDIO WITHOUT NAVIGATION WITHOUT DVD ENTERTAINMENT SYSTEM

Connector No.	F123
Connector Name	WIRE TO WIRE
Connector Type	TK16GY-IV

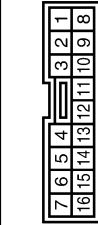

Terminal No.	Color of Wire	Signal Name [Specification]
4	G/B	-

Connector No.	M1
Connector Name	FUSE BLOCK (J/B)
Connector Type	NS0FW-M2

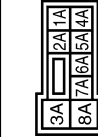

Terminal No.	Color of Wire	Signal Name [Specification]
2A	G	-
5A	R	-

Connector No.	M3
Connector Name	FUSE BLOCK (J/B)
Connector Type	NS12FW-CS

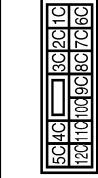

Terminal No.	Color of Wire	Signal Name [Specification]
12C	O	-

Connector No.	M4
Connector Name	DATA LINK CONNECTOR
Connector Type	BD16FW

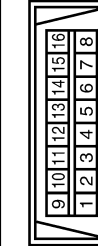

Terminal No.	Color of Wire	Signal Name [Specification]
6	L	-
14	P	-

Connector No.	M11
Connector Name	WIRE TO WIRE
Connector Type	TH10FW-CS10-M3

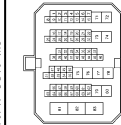

Terminal No.	Color of Wire	Signal Name [Specification]
5	O	-
22	G	-
47	P	-
48	L	-
75	BR	-
76	R	-
78	Y	-

Connector No.	M18
Connector Name	WIRE TO WIRE
Connector Type	TH40MW-CS15

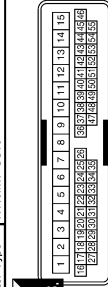

Terminal No.	Color of Wire	Signal Name [Specification]
4	W	-
5	BR	- [Type A and without BOSE system type B]
5	B	- [With BOSE system type B]

Connector No.	M20
Connector Name	WIRE TO WIRE
Connector Type	TH40MW-CS15

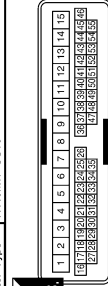

Terminal No.	Color of Wire	Signal Name [Specification]
4	B	-
5	L	-

SATELLITE RADIO TUNER

[BOSE AUDIO WITHOUT NAVIGATION]

< ECU DIAGNOSIS >

BOSE AUDIO WITHOUT NAVIGATION WITHOUT DVD ENTERTAINMENT SYSTEM

Connector No.	M22
Connector Name	WIRE TO WIRE
Connector Type	TH12FW-NH

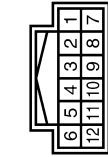

Terminal No.	Color of Wire	Signal Name [Specification]
1	V	-
2	R	-
3	R	-
4	G	-
5	W	-
6	SHIELD	-
7	LG	-
8	SHIELD	-
9	BR	-
10	SHIELD	-
11	L	-

Connector No.	M33
Connector Name	COMBINATION SWITCH (SPIRAL CABLE)
Connector Type	TK08FGY-IV



Terminal No.	Color of Wire	Signal Name [Specification]
24	BR	- [With audio steering switch and telephone]
31	G	- [With audio steering switch and telephone]
33	L	- [With audio steering switch and telephone]

12	R	-
----	---	---

Connector No.	M23
Connector Name	WIRE TO WIRE
Connector Type	TH1BMW-NH

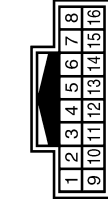

Terminal No.	Color of Wire	Signal Name [Specification]
1	W	-
2	R	- [With telephone without navigation system]
3	B	-
4	SHIELD	-

Connector No.	M34
Connector Name	COMBINATION METER
Connector Type	TH40FW-NH

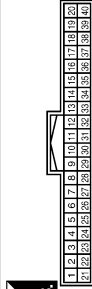

Terminal No.	Color of Wire	Signal Name [Specification]
21	L	CAN-H
22	P	CAN-L
31	V	VEHICLE SPEED (8-PULSE)

Connector No.	M30
Connector Name	STEERING ANGLE SENSOR
Connector Type	TH08FW-NH

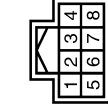

Terminal No.	Color of Wire	Signal Name [Specification]
1	B	-
3	L	-
4	G	-
6	SB	-
8	O	-

Connector No.	M44
Connector Name	WIRE TO WIRE
Connector Type	TH32FW-NH

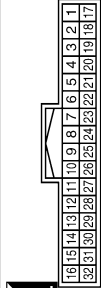

Terminal No.	Color of Wire	Signal Name [Specification]
1	G	-
2	R	-
3	SHIELD	-
4	B	-
5	W	-
6	SHIELD	-
7	O	- [Type A]
7	L	- [Type B]
8	SB	- [Type A]
8	R	- [Type B]
9	SHIELD	-

A
B
C
D
E
F
G
H
I
J
K
L
M
N
O
P

AV

JCNWM1866GI

SATELLITE RADIO TUNER

[BOSE AUDIO WITHOUT NAVIGATION]

< ECU DIAGNOSIS >

BOSE AUDIO WITHOUT NAVIGATION WITHOUT DVD ENTERTAINMENT SYSTEM

Connector No.	M49
Connector Name	FRONT DISPLAY UNIT
Connector Type	TH24FW-NH

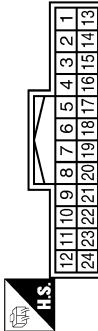

Terminal No.	Color of Wire	Signal Name [Specification]
1	B	GND
2	Y	INVERTER VCC1[Without navigation system]
3	O	SIGNAL VCC1[Without navigation system]
4	P	COMPOSITE IMAGE GND[Without navigation system]
5	SHIELD	SHIELD[Without navigation system]
6	L	RGB (GREEN) SIGNAL [Without navigation system]
7	SHIELD	SHIELD
8	G	HP[Without navigation system]
9	W	RGB AREA (YS) SIGNAL
11	R	COMM (CONT->DISP)
13	BR	INVERTER GND[Without navigation system]

Connector No.	M67
Connector Name	FRONT SQUAWKER RH
Connector Type	TK02FBR



Terminal No.	Color of Wire	Signal Name [Specification]
1	BR	-
2	R	-[With BOSE system]

14	LG	SIGNAL GND[Without navigation system]
15	L	COMPOSITE IMAGE SIGNAL [Without navigation system]
17	G	RGB (RED) SIGNAL
18	Y	RGB (BLUE) SIGNAL [Without navigation system]
19	B	RGB SYNC
20	R	VP
21	SHIELD	SHIELD
22	G	COMM (DISP->CONT)
23	SHIELD	SHIELD

Terminal No.	Color of Wire	Signal Name [Specification]
1	LG	-[With BOSE system]
2	Y	-[With BOSE system]

Terminal No.	Color of Wire	Signal Name [Specification]
43	L	-
44	V	-
45	P	-
46	R	-
47	Y	-
48	L	-
49	G	-
50	SHIELD	-
51	W	-
56	P	-
57	L	-
58	SB	-
59	SHIELD	-
60	B	-
61	R	-
62	W	-
66	L	-
67	R	-
68	G	-
69	SHIELD	-
70	L	-
71	R	-

Connector No.	M77
Connector Name	WIRE TO WIRE
Connector Type	TH80FW-CS19

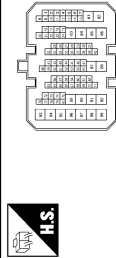

Terminal No.	Color of Wire	Signal Name [Specification]
1	SHIELD	-
2	B	-
3	W	-
4	R	-
8	SHIELD	-
9	W	-
10	R	-
11	G	-
12	B	-
41	O	-
42	SB	-

Connector No.	M65
Connector Name	CENTER SPEAKER
Connector Type	TK02FBR



Terminal No.	Color of Wire	Signal Name [Specification]
1	P	-
2	O	-

Connector No.	M97
Connector Name	WIRE TO WIRE
Connector Type	TH18FW-CS2

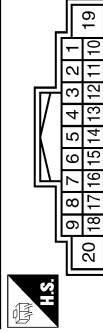

Terminal No.	Color of Wire	Signal Name [Specification]
5	SHIELD	-
6	W	-
8	B	-
9	Y	-
14	R	-
15	B	-
17	SHIELD	-
18	B	-[Type A and With navigation system type B]
18	BR	-[Without navigation system type B]

SATELLITE RADIO TUNER

[BOSE AUDIO WITHOUT NAVIGATION]

< ECU DIAGNOSIS >

BOSE AUDIO WITHOUT NAVIGATION WITHOUT DVD ENTERTAINMENT SYSTEM

Connector No.	M122
Connector Name	BCM (BODY CONTROL MODULE)
Connector Type	TH40FB-NH

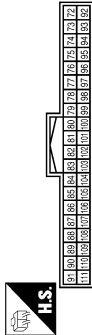

Terminal No.	Color of Wire	Signal Name [Specification]
90	P	CAN-L
91	L	CAN-H

Connector No.	M124
Connector Name	WIRE TO WIRE
Connector Type	NS12FER-CS



Terminal No.	Color of Wire	Signal Name [Specification]
1	P	-
2	BR	- [Type A]
3	B	- [Type B]
4	L	-
5	Y	-
6	BR	-
7	O	-
8	W	-
9	B	-
10	BR	-

Connector No.	M127
Connector Name	AV CONTROL UNIT (WITH BOSE SYSTEM WITHOUT NAVIGATION SYSTEM)
Connector Type	TH18FW-CS2



Terminal No.	Color of Wire	Signal Name [Specification]
6	BR	STRG SW A
7	R	ACC
9	R	ILLUMINATION
15	L	STRG SW GND
16	G	STRG SW B
19	Y	BATTERY
20	B	GND

Connector No.	M128
Connector Name	AV CONTROL UNIT (WITH BOSE SYSTEM WITHOUT NAVIGATION SYSTEM)
Connector Type	A12FW

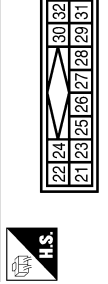

Terminal No.	Color of Wire	Signal Name [Specification]
21	B	SATELLITE RADIO SOUND SIGNAL LH (-)
22	G	SATELLITE RADIO SOUND SIGNAL LH (+)
23	R	SATELLITE RADIO SOUND SIGNAL RH (-)
24	W	SATELLITE RADIO SOUND SIGNAL RH (+)
25	SHIELD	SHIELD
26	SHIELD	SHIELD
28	R	REQUEST (SAT->CONT)
29	W	COMM (SAT->CONT)
30	B	COMM (CONT->SAT)

11	LG
12	R

Connector No.	M125
Connector Name	MULTIFUNCTION SWITCH
Connector Type	TH18FW-NH

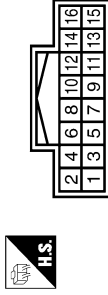

Terminal No.	Color of Wire	Signal Name [Specification]
1	B	GND
3	R	ACC
6	R	AV COMM (H)
8	L	AV COMM (L)
9	V	SW GND
14	W	EJECT SIGNAL

Connector No.	M129
Connector Name	AV CONTROL UNIT (WITH BOSE SYSTEM WITHOUT NAVIGATION SYSTEM)
Connector Type	TH24FW-NH

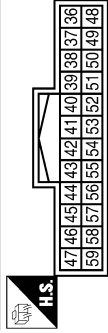

Terminal No.	Color of Wire	Signal Name [Specification]
36	L	COMPOSITE IMAGE SIGNAL
37	P	COMPOSITE IMAGE GND
38	Y	RGB (B/BLUE) SIGNAL
39	L	RGB (G/GREEN) SIGNAL
40	G	RGB (R/RED) SIGNAL
41	B	RGB SYNC
42	SHIELD	SHIELD
43	W	RGB AREA (YS) SIGNAL
44	G	COMM (DISP->CONT)
45	G	HP
46	LG	SIGNAL GND

A
B
C
D
E
F
G
H
I
J
K
L
M
N
O
P

AV

JCNWM1868GI

SATELLITE RADIO TUNER

[BOSE AUDIO WITHOUT NAVIGATION]

< ECU DIAGNOSIS >

BOSE AUDIO WITHOUT NAVIGATION WITHOUT DVD ENTERTAINMENT SYSTEM

Connector No.	M130
Connector Name	AV CONTROL UNIT (WITH BOSE SYSTEM WITHOUT NAVIGATION SYSTEM)
Connector Type	TH16FW-NH

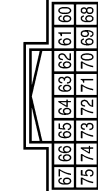

Terminal No.	Color of Wire	Signal Name [Specification]
64	SHIELD	SHIELD
65	W	CAMERA IMAGE SIGNAL
66	Y	AUX IMAGE SIGNAL [Without DVD player]
68	P	CONNECTION RECOGNITION
73	SHIELD	SHIELD [Without DVD player]
74	B	AUX IMAGE GND [Without DVD player (type A)]
74	BR	AUX IMAGE GND [Without DVD player (type B)]

Connector No.	M132
Connector Name	AV CONTROL UNIT (WITH BOSE SYSTEM WITHOUT NAVIGATION SYSTEM)
Connector Type	TH12FW-NH

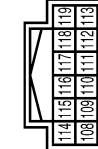

Terminal No.	Color of Wire	Signal Name [Specification]
108	V	SOUND SIGNAL REAR RH (+)
109	B	SOUND SIGNAL FRONT RH (+)
110	P	AMP ON SIGNAL
111	SHIELD	SHIELD
112	O	SOUND SIGNAL REAR LH (+) [Type A]
112	L	SOUND SIGNAL REAR LH (+) [Type B]
113	G	SOUND SIGNAL FRONT LH (+)
114	LG	SOUND SIGNAL REAR RH (-)
115	W	SOUND SIGNAL FRONT RH (-)
118	SB	SOUND SIGNAL REAR LH (-) [Type A]
118	R	SOUND SIGNAL REAR LH (-) [Type B]

Connector No.	M131
Connector Name	AV CONTROL UNIT (WITH BOSE SYSTEM WITH NAVIGATION SYSTEM)
Connector Type	TH24FW-NH

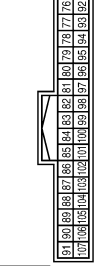

Terminal No.	Color of Wire	Signal Name [Specification]
79	L	TEL VOICE SIGNAL (-)
80	R	TEL VOICE SIGNAL (+)
81	SHIELD	SHIELD
82	W	iPod SOUND SIGNAL RH (-) [Without DVD player]
83	R	iPod SOUND SIGNAL RH (+) [Without DVD player]
85	B	GND
86	L	CAN-H
87	P	CAN-L
88	R	AV COMM (H)
89	L	AV COMM (L)
90	G	AV COMM (H)

Terminal No.	119	R	SOUND SIGNAL FRONT LH (-)
--------------	-----	---	---------------------------

91	L	AV COMM (L)
95	R	AUX SOUND SIGNAL RH (+)
96	B	AUX SOUND SIGNAL LH (+)
97	W	AUX SOUND SIGNAL GND
98	L	iPod SOUND SIGNAL LH (-) [Without DVD player]
99	BR	iPod SOUND SIGNAL LH (+) [Without DVD player]
100	SHIELD	SHIELD [Without DVD player]
101	V	SW GND
103	W	EJECT SIGNAL
104	G	IGNITION
105	SB	REVERSE
106	G	PARKING BRAKE
107	V	VEHICLE SPEED (8-PULSE)

Connector No.	M148
Connector Name	iPod ADAPTER
Connector Type	TH24FW-NH

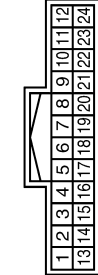

Terminal No.	Color of Wire	Signal Name [Specification]
1	BR	iPod SOUND SIGNAL LH (+)
2	R	iPod SOUND SIGNAL RH (+)
3	R	ACC
4	L	AV COMM (L)
5	Y	BATTERY
8	W	CHARGE POWER
9	G	COMM (iPod->iPod ADAPTER)
10	R	COMM (iPod->iPod ADAPTER)
11	R	ACCESSORY IDENTIFY
12	V	iPod SOUND SIGNAL RH (+)
13	L	iPod SOUND SIGNAL LH (-)

14	W	iPod SOUND SIGNAL RH (-)
15	SHIELD	SHIELD
16	R	AV COMM (H)
17	SHIELD	GND
19	SHIELD	SHIELD
21	L	iPod CONNECTION RECOGNITION
22	BR	ACCESSORY DETECT
23	R	iPod SOUND SIGNAL GND
24	LG	iPod SOUND SIGNAL LH (+)

JCNWM1869GI

SATELLITE RADIO TUNER

[BOSE AUDIO WITHOUT NAVIGATION]

< ECU DIAGNOSIS >

BOSE AUDIO WITHOUT NAVIGATION WITHOUT DVD ENTERTAINMENT SYSTEM

Connector No.	M253
Connector Name	AUXILIARY INPUT JACKS
Connector Type	A08FW



Terminal No.	Color of Wire	Signal Name [Specification]
1	R	SOUND SIGNAL RH (+)
2	W	SOUND SIGNAL GND
3	B	SOUND SIGNAL LH (-) [Without DVD player]
7	G	AUX IMAGE SIGNAL
8	R	AUX IMAGE GND [Without DVD player]

Connector No.	M251
Connector Name	WIRE TO WIRE
Connector Type	TH1BMW-CS2



Terminal No.	Color of Wire	Signal Name [Specification]
5	SHIELD	-
6	W	-
8	SHIELD	-
9	G	-
14	R	-
15	B	-
17	SHIELD	-
18	R	-

12	R	-
----	---	---

Connector No.	M204
Connector Name	WIRE TO WIRE
Connector Type	TH12MW-NH



Terminal No.	Color of Wire	Signal Name [Specification]
1	V	-
2	R	-
3	R	-
4	G	-
5	W	-
6	SHIELD	-
7	LG	-
8	SHIELD	-
9	BR	-
10	SHIELD	-
11	L	-

Connector No.	M275
Connector Name	WIRE TO WIRE
Connector Type	GT13SH-2/1S-HU



Terminal No.	Color of Wire	Signal Name [Specification]
1	-	-
2	-	-
3	-	-

Connector No.	M370
Connector Name	AV CONTROL UNIT (WITH BOSE SYSTEM WITHOUT NAVIGATION SYSTEM)
Connector Type	GT135C-2/1S-HU



Terminal No.	Color of Wire	Signal Name [Specification]
33	-	FM SUB
34	-	AM-FM MAIN
35	-	ANTENNA AMP. ON SIGNAL

Connector No.	M303
Connector Name	COMBINATION SWITCH (SPIRAL CABLE)
Connector Type	TK08FGY



Terminal No.	Color of Wire	Signal Name [Specification]
14	-	-
15	-	-
17	-	-

Connector No.	M260
Connector Name	iPod SIDE
Connector Type	IP18FGY



Terminal No.	Color of Wire	Signal Name [Specification]
1	LG	iPod SOUND SIGNAL LH (+)
2	R	iPod SOUND SIGNAL GND
5	R	COMM (iPod->iPod ADAPTER)
6	G	COMM (iPod ADAPTER->iPod)
7	V	iPod SOUND SIGNAL RH (+)
9	L	iPod CONNECTION RECOGNITION GND
10	SHIELD	CHARGE POWER
12	W	SHIELD
14	SHIELD	ACCESSORY DETECT
15	BR	ACCESSORY DETECT
16	R	ACCESSORY IDENTITY

JCNWM1870GI

A
B
C
D
E
F
G
H
I
J
K
L
M
N
O
P

AV

SATELLITE RADIO TUNER

[BOSE AUDIO WITHOUT NAVIGATION]

< ECU DIAGNOSIS >

BOSE AUDIO WITHOUT NAVIGATION WITHOUT DVD ENTERTAINMENT SYSTEM

Connector No.	M376
Connector Name	WIRE TO WIRE
Connector Type	GT13SCN-2/1PP-HU

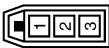

Terminal No.	Color of Wire	Signal Name [Specification]
1	-	-
2	-	-
3	-	-

Connector No.	M378
Connector Name	ANTENNA BASE (ANTENNA AMP.)
Connector Type	GT13SSN-1/1PP-HU

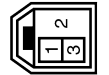

Terminal No.	Color of Wire	Signal Name [Specification]
1	-	-
3	-	-

Connector No.	M379
Connector Name	GLASS ANTENNA
Connector Type	GT13SSN-1/1PP-HU



Terminal No.	Color of Wire	Signal Name [Specification]
2	-	FM SUB

Connector No.	R1
Connector Name	WIRE TO WIRE
Connector Type	TH16FW-NH

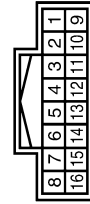

Terminal No.	Color of Wire	Signal Name [Specification]
1	R/W	-
2	R/L	- [With telephones without navigation system]
3	B	-
4	SHIELD	-

Connector No.	R20
Connector Name	MICROPHONE
Connector Type	TK04FW



Terminal No.	Color of Wire	Signal Name [Specification]
1	R/W	MICROPHONE SIGNAL (+)
2	R/L	MICROPHONE SIGNAL (-) [With telephones without navigation system]
4	B	MICROPHONE POWER

JCNWM1871GI

Wiring Diagram - BOSE AUDIO WITHOUT NAVIGATION WITH DVD ENTERTAINMENT SYSTEM -

INFOID:000000003702916

NOTE:

SATELLITE RADIO TUNER

[BOSE AUDIO WITHOUT NAVIGATION]

< ECU DIAGNOSIS >

In this section, PRESET SWITCH and MULTIFUNCTION SWITCH are written as the MULTIFUNCTION SWITCH.

BOSE AUDIO WITHOUT NAVIGATION WITH DVD ENTERTAINMENT SYSTEM

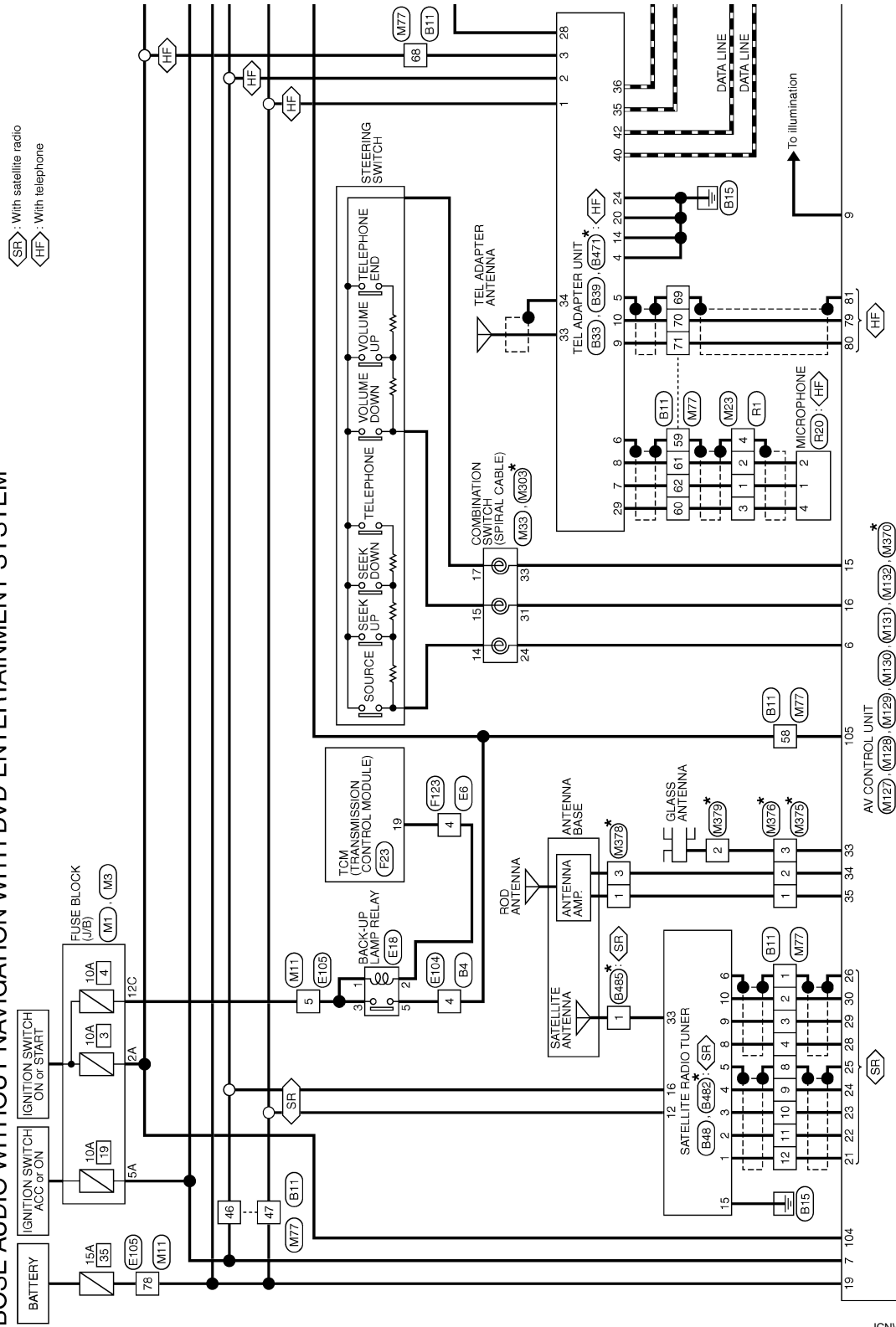

*: This connector is not shown in "Harness layout".

2008/09/23

JCNWM1872GI

A
B
C
D
E
F
G
H
I
J
K
L
M
N
O
P

AV

SATELLITE RADIO TUNER

[BOSE AUDIO WITHOUT NAVIGATION]

< ECU DIAGNOSIS >

- WI: With iPod
- HF: With telephone
- OF: Without telephone

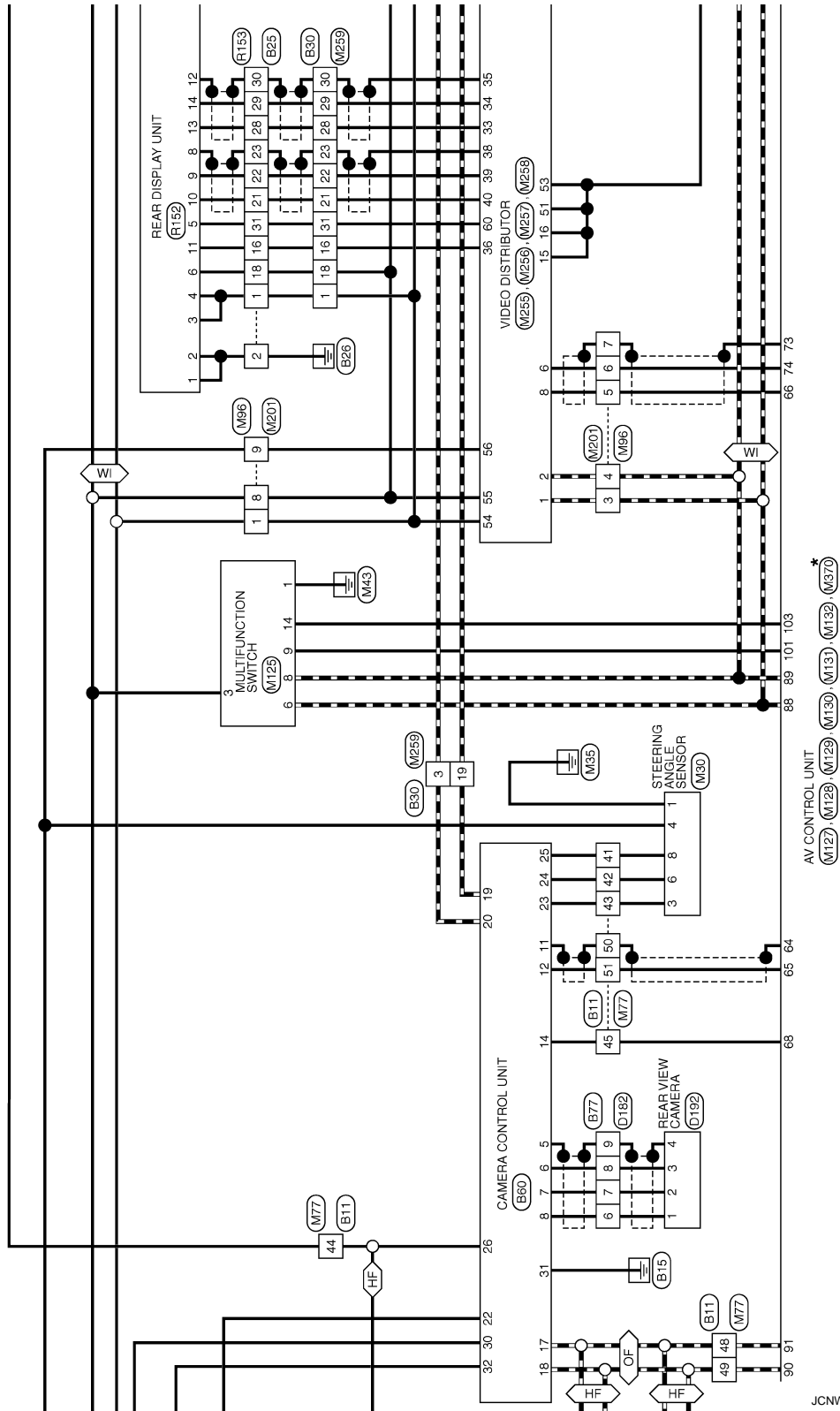

*: This connector is not shown in "Harness Layout".

JCNWM1873GI

SATELLITE RADIO TUNER

[BOSE AUDIO WITHOUT NAVIGATION]

< ECU DIAGNOSIS >

WI: With iPod

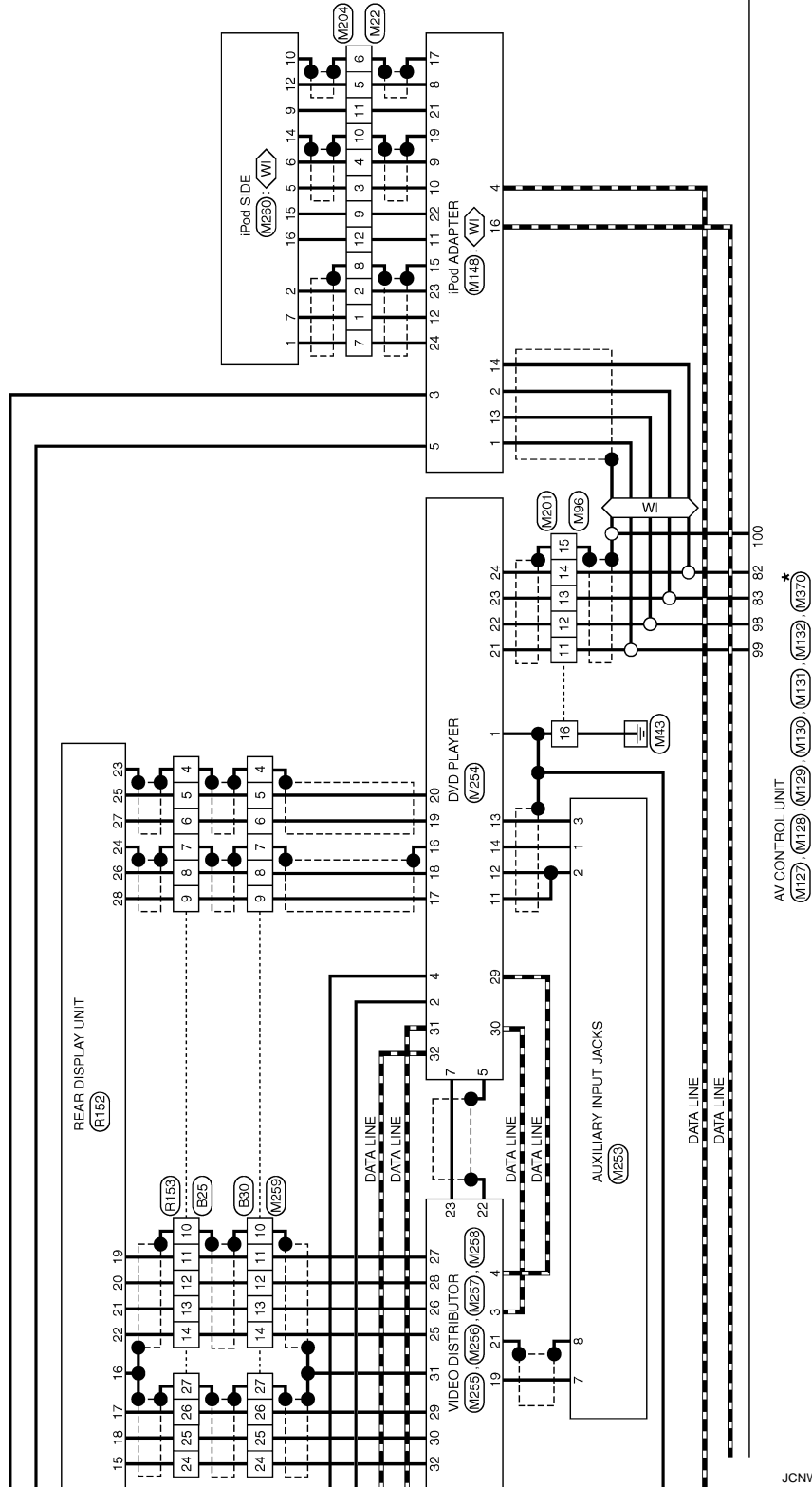

*: This connector is not shown in "Harness Layout".

JCNWM1874GI

A
B
C
D
E
F
G
H
I
J
K
L
M
N
O
P

AV

SATELLITE RADIO TUNER

[BOSE AUDIO WITHOUT NAVIGATION]

< ECU DIAGNOSIS >

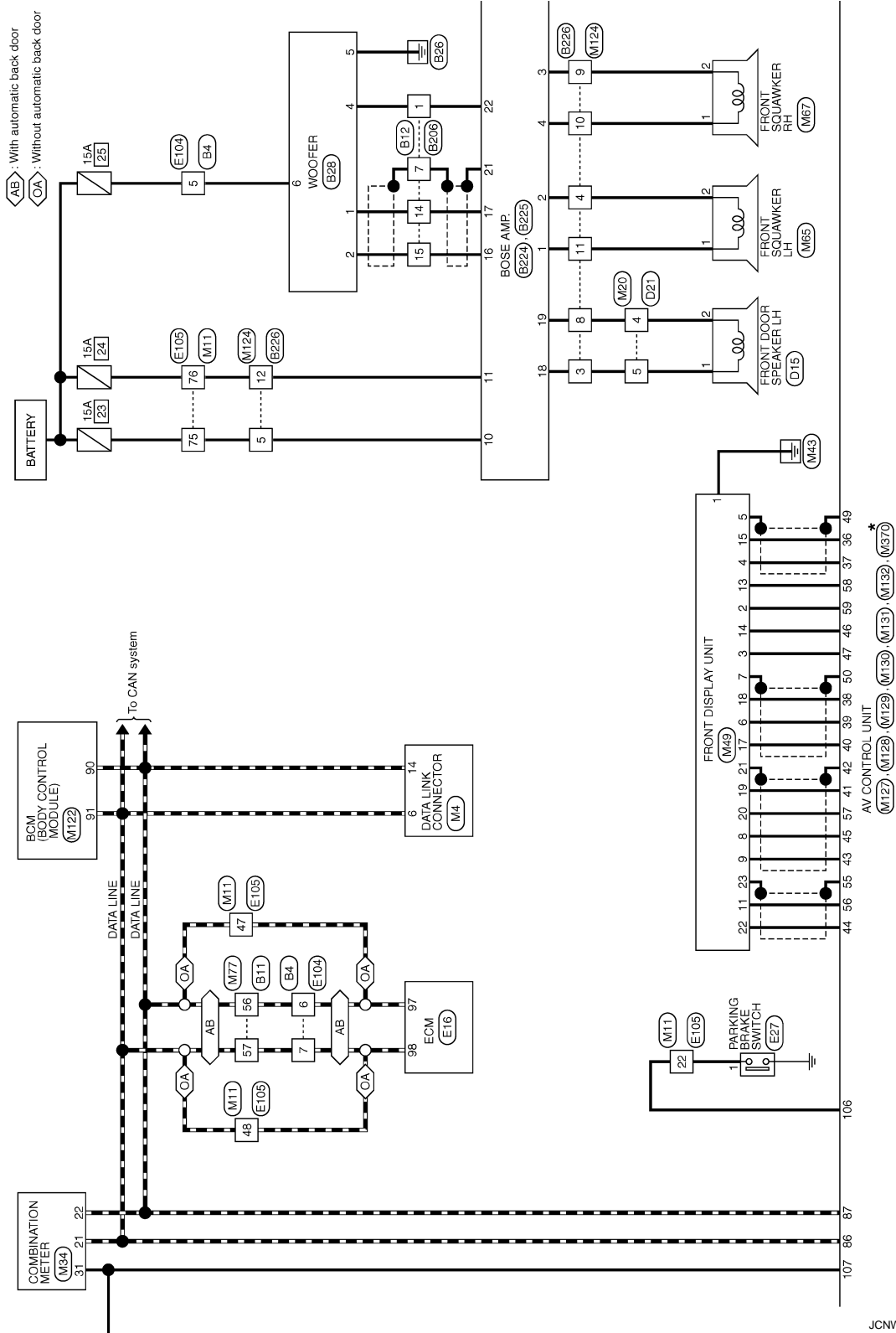

JCNWM1875GI

SATELLITE RADIO TUNER

[BOSE AUDIO WITHOUT NAVIGATION]

< ECU DIAGNOSIS >

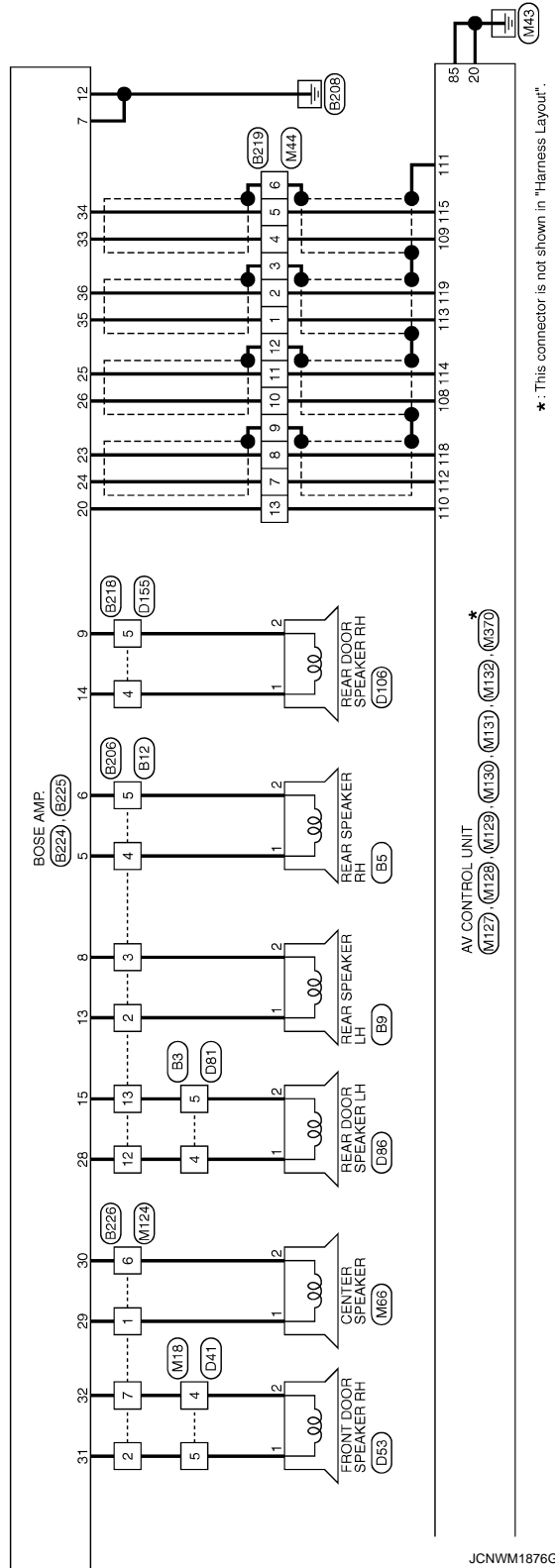

*: This connector is not shown in "Harness Layout".

JCNWM1876GI

A
B
C
D
E
F
G
H
I
J
K
L
M
N
O
P

AV

SATELLITE RADIO TUNER

[BOSE AUDIO WITHOUT NAVIGATION]

< ECU DIAGNOSIS >

BOSE AUDIO WITHOUT NAVIGATION WITH DVD ENTERTAINMENT SYSTEM

Connector No.	B3
Connector Name	WIRE TO WIRE
Connector Type	TK10FW-NS8



Terminal No.	Color of Wire	Signal Name [Specification]
4	LG	-
5	O	-

Connector No.	B4
Connector Name	WIRE TO WIRE
Connector Type	NS16MW-CS



Terminal No.	Color of Wire	Signal Name [Specification]
4	R	-
5	O	-
6	P	-
7	L	-

Connector No.	B5
Connector Name	REAR SPEAKER RH
Connector Type	TK02FBR



Terminal No.	Color of Wire	Signal Name [Specification]
1	V	-
2	LG	-

Connector No.	B9
Connector Name	REAR SPEAKER LH
Connector Type	TK02FBR



Terminal No.	Color of Wire	Signal Name [Specification]
1	SB	-
2	GR	-

Connector No.	B11
Connector Name	WIRE TO WIRE
Connector Type	TH80MW-CS19

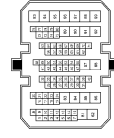

Terminal No.	Color of Wire	Signal Name [Specification]
1	SHIELD	-
2	B	-
3	R/L	-
4	R/W	-
8	SHIELD	-
9	BR/L	-
10	Y/G	-
11	Y/L	-
12	W/L	-
41	O	-
42	SB	-

43	G	-
44	BR	-
45	L	-
46	GR	-
47	V	-
48	GR	- [With rear view camera and telephone]
48	BR	- [With rear view camera without telephone]
49	Y	-
50	SHIELD	-
51	B	-
56	P	-
57	L	-
58	R	-
59	SHIELD	-
60	B	-
61	R/L	-
62	R/W	-
68	R	-
69	SHIELD	-
70	W/R	-
71	B/R	-

Connector No.	B12
Connector Name	WIRE TO WIRE
Connector Type	NS16FW-CS

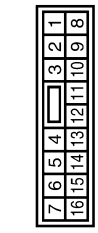

Terminal No.	Color of Wire	Signal Name [Specification]
1	W	-
2	SB	-
3	GR	-
4	V	-
5	LG	-
7	SHIELD	-
12	LG	-
13	O	-
14	W/R	-
15	B/R	-

SATELLITE RADIO TUNER

[BOSE AUDIO WITHOUT NAVIGATION]

< ECU DIAGNOSIS >

BOSE AUDIO WITHOUT NAVIGATION WITH DVD ENTERTAINMENT SYSTEM

Connector No.	B25
Connector Name	WIRE TO WIRE
Connector Type	TH22MW-NH



1	2	3	4	5	6	7	8	9	10	11	12	13	14	15	16
17	18	19	20	21	22	23	24	25	26	27	28	29	30	31	32

Terminal No.	Color of Wire	Signal Name [Specification]
1	SB	-
2	B	-
4	SHIELD	-
5	W/R	-
6	W/L	-
7	SHIELD	-
8	GR/V	-
9	W/L	-
10	SHIELD	-
11	W/L	-
12	Y/G	-

Connector No.	B30
Connector Name	WIRE TO WIRE
Connector Type	TH22FW-NH



16	15	14	13	12	11	10	9	8	7	6	5	4	3	2	1
32	31	30	29	28	27	26	25	24	23	22	21	20	19	18	17

Terminal No.	Color of Wire	Signal Name [Specification]
1	SB	-
3	G	-
4	SHIELD	-
5	W/R	-
6	W/L	-
7	SHIELD	-
8	GR/V	-
9	W/L	-
10	SHIELD	-
11	W/L	-
12	Y/G	-

13	Y/L	-
14	BR/L	-
16	V	-
18	O	-
21	B/R	-
22	W/R	-
23	SHIELD	-
24	B	-
25	R/L	-
26	R/W	-
27	SHIELD	-
28	B	-
29	W	-
30	SHIELD	-
31	P	-

Connector No.	B28
Connector Name	WOOFER
Connector Type	RS28FGY-PR



2	4	6
1	3	5

Terminal No.	Color of Wire	Signal Name [Specification]
1	W/R	SOUND SIGNAL WOOFER (-)
2	B/R	SOUND SIGNAL WOOFER (+)
4	W	WOOFER AMP ON SIGNAL
5	B/W	GND
6	O	BAT

Connector No.	B33
Connector Name	TEL ADAPTER UNIT
Connector Type	TH33FW-NH



35	37	39	41
36	38	40	42

Terminal No.	Color of Wire	Signal Name [Specification]
35	Y	AV COMM (H)
36	BR	AV COMM (L)
40	G	AV COMM (H)
42	GR	AV COMM (L)

JCNWM1878GI

A
B
C
D
E
F
G
H
I
J
K
L
M
N
O
P

AV

SATELLITE RADIO TUNER

[BOSE AUDIO WITHOUT NAVIGATION]

< ECU DIAGNOSIS >

BOSE AUDIO WITHOUT NAVIGATION WITH DVD ENTERTAINMENT SYSTEM

Connector No.	B39
Connector Name	TEL ADAPTER UNIT
Connector Type	TH22FW-NH

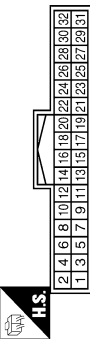

Terminal No.	Color of Wire	Signal Name [Specification]
1	V	BATTERY
2	GR	ACC
3	R	IGNITION
4	B/W	GND
5	SHIELD	SHIELD
6	SHIELD	SHIELD
7	R/W	MICROPHONE SIGNAL
8	R/L	MICROPHONE GND
9	B/R	TEL VOICE SIGNAL (+)
10	W/R	TEL VOICE SIGNAL (-)
14	B	GND

Connector No.	B80
Connector Name	CAMERA CONTROL UNIT
Connector Type	TH22FW-NH

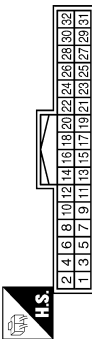

Terminal No.	Color of Wire	Signal Name [Specification]
5	SHIELD	SHIELD
6	B	CAMERA IMAGE SIGNAL
7	R/W	GND
8	R/L	CAMERA ON SIGNAL
11	SHIELD	SHIELD
12	B	CAMERA IMAGE SIGNAL
14	L	CONNECTION RECOGNITION
17	BR	AV COMM (L)
18	Y	AV COMM (H)
19	GR	AV COMM (L)
20	G	AV COMM (H)

20	B	CONTROL SIGNAL
24	B/W	CONTROL SIGNAL
28	BR	VEHICLE SPEED (8-PULSE)
29	B	MICROPHONE VCC



Terminal No.	Color of Wire	Signal Name [Specification]
1	W/L	SOUND SIGNAL LH (-)
2	Y/L	SOUND SIGNAL LH (+)
3	Y/G	SOUND SIGNAL RH (-)
4	BR/L	SOUND SIGNAL RH (+)
5	SHIELD	SHIELD
6	SHIELD	SHIELD
8	R/W	REQUEST (SAT->CONT)
9	R/L	COMM (SAT->CONT)
10	B	COMM (CONT->SAT)
12	V	BATTERY
15	B	GND

Connector No.	B77
Connector Name	WIRE TO WIRE
Connector Type	TK2MW

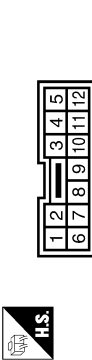

Terminal No.	Color of Wire	Signal Name [Specification]
6	R/L	-
7	R/W	-
8	B	-
9	SHIELD	-

16	GR	ACC
----	----	-----

Connector No.	B48
Connector Name	SATELLITE RADIO TUNER
Connector Type	A16FW



Connector No.	B206
Connector Name	WIRE TO WIRE
Connector Type	NS16MW-CS



Terminal No.	Color of Wire	Signal Name [Specification]
1	W	-
2	GR	-
3	BR	-
4	Y	-
5	BR	-
7	SHIELD	-
12	G	-
13	R	-
14	W/R	-
15	B/R	-

SATELLITE RADIO TUNER

[BOSE AUDIO WITHOUT NAVIGATION]

< ECU DIAGNOSIS >

BOSE AUDIO WITHOUT NAVIGATION WITH DVD ENTERTAINMENT SYSTEM

Connector No.	B218
Connector Name	WIRE TO WIRE
Connector Type	TK10FW-ANS



Connector No.	B219
Connector Name	WIRE TO WIRE
Connector Type	TH32MP-NH



Terminal No.	Color of Wire	Signal Name [Specification]
4	L	[With BOSE system]
5	O	[With BOSE system]

Terminal No.	Color of Wire	Signal Name [Specification]
1	W/R	
2	B/R	
3	SHIELD	
4	W/R	
5	B/R	
6	SHIELD	
7	GR/V	
8	W/L	
9	SHIELD	
10	GR/V	
11	W/L	

Connector No.	B224
Connector Name	BOSE AMP.
Connector Type	SGA12FBR-SJAZ

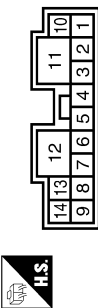

Connector No.	B225
Connector Name	BOSE AMP.
Connector Type	SCA19FBR-SGA4

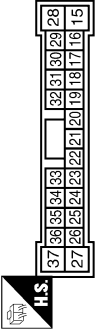

Terminal No.	Color of Wire	Signal Name [Specification]
1	LG	SOUND SIGNAL FRONT SQUAWKER LH (+)
2	V	SOUND SIGNAL FRONT SQUAWKER LH (-)
3	L	SOUND SIGNAL FRONT SQUAWKER RH (-)
4	P	SOUND SIGNAL FRONT SQUAWKER RH (+)
5	Y	SOUND SIGNAL REAR SPEAKER RH (+)
6	BR	SOUND SIGNAL REAR SPEAKER RH (-)
7	B	GND
8	BR	SOUND SIGNAL REAR SPEAKER LH (-)
9	O	SOUND SIGNAL REAR DOOR SPEAKER RH (-)
10	SB	BATTERY
11	GR	BATTERY

Terminal No.	Color of Wire	Signal Name [Specification]
15	R	SOUND SIGNAL REAR DOOR SPEAKER LH (-)
16	B/R	SOUND SIGNAL WOOFER (+)
17	W/R	SOUND SIGNAL WOOFER (-)
18	W	SOUND SIGNAL FRONT DOOR SPEAKER LH (-)
19	B	SOUND SIGNAL FRONT DOOR SPEAKER LH (+)
20	SB	AMP. ON SIGNAL
21	SHIELD	SHIELD
22	W	WOOFER AMP. ON SIGNAL
23	W/L	SOUND SIGNAL REAR LH (-)
24	GR/V	SOUND SIGNAL REAR LH (+)
25	W/L	SOUND SIGNAL REAR RH (-)

12	SHIELD
13	SB

26	GR/V	SOUND SIGNAL REAR RH (+)
28	G	SOUND SIGNAL REAR DOOR SPEAKER LH (+)
29	V	SOUND SIGNAL CENTER SPEAKER (+)
30	P	SOUND SIGNAL CENTER SPEAKER (-)
31	BR	SOUND SIGNAL FRONT DOOR SPEAKER RH (+)
32	Y	SOUND SIGNAL FRONT DOOR SPEAKER RH (-)
33	W/R	SOUND SIGNAL FRONT RH (+)
34	B/R	SOUND SIGNAL FRONT RH (-)
35	W/R	SOUND SIGNAL FRONT LH (-)
36	B/R	SOUND SIGNAL FRONT LH (+)

JCNWM1880G1

A
B
C
D
E
F
G
H
I
J
K
L
M
N
O
P

AV

SATELLITE RADIO TUNER

[BOSE AUDIO WITHOUT NAVIGATION]

< ECU DIAGNOSIS >

BOSE AUDIO WITHOUT NAVIGATION WITH DVD ENTERTAINMENT SYSTEM

Connector No.	B226
Connector Name	WIRE TO WIRE
Connector Type	NS2MBR-CS

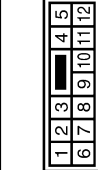

Terminal No.	Color of Wire	Signal Name [Specification]
1	V	
2	BR	
3	W	
4	V	
5	SB	
6	P	
7	Y	
8	B	
9	L	
10	P	
11	LG	

Connector No.	B465
Connector Name	ANTENNA BASE (SATELLITE ANTENNA) WITH BOSE SYSTEM WITHOUT NAVIGATION SYSTEM
Connector Type	GT16C-1PP-HU



Terminal No.	Color of Wire	Signal Name [Specification]
1	-	SATELLITE ANTENNA

12	GR	-
----	----	---

Connector No.	B471
Connector Name	TEL ADAPTER UNIT
Connector Type	GT16C-1S-HU



Terminal No.	Color of Wire	Signal Name [Specification]
33	-	TEL ANTENNA
34	SHIELD	SHIELD

Connector No.	D15
Connector Name	FRONT DOOR SPEAKER LH (WITH BOSE SYSTEM)
Connector Type	NS02FBR-CS



Terminal No.	Color of Wire	Signal Name [Specification]
1	L	-[Type A]
1	W	-[Type B]
2	B/W	-[Type A]
2	B	-[Type B]

Connector No.	B482
Connector Name	SATELLITE RADIO TUNER
Connector Type	FAK6A



Terminal No.	Color of Wire	Signal Name [Specification]
33	-	SATELLITE ANTENNA

Connector No.	D41
Connector Name	WIRE TO WIRE
Connector Type	TH4DFW-CS15

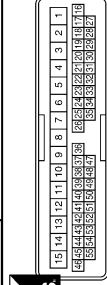

Terminal No.	Color of Wire	Signal Name [Specification]
4	B/R	-[Type A]
4	B	-[Type B]
5	BR	-[Type A]
5	W	-[Type B]

JCNWM1881GI

SATELLITE RADIO TUNER

[BOSE AUDIO WITHOUT NAVIGATION]

< ECU DIAGNOSIS >

BOSE AUDIO WITHOUT NAVIGATION WITH DVD ENTERTAINMENT SYSTEM

Connector No.	D153
Connector Name	FRONT DOOR SPEAKER RH (WITH BOSE SYSTEM)
Connector Type	NS2ZFBF-CS



Terminal No.	Color of Wire	Signal Name [Specification]
1	BR	- [Type A]
1	W	- [Type B]
2	B/R	- [Type A]
2	B	- [Type B]

Connector No.	D181
Connector Name	WIRE TO WIRE
Connector Type	TK10MW-NS3

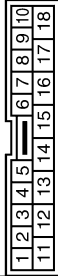

Terminal No.	Color of Wire	Signal Name [Specification]
4	L	-
5	W	-

Connector No.	D198
Connector Name	REAR DOOR SPEAKER LH (WITH BOSE SYSTEM)
Connector Type	NS2ZFBF-CS



Terminal No.	Color of Wire	Signal Name [Specification]
1	L	-
2	W	-

Connector No.	D106
Connector Name	REAR DOOR SPEAKER RH (WITH BOSE SYSTEM)
Connector Type	NS2ZFBF-CS



Terminal No.	Color of Wire	Signal Name [Specification]
1	O	- [Type A]
1	L	- [Type B]
2	B/P	- [Type A]
2	W	- [Type B]

Connector No.	D155
Connector Name	WIRE TO WIRE
Connector Type	TK10MW-NS3

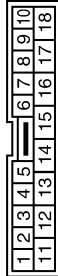

Terminal No.	Color of Wire	Signal Name [Specification]
4	O	- [Type A]
4	L	- [Type B]
5	B/P	- [Type A]
5	W	- [Type B]

Connector No.	D182
Connector Name	WIRE TO WIRE
Connector Type	TK12FW

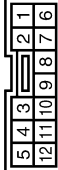

Terminal No.	Color of Wire	Signal Name [Specification]
6	R	-
7	G	-
8	B	-
9	SHIELD	-

Connector No.	D192
Connector Name	REAR VIEW CAMERA
Connector Type	TK16MGY-TV



Terminal No.	Color of Wire	Signal Name [Specification]
1	R	CAMERA ON SIGNAL
2	G	GND
3	B	CAMERA IMAGE SIGNAL
4	SHIELD	SHIELD

Connector No.	EB
Connector Name	WIRE TO WIRE
Connector Type	TK16MGY-TV



Terminal No.	Color of Wire	Signal Name [Specification]
4	R	-

JCNWM1882GI

A
B
C
D
E
F
G
H
I
J
K
L
M
O
P

AV

SATELLITE RADIO TUNER

[BOSE AUDIO WITHOUT NAVIGATION]

< ECU DIAGNOSIS >

BOSE AUDIO WITHOUT NAVIGATION WITH DVD ENTERTAINMENT SYSTEM

Connector No.	E18
Connector Name	ECM
Connector Type	RH24FB-R28-L-LH

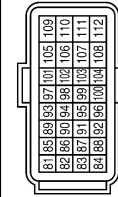

Terminal No.	Color of Wire	Signal Name [Specification]
97	P	VEHGAN-L
98	L	VEHGAN-H

Connector No.	E18
Connector Name	BACK-UP LAMP RELAY
Connector Type	MS02FL-M2-LC

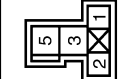

Terminal No.	Color of Wire	Signal Name [Specification]
1	LG	-
2	R	-
3	LG	-
5	R	-

Connector No.	E27
Connector Name	PARKING BRAKE SWITCH
Connector Type	F01FB-A



Terminal No.	Color of Wire	Signal Name [Specification]
1	P	-

Connector No.	E104
Connector Name	WIRE TO WIRE
Connector Type	NS36FW-CS

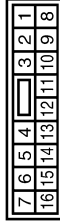

Terminal No.	Color of Wire	Signal Name [Specification]
4	R	-
5	L	-
6	P	-
7	L	-

Connector No.	E105
Connector Name	WIRE TO WIRE
Connector Type	TH70MW-CS10-M3

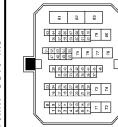

Terminal No.	Color of Wire	Signal Name [Specification]
5	LG	-
22	P	-
47	P	-
48	L	-
75	BR	-
76	GR	-
78	V	-

Connector No.	F23
Connector Name	TCM (TRANSMISSION CONTROL MODULE)
Connector Type	RH40FB-R28-L-RH

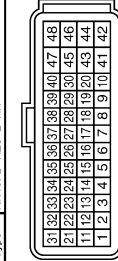

Terminal No.	Color of Wire	Signal Name [Specification]
19	G/B	REV LAMP RELAY

Connector No.	F123
Connector Name	WIRE TO WIRE
Connector Type	TK6FGY-1V

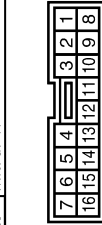

Terminal No.	Color of Wire	Signal Name [Specification]
4	G/B	-

Connector No.	M1
Connector Name	FUSE BLOCK (J/B)
Connector Type	NS00FW-M2



Terminal No.	Color of Wire	Signal Name [Specification]
2A	G	-
5A	R	-

JCNWM1883GI

SATELLITE RADIO TUNER

[BOSE AUDIO WITHOUT NAVIGATION]

< ECU DIAGNOSIS >

BOSE AUDIO WITHOUT NAVIGATION WITH DVD ENTERTAINMENT SYSTEM

Connector No.	M3
Connector Name	FUSE BLOCK (J/B)
Connector Type	NS12FW-CS

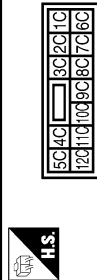

Terminal No.	Color of Wire	Signal Name [Specification]
12C	O	-

Connector No.	M4
Connector Name	DATA LINK CONNECTOR
Connector Type	BD16FW

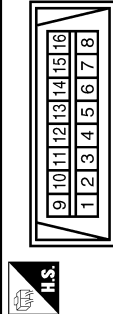

Terminal No.	Color of Wire	Signal Name [Specification]
6	L	-
14	P	-

Connector No.	M11
Connector Name	WIRE TO WIRE
Connector Type	TH10FW-CS10-M3

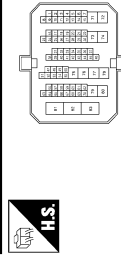

Terminal No.	Color of Wire	Signal Name [Specification]
5	O	-
22	G	-
47	P	-
48	L	-
75	BR	-
76	R	-
78	Y	-

Connector No.	M18
Connector Name	WIRE TO WIRE
Connector Type	TH40MW-CS15

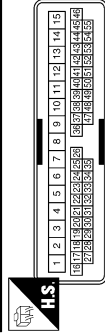

Terminal No.	Color of Wire	Signal Name [Specification]
4	W	-
5	BR	- [Type A and without BOSE system type B]
5	B	- [With BOSE system type B]

Connector No.	M20
Connector Name	WIRE TO WIRE
Connector Type	TH40MW-CS15

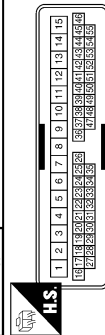

Terminal No.	Color of Wire	Signal Name [Specification]
4	B	-
5	L	-

Connector No.	M22
Connector Name	WIRE TO WIRE
Connector Type	TH12FW-NH

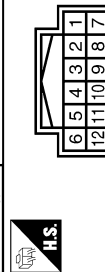

Terminal No.	Color of Wire	Signal Name [Specification]
1	V	-
2	R	-
3	R	-
4	G	-
5	W	-
6	SHIELD	-
7	LG	-
8	SHIELD	-
9	BR	-
10	SHIELD	-
11	L	-

Connector No.	M23
Connector Name	WIRE TO WIRE
Connector Type	TH16MW-NH

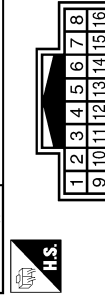

Terminal No.	Color of Wire	Signal Name [Specification]
1	W	-
2	R	- [With telephone without navigation system]
3	B	-
4	SHIELD	-

JCNWM1884GI

A
B
C
D
E
F
G
H
I
J
K
L
M
N
O
P

AV

SATELLITE RADIO TUNER

[BOSE AUDIO WITHOUT NAVIGATION]

< ECU DIAGNOSIS >

BOSE AUDIO WITHOUT NAVIGATION WITH DVD ENTERTAINMENT SYSTEM

Connector No.	M30
Connector Name	STEERING ANGLE SENSOR
Connector Type	TH08FW-NH

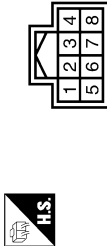

Terminal No.	Color of Wire	Signal Name [Specification]
1	B	-
3	L	-
4	G	-
6	SB	-
8	O	-

Connector No.	M33
Connector Name	COMBINATION SWITCH (SPIRAL CABLE)
Connector Type	TH08FGY-1V



Terminal No.	Color of Wire	Signal Name [Specification]
24	BR	- [With audio steering switch and telephone]
31	G	- [With audio steering switch and telephone]
33	L	- [With audio steering switch and telephone]

Connector No.	M34
Connector Name	COMBINATION METER
Connector Type	TH40FW-NH

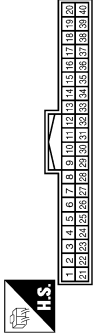

Terminal No.	Color of Wire	Signal Name [Specification]
21	L	CAN-H
22	P	CAN-L
31	V	VEHICLE SPEED (8-PULSE)

Connector No.	M44
Connector Name	WIRE TO WIRE
Connector Type	TH42FW-NH

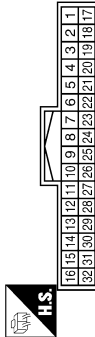

Terminal No.	Color of Wire	Signal Name [Specification]
1	G	-
2	R	-
3	SHIELD	-
4	B	-
5	W	-
6	SHIELD	-
7	O	- [Type A]
7	L	- [Type B]
8	SB	- [Type A]
8	R	- [Type B]
9	SHIELD	-

Terminal No.	10	V	-
11	LG	-	-
12	SHIELD	-	-
13	P	-	-

Connector No.	M49
Connector Name	FRONT DISPLAY UNIT
Connector Type	TH24FW-NH

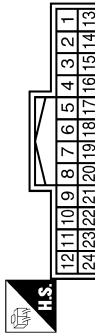

Terminal No.	Color of Wire	Signal Name [Specification]
1	B	GND
2	Y	INVERTER VCCI (Without navigation system)
3	O	SIGNAL VCCI (Without navigation system)
4	P	COMPOSITE IMAGE GND (Without navigation system)
5	SHIELD	SHIELD (Without navigation system)
6	L	RGB (GREEN) SIGNAL (Without navigation system)
7	SHIELD	SHIELD
8	G	HP (Without navigation system)
9	W	RGB AREA (YS) SIGNAL
11	R	COMM (CONT->DISP)
13	BR	INVERTER GND (Without navigation system)

14	LG	SIGNAL GND (Without navigation system)
15	L	COMPOSITE IMAGE SIGNAL (Without navigation system)
17	G	RGB (RED) SIGNAL
18	Y	RGB (BLUE) SIGNAL (Without navigation system)
19	B	RGB SYNC
20	R	VP
21	SHIELD	SHIELD
22	G	COMM (DISP->CONT)
23	SHIELD	SHIELD

JCNWM1885GI

SATELLITE RADIO TUNER

[BOSE AUDIO WITHOUT NAVIGATION]

< ECU DIAGNOSIS >

BOSE AUDIO WITHOUT NAVIGATION WITH DVD ENTERTAINMENT SYSTEM

Connector No.	M65
Connector Name	FRONT SQUAWKER LH
Connector Type	TK02FBR



Terminal No.	Color of Wire	Signal Name [Specification]
1	LG	[With BOSE system]
2	Y	[With BOSE system]

Connector No.	M66
Connector Name	CENTER SPEAKER
Connector Type	TK02FBR



Terminal No.	Color of Wire	Signal Name [Specification]
1	P	
2	O	

Connector No.	M67
Connector Name	FRONT SQUAWKER RH
Connector Type	TK02FBR



Terminal No.	Color of Wire	Signal Name [Specification]
1	BR	
2	R	[With BOSE system]

Connector No.	M77
Connector Name	WIRE TO WIRE
Connector Type	TH80FW-C519

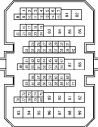

Terminal No.	Color of Wire	Signal Name [Specification]
1	SHIELD	
2	B	
3	W	
4	R	
8	SHIELD	
9	W	
10	R	
11	G	
12	B	
41	O	
42	SB	

43	L	
44	V	
45	P	
46	R	
47	Y	
48	L	
49	G	
50	SHIELD	
51	W	
56	P	
57	L	
58	SB	
59	SHIELD	
60	B	
61	R	
62	W	
68	G	
69	SHIELD	
70	L	
71	R	

Connector No.	M66
Connector Name	WIRE TO WIRE
Connector Type	TH18FW-NH

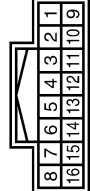

Terminal No.	Color of Wire	Signal Name [Specification]
1	Y	
3	R	
4	L	
5	L	
6	R	
7	SHIELD	
8	R	
9	G	
11	B	
12	G	
13	R	

14	W	
15	SHIELD	
16	B	

JCNWM1886G1

A
B
C
D
E
F
G
H
I
J
K
L
M
N
O
P

AV

SATELLITE RADIO TUNER

[BOSE AUDIO WITHOUT NAVIGATION]

< ECU DIAGNOSIS >

BOSE AUDIO WITHOUT NAVIGATION WITH DVD ENTERTAINMENT SYSTEM

Connector No.	M122
Connector Name	BCM BODY CONTROL MODULE
Connector Type	TH40FB-NH

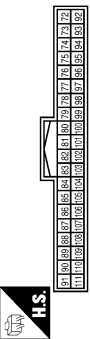

Terminal No.	Color of Wire	Signal Name [Specification]
90	P	CAN-L
91	L	CAN-H

Connector No.	M124
Connector Name	WIRE TO WIRE
Connector Type	NS12FBR-CS

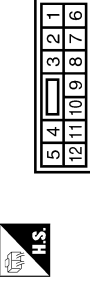

Terminal No.	Color of Wire	Signal Name [Specification]
1	P	-
2	BR	- [Type A]
3	B	- [Type B]
4	Y	-
5	BR	-
6	O	-
7	W	-
8	B	-
9	R	-
10	BR	-

Connector No.	M127
Connector Name	AV CONTROL UNIT (WITH BOSE SYSTEM WITHOUT NAVIGATION SYSTEM)
Connector Type	TH18FW-CS2

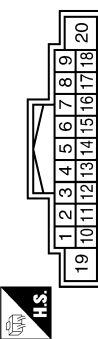

Terminal No.	Color of Wire	Signal Name [Specification]
6	BR	STRG SW A
7	R	ACC
9	R	ILLUMINATION
15	L	STRG SW GND
16	G	STRG SW B
19	Y	BATTERY
20	B	GND

Connector No.	M128
Connector Name	AV CONTROL UNIT (WITH BOSE SYSTEM WITHOUT NAVIGATION SYSTEM)
Connector Type	A12FW



Terminal No.	Color of Wire	Signal Name [Specification]
21	B	SATELLITE RADIO SOUND SIGNAL LH (-)
22	G	SATELLITE RADIO SOUND SIGNAL LH (+)
23	R	SATELLITE RADIO SOUND SIGNAL RH (-)
24	W	SATELLITE RADIO SOUND SIGNAL RH (+)
25	SHIELD	SHIELD
26	SHIELD	SHIELD
28	R	REQUEST (SAT->CONT)
29	W	COMM (SAT->CONT)
30	B	COMM (CONT->SAT)

11	LG
12	R

Connector No.	M125
Connector Name	MULTIFUNCTION SWITCH
Connector Type	TH16FW-NH

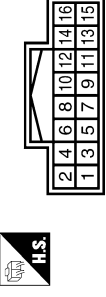

Terminal No.	Color of Wire	Signal Name [Specification]
1	B	GND
3	R	ACC
6	R	AV COMM (H)
8	L	AV COMM (L)
9	V	SW GND
14	W	EJECT SIGNAL

Connector No.	M129
Connector Name	AV CONTROL UNIT (WITH BOSE SYSTEM WITHOUT NAVIGATION SYSTEM)
Connector Type	TH24FW-NH

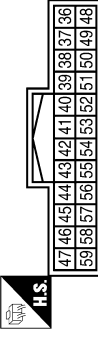

Terminal No.	Color of Wire	Signal Name [Specification]
36	L	COMPOSITE IMAGE SIGNAL
37	P	COMPOSITE IMAGE GND
38	Y	RGB (B/BLUE) SIGNAL
39	L	RGB (G/GREEN) SIGNAL
40	G	RGB (R/RED) SIGNAL
41	B	RGB SYNC
42	SHIELD	SHIELD
43	W	RGB AREA (YS) SIGNAL
44	G	COMM (DISP->CONT)
45	G	HP
46	LG	SIGNAL GND

SATELLITE RADIO TUNER

[BOSE AUDIO WITHOUT NAVIGATION]

< ECU DIAGNOSIS >

BOSE AUDIO WITHOUT NAVIGATION WITH DVD ENTERTAINMENT SYSTEM

Connector No.	M130
Connector Name	AV CONTROL UNIT (WITH BOSE SYSTEM WITHOUT NAVIGATION SYSTEM)
Connector Type	TH116FW-NH

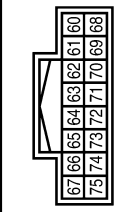

Connector No.	M131
Connector Name	AV CONTROL UNIT (WITH BOSE SYSTEM WITHOUT NAVIGATION SYSTEM)
Connector Type	TH122FW-NH

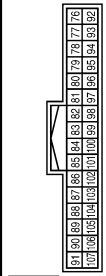

Terminal No.	Color of Wire	Signal Name [Specification]
64	SHIELD	SHIELD
65	W	CAMERA IMAGE SIGNAL
66	L	COMPOSITE IMAGE SIGNAL (With DVD player)
68	P	CONNECTION RECOGNITION
72	SHIELD	SHIELD (With DVD player)
74	R	COMPOSITE IMAGE GND (With DVD player)

Terminal No.	Color of Wire	Signal Name [Specification]
79	L	TEL VOICE SIGNAL (-)
80	R	TEL VOICE SIGNAL (+)
81	SHIELD	SHIELD
82	W	SOUND SIGNAL RH (-) (With DVD player)
83	R	SOUND SIGNAL RH (+) (With DVD player)
85	B	GND
86	L	CAN-H
87	P	CAN-L
88	R	AV COMM (H)
89	L	AV COMM (L)
90	G	AV COMM (H)

Connector No.	M132
Connector Name	AV CONTROL UNIT (WITH BOSE SYSTEM WITHOUT NAVIGATION SYSTEM)
Connector Type	TH121FW-NH

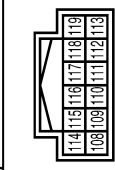

Terminal No.	R	SOUND SIGNAL FRONT LH (-)
--------------	---	---------------------------

91	L	AV COMM (L)
98	G	SOUND SIGNAL LH (-) (With DVD player)
99	B	SOUND SIGNAL LH (+) (With DVD player)
100	SHIELD	SHIELD (With DVD player)
101	V	SW GND
103	W	EJECT SIGNAL
104	G	IGNITION
105	SB	REVERSE
106	G	PARKING BRAKE
107	V	VEHICLE SPEED (8-PULSE)

Connector No.	M148
Connector Name	iPod ADAPTER
Connector Type	TH224FW-NH

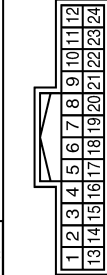

14	W	iPod SOUND SIGNAL RH (-)
15	SHIELD	SHIELD
16	R	AV COMM (H)
17	SHIELD	GND
19	SHIELD	SHIELD
21	L	iPod CONNECTION RECOGNITION
22	BR	ACCESSORY DETECT
23	R	iPod SOUND SIGNAL GND
24	LG	iPod SOUND SIGNAL LH (+)

Terminal No.	Color of Wire	Signal Name [Specification]
108	V	SOUND SIGNAL REAR RH (+)
109	B	SOUND SIGNAL FRONT RH (+)
110	P	AMP. ON SIGNAL
111	SHIELD	SHIELD
112	O	SOUND SIGNAL REAR LH (+) (Type A)
112	L	SOUND SIGNAL REAR LH (+) (Type B)
113	G	SOUND SIGNAL FRONT LH (+)
114	LG	SOUND SIGNAL REAR RH (-)
115	W	SOUND SIGNAL FRONT RH (-)
118	SB	SOUND SIGNAL REAR LH (-) (Type A)
118	R	SOUND SIGNAL REAR LH (-) (Type B)

Terminal No.	Color of Wire	Signal Name [Specification]
1	BR	iPod SOUND SIGNAL LH (+)
2	R	iPod SOUND SIGNAL RH (+)
3	R	ACC
4	L	AV COMM (L)
5	Y	BATTERY
8	W	CHARGE POWER
9	G	COMM (iPod ADAPTER->iPod)
10	R	COMM (iPod->iPod ADAPTER)
11	R	ACCESSORY IDENTIFY
12	V	iPod SOUND SIGNAL RH (+)
13	L	iPod SOUND SIGNAL LH (-)

A
B
C
D
E
F
G
H
I
J
K
L
M
N
O
P

AV

JCNWM1888GI

SATELLITE RADIO TUNER

[BOSE AUDIO WITHOUT NAVIGATION]

< ECU DIAGNOSIS >

BOSE AUDIO WITHOUT NAVIGATION WITH DVD ENTERTAINMENT SYSTEM

Connector No.	M201
Connector Name	WIRE TO WIRE
Connector Type	TH16MW-NH

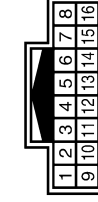

Terminal No.	Color of Wire	Signal Name [Specification]
1	Y	-
2	R	-
3	R	-
4	G	-
5	L	-
6	R	-
7	SHIELD	-
8	V	-
9	G	-
10	B	-
11	B	-
12	G	-
13	R	-

Connector No.	M253
Connector Name	AUXILIARY INPUT JACKS
Connector Type	A08FW

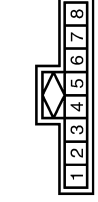

Terminal No.	Color of Wire	Signal Name [Specification]
1	R	SOUND SIGNAL RH (+)
2	W	SOUND SIGNAL GND
3	G	SOUND SIGNAL LH (-) [Wth DVD player]
7	G	AUX IMAGE SIGNAL
8	SHIELD	SHIELD [Wth DVD player]

14	W	-
15	SHIELD	-
16	B	-



Terminal No.	Color of Wire	Signal Name [Specification]
1	V	-
2	R	-
3	R	-
4	G	-
5	W	-
6	SHIELD	-
7	LG	-
8	SHIELD	-
9	BR	-
10	SHIELD	-
11	L	-

Connector No.	M254
Connector Name	DVD PLAYER
Connector Type	TH32FW-NH

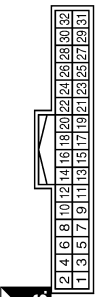

Terminal No.	Color of Wire	Signal Name [Specification]
1	B	GND
2	Y	BATTERY
4	V	ACC
5	SHIELD	SHIELD
7	P	DVD IMAGE SIGNAL
11	B	AUX SOUND SIGNAL LH (-)
12	W	AUX SOUND SIGNAL RH (-)
13	G	AUX SOUND SIGNAL LH (+)
14	R	AUX SOUND SIGNAL RH (+)
16	SHIELD	SHIELD
17	G	HEADPHONE SOUND SIGNAL LH (+)

12	R	-
----	---	---



Connector No.	M255
Connector Name	VIDEO DISTRIBUTOR
Connector Type	TH08FW-NH

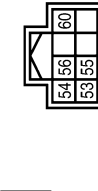

Terminal No.	Color of Wire	Signal Name [Specification]
53	B	GND
54	Y	BATTERY
55	V	ACC
56	G	IGNITION
60	R	HEADPHONE ON SIGNAL

SATELLITE RADIO TUNER

[BOSE AUDIO WITHOUT NAVIGATION]

< ECU DIAGNOSIS >

BOSE AUDIO WITHOUT NAVIGATION WITH DVD ENTERTAINMENT SYSTEM

Connector No.	M256
Connector Name	VIDEO DISTRIBUTOR
Connector Type	TH12FW-NH



26	28	30	32	34	36	38	40
25	27	29	31	33	35	37	39



Connector No.	M257
Connector Name	VIDEO DISTRIBUTOR
Connector Type	TH11FW-NH



26	28	30	32	34	36	38	40
25	27	29	31	33	35	37	39



36	G	IGNITION
38	SHIELD	SHIELD
39	V	COMM (DISP->DIST)
40	LG	COMM (DIST->DISP)

Terminal No.	Color of Wire	Signal Name [Specification]
51	B	GND

Terminal No.	Color of Wire	Signal Name [Specification]
25	R	RGB (R/RED) SIGNAL
26	L	RGB (G/GREEN) SIGNAL
27	W	RGB GND
28	G	RGB (B/BLUE) SIGNAL
29	R	YP
30	W	HP
31	SHIELD	SHIELD
32	B	RGB AREA (Y/S) SIGNAL
33	G	COMPOSITE SYNC
34	R	COMPOSITE IMAGE SIGNAL
35	SHIELD	SHIELD

Connector No.	M258
Connector Name	VIDEO DISTRIBUTOR
Connector Type	TH12FW-NH



2	4	6	8	10	12	14	16	18	20	22	24
1	3	5	7	9	11	13	15	17	19	21	23



Terminal No.	23	P	DVD IMAGE SIGNAL
--------------	----	---	------------------

Connector No.	M259
Connector Name	WIRE TO WIRE
Connector Type	TH32MW-NH



1	2	3	4	5	6	7	8	9	10	11	12	13	14	15	16
17	18	19	20	21	22	23	24	25	26	27	28	29	30	31	32



Terminal No.	Color of Wire	Signal Name [Specification]
1	R	AV COMM (H)
2	G	AV COMM (L)
3	R	AV COMM (H)
4	L	AV COMM (L)
6	R	COMPOSITE IMAGE GND
8	L	COMPOSITE IMAGE SIGNAL
15	B	GND
16	B	GND
19	G	AUX IMAGE SIGNAL
21	SHIELD	SHIELD
22	SHIELD	SHIELD

13	L	-
14	R	-
16	G	-
18	V	-
19	L	-
21	LG	-
22	V	-
23	SHIELD	-
24	B	-
25	W	-
26	R	-
27	SHIELD	-
28	G	-
29	R	-
30	SHIELD	-
31	R	-

Terminal No.	Color of Wire	Signal Name [Specification]
1	Y	-
3	R	-
4	SHIELD	-
5	LG	-
6	V	-
7	SHIELD	-
8	R	-
9	G	-
10	SHIELD	-
11	W	-
12	G	-

A
B
C
D
E
F
G
H
I
J
K
L
M
N
O
P

AV

JCNWM1890GI

SATELLITE RADIO TUNER

[BOSE AUDIO WITHOUT NAVIGATION]

< ECU DIAGNOSIS >

BOSE AUDIO WITHOUT NAVIGATION WITH DVD ENTERTAINMENT SYSTEM

Connector No.	M370
Connector Name	iPod SIDE
Connector Type	IP18FGY

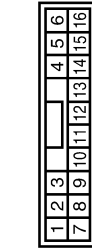

Terminal No.	Color of Wire	Signal Name [Specification]
1	LG	iPod SOUND SIGNAL LH (+)
2	R	iPod SOUND SIGNAL LH (-)
5	R	COMM (iPod->iPod ADAPTER)
6	G	COMM (iPod ADAPTER->iPod)
7	V	iPod SOUND SIGNAL RH (+)
8	L	iPod SOUND SIGNAL RH (-)
9	L	iPod CONNECTION RECOGNITION GND
10	SHIELD	CHARGE POWER
12	W	SHIELD
14	SHIELD	ACCESSORY DETECT
15	BR	ACCESSORY DETECT
16	R	ACCESSORY IDENTIFY

Connector No.	M303
Connector Name	COMBINATION SWITCH (SPIRAL CABLE)
Connector Type	TK08FGY



Terminal No.	Color of Wire	Signal Name [Specification]
14	-	-
15	-	-
17	-	-

Connector No.	M370
Connector Name	AV CONTROL UNIT (WITH BOSE SYSTEM WITHOUT NAVIGATION SYSTEM)
Connector Type	GT13SC-2/1S-HU



Terminal No.	Color of Wire	Signal Name [Specification]
33	-	FM SUB
34	-	AM-FM MAIN
35	-	ANTENNA AMP. ON SIGNAL

Connector No.	M375
Connector Name	WIRE TO WIRE
Connector Type	GT13SH-2/1S-HU

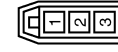

Terminal No.	Color of Wire	Signal Name [Specification]
1	-	-
2	-	-
3	-	-

Connector No.	M376
Connector Name	WIRE TO WIRE
Connector Type	GT13SCN-2/1PP-HU

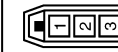

Terminal No.	Color of Wire	Signal Name [Specification]
1	-	-
2	-	-
3	-	-

Connector No.	M378
Connector Name	ANTENNA BASE (ANTENNA AMP.)
Connector Type	GT13SSN-1/1PP-HU

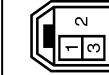

Terminal No.	Color of Wire	Signal Name [Specification]
1	-	-
3	-	-

Connector No.	M379
Connector Name	GLASS ANTENNA
Connector Type	GT13SCN-1/1PP-HU



Terminal No.	Color of Wire	Signal Name [Specification]
2	-	FM SUB

Connector No.	FT
Connector Name	WIRE TO WIRE
Connector Type	TH16FW-NH

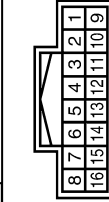

Terminal No.	Color of Wire	Signal Name [Specification]
1	R/W	-
2	R/L	-(With telephones without navigation system)
3	B	-
4	SHIELD	-

JCNWM1891GI

SATELLITE RADIO TUNER

[BOSE AUDIO WITHOUT NAVIGATION]

< ECU DIAGNOSIS >

BOSE AUDIO WITHOUT NAVIGATION WITH DVD ENTERTAINMENT SYSTEM

Connector No.	R20
Connector Name	MICROPHONE
Connector Type	TH2FW-NH



Terminal No.	Color of Wire	Signal Name [Specification]
1	R/W	MICROPHONE SIGNAL (+)
2	R/L	MICROPHONE SIGNAL (-) (Only in vehicles with navigation system)
4	B	MICROPHONE POWER

Connector No.	R152
Connector Name	REAR DISPLAY UNIT
Connector Type	TH2FW-NH



Terminal No.	Color of Wire	Signal Name [Specification]
1	B	GND
2	B	GND
3	Y/R	BATTERY
4	Y/R	BATTERY
5	R	HEADPHONE ON SIGNAL
6	V/Y	ACC
8	SHIELD	SHIELD
9	V	COMM (DISP->DISP)
10	LG	COMM (DISP->DISP)
11	G	IGNITION
12	SHIELD	SHIELD

Connector No.	R153
Connector Name	WIRE TO WIRE
Connector Type	TH2FW-NH



Terminal No.	Color of Wire	Signal Name [Specification]
1	Y/R	-
2	B	-
4	SHIELD	-
5	LG	-
6	V	-
7	SHIELD	-
8	BR	-
9	Y	-
10	SHIELD	-
11	W/L	-
12	Y/G	-

13	G	COMPOSITE SYNC
14	R	COMPOSITE IMAGE SIGNAL
15	B	RGB AREA (V/S) SIGNAL
16	SHIELD	GND
17	R	VP
18	W	HP
19	W/L	RGB GND
20	Y/G	RGR (B/BLUE) SIGNAL
21	Y/L	RGB (G/GREEN) SIGNAL
22	BR/L	RGB (R/RED) SIGNAL
23	SHIELD	SHIELD
24	SHIELD	SHIELD
25	LG	HEADPHONE SOUND SIGNAL RH (-)
26	BR	HEADPHONE SOUND SIGNAL LH (-)
27	V	HEADPHONE SOUND SIGNAL RH (+)
28	Y	HEADPHONE SOUND SIGNAL LH (+)

A
B
C
D
E
F
G
H
I
J
K
L
M
N
O
P

AV

JCNWM1892G1

IPOD ADAPTER

[BOSE AUDIO WITHOUT NAVIGATION]

< ECU DIAGNOSIS >

IPOD ADAPTER

Reference Values

INFOID:000000003625753

TERMINAL LAYOUT

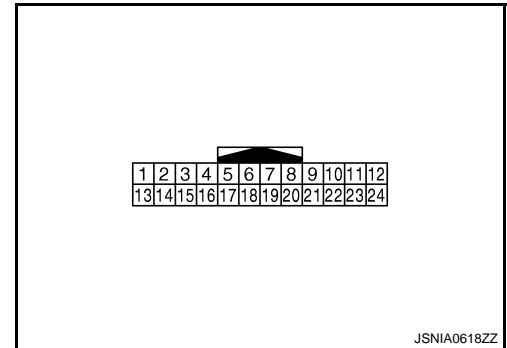

JSNIA0618ZZ

PHYSICAL VALUES

Terminal (Wire color)		Description		Condition		Reference value (Approx.)
+	-	Signal name	Input/ Output			
1 (BR)	13 (L)	iPod sound signal LH	Output	Ignition switch ON	When iPod mode is select- ed.	<p>SKIB3609E</p>
2 (R)	14 (W)	iPod sound signal RH	Output	Ignition switch ON	When iPod mode is select- ed.	<p>SKIB3609E</p>
3 (R)	Ground	ACC power supply	Input	Ignition switch ACC	—	Battery voltage
4 (L)	—	AV communication signal (L)	Input/ Output	—	—	—
5 (Y)	Ground	Battery power supply	Input	Ignition switch OFF	—	Battery voltage
8 (W)	Ground	iPod battery charge	Output	Ignition switch ON	Connected to iPod®.	12.0 V

IPOD ADAPTER

< ECU DIAGNOSIS >

[BOSE AUDIO WITHOUT NAVIGATION]

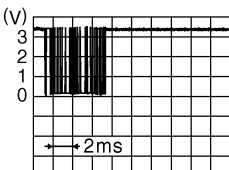
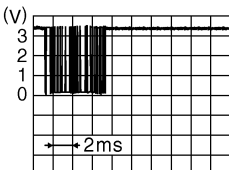
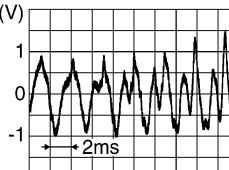
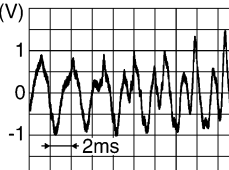
Terminal (Wire color)		Description		Condition		Reference value (Approx.)
+	-	Signal name	Input/ Output	Ignition switch ON		
9 (G)	Ground	Communication signal (iPod adapter→iPod®)	Output	Ignition switch ON	The wave pattern is displayed just after iPod connection.	 <p style="text-align: right; font-size: small;">JPNIA0462GB</p> <p>NOTE: After the wave pattern display, the value continues Approx 3.3 V</p>
10 (R)	Ground	Communication signal (iPod®→iPod adapter)	Input	Ignition switch ON	Connected to iPod®.	 <p style="text-align: right; font-size: small;">JPNIA0462GB</p>
11 (R)	Ground	ACCESSORY-IDENTIFY	—	Ignition switch ON	Connected to iPod®.	0 V
12 (V)	23 (R)	iPod sound signal RH	Input	Ignition switch ON	When iPod mode is selected.	 <p style="text-align: right; font-size: small;">SKIB3609E</p>
15	—	Shield	—	—	—	—
16 (R)	—	AV communication signal (H)	Input/ Output	—	—	—
17	Ground	Ground	—	Ignition switch ON	—	0 V
19	—	Shield	—	—	—	—
21 (L)	Ground	iPod connection recognition signal	Input	Ignition switch ON	Not connected to iPod®.	4.0 V
					Connected to iPod®.	0 V
22 (BR)	Ground	ACCESSORY-DETECT	—	Ignition switch ON	Connected to iPod®.	0 V
24 (LG)	23 (R)	iPod sound signal LH	Input	Ignition switch ON	When iPod mode is selected.	 <p style="text-align: right; font-size: small;">SKIB3609E</p>

A
B
C
D
E
F
G
H
I
J
K
L
M
O
P

AV

Wiring Diagram - BOSE AUDIO WITHOUT NAVIGATION WITHOUT DVD ENTER-

IPOD ADAPTER

[BOSE AUDIO WITHOUT NAVIGATION]

< ECU DIAGNOSIS >

TAINMENT SYSTEM -

INFOID:000000003702917

NOTE:

- In this section, PRESET SWITCH and MULTIFUNCTION SWITCH are written as the MULTIFUNCTION SWITCH.
- Type A: Up to VIN: JN8AZ18U*9W100000, JN8AZ18W*9W200000 (EXCEPT FOR MEXICO), JN8AZ18U*9W710000, JN8AZ18W*9W810000 (FOR MEXICO)
- Type B: From VIN: JN8AZ18U*9W100001, JN8AZ18W*9W200001 (EXCEPT FOR MEXICO), JN8AZ18U*9W710001, JN8AZ18W*9W810001 (FOR MEXICO)

BOSE AUDIO WITHOUT NAVIGATION WITHOUT DVD ENTERTAINMENT SYSTEM

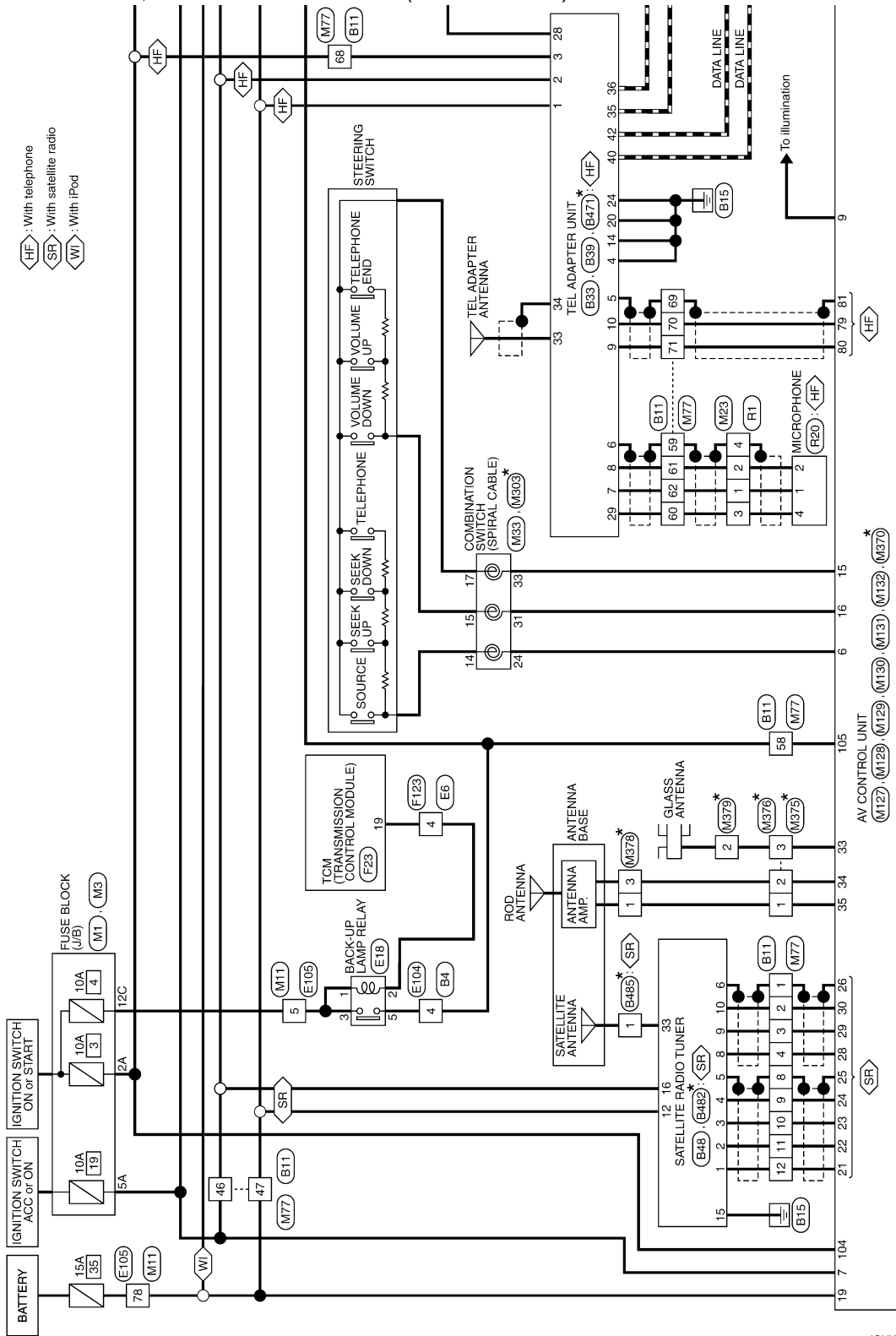

*: This connector is not shown in "Harness Layout".

2008/09/23

JCNWM1855GI

IPOD ADAPTER

[BOSE AUDIO WITHOUT NAVIGATION]

< ECU DIAGNOSIS >

- HF : With telephone
- OF : Without telephone
- WI : With iPod

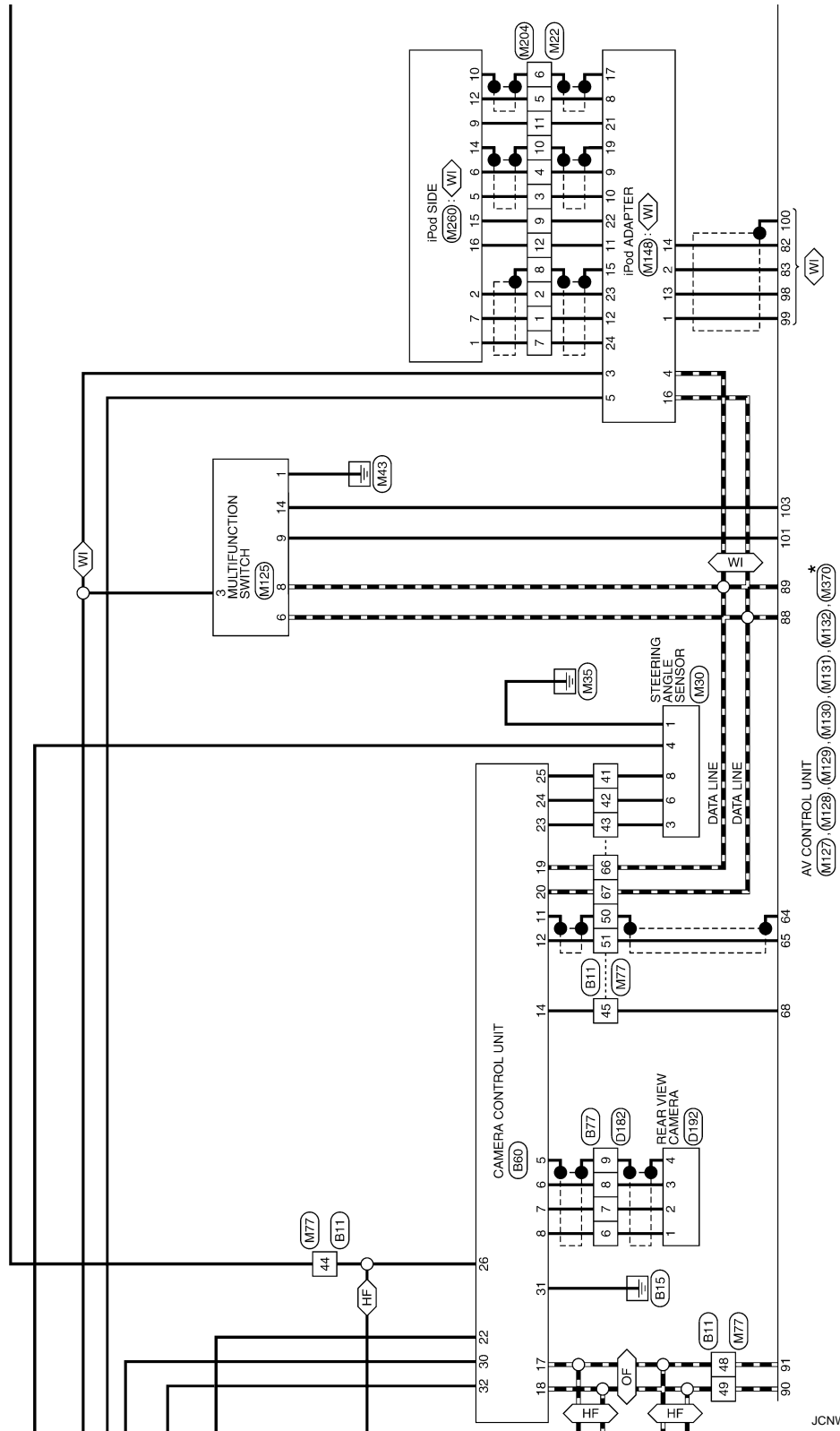

*: This connector is not shown in "Harness Layout".

JCNWM1856GI

A
B
C
D
E
F
G
H
I
J
K
L
M
N
O
P

AV

IPOD ADAPTER

[BOSE AUDIO WITHOUT NAVIGATION]

< ECU DIAGNOSIS >

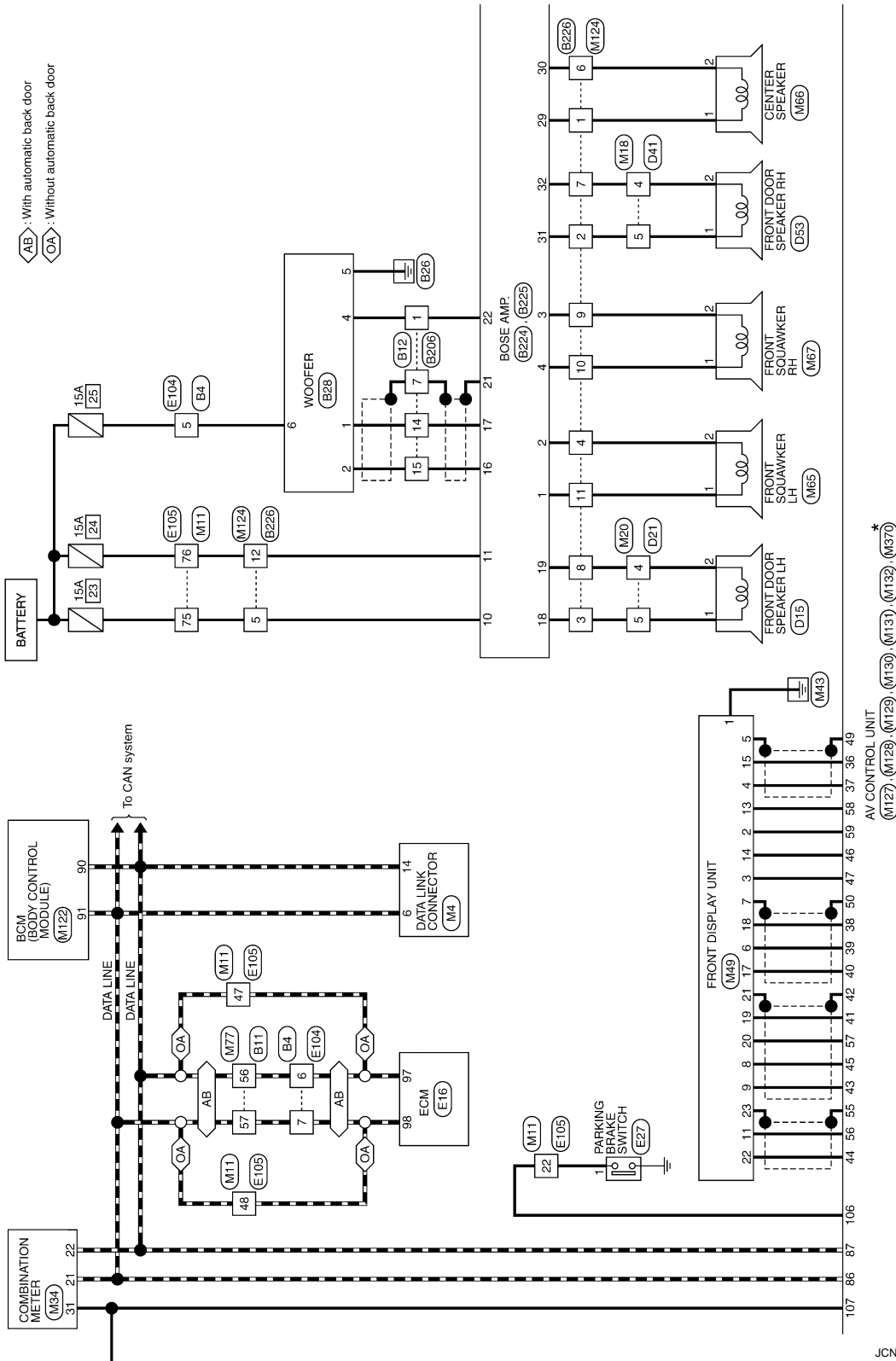

*: This connector is not shown in "Harness Layout".

JCNWM1857GI

IPOD ADAPTER

[BOSE AUDIO WITHOUT NAVIGATION]

< ECU DIAGNOSIS >

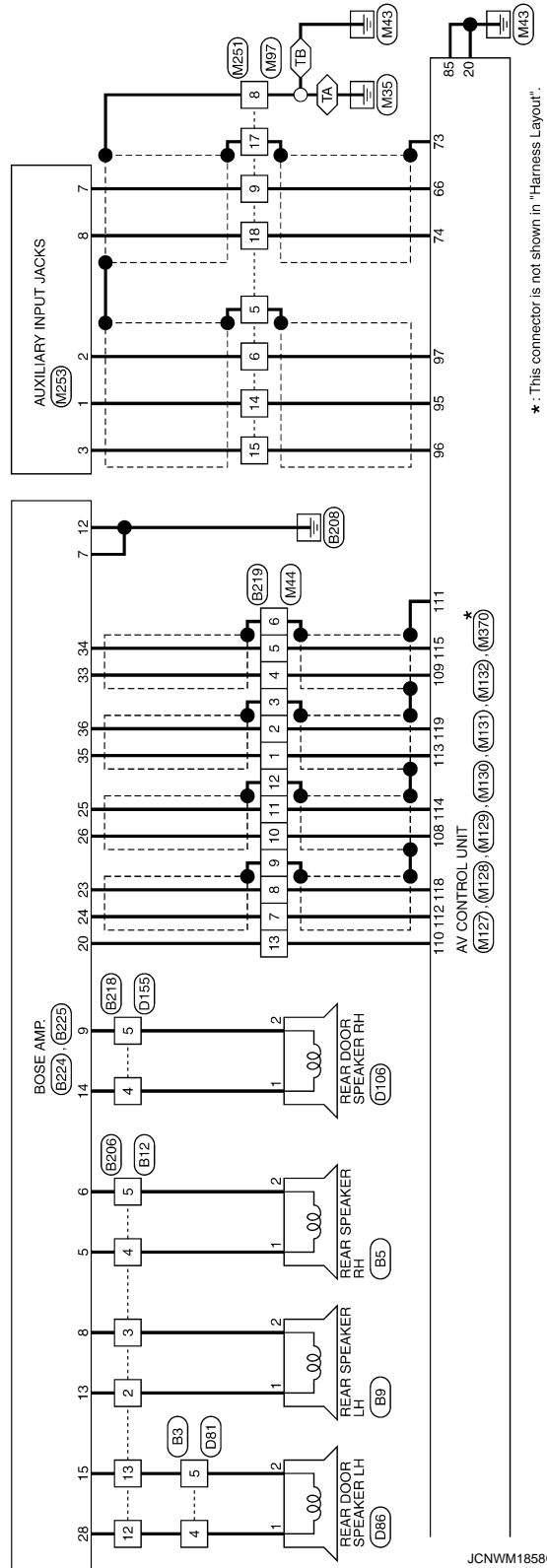

*: This connector is not shown in "Harness Layout".

JCNWM1858GI

A
B
C
D
E
F
G
H
I
J
K
L
M
AV
O
P

IPOD ADAPTER

[BOSE AUDIO WITHOUT NAVIGATION]

< ECU DIAGNOSIS >

BOSE AUDIO WITHOUT NAVIGATION WITHOUT DVD ENTERTAINMENT SYSTEM

Connector No.	B3
Connector Name	WIRE TO WIRE
Connector Type	TK10FW-NS8



Terminal No.	Color of Wire	Signal Name [Specification]
4	LG	-
5	O	-

Connector No.	B4
Connector Name	WIRE TO WIRE
Connector Type	NS16MW-CS



Terminal No.	Color of Wire	Signal Name [Specification]
4	R	-
5	O	-
6	P	-
7	L	-

Connector No.	B5
Connector Name	REAR SPEAKER RH
Connector Type	TK02FBR



Terminal No.	Color of Wire	Signal Name [Specification]
1	V	-
2	LG	-

Connector No.	B9
Connector Name	REAR SPEAKER LH
Connector Type	TK02FBR



Terminal No.	Color of Wire	Signal Name [Specification]
1	SB	-
2	GR	-

Connector No.	B11
Connector Name	WIRE TO WIRE
Connector Type	TH80MW-CS19

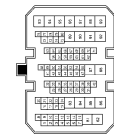

Terminal No.	Color of Wire	Signal Name [Specification]
1	SHIELD	-
2	B	-
3	R/L	-
4	R/W	-
8	SHIELD	-
9	BR/L	-
10	Y/G	-
11	Y/L	-
12	W/L	-
41	O	-
42	SB	-

43	G	-
44	BR	-
45	L	-
46	GR	-
47	V	-
48	GR	- [With rear view camera and telephone]
48	BR	- [With rear view camera without telephone]
49	Y	-
50	SHIELD	-
51	B	-
56	P	-
57	L	-
58	R	-
59	SHIELD	-
60	B	-
61	R/L	-
62	R/W	-
66	GR	-
67	G	-
68	R	-
69	SHIELD	-
70	W/R	-
71	B/R	-

Connector No.	B12
Connector Name	WIRE TO WIRE
Connector Type	NS18FW-CS

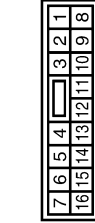

Terminal No.	Color of Wire	Signal Name [Specification]
1	W	-
2	SB	-
3	GR	-
4	V	-
5	LG	-
7	SHIELD	-
12	LG	-
13	O	-
14	W/R	-
15	B/R	-

Connector No.	B28
Connector Name	WOOFER
Connector Type	RS08FGY-PR



Terminal No.	Color of Wire	Signal Name [Specification]
1	W/R	SOUND SIGNAL WOOFER (-)
2	B/R	SOUND SIGNAL WOOFER (+)
4	W	WOOFER AMP. ON SIGNAL
5	B/W	GND
6	O	BAT

IPOD ADAPTER

[BOSE AUDIO WITHOUT NAVIGATION]

< ECU DIAGNOSIS >

BOSE AUDIO WITHOUT NAVIGATION WITHOUT DVD ENTERTAINMENT SYSTEM

Connector No.	B33
Connector Name	TEL ADAPTER UNIT
Connector Type	TH88FW-NH



2	3	4	5	6	7	8	9	10	11	12	13	14	15	16	17	18	19	20	21	22	23	24	25	26	27	28	29	30	31	32	
1	2	3	4	5	6	7	8	9	10	11	12	13	14	15	16	17	18	19	20	21	22	23	24	25	26	27	28	29	30	31	32

Terminal No.	Color of Wire	Signal Name [Specification]
35	Y	AV COMM (H)
36	BR	AV COMM (L)
40	G	AV COMM (H)
42	GR	AV COMM (L)

Connector No.	B48
Connector Name	SATELLITE RADIO TUNER
Connector Type	A18FW



2	3	4	5	6	7	8	9	10	11	12	13	14	15	16	
1	2	3	4	5	6	7	8	9	10	11	12	13	14	15	16

Terminal No.	Color of Wire	Signal Name [Specification]
1	W/L	SOUND SIGNAL LH (-)
2	Y/L	SOUND SIGNAL LH (+)
3	Y/G	SOUND SIGNAL RH (-)
4	BR/L	SOUND SIGNAL RH (+)
5	SHIELD	SHIELD
6	SHIELD	SHIELD
8	R/W	REQUEST (SAT->CONT)
9	R/L	COMM (SAT->CONT)
10	B	COMM (CONT->SAT)
12	V	BATTERY
15	B	GND

Connector No.	B39
Connector Name	TEL ADAPTER UNIT
Connector Type	TH32FW-NH



2	3	4	5	6	7	8	9	10	11	12	13	14	15	16	17	18	19	20	21	22	23	24	25	26	27	28	29	30	31	32	
1	2	3	4	5	6	7	8	9	10	11	12	13	14	15	16	17	18	19	20	21	22	23	24	25	26	27	28	29	30	31	32

Terminal No.	Color of Wire	Signal Name [Specification]
1	V	BATTERY
2	GR	ACC
3	R	IGNITION
4	B/W	GND
5	SHIELD	SHIELD
6	SHIELD	SHIELD
7	R/W	MICROPHONE SIGNAL
8	R/L	MICROPHONE GND
9	B/R	TEL VOICE SIGNAL (+)
10	W/R	TEL VOICE SIGNAL (-)
14	B	GND

Connector No.	B60
Connector Name	CAMERA CONTROL UNIT
Connector Type	TH32FW-NH



2	3	4	5	6	7	8	9	10	11	12	13	14	15	16	17	18	19	20	21	22	23	24	25	26	27	28	29	30	31	32	
1	2	3	4	5	6	7	8	9	10	11	12	13	14	15	16	17	18	19	20	21	22	23	24	25	26	27	28	29	30	31	32

Terminal No.	Color of Wire	Signal Name [Specification]
5	SHIELD	SHIELD
6	B	CAMERA IMAGE SIGNAL
7	R/W	GND
8	R/L	CAMERA ON SIGNAL
11	SHIELD	SHIELD
12	B	CAMERA IMAGE SIGNAL
14	L	CONNECTION RECOGNITION
17	BR	AV COMM (L)
18	Y	AV COMM (H)
19	GR	AV COMM (L)
20	G	AV COMM (H)

22	R	REVERSE
23	G	SENSOR SIGNAL 1
24	SB	SENSOR SIGNAL 2
25	O	SENSOR SIGNAL 3
26	BR	VEHICLE SPEED (8-PULSE)
30	GR	ACC
31	B	GND
32	V	BATTERY

A
B
C
D
E
F
G
H
I
J
K
L
M
N
O
P

AV

JCNWM1860GI

IPOD ADAPTER

[BOSE AUDIO WITHOUT NAVIGATION]

< ECU DIAGNOSIS >

BOSE AUDIO WITHOUT NAVIGATION WITHOUT DVD ENTERTAINMENT SYSTEM

Connector No.	B77
Connector Name	WIRE TO WIRE
Connector Type	TK12MW

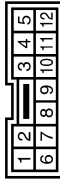

Terminal No.	Color of Wire	Signal Name [Specification]
6	R/L	-
7	R/W	-
8	B	-
9	SHIELD	-

Connector No.	B706
Connector Name	WIRE TO WIRE
Connector Type	NS16MW-GS

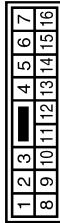

Terminal No.	Color of Wire	Signal Name [Specification]
1	W	-
2	GR	-
3	BR	-
4	Y	-
5	BR	-
7	SHIELD	-
12	G	-
13	R	-
14	W/R	-
15	B/R	-

Connector No.	B218
Connector Name	WIRE TO WIRE
Connector Type	TK10FW-NSB



Terminal No.	Color of Wire	Signal Name [Specification]
4	L	-[With BOSE system]
5	O	-[With BOSE system]

Connector No.	B219
Connector Name	WIRE TO WIRE
Connector Type	TH82MW-NH



Terminal No.	Color of Wire	Signal Name [Specification]
1	W/R	-
2	B/R	-
3	SHIELD	-
4	W/R	-
5	B/R	-
6	SHIELD	-
7	GR/V	-
8	W/L	-
9	SHIELD	-
10	GR/V	-
11	W/L	-

Terminal No.	12	SHIELD	-
Terminal No.	13	SB	-

Connector No.	B224
Connector Name	BOSE AMP.
Connector Type	SGA12FBR-SJA2



Terminal No.	12	B	GND
Terminal No.	13	GR	SOUND SIGNAL REAR SPEAKER LH (+)
Terminal No.	14	L	SOUND SIGNAL REAR DOOR SPEAKER RH (+)

Terminal No.	Color of Wire	Signal Name [Specification]
1	LG	SOUND SIGNAL FRONT SQUAWKER LH (+)
2	V	SOUND SIGNAL FRONT SQUAWKER LH (-)
3	L	SOUND SIGNAL FRONT SQUAWKER RH (-)
4	P	SOUND SIGNAL FRONT SQUAWKER RH (+)
5	Y	SOUND SIGNAL REAR SPEAKER RH (+)
6	BR	SOUND SIGNAL REAR SPEAKER RH (-)
7	B	GND
8	BR	SOUND SIGNAL REAR SPEAKER LH (-)
9	O	SOUND SIGNAL REAR DOOR SPEAKER RH (-)
10	SB	BATTERY
11	GR	BATTERY

JCNWM1861GI

IPOD ADAPTER

[BOSE AUDIO WITHOUT NAVIGATION]

< ECU DIAGNOSIS >

BOSE AUDIO WITHOUT NAVIGATION WITHOUT DVD ENTERTAINMENT SYSTEM

Connector No.	B225
Connector Name	BOSE AMP.
Connector Type	SCA1PBR-SGA4

37	36	35	34	33	32	31	30	29	28			
27	26	25	24	23	22	21	20	19	18	17	16	15

Terminal No.	Color of Wire	Signal Name [Specification]
15	R	SOUND SIGNAL REAR DOOR SPEAKER LH (-)
16	B/R	SOUND SIGNAL REAR DOOR SPEAKER LH (+)
17	W/R	SOUND SIGNAL WOOFER (-)
18	W	SOUND SIGNAL WOOFER (+)
18	B	SOUND SIGNAL FRONT DOOR SPEAKER LH (+)
20	SB	SOUND SIGNAL FRONT DOOR SPEAKER LH (-)
21	SHIELD	AMP ON SIGNAL
21	SHIELD	SHIELD
22	W	WOOFER AMP-ON SIGNAL
23	W/L	SOUND SIGNAL REAR LH (-)
24	GR/V	SOUND SIGNAL REAR LH (+)
25	W/L	SOUND SIGNAL REAR RH (-)

Connector No.	B471
Connector Name	TEL ADAPTER UNIT
Connector Type	GT1BC-1S-HU

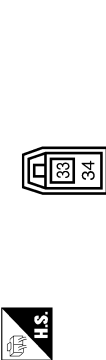

Terminal No.	Color of Wire	Signal Name [Specification]
33	-	TEL ANTENNA
34	SHIELD	SHIELD

26	GR/V	SOUND SIGNAL REAR RH (+)
28	G	SOUND SIGNAL REAR DOOR SPEAKER LH (+)
29	V	SOUND SIGNAL CENTER SPEAKER (+)
30	P	SOUND SIGNAL CENTER SPEAKER (-)
31	BR	SOUND SIGNAL FRONT DOOR SPEAKER RH (+)
32	Y	SOUND SIGNAL FRONT DOOR SPEAKER RH (-)
33	W/R	SOUND SIGNAL FRONT RH (+)
34	B/R	SOUND SIGNAL FRONT RH (-)
35	W/R	SOUND SIGNAL FRONT LH (+)
36	B/R	SOUND SIGNAL FRONT LH (-)

Terminal No.	Color of Wire	Signal Name [Specification]
1	V	-
2	BR	-
3	W	-
4	V	-
5	SB	-
8	P	-
7	Y	-
8	B	-
9	L	-
10	P	-
11	LG	-

Connector No.	B482
Connector Name	SATELLITE RADIO TUNER
Connector Type	FAKRA



Terminal No.	Color of Wire	Signal Name [Specification]
33	-	SATELLITE ANTENNA
34	-	SATELLITE ANTENNA

Connector No.	B226
Connector Name	WIRE TO WIRE
Connector Type	NS12MFR-CS

1	2	3	4	5		
6	7	8	9	10	11	12

Connector No.	D15
Connector Name	FRONT DOOR SPEAKER LH (WITH BOSE SYSTEM)
Connector Type	NS02FBR-CS

Connector No.	B485
Connector Name	ANTENNA BASE (SATELLITE ANTENNA (WITH BOSE SYSTEM WITHOUT NAVIGATION SYSTEM))
Connector Type	GT1BC-1PP-HU



Terminal No.	Color of Wire	Signal Name [Specification]
1	L	-[Type A]
1	W	-[Type B]
2	B/W	-[Type A]
2	B	-[Type B]

JCNWM1862GI

A
B
C
D
E
F
G
H
I
J
K
L
M
N
O
P

AV

IPOD ADAPTER

[BOSE AUDIO WITHOUT NAVIGATION]

< ECU DIAGNOSIS >

BOSE AUDIO WITHOUT NAVIGATION WITHOUT DVD ENTERTAINMENT SYSTEM

Connector No.	D81
Connector Name	WIRE TO WIRE
Connector Type	TK10MW-NS8



Terminal No.	Color of Wire	Signal Name [Specification]
4	L	-
5	W	-

Connector No.	D53
Connector Name	FRONT DOOR SPEAKER RH (WITH BOSE SYSTEM)
Connector Type	NS02FBR-CS



Terminal No.	Color of Wire	Signal Name [Specification]
1	BR	-[Type A]
2	B/R	-[Type A]
2	B	-[Type B]

Connector No.	D41
Connector Name	WIRE TO WIRE
Connector Type	TH40FW-CS15

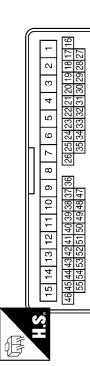

Terminal No.	Color of Wire	Signal Name [Specification]
4	B/R	-[Type A]
4	B	-[Type B]
5	BR	-[Type A]
5	W	-[Type B]

Connector No.	D21
Connector Name	WIRE TO WIRE
Connector Type	TH40FW-CS15

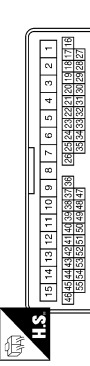

Terminal No.	Color of Wire	Signal Name [Specification]
4	B/W	-[Type A]
4	B	-[Type B]
5	L	-[Type A]
5	W	-[Type B]

Connector No.	D182
Connector Name	WIRE TO WIRE
Connector Type	TK12FW

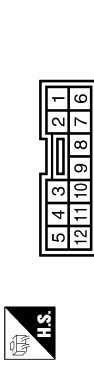

Terminal No.	Color of Wire	Signal Name [Specification]
6	R	-
7	G	-
8	B	-
9	SHIELD	-

Connector No.	D155
Connector Name	WIRE TO WIRE
Connector Type	TK10MW-NS8



Terminal No.	Color of Wire	Signal Name [Specification]
4	O	-[Type A]
4	L	-[Type B]
5	B/P	-[Type A]
5	W	-[Type B]

Connector No.	D106
Connector Name	REAR DOOR SPEAKER RH (WITH BOSE SYSTEM)
Connector Type	NS02FBR-CS



Terminal No.	Color of Wire	Signal Name [Specification]
1	O	-[Type A]
1	L	-[Type B]
2	B/P	-[Type A]
2	W	-[Type B]

Connector No.	D86
Connector Name	REAR DOOR SPEAKER LH (WITH BOSE SYSTEM)
Connector Type	NS02FBR-CS



Terminal No.	Color of Wire	Signal Name [Specification]
1	L	-
2	W	-

JCNWM1863GI

IPOD ADAPTER

[BOSE AUDIO WITHOUT NAVIGATION]

< ECU DIAGNOSIS >

BOSE AUDIO WITHOUT NAVIGATION WITHOUT DVD ENTERTAINMENT SYSTEM

Connector No.	D132
Connector Name	REAR VIEW CAMERA
Connector Type	TH04MW-NH



Terminal No.	Color of Wire	Signal Name [Specification]
1	R	CAMERA ON SIGNAL
2	G	GND
3	B	CAMERA IMAGE SIGNAL
4	SHIELD	SHIELD

Connector No.	E16
Connector Name	WIRE TO WIRE
Connector Type	TK18MGY-1V

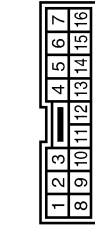

Terminal No.	Color of Wire	Signal Name [Specification]
4	R	-

Connector No.	E16
Connector Name	ECM
Connector Type	RI124FB-R2B-L-LH

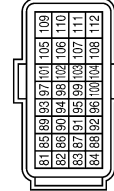

Terminal No.	Color of Wire	Signal Name [Specification]
97	P	VEHCAN-L
98	L	VEHCAN-H

Connector No.	E18
Connector Name	BACK-UP LAMP RELAY
Connector Type	MS02FL-M2-LC

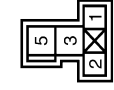

Terminal No.	Color of Wire	Signal Name [Specification]
1	LG	-
2	R	-
3	LG	-
5	R	-

Connector No.	E27
Connector Name	PARKING BRAKE SWITCH
Connector Type	P01FE-A



Terminal No.	Color of Wire	Signal Name [Specification]
1	P	-

Connector No.	E104
Connector Name	WIRE TO WIRE
Connector Type	NS16FW-CS

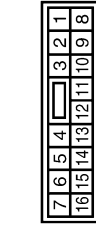

Terminal No.	Color of Wire	Signal Name [Specification]
4	R	-
5	L	-
6	P	-
7	L	-

Connector No.	E105
Connector Name	WIRE TO WIRE
Connector Type	TH10MW-CS10-M3

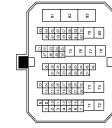

Terminal No.	Color of Wire	Signal Name [Specification]
5	LG	-
22	P	-
47	P	-
48	L	-
75	BR	-
76	GR	-
78	V	-

Connector No.	F23
Connector Name	TOM (TRANSMISSION CONTROL MODULE)
Connector Type	RH40FB-R2B-L-RH

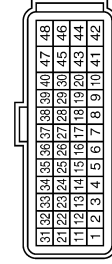

Terminal No.	Color of Wire	Signal Name [Specification]
19	G/B	REV LAMP RELAY

A
B
C
D
E
F
G
H
I
J
K
L
M
N
O
P

AV

JCNWM1864GI

IPOD ADAPTER

[BOSE AUDIO WITHOUT NAVIGATION]

< ECU DIAGNOSIS >

BOSE AUDIO WITHOUT NAVIGATION WITHOUT DVD ENTERTAINMENT SYSTEM

Connector No.	F123
Connector Name	WIRE TO WIRE
Connector Type	TK16GY-IV

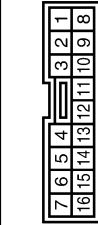

Terminal No.	Color of Wire	Signal Name [Specification]
4	G/B	-

Connector No.	M1
Connector Name	FUSE BLOCK (J/B)
Connector Type	NS0FW-M2

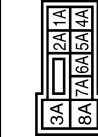

Terminal No.	Color of Wire	Signal Name [Specification]
2A	G	-
5A	R	-

Connector No.	M3
Connector Name	FUSE BLOCK (J/B)
Connector Type	NS12FW-CS

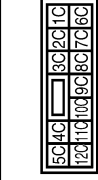

Terminal No.	Color of Wire	Signal Name [Specification]
12C	O	-

Connector No.	M4
Connector Name	DATA LINK CONNECTOR
Connector Type	BD16FW

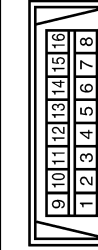

Terminal No.	Color of Wire	Signal Name [Specification]
6	L	-
14	P	-

Connector No.	M11
Connector Name	WIRE TO WIRE
Connector Type	TH10FW-CS10-M3

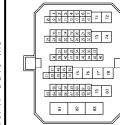

Terminal No.	Color of Wire	Signal Name [Specification]
5	O	-
22	G	-
47	P	-
48	L	-
75	BR	-
76	R	-
78	Y	-

Connector No.	M18
Connector Name	WIRE TO WIRE
Connector Type	TH40MW-CS15

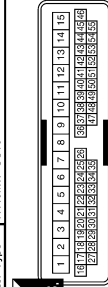

Terminal No.	Color of Wire	Signal Name [Specification]
4	W	-
5	BR	- [Type A and without BOSE system type B] - [With BOSE system type B]
5	B	-

Connector No.	M20
Connector Name	WIRE TO WIRE
Connector Type	TH40MW-CS15

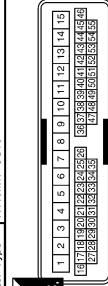

Terminal No.	Color of Wire	Signal Name [Specification]
4	B	-
5	L	-

IPOD ADAPTER

[BOSE AUDIO WITHOUT NAVIGATION]

< ECU DIAGNOSIS >

BOSE AUDIO WITHOUT NAVIGATION WITHOUT DVD ENTERTAINMENT SYSTEM

Connector No.	M22
Connector Name	WIRE TO WIRE
Connector Type	TH12FW-NH

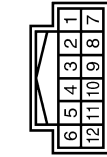

Terminal No.	Color of Wire	Signal Name [Specification]
1	V	-
2	R	-
3	R	-
4	G	-
5	W	-
6	SHIELD	-
7	LG	-
8	SHIELD	-
9	BR	-
10	SHIELD	-
11	L	-

Connector No.	M33
Connector Name	COMBINATION SWITCH (SPIRAL CABLE)
Connector Type	TK08FGY-IV

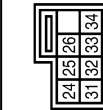

Terminal No.	Color of Wire	Signal Name [Specification]
24	BR	- [With audio steering switch and telephone]
31	G	- [With audio steering switch and telephone]
33	L	- [With audio steering switch and telephone]

12	R	-
----	---	---

Connector No.	M23
Connector Name	WIRE TO WIRE
Connector Type	TH18MW-NH

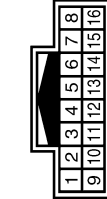

Terminal No.	Color of Wire	Signal Name [Specification]
1	W	-
2	R	- [With telephone without navigation system]
3	B	-
4	SHIELD	-

Connector No.	M34
Connector Name	COMBINATION METER
Connector Type	TH40FW-NH



Terminal No.	Color of Wire	Signal Name [Specification]
21	L	CAN-H
22	P	CAN-L
31	V	VEHICLE SPEED (8-PULSE)

Connector No.	M30
Connector Name	STEERING ANGLE SENSOR
Connector Type	TH08FW-NH

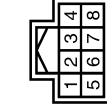

Terminal No.	Color of Wire	Signal Name [Specification]
1	B	-
3	L	-
4	G	-
6	SB	-
8	O	-

Connector No.	M44
Connector Name	WIRE TO WIRE
Connector Type	TH32FW-NH

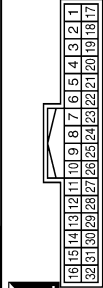

Terminal No.	Color of Wire	Signal Name [Specification]
1	G	-
2	R	-
3	SHIELD	-
4	B	-
5	W	-
6	SHIELD	-
7	O	- [Type A]
7	L	- [Type B]
8	SB	- [Type A]
8	R	- [Type B]
9	SHIELD	-

A
B
C
D
E
F
G
H
I
J
K
L
M
AV
O
P

IPOD ADAPTER

[BOSE AUDIO WITHOUT NAVIGATION]

< ECU DIAGNOSIS >

BOSE AUDIO WITHOUT NAVIGATION WITHOUT DVD ENTERTAINMENT SYSTEM

Connector No.	M49
Connector Name	FRONT DISPLAY UNIT
Connector Type	TH24FW-NH

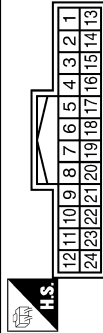

Terminal No.	Color of Wire	Signal Name [Specification]
1	B	GND
2	Y	INVERTER VCC1[Without navigation system]
3	O	SIGNAL VCC1[Without navigation system]
4	P	COMPOSITE IMAGE GND[Without navigation system]
5	SHIELD	SHIELD[Without navigation system]
6	L	RGB (GREEN) SIGNAL[Without navigation system]
7	SHIELD	SHIELD
8	G	HP[Without navigation system]
9	W	RGB AREA (YS) SIGNAL
11	R	COMM (CONT->DISP)
13	BR	INVERTER GND[Without navigation system]

Connector No.	M67
Connector Name	FRONT SQUAWKER RH
Connector Type	TK02FBR

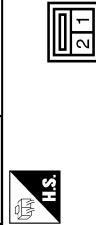

Terminal No.	Color of Wire	Signal Name [Specification]
1	BR	-
2	R	-[With BOSE system]

14	LG	SIGNAL GND[Without navigation system]
15	L	COMPOSITE IMAGE SIGNAL[Without navigation system]
17	G	RGB (RED) SIGNAL
18	Y	RGB (BLUE) SIGNAL[Without navigation system]
19	B	RGB SYNC
20	R	VP
21	SHIELD	SHIELD
22	G	COMM (DISP->CONT)
23	SHIELD	SHIELD

Terminal No.	Color of Wire	Signal Name [Specification]
1	LG	-[With BOSE system]
2	Y	-[With BOSE system]

Terminal No.	Color of Wire	Signal Name [Specification]
43	L	-
44	V	-
45	P	-
46	R	-
47	Y	-
48	L	-
49	G	-
50	SHIELD	-
51	W	-
56	P	-
57	L	-
58	SB	-
59	SHIELD	-
60	B	-
61	R	-
62	W	-
66	L	-
67	R	-
68	G	-
69	SHIELD	-
70	L	-
71	R	-

Terminal No.	Color of Wire	Signal Name [Specification]
1	SHIELD	-
2	B	-
3	W	-
4	R	-
8	SHIELD	-
9	W	-
10	R	-
11	G	-
12	B	-
41	O	-
42	SB	-

Connector No.	M65
Connector Name	CENTER SPEAKER
Connector Type	TK02FBR



Terminal No.	Color of Wire	Signal Name [Specification]
1	P	-
2	O	-

Connector No.	M97
Connector Name	WIRE TO WIRE
Connector Type	TH18FW-CS2

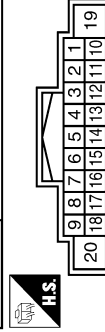

Terminal No.	Color of Wire	Signal Name [Specification]
5	SHIELD	-
6	W	-
8	B	-
9	Y	-
14	R	-
15	B	-
17	SHIELD	-
18	B	-[Type A and With navigation system type B]
18	BR	-[Without navigation system type B]

IPOD ADAPTER

[BOSE AUDIO WITHOUT NAVIGATION]

< ECU DIAGNOSIS >

BOSE AUDIO WITHOUT NAVIGATION WITHOUT DVD ENTERTAINMENT SYSTEM

Connector No.	M122
Connector Name	BCM (BODY CONTROL MODULE)
Connector Type	TH40FB-NH

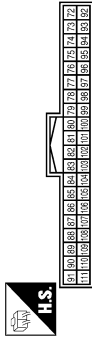

Terminal No.	Color of Wire	Signal Name [Specification]
90	P	CAN-L
91	L	CAN-H

Connector No.	M124
Connector Name	WIRE TO WIRE
Connector Type	NS12FER-CS

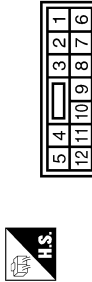

Terminal No.	Color of Wire	Signal Name [Specification]
1	P	-
2	BR	- [Type A]
3	B	- [Type B]
4	Y	-
5	BR	-
6	O	-
7	W	-
8	B	-
9	R	-
10	BR	-

Connector No.	M125
Connector Name	MULTIFUNCTION SWITCH
Connector Type	TH18FW-NH

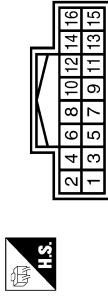

Terminal No.	Color of Wire	Signal Name [Specification]
1	B	GND
3	R	ACC
6	R	AV COMM (H)
8	L	AV COMM (L)
9	V	SW GND
14	W	EJECT SIGNAL

Connector No.	M127
Connector Name	AV CONTROL UNIT (WITH BOSE SYSTEM WITHOUT NAVIGATION SYSTEM)
Connector Type	TH18FW-CS2

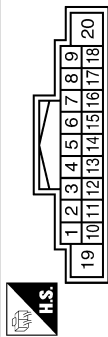

Terminal No.	Color of Wire	Signal Name [Specification]
6	BR	STRG SW A
7	R	ACC
9	R	ILLUMINATION
15	L	STRG SW GND
16	G	STRG SW B
19	Y	BATTERY
20	B	GND

Connector No.	M128
Connector Name	AV CONTROL UNIT (WITH BOSE SYSTEM WITHOUT NAVIGATION SYSTEM)
Connector Type	A12FW

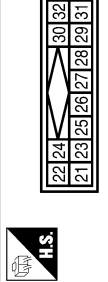

Terminal No.	Color of Wire	Signal Name [Specification]
21	B	SATELLITE RADIO SOUND SIGNAL LH (-)
22	G	SATELLITE RADIO SOUND SIGNAL LH (+)
23	R	SATELLITE RADIO SOUND SIGNAL RH (-)
24	W	SATELLITE RADIO SOUND SIGNAL RH (+)
25	SHIELD	SHIELD
26	SHIELD	SHIELD
28	R	REQUEST (SAT->CONT)
29	W	COMM (SAT->CONT)
30	B	COMM (CONT->SAT)

Connector No.	M129
Connector Name	AV CONTROL UNIT (WITH BOSE SYSTEM WITHOUT NAVIGATION SYSTEM)
Connector Type	TH24FW-NH

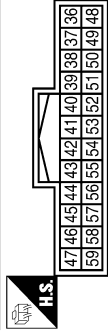

Terminal No.	Color of Wire	Signal Name [Specification]
36	L	COMPOSITE IMAGE SIGNAL
37	P	COMPOSITE IMAGE GND
38	Y	RGB (B/BLUE) SIGNAL
39	L	RGB (G/GREEN) SIGNAL
40	G	RGB (R/RED) SIGNAL
41	B	RGB SYNC
42	SHIELD	SHIELD
43	W	RGB AREA (YS) SIGNAL
44	G	COMM (DISP->CONT)
45	G	HP
46	LG	SIGNAL GND

A
B
C
D
E
F
G
H
I
J
K
L
M
N
O
P

AV

JCNWM1868GI

IPOD ADAPTER

[BOSE AUDIO WITHOUT NAVIGATION]

< ECU DIAGNOSIS >

BOSE AUDIO WITHOUT NAVIGATION WITHOUT DVD ENTERTAINMENT SYSTEM

Connector No.	M130
Connector Name	AV CONTROL UNIT (WITH BOSE SYSTEM WITHOUT NAVIGATION SYSTEM)
Connector Type	TH16FW-NH



67	66	65	64	63	62	61	60
75	74	73	72	71	70	69	68

Terminal No.	Color of Wire	Signal Name [Specification]
64	SHIELD	SHIELD
65	W	CAMERA IMAGE SIGNAL
66	Y	AUX IMAGE SIGNAL [Without DVD player]
68	P	CONNECTION RECOGNITION
73	SHIELD	SHIELD [Without DVD player]
74	B	AUX IMAGE GND [Without DVD player (type A)]
74	BR	AUX IMAGE GND [Without DVD player (type B)]

Connector No.	M132
Connector Name	AV CONTROL UNIT (WITH BOSE SYSTEM WITHOUT NAVIGATION SYSTEM)
Connector Type	TH12FW-NH



114	115	116	117	118	119
108	109	110	111	112	113

Terminal No.	Color of Wire	Signal Name [Specification]
108	V	SOUND SIGNAL REAR RH (+)
109	B	SOUND SIGNAL FRONT RH (+)
110	P	AMP ON SIGNAL
111	SHIELD	SHIELD
112	O	SOUND SIGNAL REAR LH (+) [Type A]
112	L	SOUND SIGNAL REAR LH (+) [Type B]
113	G	SOUND SIGNAL FRONT LH (+)
114	LG	SOUND SIGNAL REAR RH (-)
115	W	SOUND SIGNAL FRONT RH (-)
118	SB	SOUND SIGNAL REAR LH (-) [Type A]
118	R	SOUND SIGNAL REAR LH (-) [Type B]

Connector No.	M131
Connector Name	AV CONTROL UNIT (WITH BOSE SYSTEM WITH NAVIGATION SYSTEM)
Connector Type	TH24FW-NH



71	70	69	68	67	66	65	64	63	62	61	60	59	58	57	56	55	54	53	52	51	50	49	48	47	46	45	44	43	42	41	40	39	38	37	36	35	34	33	32	31	30	29	28	27	26	25	24	23	22	21	20	19	18	17	16	15	14	13	12	11	10	9	8	7	6	5	4	3	2	1
----	----	----	----	----	----	----	----	----	----	----	----	----	----	----	----	----	----	----	----	----	----	----	----	----	----	----	----	----	----	----	----	----	----	----	----	----	----	----	----	----	----	----	----	----	----	----	----	----	----	----	----	----	----	----	----	----	----	----	----	----	----	---	---	---	---	---	---	---	---	---

Terminal No.	Color of Wire	Signal Name [Specification]
79	L	TEL VOICE SIGNAL (-)
80	R	TEL VOICE SIGNAL (+)
81	SHIELD	SHIELD
82	W	iPod SOUND SIGNAL RH (-) [Without DVD player]
83	R	iPod SOUND SIGNAL RH (+) [Without DVD player]
85	B	GND
86	L	CAN-H
87	P	CAN-L
88	R	AV COMM (H)
89	L	AV COMM (L)
90	G	AV COMM (H)

Connector No.	M148
Connector Name	iPod ADAPTER
Connector Type	TH24FW-NH



1	2	3	4	5	6	7	8	9	10	11	12
13	14	15	16	17	18	19	20	21	22	23	24

Terminal No.	Color of Wire	Signal Name [Specification]
1	BR	iPod SOUND SIGNAL LH (+)
2	R	iPod SOUND SIGNAL RH (+)
3	R	ACC
4	L	AV COMM (L)
5	Y	BATTERY
8	W	CHARGE POWER
9	G	COMM (iPod ADAPTER->iPod)
10	R	COMM (iPod->iPod ADAPTER)
11	R	ACCESSORY IDENTIFY
12	V	iPod SOUND SIGNAL RH (+)
13	L	iPod SOUND SIGNAL LH (+)

91	L	AV COMM (L)
95	R	AUX SOUND SIGNAL RH (+)
96	B	AUX SOUND SIGNAL LH (+)
97	W	AUX SOUND SIGNAL GND
98	L	iPod SOUND SIGNAL LH (-) [Without DVD player]
99	BR	iPod SOUND SIGNAL LH (+) [Without DVD player]
100	SHIELD	SHIELD [Without DVD player]
101	V	SW GND
103	W	EJECT SIGNAL
104	G	IGNITION
105	SB	REVERSE
106	G	PARKING BRAKE
107	V	VEHICLE SPEED (8-PULSE)

14	W	iPod SOUND SIGNAL RH (-)
15	SHIELD	SHIELD
16	R	AV COMM (H)
17	SHIELD	GND
19	SHIELD	SHIELD
21	L	iPod CONNECTION RECOGNITION
22	BR	ACCESSORY DETECT
23	R	iPod SOUND SIGNAL GND
24	LG	iPod SOUND SIGNAL LH (+)

IPOD ADAPTER

[BOSE AUDIO WITHOUT NAVIGATION]

< ECU DIAGNOSIS >

BOSE AUDIO WITHOUT NAVIGATION WITHOUT DVD ENTERTAINMENT SYSTEM

Connector No.	M253
Connector Name	AUXILIARY INPUT JACKS
Connector Type	A08FW



Terminal No.	Color of Wire	Signal Name [Specification]
1	R	SOUND SIGNAL RH (+)
2	W	SOUND SIGNAL GND
3	B	SOUND SIGNAL LH (-) [Without DVD player]
7	G	AUX IMAGE SIGNAL
8	R	AUX IMAGE GND [Without DVD player]

Connector No.	M251
Connector Name	WIRE TO WIRE
Connector Type	TH1BMW-CS2



Terminal No.	Color of Wire	Signal Name [Specification]
5	SHIELD	-
6	W	-
8	SHIELD	-
9	G	-
14	R	-
15	B	-
18	R	-

12	R	-
----	---	---



Terminal No.	Color of Wire	Signal Name [Specification]
1	V	-
2	R	-
3	R	-
4	G	-
5	W	-
6	SHIELD	-
7	LG	-
8	SHIELD	-
9	BR	-
10	SHIELD	-
11	L	-

Connector No.	M275
Connector Name	WIRE TO WIRE
Connector Type	GT13SH-2/1S-HU



Terminal No.	Color of Wire	Signal Name [Specification]
1	-	-
2	-	-
3	-	-

Connector No.	M370
Connector Name	AV CONTROL UNIT (WITH BOSE SYSTEM WITHOUT NAVIGATION SYSTEM)
Connector Type	GT135C-2/1S-HU



Terminal No.	Color of Wire	Signal Name [Specification]
33	-	FM SUB
34	-	AM-FM MAIN
35	-	ANTENNA AMP. ON SIGNAL

Connector No.	M303
Connector Name	COMBINATION SWITCH (SPIRAL CABLE)
Connector Type	TK08FGY



Terminal No.	Color of Wire	Signal Name [Specification]
14	-	-
15	-	-
17	-	-

Connector No.	M260
Connector Name	iPod SIDE
Connector Type	IP18FGY



Terminal No.	Color of Wire	Signal Name [Specification]
1	LG	iPod SOUND SIGNAL LH (+)
2	R	iPod SOUND SIGNAL GND
5	R	COMM (iPod->iPod ADAPTER)
6	G	COMM (iPod ADAPTER->iPod)
7	V	iPod SOUND SIGNAL RH (+)
9	L	iPod CONNECTION RECOGNITION GND
10	SHIELD	CHARGE POWER
12	W	SHIELD
14	SHIELD	ACCESSORY DETECT
15	BR	ACCESSORY DETECT
16	R	ACCESSORY IDENTITY

JCNWM1870GI

A
B
C
D
E
F
G
H
I
J
K
L
M
N
O
P

AV

IPOD ADAPTER

[BOSE AUDIO WITHOUT NAVIGATION]

< ECU DIAGNOSIS >

BOSE AUDIO WITHOUT NAVIGATION WITHOUT DVD ENTERTAINMENT SYSTEM

Connector No.	M376
Connector Name	WIRE TO WIRE
Connector Type	GT13SCW-2/1PP-HU



Terminal No.	Color of Wire	Signal Name [Specification]
1	-	-
2	-	-
3	-	-

Connector No.	M378
Connector Name	ANTENNA BASE (ANTENNA AMP.)
Connector Type	GT13SSN-1/1PP-HU

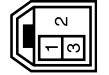

Terminal No.	Color of Wire	Signal Name [Specification]
1	-	-
3	-	-

Connector No.	M379
Connector Name	GLASS ANTENNA
Connector Type	GT13SSN-1/1PP-HU



Terminal No.	Color of Wire	Signal Name [Specification]
2	-	FM SUB

Connector No.	R1
Connector Name	WIRE TO WIRE
Connector Type	TH16FW-NH

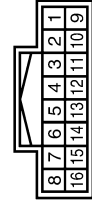

Terminal No.	Color of Wire	Signal Name [Specification]
1	R/W	-
2	R/L	- [With telephones without navigation system]
3	B	-
4	SHIELD	-

Connector No.	R20
Connector Name	MICROPHONE
Connector Type	TK04FW



Terminal No.	Color of Wire	Signal Name [Specification]
1	R/W	MICROPHONE SIGNAL (+)
2	R/L	MICROPHONE SIGNAL (-) [Only telephones without navigation system]
4	B	MICROPHONE POWER

JCNWM1871GI

Wiring Diagram - BOSE AUDIO WITHOUT NAVIGATION WITH DVD ENTERTAINMENT SYSTEM -

INFOID:000000003702918

NOTE:

IPOD ADAPTER

[BOSE AUDIO WITHOUT NAVIGATION]

< ECU DIAGNOSIS >

In this section, PRESET SWITCH and MULTIFUNCTION SWITCH are written as the MULTIFUNCTION SWITCH.

BOSE AUDIO WITHOUT NAVIGATION WITH DVD ENTERTAINMENT SYSTEM

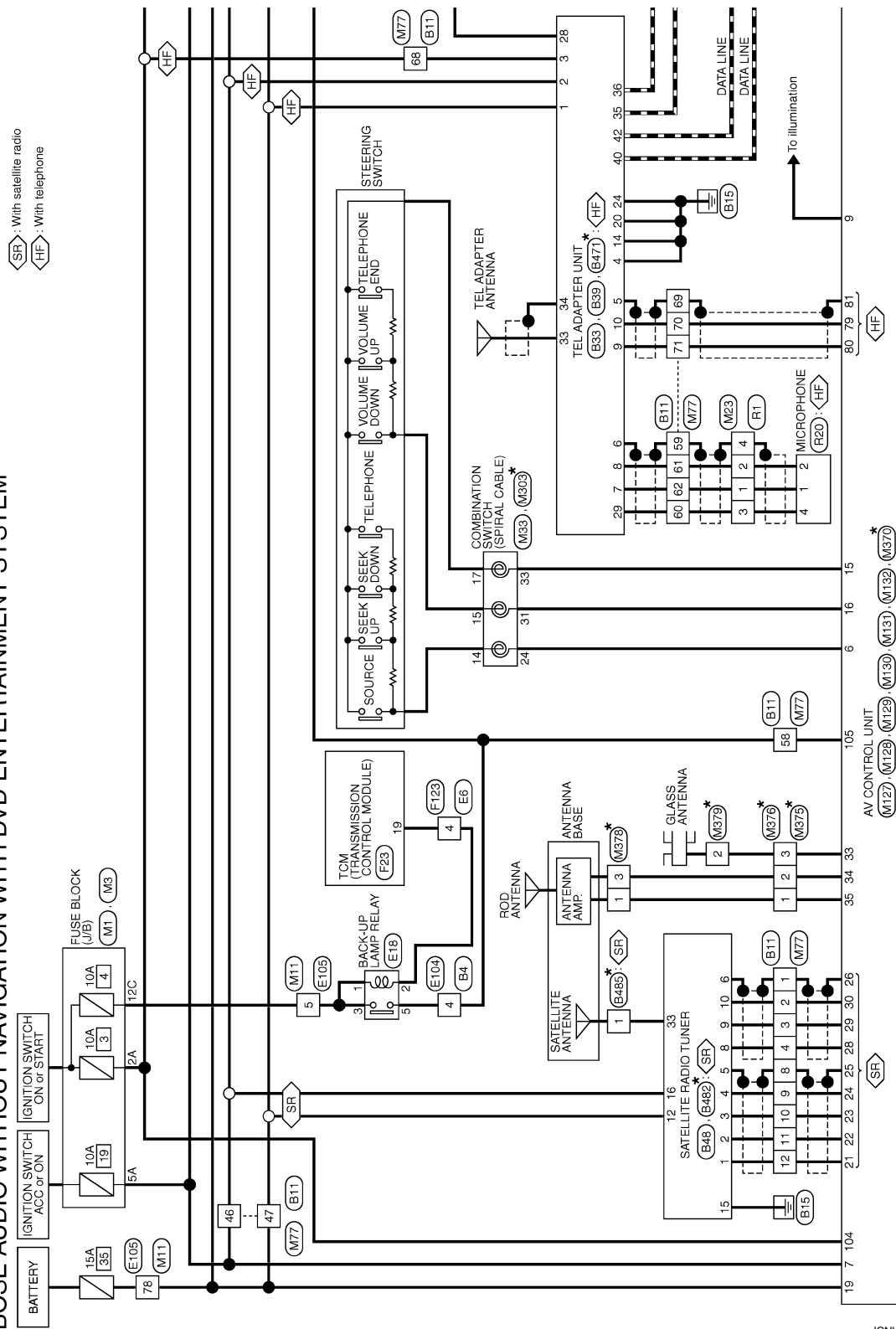

*: This connector is not shown in "Harness Layout".

2008/09/23

JCNWM1872GI

A
B
C
D
E
F
G
H
I
J
K
L
M
N
O
P

AV

IPOD ADAPTER

[BOSE AUDIO WITHOUT NAVIGATION]

< ECU DIAGNOSIS >

- : With iPod
- : With telephone
- : Without telephone

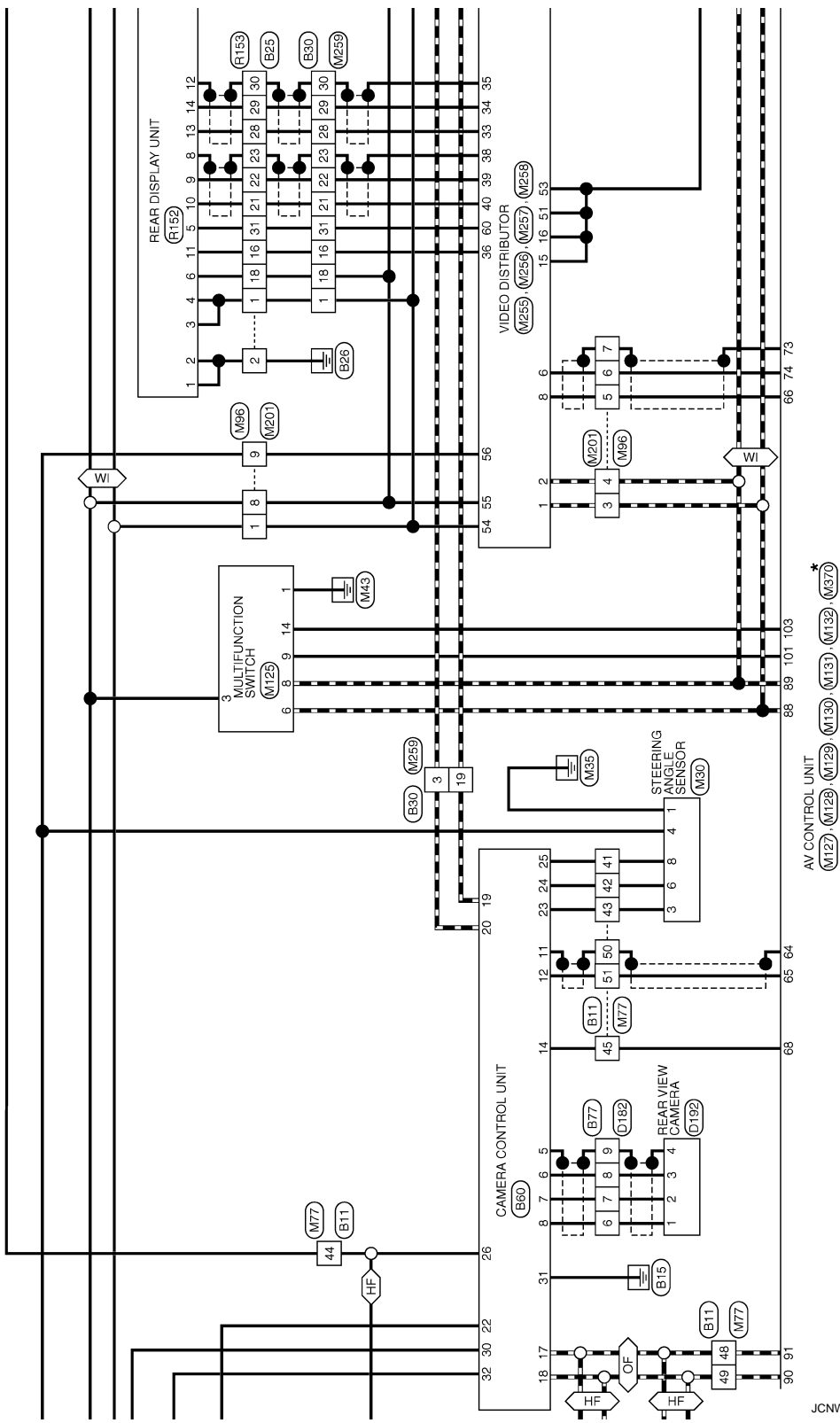

*: This connector is not shown in "Harness Layout".

IPOD ADAPTER

[BOSE AUDIO WITHOUT NAVIGATION]

< ECU DIAGNOSIS >

WI: With iPod

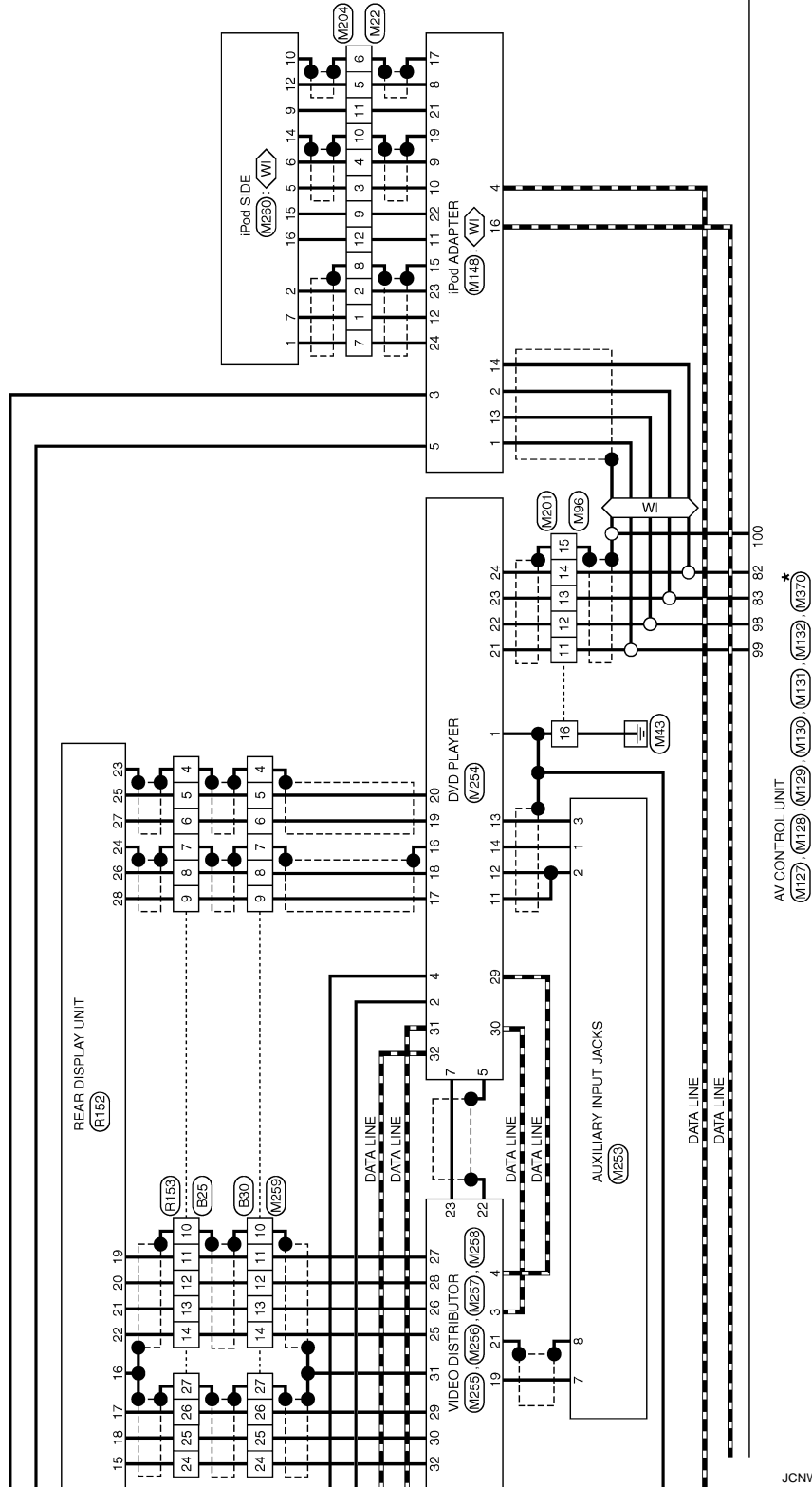

*: This connector is not shown in "Harness Layout".

JCNWM1874GI

A
B
C
D
E
F
G
H
I
J
K
L
M
N
O
P

AV

IPOD ADAPTER

[BOSE AUDIO WITHOUT NAVIGATION]

< ECU DIAGNOSIS >

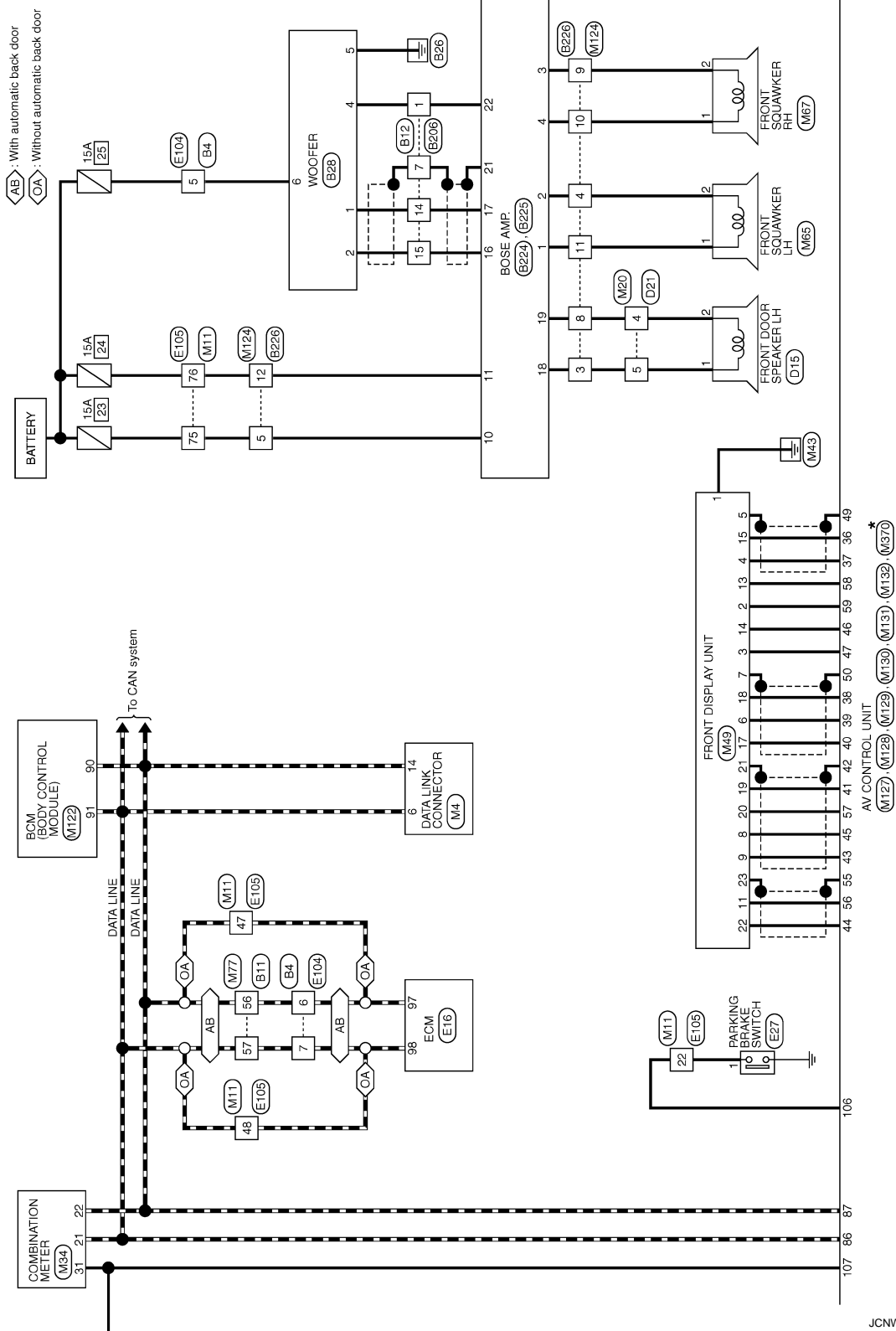

*: This connector is not shown in "Harness Layout".

JCNWM1875GI

IPOD ADAPTER

[BOSE AUDIO WITHOUT NAVIGATION]

< ECU DIAGNOSIS >

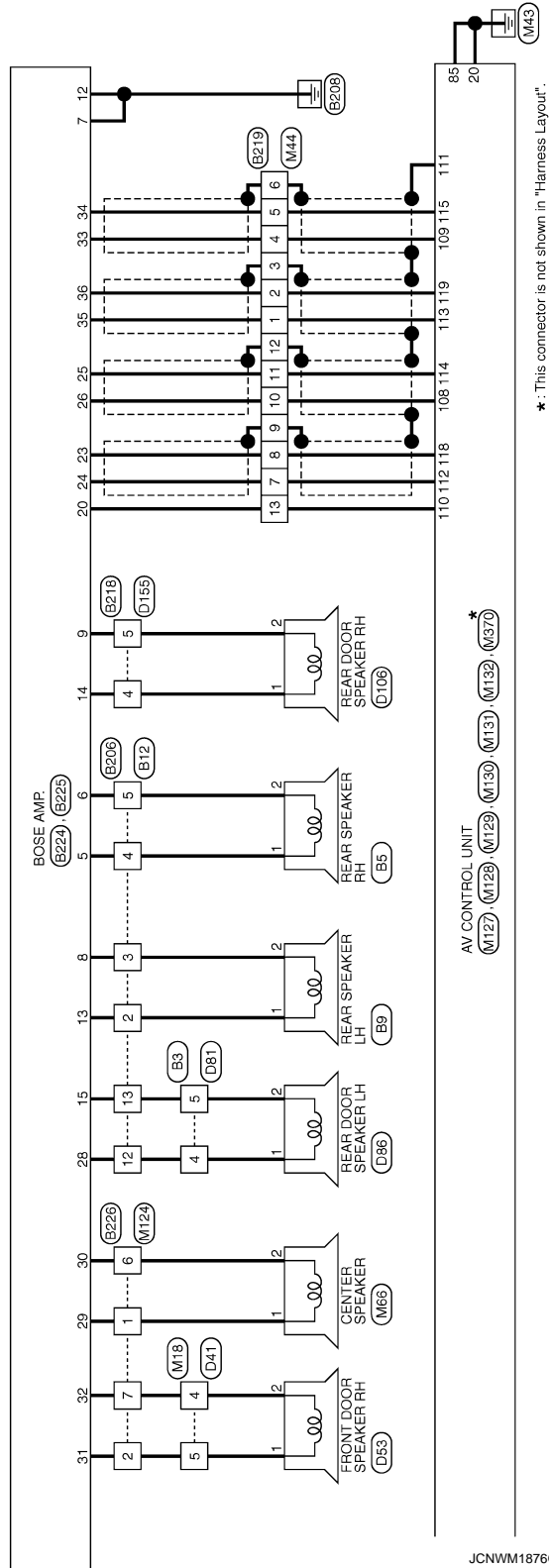

A
B
C
D
E
F
G
H
I
J
K
L
M
N
O
P

AV

IPOD ADAPTER

[BOSE AUDIO WITHOUT NAVIGATION]

< ECU DIAGNOSIS >

BOSE AUDIO WITHOUT NAVIGATION WITH DVD ENTERTAINMENT SYSTEM

Connector No.	B3
Connector Name	WIRE TO WIRE
Connector Type	TK10FW-NS8



Terminal No.	Color of Wire	Signal Name [Specification]
4	LG	-
5	O	-

Connector No.	B4
Connector Name	WIRE TO WIRE
Connector Type	NS16MW-CS

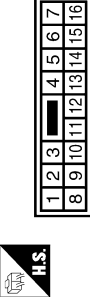

Terminal No.	Color of Wire	Signal Name [Specification]
4	R	-
5	O	-
6	P	-
7	L	-

Connector No.	B5
Connector Name	REAR SPEAKER RH
Connector Type	TK02FBR



Terminal No.	Color of Wire	Signal Name [Specification]
1	V	-
2	LG	-

Connector No.	B9
Connector Name	REAR SPEAKER LH
Connector Type	TK02FBR



Terminal No.	Color of Wire	Signal Name [Specification]
1	SB	-
2	GR	-

Connector No.	B11
Connector Name	WIRE TO WIRE
Connector Type	TH80MW-CS19

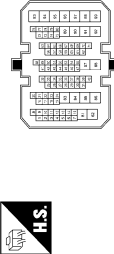

Terminal No.	Color of Wire	Signal Name [Specification]
1	SHIELD	-
2	B	-
3	R/L	-
4	R/W	-
8	SHIELD	-
9	BR/L	-
10	Y/G	-
11	Y/L	-
12	W/L	-
41	O	-
42	SB	-

43	G	-
44	BR	-
45	L	-
46	GR	-
47	V	-
48	GR	- [With rear view camera and telephone]
48	BR	- [With rear view camera without telephone]
49	Y	-
50	SHIELD	-
51	B	-
56	P	-
57	L	-
58	R	-
59	SHIELD	-
60	B	-
61	R/L	-
62	R/W	-
68	R	-
69	SHIELD	-
70	W/R	-
71	B/R	-

Connector No.	B12
Connector Name	WIRE TO WIRE
Connector Type	NS16FW-CS

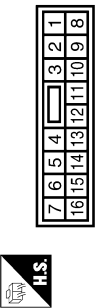

Terminal No.	Color of Wire	Signal Name [Specification]
1	W	-
2	SB	-
3	GR	-
4	V	-
5	LG	-
7	SHIELD	-
12	LG	-
13	O	-
14	W/R	-
15	B/R	-

IPOD ADAPTER

[BOSE AUDIO WITHOUT NAVIGATION]

< ECU DIAGNOSIS >

BOSE AUDIO WITHOUT NAVIGATION WITH DVD ENTERTAINMENT SYSTEM

Connector No.	B25
Connector Name	WIRE TO WIRE
Connector Type	TH22MW-NH



1	2	3	4	5	6	7	8	9	10	11	12	13	14	15	16
17	18	19	20	21	22	23	24	25	26	27	28	29	30	31	32

Terminal No.	Color of Wire	Signal Name [Specification]
1	SB	-
2	B	-
4	SHIELD	-
5	W/R	-
6	W/L	-
7	SHIELD	-
8	GR/V	-
9	W/L	-
10	SHIELD	-
11	W/L	-
12	Y/G	-

Connector No.	B30
Connector Name	WIRE TO WIRE
Connector Type	TH22FW-NH



16	15	14	13	12	11	10	9	8	7	6	5	4	3	2	1
32	31	30	29	28	27	26	25	24	23	22	21	20	19	18	17

Terminal No.	Color of Wire	Signal Name [Specification]
1	SB	-
3	G	-
4	SHIELD	-
5	W/R	-
6	W/L	-
7	SHIELD	-
8	GR/V	-
9	W/L	-
10	SHIELD	-
11	W/L	-
12	Y/G	-

13	Y/L	-
14	BR/L	-
16	V	-
18	O	-
21	B/R	-
22	W/R	-
23	SHIELD	-
24	B	-
25	R/L	-
26	R/W	-
27	SHIELD	-
28	B	-
29	W	-
30	SHIELD	-
31	P	-

Connector No.	B28
Connector Name	WOOFER
Connector Type	RS28FGY-PR



Terminal No.	Color of Wire	Signal Name [Specification]
1	W/R	SOUND SIGNAL WOOFER (-)
2	B/R	SOUND SIGNAL WOOFER (+)
4	W	WOOFER AMP ON SIGNAL
5	B/W	GND
6	O	BAT

Connector No.	B33
Connector Name	TEL ADAPTER UNIT
Connector Type	TH33FW-NH

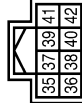

Terminal No.	Color of Wire	Signal Name [Specification]
35	Y	AV COMM (H)
36	BR	AV COMM (L)
40	G	AV COMM (H)
42	GR	AV COMM (L)

JCNWM1878GI

A
B
C
D
E
F
G
H
I
J
K
L
M
N
O
P

AV

IPOD ADAPTER

[BOSE AUDIO WITHOUT NAVIGATION]

< ECU DIAGNOSIS >

BOSE AUDIO WITHOUT NAVIGATION WITH DVD ENTERTAINMENT SYSTEM

Connector No.	B39
Connector Name	TEL ADAPTER UNIT
Connector Type	TH22FW-NH

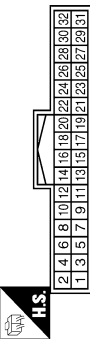

Terminal No.	Color of Wire	Signal Name [Specification]
1	V	BATTERY
2	GR	ACC
3	R	IGNITION
4	B/W	GND
5	SHIELD	SHIELD
6	SHIELD	SHIELD
7	R/W	MICROPHONE SIGNAL
8	R/L	MICROPHONE GND
9	B/R	TEL VOICE SIGNAL (+)
10	W/R	TEL VOICE SIGNAL (-)
14	B	GND

Connector No.	B80
Connector Name	CAMERA CONTROL UNIT
Connector Type	TH22FW-NH

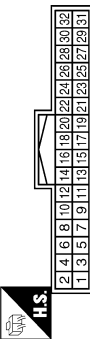

Terminal No.	Color of Wire	Signal Name [Specification]
5	SHIELD	SHIELD
6	B	CAMERA IMAGE SIGNAL
7	R/W	GND
8	R/L	CAMERA ON SIGNAL
11	SHIELD	SHIELD
12	B	CAMERA IMAGE SIGNAL
14	L	CONNECTION RECOGNITION
17	BR	AV COMM (L)
18	Y	AV COMM (H)
19	GR	AV COMM (L)
20	G	AV COMM (H)

Connector No.	B48
Connector Name	SATELLITE RADIO TUNER
Connector Type	A16FW

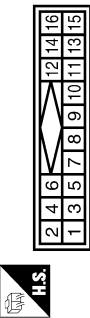

Terminal No.	Color of Wire	Signal Name [Specification]
1	W/L	SOUND SIGNAL LH (-)
2	Y/L	SOUND SIGNAL LH (+)
3	Y/G	SOUND SIGNAL RH (-)
4	BR/L	SOUND SIGNAL RH (+)
5	SHIELD	SHIELD
6	SHIELD	SHIELD
8	R/W	REQUEST (SAT->CONT)
9	R/L	COMM (SAT->CONT)
10	B	COMM (CONT->SAT)
12	V	BATTERY
15	B	GND

Connector No.	B77
Connector Name	WIRE TO WIRE
Connector Type	TK2MW



Terminal No.	Color of Wire	Signal Name [Specification]
6	R/L	-
7	R/W	-
8	B	-
9	SHIELD	-

16	GR	ACC
----	----	-----

Connector No.	B206
Connector Name	WIRE TO WIRE
Connector Type	NS16MW-CS



Terminal No.	Color of Wire	Signal Name [Specification]
1	W	-
2	GR	-
3	BR	-
4	Y	-
5	BR	-
7	SHIELD	-
12	G	-
13	R	-
14	W/R	-
15	B/R	-

IPOD ADAPTER

[BOSE AUDIO WITHOUT NAVIGATION]

< ECU DIAGNOSIS >

BOSE AUDIO WITHOUT NAVIGATION WITH DVD ENTERTAINMENT SYSTEM

Connector No.	B218
Connector Name	WIRE TO WIRE
Connector Type	TK10FW-ANS

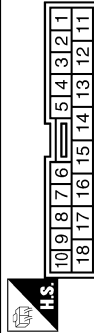

Connector No.	B219
Connector Name	WIRE TO WIRE
Connector Type	TH32MP-NH



Terminal No.	Color of Wire	Signal Name [Specification]
4	L	[With BOSE system]
5	O	[With BOSE system]

Terminal No.	Color of Wire	Signal Name [Specification]
1	W/R	
2	B/R	
3	SHIELD	
4	W/R	
5	B/R	
6	SHIELD	
7	GR/V	
8	W/L	
9	SHIELD	
10	GR/V	
11	W/L	

Connector No.	B224
Connector Name	BOSE AMP.
Connector Type	SGA12FBR-SJAZ

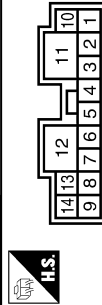

Connector No.	B225
Connector Name	BOSE AMP.
Connector Type	SCA19FBR-SGA4

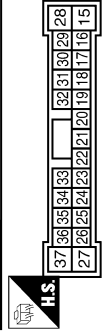

Terminal No.	Color of Wire	Signal Name [Specification]
1	LG	SOUND SIGNAL FRONT SQUAWKER LH (+)
2	V	SOUND SIGNAL FRONT SQUAWKER LH (-)
3	L	SOUND SIGNAL FRONT SQUAWKER RH (-)
4	P	SOUND SIGNAL FRONT SQUAWKER RH (+)
5	Y	SOUND SIGNAL REAR SPEAKER RH (+)
6	BR	SOUND SIGNAL REAR SPEAKER RH (-)
7	B	GND
8	BR	SOUND SIGNAL REAR SPEAKER LH (-)
9	O	SOUND SIGNAL REAR DOOR SPEAKER RH (-)
10	SB	BATTERY
11	GR	BATTERY

Terminal No.	Color of Wire	Signal Name [Specification]
15	R	SOUND SIGNAL REAR DOOR SPEAKER LH (-)
16	B/R	SOUND SIGNAL WOOFER (+)
17	W/R	SOUND SIGNAL WOOFER (-)
18	W	SOUND SIGNAL FRONT DOOR SPEAKER LH (-)
19	B	SOUND SIGNAL FRONT DOOR SPEAKER LH (+)
20	SB	AMP. ON SIGNAL
21	SHIELD	SHIELD
22	W	WOOFER AMP. ON SIGNAL
23	W/L	SOUND SIGNAL REAR LH (-)
24	GR/V	SOUND SIGNAL REAR LH (+)
25	W/L	SOUND SIGNAL REAR RH (-)

12	SHIELD
13	SB

26	GR/V	SOUND SIGNAL REAR RH (+)
28	G	SOUND SIGNAL REAR DOOR SPEAKER LH (+)
29	V	SOUND SIGNAL CENTER SPEAKER (+)
30	P	SOUND SIGNAL CENTER SPEAKER (-)
31	BR	SOUND SIGNAL FRONT DOOR SPEAKER RH (+)
32	Y	SOUND SIGNAL FRONT DOOR SPEAKER RH (-)
33	W/R	SOUND SIGNAL FRONT RH (+)
34	B/R	SOUND SIGNAL FRONT RH (-)
35	W/R	SOUND SIGNAL FRONT LH (-)
36	B/R	SOUND SIGNAL FRONT LH (+)

JCNWM1880GI

A
B
C
D
E
F
G
H
I
J
K
L
M
N
O
P

AV

IPOD ADAPTER

< ECU DIAGNOSIS >

[BOSE AUDIO WITHOUT NAVIGATION]

BOSE AUDIO WITHOUT NAVIGATION WITH DVD ENTERTAINMENT SYSTEM

Connector No.	B226
Connector Name	WIRE TO WIRE
Connector Type	NS2MBR-CS

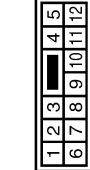

Terminal No.	Color of Wire	Signal Name [Specification]
1	V	
2	BR	
3	W	
4	V	
5	SB	
6	P	
7	Y	
8	B	
9	L	
10	P	
11	LG	

Connector No.	B465
Connector Name	ANTENNA BASE (SATELLITE ANTENNA) WITH BOSE SYSTEM WITHOUT NAVIGATION SYSTEM
Connector Type	GT16C-1PP-HU



Terminal No.	1	Color of Wire	-	Signal Name [Specification]	SATELLITE ANTENNA
--------------	---	---------------	---	-----------------------------	-------------------

12	GR	-
----	----	---

Connector No.	B471
Connector Name	TEL ADAPTER UNIT
Connector Type	GT16C-1S-HU



Terminal No.	33	Color of Wire	-	Signal Name [Specification]	TEL ANTENNA
	34	SHIELD	-	SHIELD	

Connector No.	D21
Connector Name	WIRE TO WIRE
Connector Type	TH40FW-CS15

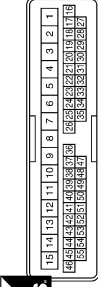

Terminal No.	4	Color of Wire	B/W	Signal Name [Specification]	-[Type A]
	4	B	-	-[Type B]	
	5	L	-	-[Type A]	
	5	W	-	-[Type B]	

Connector No.	B482
Connector Name	SATELLITE RADIO TUNER
Connector Type	FAK6A



Terminal No.	33	Color of Wire	-	Signal Name [Specification]	SATELLITE ANTENNA
--------------	----	---------------	---	-----------------------------	-------------------

Connector No.	D41
Connector Name	WIRE TO WIRE
Connector Type	TH40FW-CS15

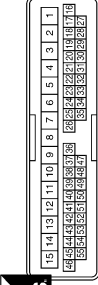

Terminal No.	4	Color of Wire	B/R	Signal Name [Specification]	-[Type A]
	4	B	-	-[Type B]	
	5	BR	-	-[Type A]	
	5	W	-	-[Type B]	

JCNWM1881GI

IPOD ADAPTER

[BOSE AUDIO WITHOUT NAVIGATION]

< ECU DIAGNOSIS >

BOSE AUDIO WITHOUT NAVIGATION WITH DVD ENTERTAINMENT SYSTEM

Connector No.	D153
Connector Name	FRONT DOOR SPEAKER RH (WITH BOSE SYSTEM)
Connector Type	NS2ZFER-CS



Terminal No.	Color of Wire	Signal Name [Specification]
1	BR	- [Type A]
1	W	- [Type B]
2	B/R	- [Type A]
2	B	- [Type B]

Connector No.	D181
Connector Name	WIRE TO WIRE
Connector Type	TK10MW-NS3

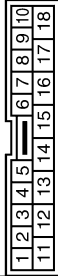

Terminal No.	Color of Wire	Signal Name [Specification]
4	L	-
5	W	-

Connector No.	D198
Connector Name	REAR DOOR SPEAKER LH (WITH BOSE SYSTEM)
Connector Type	NS2ZFER-CS



Terminal No.	Color of Wire	Signal Name [Specification]
1	L	-
2	W	-

Connector No.	D106
Connector Name	REAR DOOR SPEAKER RH (WITH BOSE SYSTEM)
Connector Type	NS2ZFER-CS



Terminal No.	Color of Wire	Signal Name [Specification]
1	O	- [Type A]
1	L	- [Type B]
2	B/P	- [Type A]
2	W	- [Type B]

Connector No.	D155
Connector Name	WIRE TO WIRE
Connector Type	TK10MW-NS3

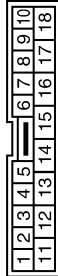

Terminal No.	Color of Wire	Signal Name [Specification]
4	O	- [Type A]
4	L	- [Type B]
5	B/P	- [Type A]
5	W	- [Type B]

Connector No.	D182
Connector Name	WIRE TO WIRE
Connector Type	TK12FW

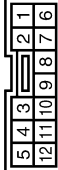

Terminal No.	Color of Wire	Signal Name [Specification]
6	R	-
7	G	-
8	B	-
9	SHIELD	-

Connector No.	D192
Connector Name	REAR VIEW CAMERA
Connector Type	TK16MGY-TV



Terminal No.	Color of Wire	Signal Name [Specification]
1	R	CAMERA ON SIGNAL
2	G	GND
3	B	CAMERA IMAGE SIGNAL
4	SHIELD	SHIELD

Connector No.	EB
Connector Name	WIRE TO WIRE
Connector Type	TK16MGY-TV



Terminal No.	Color of Wire	Signal Name [Specification]
4	R	-

JCNWM1882GI

A
B
C
D
E
F
G
H
I
J
K
L
M
O
P

AV

IPOD ADAPTER

[BOSE AUDIO WITHOUT NAVIGATION]

< ECU DIAGNOSIS >

BOSE AUDIO WITHOUT NAVIGATION WITH DVD ENTERTAINMENT SYSTEM

Connector No.	E18
Connector Name	ECM
Connector Type	RH24FB-R28-L-LH

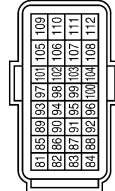

Terminal No.	Color of Wire	Signal Name [Specification]
97	P	VEHGAN-L
98	L	VEHGAN-H

Connector No.	E18
Connector Name	BACK-UP LAMP RELAY
Connector Type	MS02FL-M2-LC

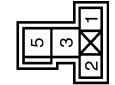

Terminal No.	Color of Wire	Signal Name [Specification]
1	LG	-
2	R	-
3	LG	-
5	R	-

Connector No.	E27
Connector Name	PARKING BRAKE SWITCH
Connector Type	F01FB-A



Terminal No.	Color of Wire	Signal Name [Specification]
1	P	-

Connector No.	E104
Connector Name	WIRE TO WIRE
Connector Type	NS36FW-CS

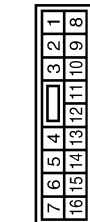

Terminal No.	Color of Wire	Signal Name [Specification]
4	R	-
5	L	-
6	P	-
7	L	-

Connector No.	E105
Connector Name	WIRE TO WIRE
Connector Type	TH70MW-CS10-M3

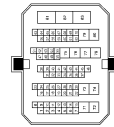

Terminal No.	Color of Wire	Signal Name [Specification]
5	LG	-
22	P	-
47	P	-
48	L	-
75	BR	-
76	GR	-
78	V	-

Connector No.	F23
Connector Name	TCM (TRANSMISSION CONTROL MODULE)
Connector Type	RH40FB-R26-L-RH

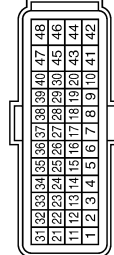

Terminal No.	Color of Wire	Signal Name [Specification]
19	G/B	REV LAMP RELAY

Connector No.	F123
Connector Name	WIRE TO WIRE
Connector Type	TK6FGY-1V

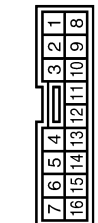

Terminal No.	Color of Wire	Signal Name [Specification]
4	G/B	-

Connector No.	M1
Connector Name	FUSE BLOCK (J/B)
Connector Type	NS00FW-M2

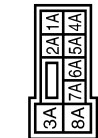

Terminal No.	Color of Wire	Signal Name [Specification]
2A	G	-
5A	R	-

IPOD ADAPTER

[BOSE AUDIO WITHOUT NAVIGATION]

< ECU DIAGNOSIS >

BOSE AUDIO WITHOUT NAVIGATION WITH DVD ENTERTAINMENT SYSTEM

Connector No.	M3
Connector Name	FUSE BLOCK (J/B)
Connector Type	HS12FW-CS

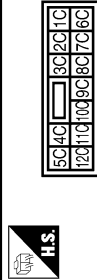

Terminal No.	Color of Wire	Signal Name [Specification]
12C	O	-

Connector No.	M4
Connector Name	DATA LINK CONNECTOR
Connector Type	BD16FW

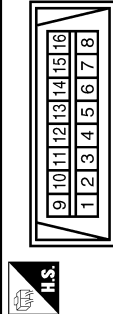

Terminal No.	Color of Wire	Signal Name [Specification]
6	L	-
14	P	-

Connector No.	M11
Connector Name	WIRE TO WIRE
Connector Type	TH10FW-CS10-M3

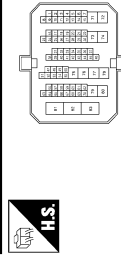

Terminal No.	Color of Wire	Signal Name [Specification]
5	O	-
22	G	-
47	P	-
48	L	-
75	BR	-
76	R	-
78	Y	-

Connector No.	M18
Connector Name	WIRE TO WIRE
Connector Type	TH40MW-CS15

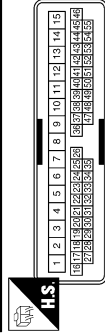

Terminal No.	Color of Wire	Signal Name [Specification]
4	W	-
5	BR	- [Type A and without BOSE system type B]
5	B	- [With BOSE system type B]

Connector No.	M20
Connector Name	WIRE TO WIRE
Connector Type	TH40MW-CS15

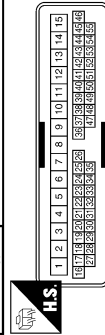

Terminal No.	Color of Wire	Signal Name [Specification]
4	B	-
5	L	-

Connector No.	M22
Connector Name	WIRE TO WIRE
Connector Type	TH12FW-NH

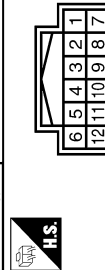

Terminal No.	Color of Wire	Signal Name [Specification]
1	V	-
2	R	-
3	R	-
4	G	-
5	W	-
6	SHIELD	-
7	LG	-
8	SHIELD	-
9	BR	-
10	SHIELD	-
11	L	-

Connector No.	M23
Connector Name	WIRE TO WIRE
Connector Type	TH16MW-NH

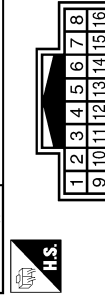

Terminal No.	Color of Wire	Signal Name [Specification]
1	W	-
2	R	- [With telephone without navigation system]
3	B	-
4	SHIELD	-

JCNWM1884GI

A
B
C
D
E
F
G
H
I
J
K
L
M
N
O
P

AV

IPOD ADAPTER

[BOSE AUDIO WITHOUT NAVIGATION]

< ECU DIAGNOSIS >

BOSE AUDIO WITHOUT NAVIGATION WITH DVD ENTERTAINMENT SYSTEM

Connector No.	M30
Connector Name	STEERING ANGLE SENSOR
Connector Type	TH08FW-NH

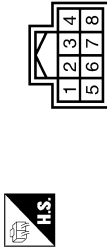

Terminal No.	Color of Wire	Signal Name [Specification]
1	B	-
3	L	-
4	G	-
6	SB	-
8	O	-

Connector No.	M33
Connector Name	COMBINATION SWITCH (SPIRAL CABLE)
Connector Type	TH08FGY-1V

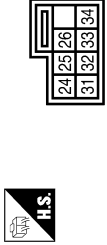

Terminal No.	Color of Wire	Signal Name [Specification]
24	BR	- [With audio steering switch and telephone]
31	G	- [With audio steering switch and telephone]
33	L	- [With audio steering switch and telephone]

Connector No.	M34
Connector Name	COMBINATION METER
Connector Type	TH40FW-NH

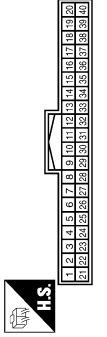

Terminal No.	Color of Wire	Signal Name [Specification]
21	L	CAN-H
22	P	CAN-L
31	V	VEHICLE SPEED (8-PULSE)

Connector No.	M44
Connector Name	WIRE TO WIRE
Connector Type	TH42FW-NH

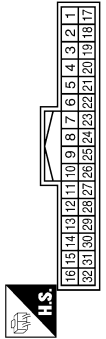

Terminal No.	Color of Wire	Signal Name [Specification]
1	G	-
2	R	-
3	SHIELD	-
4	B	-
5	W	-
6	SHIELD	-
7	O	- [Type A]
7	L	- [Type B]
8	SB	- [Type A]
8	R	- [Type B]
9	SHIELD	-

Terminal No.	10	V	-
11	LG	-	-
12	SHIELD	-	-
13	P	-	-

Connector No.	M49
Connector Name	FRONT DISPLAY UNIT
Connector Type	TH24FW-NH

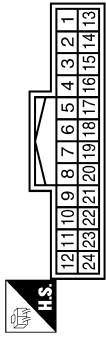

Terminal No.	Color of Wire	Signal Name [Specification]
1	B	GND
2	Y	INVERTER VCCI (Without navigation system)
3	O	SIGNAL VCCI (Without navigation system)
4	P	COMPOSITE IMAGE GND (Without navigation system)
5	SHIELD	SHIELD (Without navigation system)
6	L	RGB (GREEN) SIGNAL (Without navigation system)
7	SHIELD	SHIELD
8	G	HP (Without navigation system)
9	W	RGB AREA (YS) SIGNAL
11	R	COMM (CONT->DISP)
13	BR	INVERTER GND (Without navigation system)

14	LG	SIGNAL GND (Without navigation system)
15	L	COMPOSITE IMAGE SIGNAL (Without navigation system)
17	G	RGB (RED) SIGNAL
18	Y	RGB (BLUE) SIGNAL (Without navigation system)
19	B	RGB SYNC
20	R	VP
21	SHIELD	SHIELD
22	G	COMM (DISP->CONT)
23	SHIELD	SHIELD

JCNWM1885GI

IPOD ADAPTER

[BOSE AUDIO WITHOUT NAVIGATION]

< ECU DIAGNOSIS >

BOSE AUDIO WITHOUT NAVIGATION WITH DVD ENTERTAINMENT SYSTEM

Connector No.	M65
Connector Name	FRONT SQUAWKER LH
Connector Type	TK02FBR



Terminal No.	Color of Wire	Signal Name [Specification]
1	LG	[With BOSE system]
2	Y	[With BOSE system]

Connector No.	M66
Connector Name	CENTER SPEAKER
Connector Type	TK02FBR



Terminal No.	Color of Wire	Signal Name [Specification]
1	P	-
2	O	-

Connector No.	M67
Connector Name	FRONT SQUAWKER RH
Connector Type	TK02FBR



Terminal No.	Color of Wire	Signal Name [Specification]
1	BR	-
2	R	[With BOSE system]

Connector No.	M77
Connector Name	WIRE TO WIRE
Connector Type	TH80FW-C519

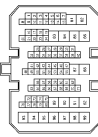

Terminal No.	Color of Wire	Signal Name [Specification]
1	SHIELD	-
2	B	-
3	W	-
4	R	-
8	SHIELD	-
9	W	-
10	R	-
11	G	-
12	B	-
41	O	-
42	SB	-

43	L	-
44	V	-
45	P	-
46	R	-
47	Y	-
48	L	-
49	G	-
50	SHIELD	-
51	W	-
56	P	-
57	L	-
58	SS	-
59	SHIELD	-
60	B	-
61	R	-
62	W	-
68	G	-
69	SHIELD	-
70	L	-
71	R	-

Connector No.	M66
Connector Name	WIRE TO WIRE
Connector Type	TH18FW-NH

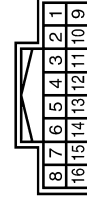

Terminal No.	Color of Wire	Signal Name [Specification]
1	Y	-
3	R	-
4	L	-
5	L	-
6	R	-
7	SHIELD	-
8	R	-
9	G	-
11	B	-
12	G	-
13	R	-

14	W	-
15	SHIELD	-
16	B	-

A
B
C
D
E
F
G
H
I
J
K
L
M
N
O
P

AV

JCNWM1886G1

IPOD ADAPTER

[BOSE AUDIO WITHOUT NAVIGATION]

< ECU DIAGNOSIS >

BOSE AUDIO WITHOUT NAVIGATION WITH DVD ENTERTAINMENT SYSTEM

Connector No.	M122
Connector Name	BCM BODY CONTROL MODULE
Connector Type	TH40FB-NH

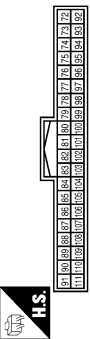

Terminal No.	Color of Wire	Signal Name [Specification]
90	P	CAN-L
91	L	CAN-H

Connector No.	M124
Connector Name	WIRE TO WIRE
Connector Type	NS12FBR-CS



Terminal No.	Color of Wire	Signal Name [Specification]
1	P	-
2	BR	- [Type A]
3	B	- [Type B]
4	Y	-
5	BR	-
6	O	-
7	W	-
8	B	-
9	R	-
10	BR	-

Connector No.	M127
Connector Name	AV CONTROL UNIT (WITH BOSE SYSTEM WITHOUT NAVIGATION SYSTEM)
Connector Type	TH18FW-CS2

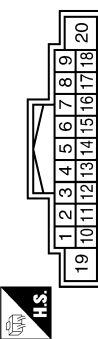

Terminal No.	Color of Wire	Signal Name [Specification]
6	BR	STRG SW A
7	R	ACC
9	R	ILLUMINATION
15	L	STRG SW GND
16	G	STRG SW B
19	Y	BATTERY
20	B	GND

Connector No.	M128
Connector Name	AV CONTROL UNIT (WITH BOSE SYSTEM WITHOUT NAVIGATION SYSTEM)
Connector Type	A12FW

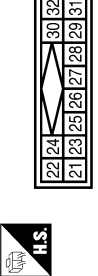

Terminal No.	Color of Wire	Signal Name [Specification]
21	B	SATELLITE RADIO SOUND SIGNAL LH (-)
22	G	SATELLITE RADIO SOUND SIGNAL LH (+)
23	R	SATELLITE RADIO SOUND SIGNAL RH (-)
24	W	SATELLITE RADIO SOUND SIGNAL RH (+)
25	SHIELD	SHIELD
26	SHIELD	SHIELD
28	R	REQUEST (SAT->CONT)
29	W	COMM (SAT->CONT)
30	B	COMM (CONT->SAT)

11	LG
12	R

Connector No.	M125
Connector Name	MULTIFUNCTION SWITCH
Connector Type	TH16FW-NH

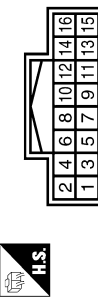

Terminal No.	Color of Wire	Signal Name [Specification]
1	B	GND
3	R	ACC
6	R	AV COMM (H)
8	L	AV COMM (L)
9	V	SW GND
14	W	EJECT SIGNAL

Connector No.	M129
Connector Name	AV CONTROL UNIT (WITH BOSE SYSTEM WITHOUT NAVIGATION SYSTEM)
Connector Type	TH24FW-NH

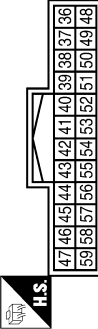

Terminal No.	Color of Wire	Signal Name [Specification]
36	L	COMPOSITE IMAGE SIGNAL
37	P	COMPOSITE IMAGE GND
38	Y	RGB (B/BLUE) SIGNAL
39	L	RGB (G/GREEN) SIGNAL
40	G	RGB (R/RED) SIGNAL
41	B	RGB SYNC
42	SHIELD	SHIELD
43	W	RGB AREA (YS) SIGNAL
44	G	COMM (DISP->CONT)
45	G	HP
46	LG	SIGNAL GND

Terminal No.	Color of Wire	Signal Name [Specification]
47	O	SIGNAL VCC
49	SHIELD	SHIELD
50	SHIELD	SHIELD
55	SHIELD	SHIELD
56	R	COMM (CONT->DISP)
57	R	VP
58	BR	INVERTER GND
59	Y	INVERTER VCC

IPOD ADAPTER

[BOSE AUDIO WITHOUT NAVIGATION]

< ECU DIAGNOSIS >

BOSE AUDIO WITHOUT NAVIGATION WITH DVD ENTERTAINMENT SYSTEM

Connector No.	M130
Connector Name	AV CONTROL UNIT (WITH BOSE SYSTEM WITHOUT NAVIGATION SYSTEM)
Connector Type	TH116FW-NH



67	66	65	64	63	62	61	60
75	74	73	72	71	70	69	68

Connector No.	M131
Connector Name	AV CONTROL UNIT (WITH BOSE SYSTEM WITHOUT NAVIGATION SYSTEM)
Connector Type	TH122FW-NH



91	90	89	88	87	86	85	84	83	82	81	80	79	78	77	76
107	106	105	104	103	102	101	100	99	98	97	96	95	94	93	92

91	L	AV COMM (L)
98	G	SOUND SIGNAL LH (-) [With DVD player]
99	B	SOUND SIGNAL LH (+) [With DVD player]
100	SHIELD	SHIELD [With DVD player]
101	V	SW GND
103	W	EJECT SIGNAL
104	G	IGNITION
105	SB	REVERSE
106	G	PARKING BRAKE
107	V	VEHICLE SPEED (8-PULSE)

Terminal No.	Color of Wire	Signal Name [Specification]
64	SHIELD	SHIELD
65	W	CAMERA IMAGE SIGNAL
66	L	COMPOSITE IMAGE SIGNAL [With DVD player]
68	P	CONNECTION RECOGNITION
72	SHIELD	SHIELD [With DVD player]
74	R	COMPOSITE IMAGE GND [With DVD player]

Connector No.	M132
Connector Name	AV CONTROL UNIT (WITH BOSE SYSTEM WITHOUT NAVIGATION SYSTEM)
Connector Type	TH121FW-NH



114	115	116	117	118	119
108	109	110	111	112	113

Terminal No.	Color of Wire	Signal Name [Specification]
79	L	TEL VOICE SIGNAL (-)
80	R	TEL VOICE SIGNAL (+)
81	SHIELD	SHIELD
82	W	SOUND SIGNAL RH (-) [With DVD player]
83	R	SOUND SIGNAL RH (+) [With DVD player]
85	B	GND
86	L	CAN-H
87	P	CAN-L
88	R	AV COMM (H)
89	L	AV COMM (L)
90	G	AV COMM (H)

119	R	SOUND SIGNAL FRONT LH (-)
-----	---	---------------------------

Connector No.	M148
Connector Name	IPOD ADAPTER
Connector Type	TH224FW-NH



1	2	3	4	5	6	7	8	9	10	11	12
13	14	15	16	17	18	19	20	21	22	23	24

14	W	iPod SOUND SIGNAL RH (-)
15	SHIELD	SHIELD
16	R	AV COMM (H)
17	SHIELD	GND
19	SHIELD	SHIELD
21	L	iPod CONNECTION RECOGNITION
22	BR	ACCESSORY DETECT
23	R	iPod SOUND SIGNAL GND
24	LG	iPod SOUND SIGNAL LH (+)

Terminal No.	Color of Wire	Signal Name [Specification]
108	V	SOUND SIGNAL REAR RH (+)
109	B	SOUND SIGNAL FRONT RH (+)
110	P	AMP. ON SIGNAL
111	SHIELD	SHIELD
112	O	SOUND SIGNAL REAR LH (+) [Type A]
112	L	SOUND SIGNAL REAR LH (+) [Type B]
113	G	SOUND SIGNAL FRONT LH (+)
114	LG	SOUND SIGNAL REAR RH (-)
115	W	SOUND SIGNAL FRONT RH (-)
118	SB	SOUND SIGNAL REAR LH (-) [Type A]
118	R	SOUND SIGNAL REAR LH (-) [Type B]

Terminal No.	Color of Wire	Signal Name [Specification]
1	BR	iPod SOUND SIGNAL LH (+)
2	R	iPod SOUND SIGNAL RH (+)
3	R	ACC
4	L	AV COMM (L)
5	Y	BATTERY
8	W	CHARGE POWER
9	G	COMM (iPod ADAPTER->iPod)
10	R	COMM (iPod->iPod ADAPTER)
11	R	ACCESSORY IDENTIFY
12	V	iPod SOUND SIGNAL RH (+)
13	L	iPod SOUND SIGNAL LH (-)

JCNWM1888GI

A
B
C
D
E
F
G
H
I
J
K
L
M
N
O
P

AV

IPOD ADAPTER

[BOSE AUDIO WITHOUT NAVIGATION]

< ECU DIAGNOSIS >

BOSE AUDIO WITHOUT NAVIGATION WITH DVD ENTERTAINMENT SYSTEM

Connector No.	M201	W	-
Connector Name	WIRE TO WIRE	SHIELD	-
Connector Type	TH16MW-NH	B	-

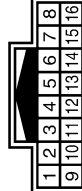

Terminal No.	Color of Wire	Signal Name [Specification]
1	Y	-
2	R	-
3	R	-
4	G	-
5	L	-
6	R	-
7	SHIELD	-
8	V	-
9	G	-
11	B	-
12	G	-
13	R	-

Connector No.	M254	DVD PLAYER
Connector Name	DVD PLAYER	
Connector Type	TH32FW-NH	

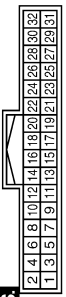

Terminal No.	Color of Wire	Signal Name [Specification]
1	R	SOUND SIGNAL RH (+)
2	W	SOUND SIGNAL GND
3	G	SOUND SIGNAL LH (-) [With DVD player]
7	G	AUX IMAGE SIGNAL SHIELD [With DVD player]

Terminal No.	Color of Wire	Signal Name [Specification]
1	B	GND
2	Y	BATTERY
4	V	ACC
5	SHIELD	SHIELD
7	P	DVD IMAGE SIGNAL
11	B	AUX SOUND SIGNAL LH (-)
12	W	AUX SOUND SIGNAL LH (+)
13	G	AUX SOUND SIGNAL RH (+)
14	R	AUX SOUND SIGNAL RH (-)
16	SHIELD	SHIELD
17	G	HEADPHONE SOUND SIGNAL LH (+)

Connector No.	M204	WIRE TO WIRE
Connector Name	WIRE TO WIRE	
Connector Type	TH12MW-NH	

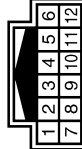

Terminal No.	Color of Wire	Signal Name [Specification]
1	V	-
2	R	-
3	R	-
4	G	-
5	W	-
6	SHIELD	-
7	LG	-
8	SHIELD	-
9	BR	-
10	SHIELD	-
11	L	-
12	L	-

Connector No.	M255	VIDEO DISTRIBUTOR
Connector Name	VIDEO DISTRIBUTOR	
Connector Type	TH08FW-NH	



Terminal No.	Color of Wire	Signal Name [Specification]
18	R	HEADPHONE SOUND SIGNAL LH (-)
19	V	HEADPHONE SOUND SIGNAL RH (+)
20	LG	HEADPHONE SOUND SIGNAL RH (-)
21	B	SOUND SIGNAL LH (+)
22	G	SOUND SIGNAL LH (-)
23	R	SOUND SIGNAL RH (+)
24	W	SOUND SIGNAL RH (-)
29	L	AV COMM (L)
30	R	AV COMM (H)
31	L	AV COMM (L)
32	R	AV COMM (H)

Terminal No.	Color of Wire	Signal Name [Specification]
53	B	GND
54	Y	BATTERY
55	V	ACC
56	G	IGNITION
60	R	HEADPHONE ON SIGNAL

IPOD ADAPTER

[BOSE AUDIO WITHOUT NAVIGATION]

< ECU DIAGNOSIS >

BOSE AUDIO WITHOUT NAVIGATION WITH DVD ENTERTAINMENT SYSTEM

Connector No.	M256
Connector Name	VIDEO DISTRIBUTOR
Connector Type	TH12FW-NH



26	28	30	32	34	36	38	40
25	27	29	31	33	35	37	39



Connector No.	M257
Connector Name	VIDEO DISTRIBUTOR
Connector Type	TH11FW-NH



26	28	30	32	34	36	38	40
25	27	29	31	33	35	37	39



36	G	IGNITION
38	SHIELD	SHIELD
39	V	COMM (DISP->DISP)
40	LG	COMM (DISP->DISP)

Terminal No.	Color of Wire	Signal Name [Specification]
51	B	GND

Terminal No.	Color of Wire	Signal Name [Specification]
25	R	RGB (R/RED) SIGNAL
26	L	RGB (G/GREEN) SIGNAL
27	W	RGB GND
28	G	RGB (B/BLUE) SIGNAL
29	R	YP
30	W	HP
31	SHIELD	SHIELD
32	B	RGB AREA (Y/S) SIGNAL
33	G	COMPOSITE SYNC
34	R	COMPOSITE IMAGE SIGNAL
35	SHIELD	SHIELD

Connector No.	M258
Connector Name	VIDEO DISTRIBUTOR
Connector Type	TH12FW-NH

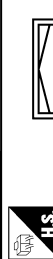

2	4	6	8	10	12	14	16	18	20	22	24
1	3	5	7	9	11	13	15	17	19	21	23



Terminal No.	Color of Wire	Signal Name [Specification]
1	R	AV COMM (H)
2	G	AV COMM (L)
3	R	AV COMM (H)
4	L	AV COMM (L)
6	R	COMPOSITE IMAGE GND
8	L	COMPOSITE IMAGE SIGNAL
15	B	GND
16	B	GND
19	G	AUX IMAGE SIGNAL
21	SHIELD	SHIELD
22	SHIELD	SHIELD

Connector No.	M259
Connector Name	WIRES TO WIRE
Connector Type	TH32MW-NH



1	2	3	4	5	6	7	8	9	10	11	12	13	14	15	16
17	18	19	20	21	22	23	24	25	26	27	28	29	30	31	32

Terminal No.	Color of Wire	Signal Name [Specification]
1	Y	-
3	R	-
4	SHIELD	-
5	LG	-
6	V	-
7	SHIELD	-
8	R	-
9	G	-
10	SHIELD	-
11	W	-
12	G	-

13	L	-
14	R	-
16	G	-
18	V	-
19	L	-
21	LG	-
22	V	-
23	SHIELD	-
24	B	-
25	W	-
26	R	-
27	SHIELD	-
28	G	-
29	R	-
30	SHIELD	-
31	R	-

A
B
C
D
E
F
G
H
I
J
K
L
M
N
O
P

AV

IPOD ADAPTER

[BOSE AUDIO WITHOUT NAVIGATION]

< ECU DIAGNOSIS >

BOSE AUDIO WITHOUT NAVIGATION WITH DVD ENTERTAINMENT SYSTEM

Connector No.	M376
Connector Name	IPOD SIDE
Connector Type	IP16FGY

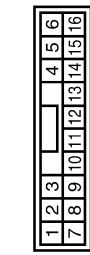

Terminal No.	Color of Wire	Signal Name [Specification]
1	LG	iPod SOUND SIGNAL LH (+)
2	R	iPod SOUND SIGNAL LH (-)
5	R	COMM (iPod->iPod ADAPTER)
6	G	COMM (iPod ADAPTER->iPod)
7	V	iPod SOUND SIGNAL RH (+)
8	L	iPod SOUND SIGNAL RH (-)
9	—	iPod CONNECTION RECOGNITION GND
10	SHIELD	—
12	W	CHARGE POWER
14	SHIELD	SHIELD
15	BR	ACCESSORY DETECT
16	R	ACCESSORY IDENTIFY

Connector No.	M376
Connector Name	WIRES TO WIRE
Connector Type	GT13SCN-2/1PP-HU



Terminal No.	Color of Wire	Signal Name [Specification]
1	—	—
2	—	—
3	—	—

Connector No.	M303
Connector Name	COMBINATION SWITCH (SPIRAL CABLE)
Connector Type	TK08FGY



Terminal No.	Color of Wire	Signal Name [Specification]
14	—	—
15	—	—
17	—	—

Connector No.	M378
Connector Name	ANTENNA BASE (ANTENNA AMP.)
Connector Type	GT13SSN-1/1PP-HU

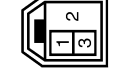

Terminal No.	Color of Wire	Signal Name [Specification]
1	—	—
3	—	—

Connector No.	M370
Connector Name	AV CONTROL UNIT (WITH BOSE SYSTEM WITHOUT NAVIGATION SYSTEM)
Connector Type	GT13SC-2/1S-HU



Terminal No.	Color of Wire	Signal Name [Specification]
33	—	FM SUB
34	—	AM-FM MAIN
35	—	ANTENNA AMP. ON SIGNAL

Connector No.	M379
Connector Name	GLASS ANTENNA
Connector Type	GT13SCN-1/1PP-HU



Terminal No.	Color of Wire	Signal Name [Specification]
2	—	FM SUB

Connector No.	M375
Connector Name	WIRES TO WIRE
Connector Type	GT13SH-2/1S-HU

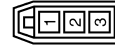

Terminal No.	Color of Wire	Signal Name [Specification]
1	—	—
2	—	—
3	—	—

Connector No.	FT
Connector Name	WIRES TO WIRE
Connector Type	TH16FW-NH

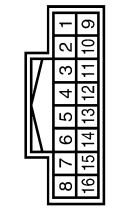

Terminal No.	Color of Wire	Signal Name [Specification]
1	R/W	—
2	R/L	— [With telephones without navigation system]
3	B	—
4	SHIELD	—

JCNWM1891GI

IPOD ADAPTER

[BOSE AUDIO WITHOUT NAVIGATION]

< ECU DIAGNOSIS >

BOSE AUDIO WITHOUT NAVIGATION WITH DVD ENTERTAINMENT SYSTEM

Connector No.	R20
Connector Name	MICROPHONE
Connector Type	TH2FW-NH



Terminal No.	Color of Wire	Signal Name [Specification]
1	R/W	MICROPHONE SIGNAL (+)
2	R/L	MICROPHONE SIGNAL (-) (Only in vehicle with navigation system)
4	B	MICROPHONE POWER

Connector No.	R152
Connector Name	REAR DISPLAY UNIT
Connector Type	TH2FW-NH



Terminal No.	Color of Wire	Signal Name [Specification]
1	B	GND
2	B	GND
3	Y/R	BATTERY
4	Y/R	BATTERY
5	R	HEADPHONE ON SIGNAL
6	V/Y	ACC
8	SHIELD	SHIELD
9	V	COMM (DISP->DISP)
10	LG	COMM (DISP->DISP)
11	G	IGNITION
12	SHIELD	SHIELD

Connector No.	R153
Connector Name	WIRE TO WIRE
Connector Type	TH2FW-NH



Terminal No.	Color of Wire	Signal Name [Specification]
1	Y/R	-
2	B	-
4	SHIELD	-
5	LG	-
6	V	-
7	SHIELD	-
8	BR	-
9	Y	-
10	SHIELD	-
11	W/L	-
12	Y/G	-

13	G	COMPOSITE SYNC
14	R	COMPOSITE IMAGE SIGNAL
15	B	RGB AREA (V/S) SIGNAL
16	SHIELD	GND
17	R	VP
18	W	HP
19	W/L	RGB GND
20	Y/G	RGR (B/BLUE) SIGNAL
21	Y/L	RGB (G/GREEN) SIGNAL
22	BR/L	RGB (R/RED) SIGNAL
23	SHIELD	SHIELD
24	SHIELD	SHIELD
25	LG	HEADPHONE SOUND SIGNAL RH (-)
26	BR	HEADPHONE SOUND SIGNAL LH (-)
27	V	HEADPHONE SOUND SIGNAL RH (+)
28	Y	HEADPHONE SOUND SIGNAL LH (+)

13	Y/L	-
14	BR/L	-
16	G	-
18	V/Y	-
21	LG	-
22	V	-
23	SHIELD	-
24	B	-
25	W	-
26	R	-
27	SHIELD	-
28	G	-
29	R	-
30	SHIELD	-
31	R	-

A
B
C
D
E
F
G
H
I
J
K
L
M
N
O
P

AV

JCNWM1892GI

TEL ADAPTER UNIT

[BOSE AUDIO WITHOUT NAVIGATION]

< ECU DIAGNOSIS >

TEL ADAPTER UNIT

Reference Values

INFOID:000000003356840

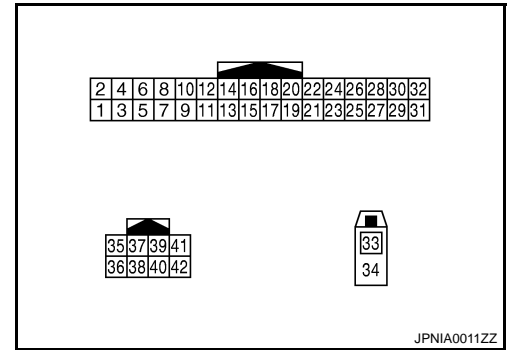

PHYSICAL VALUES

Terminal (Wire color)		Description		Condition		Reference value (Approx.)
+	-	Signal name	Input/ Output			
1 (V)	Ground	Battery power supply	Input	Ignition switch OFF	—	Battery voltage
2 (GR)	Ground	ACC power supply	Input	Ignition switch ACC	—	Battery voltage
3 (R)	Ground	Ignition signal	Input	Ignition switch ON	—	Battery voltage
4 (B/W)	Ground	ground	—	Ignition switch ON	—	0 V
5	—	Shield	—	—	—	—
6	—	Shield	—	—	—	—
7 (R/w)	8 (R/L)	Microphone signal	Input	Ignition switch ON	Give a voice	<p>PKIB5037J</p>
8 (R/L)	Ground	Microphone GND	—	Ignition switch ON	—	0 V
9 (B/R)	10 (W/R)	TEL voice signal	Output	Ignition switch ON	During voice guide output with the switch pressed	<p>SKIB3609E</p>

TEL ADAPTER UNIT

[BOSE AUDIO WITHOUT NAVIGATION]

< ECU DIAGNOSIS >

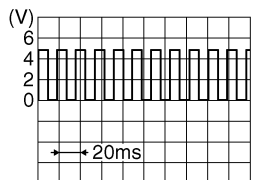
Terminal (Wire color)		Description		Condition		Reference value (Approx.)
+	-	Signal name	Input/ Output			
14 (B)	Ground	GND	—	Ignition switch ON	—	0 V
20 (B)	Ground	Control signal	Input	Ignition switch ON	—	0 V
24 (B/W)	Ground	Control signal	Input	Ignition switch ON	—	0 V
28 (BR)	Ground	Vehicle speed signal (8-pulse)	Input	Ignition switch ON	When vehicle speed is ap- prox. 40 km/h (25MPH)	NOTE: Maximum voltage may be 12 V due to specifications (connected units). 
29 (B)	Ground	Microphone VCC	Output	Ignition switch ON	—	5.0 V
33	—	TEL antenna	Input	—	—	—
34	—	Shield	—	—	—	—
35 (Y)	—	AV communication signal (H)	Input/ Output	—	—	—
36 (BR)	—	AV communication signal (L)	Input/ Output	—	—	—
40 (G)	—	AV communication signal (H)	Input/ Output	—	—	—
42 (GR)	—	AV communication signal (L)	Input/ Output	—	—	—

Wiring Diagram - BOSE AUDIO WITHOUT NAVIGATION WITHOUT DVD ENTERTAINMENT SYSTEM -

INFOID:000000003702919

NOTE:

- In this section, PRESET SWITCH and MULTIFUNCTION SWITCH are written as the MULTIFUNCTION SWITCH.
- Type A: Up to VIN: JN8AZ18U*9W100000, JN8AZ18W*9W200000 (EXCEPT FOR MEXICO), JN8AZ18U*9W710000, JN8AZ18W*9W810000 (FOR MEXICO)

AV

O

P

TEL ADAPTER UNIT

[BOSE AUDIO WITHOUT NAVIGATION]

< ECU DIAGNOSIS >

- Type B: From VIN: JN8AZ18U*9W10001, JN8AZ18W*9W20001 (EXCEPT FOR MEXICO), JN8AZ18U*9W710001, JN8AZ18W*9W810001 (FOR MEXICO)

BOSE AUDIO WITHOUT NAVIGATION WITHOUT DVD ENTERTAINMENT SYSTEM

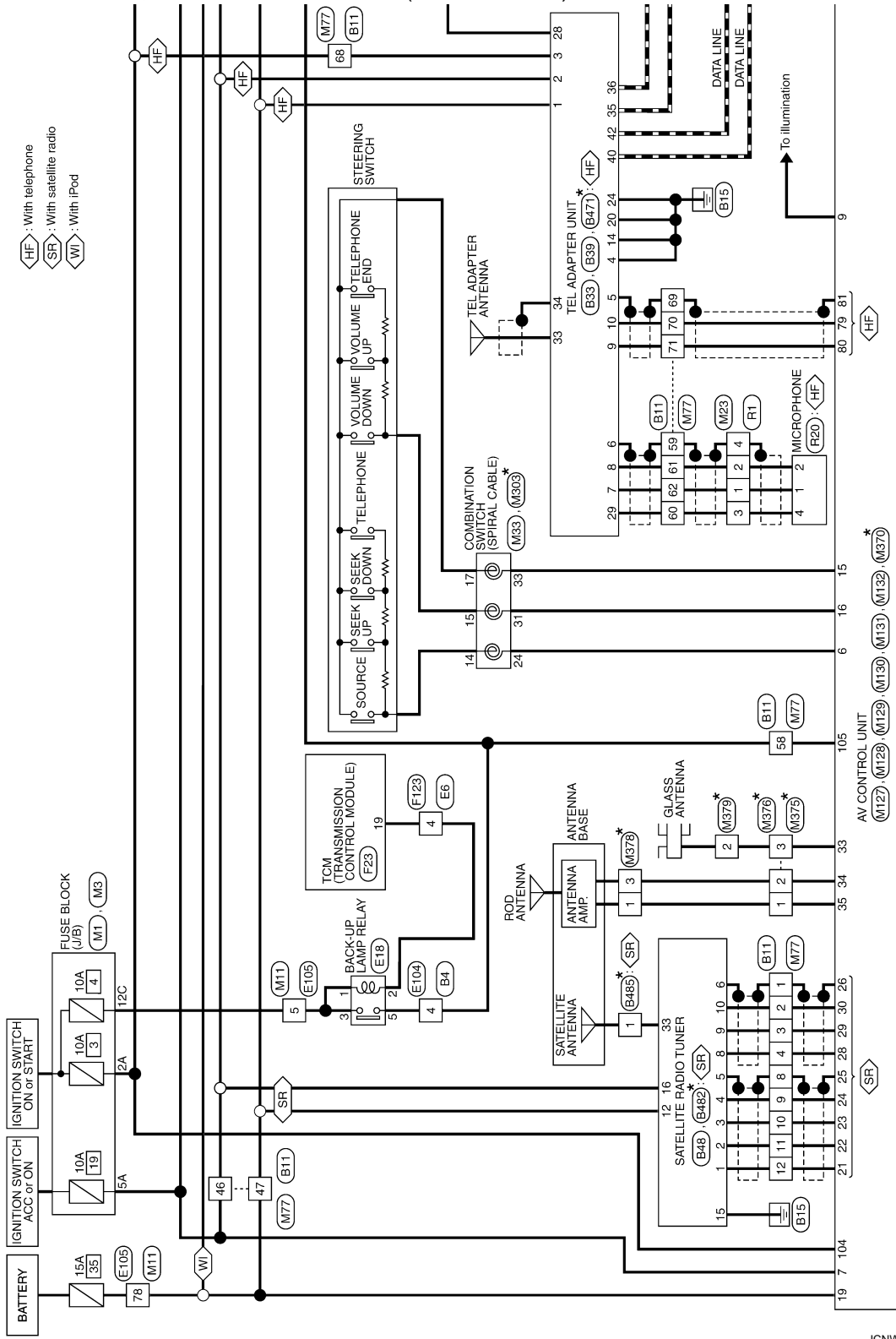

*: This connector is not shown in "Harness Layout".

2008/09/23

JCNWM1855GI

TEL ADAPTER UNIT

[BOSE AUDIO WITHOUT NAVIGATION]

< ECU DIAGNOSIS >

- HF : With telephone
- OF : Without telephone
- WI : With iPod

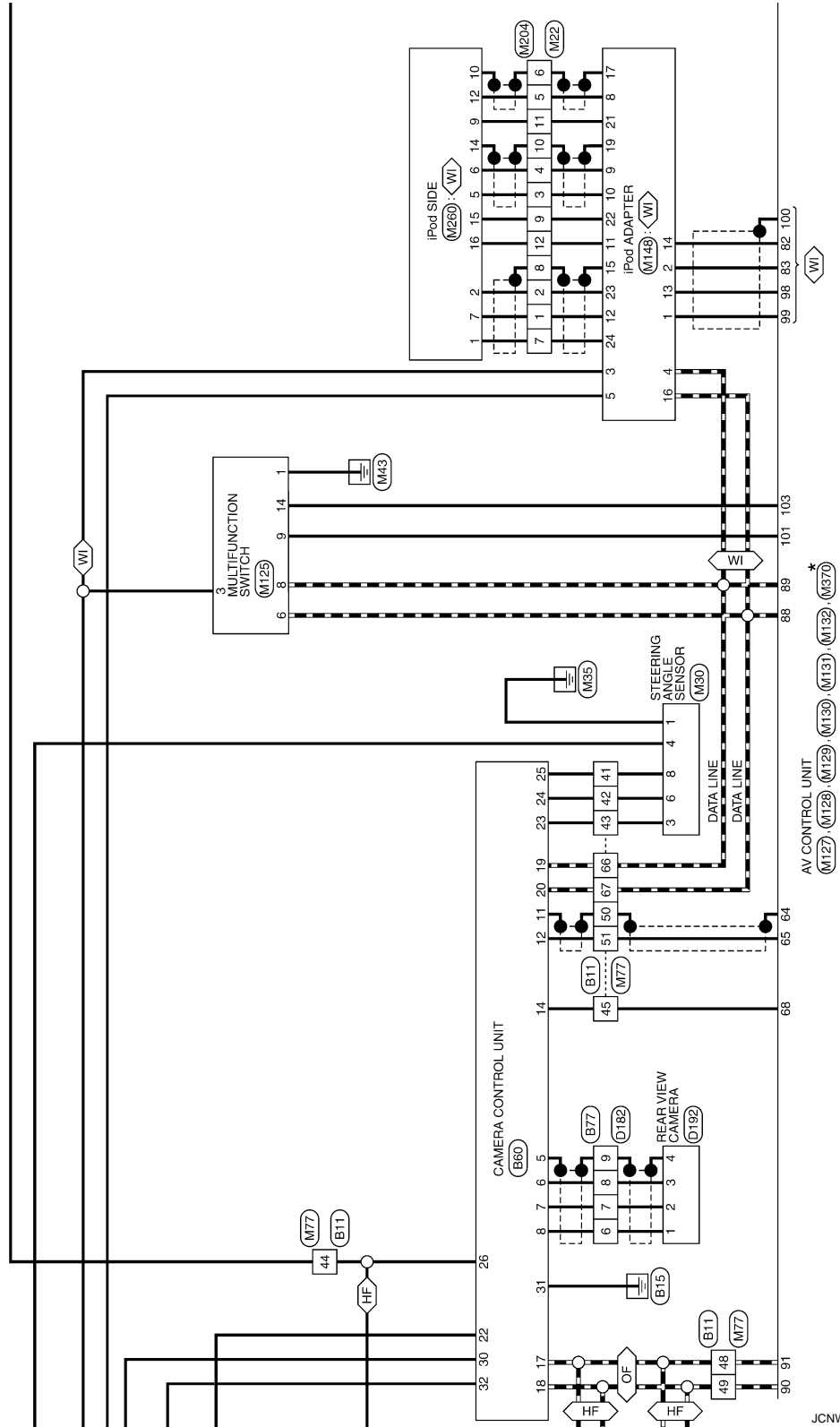

*: This connector is not shown in "Harness Layout".

JCNWM1856GI

A
B
C
D
E
F
G
H
I
J
K
L
M
N
O
P

AV

TEL ADAPTER UNIT

[BOSE AUDIO WITHOUT NAVIGATION]

< ECU DIAGNOSIS >

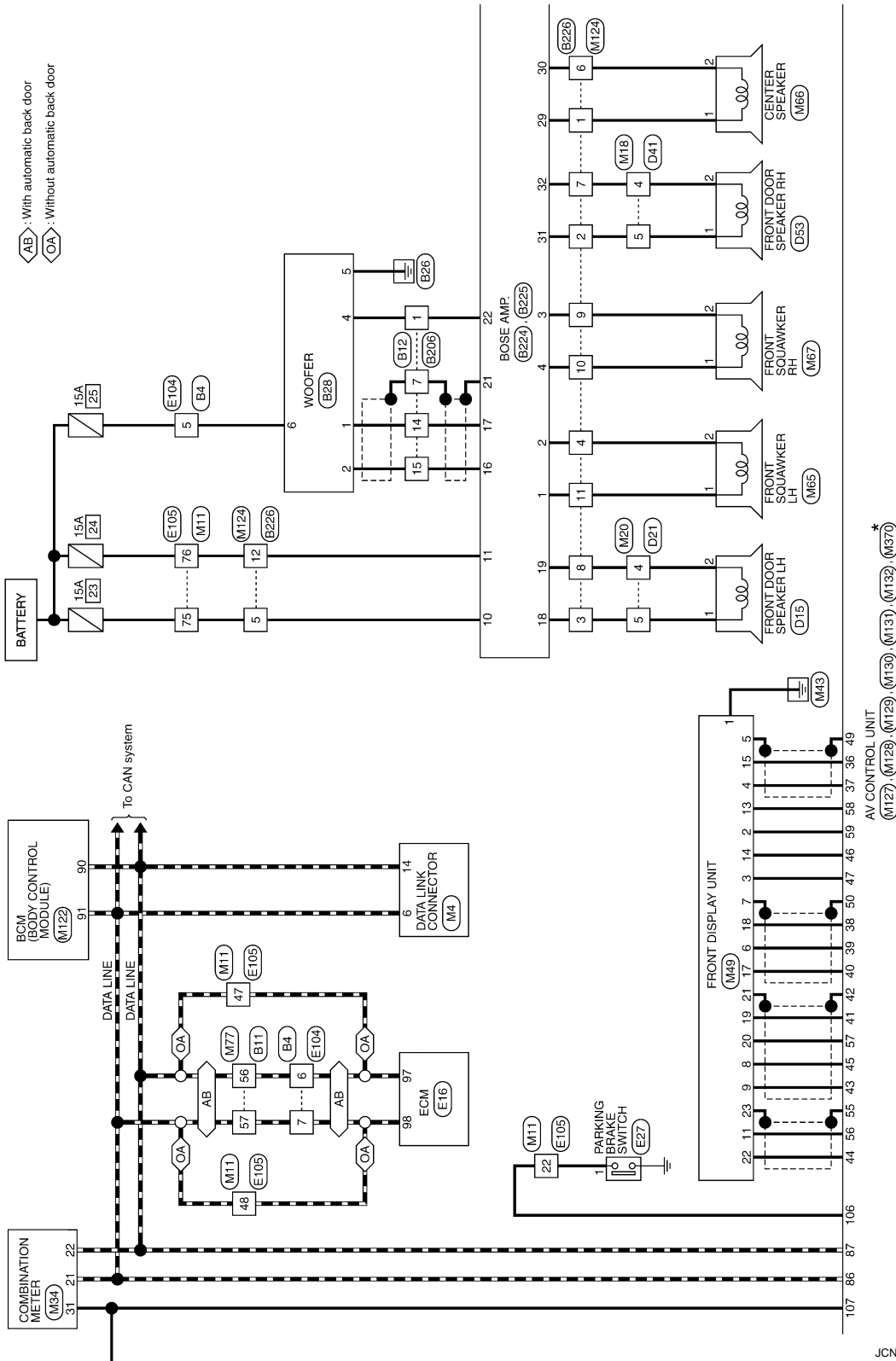

JCNWM1857GI

TEL ADAPTER UNIT

[BOSE AUDIO WITHOUT NAVIGATION]

< ECU DIAGNOSIS >

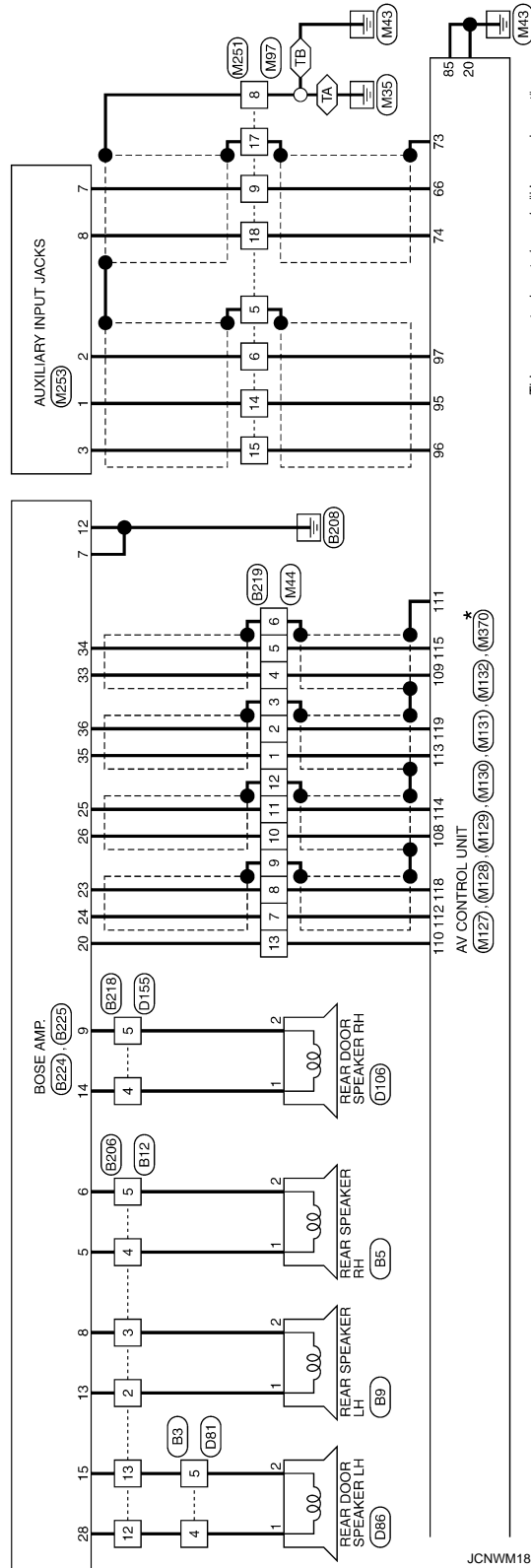

*: This connector is not shown in "Harness Layout".

JCNWM1858GI

A
B
C
D
E
F
G
H
I
J
K
L
M
AV
O
P

TEL ADAPTER UNIT

[BOSE AUDIO WITHOUT NAVIGATION]

< ECU DIAGNOSIS >

BOSE AUDIO WITHOUT NAVIGATION WITHOUT DVD ENTERTAINMENT SYSTEM

Connector No.	B3
Connector Name	WIRE TO WIRE
Connector Type	TK10FW-NS8



Terminal No.	Color of Wire	Signal Name [Specification]
4	LG	-
5	O	-

Connector No.	B4
Connector Name	WIRE TO WIRE
Connector Type	NS16MW-CS



Terminal No.	Color of Wire	Signal Name [Specification]
4	R	-
5	O	-
6	P	-
7	L	-

Connector No.	B5
Connector Name	REAR SPEAKER RH
Connector Type	TK2FBR

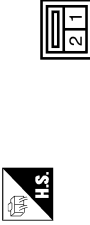

Terminal No.	Color of Wire	Signal Name [Specification]
1	V	-
2	LG	-

Connector No.	B9
Connector Name	REAR SPEAKER LH
Connector Type	TK2FBR



Terminal No.	Color of Wire	Signal Name [Specification]
1	SB	-
2	GR	-

Connector No.	B11
Connector Name	WIRE TO WIRE
Connector Type	TH80MW-CS19

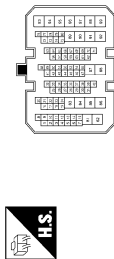

Terminal No.	Color of Wire	Signal Name [Specification]
1	SHIELD	-
2	B	-
3	R/L	-
4	R/W	-
8	SHIELD	-
9	BR/L	-
10	Y/G	-
11	Y/L	-
12	W/L	-
41	O	-
42	SB	-

43	G	-
44	BR	-
45	L	-
46	GR	-
47	V	-
48	GR	- [With rear view camera and telephone]
48	BR	- [With rear view camera without telephone]
49	Y	-
50	SHIELD	-
51	B	-
56	P	-
57	L	-
58	R	-
59	SHIELD	-
60	B	-
61	R/L	-
62	R/W	-
66	GR	-
67	G	-
68	R	-
69	SHIELD	-
70	W/R	-
71	B/R	-

Connector No.	B12
Connector Name	WIRE TO WIRE
Connector Type	NS18FW-CS

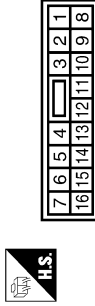

Terminal No.	Color of Wire	Signal Name [Specification]
1	W	-
2	SB	-
3	GR	-
4	V	-
5	LG	-
7	SHIELD	-
12	LG	-
13	O	-
14	W/R	-
15	B/R	-

Connector No.	B28
Connector Name	WOOFER
Connector Type	RS3DFGY-PR



Terminal No.	Color of Wire	Signal Name [Specification]
1	W/R	SOUND SIGNAL WOOFER (-)
2	B/R	SOUND SIGNAL WOOFER (+)
4	W	WOOFER AMP. ON SIGNAL
5	B/W	GND
6	O	BAT

JCNWM1859GI

TEL ADAPTER UNIT

[BOSE AUDIO WITHOUT NAVIGATION]

< ECU DIAGNOSIS >

BOSE AUDIO WITHOUT NAVIGATION WITHOUT DVD ENTERTAINMENT SYSTEM

Connector No.	B33
Connector Name	TEL ADAPTER UNIT
Connector Type	TH88FW-NH



Terminal No.	Color of Wire	Signal Name [Specification]
35	Y	AV COMM (H)
36	BR	AV COMM (L)
40	G	AV COMM (H)
42	GR	AV COMM (L)

Connector No.	B39
Connector Name	TEL ADAPTER UNIT
Connector Type	TH32FW-NH

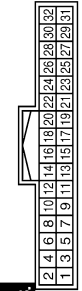

Terminal No.	Color of Wire	Signal Name [Specification]
1	V	BATTERY
2	GR	ACC
3	R	IGNITION
4	B/W	GND
5	SHIELD	SHIELD
6	SHIELD	SHIELD
7	R/W	MICROPHONE SIGNAL
8	R/L	MICROPHONE GND
9	B/R	TEL VOICE SIGNAL (+)
10	W/R	TEL VOICE SIGNAL (-)
14	B	GND

Connector No.	B48
Connector Name	SATELLITE RADIO TUNER
Connector Type	A18FW

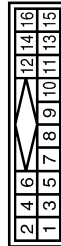

Terminal No.	Color of Wire	Signal Name [Specification]
1	W/L	SOUND SIGNAL LH (-)
2	Y/L	SOUND SIGNAL LH (+)
3	Y/G	SOUND SIGNAL RH (-)
4	BR/L	SOUND SIGNAL RH (+)
5	SHIELD	SHIELD
6	SHIELD	SHIELD
8	R/W	REQUEST (SAT->CONT)
9	R/L	COMM (SAT->CONT)
10	B	COMM (CONT->SAT)
12	V	BATTERY
15	B	GND

20	B	CONTROL SIGNAL
24	B/W	CONTROL SIGNAL
28	BR	VEHICLE SPEED (8-PULSE)
29	B	MICROPHONE VCC

Connector No.	B60
Connector Name	CAMERA CONTROL UNIT
Connector Type	TH32FW-NH

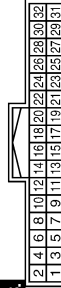

Terminal No.	Color of Wire	Signal Name [Specification]
5	SHIELD	SHIELD
6	B	CAMERA IMAGE SIGNAL
7	R/W	GND
8	R/L	CAMERA ON SIGNAL
11	SHIELD	SHIELD
12	B	CAMERA IMAGE SIGNAL
14	L	CONNECTION RECOGNITION
17	BR	AV COMM (L)
18	Y	AV COMM (H)
19	GR	AV COMM (L)
20	G	AV COMM (H)

22	R	REVERSE
23	G	SENSOR SIGNAL 1
24	SB	SENSOR SIGNAL 2
25	O	SENSOR SIGNAL 3
26	BR	VEHICLE SPEED (8-PULSE)
30	GR	ACC
31	B	GND
32	V	BATTERY

JCNWM1860GI

A
B
C
D
E
F
G
H
I
J
K
L
M
N
O
P

AV

TEL ADAPTER UNIT

[BOSE AUDIO WITHOUT NAVIGATION]

< ECU DIAGNOSIS >

BOSE AUDIO WITHOUT NAVIGATION WITHOUT DVD ENTERTAINMENT SYSTEM

Connector No.	B77
Connector Name	WIRE TO WIRE
Connector Type	TK12MW

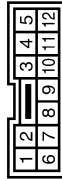

Terminal No.	Color of Wire	Signal Name [Specification]
6	R/L	-
7	R/W	-
8	B	-
9	SHIELD	-

Connector No.	B706
Connector Name	WIRE TO WIRE
Connector Type	NS16MW-CS

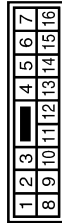

Terminal No.	Color of Wire	Signal Name [Specification]
1	W	-
2	GR	-
3	BR	-
4	Y	-
5	BR	-
7	SHIELD	-
12	G	-
13	R	-
14	W/R	-
15	B/R	-

Connector No.	B218
Connector Name	WIRE TO WIRE
Connector Type	TK10FW-NSB



Terminal No.	Color of Wire	Signal Name [Specification]
4	L	- [With BOSE system]
5	O	- [With BOSE system]

Connector No.	B219
Connector Name	WIRE TO WIRE
Connector Type	TH32MW-NH



Terminal No.	Color of Wire	Signal Name [Specification]
1	W/R	-
2	B/R	-
3	SHIELD	-
4	W/R	-
5	B/R	-
6	SHIELD	-
7	GR/V	-
8	W/L	-
9	SHIELD	-
10	GR/V	-
11	W/L	-

Terminal No.	12	SHIELD	-
Terminal No.	13	SB	-

Connector No.	B224
Connector Name	BOSE AMP.
Connector Type	SGA12FBR-SJA2



Terminal No.	12	B	GND
Terminal No.	13	GR	SOUND SIGNAL REAR SPEAKER LH (+)
Terminal No.	14	L	SOUND SIGNAL REAR DOOR SPEAKER RH (+)

Terminal No.	Color of Wire	Signal Name [Specification]
1	LG	SOUND SIGNAL FRONT SQUAWKER LH (+)
2	V	SOUND SIGNAL FRONT SQUAWKER LH (-)
3	L	SOUND SIGNAL FRONT SQUAWKER RH (-)
4	P	SOUND SIGNAL FRONT SQUAWKER RH (+)
5	Y	SOUND SIGNAL REAR SPEAKER RH (+)
6	BR	SOUND SIGNAL REAR SPEAKER RH (-)
7	B	GND
8	BR	SOUND SIGNAL REAR SPEAKER LH (-)
9	O	SOUND SIGNAL REAR DOOR SPEAKER RH (-)
10	SB	BATTERY
11	GR	BATTERY

JCNWM1861G1

TEL ADAPTER UNIT

[BOSE AUDIO WITHOUT NAVIGATION]

< ECU DIAGNOSIS >

BOSE AUDIO WITHOUT NAVIGATION WITHOUT DVD ENTERTAINMENT SYSTEM

Connector No.	B225
Connector Name	BOSE AMP.
Connector Type	SCA1PBR-SGA4

37	36	35	34	33	32	31	30	29	28			
27	26	25	24	23	22	21	20	19	18	17	16	15

Terminal No.	Color of Wire	Signal Name [Specification]
15	R	SOUND SIGNAL REAR DOOR SPEAKER LH (-)
16	B/R	SOUND SIGNAL REAR DOOR SPEAKER LH (+)
17	W/R	SOUND SIGNAL WOOFER (-)
18	W	SOUND SIGNAL FRONT DOOR SPEAKER LH (+)
18	B	SOUND SIGNAL FRONT DOOR SPEAKER LH (-)
20	SB	AMP ON SIGNAL
21	SHIELD	SHIELD
22	W	WOOFER AMP-ON SIGNAL
23	W/L	SOUND SIGNAL REAR LH (-)
24	GR/V	SOUND SIGNAL REAR LH (+)
25	W/L	SOUND SIGNAL REAR RH (-)

Connector No.	B471
Connector Name	TEL ADAPTER UNIT
Connector Type	GT1BC-1S-HU

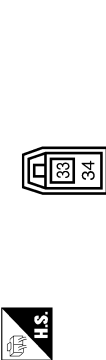

Terminal No.	Color of Wire	Signal Name [Specification]
33	-	TEL ANTENNA
34	SHIELD	SHIELD

26	GR/V	SOUND SIGNAL REAR RH (+)
28	G	SOUND SIGNAL REAR DOOR SPEAKER LH (+)
29	V	SOUND SIGNAL CENTER SPEAKER (+)
30	P	SOUND SIGNAL CENTER SPEAKER (-)
31	BR	SOUND SIGNAL FRONT DOOR SPEAKER RH (+)
32	Y	SOUND SIGNAL FRONT DOOR SPEAKER RH (-)
33	W/R	SOUND SIGNAL FRONT RH (+)
34	B/R	SOUND SIGNAL FRONT LH (+)
35	W/R	SOUND SIGNAL FRONT LH (-)
36	B/R	SOUND SIGNAL FRONT LH (-)

Connector No.	B226
Connector Name	WIRE TO WIRE
Connector Type	NS12MFR-CS

1	2	3	4	5		
6	7	8	9	10	11	12

Terminal No.	Color of Wire	Signal Name [Specification]
1	V	-
2	BR	-
3	W	-
4	V	-
5	SB	-
8	P	-
7	Y	-
8	B	-
9	L	-
10	P	-
11	LG	-

Connector No.	B485
Connector Name	ANTENNA BASE (SATELLITE ANTENNA) (WITH BOSE SYSTEM WITHOUT NAVIGATION SYSTEM)
Connector Type	GT1BC-1PP-HU



Terminal No.	Color of Wire	Signal Name [Specification]
1	-	SATELLITE ANTENNA

Connector No.	D15
Connector Name	FRONT DOOR SPEAKER LH (WITH BOSE SYSTEM)
Connector Type	NS02FBR-CS



Terminal No.	Color of Wire	Signal Name [Specification]
1	L	-[Type A]
1	W	-[Type B]
2	B/W	-[Type A]
2	B	-[Type B]

JCNWM1862GI

A
B
C
D
E
F
G
H
I
J
K
L
M
O
P

AV

TEL ADAPTER UNIT

< ECU DIAGNOSIS >

[BOSE AUDIO WITHOUT NAVIGATION]

BOSE AUDIO WITHOUT NAVIGATION WITHOUT DVD ENTERTAINMENT SYSTEM

Connector No.	D81
Connector Name	WIRE TO WIRE
Connector Type	TK10MW-NS8



Terminal No.	Color of Wire	Signal Name [Specification]
4	L	-
5	W	-

Connector No.	D53
Connector Name	FRONT DOOR SPEAKER RH (WITH BOSE SYSTEM)
Connector Type	NS02FBR-CS



Terminal No.	Color of Wire	Signal Name [Specification]
1	BR	-[Type A]
2	W	-[Type B]
2	B/R	-[Type A]
2	B	-[Type B]

Connector No.	D41
Connector Name	WIRE TO WIRE
Connector Type	TH40FW-CS15

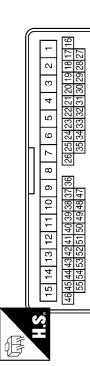

Terminal No.	Color of Wire	Signal Name [Specification]
4	B/R	-[Type A]
4	B	-[Type B]
5	BR	-[Type A]
5	W	-[Type B]

Connector No.	D21
Connector Name	WIRE TO WIRE
Connector Type	TH40FW-CS15

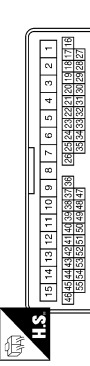

Terminal No.	Color of Wire	Signal Name [Specification]
4	B/W	-[Type A]
4	B	-[Type B]
5	L	-[Type A]
5	W	-[Type B]

Connector No.	D182
Connector Name	WIRE TO WIRE
Connector Type	TK12FW

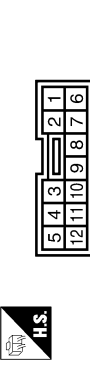

Terminal No.	Color of Wire	Signal Name [Specification]
6	R	-
7	G	-
8	B	-
9	SHIELD	-

Connector No.	D155
Connector Name	WIRE TO WIRE
Connector Type	TK10MW-NS8



Terminal No.	Color of Wire	Signal Name [Specification]
4	O	-[Type A]
4	L	-[Type B]
5	B/P	-[Type A]
5	W	-[Type B]

Connector No.	D106
Connector Name	REAR DOOR SPEAKER RH (WITH BOSE SYSTEM)
Connector Type	NS02FBR-CS



Terminal No.	Color of Wire	Signal Name [Specification]
1	O	-[Type A]
1	L	-[Type B]
2	B/P	-[Type A]
2	W	-[Type B]

Connector No.	D86
Connector Name	REAR DOOR SPEAKER LH (WITH BOSE SYSTEM)
Connector Type	NS02FBR-CS



Terminal No.	Color of Wire	Signal Name [Specification]
1	L	-
2	W	-







JCNWM1863GI

TEL ADAPTER UNIT

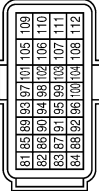
[BOSE AUDIO WITHOUT NAVIGATION]

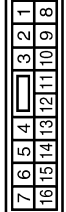
< ECU DIAGNOSIS >

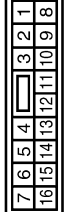
BOSE AUDIO WITHOUT NAVIGATION WITHOUT DVD ENTERTAINMENT SYSTEM

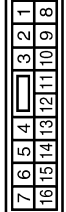
<table border="1"> <tr><td>Connector No.</td><td>D132</td></tr> <tr><td>Connector Name</td><td>REAR VIEW CAMERA</td></tr> <tr><td>Connector Type</td><td>TH04MW-NH</td></tr> </table>  <table border="1"> <tr><td>Terminal No.</td><td>Color of Wire</td><td>Signal Name [Specification]</td></tr> <tr><td>1</td><td>R</td><td>CAMERA ON SIGNAL</td></tr> <tr><td>2</td><td>G</td><td>GND</td></tr> <tr><td>3</td><td>B</td><td>CAMERA IMAGE SIGNAL</td></tr> <tr><td>4</td><td>SHIELD</td><td>SHIELD</td></tr> </table>	Connector No.	D132	Connector Name	REAR VIEW CAMERA	Connector Type	TH04MW-NH	Terminal No.	Color of Wire	Signal Name [Specification]	1	R	CAMERA ON SIGNAL	2	G	GND	3	B	CAMERA IMAGE SIGNAL	4	SHIELD	SHIELD	<table border="1"> <tr><td>Connector No.</td><td>E16</td></tr> <tr><td>Connector Name</td><td>ECM</td></tr> <tr><td>Connector Type</td><td>RI124FB-R2B-L-LH</td></tr> </table>  <table border="1"> <tr><td>Terminal No.</td><td>Color of Wire</td><td>Signal Name [Specification]</td></tr> <tr><td>97</td><td>P</td><td>VEHCAN-L</td></tr> <tr><td>98</td><td>L</td><td>VEHCAN-H</td></tr> </table>	Connector No.	E16	Connector Name	ECM	Connector Type	RI124FB-R2B-L-LH	Terminal No.	Color of Wire	Signal Name [Specification]	97	P	VEHCAN-L	98	L	VEHCAN-H	<table border="1"> <tr><td>Connector No.</td><td>E18</td></tr> <tr><td>Connector Name</td><td>BACK-UP LAMP RELAY</td></tr> <tr><td>Connector Type</td><td>MS02FL-M2-LC</td></tr> </table>  <table border="1"> <tr><td>Terminal No.</td><td>Color of Wire</td><td>Signal Name [Specification]</td></tr> <tr><td>1</td><td>LG</td><td>-</td></tr> <tr><td>2</td><td>R</td><td>-</td></tr> <tr><td>3</td><td>LG</td><td>-</td></tr> <tr><td>5</td><td>R</td><td>-</td></tr> </table>	Connector No.	E18	Connector Name	BACK-UP LAMP RELAY	Connector Type	MS02FL-M2-LC	Terminal No.	Color of Wire	Signal Name [Specification]	1	LG	-	2	R	-	3	LG	-	5	R	-						
Connector No.	D132																																																																
Connector Name	REAR VIEW CAMERA																																																																
Connector Type	TH04MW-NH																																																																
Terminal No.	Color of Wire	Signal Name [Specification]																																																															
1	R	CAMERA ON SIGNAL																																																															
2	G	GND																																																															
3	B	CAMERA IMAGE SIGNAL																																																															
4	SHIELD	SHIELD																																																															
Connector No.	E16																																																																
Connector Name	ECM																																																																
Connector Type	RI124FB-R2B-L-LH																																																																
Terminal No.	Color of Wire	Signal Name [Specification]																																																															
97	P	VEHCAN-L																																																															
98	L	VEHCAN-H																																																															
Connector No.	E18																																																																
Connector Name	BACK-UP LAMP RELAY																																																																
Connector Type	MS02FL-M2-LC																																																																
Terminal No.	Color of Wire	Signal Name [Specification]																																																															
1	LG	-																																																															
2	R	-																																																															
3	LG	-																																																															
5	R	-																																																															
<table border="1"> <tr><td>Connector No.</td><td>E104</td></tr> <tr><td>Connector Name</td><td>WIRE TO WIRE</td></tr> <tr><td>Connector Type</td><td>NS16FW-CS</td></tr> </table>  <table border="1"> <tr><td>Terminal No.</td><td>Color of Wire</td><td>Signal Name [Specification]</td></tr> <tr><td>4</td><td>R</td><td>-</td></tr> </table>	Connector No.	E104	Connector Name	WIRE TO WIRE	Connector Type	NS16FW-CS	Terminal No.	Color of Wire	Signal Name [Specification]	4	R	-	<table border="1"> <tr><td>Connector No.</td><td>E105</td></tr> <tr><td>Connector Name</td><td>WIRE TO WIRE</td></tr> <tr><td>Connector Type</td><td>TH170MW-CS10-M3</td></tr> </table>  <table border="1"> <tr><td>Terminal No.</td><td>Color of Wire</td><td>Signal Name [Specification]</td></tr> <tr><td>5</td><td>LG</td><td>-</td></tr> <tr><td>22</td><td>P</td><td>-</td></tr> <tr><td>47</td><td>P</td><td>-</td></tr> <tr><td>48</td><td>L</td><td>-</td></tr> <tr><td>75</td><td>BR</td><td>-</td></tr> <tr><td>76</td><td>GR</td><td>-</td></tr> <tr><td>78</td><td>V</td><td>-</td></tr> </table>	Connector No.	E105	Connector Name	WIRE TO WIRE	Connector Type	TH170MW-CS10-M3	Terminal No.	Color of Wire	Signal Name [Specification]	5	LG	-	22	P	-	47	P	-	48	L	-	75	BR	-	76	GR	-	78	V	-	<table border="1"> <tr><td>Connector No.</td><td>E104</td></tr> <tr><td>Connector Name</td><td>WIRE TO WIRE</td></tr> <tr><td>Connector Type</td><td>NS16FW-CS</td></tr> </table>  <table border="1"> <tr><td>Terminal No.</td><td>Color of Wire</td><td>Signal Name [Specification]</td></tr> <tr><td>4</td><td>R</td><td>-</td></tr> <tr><td>5</td><td>L</td><td>-</td></tr> <tr><td>6</td><td>P</td><td>-</td></tr> <tr><td>7</td><td>L</td><td>-</td></tr> </table>	Connector No.	E104	Connector Name	WIRE TO WIRE	Connector Type	NS16FW-CS	Terminal No.	Color of Wire	Signal Name [Specification]	4	R	-	5	L	-	6	P	-	7	L	-
Connector No.	E104																																																																
Connector Name	WIRE TO WIRE																																																																
Connector Type	NS16FW-CS																																																																
Terminal No.	Color of Wire	Signal Name [Specification]																																																															
4	R	-																																																															
Connector No.	E105																																																																
Connector Name	WIRE TO WIRE																																																																
Connector Type	TH170MW-CS10-M3																																																																
Terminal No.	Color of Wire	Signal Name [Specification]																																																															
5	LG	-																																																															
22	P	-																																																															
47	P	-																																																															
48	L	-																																																															
75	BR	-																																																															
76	GR	-																																																															
78	V	-																																																															
Connector No.	E104																																																																
Connector Name	WIRE TO WIRE																																																																
Connector Type	NS16FW-CS																																																																
Terminal No.	Color of Wire	Signal Name [Specification]																																																															
4	R	-																																																															
5	L	-																																																															
6	P	-																																																															
7	L	-																																																															
<table border="1"> <tr><td>Connector No.</td><td>E27</td></tr> <tr><td>Connector Name</td><td>PARKING BRAKE SWITCH</td></tr> <tr><td>Connector Type</td><td>P01FE-A</td></tr> </table>  <table border="1"> <tr><td>Terminal No.</td><td>Color of Wire</td><td>Signal Name [Specification]</td></tr> <tr><td>1</td><td>P</td><td>-</td></tr> </table>	Connector No.	E27	Connector Name	PARKING BRAKE SWITCH	Connector Type	P01FE-A	Terminal No.	Color of Wire	Signal Name [Specification]	1	P	-	<table border="1"> <tr><td>Connector No.</td><td>F23</td></tr> <tr><td>Connector Name</td><td>TOM (TRANSMISSION CONTROL MODULE)</td></tr> <tr><td>Connector Type</td><td>RH40FB-R2B-L-RH</td></tr> </table>  <table border="1"> <tr><td>Terminal No.</td><td>Color of Wire</td><td>Signal Name [Specification]</td></tr> <tr><td>19</td><td>G/B</td><td>REV LAMP RELAY</td></tr> </table>	Connector No.	F23	Connector Name	TOM (TRANSMISSION CONTROL MODULE)	Connector Type	RH40FB-R2B-L-RH	Terminal No.	Color of Wire	Signal Name [Specification]	19	G/B	REV LAMP RELAY	<table border="1"> <tr><td>Connector No.</td><td>E104</td></tr> <tr><td>Connector Name</td><td>WIRE TO WIRE</td></tr> <tr><td>Connector Type</td><td>NS16FW-CS</td></tr> </table>  <table border="1"> <tr><td>Terminal No.</td><td>Color of Wire</td><td>Signal Name [Specification]</td></tr> <tr><td>4</td><td>R</td><td>-</td></tr> <tr><td>5</td><td>L</td><td>-</td></tr> <tr><td>6</td><td>P</td><td>-</td></tr> <tr><td>7</td><td>L</td><td>-</td></tr> </table>	Connector No.	E104	Connector Name	WIRE TO WIRE	Connector Type	NS16FW-CS	Terminal No.	Color of Wire	Signal Name [Specification]	4	R	-	5	L	-	6	P	-	7	L	-																		
Connector No.	E27																																																																
Connector Name	PARKING BRAKE SWITCH																																																																
Connector Type	P01FE-A																																																																
Terminal No.	Color of Wire	Signal Name [Specification]																																																															
1	P	-																																																															
Connector No.	F23																																																																
Connector Name	TOM (TRANSMISSION CONTROL MODULE)																																																																
Connector Type	RH40FB-R2B-L-RH																																																																
Terminal No.	Color of Wire	Signal Name [Specification]																																																															
19	G/B	REV LAMP RELAY																																																															
Connector No.	E104																																																																
Connector Name	WIRE TO WIRE																																																																
Connector Type	NS16FW-CS																																																																
Terminal No.	Color of Wire	Signal Name [Specification]																																																															
4	R	-																																																															
5	L	-																																																															
6	P	-																																																															
7	L	-																																																															

JCNWM1864GI

A
B
C
D
E
F
G
H
I
J
K
L
M
N
O
P

AV

TEL ADAPTER UNIT

[BOSE AUDIO WITHOUT NAVIGATION]

< ECU DIAGNOSIS >

BOSE AUDIO WITHOUT NAVIGATION WITHOUT DVD ENTERTAINMENT SYSTEM

Connector No.	F123
Connector Name	WIRE TO WIRE
Connector Type	TK16GY-IV

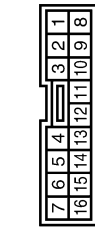

Terminal No.	Color of Wire	Signal Name [Specification]
4	G/B	-

Connector No.	M1
Connector Name	FUSE BLOCK (J/B)
Connector Type	NS0FW-M2



Terminal No.	Color of Wire	Signal Name [Specification]
2A	G	-
5A	R	-

Connector No.	M3
Connector Name	FUSE BLOCK (J/B)
Connector Type	NS12FW-CS

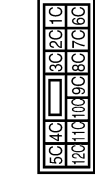

Terminal No.	Color of Wire	Signal Name [Specification]
12C	O	-

Connector No.	M4
Connector Name	DATA LINK CONNECTOR
Connector Type	BD16FW

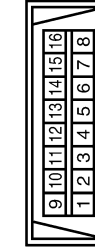

Terminal No.	Color of Wire	Signal Name [Specification]
6	L	-
14	P	-

Connector No.	M11
Connector Name	WIRE TO WIRE
Connector Type	TH10FW-CS10-M3

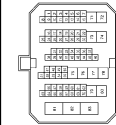

Terminal No.	Color of Wire	Signal Name [Specification]
5	O	-
22	G	-
47	P	-
48	L	-
75	BR	-
76	R	-
78	Y	-

Connector No.	M18
Connector Name	WIRE TO WIRE
Connector Type	TH40MW-CS15

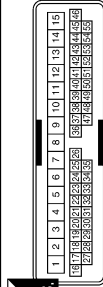

Terminal No.	Color of Wire	Signal Name [Specification]
4	W	-
5	BR	- [Type A and without BOSE system type B] - [With BOSE system type B]
5	B	-

Connector No.	M20
Connector Name	WIRE TO WIRE
Connector Type	TH40MW-CS15

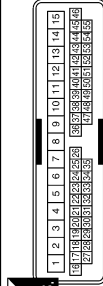

Terminal No.	Color of Wire	Signal Name [Specification]
4	B	-
5	L	-

TEL ADAPTER UNIT

[BOSE AUDIO WITHOUT NAVIGATION]

< ECU DIAGNOSIS >

BOSE AUDIO WITHOUT NAVIGATION WITHOUT DVD ENTERTAINMENT SYSTEM

Connector No.	M22
Connector Name	WIRE TO WIRE
Connector Type	TH12FW-NH

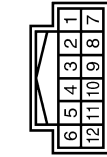

Terminal No.	Color of Wire	Signal Name [Specification]
1	V	-
2	R	-
3	R	-
4	G	-
5	W	-
6	SHIELD	-
7	LG	-
8	SHIELD	-
9	BR	-
10	SHIELD	-
11	L	-

Connector No.	M33
Connector Name	COMBINATION SWITCH (SPIRAL CABLE)
Connector Type	TK08FGY-IV

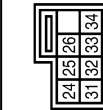

Terminal No.	Color of Wire	Signal Name [Specification]
24	BR	- [With audio steering switch and telephone]
31	G	- [With audio steering switch and telephone]
33	L	- [With audio steering switch and telephone]

12	R
----	---

Connector No.	M23
Connector Name	WIRE TO WIRE
Connector Type	TH18MW-NH

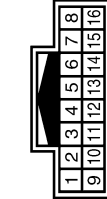

Terminal No.	Color of Wire	Signal Name [Specification]
1	W	-
2	R	- [With telephone without navigation system]
3	B	-
4	SHIELD	-

Connector No.	M34
Connector Name	COMBINATION METER
Connector Type	TH40FW-NH



Terminal No.	Color of Wire	Signal Name [Specification]
21	L	CAN-H
22	P	CAN-L
31	V	VEHICLE SPEED (8-PULSE)

Connector No.	M30
Connector Name	STEERING ANGLE SENSOR
Connector Type	TH08FW-NH

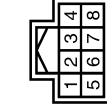

Terminal No.	Color of Wire	Signal Name [Specification]
1	B	-
3	L	-
4	G	-
6	SB	-
8	O	-

Connector No.	M44
Connector Name	WIRE TO WIRE
Connector Type	TH32FW-NH

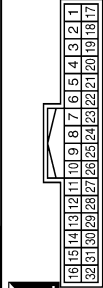

Terminal No.	Color of Wire	Signal Name [Specification]
1	G	-
2	R	-
3	SHIELD	-
4	B	-
5	W	-
6	SHIELD	-
7	O	- [Type A]
7	L	- [Type B]
8	SB	- [Type A]
8	R	- [Type B]
9	SHIELD	-

A
B
C
D
E
F
G
H
I
J
K
L
M
AV
O
P

JCNWM1866GI

TEL ADAPTER UNIT

[BOSE AUDIO WITHOUT NAVIGATION]

< ECU DIAGNOSIS >

BOSE AUDIO WITHOUT NAVIGATION

Connector No.	M49
Connector Name	FRONT DISPLAY UNIT
Connector Type	TH24FW-NH

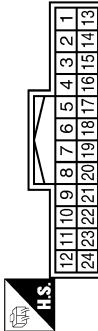

14	LG	SIGNAL GND[Without navigation system]
15	L	COMPOSITE IMAGE SIGNAL[Without navigation system]
17	G	RGB (R)RED SIGNAL
18	Y	RGB (B)BLUE SIGNAL[Without navigation system]
19	B	RGB SYNC
20	R	VP
21	SHIELD	SHIELD
22	G	COMM (DISP->CONT)
23	SHIELD	SHIELD

Connector No.	M65
Connector Name	FRONT SQUAWKER LH
Connector Type	TK02FBR



Connector No.	M66
Connector Name	CENTER SPEAKER
Connector Type	TK02FBR



Terminal No.	Color of Wire	Signal Name [Specification]
1	B	GND
2	Y	INVERTER VCC[Without navigation system]
3	O	SIGNAL VCC[Without navigation system]
4	P	COMPOSITE IMAGE GND[Without navigation system]
5	SHIELD	SHIELD[Without navigation system]
6	L	RGB (G)GREEN SIGNAL[Without navigation system]
7	SHIELD	SHIELD
8	G	HP[Without navigation system]
9	W	RGB AREA (YS) SIGNAL
11	R	COMM (CONT->DISP)
13	BR	INVERTER GND[Without navigation system]

Terminal No.	Color of Wire	Signal Name [Specification]
1	LG	-[With BOSE system]
2	Y	-[With BOSE system]

Terminal No.	Color of Wire	Signal Name [Specification]
1	P	-
2	O	-

Connector No.	M67
Connector Name	FRONT SQUAWKER RH
Connector Type	TK02FBR



Connector No.	M77
Connector Name	WIRE TO WIRE
Connector Type	TH80FW-CS19

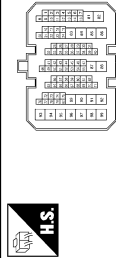

Terminal No.	Color of Wire	Signal Name [Specification]
43	L	-
44	V	-
45	P	-
46	R	-
47	Y	-
48	L	-
49	G	-
50	SHIELD	-
51	W	-
56	P	-
57	L	-
58	SB	-
59	SHIELD	-
60	B	-
61	R	-
62	W	-
66	L	-
67	R	-
68	G	-
69	SHIELD	-
70	L	-
71	R	-

Connector No.	M97
Connector Name	WIRE TO WIRE
Connector Type	TH18FW-CS2

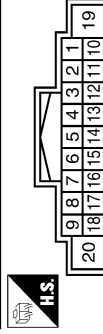

Terminal No.	Color of Wire	Signal Name [Specification]
1	BR	-
2	R	-[With BOSE system]

Terminal No.	Color of Wire	Signal Name [Specification]
1	SHIELD	-
2	B	-
3	W	-
4	R	-
8	SHIELD	-
9	W	-
10	R	-
11	G	-
12	B	-
41	O	-
42	SB	-

Terminal No.	Color of Wire	Signal Name [Specification]
5	SHIELD	-
6	W	-
8	B	-
9	Y	-
14	R	-
15	B	-
17	SHIELD	-
18	B	-[Type A and With navigation system type B]
18	BR	-[Without navigation system type B]

TEL ADAPTER UNIT

[BOSE AUDIO WITHOUT NAVIGATION]

< ECU DIAGNOSIS >

BOSE AUDIO WITHOUT NAVIGATION WITHOUT DVD ENTERTAINMENT SYSTEM

Connector No.	M122
Connector Name	BCM (BODY CONTROL MODULE)
Connector Type	TH40FB-NH

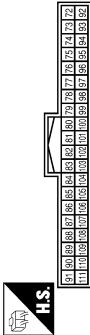

Terminal No.	Color of Wire	Signal Name [Specification]
90	P	CAN-L
91	L	CAN-H

Connector No.	M124
Connector Name	WIRE TO WIRE
Connector Type	NS12FER-CS



Terminal No.	Color of Wire	Signal Name [Specification]
1	P	-
2	BR	- [Type A]
3	B	- [Type B]
4	L	-
5	Y	-
6	BR	-
7	W	-
8	B	-
9	R	-
10	BR	-

Connector No.	M127
Connector Name	AV CONTROL UNIT (WITH BOSE SYSTEM WITHOUT NAVIGATION SYSTEM)
Connector Type	TH18FW-CS2

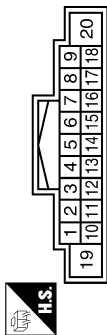

Terminal No.	Color of Wire	Signal Name [Specification]
6	BR	STRG SW A
7	R	ACC
9	R	ILLUMINATION
15	L	STRG SW GND
16	G	STRG SW B
19	Y	BATTERY
20	B	GND

Connector No.	M128
Connector Name	AV CONTROL UNIT (WITH BOSE SYSTEM WITHOUT NAVIGATION SYSTEM)
Connector Type	A12FW

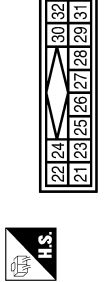

Terminal No.	Color of Wire	Signal Name [Specification]
21	B	SATELLITE RADIO SOUND SIGNAL LH (-)
22	G	SATELLITE RADIO SOUND SIGNAL LH (+)
23	R	SATELLITE RADIO SOUND SIGNAL RH (-)
24	W	SATELLITE RADIO SOUND SIGNAL RH (+)
25	SHIELD	SHIELD
26	SHIELD	SHIELD
28	R	REQUEST (SAT->CONT)
29	W	COMM (SAT->CONT)
30	B	COMM (CONT->SAT)

11	LG
12	R

Connector No.	M125
Connector Name	MULTIFUNCTION SWITCH
Connector Type	TH18FW-NH

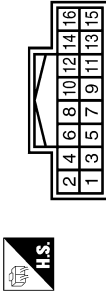

Terminal No.	Color of Wire	Signal Name [Specification]
1	B	GND
3	R	ACC
6	R	AV COMM (H)
8	L	AV COMM (L)
9	V	SW GND
14	W	EJECT SIGNAL

Terminal No.	Color of Wire	Signal Name [Specification]
47	O	SIGNAL VCC
49	SHIELD	SHIELD
50	SHIELD	SHIELD
55	SHIELD	SHIELD
56	R	COMM (CONT->DISP)
57	R	VP
58	BR	INVERTER GND
59	Y	INVERTER VCC

Connector No.	M129
Connector Name	AV CONTROL UNIT (WITH BOSE SYSTEM WITHOUT NAVIGATION SYSTEM)
Connector Type	TH24FW-NH

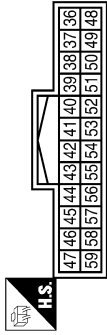

Terminal No.	Color of Wire	Signal Name [Specification]
36	L	COMPOSITE IMAGE SIGNAL
37	P	COMPOSITE IMAGE GND
38	Y	RGB (B/BLUE) SIGNAL
39	L	RGB (G/GREEN) SIGNAL
40	G	RGB (R/RED) SIGNAL
41	B	RGB SYNC
42	SHIELD	SHIELD
43	W	RGB AREA (YS) SIGNAL
44	G	COMM (DISP->CONT)
45	G	HP
46	LG	SIGNAL GND

A
B
C
D
E
F
G
H
I
J
K
L
M
N
O
P

AV

TEL ADAPTER UNIT

[BOSE AUDIO WITHOUT NAVIGATION]

< ECU DIAGNOSIS >

BOSE AUDIO WITHOUT NAVIGATION WITHOUT DVD ENTERTAINMENT SYSTEM

Connector No.	M130
Connector Name	AV CONTROL UNIT (WITH BOSE SYSTEM WITHOUT NAVIGATION SYSTEM)
Connector Type	TH16FW-NH



67	66	65	64	63	62	61	60
75	74	73	72	71	70	69	68

Terminal No.	Color of Wire	Signal Name [Specification]
64	SHIELD	SHIELD
65	W	CAMERA IMAGE SIGNAL
66	Y	AUX IMAGE SIGNAL [Without DVD player]
68	P	CONNECTION RECOGNITION
73	SHIELD	SHIELD [Without DVD player]
74	B	AUX IMAGE GND [Without DVD player (type A)]
74	BR	AUX IMAGE GND [Without DVD player (type B)]

Connector No.	M132
Connector Name	AV CONTROL UNIT (WITH BOSE SYSTEM WITHOUT NAVIGATION SYSTEM)
Connector Type	TH12FW-NH



114	115	116	117	118	119
108	109	110	111	112	113

Terminal No.	Color of Wire	Signal Name [Specification]
108	V	SOUND SIGNAL REAR RH (+)
109	B	SOUND SIGNAL FRONT RH (+)
110	P	AMP ON SIGNAL
111	SHIELD	SHIELD
112	O	SOUND SIGNAL REAR LH (+) [Type A]
112	L	SOUND SIGNAL REAR LH (+) [Type B]
113	G	SOUND SIGNAL FRONT LH (+)
114	LG	SOUND SIGNAL REAR RH (-)
115	W	SOUND SIGNAL FRONT RH (-)
118	SR	SOUND SIGNAL REAR LH (-) [Type A]
118	R	SOUND SIGNAL REAR LH (-) [Type B]

Connector No.	M131
Connector Name	AV CONTROL UNIT (WITH BOSE SYSTEM WITH NAVIGATION SYSTEM)
Connector Type	TH24FW-NH



91	90	89	88	87	86	85	84	83	82	81	80	79	78	77	76
----	----	----	----	----	----	----	----	----	----	----	----	----	----	----	----

Terminal No.	Color of Wire	Signal Name [Specification]
79	L	TEL VOICE SIGNAL (-)
80	R	TEL VOICE SIGNAL (+)
81	SHIELD	SHIELD
82	W	iPod SOUND SIGNAL RH (-) [Without DVD player]
83	R	iPod SOUND SIGNAL RH (+) [Without DVD player]
85	B	GND
86	L	CAN-H
87	P	CAN-L
88	R	AV COMM (H)
89	L	AV COMM (L)
90	G	AV COMM (H)

119	R	SOUND SIGNAL FRONT LH (-)
-----	---	---------------------------

91	L	AV COMM (L)
95	R	AUX SOUND SIGNAL RH (+)
96	B	AUX SOUND SIGNAL LH (+)
97	W	AUX SOUND SIGNAL GND
98	L	iPod SOUND SIGNAL LH (-) [Without DVD player]
99	BR	iPod SOUND SIGNAL LH (+) [Without DVD player]
100	SHIELD	SHIELD [Without DVD player]
101	V	SW GND
103	W	EJECT SIGNAL
104	G	IGNITION
105	SB	REVERSE
106	G	PARKING BRAKE
107	V	VEHICLE SPEED (8-PULSE)

Connector No.	M148
Connector Name	iPod ADAPTER
Connector Type	TH24FW-NH



1	2	3	4	5	6	7	8	9	10	11	12
13	14	15	16	17	18	19	20	21	22	23	24

14	W	iPod SOUND SIGNAL RH (-)
15	SHIELD	SHIELD
16	R	AV COMM (H)
17	SHIELD	GND
19	SHIELD	SHIELD
21	L	iPod CONNECTION RECOGNITION
22	BR	ACCESSORY DETECT
23	R	iPod SOUND SIGNAL GND
24	LG	iPod SOUND SIGNAL LH (+)

Terminal No.	Color of Wire	Signal Name [Specification]
1	BR	iPod SOUND SIGNAL LH (+)
2	R	iPod SOUND SIGNAL RH (+)
3	R	ACC
4	L	AV COMM (L)
5	Y	BATTERY
8	W	CHARGE POWER
9	G	COMM (iPod ADAPTER->iPod)
10	R	COMM (iPod->iPod ADAPTER)
11	R	ACCESSORY IDENTIFY
12	V	iPod SOUND SIGNAL RH (+)
13	L	iPod SOUND SIGNAL LH (-)

TEL ADAPTER UNIT

[BOSE AUDIO WITHOUT NAVIGATION]

< ECU DIAGNOSIS >

BOSE AUDIO WITHOUT NAVIGATION WITHOUT DVD ENTERTAINMENT SYSTEM

Connector No.	M253
Connector Name	AUXILIARY INPUT JACKS
Connector Type	A08FW



Terminal No.	Color of Wire	Signal Name [Specification]
1	R	SOUND SIGNAL RH (+)
2	W	SOUND SIGNAL GND
3	B	SOUND SIGNAL LH (-) [Without DVD player]
7	G	AUX IMAGE SIGNAL
8	R	AUX IMAGE GND [Without DVD player]

Connector No.	M251
Connector Name	WIRE TO WIRE
Connector Type	TH1BMW-CS2



Terminal No.	Color of Wire	Signal Name [Specification]
5	SHIELD	-
6	W	-
8	SHIELD	-
9	G	-
14	R	-
15	B	-
17	SHIELD	-
18	R	-

12	R	-
----	---	---

Connector No.	M204
Connector Name	WIRE TO WIRE
Connector Type	TH12MW-NH

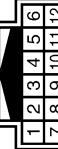

Terminal No.	Color of Wire	Signal Name [Specification]
1	V	-
2	R	-
3	R	-
4	G	-
5	W	-
6	SHIELD	-
7	LG	-
8	SHIELD	-
9	BR	-
10	SHIELD	-
11	L	-

Connector No.	M275
Connector Name	WIRE TO WIRE
Connector Type	GT13SH-2/1S-HU



Terminal No.	Color of Wire	Signal Name [Specification]
1	-	-
2	-	-
3	-	-

Connector No.	M370
Connector Name	AV CONTROL UNIT WITH BOSE SYSTEM WITHOUT NAVIGATION SYSTEM
Connector Type	GT135C-2/1S-HU



Terminal No.	Color of Wire	Signal Name [Specification]
33	-	FM SUB
34	-	AM-FM MAIN
35	-	ANTENNA AMP. ON SIGNAL

Connector No.	M303
Connector Name	COMBINATION SWITCH (SPIRAL CABLE)
Connector Type	TK08FGY



Terminal No.	Color of Wire	Signal Name [Specification]
14	-	-
15	-	-
17	-	-

Connector No.	M260
Connector Name	iPod SIDE
Connector Type	IP18FGY



Terminal No.	Color of Wire	Signal Name [Specification]
1	LG	iPod SOUND SIGNAL LH (+)
2	R	iPod SOUND SIGNAL GND
5	R	COMM (iPod->iPod ADAPTER)
6	G	COMM (iPod ADAPTER->iPod)
7	V	iPod SOUND SIGNAL RH (+)
9	L	iPod CONNECTION RECOGNITION GND
10	SHIELD	CHARGE POWER
12	W	SHIELD
14	SHIELD	ACCESSORY DETECT
15	BR	ACCESSORY DETECT
16	R	ACCESSORY IDENTITY

JCNWM1870GI

A
B
C
D
E
F
G
H
I
J
K
L
M
O
P

AV

TEL ADAPTER UNIT

[BOSE AUDIO WITHOUT NAVIGATION]

< ECU DIAGNOSIS >

BOSE AUDIO WITHOUT NAVIGATION WITHOUT DVD ENTERTAINMENT SYSTEM

Connector No.	M376
Connector Name	WIRE TO WIRE
Connector Type	GT13SCW-2/1PP-HU



Terminal No.	Color of Wire	Signal Name [Specification]
1	-	-
2	-	-
3	-	-

Connector No.	M378
Connector Name	ANTENNA BASE (ANTENNA AMP.)
Connector Type	GT13SSN-1/1PP-HU

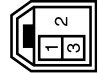

Terminal No.	Color of Wire	Signal Name [Specification]
1	-	-
3	-	-

Connector No.	M379
Connector Name	GLASS ANTENNA
Connector Type	GT13SSN-1/1PP-HU



Terminal No.	Color of Wire	Signal Name [Specification]
2	-	FM SUB

Connector No.	R1
Connector Name	WIRE TO WIRE
Connector Type	TH16FW-NH

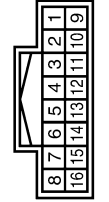

Terminal No.	Color of Wire	Signal Name [Specification]
1	R/W	-
2	R/L	- [With telephones without navigation system]
3	B	-
4	SHIELD	-

Connector No.	R20
Connector Name	MICROPHONE
Connector Type	TK04FW



Terminal No.	Color of Wire	Signal Name [Specification]
1	R/W	MICROPHONE SIGNAL (+)
2	R/L	MICROPHONE SIGNAL (-) [Only telephones without navigation system]
4	B	MICROPHONE POWER

JCNWM1871GI

Wiring Diagram - BOSE AUDIO WITHOUT NAVIGATION WITH DVD ENTERTAINMENT SYSTEM -

INFOID:000000003702920

NOTE:

TEL ADAPTER UNIT

[BOSE AUDIO WITHOUT NAVIGATION]

< ECU DIAGNOSIS >

In this section, PRESET SWITCH and MULTIFUNCTION SWITCH are written as the MULTIFUNCTION SWITCH.

BOSE AUDIO WITHOUT NAVIGATION WITH DVD ENTERTAINMENT SYSTEM

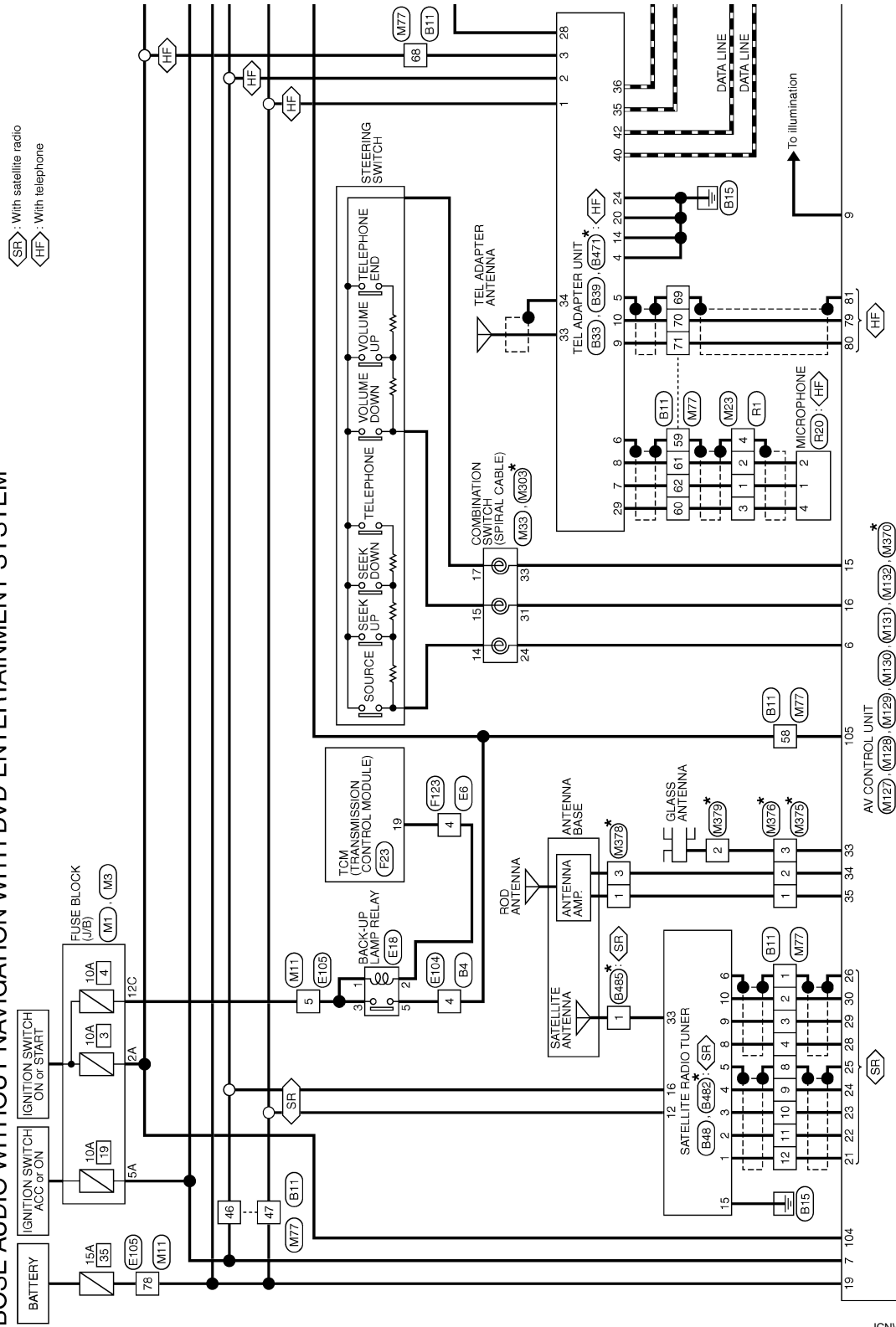

*: This connector is not shown in "Harness layout".

2008/09/23

JCNWM1872GI

A
B
C
D
E
F
G
H
I
J
K
L
M
N
O
P

AV

TEL ADAPTER UNIT

[BOSE AUDIO WITHOUT NAVIGATION]

< ECU DIAGNOSIS >

- : With iPod
- : With telephone
- : Without telephone

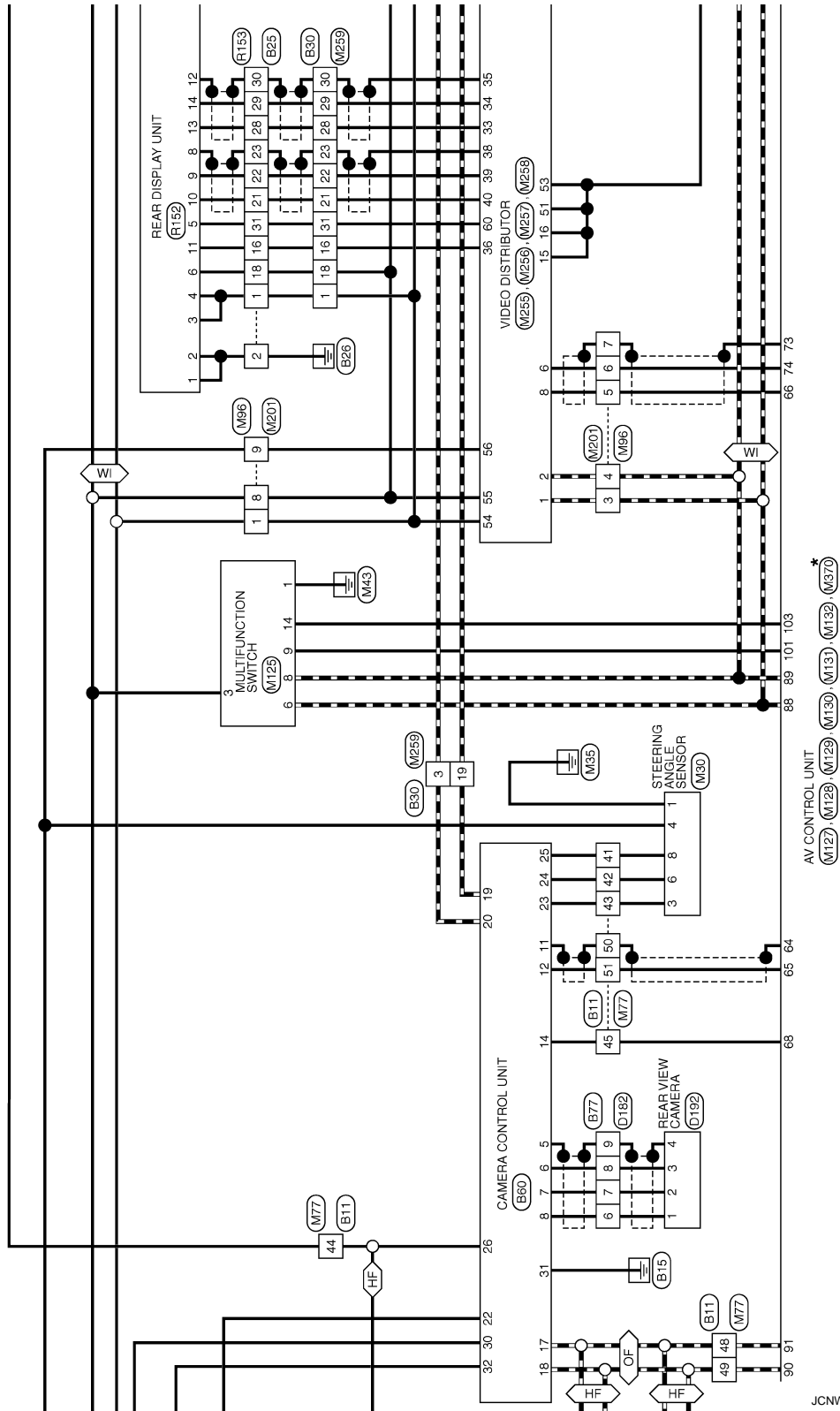

*: This connector is not shown in "Harness Layout".

JCNWM1873GI

TEL ADAPTER UNIT

[BOSE AUDIO WITHOUT NAVIGATION]

< ECU DIAGNOSIS >

WI: With iPod

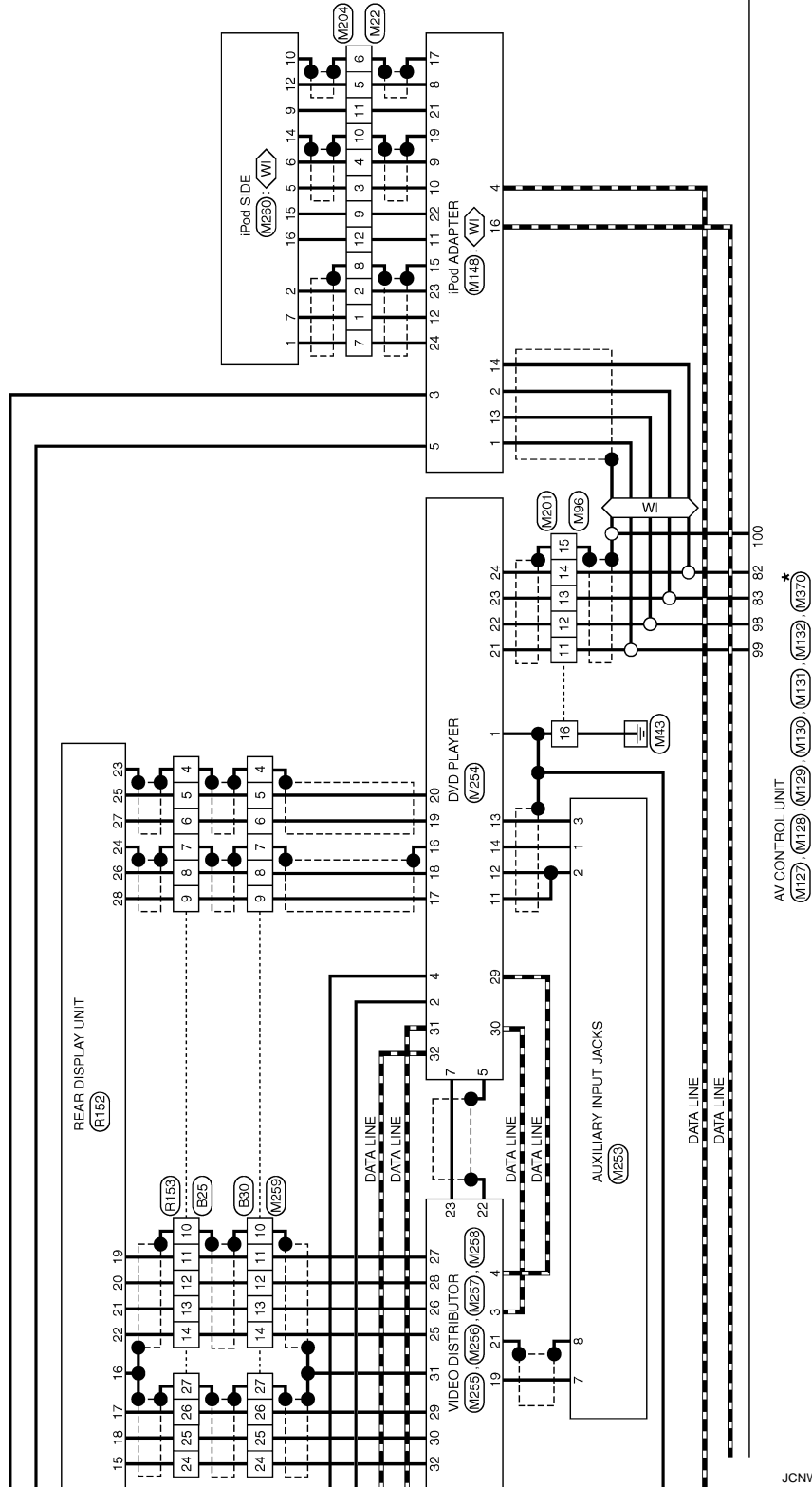

*: This connector is not shown in "Harness Layout".

JCNWM1874GI

A
B
C
D
E
F
G
H
I
J
K
L
M
N
O
P

AV

TEL ADAPTER UNIT

[BOSE AUDIO WITHOUT NAVIGATION]

< ECU DIAGNOSIS >

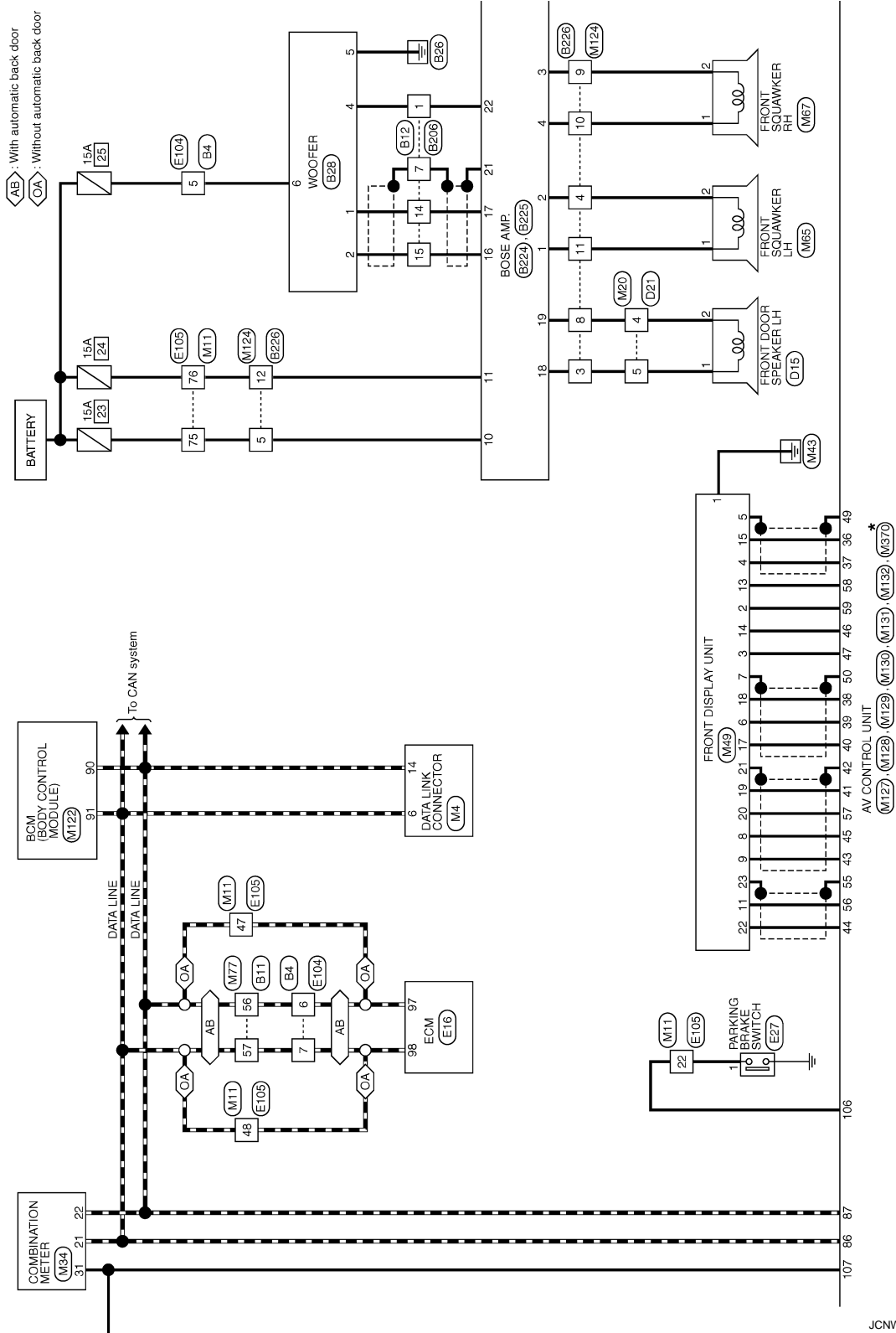

*: This connector is not shown in "Harness Layout".

JCNWM1875GI

TEL ADAPTER UNIT

[BOSE AUDIO WITHOUT NAVIGATION]

< ECU DIAGNOSIS >

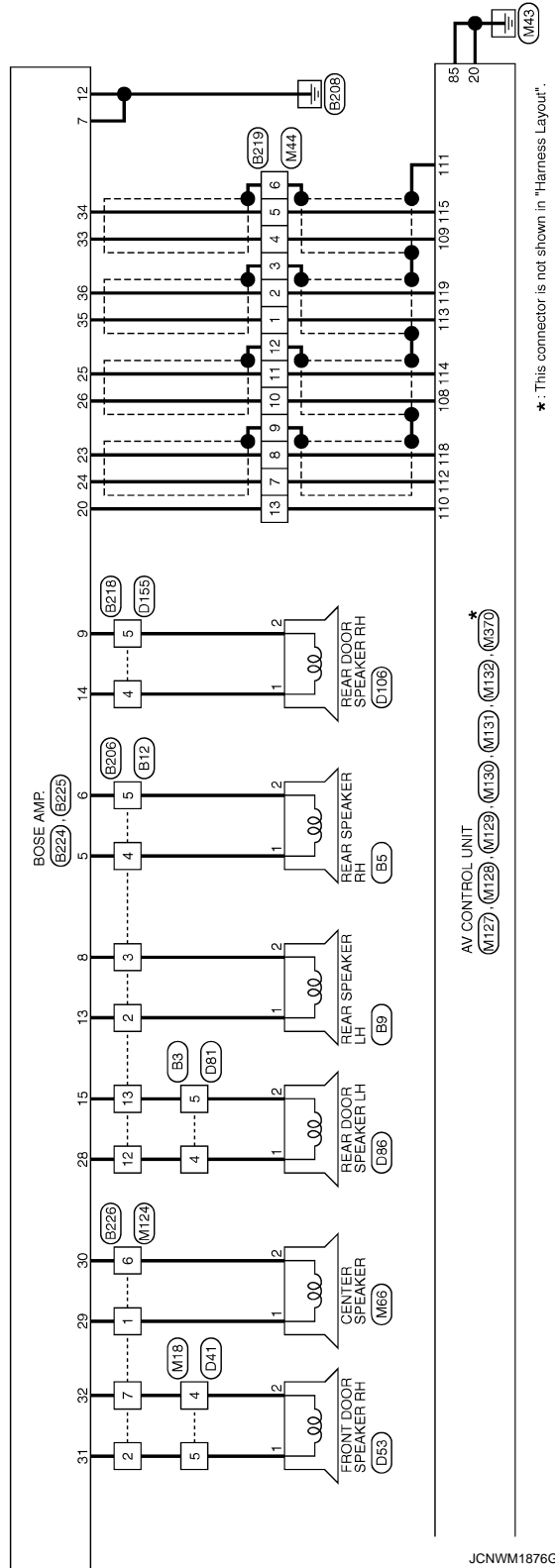

A
B
C
D
E
F
G
H
I
J
K
L
M
AV
O
P

TEL ADAPTER UNIT

[BOSE AUDIO WITHOUT NAVIGATION]

< ECU DIAGNOSIS >

BOSE AUDIO WITHOUT NAVIGATION WITH DVD ENTERTAINMENT SYSTEM

Connector No.	B3
Connector Name	WIRE TO WIRE
Connector Type	TK10FW-NS8



Terminal No.	Color of Wire	Signal Name [Specification]
4	LG	-
5	O	-

Connector No.	B4
Connector Name	WIRE TO WIRE
Connector Type	NS16MW-CS



Terminal No.	Color of Wire	Signal Name [Specification]
4	R	-
5	O	-
6	P	-
7	L	-

Connector No.	B5
Connector Name	REAR SPEAKER RH
Connector Type	TK02FBR



Terminal No.	Color of Wire	Signal Name [Specification]
1	V	-
2	LG	-

Connector No.	B9
Connector Name	REAR SPEAKER LH
Connector Type	TK02FBR



Terminal No.	Color of Wire	Signal Name [Specification]
1	SB	-
2	GR	-

Connector No.	B11
Connector Name	WIRE TO WIRE
Connector Type	TH80MW-CS19

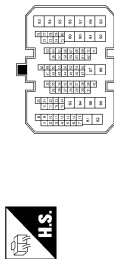

Terminal No.	Color of Wire	Signal Name [Specification]
1	SHIELD	-
2	B	-
3	R/L	-
4	R/W	-
8	SHIELD	-
9	BR/L	-
10	Y/G	-
11	Y/L	-
12	W/L	-
41	O	-
42	SB	-

43	G	-
44	BR	-
45	L	-
46	GR	-
47	V	-
48	GR	- [With rear view camera and telephone]
48	BR	- [With rear view camera without telephone]
49	Y	-
50	SHIELD	-
51	B	-
56	P	-
57	L	-
58	R	-
59	SHIELD	-
60	B	-
61	R/L	-
62	R/W	-
68	R	-
69	SHIELD	-
70	W/R	-
71	B/R	-

Connector No.	B12
Connector Name	WIRE TO WIRE
Connector Type	NS16FW-CS

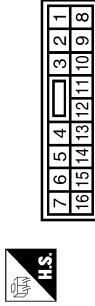

Terminal No.	Color of Wire	Signal Name [Specification]
1	W	-
2	SB	-
3	GR	-
4	V	-
5	LG	-
7	SHIELD	-
12	LG	-
13	O	-
14	W/R	-
15	B/R	-

TEL ADAPTER UNIT

[BOSE AUDIO WITHOUT NAVIGATION]

< ECU DIAGNOSIS >

BOSE AUDIO WITHOUT NAVIGATION WITH DVD ENTERTAINMENT SYSTEM

Connector No.	B25
Connector Name	WIRE TO WIRE
Connector Type	TH22MW-NH



1	2	3	4	5	6	7	8	9	10	11	12	13	14	15	16
17	18	19	20	21	22	23	24	25	26	27	28	29	30	31	32

Terminal No.	Color of Wire	Signal Name [Specification]
1	SB	-
2	B	-
4	SHIELD	-
5	W/R	-
6	W/L	-
7	SHIELD	-
8	GR/V	-
9	W/L	-
10	SHIELD	-
11	W/L	-
12	Y/G	-

Connector No.	B30
Connector Name	WIRE TO WIRE
Connector Type	TH22FW-NH



16	15	14	13	12	11	10	9	8	7	6	5	4	3	2	1
32	31	30	29	28	27	26	25	24	23	22	21	20	19	18	17

Terminal No.	Color of Wire	Signal Name [Specification]
1	SB	-
3	G	-
4	SHIELD	-
5	W/R	-
6	W/L	-
7	SHIELD	-
8	GR/V	-
9	W/L	-
10	SHIELD	-
11	W/L	-
12	Y/G	-

13	Y/L	-
14	BR/L	-
16	V	-
18	O	-
21	B/R	-
22	W/R	-
23	SHIELD	-
24	B	-
25	R/L	-
26	R/W	-
27	SHIELD	-
28	B	-
29	W	-
30	SHIELD	-
31	P	-

Connector No.	B28
Connector Name	WOOFER
Connector Type	RS28FGY-PR



Terminal No.	Color of Wire	Signal Name [Specification]
1	W/R	SOUND SIGNAL WOOFER (-)
2	B/R	SOUND SIGNAL WOOFER (+)
4	W	WOOFER AMP ON SIGNAL
5	B/W	GND
6	O	BAT

13	Y/L	-
14	BR/L	-
16	V	-
18	O	-
19	GR	-
21	B/R	-
22	W/R	-
23	SHIELD	-
24	B	-
25	R/L	-
26	R/W	-
27	SHIELD	-
28	B	-
29	W	-
30	SHIELD	-
31	P	-

Connector No.	B33
Connector Name	TEL ADAPTER UNIT
Connector Type	TH33FW-NH

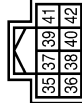

Terminal No.	Color of Wire	Signal Name [Specification]
35	Y	AV COMM (H)
36	BR	AV COMM (L)
40	G	AV COMM (H)
42	GR	AV COMM (L)

A
B
C
D
E
F
G
H
I
J
K
L
M
N
O
P

AV

TEL ADAPTER UNIT

[BOSE AUDIO WITHOUT NAVIGATION]

< ECU DIAGNOSIS >

BOSE AUDIO WITHOUT NAVIGATION WITH DVD ENTERTAINMENT SYSTEM

Connector No.	B48
Connector Name	SATELLITE RADIO TUNER
Connector Type	A16FW

Terminal No.	Color of Wire	Signal Name [Specification]
1	W/L	SOUND SIGNAL LH (-)
2	Y/L	SOUND SIGNAL LH (+)
3	Y/G	SOUND SIGNAL RH (-)
4	BR/L	SOUND SIGNAL RH (+)
5	SHIELD	SHIELD
6	SHIELD	SHIELD
8	R/W	REQUEST (SAT->CONT)
9	R/L	COMM (SAT->CONT)
10	B	COMM (CONT->SAT)
12	V	BATTERY
15	B	GND

Connector No.	B39
Connector Name	TEL ADAPTER UNIT
Connector Type	TH2FW-NH

Terminal No.	Color of Wire	Signal Name [Specification]
1	V	BATTERY
2	GR	ACC
3	R	IGNITION
4	B/W	GND
5	SHIELD	SHIELD
6	SHIELD	SHIELD
7	R/W	MICROPHONE SIGNAL
8	R/L	MICROPHONE GND
9	B/R	TEL VOICE SIGNAL (+)
10	W/R	TEL VOICE SIGNAL (-)
14	B	GND

Connector No.	B206
Connector Name	WIRE TO WIRE
Connector Type	NS16MW-CS

Terminal No.	Color of Wire	Signal Name [Specification]
1	W	
2	GR	
3	BR	
4	Y	
5	BR	
7	G	
12	R	
14	W/R	
15	B/R	

Connector No.	B77
Connector Name	WIRE TO WIRE
Connector Type	TK2MW

Terminal No.	Color of Wire	Signal Name [Specification]
6	R/L	
7	R/W	
8	B	
9	SHIELD	

Connector No.	B80
Connector Name	CAMERA CONTROL UNIT
Connector Type	TH2FW-NH

Terminal No.	Color of Wire	Signal Name [Specification]
5	SHIELD	SHIELD
6	B	CAMERA IMAGE SIGNAL
7	R/W	GND
8	R/L	CAMERA ON SIGNAL
11	SHIELD	SHIELD
12	B	CAMERA IMAGE SIGNAL
14	L	CONNECTION RECOGNITION
17	BR	AV COMM (L)
18	Y	AV COMM (H)
19	GR	AV COMM (L)
20	G	AV COMM (H)

Terminal No.	Color of Wire	Signal Name [Specification]
22	R	REVERSE
23	G	SENSOR SIGNAL 1
24	SB	SENSOR SIGNAL 2
25	O	SENSOR SIGNAL 3
26	BR	VEHICLE SPEED (8-PULSE)
30	GR	ACC
31	B	GND
32	V	BATTERY

Terminal No.	Color of Wire	Signal Name [Specification]
1	W	
2	GR	
3	BR	
4	Y	
5	BR	
7	G	
12	R	
14	W/R	
15	B/R	

Terminal No.	Color of Wire	Signal Name [Specification]
2	GR	
3	R	
4	B/W	
5	SHIELD	
6	SHIELD	
7	R/W	
8	R/L	
9	B/R	
10	W/R	
14	B	

TEL ADAPTER UNIT

[BOSE AUDIO WITHOUT NAVIGATION]

< ECU DIAGNOSIS >

BOSE AUDIO WITHOUT NAVIGATION WITH DVD ENTERTAINMENT SYSTEM

Connector No.	B218
Connector Name	WIRE TO WIRE
Connector Type	TK10FW-ANS

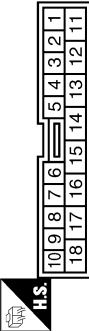

Connector No.	B219
Connector Name	WIRE TO WIRE
Connector Type	TH32MP-NH



Terminal No.	Color of Wire	Signal Name [Specification]
4	L	[With BOSE system]
5	O	[With BOSE system]

Terminal No.	Color of Wire	Signal Name [Specification]
1	W/R	
2	B/R	
3	SHIELD	
4	W/R	
5	B/R	
6	SHIELD	
7	GR/V	
8	W/L	
9	SHIELD	
10	GR/V	
11	W/L	

Connector No.	B224
Connector Name	BOSE AMP.
Connector Type	SGA12FBR-SJAZ

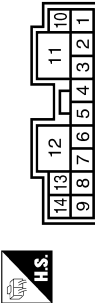

Connector No.	B225
Connector Name	BOSE AMP.
Connector Type	SCA19FBR-SGA4

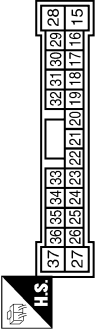

Terminal No.	Color of Wire	Signal Name [Specification]
1	LG	SOUND SIGNAL FRONT SQUAWKER LH (+)
2	V	SOUND SIGNAL FRONT SQUAWKER LH (-)
3	L	SOUND SIGNAL FRONT SQUAWKER RH (-)
4	P	SOUND SIGNAL FRONT SQUAWKER RH (+)
5	Y	SOUND SIGNAL REAR SPEAKER RH (+)
6	BR	SOUND SIGNAL REAR SPEAKER RH (-)
7	B	GND
8	BR	SOUND SIGNAL REAR SPEAKER LH (-)
9	O	SOUND SIGNAL REAR DOOR SPEAKER RH (-)
10	SB	BATTERY
11	GR	BATTERY

Terminal No.	Color of Wire	Signal Name [Specification]
15	R	SOUND SIGNAL REAR DOOR SPEAKER LH (-)
16	B/R	SOUND SIGNAL WOOFER (+)
17	W/R	SOUND SIGNAL WOOFER (-)
18	W	SOUND SIGNAL FRONT DOOR SPEAKER LH (-)
19	B	SOUND SIGNAL FRONT DOOR SPEAKER LH (+)
20	SB	AMP. ON SIGNAL
21	SHIELD	SHIELD
22	W	WOOFER AMP. ON SIGNAL
23	W/L	SOUND SIGNAL REAR LH (-)
24	GR/V	SOUND SIGNAL REAR LH (+)
25	W/L	SOUND SIGNAL REAR RH (-)

12	SHIELD
13	SB

26	GR/V	SOUND SIGNAL REAR RH (+)
28	G	SOUND SIGNAL REAR DOOR SPEAKER LH (+)
29	V	SOUND SIGNAL CENTER SPEAKER (+)
30	P	SOUND SIGNAL CENTER SPEAKER (-)
31	BR	SOUND SIGNAL FRONT DOOR SPEAKER RH (+)
32	Y	SOUND SIGNAL FRONT DOOR SPEAKER RH (-)
33	W/R	SOUND SIGNAL FRONT RH (+)
34	B/R	SOUND SIGNAL FRONT RH (-)
35	W/R	SOUND SIGNAL FRONT LH (-)
36	B/R	SOUND SIGNAL FRONT LH (+)

JCNWM1880G1

A
B
C
D
E
F
G
H
I
J
K
L
M
N
O
P

AV

TEL ADAPTER UNIT

[BOSE AUDIO WITHOUT NAVIGATION]

< ECU DIAGNOSIS >

BOSE AUDIO WITHOUT NAVIGATION WITH DVD ENTERTAINMENT SYSTEM

Connector No.	B226
Connector Name	WIRE TO WIRE
Connector Type	NS2MBR-CS

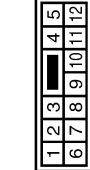

Terminal No.	Color of Wire	Signal Name [Specification]
1	V	-
2	BR	-
3	W	-
4	V	-
5	SB	-
6	P	-
7	Y	-
8	B	-
9	L	-
10	P	-
11	LG	-

Connector No.	B465
Connector Name	ANTENNA BASE (SATELLITE ANTENNA) WITH BOSE SYSTEM WITHOUT NAVIGATION SYSTEM
Connector Type	GT16C-1PP-HU



Terminal No.	1	Color of Wire	-	Signal Name [Specification]	SATELLITE ANTENNA
--------------	---	---------------	---	-----------------------------	-------------------

12	GR	-
----	----	---

Connector No.	B471
Connector Name	TEL ADAPTER UNIT
Connector Type	GT16C-1S-HU



Terminal No.	33	Color of Wire	-	Signal Name [Specification]	TEL ANTENNA SHIELD
	34	SHIELD	-	-	-

Connector No.	D21
Connector Name	WIRE TO WIRE
Connector Type	TH40FW-CS15

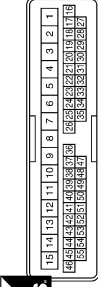

Terminal No.	4	Color of Wire	B/W	Signal Name [Specification]	-[Type A]
	4	B	-	-	-[Type B]
	5	L	-	-	-[Type A]
	5	W	-	-	-[Type B]

Connector No.	B482
Connector Name	SATELLITE RADIO TUNER
Connector Type	FAK6A



Terminal No.	33	Color of Wire	-	Signal Name [Specification]	SATELLITE ANTENNA
--------------	----	---------------	---	-----------------------------	-------------------

Connector No.	D41
Connector Name	WIRE TO WIRE
Connector Type	TH40FW-CS15

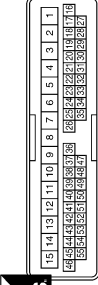

Terminal No.	4	Color of Wire	B/R	Signal Name [Specification]	-[Type A]
	4	B	-	-	-[Type B]
	5	BR	-	-	-[Type A]
	5	W	-	-	-[Type B]

JCNWM1881GI



TEL ADAPTER UNIT

[BOSE AUDIO WITHOUT NAVIGATION]

< ECU DIAGNOSIS >



BOSE AUDIO WITHOUT NAVIGATION WITH DVD ENTERTAINMENT SYSTEM

Connector No.	D106
Connector Name	REAR DOOR SPEAKER RH (WITH BOSE SYSTEM)
Connector Type	NS2ZFBF-CS

Terminal No.	Color of Wire	Signal Name [Specification]
1	O	- [Type A]
1	L	- [Type B]
2	B/P	- [Type A]
2	W	- [Type B]

Connector No.	D98
Connector Name	REAR DOOR SPEAKER LH (WITH BOSE SYSTEM)
Connector Type	NS2ZFBF-CS



Terminal No.	Color of Wire	Signal Name [Specification]
1	L	-
2	W	-

Connector No.	D81
Connector Name	WIRE TO WIRE
Connector Type	TK10MW-NS8

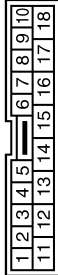

Terminal No.	Color of Wire	Signal Name [Specification]
4	L	-
5	W	-

Connector No.	D53
Connector Name	FRONT DOOR SPEAKER RH (WITH BOSE SYSTEM)
Connector Type	NS2ZFBF-CS



Terminal No.	Color of Wire	Signal Name [Specification]
1	BR	- [Type A]
1	W	- [Type B]
2	B/R	- [Type A]
2	B	- [Type B]

Connector No.	EB
Connector Name	WIRE TO WIRE
Connector Type	TK16MGY-TV

Terminal No.	Color of Wire	Signal Name [Specification]
4	R	-

Connector No.	D192
Connector Name	REAR VIEW CAMERA
Connector Type	TK4MMW-NH

Terminal No.	Color of Wire	Signal Name [Specification]
1	R	CAMERA ON SIGNAL
2	G	GND
3	B	CAMERA IMAGE SIGNAL
4	SHIELD	SHIELD

Connector No.	D182
Connector Name	WIRE TO WIRE
Connector Type	TK12FW

Terminal No.	Color of Wire	Signal Name [Specification]
6	R	-
7	G	-
8	B	-
9	SHIELD	-

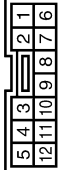
Connector No.	D155
Connector Name	WIRE TO WIRE
Connector Type	TK10MW-NS8

Terminal No.	Color of Wire	Signal Name [Specification]
4	O	- [Type A]
4	L	- [Type B]
5	B/P	- [Type A]
5	W	- [Type B]

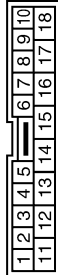
A
B
C
D
E
F
G
H
I
J
K
L
M
AV
O
P

TEL ADAPTER UNIT

[BOSE AUDIO WITHOUT NAVIGATION]

< ECU DIAGNOSIS >

BOSE AUDIO WITHOUT NAVIGATION WITH DVD ENTERTAINMENT SYSTEM

Connector No.	E18
Connector Name	ECM
Connector Type	RH24FB-R28-L-LH

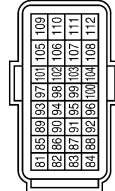

Terminal No.	Color of Wire	Signal Name [Specification]
97	P	VEHGAN-L
98	L	VEHGAN-H

Connector No.	E18
Connector Name	BACK-UP LAMP RELAY
Connector Type	MS02FL-M2-LC

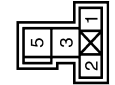

Terminal No.	Color of Wire	Signal Name [Specification]
1	LG	-
2	R	-
3	LG	-
5	R	-

Connector No.	E27
Connector Name	PARKING BRAKE SWITCH
Connector Type	F01FB-A



Terminal No.	Color of Wire	Signal Name [Specification]
1	P	-

Connector No.	E104
Connector Name	WIRE TO WIRE
Connector Type	NS36FW-CS

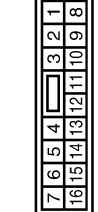

Terminal No.	Color of Wire	Signal Name [Specification]
4	R	-
5	L	-
6	P	-
7	L	-

Connector No.	E105
Connector Name	WIRE TO WIRE
Connector Type	TH70MW-CS10-M3

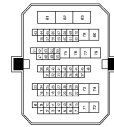

Terminal No.	Color of Wire	Signal Name [Specification]
5	LG	-
22	P	-
47	P	-
48	L	-
75	BR	-
76	GR	-
78	V	-

Connector No.	F23
Connector Name	TCM (TRANSMISSION CONTROL MODULE)
Connector Type	RH40FB-R26-L-RH

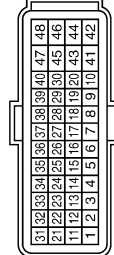

Terminal No.	Color of Wire	Signal Name [Specification]
19	G/B	REV LAMP RELAY

Connector No.	F123
Connector Name	WIRE TO WIRE
Connector Type	TK6FGY-1V

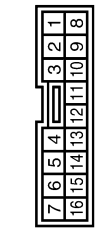

Terminal No.	Color of Wire	Signal Name [Specification]
4	G/B	-

Connector No.	M1
Connector Name	FUSE BLOCK (J/B)
Connector Type	NS06FW-M2

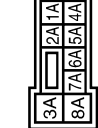

Terminal No.	Color of Wire	Signal Name [Specification]
2A	G	-
5A	R	-

JCNWM1883GI

TEL ADAPTER UNIT

[BOSE AUDIO WITHOUT NAVIGATION]

< ECU DIAGNOSIS >

BOSE AUDIO WITHOUT NAVIGATION WITH DVD ENTERTAINMENT SYSTEM

Connector No.	M3
Connector Name	FUSE BLOCK (J/B)
Connector Type	NS12FW-CS

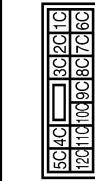

Terminal No.	Color of Wire	Signal Name [Specification]
12C	O	-

Connector No.	M4
Connector Name	DATA LINK CONNECTOR
Connector Type	BD16FW

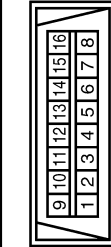

Terminal No.	Color of Wire	Signal Name [Specification]
6	L	-
14	P	-

Connector No.	M11
Connector Name	WIRE TO WIRE
Connector Type	TH10FW-CS10-M3

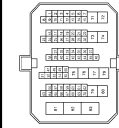

Terminal No.	Color of Wire	Signal Name [Specification]
5	O	-
22	G	-
47	P	-
48	L	-
75	BR	-
76	R	-
78	Y	-

Connector No.	M18
Connector Name	WIRE TO WIRE
Connector Type	TH40MW-CS15

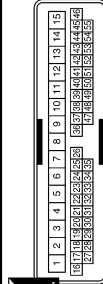

Terminal No.	Color of Wire	Signal Name [Specification]
4	W	-
5	BR	- [Type A and without BOSE system type B]
5	B	- [With BOSE system type B]

Connector No.	M20
Connector Name	WIRE TO WIRE
Connector Type	TH40MW-CS15

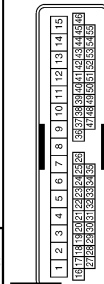

Terminal No.	Color of Wire	Signal Name [Specification]
4	B	-
5	L	-

Connector No.	M22
Connector Name	WIRE TO WIRE
Connector Type	TH12FW-NH

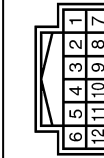

Terminal No.	Color of Wire	Signal Name [Specification]
1	V	-
2	R	-
3	R	-
4	G	-
5	W	-
6	SHIELD	-
7	LG	-
8	SHIELD	-
9	BR	-
10	SHIELD	-
11	L	-

Connector No.	M23
Connector Name	WIRE TO WIRE
Connector Type	TH16MW-NH



Terminal No.	Color of Wire	Signal Name [Specification]
1	W	-
2	R	- [With telephone without navigation system]
3	B	-
4	SHIELD	-

JCNWM1884GI

A
B
C
D
E
F
G
H
I
J
K
L
M
N
O
P

AV

TEL ADAPTER UNIT

[BOSE AUDIO WITHOUT NAVIGATION]

< ECU DIAGNOSIS >

BOSE AUDIO WITHOUT NAVIGATION WITH DVD ENTERTAINMENT SYSTEM

Connector No.	M30
Connector Name	STEERING ANGLE SENSOR
Connector Type	TH08FW-NH

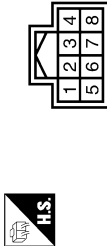

Terminal No.	Color of Wire	Signal Name [Specification]
1	B	-
3	L	-
4	G	-
6	SB	-
8	O	-

Connector No.	M33
Connector Name	COMBINATION SWITCH (SPIRAL CABLE)
Connector Type	TH08FGY-1V



Terminal No.	Color of Wire	Signal Name [Specification]
24	BR	- [With audio steering switch and telephone]
31	G	- [With audio steering switch and telephone]
33	L	- [With audio steering switch and telephone]

Connector No.	M34
Connector Name	COMBINATION METER
Connector Type	TH40FW-NH

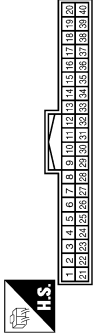

Terminal No.	Color of Wire	Signal Name [Specification]
21	L	CAN-H
22	P	CAN-L
31	V	VEHICLE SPEED (8-PULSE)

Connector No.	M44
Connector Name	WIRE TO WIRE
Connector Type	TH42FW-NH

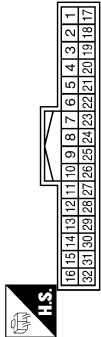

Terminal No.	Color of Wire	Signal Name [Specification]
1	G	-
2	R	-
3	SHIELD	-
4	B	-
5	W	-
6	SHIELD	-
7	O	- [Type A]
7	L	- [Type B]
8	SB	- [Type A]
8	R	- [Type B]
9	SHIELD	-

Terminal No.	10	V
11	LG	-
12	SHIELD	-
13	P	-

Connector No.	M49
Connector Name	FRONT DISPLAY UNIT
Connector Type	TH42FW-NH

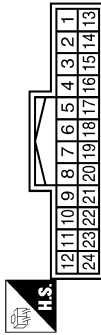

Terminal No.	Color of Wire	Signal Name [Specification]
1	B	GND
2	Y	INVERTER VCCI (Without navigation system)
3	O	SIGNAL VCCI (Without navigation system)
4	P	COMPOSITE IMAGE GND (Without navigation system)
5	SHIELD	SHIELD (Without navigation system)
6	L	RGB (GREEN) SIGNAL (Without navigation system)
7	SHIELD	SHIELD
8	G	HP (Without navigation system)
9	W	RGB AREA (YS) SIGNAL
11	R	COMM (CONT->DISP)
13	BR	INVERTER GND (Without navigation system)

14	LG	SIGNAL GND (Without navigation system)
15	L	COMPOSITE IMAGE SIGNAL (Without navigation system)
17	G	RGB (RED) SIGNAL
18	Y	RGB (BLUE) SIGNAL (Without navigation system)
19	B	RGB SYNC
20	R	VP
21	SHIELD	SHIELD
22	G	COMM (DISP->CONT)
23	SHIELD	SHIELD

JCNWM1885GI

TEL ADAPTER UNIT

[BOSE AUDIO WITHOUT NAVIGATION]

< ECU DIAGNOSIS >

BOSE AUDIO WITHOUT NAVIGATION WITH DVD ENTERTAINMENT SYSTEM

Connector No.	M65
Connector Name	FRONT SQUAWKER LH
Connector Type	TK02FBR



Terminal No.	Color of Wire	Signal Name [Specification]
1	LG	[With BOSE system]
2	Y	[With BOSE system]

Connector No.	M66
Connector Name	CENTER SPEAKER
Connector Type	TK02FBR



Terminal No.	Color of Wire	Signal Name [Specification]
1	P	
2	O	

Connector No.	M67
Connector Name	FRONT SQUAWKER RH
Connector Type	TK02FBR



Terminal No.	Color of Wire	Signal Name [Specification]
1	BR	
2	R	[With BOSE system]

Connector No.	M77
Connector Name	WIRE TO WIRE
Connector Type	TH80FW-C519

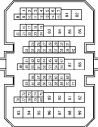

Terminal No.	Color of Wire	Signal Name [Specification]
1	SHIELD	
2	B	
3	W	
4	R	
8	SHIELD	
9	W	
10	R	
11	G	
12	B	
41	O	
42	SB	

43	L	
44	V	
45	P	
46	R	
47	Y	
48	L	
49	G	
50	SHIELD	
51	W	
56	P	
57	L	
58	SB	
59	SHIELD	
60	B	
61	R	
62	W	
68	G	
69	SHIELD	
70	L	
71	R	

Connector No.	M66
Connector Name	WIRE TO WIRE
Connector Type	TH18FW-NH

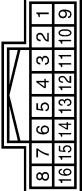

Terminal No.	Color of Wire	Signal Name [Specification]
1	Y	
3	R	
4	L	
5	L	
6	R	
7	SHIELD	
8	R	
9	G	
11	B	
12	G	
13	R	

14	W	
15	SHIELD	
16	B	

A
B
C
D
E
F
G
H
I
J
K
L
M
N
O
P

AV

JCNWM1886G1

TEL ADAPTER UNIT

[BOSE AUDIO WITHOUT NAVIGATION]

< ECU DIAGNOSIS >

BOSE AUDIO WITHOUT NAVIGATION WITH DVD ENTERTAINMENT SYSTEM

Connector No.	M122
Connector Name	BCM BODY CONTROL MODULE
Connector Type	TH40FB-NH

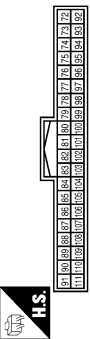

Terminal No.	Color of Wire	Signal Name [Specification]
90	P	CAN-L
91	L	CAN-H

Connector No.	M124
Connector Name	WIRE TO WIRE
Connector Type	NS12FBR-CS

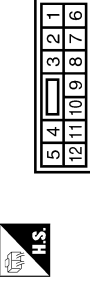

Terminal No.	Color of Wire	Signal Name [Specification]
1	P	-
2	BR	- [Type A]
3	B	- [Type B]
4	Y	-
5	BR	-
6	O	-
7	W	-
8	B	-
9	R	-
10	BR	-

Connector No.	M127
Connector Name	AV CONTROL UNIT (WITH BOSE SYSTEM WITHOUT NAVIGATION SYSTEM)
Connector Type	TH18FW-CS2

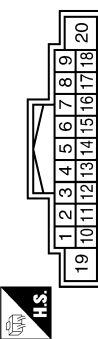

Terminal No.	Color of Wire	Signal Name [Specification]
6	BR	STRG SW A
7	R	ACC
9	R	ILLUMINATION
15	L	STRG SW GND
16	G	STRG SW B
19	Y	BATTERY
20	B	GND

Connector No.	M128
Connector Name	AV CONTROL UNIT (WITH BOSE SYSTEM WITHOUT NAVIGATION SYSTEM)
Connector Type	A12FW



Terminal No.	Color of Wire	Signal Name [Specification]
21	B	SATELLITE RADIO SOUND SIGNAL LH (-)
22	G	SATELLITE RADIO SOUND SIGNAL LH (+)
23	R	SATELLITE RADIO SOUND SIGNAL RH (-)
24	W	SATELLITE RADIO SOUND SIGNAL RH (+)
25	SHIELD	SHIELD
26	SHIELD	SHIELD
28	R	REQUEST (SAT->CONT)
29	W	COMM (SAT->CONT)
30	B	COMM (CONT->SAT)

11	LG
12	R

Connector No.	M125
Connector Name	MULTIFUNCTION SWITCH
Connector Type	TH16FW-NH

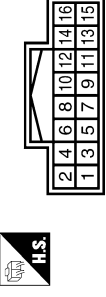

Terminal No.	Color of Wire	Signal Name [Specification]
1	B	GND
3	R	ACC
6	R	AV COMM (H)
8	L	AV COMM (L)
9	V	SW GND
14	W	EJECT SIGNAL

Connector No.	M129
Connector Name	AV CONTROL UNIT (WITH BOSE SYSTEM WITHOUT NAVIGATION SYSTEM)
Connector Type	TH24FW-NH

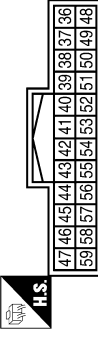

Terminal No.	Color of Wire	Signal Name [Specification]
36	L	COMPOSITE IMAGE SIGNAL
37	P	COMPOSITE IMAGE GND
38	Y	RGB (B/BLUE) SIGNAL
39	L	RGB (G/GREEN) SIGNAL
40	G	RGB (R/RED) SIGNAL
41	B	RGB SYNC
42	SHIELD	SHIELD
43	W	RGB AREA (YS) SIGNAL
44	G	COMM (DISP->CONT)
45	G	HP
46	LG	SIGNAL GND

Terminal No.	Color of Wire	Signal Name [Specification]
47	O	SIGNAL VCC
49	SHIELD	SHIELD
50	SHIELD	SHIELD
55	SHIELD	SHIELD
56	R	COMM (CONT->DISP)
57	R	VP
58	BR	INVERTER GND
59	Y	INVERTER VCC

TEL ADAPTER UNIT

[BOSE AUDIO WITHOUT NAVIGATION]

< ECU DIAGNOSIS >

BOSE AUDIO WITHOUT NAVIGATION WITH DVD ENTERTAINMENT SYSTEM

Connector No.	M130
Connector Name	AV CONTROL UNIT (WITH BOSE SYSTEM WITHOUT NAVIGATION SYSTEM)
Connector Type	TH116FW-NH



67	66	65	64	63	62	61	60
75	74	73	72	71	70	69	68

Connector No.	M131
Connector Name	AV CONTROL UNIT (WITH BOSE SYSTEM WITHOUT NAVIGATION SYSTEM)
Connector Type	TH122FW-NH



91	90	89	88	87	86	85	84	83	82	81	80	79	78	77	76
----	----	----	----	----	----	----	----	----	----	----	----	----	----	----	----

91	L	AV COMM (L)
98	G	SOUND SIGNAL LH (-) [With DVD player]
99	B	SOUND SIGNAL LH (+) [With DVD player]
100	SHIELD	SHIELD [With DVD player]
101	V	SW GND
103	W	EJECT SIGNAL
104	G	IGNITION
105	SB	REVERSE
106	G	PARKING BRAKE
107	V	VEHICLE SPEED (8-PULSE)

Terminal No.	Color of Wire	Signal Name [Specification]
64	SHIELD	SHIELD
65	W	CAMERA IMAGE SIGNAL
66	L	COMPOSITE IMAGE SIGNAL [With DVD player]
68	P	CONNECTION RECOGNITION
72	SHIELD	SHIELD [With DVD player]
74	R	COMPOSITE IMAGE GND [With DVD player]

Terminal No.	Color of Wire	Signal Name [Specification]
79	L	TEL VOICE SIGNAL (-)
80	R	TEL VOICE SIGNAL (+)
81	SHIELD	SHIELD
82	W	SOUND SIGNAL RH (-) [With DVD player]
83	R	SOUND SIGNAL RH (+) [With DVD player]
85	B	GND
86	L	CAN-H
87	P	CAN-L
88	R	AV COMM (H)
89	L	AV COMM (L)
90	G	AV COMM (H)

Connector No.	M132
Connector Name	AV CONTROL UNIT (WITH BOSE SYSTEM WITHOUT NAVIGATION SYSTEM)
Connector Type	TH122FW-NH



114	115	116	117	118	119
108	109	110	111	112	113

119	R	SOUND SIGNAL FRONT LH (-)
-----	---	---------------------------

Connector No.	M148
Connector Name	iPod ADAPTER
Connector Type	TH224FW-NH



1	2	3	4	5	6	7	8	9	10	11	12
13	14	15	16	17	18	19	20	21	22	23	24

14	W	iPod SOUND SIGNAL RH (-)
15	SHIELD	SHIELD
16	R	AV COMM (H)
17	SHIELD	GND
19	SHIELD	SHIELD
21	L	iPod CONNECTION RECOGNITION
22	BR	ACCESSORY DETECT
23	R	iPod SOUND SIGNAL GND
24	LG	iPod SOUND SIGNAL LH (+)

Terminal No.	Color of Wire	Signal Name [Specification]
108	V	SOUND SIGNAL REAR RH (+)
109	B	SOUND SIGNAL FRONT RH (+)
110	P	AMP. ON SIGNAL
111	SHIELD	SHIELD
112	O	SOUND SIGNAL REAR LH (+) [Type A]
112	L	SOUND SIGNAL REAR LH (+) [Type B]
113	G	SOUND SIGNAL FRONT LH (+)
114	LG	SOUND SIGNAL REAR RH (-)
115	W	SOUND SIGNAL FRONT RH (-)
118	SB	SOUND SIGNAL REAR LH (-) [Type A]
118	R	SOUND SIGNAL REAR LH (-) [Type B]

Terminal No.	Color of Wire	Signal Name [Specification]
1	BR	iPod SOUND SIGNAL LH (+)
2	R	iPod SOUND SIGNAL RH (+)
3	R	ACC
4	L	AV COMM (L)
5	Y	BATTERY
8	W	CHARGE POWER
9	G	COMM (iPod ADAPTER->iPod)
10	R	COMM (iPod->iPod ADAPTER)
11	R	ACCESSORY IDENTIFY
12	V	iPod SOUND SIGNAL RH (+)
13	L	iPod SOUND SIGNAL LH (-)

JCNWM1888GI

A
B
C
D
E
F
G
H
I
J
K
L
M
N
O
P

AV

TEL ADAPTER UNIT

[BOSE AUDIO WITHOUT NAVIGATION]

< ECU DIAGNOSIS >

BOSE AUDIO WITHOUT NAVIGATION WITH DVD ENTERTAINMENT SYSTEM

Connector No.	M204
Connector Name	WIRE TO WIRE
Connector Type	TH12MW-NH

Terminal No.	Color of Wire	Signal Name [Specification]
1	V	-
2	R	-
3	R	-
4	G	-
5	W	-
6	SHIELD	-
7	LG	-
8	SHIELD	-
9	BR	-
10	SHIELD	-
11	L	-

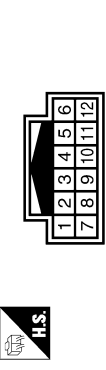

Terminal No.	Color of Wire	Signal Name [Specification]
14	W	-
15	SHIELD	-
16	B	-

Connector No.	M201
Connector Name	WIRE TO WIRE
Connector Type	TH16MW-NH



Terminal No.	Color of Wire	Signal Name [Specification]
1	Y	-
3	R	-
4	G	-
5	L	-
6	R	-
7	SHIELD	-
8	V	-
9	G	-
11	B	-
12	G	-
13	R	-

Terminal No.	Color of Wire	Signal Name [Specification]
18	R	HEADPHONE SOUND SIGNAL LH (-)
19	V	HEADPHONE SOUND SIGNAL RH (+)
20	LG	HEADPHONE SOUND SIGNAL RH (-)
21	B	SOUND SIGNAL LH (+)
22	G	SOUND SIGNAL LH (-)
23	R	SOUND SIGNAL RH (+)
24	W	SOUND SIGNAL RH (-)
29	L	AV COMM (L)
30	R	AV COMM (H)
31	L	AV COMM (L)
32	R	AV COMM (H)

Connector No.	M254
Connector Name	DVD PLAYER
Connector Type	TH32FW-NH

Connector No.	M253
Connector Name	AUXILIARY INPUT JACKS
Connector Type	A08FW

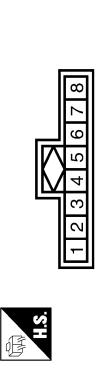
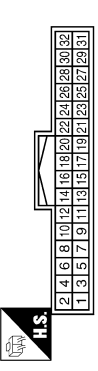

Terminal No.	Color of Wire	Signal Name [Specification]
1	B	GND
2	Y	BATTERY
4	V	ACC
5	SHIELD	SHIELD
7	P	DVD IMAGE SIGNAL
11	B	AUX SOUND SIGNAL LH (-)
12	W	AUX SOUND SIGNAL LH (+)
13	G	AUX SOUND SIGNAL RH (+)
14	R	AUX SOUND SIGNAL RH (-)
16	SHIELD	SHIELD
17	G	HEADPHONE SOUND SIGNAL LH (+)

Terminal No.	Color of Wire	Signal Name [Specification]
1	R	SOUND SIGNAL RH (+)
2	W	SOUND SIGNAL GND
3	G	SOUND SIGNAL LH (-) [Wth DVD player]
7	G	AUX IMAGE SIGNAL
8	SHIELD	SHIELD [Wth DVD player]

Connector No.	M255
Connector Name	VIDEO DISTRIBUTOR
Connector Type	TH08FW-NH

Terminal No.	Color of Wire	Signal Name [Specification]
53	B	GND
54	Y	BATTERY
55	V	ACC
56	G	IGNITION
60	R	HEADPHONE ON SIGNAL

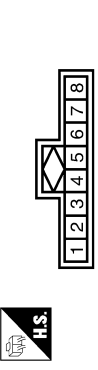
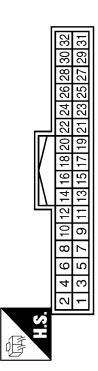

JCNWM1889G1

TEL ADAPTER UNIT

[BOSE AUDIO WITHOUT NAVIGATION]

< ECU DIAGNOSIS >

BOSE AUDIO WITHOUT NAVIGATION WITH DVD ENTERTAINMENT SYSTEM

Connector No.	M256
Connector Name	VIDEO DISTRIBUTOR
Connector Type	TH12FW-NH

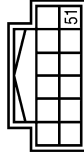

Terminal No.	Color of Wire	Signal Name [Specification]
51	B	GND

Connector No.	M257
Connector Name	VIDEO DISTRIBUTOR
Connector Type	TH11FW-NH

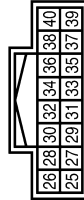

Terminal No.	Color of Wire	Signal Name [Specification]
25	R	RGB (R/RED) SIGNAL
26	L	RGB (G/GREEN) SIGNAL
27	W	RGB GND
28	G	RGB (B/BLUE) SIGNAL
29	R	YP
30	W	HP
31	SHIELD	SHIELD
32	B	RGB AREA (Y/S) SIGNAL
33	G	COMPOSITE SYNC
34	R	COMPOSITE IMAGE SIGNAL
35	SHIELD	SHIELD

Connector No.	M258
Connector Name	VIDEO DISTRIBUTOR
Connector Type	TH12FW-NH



Terminal No.	Color of Wire	Signal Name [Specification]
1	R	AV COMM (H)
2	G	AV COMM (L)
3	R	AV COMM (H)
4	L	AV COMM (L)
6	R	COMPOSITE IMAGE GND
8	L	COMPOSITE IMAGE SIGNAL
15	B	GND
16	B	GND
19	G	AUX IMAGE SIGNAL
21	SHIELD	SHIELD
22	SHIELD	SHIELD

36	G	IGNITION
38	SHIELD	SHIELD
39	V	COMM (DISP->DIST)
40	LG	COMM (DIST->DISP)

Connector No.	M259
Connector Name	WIRE TO WIRE
Connector Type	TH32MW-NH



Terminal No.	Color of Wire	Signal Name [Specification]
1	Y	-
3	R	-
4	SHIELD	-
5	LG	-
6	V	-
7	SHIELD	-
8	R	-
9	G	-
10	SHIELD	-
11	W	-
12	G	-

13	L	-
14	R	-
16	G	-
18	V	-
19	L	-
21	LG	-
22	V	-
23	SHIELD	-
24	B	-
25	W	-
26	R	-
27	SHIELD	-
28	G	-
29	R	-
30	SHIELD	-
31	R	-

JCNWM1890GI

A
B
C
D
E
F
G
H
I
J
K
L
M
N
O
P

AV

TEL ADAPTER UNIT

[BOSE AUDIO WITHOUT NAVIGATION]

< ECU DIAGNOSIS >

BOSE AUDIO WITHOUT NAVIGATION WITH DVD ENTERTAINMENT SYSTEM

Connector No.	M376
Connector Name	iPod SIDE
Connector Type	IP16FGY

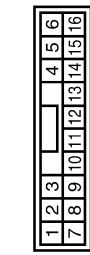

Terminal No.	Color of Wire	Signal Name [Specification]
1	LG	iPod SOUND SIGNAL LH (+)
2	R	iPod SOUND SIGNAL LH (-)
5	R	COMM (iPod->iPod ADAPTER)
6	G	COMM (iPod ADAPTER->iPod)
7	V	iPod SOUND SIGNAL RH (+)
8	L	iPod SOUND SIGNAL RH (-)
9	L	iPod CONNECTION RECOGNITION GND
10	SHIELD	CHARGE POWER
12	W	SHIELD
14	SHIELD	SHIELD
15	BR	ACCESSORY DETECT
16	R	ACCESSORY IDENTIFY

Connector No.	M376
Connector Name	WIRE TO WIRE
Connector Type	GT13SCN-2/1PP-HU



Terminal No.	Color of Wire	Signal Name [Specification]
1	-	-
2	-	-
3	-	-

Connector No.	M303
Connector Name	COMBINATION SWITCH (SPIRAL CABLE)
Connector Type	TK08FGY



Terminal No.	Color of Wire	Signal Name [Specification]
14	-	-
15	-	-
17	-	-

Connector No.	M378
Connector Name	ANTENNA BASE (ANTENNA AMP.)
Connector Type	GT13SSN-1/1PP-HU

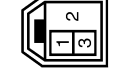

Terminal No.	Color of Wire	Signal Name [Specification]
1	-	-
3	-	-

Connector No.	M370
Connector Name	AV CONTROL UNIT (WITH BOSE SYSTEM WITHOUT NAVIGATION SYSTEM)
Connector Type	GT13SC-2/1S-HU



Terminal No.	Color of Wire	Signal Name [Specification]
33	-	FM SUB
34	-	AM-FM MAIN
35	-	ANTENNA AMP. ON SIGNAL

Connector No.	M379
Connector Name	GLASS ANTENNA
Connector Type	GT13SCN-1/1PP-HU



Terminal No.	Color of Wire	Signal Name [Specification]
2	-	FM SUB

Connector No.	M375
Connector Name	WIRE TO WIRE
Connector Type	GT13SH-2/1S-HU

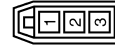

Terminal No.	Color of Wire	Signal Name [Specification]
1	-	-
2	-	-
3	-	-

Connector No.	FT
Connector Name	WIRE TO WIRE
Connector Type	TH16FW-NH

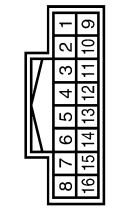

Terminal No.	Color of Wire	Signal Name [Specification]
1	R/W	-
2	R/L	-(With telephones without navigation system)
3	B	-
4	SHIELD	-

JCNWM1891GI

TEL ADAPTER UNIT

[BOSE AUDIO WITHOUT NAVIGATION]

< ECU DIAGNOSIS >

BOSE AUDIO WITHOUT NAVIGATION WITH DVD ENTERTAINMENT SYSTEM

Connector No.	R20
Connector Name	MICROPHONE
Connector Type	TH2FW-NH



Terminal No.	Color of Wire	Signal Name [Specification]
1	R/W	MICROPHONE SIGNAL (+)
2	R/L	MICROPHONE SIGNAL (-) (Only in vehicle with navigation system)
4	B	MICROPHONE POWER

Connector No.	R152
Connector Name	REAR DISPLAY UNIT
Connector Type	TH2FW-NH



Terminal No.	Color of Wire	Signal Name [Specification]
1	B	GND
2	B	GND
3	Y/R	BATTERY
4	Y/R	BATTERY
5	R	HEADPHONE ON SIGNAL
6	V/Y	ACC
8	SHIELD	SHIELD
9	V	COMM (DISP->DISP)
10	LG	COMM (DISP->DISP)
11	G	IGNITION
12	SHIELD	SHIELD

Connector No.	R153
Connector Name	WIRE TO WIRE
Connector Type	TH2FW-NH

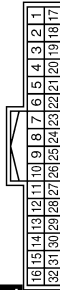

Terminal No.	Color of Wire	Signal Name [Specification]
1	Y/R	-
2	B	-
4	SHIELD	-
5	LG	-
6	V	-
7	SHIELD	-
8	BR	-
9	Y	-
10	SHIELD	-
11	W/L	-
12	Y/G	-

13	G	COMPOSITE SYNC
14	R	COMPOSITE IMAGE SIGNAL
15	B	RGB AREA (V/S) SIGNAL
16	SHIELD	GND
17	R	VP
18	W	HP
19	W/L	RGB GND
20	Y/G	RGR (B/BLUE) SIGNAL
21	Y/L	RGB (G/GREEN) SIGNAL
22	BR/L	RGB (R/RED) SIGNAL
23	SHIELD	SHIELD
24	SHIELD	SHIELD
25	LG	HEADPHONE SOUND SIGNAL RH (-)
26	BR	HEADPHONE SOUND SIGNAL LH (-)
27	V	HEADPHONE SOUND SIGNAL RH (+)
28	Y	HEADPHONE SOUND SIGNAL LH (+)

A
B
C
D
E
F
G
H
I
J
K
L
M
N
O
P

AV

JCNWM1892GI

CAMERA CONTROL UNIT

[BOSE AUDIO WITHOUT NAVIGATION]

< ECU DIAGNOSIS >

CAMERA CONTROL UNIT

Reference Values

INFOID:000000003457775

TERMINAL LAYOUT

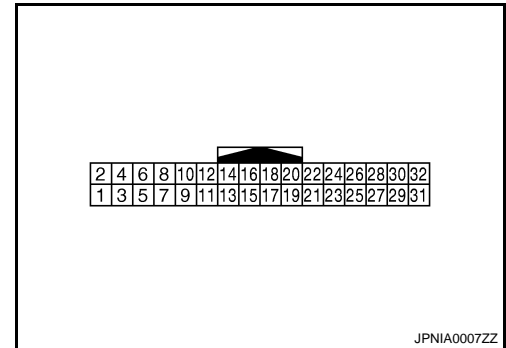

PHYSICAL VALUES

Terminal (Wire color)		Description		Condition		Reference value (Approx.)
+	-	Signal name	Input/ Output			
5	—	Shield	—	—	—	—
6 (B)	Ground	Camera image signal	Input	Ignition switch ON	when rear view camera im- age is displayed.	<p style="text-align: right;">SKIB2251J</p>
7 (R/W)	Ground	Rear view camera ground	—	Ignition switch ON	—	0 V
8 (R/L)	Ground	Camera ON signal	Output	Ignition switch ON	R position.	6.0 V
					Other than R position.	0 V
11	Ground	Shield (camera image ground)	—	Ignition switch ON	—	0 V
12 (B)	11	Camera image signal	Output	Ignition switch ON	when rear view camera im- age is displayed.	<p style="text-align: right;">SKIB2251J</p>
14 (L)	Ground	Camera-connection recog- nition signal	Output	Ignition switch ON	Connected to camera con- trol unit connector.	0 V
					Not connected to camera control unit connector.	5.0 V
17 (BR)	—	AV communication signal (L)	Input/ Output	—	—	—
18 (Y)	—	AV communication signal (H)	Input/ Output	—	—	—

CAMERA CONTROL UNIT

[BOSE AUDIO WITHOUT NAVIGATION]

< ECU DIAGNOSIS >

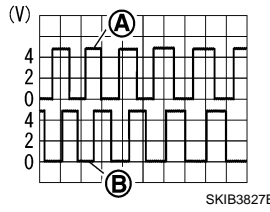
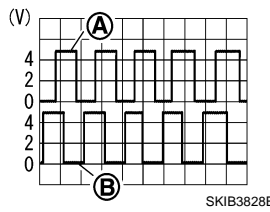
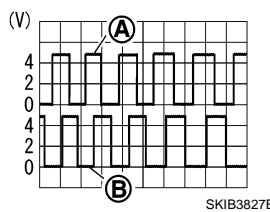
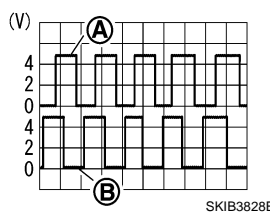
Terminal (Wire color)		Description		Condition		Reference value (Approx.)
+	-	Signal name	Input/ Output			
19 (GR)	—	AV communication signal (L)	Input/ Output	—	—	—
20 (G)	—	AV communication signal (H)	Input/ Output	—	—	—
22 (R)	Ground	Reverse signal	Input	Ignition switch ON	R position.	12.0 V
				Other than R position.	0 V	
23 (G)	Ground	Sensor signal 1	Input	Ignition switch ON	Turn the steering to the right.	 <p style="text-align: center;">A: Sensor signal 1 B: Sensor signal 2</p>
					Turn the steering to the left.	 <p style="text-align: center;">A: Sensor signal 1 B: Sensor signal 2</p>
24 (SB)	Ground	Sensor signal 2	Input	Ignition switch ON	Turn the steering to the right.	 <p style="text-align: center;">A: Sensor signal 1 B: Sensor signal 2</p>
					Turn the steering to the left.	 <p style="text-align: center;">A: Sensor signal 1 B: Sensor signal 2</p>

A
B
C
D
E
F
G
H
I
J
K
L
M
O
P

AV

CAMERA CONTROL UNIT

[BOSE AUDIO WITHOUT NAVIGATION]

< ECU DIAGNOSIS >

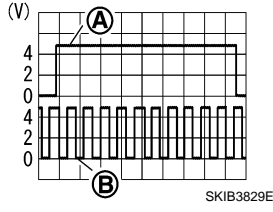
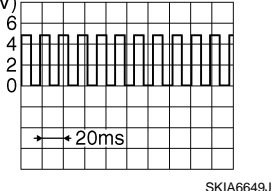
Terminal (Wire color)		Description		Condition		Reference value (Approx.)
+	-	Signal name	Input/ Output			
25 (O)	Ground	Sensor signal 3	Input	Ignition switch ON	Turn the steering around the neutral position.	 <p>A: Sensor signal 3 B: Sensor signal 1</p>
26 (BR)	Ground	Vehicle speed signal (8-pulse)	Input	Ignition switch ON	When vehicle speed is ap- prox. 40 km/h (25 MPH).	<p>NOTE: Maximum voltage may be 12 V due to specifications (connected units).</p> 
30 (GR)	Ground	ACC power supply	Input	Ignition switch ACC	—	Battery voltage
31 (B)	Ground	Ground	—	Ignition switch ON	—	0 V
32 (V)	Ground	Battery power supply	Input	Ignition switch OFF	—	Battery voltage

Wiring Diagram - BOSE AUDIO WITHOUT NAVIGATION WITHOUT DVD ENTERTAINMENT SYSTEM -

INFOID:000000003702921

NOTE:

- In this section, PRESET SWITCH and MULTIFUNCTION SWITCH are written as the MULTIFUNCTION SWITCH.
- Type A: Up to VIN: JN8AZ18U*9W100000, JN8AZ18W*9W200000 (EXCEPT FOR MEXICO), JN8AZ18U*9W710000, JN8AZ18W*9W810000 (FOR MEXICO)

CAMERA CONTROL UNIT

[BOSE AUDIO WITHOUT NAVIGATION]

< ECU DIAGNOSIS >

- Type B: From VIN: JN8AZ18U*9W10001, JN8AZ18W*9W20001 (EXCEPT FOR MEXICO), JN8AZ18U*9W710001, JN8AZ18W*9W810001 (FOR MEXICO)

BOSE AUDIO WITHOUT NAVIGATION WITHOUT DVD ENTERTAINMENT SYSTEM

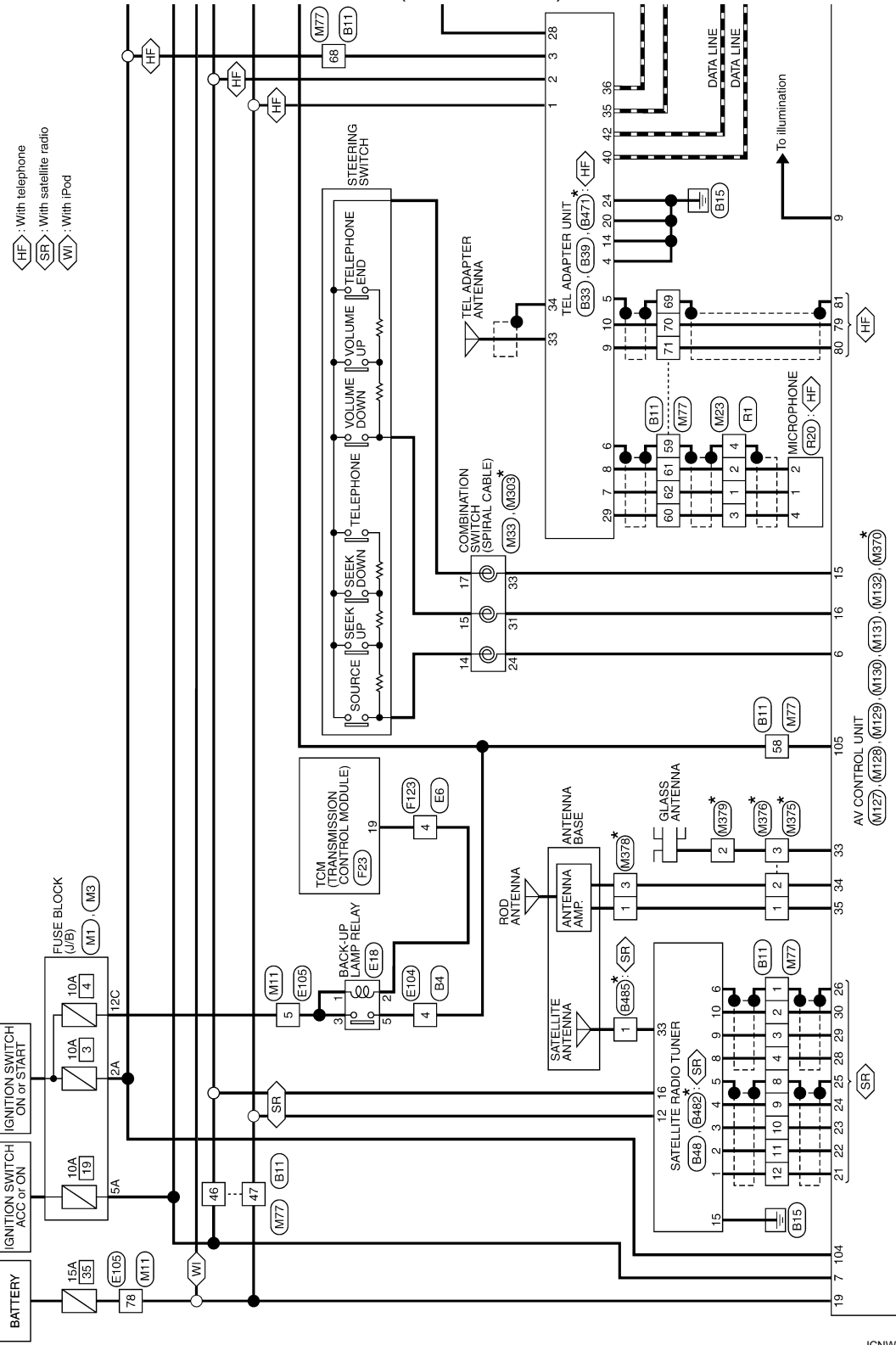

*: This connector is not shown in "Harness Layout".

2008/09/23

JCNWM1855GI

A
B
C
D
E
F
G
H
I
J
K
L
M
N
O
P

AV

CAMERA CONTROL UNIT

[BOSE AUDIO WITHOUT NAVIGATION]

< ECU DIAGNOSIS >

- : With telephone
- : Without telephone
- : With iPod

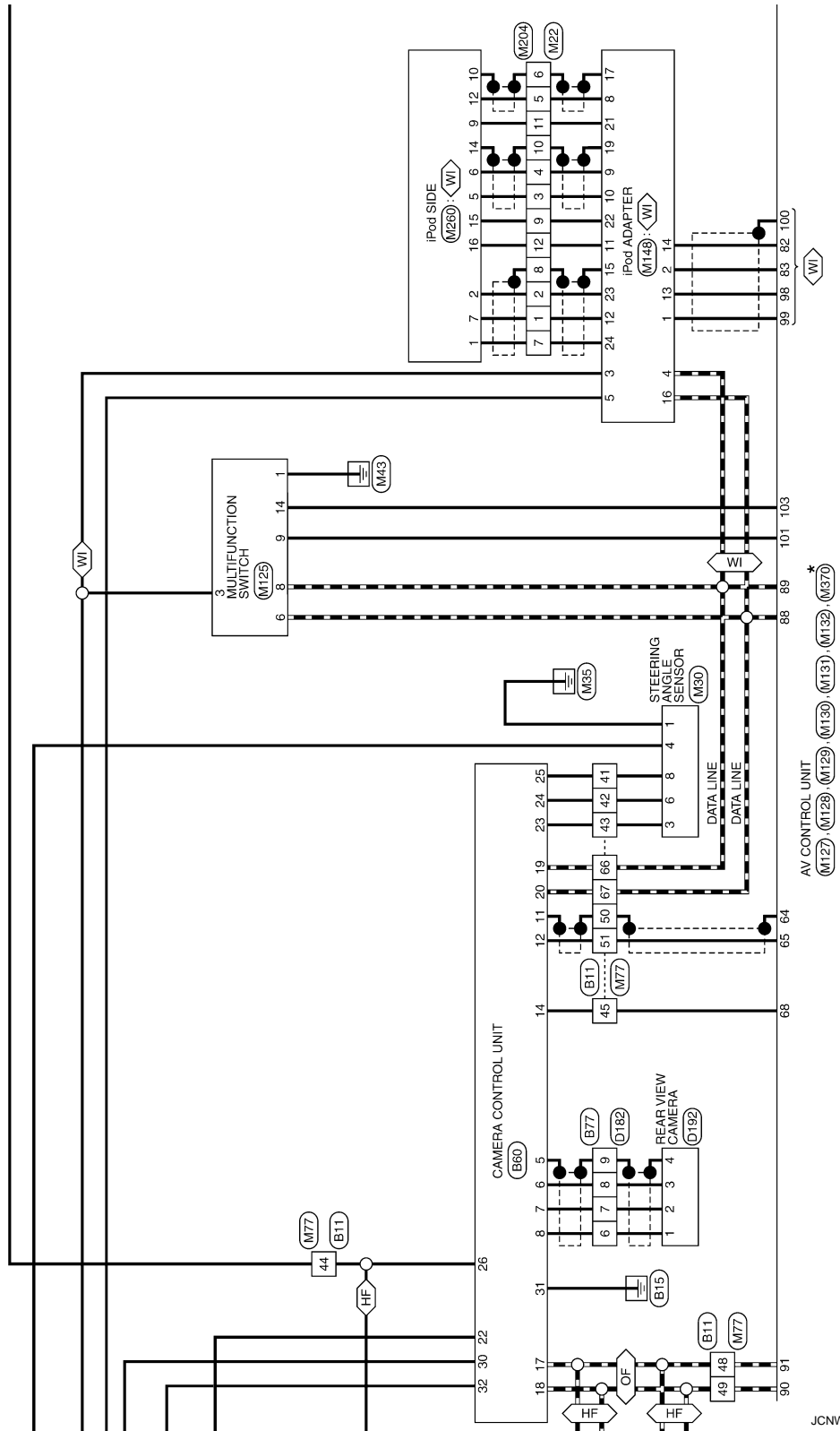

*: This connector is not shown in "Harness Layout".

JCNWM1856GI

CAMERA CONTROL UNIT

[BOSE AUDIO WITHOUT NAVIGATION]

< ECU DIAGNOSIS >

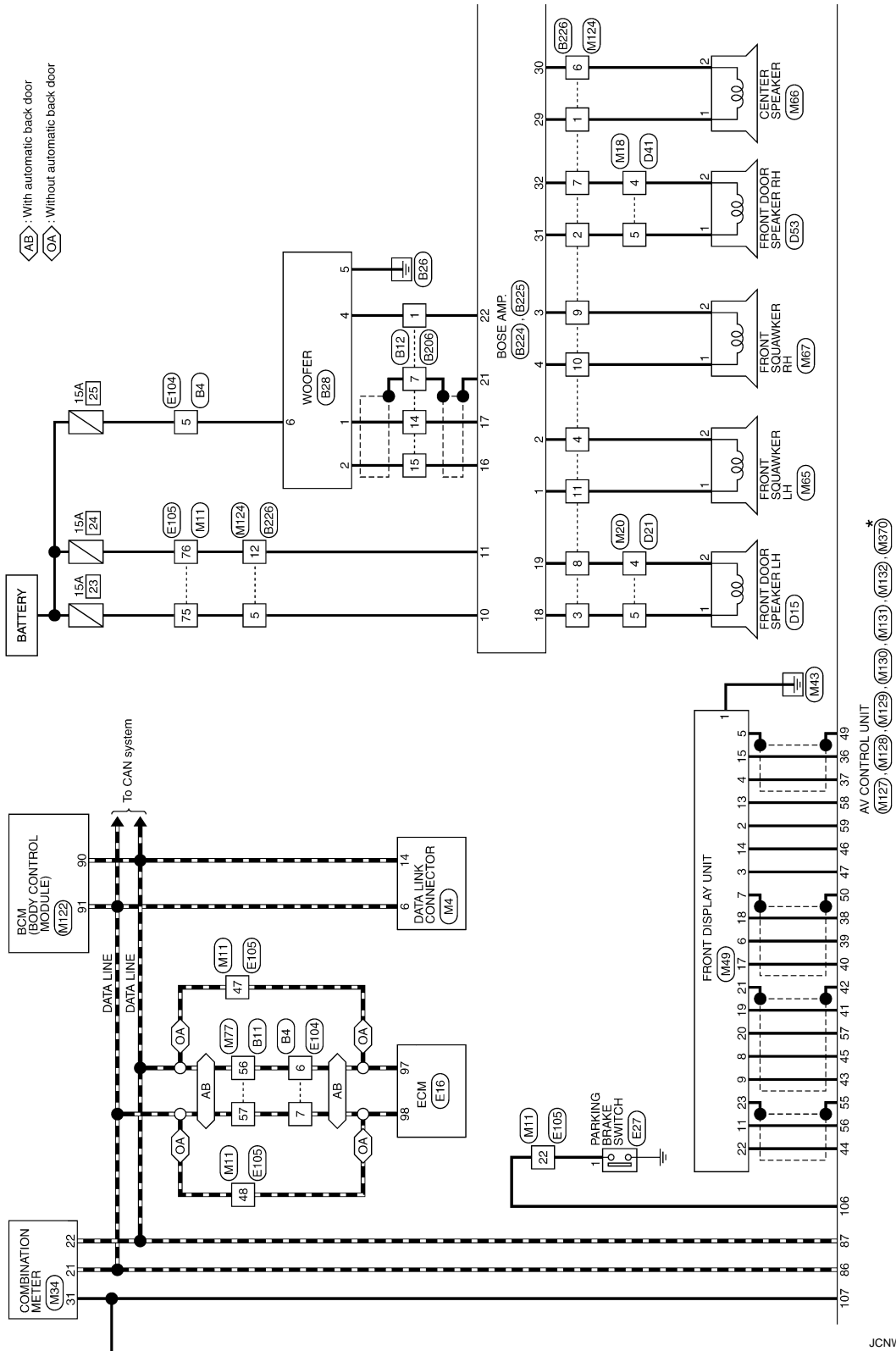

*: This connector is not shown in "Harness Layout".

JCNWM1857GI

A
B
C
D
E
F
G
H
I
J
K
L
M
N
O
P

AV

CAMERA CONTROL UNIT

[BOSE AUDIO WITHOUT NAVIGATION]

< ECU DIAGNOSIS >

TA : Type A
TB : Type B

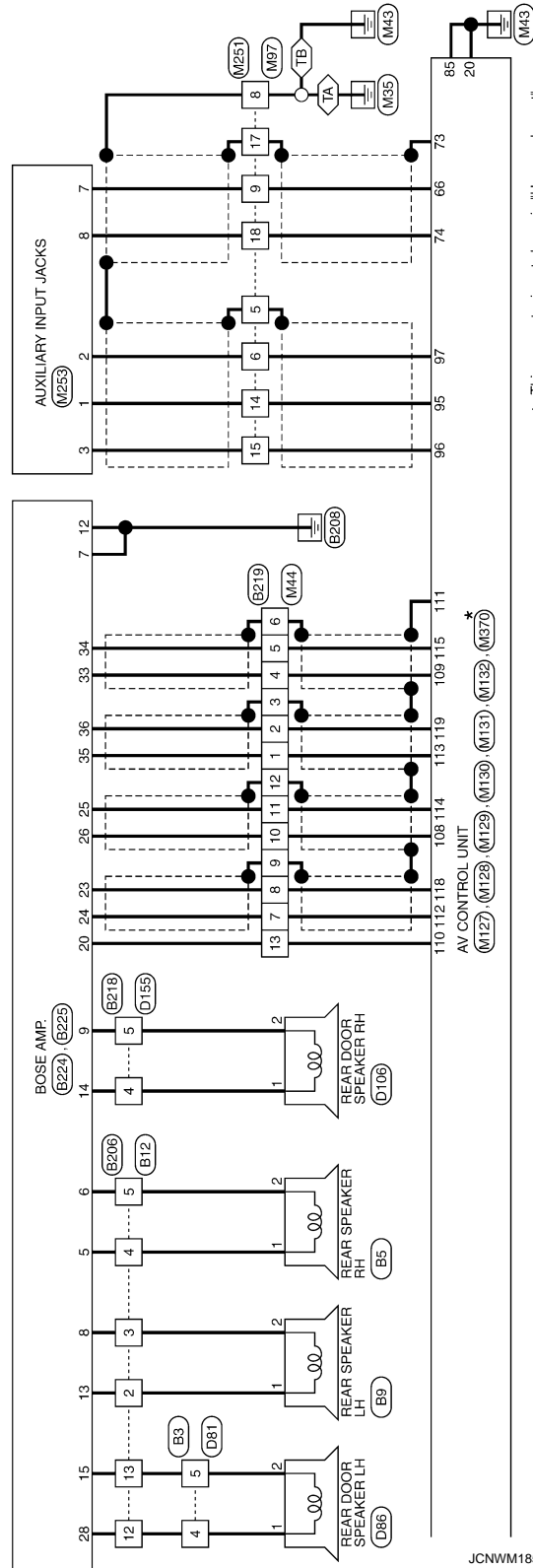

*: This connector is not shown in "Harness Layout".

JCNW18586I

CAMERA CONTROL UNIT

[BOSE AUDIO WITHOUT NAVIGATION]

< ECU DIAGNOSIS >

BOSE AUDIO WITHOUT NAVIGATION WITHOUT DVD ENTERTAINMENT SYSTEM

Connector No.	B3
Connector Name	WIRE TO WIRE
Connector Type	TK0DFW-ANS8



Connector No.	B4
Connector Name	WIRE TO WIRE
Connector Type	NS16MHW-CS



Connector No.	B5
Connector Name	REAR SPEAKER RH
Connector Type	TK02FBR

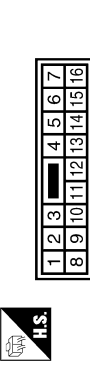

Connector No.	B8
Connector Name	REAR SPEAKER LH
Connector Type	TK02FBR



Terminal No.	Color of Wire	Signal Name [Specification]
1	SB	-
2	GR	-

Terminal No.	Color of Wire	Signal Name [Specification]
1	V	-
2	LG	-

Terminal No.	Color of Wire	Signal Name [Specification]
4	R	-
5	O	-
6	P	-
7	L	-

Terminal No.	Color of Wire	Signal Name [Specification]
4	LG	-
5	O	-

Connector No.	B11
Connector Name	WIRE TO WIRE
Connector Type	TH80MW-CS19



Connector No.	B12
Connector Name	WIRE TO WIRE
Connector Type	NS18FW-CS

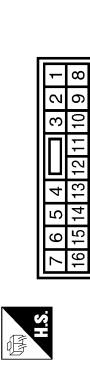

43	G	-
44	BR	-
45	L	-
46	GR	-
47	V	-
48	GR	-(With rear view camera and telephone)
48	BR	-(With rear view camera without telephone)
49	Y	-
50	SHIELD	-
51	B	-
56	P	-
57	L	-
58	R	-
59	SHIELD	-
60	B	-
61	R/L	-
62	R/W	-
66	GR	-
67	G	-
68	R	-
69	SHIELD	-
70	W/R	-
71	B/R	-

Terminal No.	Color of Wire	Signal Name [Specification]
1	SHIELD	-
2	B	-
3	R/L	-
4	R/W	-
8	SHIELD	-
9	BR/L	-
10	Y/G	-
11	Y/L	-
12	W/L	-
41	O	-
42	SB	-

Connector No.	B28
Connector Name	WOOFER
Connector Type	RS08FGY-PR



Terminal No.	Color of Wire	Signal Name [Specification]
1	W/R	SOUND SIGNAL WOOFER (-)
2	B/R	SOUND SIGNAL WOOFER (+)
4	W	WOOFER AMP- ON SIGNAL
5	B/W	GND
6	O	BAT

Terminal No.	Color of Wire	Signal Name [Specification]
1	W	-
2	SB	-
3	GR	-
4	V	-
5	LG	-
7	SHIELD	-
12	LG	-
13	O	-
14	W/R	-
15	B/R	-

Terminal No.	Color of Wire	Signal Name [Specification]
1	SHIELD	-
2	B	-
3	R/L	-
4	R/W	-
8	SHIELD	-
9	BR/L	-
10	Y/G	-
11	Y/L	-
12	W/L	-
41	O	-
42	SB	-

A B C D E F G H I J K L M O P

AV

JCNWM1859GI

CAMERA CONTROL UNIT

[BOSE AUDIO WITHOUT NAVIGATION]

< ECU DIAGNOSIS >

BOSE AUDIO WITHOUT NAVIGATION WITHOUT DVD ENTERTAINMENT SYSTEM

Connector No.	B33
Connector Name	TEL ADAPTER UNIT
Connector Type	TH32FW-NH

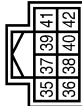

Terminal No.	Color of Wire	Signal Name [Specification]
35	Y	AV COMM (H)
36	BR	AV COMM (L)
40	G	AV COMM (H)
42	GR	AV COMM (L)

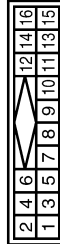

Connector No.	B48
Connector Name	SATELLITE RADIO TUNER
Connector Type	A18FW

Connector No.	B39
Connector Name	TEL ADAPTER UNIT
Connector Type	TH32FW-NH

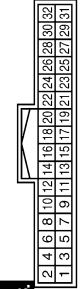

Terminal No.	Color of Wire	Signal Name [Specification]
1	V	BATTERY
2	GR	ACC
3	R	IGNITION
4	B/W	GND
5	SHIELD	SHIELD
6	SHIELD	SHIELD
7	R/W	MICROPHONE SIGNAL
8	R/L	MICROPHONE GND
9	B/R	TEL VOICE SIGNAL (+)
10	W/R	TEL VOICE SIGNAL (-)
14	B	GND

Terminal No.	16
Color of Wire	GR
Signal Name [Specification]	ACC

Terminal No.	20
Color of Wire	B
Signal Name [Specification]	CONTROL SIGNAL
Terminal No.	24
Color of Wire	B/W
Signal Name [Specification]	CONTROL SIGNAL
Terminal No.	28
Color of Wire	BR
Signal Name [Specification]	VEHICLE SPEED (8-PULSE)
Terminal No.	29
Color of Wire	B
Signal Name [Specification]	MICROPHONE VCC

Connector No.	B60
Connector Name	CAMERA CONTROL UNIT
Connector Type	TH32FW-NH

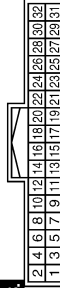

Terminal No.	Color of Wire	Signal Name [Specification]
1	W/L	SOUND SIGNAL LH (-)
2	Y/L	SOUND SIGNAL LH (+)
3	Y/G	SOUND SIGNAL RH (-)
4	BR/L	SOUND SIGNAL RH (+)
5	SHIELD	SHIELD
6	SHIELD	SHIELD
8	R/W	REQUEST (SAT->CONT)
9	R/L	COMM (SAT->CONT)
10	B	COMM (CONT->SAT)
12	V	BATTERY
15	B	GND

Terminal No.	22
Color of Wire	R
Signal Name [Specification]	REVERSE
Terminal No.	23
Color of Wire	G
Signal Name [Specification]	SENSOR SIGNAL 1
Terminal No.	24
Color of Wire	SB
Signal Name [Specification]	SENSOR SIGNAL 2
Terminal No.	25
Color of Wire	O
Signal Name [Specification]	SENSOR SIGNAL 3
Terminal No.	26
Color of Wire	BR
Signal Name [Specification]	VEHICLE SPEED (8-PULSE)
Terminal No.	30
Color of Wire	GR
Signal Name [Specification]	ACC
Terminal No.	31
Color of Wire	B
Signal Name [Specification]	GND
Terminal No.	32
Color of Wire	V
Signal Name [Specification]	BATTERY

Terminal No.	Color of Wire	Signal Name [Specification]
5	SHIELD	SHIELD
6	B	CAMERA IMAGE SIGNAL
7	R/W	GND
8	R/L	CAMERA ON SIGNAL
11	SHIELD	SHIELD
12	B	CAMERA IMAGE SIGNAL
14	L	CONNECTION RECOGNITION
17	BR	AV COMM (L)
18	Y	AV COMM (H)
19	GR	AV COMM (L)
20	G	AV COMM (H)

CAMERA CONTROL UNIT

[BOSE AUDIO WITHOUT NAVIGATION]

< ECU DIAGNOSIS >

BOSE AUDIO WITHOUT NAVIGATION WITHOUT DVD ENTERTAINMENT SYSTEM

Connector No.	B77
Connector Name	WIRE TO WIRE
Connector Type	TK12MW

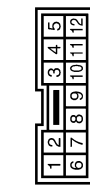

Terminal No.	Color of Wire	Signal Name [Specification]
6	R/L	-
7	R/W	-
8	B	-
9	SHIELD	-

Connector No.	B219
Connector Name	WIRE TO WIRE
Connector Type	TH22MW-NH



Terminal No.	Color of Wire	Signal Name [Specification]
1	W/R	-
2	B/R	-
3	SHIELD	-
4	W/R	-
5	B/R	-
6	SHIELD	-
7	GR/V	-
8	W/L	-
9	SHIELD	-
10	GR/V	-
11	W/L	-

Connector No.	B206
Connector Name	WIRE TO WIRE
Connector Type	NS16MH-CS



Terminal No.	Color of Wire	Signal Name [Specification]
1	W	-
2	GR	-
3	BR	-
4	Y	-
5	BR	-
7	SHIELD	-
12	G	-
13	R	-
14	W/R	-
15	B/R	-

Terminal No.	12	SHIELD
Terminal No.	13	SB

Connector No.	B218
Connector Name	WIRE TO WIRE
Connector Type	TK16FW-NSB

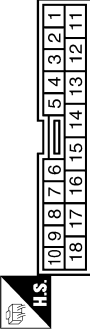

Terminal No.	Color of Wire	Signal Name [Specification]
4	L	- [With BOSE system]
5	O	- [With BOSE system]

Connector No.	B224
Connector Name	BOSE AMP.
Connector Type	SGA12FBR-SJA2

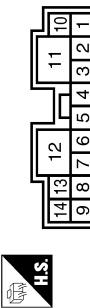

Terminal No.	12	B	GND
Terminal No.	13	GR	SOUND SIGNAL REAR SPEAKER LH (+)
Terminal No.	14	L	SOUND SIGNAL REAR DOOR SPEAKER RH (+)

Terminal No.	Color of Wire	Signal Name [Specification]
1	LG	SOUND SIGNAL FRONT SQUAWKER LH (+)
2	V	SOUND SIGNAL FRONT SQUAWKER LH (-)
3	L	SOUND SIGNAL FRONT SQUAWKER RH (-)
4	P	SOUND SIGNAL FRONT SQUAWKER RH (+)
5	Y	SOUND SIGNAL REAR SPEAKER RH (+)
6	BR	SOUND SIGNAL REAR SPEAKER RH (-)
7	B	GND
8	BR	SOUND SIGNAL REAR SPEAKER LH (-)
9	O	SOUND SIGNAL REAR DOOR SPEAKER RH (-)
10	SB	BATTERY
11	GR	BATTERY

JCNWM1861G1

A
B
C
D
E
F
G
H
I
J
K
L
M
O
P

AV

CAMERA CONTROL UNIT

[BOSE AUDIO WITHOUT NAVIGATION]

< ECU DIAGNOSIS >

BOSE AUDIO WITHOUT NAVIGATION WITHOUT DVD ENTERTAINMENT SYSTEM

Connector No.	B225
Connector Name	BOSE AMP.
Connector Type	SCA19FBR-SGA4

37	38	35	34	33	32	31	30	29	28			
27	26	25	24	23	22	21	20	19	18	17	16	15

Terminal No.	Color of Wire	Signal Name [Specification]
15	R	SOUND SIGNAL REAR DOOR SPEAKER LH (-)
16	B/R	SOUND SIGNAL REAR DOOR SPEAKER LH (+)
17	W/R	SOUND SIGNAL WOOFER (+)
18	W	SOUND SIGNAL FRONT DOOR SPEAKER LH (+)
19	B	SOUND SIGNAL FRONT DOOR SPEAKER LH (-)
20	SB	AMP ON SIGNAL
21	SHIELD	SHIELD
22	W	WOOFER AMP ON SIGNAL
23	W/L	SOUND SIGNAL REAR LH (-)
24	GR/V	SOUND SIGNAL REAR LH (+)
25	W/L	SOUND SIGNAL REAR RH (-)

Connector No.	B471
Connector Name	TEL ADAPTER UNIT
Connector Type	GT16C-IS-HU

33	34
----	----

Terminal No.	Color of Wire	Signal Name [Specification]
33	-	TEL ANTENNA
34	SHIELD	SHIELD

26	GR/V	SOUND SIGNAL REAR RH (+)
28	G	SOUND SIGNAL REAR DOOR SPEAKER LH (+)
29	V	SOUND SIGNAL CENTER SPEAKER (+)
30	P	SOUND SIGNAL CENTER SPEAKER (-)
31	BR	SOUND SIGNAL FRONT DOOR SPEAKER RH (+)
32	Y	SOUND SIGNAL FRONT DOOR SPEAKER RH (-)
33	W/R	SOUND SIGNAL FRONT RH (+)
34	B/R	SOUND SIGNAL FRONT RH (-)
35	W/R	SOUND SIGNAL FRONT LH (+)
36	B/R	SOUND SIGNAL FRONT LH (-)

Connector No.	B326
Connector Name	WIRE TO WIRE
Connector Type	NS12MR-CS

1	2	3	4	5		
6	7	8	9	10	11	12

Terminal No.	Color of Wire	Signal Name [Specification]
1	V	-
2	BR	-
3	W	-
4	V	-
5	SB	-
6	P	-
7	Y	-
8	B	-
9	L	-
10	P	-
11	LG	-

Connector No.	B485
Connector Name	ANTENNA BASE (SATELLITE ANTENNA) (WITH BOSE SYSTEM WITHOUT NAVIGATION SYSTEM)
Connector Type	GT16C-1PP-HU

1	2
---	---

Terminal No.	Color of Wire	Signal Name [Specification]
1	-	SATELLITE ANTENNA

12	GR
----	----

Connector No.	DI5
Connector Name	FRONT DOOR SPEAKER LH (WITH BOSE SYSTEM)
Connector Type	NS02FBR-CS

2	1
---	---

Terminal No.	Color of Wire	Signal Name [Specification]
1	L	-[Type A]
1	W	-[Type B]
2	B/W	-[Type A]
2	B	-[Type B]

JCNWM1862GI

CAMERA CONTROL UNIT

[BOSE AUDIO WITHOUT NAVIGATION]

< ECU DIAGNOSIS >

BOSE AUDIO WITHOUT NAVIGATION WITHOUT DVD ENTERTAINMENT SYSTEM

Connector No.	D81
Connector Name	WIRE TO WIRE
Connector Type	TK10MW-NS8



Terminal No.	Color of Wire	Signal Name [Specification]
4	L	-
5	W	-

Connector No.	D53
Connector Name	FRONT DOOR SPEAKER RH (WITH BOSE SYSTEM)
Connector Type	NS2ZFBF-CS



Terminal No.	Color of Wire	Signal Name [Specification]
1	BR	-[Type A]
1	W	-[Type B]
2	B/R	-[Type A]
2	B	-[Type B]

Connector No.	D41
Connector Name	WIRE TO WIRE
Connector Type	TH4QFW-CS15



Terminal No.	Color of Wire	Signal Name [Specification]
4	B/R	-[Type A]
4	B	-[Type B]
5	BR	-[Type A]
5	W	-[Type B]

Connector No.	D21
Connector Name	WIRE TO WIRE
Connector Type	TH4QFW-CS15



Terminal No.	Color of Wire	Signal Name [Specification]
4	B/W	-[Type A]
4	B	-[Type B]
5	L	-[Type A]
5	W	-[Type B]

Connector No.	D182
Connector Name	WIRE TO WIRE
Connector Type	TK12FW

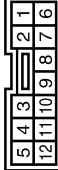

Connector No.	D155
Connector Name	WIRE TO WIRE
Connector Type	TK10MW-NS8

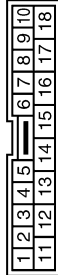

Connector No.	D108
Connector Name	REAR DOOR SPEAKER RH (WITH BOSE SYSTEM)
Connector Type	NS2ZFBF-CS



Connector No.	D86
Connector Name	REAR DOOR SPEAKER LH (WITH BOSE SYSTEM)
Connector Type	NS2ZFBF-CS



Terminal No.	Color of Wire	Signal Name [Specification]
6	R	-
7	G	-
8	B	-
9	SHIELD	-

Terminal No.	Color of Wire	Signal Name [Specification]
4	O	-[Type A]
4	L	-[Type B]
5	B/P	-[Type A]
5	W	-[Type B]

Terminal No.	Color of Wire	Signal Name [Specification]
1	O	-[Type A]
1	L	-[Type B]
2	B/P	-[Type A]
2	W	-[Type B]

Terminal No.	Color of Wire	Signal Name [Specification]
1	L	-
2	W	-

JCNWM1863GI

A
B
C
D
E
F
G
H
I
J
K
L
M
AV
O
P

CAMERA CONTROL UNIT

[BOSE AUDIO WITHOUT NAVIGATION]

< ECU DIAGNOSIS >

BOSE AUDIO WITHOUT NAVIGATION WITHOUT DVD ENTERTAINMENT SYSTEM

Connector No.	D192
Connector Name	REAR VIEW CAMERA
Connector Type	TH70MW-NH

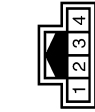

Terminal No.	Color of Wire	Signal Name [Specification]
1	R	CAMERA ON SIGNAL
2	G	GND
3	B	CAMERA IMAGE SIGNAL
4	SHIELD	SHIELD

Connector No.	E6
Connector Name	WIRE TO WIRE
Connector Type	TK18MGY-TV

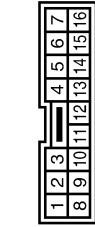

Terminal No.	Color of Wire	Signal Name [Specification]
4	R	-

Connector No.	E16
Connector Name	ECM
Connector Type	RH4ZFB-R2B-L-LH

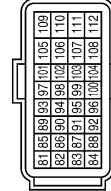

Terminal No.	Color of Wire	Signal Name [Specification]
97	P	VEHCAN-L
98	L	VEHCAN-H

Connector No.	E18
Connector Name	BACK-UP LAMP RELAY
Connector Type	MS02FL-M2-LC

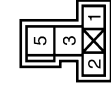

Terminal No.	Color of Wire	Signal Name [Specification]
1	LG	-
2	R	-
3	LG	-
5	R	-

Connector No.	E27
Connector Name	PARKING BRAKE SWITCH
Connector Type	P01FE-A



Terminal No.	Color of Wire	Signal Name [Specification]
1	P	-

Connector No.	E104
Connector Name	WIRE TO WIRE
Connector Type	NS16FW-CS

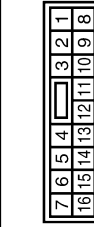

Terminal No.	Color of Wire	Signal Name [Specification]
4	R	-
5	L	-
6	P	-
7	L	-

Connector No.	E105
Connector Name	WIRE TO WIRE
Connector Type	TH70MW-CS10-M3

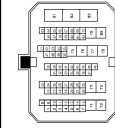

Terminal No.	Color of Wire	Signal Name [Specification]
5	LG	-
22	P	-
47	P	-
48	L	-
75	BR	-
76	GR	-
78	V	-

Connector No.	F23
Connector Name	TOM (TRANSMISSION CONTROL MODULE)
Connector Type	RH40FB-R2B-L-RH

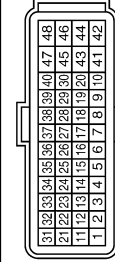

Terminal No.	Color of Wire	Signal Name [Specification]
19	G/B	REV LAMP RELAY

JCNWM1864GI

CAMERA CONTROL UNIT

[BOSE AUDIO WITHOUT NAVIGATION]

< ECU DIAGNOSIS >

BOSE AUDIO WITHOUT NAVIGATION WITHOUT DVD ENTERTAINMENT SYSTEM

Connector No.	F123	Connector No.	M1	Connector No.	M3	Connector No.	M4
Connector Name	WIRE TO WIRE	Connector Name	NSG0FW-M2	Connector Name	FUSE BLOCK (J/B)	Connector Name	DATA LINK CONNECTOR
Connector Type	TK18FY-TV	Connector Type	NSG0FW-M2	Connector Type	NS12FW-CS	Connector Type	BD18FW

Terminal No.	7	8	9	10	11	12	13	14	15	16
Color of Wire	G/B	-	-	-	-	-	-	-	-	-
Signal Name [Specification]	-	-	-	-	-	-	-	-	-	-

Terminal No.	4
Color of Wire	G/B
Signal Name [Specification]	-

Terminal No.	2A	5A
Color of Wire	G	R
Signal Name [Specification]	-	-

Terminal No.	12C
Color of Wire	O
Signal Name [Specification]	-

Terminal No.	6	14
Color of Wire	L	P
Signal Name [Specification]	-	-

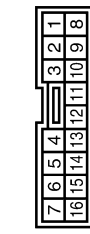
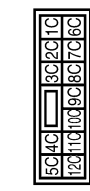
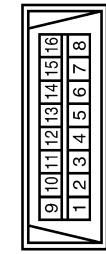

Connector No.	M18	Connector No.	M20
Connector Name	WIRE TO WIRE	Connector Name	WIRE TO WIRE
Connector Type	TH40MW-CS15	Connector Type	TH40MW-CS15

Terminal No.	1	2	3	4	5	6	7	8	9	10	11	12	13	14	15
Color of Wire	W	B	R	-	-	-	-	-	-	-	-	-	-	-	-
Signal Name [Specification]	-	-	-	-	-	-	-	-	-	-	-	-	-	-	-

Terminal No.	4	5
Color of Wire	W	B
Signal Name [Specification]	-	-

Terminal No.	5
Color of Wire	O
Signal Name [Specification]	-

Terminal No.	22	47	48	75	76	78
Color of Wire	G	P	L	BR	R	Y
Signal Name [Specification]	-	-	-	-	-	-

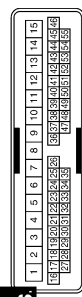
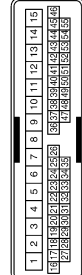

JCNWM1865GI

A
B
C
D
E
F
G
H
I
J
K
L
M
AV
O
P

CAMERA CONTROL UNIT

[BOSE AUDIO WITHOUT NAVIGATION]

< ECU DIAGNOSIS >

BOSE AUDIO WITHOUT NAVIGATION WITHOUT DVD ENTERTAINMENT SYSTEM

Connector No.	M22
Connector Name	WIRE TO WIRE
Connector Type	TH12FW-NH



Terminal No.	Color of Wire	Signal Name [Specification]
1	V	-
2	R	-
3	R	-
4	G	-
5	W	-
6	SHIELD	-
7	LG	-
8	SHIELD	-
9	BR	-
10	SHIELD	-
11	L	-

Connector No.	M33
Connector Name	COMBINATION SWITCH (SPIRAL CABLE)
Connector Type	TK08FGY-IV

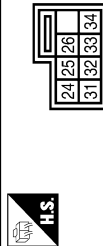

Terminal No.	Color of Wire	Signal Name [Specification]
24	BR	- [With audio steering switch and telephone]
25	G	- [With audio steering switch and telephone]
26	L	- [With audio steering switch and telephone]
27	G	- [With audio steering switch and telephone]
28	BR	- [With audio steering switch and telephone]
29	L	- [With audio steering switch and telephone]
30	SHIELD	- [With audio steering switch and telephone]
31	G	- [With audio steering switch and telephone]
32	BR	- [With audio steering switch and telephone]
33	L	- [With audio steering switch and telephone]

12	R	-
----	---	---

Connector No.	M23
Connector Name	WIRE TO WIRE
Connector Type	TH16MW-NH

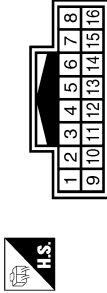

Terminal No.	Color of Wire	Signal Name [Specification]
1	W	-
2	R	- [With telephone without navigation system]
3	B	-
4	SHIELD	-

Connector No.	M44
Connector Name	WIRE TO WIRE
Connector Type	TH32FW-NH

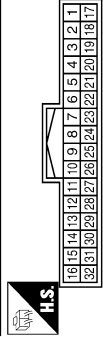

Terminal No.	Color of Wire	Signal Name [Specification]
1	G	-
2	R	-
3	SHIELD	-
4	B	-
5	W	-
6	SHIELD	-
7	O	- [Type A]
8	SB	- [Type B]
9	R	- [Type A]
10	SHIELD	- [Type B]

Connector No.	M30
Connector Name	STEERING ANGLE SENSOR
Connector Type	TH08FW-NH

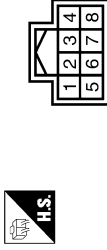

Terminal No.	Color of Wire	Signal Name [Specification]
1	B	-
2	L	-
3	G	-
4	SB	-
5	O	-
6	SHIELD	-
7	LG	-
8	BR	-

Terminal No.	10	V
Terminal No.	11	LG
Terminal No.	12	SHIELD
Terminal No.	13	P

JCNWM1866GI

CAMERA CONTROL UNIT

[BOSE AUDIO WITHOUT NAVIGATION]

< ECU DIAGNOSIS >

BOSE AUDIO WITHOUT NAVIGATION WITHOUT DVD ENTERTAINMENT SYSTEM

Connector No.	M4B
Connector Name	FRONT DISPLAY UNIT
Connector Type	TH24FW-NH

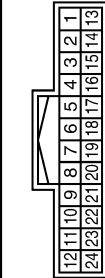

Terminal No.	Color of Wire	Signal Name [Specification]
1	B	GND
2	Y	INVERTER VCGI[Without navigation system]
3	O	SIGNAL VCGI[Without navigation system]
4	P	COMPOSITE IMAGE CHN[Without navigation system]
5	SHIELD	SHIELD[Without navigation system]
6	SHIELD	SHIELD[Without navigation system]
7	SHIELD	SHIELD
8	G	HP[Without navigation system]
9	W	RGB AREA (YS) SIGNAL
11	R	COMM (CONT->DISP)
13	BR	INVERTER GNDI[Without navigation system]

Connector No.	M67
Connector Name	FRONT SQUAWKER RH
Connector Type	TK02FBR



Terminal No.	Color of Wire	Signal Name [Specification]
1	BR	-
2	R	-[With BOSE system]

14	LG	SIGNAL GNDI[Without navigation system]
15	L	COMPOSITE IMAGE SIGNAL[Without navigation system]
17	G	RGB (RED) SIGNAL
18	Y	RGB (BLUE) SIGNAL[Without navigation system]
19	B	RGB SYNC
20	R	VP
21	SHIELD	SHIELD
22	G	COMM (DISP->CONT)
23	SHIELD	SHIELD

Terminal No.	Color of Wire	Signal Name [Specification]
1	LG	-[With BOSE system]
2	Y	-[With BOSE system]

Connector No.	M77
Connector Name	WIRE TO WIRE
Connector Type	TH80FW-CS19

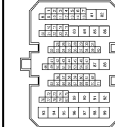

Terminal No.	Color of Wire	Signal Name [Specification]
1	SHIELD	-
2	B	-
3	W	-
4	R	-
8	SHIELD	-
9	W	-
10	R	-
11	G	-
12	B	-
41	O	-
42	SB	-

Connector No.	M65
Connector Name	FRONT SQUAWKER LH
Connector Type	TK02FBR



Terminal No.	Color of Wire	Signal Name [Specification]
1	LG	-[With BOSE system]
2	Y	-[With BOSE system]

Terminal No.	Color of Wire	Signal Name [Specification]
43	L	-
44	V	-
45	P	-
46	R	-
47	Y	-
48	L	-
49	G	-
50	SHIELD	-
51	W	-
56	P	-
57	L	-
58	SB	-
59	SHIELD	-
60	B	-
61	R	-
62	W	-
66	L	-
67	R	-
68	G	-
69	SHIELD	-
70	L	-
71	R	-

Connector No.	M66
Connector Name	CENTER SPEAKER
Connector Type	TK02FBR



Terminal No.	Color of Wire	Signal Name [Specification]
1	P	-
2	O	-

Connector No.	M97
Connector Name	WIRE TO WIRE
Connector Type	TH18FW-CS2

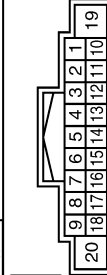

Terminal No.	Color of Wire	Signal Name [Specification]
5	SHIELD	-
6	W	-
8	B	-
9	Y	-
14	R	-
15	B	-
17	SHIELD	-
18	B	-[Type A and With navigation system type B]
18	BR	-[Without navigation system type B]

A
B
C
D
E
F
G
H
I
J
K
L
M
N
O
P

AV

JCNWM1867GI

CAMERA CONTROL UNIT

[BOSE AUDIO WITHOUT NAVIGATION]

< ECU DIAGNOSIS >

BOSE AUDIO WITHOUT NAVIGATION WITHOUT DVD ENTERTAINMENT SYSTEM

Connector No.	M122
Connector Name	BCM BODY CONTROL MODULE
Connector Type	TH40FB-NH

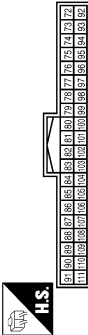

Terminal No.	Color of Wire	Signal Name [Specification]
90	P	CAN-L
91	L	CAN-H

Connector No.	M124
Connector Name	WIRE TO WIRE
Connector Type	NS12FBR-CS



Terminal No.	Color of Wire	Signal Name [Specification]
1	P	-
2	BR	- [Type A]
3	B	- [Type B]
4	Y	-
5	BR	-
6	O	-
7	W	-
8	B	-
9	R	-
10	BR	-

Connector No.	M125
Connector Name	MULTIFUNCTION SWITCH
Connector Type	TH16FW-NH

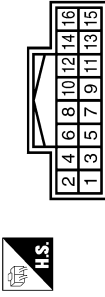

Terminal No.	Color of Wire	Signal Name [Specification]
1	B	GND
3	R	ACC
6	R	AV COMM (H)
8	L	AV COMM (L)
9	V	SW GND
14	W	EJECT SIGNAL

Connector No.	M127
Connector Name	AV CONTROL UNIT (WITH BOSE SYSTEM WITHOUT NAVIGATION SYSTEM)
Connector Type	TH18FW-CS2

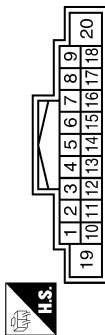

Terminal No.	Color of Wire	Signal Name [Specification]
6	BR	STRG SW A
7	R	ACC
9	R	ILLUMINATION
15	L	STRG SW GND
16	G	STRG SW B
19	Y	BATTERY
20	B	GND

Connector No.	M128
Connector Name	AV CONTROL UNIT (WITH BOSE SYSTEM WITHOUT NAVIGATION SYSTEM)
Connector Type	A12FW

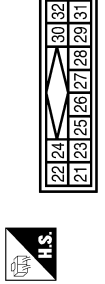

Terminal No.	Color of Wire	Signal Name [Specification]
21	B	SATELLITE RADIO SOUND SIGNAL LH (-)
22	G	SATELLITE RADIO SOUND SIGNAL LH (+)
23	R	SATELLITE RADIO SOUND SIGNAL RH (-)
24	W	SATELLITE RADIO SOUND SIGNAL RH (+)
25	SHIELD	SHIELD
26	SHIELD	SHIELD
28	R	REQUEST (SAT->CONT)
29	W	COMM (SAT->CONT)
30	B	COMM (CONT->SAT)

Connector No.	M129
Connector Name	AV CONTROL UNIT (WITH BOSE SYSTEM WITHOUT NAVIGATION SYSTEM)
Connector Type	TH24FW-NH

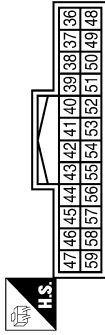

Terminal No.	Color of Wire	Signal Name [Specification]
36	L	COMPOSITE IMAGE SIGNAL
37	P	COMPOSITE IMAGE GND
38	Y	RGB (B/BLUE) SIGNAL
39	L	RGB (G/GREEN) SIGNAL
40	G	RGB (R/RED) SIGNAL
41	B	RGB SYNC
42	SHIELD	SHIELD
43	W	RGB AREA (YS) SIGNAL
44	G	COMM (DISP->CONT)
45	G	HP
46	LG	SIGNAL GND

JCNWM1868G1

CAMERA CONTROL UNIT

[BOSE AUDIO WITHOUT NAVIGATION]

< ECU DIAGNOSIS >

BOSE AUDIO WITHOUT NAVIGATION WITHOUT DVD ENTERTAINMENT SYSTEM

Connector No.	M130
Connector Name	AV CONTROL UNIT (WITH BOSE SYSTEM WITHOUT NAVIGATION SYSTEM)
Connector Type	TH116FW-NH



67	66	65	64	63	62	61	60
75	74	73	72	71	70	69	68

Terminal No.	Color of Wire	Signal Name [Specification]
64	SHIELD	SHIELD
65	W	CAMERA IMAGE SIGNAL
66	Y	AUX IMAGE SIGNAL [Without DVD player]
68	P	CONNECTION RECOGNITION
72	SHIELD	SHIELD [Without DVD player]
74	B	AUX IMAGE GND [Without DVD player (Type A)]
74	BR	AUX IMAGE GND [Without DVD player (Type B)]

Connector No.	M132
Connector Name	AV CONTROL UNIT (WITH BOSE SYSTEM WITHOUT NAVIGATION SYSTEM)
Connector Type	TH12FW-NH



114	115	116	117	118	119
108	109	110	111	112	113

Terminal No.	Color of Wire	Signal Name [Specification]
108	V	SOUND SIGNAL REAR RH (+)
109	B	SOUND SIGNAL FRONT RH (+)
110	P	AMP. ON SIGNAL
111	SHIELD	SHIELD
112	O	SOUND SIGNAL REAR LH (+) [Type A]
112	L	SOUND SIGNAL REAR LH (+) [Type B]
113	G	SOUND SIGNAL FRONT LH (+)
114	LG	SOUND SIGNAL REAR RH (-)
115	W	SOUND SIGNAL FRONT RH (-)
118	SB	SOUND SIGNAL REAR LH (-) [Type A]
118	R	SOUND SIGNAL REAR LH (-) [Type B]

Connector No.	M131
Connector Name	AV CONTROL UNIT (WITH BOSE SYSTEM WITHOUT NAVIGATION SYSTEM)
Connector Type	TH32FW-NH



91	90	89	88	87	86	85	84	83	82	81	80	79	78	77	76
107	106	105	104	103	102	101	100	99	98	97	96	95	94	93	92

Terminal No.	Color of Wire	Signal Name [Specification]
79	L	TEL VOICE SIGNAL (-)
80	R	TEL VOICE SIGNAL (+)
81	SHIELD	SHIELD
82	W	iPod SOUND SIGNAL RH (-) [Without DVD player]
83	R	iPod SOUND SIGNAL RH (+) [Without DVD player]
85	B	GND
85	L	CAN-H
87	P	CAN-L
88	R	AV COMM (H)
88	L	AV COMM (L)
90	G	AV COMM (H)

Terminal No.	119	R	SOUND SIGNAL FRONT LH (-)
--------------	-----	---	---------------------------

91	L	AV COMM (L)
95	R	AUX SOUND SIGNAL RH (+)
96	B	AUX SOUND SIGNAL LH (-)
97	W	AUX SOUND SIGNAL GND
98	L	iPod SOUND SIGNAL LH (-) [Without DVD player]
98	BR	iPod SOUND SIGNAL LH (+) [Without DVD player]
100	SHIELD	SHIELD [Without DVD player]
101	V	SW GND
103	W	EJECT SIGNAL
104	G	IGNITION
105	SB	REVERSE
106	G	PARKING BRAKE
107	V	VEHICLE SPEED (8-PULSE)

Connector No.	M148
Connector Name	iPod ADAPTER
Connector Type	TH24FW-NH



1	2	3	4	5	6	7	8	9	10	11	12
13	14	15	16	17	18	19	20	21	22	23	24

Terminal No.	Color of Wire	Signal Name [Specification]
1	BR	iPod SOUND SIGNAL LH (+)
2	R	iPod SOUND SIGNAL RH (+)
3	R	ACC
4	L	AV COMM (L)
5	Y	BATTERY
8	W	CHARGE POWER
9	G	COMM (iPod ADAPTER->iPod)
10	R	COMM (iPod->iPod ADAPTER)
11	R	ACCESSORY IDENTIFY
12	V	iPod SOUND SIGNAL RH (+)
13	L	iPod SOUND SIGNAL LH (-)

14	W	iPod SOUND SIGNAL RH (-)
15	SHIELD	SHIELD
16	R	AV COMM (H)
17	SHIELD	GND
19	SHIELD	SHIELD
21	L	iPod CONNECTION RECOGNITION
22	BR	ACCESSORY DETECT
23	R	iPod SOUND SIGNAL GND
24	LG	iPod SOUND SIGNAL LH (+)

A
B
C
D
E
F
G
H
I
J
K
L
M
N
O
P

AV

CAMERA CONTROL UNIT

[BOSE AUDIO WITHOUT NAVIGATION]

< ECU DIAGNOSIS >

BOSE AUDIO WITHOUT NAVIGATION WITHOUT DVD ENTERTAINMENT SYSTEM

Connector No.	M204
Connector Name	WIRE TO WIRE
Connector Type	TH12MW-NH

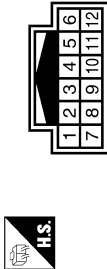

Terminal No.	Color of Wire	Signal Name [Specification]
1	V	-
2	R	-
3	R	-
4	G	-
5	W	-
6	SHIELD	-
7	LG	-
8	SHIELD	-
9	BR	-
10	SHIELD	-
11	L	-

Connector No.	M260
Connector Name	iPod SIDE
Connector Type	IP10F3GY

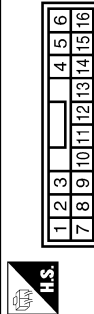

Terminal No.	Color of Wire	Signal Name [Specification]
1	LG	iPod SOUND SIGNAL LH (+)
2	R	iPod SOUND SIGNAL GND
5	R	COMM (iPod->iPod ADAPTER)
6	G	COMM (iPod ADAPTER->iPod)
7	V	iPod SOUND SIGNAL RH (+)
9	L	iPod CONNECTION RECOGNITION GND
10	SHIELD	CHARGE POWER
12	W	SHIELD
14	SHIELD	ACCESSORY DETECT
15	BR	ACCESSORY IDENTIFY
16	R	ACCESSORY IDENTIFY

12	R	-
----	---	---

Connector No.	M251
Connector Name	WIRE TO WIRE
Connector Type	TH18MW-CSZ

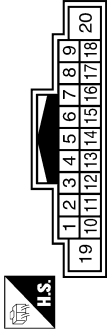

Terminal No.	Color of Wire	Signal Name [Specification]
5	SHIELD	-
6	W	-
8	SHIELD	-
9	G	-
14	R	-
15	B	-
17	SHIELD	-
18	R	-

Connector No.	M370
Connector Name	AV CONTROL UNIT (WITH BOSE SYSTEM WITHOUT NAVIGATION SYSTEM)
Connector Type	GT13SH-2/1S-HU



Terminal No.	Color of Wire	Signal Name [Specification]
33	-	FM SUB
34	-	AM-FM MAIN
35	-	ANTENNA AMP. ON SIGNAL

Connector No.	M303
Connector Name	COMBINATION SWITCH (SPIRAL CABLE)
Connector Type	TK08FGY



Terminal No.	Color of Wire	Signal Name [Specification]
14	-	-
15	-	-
17	-	-

Connector No.	M253
Connector Name	AUXILIARY INPUT JACKS
Connector Type	A08FW

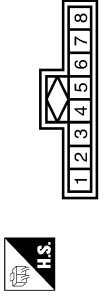

Terminal No.	Color of Wire	Signal Name [Specification]
1	R	SOUND SIGNAL RH (+)
2	W	SOUND SIGNAL GND
3	B	SOUND SIGNAL LH (-) [Without DVD player]
7	G	AUX IMAGE SIGNAL
8	R	AUX IMAGE GND [Without DVD player]

Connector No.	M275
Connector Name	WIRE TO WIRE
Connector Type	GT13SH-2/1S-HU



Terminal No.	Color of Wire	Signal Name [Specification]
1	-	-
2	-	-
3	-	-

JCNWM1870GI

CAMERA CONTROL UNIT

[BOSE AUDIO WITHOUT NAVIGATION]

< ECU DIAGNOSIS >

BOSE AUDIO WITHOUT NAVIGATION WITHOUT DVD ENTERTAINMENT SYSTEM

Connector No.	M376	Connector No.	M378	Connector No.	M379	Connector No.	RT
Connector Name	WIRE TO WIRE	Connector Name	ANTENNA BASE (ANTENNA AMP.)	Connector Name	GLASS ANTENNA	Connector Name	WIRE TO WIRE
Connector Type	GT13SCH-2/1PP-HU	Connector Type	GT13SCH-1/1PP-HU	Connector Type	GT13SCH-1/1PP-HU	Connector Type	TH18FW-NH

Terminal No.	1	2	3	Terminal No.	1	2	3	4
Color of Wire	-	-	-	Color of Wire	-	-	R/W	R/L
Signal Name [Specification]	-	-	-	Signal Name [Specification]	-	-	B	- [With telephone without navigation system]
							SHIELD	-

Terminal No.	1	2	3	Terminal No.	1	2	3	4
Color of Wire	-	-	-	Color of Wire	-	-	-	-
Signal Name [Specification]	-	-	-	Signal Name [Specification]	-	-	FM SUB	-

Terminal No.	1	2	3	Terminal No.	1	2	3	4
Color of Wire	-	-	-	Color of Wire	-	-	-	-
Signal Name [Specification]	-	-	-	Signal Name [Specification]	-	-	-	-

Connector No.	R20
Connector Name	MICROPHONE
Connector Type	TK04FW

Terminal No.	1	2	4	Terminal No.	1	2	3
Color of Wire	-	-	-	Color of Wire	-	-	-
Signal Name [Specification]	-	-	-	Signal Name [Specification]	-	-	-

Terminal No.	1	2	4	Terminal No.	1	2	3
Color of Wire	-	-	-	Color of Wire	-	-	-
Signal Name [Specification]	-	-	-	Signal Name [Specification]	-	-	-

Wiring Diagram - BOSE AUDIO WITHOUT NAVIGATION WITH DVD ENTERTAINMENT SYSTEM -

NOTE:

JCNWM1871GI
 INFOID:000000003702922

A
B
C
D
E
F
G
H
I
J
K
L
M
AV
O
P

CAMERA CONTROL UNIT

[BOSE AUDIO WITHOUT NAVIGATION]

< ECU DIAGNOSIS >

In this section, PRESET SWITCH and MULTIFUNCTION SWITCH are written as the MULTIFUNCTION SWITCH.

BOSE AUDIO WITHOUT NAVIGATION WITH DVD ENTERTAINMENT SYSTEM

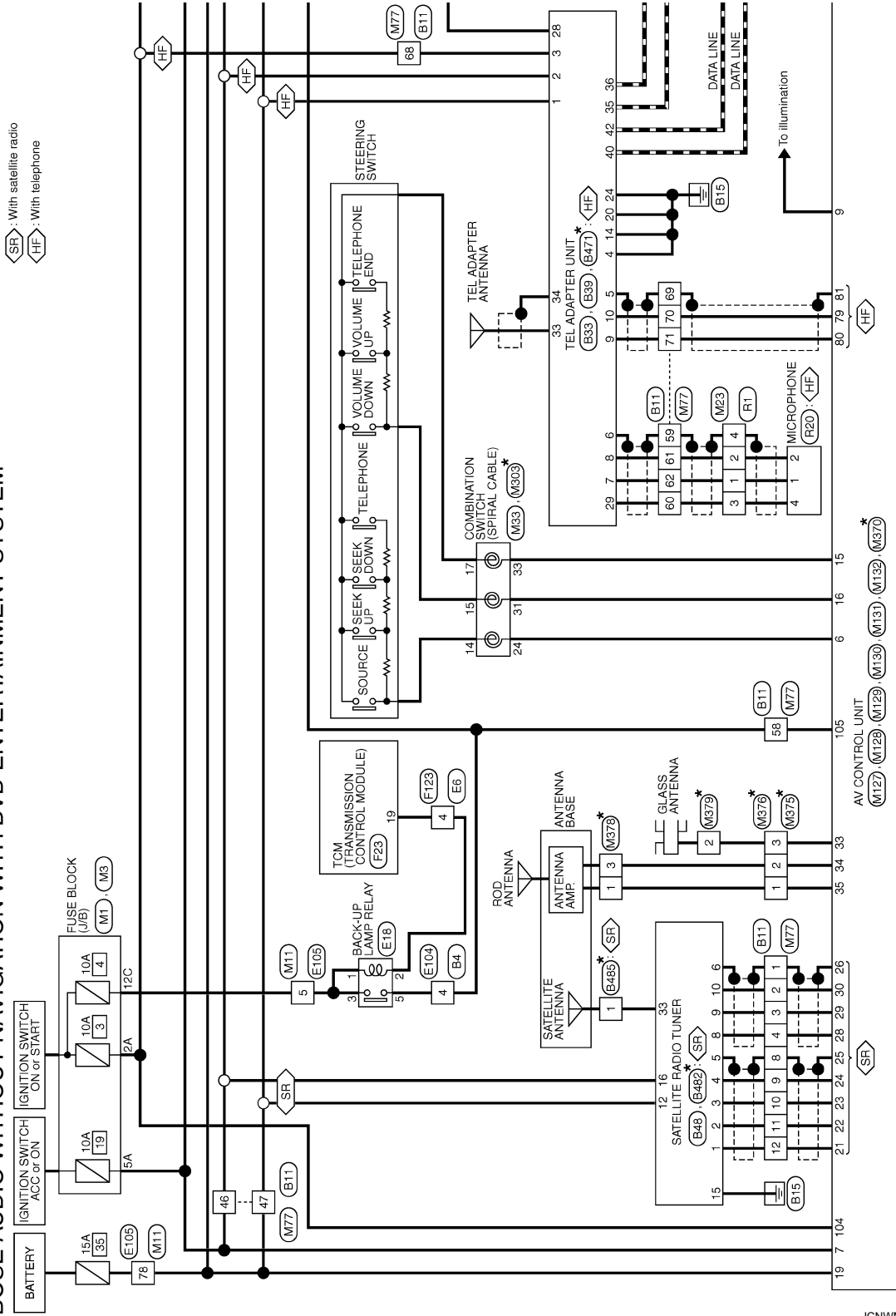

*: This connector is not shown in "Harness Layout".

2008/09/23

JCNWM1872GI

CAMERA CONTROL UNIT

[BOSE AUDIO WITHOUT NAVIGATION]

< ECU DIAGNOSIS >

WI: With iPod

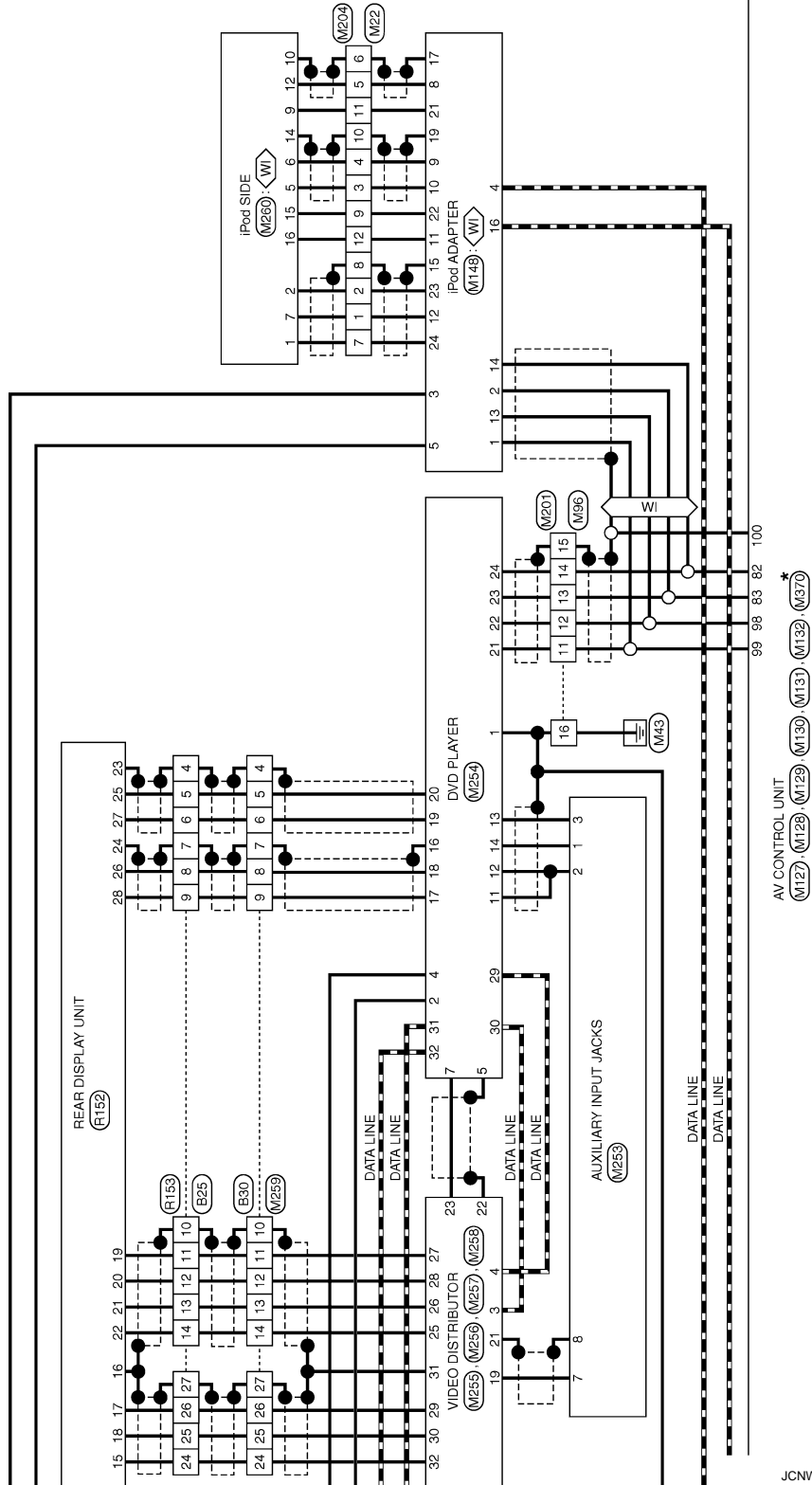

*: This connector is not shown in "Harness Layout".

JCNWM1874GI

CAMERA CONTROL UNIT

[BOSE AUDIO WITHOUT NAVIGATION]

< ECU DIAGNOSIS >

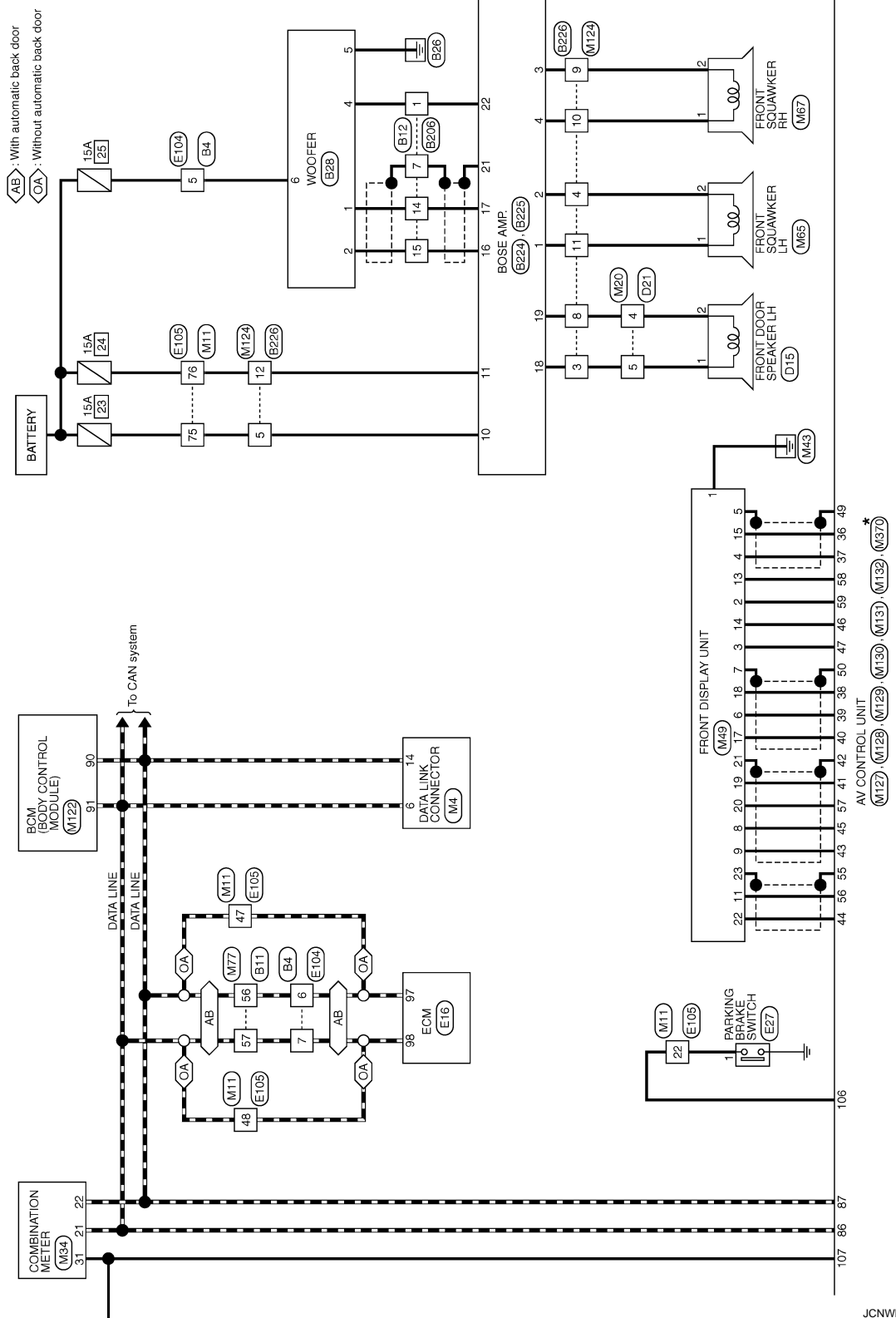

*: This connector is not shown in "Harness Layout".

A
B
C
D
E
F
G
H
I
J
K
L
M
AV
O
P

CAMERA CONTROL UNIT

[BOSE AUDIO WITHOUT NAVIGATION]

< ECU DIAGNOSIS >

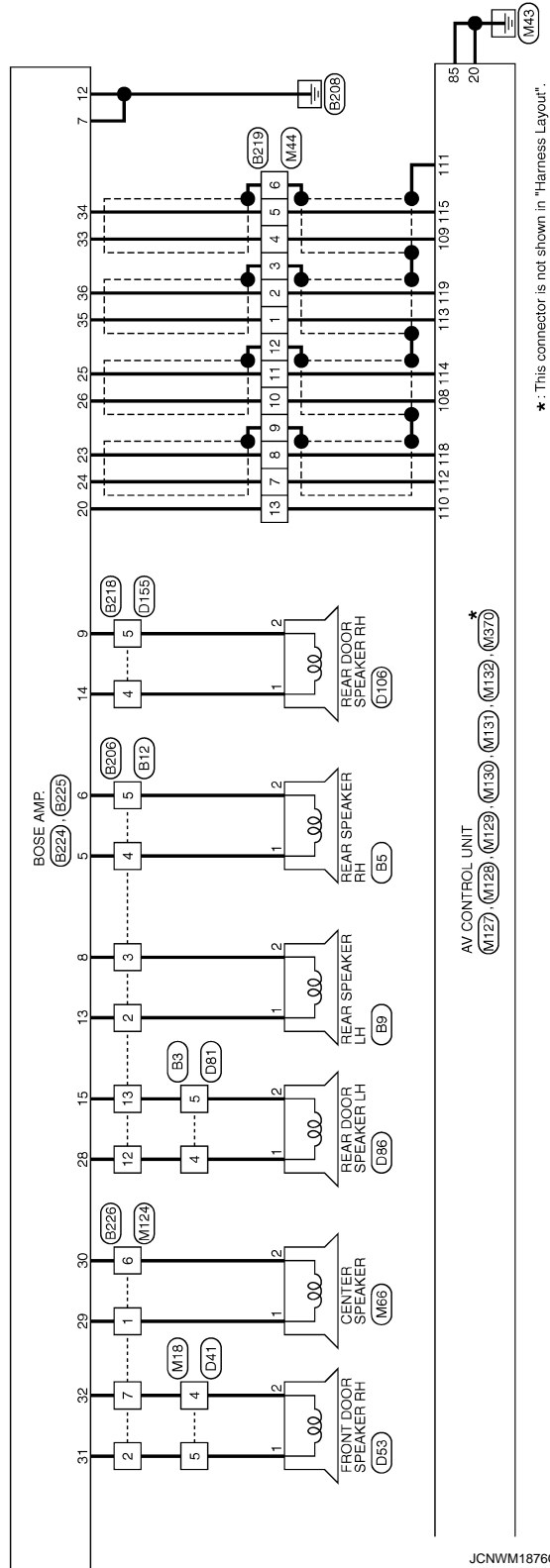

*: This connector is not shown in "Harness Layout".

JCNWM1876G1

CAMERA CONTROL UNIT

[BOSE AUDIO WITHOUT NAVIGATION]

< ECU DIAGNOSIS >

BOSE AUDIO WITHOUT NAVIGATION WITH DVD ENTERTAINMENT SYSTEM

Connector No.	B3
Connector Name	WIRE TO WIRE
Connector Type	TK0DFW-ANS8



Terminal No.	Color of Wire	Signal Name [Specification]
4	LG	-
5	O	-

Connector No.	B4
Connector Name	WIRE TO WIRE
Connector Type	NS16MW-CS



Terminal No.	Color of Wire	Signal Name [Specification]
4	R	-
5	O	-
6	P	-
7	L	-

Connector No.	B5
Connector Name	REAR SPEAKER RH
Connector Type	TK02FBR



Terminal No.	Color of Wire	Signal Name [Specification]
1	V	-
2	LG	-

Connector No.	B9
Connector Name	REAR SPEAKER LH
Connector Type	TK02FBR



Terminal No.	Color of Wire	Signal Name [Specification]
1	SB	-
2	GR	-

Connector No.	B11
Connector Name	WIRE TO WIRE
Connector Type	TH80MW-CS19

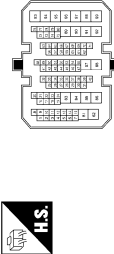

Terminal No.	Color of Wire	Signal Name [Specification]
1	SHIELD	-
2	B	-
3	R/L	-
4	R/W	-
8	SHIELD	-
9	BR/L	-
10	Y/G	-
11	Y/L	-
12	W/L	-
41	O	-
42	SB	-

43	G	-
44	BR	-
45	L	-
46	GR	-
47	V	-
48	GR	-(With rear view camera and telephone)
48	BR	-(With rear view camera without telephone)
49	Y	-
50	SHIELD	-
51	B	-
56	P	-
57	L	-
58	R	-
59	SHIELD	-
60	B	-
61	R/L	-
62	R/W	-
68	R	-
69	SHIELD	-
70	W/R	-
71	B/R	-

Connector No.	B12
Connector Name	WIRE TO WIRE
Connector Type	NS18FW-CS

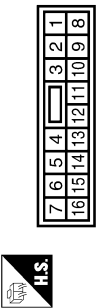

Terminal No.	Color of Wire	Signal Name [Specification]
1	W	-
2	SB	-
3	GR	-
4	V	-
5	LG	-
7	SHIELD	-
12	LG	-
13	O	-
14	W/R	-
15	B/R	-

A
B
C
D
E
F
G
H
I
J
K
L
M
O
P

AV

JCNWM1877G1

CAMERA CONTROL UNIT

[BOSE AUDIO WITHOUT NAVIGATION]

< ECU DIAGNOSIS >

BOSE AUDIO WITHOUT NAVIGATION WITH DVD ENTERTAINMENT SYSTEM

Connector No.	B25
Connector Name	WIRE TO WIRE
Connector Type	TH22MW-NH



Terminal No.	Color of Wire	Signal Name [Specification]
1	SB	-
2	B	-
4	SHIELD	-
5	W/R	-
6	W/L	-
7	SHIELD	-
8	GR/V	-
9	W/L	-
10	SHIELD	-
11	W/L	-
12	Y/G	-

Connector No.	B30
Connector Name	WIRE TO WIRE
Connector Type	TH32FW-NH



Terminal No.	Color of Wire	Signal Name [Specification]
1	SB	-
3	G	-
4	SHIELD	-
5	W/R	-
6	W/L	-
7	SHIELD	-
8	GR/V	-
9	W/L	-
10	SHIELD	-
11	W/L	-
12	Y/G	-

Terminal No.	Color of Wire	Signal Name [Specification]
13	Y/L	-
14	BR/L	-
16	V	-
18	O	-
21	B/R	-
22	W/R	-
23	SHIELD	-
24	B	-
25	R/L	-
26	R/W	-
27	SHIELD	-
28	B	-
29	W	-
30	SHIELD	-
31	P	-

Connector No.	B28
Connector Name	WOOFER
Connector Type	RS08FGY-PR



Terminal No.	Color of Wire	Signal Name [Specification]
1	W/R	SOUND SIGNAL WOOFER (-)
2	B/R	SOUND SIGNAL WOOFER (+)
4	W	WOOFER AMP. ON SIGNAL
5	B/W	GND
6	O	BAT

Connector No.	B33
Connector Name	TEL ADAPTER UNIT
Connector Type	TH08FW-NH



Terminal No.	Color of Wire	Signal Name [Specification]
35	Y	AV COMM (H)
36	BR	AV COMM (L)
40	G	AV COMM (H)
42	GR	AV COMM (L)

CAMERA CONTROL UNIT

[BOSE AUDIO WITHOUT NAVIGATION]

< ECU DIAGNOSIS >

BOSE AUDIO WITHOUT NAVIGATION WITH DVD ENTERTAINMENT SYSTEM

Connector No.	B48
Connector Name	SATELLITE RADIO TUNER
Connector Type	A18FW

Terminal No.	Color of Wire	Signal Name [Specification]
1	W/L	SOUND SIGNAL LH (-)
2	Y/L	SOUND SIGNAL LH (+)
3	Y/G	SOUND SIGNAL RH (-)
4	BR/L	SOUND SIGNAL RH (+)
5	SHIELD	SHIELD
8	SHIELD	SHIELD
8	R/W	REQUEST (SAT->CONT)
9	R/L	COMM (SAT->CONT)
10	B	COMM (CONT->SAT)
12	V	BATTERY
15	B	GND

20	B	CONTROL SIGNAL
24	B/W	CONTROL SIGNAL
26	BR	VEHICLE SPEED (8-PULSE)
29	B	MICROPHONE VCC

Connector No.	B38
Connector Name	TEL ADAPTER UNIT
Connector Type	TH22FW-NH

16	GR	ACC
----	----	-----

22	R	REVERSE
23	G	SENSOR SIGNAL 1
24	SB	SENSOR SIGNAL 2
25	O	SENSOR SIGNAL 3
26	BR	VEHICLE SPEED (8-PULSE)
30	GR	ACC
31	B	GND
32	V	BATTERY

Terminal No.	Color of Wire	Signal Name [Specification]
1	V	BATTERY
2	GR	ACC
3	R	IGNITION
4	B/W	GND
5	SHIELD	SHIELD
8	SHIELD	SHIELD
7	R/W	MICROPHONE SIGNAL
8	R/L	MICROPHONE GND
9	B/R	TEL VOICE SIGNAL (+)
10	W/R	TEL VOICE SIGNAL (-)
14	B	GND

Connector No.	B80
Connector Name	CAMERA CONTROL UNIT
Connector Type	TH22FW-NH

2	4	6	8	10	12	14	16
1	3	5	7	9	11	13	15

2	4	6	8	10	12	14	16
1	3	5	7	9	11	13	15

2	4	6	8	10	12	14	16	18	20	22	24	26	28	30	32
1	3	5	7	9	11	13	15	17	19	21	23	25	27	29	31

2	4	6	8	10	12	14	16	18	20	22	24	26	28	30	32
1	3	5	7	9	11	13	15	17	19	21	23	25	27	29	31

Terminal No.	Color of Wire	Signal Name [Specification]
5	SHIELD	SHIELD
12	G	SHIELD
13	R	SHIELD
14	W/R	SHIELD
15	B/R	SHIELD

Terminal No.	Color of Wire	Signal Name [Specification]
6	R/L	SHIELD
7	R/W	SHIELD
8	B	SHIELD
9	SHIELD	SHIELD

Terminal No.	Color of Wire	Signal Name [Specification]
5	SHIELD	SHIELD
6	B	SHIELD
7	R/W	SHIELD
8	R/L	SHIELD
11	SHIELD	SHIELD
12	B	SHIELD
14	L	SHIELD
17	BR	SHIELD
18	Y	SHIELD
19	GR	SHIELD
20	G	SHIELD

Terminal No.	Color of Wire	Signal Name [Specification]
5	SHIELD	SHIELD
6	B	SHIELD
7	R/W	SHIELD
8	R/L	SHIELD
11	SHIELD	SHIELD
12	B	SHIELD
14	L	SHIELD
17	BR	SHIELD
18	Y	SHIELD
19	GR	SHIELD
20	G	SHIELD

Connector No.	B206
Connector Name	WIRE TO WIRE
Connector Type	NS16MW-CS

Connector No.	B77
Connector Name	WIRE TO WIRE
Connector Type	TK12MW

Terminal No.	Color of Wire	Signal Name [Specification]
1	W	SHIELD
2	GR	SHIELD
3	BR	SHIELD
4	Y	SHIELD
5	BR	SHIELD
7	G	SHIELD
12	G	SHIELD
13	R	SHIELD
14	W/R	SHIELD
15	B/R	SHIELD

Terminal No.	Color of Wire	Signal Name [Specification]
5	SHIELD	SHIELD
6	B	SHIELD
7	R/W	SHIELD
8	R/L	SHIELD
11	SHIELD	SHIELD
12	B	SHIELD
14	L	SHIELD
17	BR	SHIELD
18	Y	SHIELD
19	GR	SHIELD
20	G	SHIELD

1	2	3	4	5	6	7
8	9	10	11	12	13	14
15	16	17	18	19	20	21

1	2	3	4	5
6	7	8	9	10
11	12	13	14	15

2	4	6	8	10	12	14	16	18	20	22	24	26	28	30	32
1	3	5	7	9	11	13	15	17	19	21	23	25	27	29	31

2	4	6	8	10	12	14	16	18	20	22	24	26	28	30	32
1	3	5	7	9	11	13	15	17	19	21	23	25	27	29	31

Terminal No.	Color of Wire	Signal Name [Specification]
1	W	SHIELD
2	GR	SHIELD
3	BR	SHIELD
4	Y	SHIELD
5	BR	SHIELD
7	G	SHIELD
12	G	SHIELD
13	R	SHIELD
14	W/R	SHIELD
15	B/R	SHIELD

Terminal No.	Color of Wire	Signal Name [Specification]
6	R/L	SHIELD
7	R/W	SHIELD
8	B	SHIELD
9	SHIELD	SHIELD

Terminal No.	Color of Wire	Signal Name [Specification]
5	SHIELD	SHIELD
6	B	SHIELD
7	R/W	SHIELD
8	R/L	SHIELD
11	SHIELD	SHIELD
12	B	SHIELD
14	L	SHIELD
17	BR	SHIELD
18	Y	SHIELD
19	GR	SHIELD
20	G	SHIELD

Terminal No.	Color of Wire	Signal Name [Specification]
5	SHIELD	SHIELD
6	B	SHIELD
7	R/W	SHIELD
8	R/L	SHIELD
11	SHIELD	SHIELD
12	B	SHIELD
14	L	SHIELD
17	BR	SHIELD
18	Y	SHIELD
19	GR	SHIELD
20	G	SHIELD

JCNWM1879GI

A
B
C
D
E
F
G
H
I
J
K
L
M
N
O
P

AV

CAMERA CONTROL UNIT

[BOSE AUDIO WITHOUT NAVIGATION]

< ECU DIAGNOSIS >

BOSE AUDIO WITHOUT NAVIGATION WITH DVD ENTERTAINMENT SYSTEM

Connector No.	B218
Connector Name	WIRE TO WIRE
Connector Type	TK10FW-NSB



Terminal No.	Color of Wire	Signal Name [Specification]
4	L	-[With BOSE system]
5	O	-[With BOSE system]

Connector No.	B219
Connector Name	WIRE TO WIRE
Connector Type	TK132MF-NH



Terminal No.	Color of Wire	Signal Name [Specification]
1	W/R	-
2	B/R	-
3	SHIELD	-
4	W/R	-
5	B/R	-
6	SHIELD	-
7	GR/V	-
8	W/L	-
9	SHIELD	-
10	GR/V	-
11	W/L	-

Connector No.	B224
Connector Name	BOSE AMP.
Connector Type	SGA12FBR-SJAZ

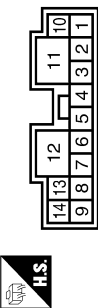

Terminal No.	Color of Wire	Signal Name [Specification]
1	LG	SOUND SIGNAL FRONT SQUAWKER LH (+)
2	V	SOUND SIGNAL FRONT SQUAWKER LH (-)
3	L	SOUND SIGNAL FRONT SQUAWKER RH (-)
4	P	SOUND SIGNAL FRONT SQUAWKER RH (+)
5	Y	SOUND SIGNAL REAR SPEAKER RH (+)
6	BR	SOUND SIGNAL REAR SPEAKER RH (-)
7	B	GND
8	BR	SOUND SIGNAL REAR SPEAKER LH (-)
9	O	SOUND SIGNAL REAR DOOR SPEAKER RH (-)
10	SB	BATTERY
11	GR	BATTERY

Connector No.	B225
Connector Name	BOSE AMP.
Connector Type	SCA19FBR-SGA4

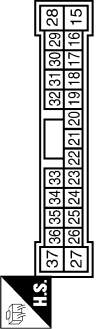

Terminal No.	Color of Wire	Signal Name [Specification]
15	R	SOUND SIGNAL REAR DOOR SPEAKER LH (-)
16	B/R	SOUND SIGNAL WOOFER (+)
17	W/R	SOUND SIGNAL WOOFER (-)
18	W	SOUND SIGNAL FRONT DOOR SPEAKER LH (+)
19	B	SOUND SIGNAL FRONT DOOR SPEAKER LH (-)
20	SB	AMP. ON SIGNAL
21	SHIELD	SHIELD
22	W	WOOFER AMP. ON SIGNAL
23	W/L	SOUND SIGNAL REAR LH (-)
24	GR/V	SOUND SIGNAL REAR LH (+)
25	W/L	SOUND SIGNAL REAR RH (-)

12	SHIELD
13	SB

26	GR/V	SOUND SIGNAL REAR RH (+)
28	G	SOUND SIGNAL REAR DOOR SPEAKER LH (+)
29	V	SOUND SIGNAL CENTER SPEAKER (+)
30	P	SOUND SIGNAL CENTER SPEAKER (-)
31	BR	SOUND SIGNAL FRONT DOOR SPEAKER RH (+)
32	Y	SOUND SIGNAL FRONT DOOR SPEAKER RH (-)
33	W/R	SOUND SIGNAL FRONT RH (+)
34	B/R	SOUND SIGNAL FRONT RH (-)
35	W/R	SOUND SIGNAL FRONT LH (+)
36	B/R	SOUND SIGNAL FRONT LH (-)

CAMERA CONTROL UNIT

[BOSE AUDIO WITHOUT NAVIGATION]

< ECU DIAGNOSIS >

BOSE AUDIO WITHOUT NAVIGATION WITH DVD ENTERTAINMENT SYSTEM

Connector No.	B226
Connector Name	WIRE TO WIRE
Connector Type	NS2/MBR-CS

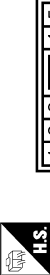

1	2	3	4	5
6	7	8	9	10
11	12			

Terminal No.	Color of Wire	Signal Name [Specification]
1	V	
2	BR	
3	W	
4	V	
5	SB	
6	P	
7	Y	
8	B	
9	L	
10	P	
11	LG	

Connector No.	B465
Connector Name	ANTENNA BASE (SATELLITE ANTENNA) WITH BOSE SYSTEM WITHOUT NAVIGATION SYSTEM
Connector Type	GT1BC-1PP-HU



1	2
---	---

Terminal No.	Color of Wire	Signal Name [Specification]
1	-	SATELLITE ANTENNA

Connector No.	B471
Connector Name	TEL ADAPTER UNIT
Connector Type	GT1BC-1S-HU



33	34
----	----

Terminal No.	Color of Wire	Signal Name [Specification]
33	-	TEL ANTENNA
34	SHIELD	SHIELD

Connector No.	D21
Connector Name	WIRE TO WIRE
Connector Type	TH4DFW-CS15



1	2	3	4	5	6	7	8	9	10	11	12	13	14	15
---	---	---	---	---	---	---	---	---	----	----	----	----	----	----

Terminal No.	Color of Wire	Signal Name [Specification]
4	B/W	-[Type A]
4	B	-[Type B]
5	L	-[Type A]
5	W	-[Type B]

Connector No.	B482
Connector Name	SATELLITE RADIO TUNER
Connector Type	FAKBA



33	34
----	----

Terminal No.	Color of Wire	Signal Name [Specification]
33	-	SATELLITE ANTENNA

Connector No.	D41
Connector Name	WIRE TO WIRE
Connector Type	TH4DFW-CS15



1	2	3	4	5	6	7	8	9	10	11	12	13	14	15
---	---	---	---	---	---	---	---	---	----	----	----	----	----	----

Terminal No.	Color of Wire	Signal Name [Specification]
4	B/R	-[Type A]
4	B	-[Type B]
5	BR	-[Type A]
5	W	-[Type B]

A
B
C
D
E
F
G
H
I
J
K
L
M
O
P

AV

JCNWM1881GI

CAMERA CONTROL UNIT

[BOSE AUDIO WITHOUT NAVIGATION]

< ECU DIAGNOSIS >

BOSE AUDIO WITHOUT NAVIGATION WITH DVD ENTERTAINMENT SYSTEM

Connector No.	D106
Connector Name	REAR DOOR SPEAKER RH (WITH BOSE SYSTEM)
Connector Type	NS02FBR-CS



Terminal No.	Color of Wire	Signal Name [Specification]
1	O	-[Type A]
1	L	-[Type B]
2	B/P	-[Type A]
2	W	-[Type B]

Connector No.	D36
Connector Name	REAR DOOR SPEAKER LH (WITH BOSE SYSTEM)
Connector Type	NS02FBR-CS



Terminal No.	Color of Wire	Signal Name [Specification]
1	L	-
2	W	-

Connector No.	D81
Connector Name	WIRE TO WIRE
Connector Type	TK10MW-NS

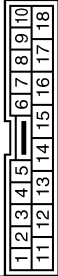

Terminal No.	Color of Wire	Signal Name [Specification]
4	L	-
5	W	-

Connector No.	D53
Connector Name	FRONT DOOR SPEAKER RH (WITH BOSE SYSTEM)
Connector Type	NS02FBR-CS



Terminal No.	Color of Wire	Signal Name [Specification]
1	BR	-[Type A]
1	W	-[Type B]
2	B/R	-[Type A]
2	B	-[Type B]

Connector No.	E6
Connector Name	WIRE TO WIRE
Connector Type	TK16MGY-TV



Terminal No.	Color of Wire	Signal Name [Specification]
4	R	-

Connector No.	D192
Connector Name	REAR VIEW CAMERA
Connector Type	TK4MMW-NH



Terminal No.	Color of Wire	Signal Name [Specification]
1	R	CAMERA ON SIGNAL
2	G	GND
3	B	CAMERA IMAGE SIGNAL
4	SHIELD	SHIELD

Connector No.	D182
Connector Name	WIRE TO WIRE
Connector Type	TK12FW

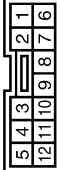

Terminal No.	Color of Wire	Signal Name [Specification]
6	R	-
7	G	-
8	B	-
9	SHIELD	-

Connector No.	D155
Connector Name	WIRE TO WIRE
Connector Type	TK10MW-NS



Terminal No.	Color of Wire	Signal Name [Specification]
4	O	-[Type A]
4	L	-[Type B]
5	B/P	-[Type A]
5	W	-[Type B]

JCNWM1882GI

CAMERA CONTROL UNIT

[BOSE AUDIO WITHOUT NAVIGATION]

< ECU DIAGNOSIS >

BOSE AUDIO WITHOUT NAVIGATION WITH DVD ENTERTAINMENT SYSTEM

Connector No.	E18
Connector Name	ECM
Connector Type	RH24FB-RZ8-L-LH

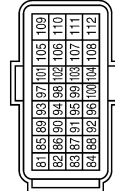

Terminal No.	Color of Wire	Signal Name [Specification]
97	P	VEHGAN-L
98	L	VEHGAN-H

Connector No.	E18
Connector Name	BACK-UP LAMP RELAY
Connector Type	MS02FL-M2-LC

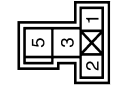

Terminal No.	Color of Wire	Signal Name [Specification]
1	LG	-
2	R	-
3	LG	-
5	R	-

Connector No.	E27
Connector Name	PARKING BRAKE SWITCH
Connector Type	F01FB-A



Terminal No.	Color of Wire	Signal Name [Specification]
1	P	-

Connector No.	E104
Connector Name	WIRE TO WIRE
Connector Type	NS38FW-CS

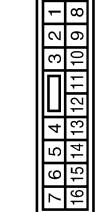

Terminal No.	Color of Wire	Signal Name [Specification]
4	R	-
5	L	-
6	P	-
7	L	-

Connector No.	E105
Connector Name	WIRE TO WIRE
Connector Type	TH170MW-CS10-M3

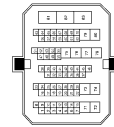

Terminal No.	Color of Wire	Signal Name [Specification]
5	LG	-
22	P	-
47	P	-
48	L	-
75	BR	-
76	GR	-
78	V	-

Connector No.	F23
Connector Name	TOM (TRANSMISSION CONTROL MODULE)
Connector Type	RH40FB-RZ8-L-RH

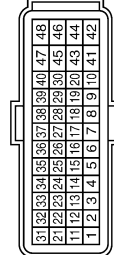

Terminal No.	Color of Wire	Signal Name [Specification]
19	G/B	REV LAMP RELAY

Connector No.	F123
Connector Name	WIRE TO WIRE
Connector Type	TK18FGY-1V

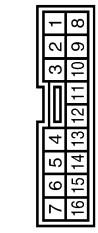

Terminal No.	Color of Wire	Signal Name [Specification]
4	G/B	-

Connector No.	M1
Connector Name	FUSE BLOK (J/B)
Connector Type	NS08FW-M2

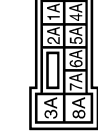

Terminal No.	Color of Wire	Signal Name [Specification]
2A	G	-
5A	R	-

A
B
C
D
E
F
G
H
I
J
K
L
M
AV
O
P

CAMERA CONTROL UNIT

[BOSE AUDIO WITHOUT NAVIGATION]

< ECU DIAGNOSIS >

BOSE AUDIO WITHOUT NAVIGATION WITH DVD ENTERTAINMENT SYSTEM

Connector No.	M3
Connector Name	FUSE BLOCK (J/B)
Connector Type	HS12FW-CS

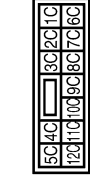

Terminal No.	Color of Wire	Signal Name [Specification]
12C	O	-

Connector No.	M4
Connector Name	DATA LINK CONNECTOR
Connector Type	BD16FW



Terminal No.	Color of Wire	Signal Name [Specification]
6	L	-
14	P	-

Connector No.	M11
Connector Name	WIRE TO WIRE
Connector Type	TH10FW-CS10-M3

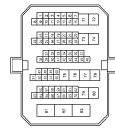

Terminal No.	Color of Wire	Signal Name [Specification]
5	O	-
22	G	-
47	P	-
48	L	-
75	BR	-
76	R	-
78	Y	-

Connector No.	M18
Connector Name	WIRE TO WIRE
Connector Type	TH40MW-CS15

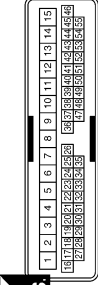

Terminal No.	Color of Wire	Signal Name [Specification]
4	W	-
5	BR	- [Type A and without BOSE system type B]
	B	- [With BOSE system type B]

Connector No.	M20
Connector Name	WIRE TO WIRE
Connector Type	TH40MW-CS15

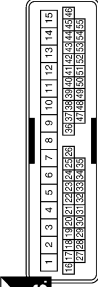

Terminal No.	Color of Wire	Signal Name [Specification]
4	B	-
5	L	-

Connector No.	M22
Connector Name	WIRE TO WIRE
Connector Type	TH12FW-NH

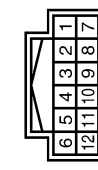

Terminal No.	Color of Wire	Signal Name [Specification]
1	V	-
2	R	-
3	R	-
4	G	-
5	W	-
6	SHIELD	-
7	LG	-
8	SHIELD	-
9	BR	-
10	SHIELD	-
11	L	-

Connector No.	M23
Connector Name	WIRE TO WIRE
Connector Type	TH16MW-NH



Terminal No.	Color of Wire	Signal Name [Specification]
1	W	-
2	R	- [With telephones without navigation system]
3	B	-
4	SHIELD	-

CAMERA CONTROL UNIT

[BOSE AUDIO WITHOUT NAVIGATION]

< ECU DIAGNOSIS >

BOSE AUDIO WITHOUT NAVIGATION WITH DVD ENTERTAINMENT SYSTEM

Connector No.	M33
Connector Name	STEERING ANGLE SENSOR
Connector Type	TH08FW-NH

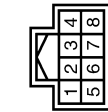

Terminal No.	Color of Wire	Signal Name [Specification]
1	B	-
3	L	-
4	G	-
6	SB	-
8	O	-

Connector No.	M33
Connector Name	COMBINATION SWITCH (SPIRAL CABLE)
Connector Type	TH08FGY-1V

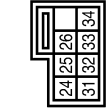

Terminal No.	Color of Wire	Signal Name [Specification]
24	BR	- [With audio steering switch and telephone]
31	G	- [With audio steering switch and telephone]
33	L	- [With audio steering switch and telephone]

Connector No.	M34
Connector Name	COMBINATION METER
Connector Type	TH46FW-NH

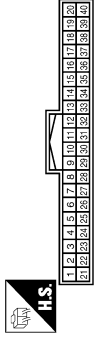

Terminal No.	Color of Wire	Signal Name [Specification]
21	L	CAN-H
22	P	CAN-L
31	V	VEHICLE SPEED (8-PULSE)

Connector No.	M44
Connector Name	WIRE TO WIRE
Connector Type	TH22FW-NH

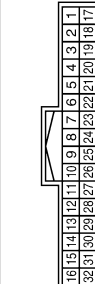

Terminal No.	10	V	-
11	LG	-	-
12	SHIELD	-	-
13	P	-	-

Connector No.	M49
Connector Name	FRONT DISPLAY UNIT
Connector Type	TH24FW-NH



14	LG	SIGNAL GND [Without navigation system]
15	L	COMPOSITE IMAGE SIGNAL [Without navigation system]
17	G	RGB (RED) SIGNAL
18	Y	RGB (BLUE) SIGNAL [Without navigation system]
19	B	RGB SYNC
20	R	VP
21	SHIELD	SHIELD
22	G	COMM (DISEP->CONT)
23	SHIELD	SHIELD

Terminal No.	Color of Wire	Signal Name [Specification]
1	G	-
2	R	-
3	SHIELD	-
4	B	-
5	W	-
6	SHIELD	-
7	O	- [Type A]
7	L	- [Type B]
8	SB	- [Type A]
8	R	- [Type B]
9	SHIELD	-

Terminal No.	Color of Wire	Signal Name [Specification]
1	B	GND
2	Y	INVERTER VCCI [Without navigation system]
3	O	SIGNAL VCCI [Without navigation system]
4	P	COMPOSITE IMAGE GND [Without navigation system]
5	SHIELD	SHIELD [Without navigation system]
6	L	RGB (GREEN) SIGNAL [Without navigation system]
7	SHIELD	SHIELD
8	G	HP [Without navigation system]
9	W	RGB AREA (YS) SIGNAL
11	R	COMM (CONT->DISEP)
13	BR	INVERTER GND [Without navigation system]

JCNWM1885GI

A
B
C
D
E
F
G
H
I
J
K
L
M
N
O
P

AV

CAMERA CONTROL UNIT

[BOSE AUDIO WITHOUT NAVIGATION]

< ECU DIAGNOSIS >

BOSE AUDIO WITHOUT NAVIGATION WITH DVD ENTERTAINMENT SYSTEM

Connector No.	M65
Connector Name	FRONT SQUAWKER LH
Connector Type	TK02FBR



Terminal No.	Color of Wire	Signal Name [Specification]
1	LG	- [With BOSE system]
2	Y	- [With BOSE system]

Connector No.	M66
Connector Name	CENTER SPEAKER
Connector Type	TK02FBR



Terminal No.	Color of Wire	Signal Name [Specification]
1	P	-
2	O	-

Connector No.	M67
Connector Name	FRONT SQUAWKER RH
Connector Type	TK02FBR



Terminal No.	Color of Wire	Signal Name [Specification]
1	BR	-
2	R	- [With BOSE system]

Connector No.	M77
Connector Name	WIRE TO WIRE
Connector Type	TH80FW-CS19

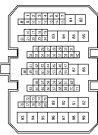

Terminal No.	Color of Wire	Signal Name [Specification]
1	SHIELD	-
2	B	-
3	W	-
4	R	-
8	SHIELD	-
9	W	-
10	R	-
11	G	-
12	B	-
41	O	-
42	SB	-

43	L	-
44	V	-
45	P	-
46	R	-
47	Y	-
48	L	-
49	G	-
50	SHIELD	-
51	W	-
56	P	-
57	L	-
58	SB	-
59	SHIELD	-
60	B	-
61	R	-
62	W	-
68	G	-
69	SHIELD	-
70	L	-
71	R	-

Connector No.	M66
Connector Name	WIRE TO WIRE
Connector Type	TH18FW-NH

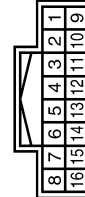

Terminal No.	Color of Wire	Signal Name [Specification]
1	Y	-
3	R	-
4	L	-
5	L	-
6	R	-
7	SHIELD	-
8	R	-
9	G	-
11	B	-
12	G	-
13	R	-

14	W	-
15	SHIELD	-
16	B	-

JCNWM1886GI

CAMERA CONTROL UNIT

[BOSE AUDIO WITHOUT NAVIGATION]

< ECU DIAGNOSIS >

BOSE AUDIO WITHOUT NAVIGATION WITH DVD ENTERTAINMENT SYSTEM

Connector No.	M122
Connector Name	BCM BODY CONTROL MODULE
Connector Type	TH40FB-NH

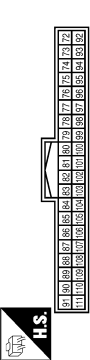

Terminal No.	Color of Wire	Signal Name [Specification]
90	P	CAN-L
91	L	CAN-H

11	LG	-
12	R	-



Terminal No.	Color of Wire	Signal Name [Specification]
1	P	-
2	BR	- [Type A]
3	B	- [Type B]
4	Y	-
5	BR	-
6	O	-
7	W	-
8	B	-
9	R	-
10	BR	-

Connector No.	M127
Connector Name	AV CONTROL UNIT (WITH BOSE SYSTEM WITHOUT NAVIGATION SYSTEM)
Connector Type	TH18FW-CS2

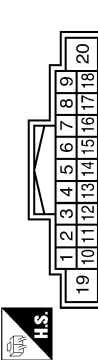

Terminal No.	Color of Wire	Signal Name [Specification]
6	BR	STRG SW A
7	R	ACC
9	R	ILLUMINATION
15	L	STRG SW GND
16	G	STRG SW B
19	Y	BATTERY
20	B	GND

Connector No.	M128
Connector Name	AV CONTROL UNIT (WITH BOSE SYSTEM WITHOUT NAVIGATION SYSTEM)
Connector Type	A12FW

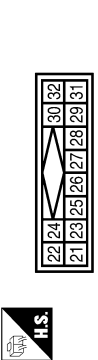

Terminal No.	Color of Wire	Signal Name [Specification]
21	B	SATELLITE RADIO SOUND SIGNAL LH (-)
22	G	SATELLITE RADIO SOUND SIGNAL LH (+)
23	R	SATELLITE RADIO SOUND SIGNAL RH (-)
24	W	SATELLITE RADIO SOUND SIGNAL RH (+)
25	SHIELD	SHIELD
26	SHIELD	SHIELD
28	R	REQUEST (SAT->CONT)
29	W	COMM (SAT->CONT)
30	B	COMM (CONT->SAT)

Connector No.	M125
Connector Name	MULTIFUNCTION SWITCH
Connector Type	TH18FW-NH

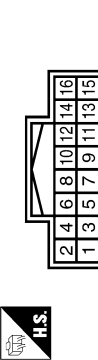

Terminal No.	Color of Wire	Signal Name [Specification]
1	B	GND
3	R	ACC
6	R	AV COMM (H)
8	L	AV COMM (L)
9	V	SW GND
14	W	EJECT SIGNAL

Connector No.	M129
Connector Name	AV CONTROL UNIT (WITH BOSE SYSTEM WITHOUT NAVIGATION SYSTEM)
Connector Type	TH24FW-NH



Terminal No.	Color of Wire	Signal Name [Specification]
36	L	COMPOSITE IMAGE SIGNAL
37	P	COMPOSITE IMAGE GND
38	Y	RGB (B/BLUE) SIGNAL
39	L	RGB (G/GREEN) SIGNAL
40	G	RGB (R/RED) SIGNAL
41	B	RGB SYNC
42	SHIELD	SHIELD
43	W	RGB AREA (YS) SIGNAL
44	G	COMM (DISP->CONT)
45	G	HP
46	LG	SIGNAL GND

A
B
C
D
E
F
G
H
I
J
K
L
M
N
O
P

AV

CAMERA CONTROL UNIT

[BOSE AUDIO WITHOUT NAVIGATION]

< ECU DIAGNOSIS >

BOSE AUDIO WITHOUT NAVIGATION WITH DVD ENTERTAINMENT SYSTEM

Connector No.	M130
Connector Name	AV CONTROL UNIT (WITH BOSE SYSTEM WITHOUT NAVIGATION SYSTEM)
Connector Type	TH16FW-NH



67	66	65	64	63	62	61	60
75	74	73	72	71	70	69	68

Terminal No.	Color of Wire	Signal Name [Specification]
64	SHIELD	SHIELD
65	W	CAMERA IMAGE SIGNAL
66	L	COMPOSITE IMAGE SIGNAL (With DVD player)
68	P	CONNECTION RECOGNITION SHIELD (With DVD player)
74	R	COMPOSITE IMAGE GND (With DVD player)

Connector No.	M132
Connector Name	AV CONTROL UNIT (WITH BOSE SYSTEM WITHOUT NAVIGATION SYSTEM)
Connector Type	TH12FW-NH



114	115	116	117	118	119
108	109	110	111	112	113

Terminal No.	Color of Wire	Signal Name [Specification]
108	V	SOUND SIGNAL REAR RH (+)
109	B	SOUND SIGNAL FRONT RH (+)
110	P	AMP. ON SIGNAL
111	SHIELD	SHIELD
112	O	SOUND SIGNAL REAR LH (+) [Type A]
112	L	SOUND SIGNAL REAR LH (+) [Type B]
113	G	SOUND SIGNAL FRONT LH (+)
114	LG	SOUND SIGNAL REAR RH (-)
115	W	SOUND SIGNAL FRONT RH (-)
118	SB	SOUND SIGNAL REAR LH (-) [Type A]
118	R	SOUND SIGNAL REAR LH (-) [Type B]

Connector No.	M131
Connector Name	AV CONTROL UNIT (WITH BOSE SYSTEM WITH NAVIGATION SYSTEM)
Connector Type	TH24FW-NH



81	80	83	82	84	83	81	80	79	78	77	76
101	100	102	101	103	102	104	103	105	104	106	105

Terminal No.	Color of Wire	Signal Name [Specification]
79	L	TEL VOICE SIGNAL (-)
80	R	TEL VOICE SIGNAL (+)
81	SHIELD	SHIELD
82	W	SOUND SIGNAL RH (-) [With DVD player]
83	R	SOUND SIGNAL RH (+) [With DVD player]
85	B	GND
86	L	CAN-H
87	P	CAN-L
88	R	AV COMM (H)
89	L	AV COMM (L)
90	G	AV COMM (H)

119	R	SOUND SIGNAL FRONT LH (-)
-----	---	---------------------------

91	L	AV COMM (L)
98	G	SOUND SIGNAL LH (-) [With DVD player]
99	B	SOUND SIGNAL LH (+) [With DVD player]
100	SHIELD	SHIELD (With DVD player)
101	V	SW GND
103	W	EJECT SIGNAL
104	G	IGNITION
105	SB	REVERSE
106	G	PARKING BRAKE
107	V	VEHICLE SPEED (8-PULSE)

Connector No.	M148
Connector Name	iPod ADAPTER
Connector Type	TH24FW-NH



1	2	3	4	5	6	7	8	9	10	11	12
13	14	15	16	17	18	19	20	21	22	23	24

Terminal No.	Color of Wire	Signal Name [Specification]
1	BR	iPod SOUND SIGNAL LH (+)
2	R	iPod SOUND SIGNAL RH (+)
3	R	ACC
4	L	AV COMM (L)
5	Y	BATTERY
8	W	CHARGE POWER
9	G	COMM (iPod ADAPTER->iPod)
10	R	COMM (iPod->iPod ADAPTER)
11	R	ACCESSORY IDENTIFY
12	V	iPod SOUND SIGNAL RH (+)
13	L	iPod SOUND SIGNAL LH (-)

14	W	iPod SOUND SIGNAL RH (-)
15	SHIELD	SHIELD
16	R	AV COMM (H)
17	SHIELD	GND
19	SHIELD	SHIELD
21	L	iPod CONNECTION RECOGNITION
22	BR	ACCESSORY DETECT
23	R	iPod SOUND SIGNAL GND
24	LG	iPod SOUND SIGNAL LH (+)

CAMERA CONTROL UNIT

[BOSE AUDIO WITHOUT NAVIGATION]

< ECU DIAGNOSIS >

BOSE AUDIO WITHOUT NAVIGATION WITH DVD ENTERTAINMENT SYSTEM

Connector No.	M204
Connector Name	WIRE TO WIRE
Connector Type	TH12MF-NH



Terminal No.	1	2	3	4	5	6	7	8	9	10	11
Color of Wire	V	R	R	G	W	SHIELD	LG	SHIELD	BR	SHIELD	L
Signal Name [Specification]	-	-	-	-	-	-	-	-	-	-	-

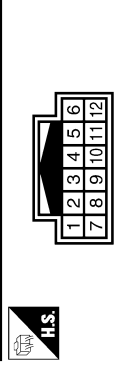

Terminal No.	14	15	16
Color of Wire	W	SHIELD	B
Signal Name [Specification]	-	-	-



Connector No.	M201
Connector Name	WIRE TO WIRE
Connector Type	TH18MW-NH

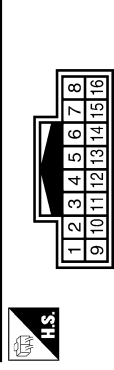

Terminal No.	1	3	4	5	6	7	8	9	11	12	13
Color of Wire	Y	R	G	L	R	SHIELD	V	G	B	G	R
Signal Name [Specification]	-	-	-	-	-	-	-	-	-	-	-

Connector No.	M253
Connector Name	AUXILIARY INPUT JACKS
Connector Type	A08FW

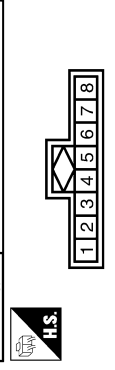

Connector No.	M254
Connector Name	DVD PLAYER
Connector Type	TH432FW-NH

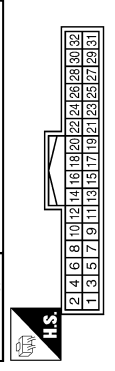

Connector No.	M255
Connector Name	VIDEO DISTRIBUTOR
Connector Type	TH08FW-NH

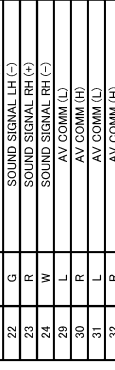

Terminal No.	1	2	3	7	8
Color of Wire	R	W	G	G	SHIELD
Signal Name [Specification]	SOUND SIGNAL RH (+)	SOUND SIGNAL GND	SOUND SIGNAL LH (-) [With DVD player]	AUX IMAGE SIGNAL	SHIELD [With DVD player]

Terminal No.	1	2	4	5	7	11	12	13	14	16	17
Color of Wire	B	Y	V	SHIELD	P	B	W	G	R	SHIELD	G
Signal Name [Specification]	GND	BATTERY	ACC	SHIELD	DVD IMAGE SIGNAL	AUX SOUND SIGNAL LH (-)	AUX SOUND SIGNAL RH (+)	AUX SOUND SIGNAL LH (+)	AUX SOUND SIGNAL RH (+)	SHIELD	HEADPHONE SOUND SIGNAL LH (+)

Terminal No.	53	54	55	56	60
Color of Wire	B	Y	V	G	R
Signal Name [Specification]	GND	BATTERY	ACC	IGNITION	HEADPHONE ON SIGNAL

A
B
C
D
E
F
G
H
I
J
K
L
M
N
O
P

AV

JCNWM1889GI

CAMERA CONTROL UNIT

[BOSE AUDIO WITHOUT NAVIGATION]

< ECU DIAGNOSIS >

BOSE AUDIO WITHOUT NAVIGATION WITH DVD ENTERTAINMENT SYSTEM

Connector No.	M256
Connector Name	VIDEO DISTRIBUTOR
Connector Type	TH12FW-NH



Connector No.	M257
Connector Name	VIDEO DISTRIBUTOR
Connector Type	TH11FW-NH

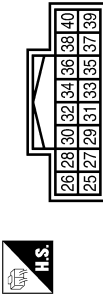

Terminal No.	Color of Wire	Signal Name [Specification]
51	B	GND

Terminal No.	Color of Wire	Signal Name [Specification]
25	R	RGB (R/RED) SIGNAL
26	L	RGB (G/GREEN) SIGNAL
27	W	RGB GND
28	G	RGB (B/BLUE) SIGNAL
29	R	YP
30	W	HP
31	SHIELD	SHIELD
32	B	RGB AREA (S) SIGNAL
33	G	COMPOSITE SYNC
34	R	COMPOSITE IMAGE SIGNAL
35	SHIELD	SHIELD

Connector No.	M258
Connector Name	VIDEO DISTRIBUTOR
Connector Type	TH12FW-NH

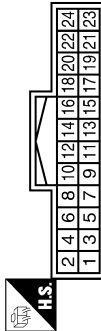

Terminal No.	Color of Wire	Signal Name [Specification]
1	R	AV COMM (H)
2	G	AV COMM (L)
3	R	AV COMM (H)
4	L	AV COMM (L)
6	R	COMPOSITE IMAGE GND
8	L	COMPOSITE IMAGE SIGNAL
15	B	GND
16	B	GND
19	G	AUX IMAGE SIGNAL
21	SHIELD	SHIELD
22	SHIELD	SHIELD

36	G	IGNITION
38	SHIELD	SHIELD
39	V	COMM (DISP->DIST)
40	LG	COMM (DIST->DISP)

Connector No.	M259
Connector Name	WIRE TO WIRE
Connector Type	TH32MW-NH

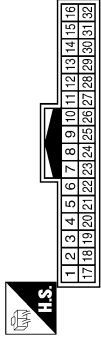

Terminal No.	Color of Wire	Signal Name [Specification]
1	Y	-
3	R	-
4	SHIELD	-
5	LG	-
6	V	-
7	SHIELD	-
8	R	-
9	G	-
10	SHIELD	-
11	W	-
12	G	-

13	L	-
14	R	-
16	G	-
18	V	-
19	L	-
21	LG	-
22	V	-
23	SHIELD	-
24	B	-
25	W	-
26	R	-
27	SHIELD	-
28	G	-
29	R	-
30	SHIELD	-
31	R	-

JCNWM1890GI

CAMERA CONTROL UNIT

[BOSE AUDIO WITHOUT NAVIGATION]

< ECU DIAGNOSIS >

BOSE AUDIO WITHOUT NAVIGATION WITH DVD ENTERTAINMENT SYSTEM

Connector No.	M280
Connector Name	IPod SIDE
Connector Type	IP16FGY

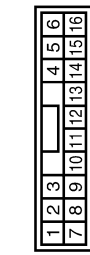

Terminal No.	Color of Wire	Signal Name [Specification]
1	LG	IPod SOUND SIGNAL LH (+)
2	R	IPod SOUND SIGNAL LH (-)
5	R	IPod SOUND SIGNAL GND
6	G	COMM (IPod->IPod ADAPTER)
7	G	COMM (IPod ADAPTER->IPod)
8	V	IPod SOUND SIGNAL RH (+)
10	SHIELD	IPod CONNECTION RECOGNITION GND
12	W	CHARGE POWER SHIELD
14	SHIELD	SHIELD
15	BR	ACCESSORY DETECT
16	R	ACCESSORY IDENTIFY

Connector No.	M303
Connector Name	COMBINATION SWITCH (SPIRAL CABLE)
Connector Type	TK08FGY



Terminal No.	Color of Wire	Signal Name [Specification]
14	-	-
15	-	-
17	-	-

Connector No.	M370
Connector Name	AV CONTROL UNIT (WITH BOSE SYSTEM WITHOUT NAVIGATION SYSTEM)
Connector Type	GT135C-2/IS-HU



Terminal No.	Color of Wire	Signal Name [Specification]
33	-	FM SUB
34	-	AM-FM MAIN
35	-	ANTENNA AMP. ON SIGNAL

Connector No.	M375
Connector Name	WIRE TO WIRE
Connector Type	GT135H-2/IS-HU



Terminal No.	Color of Wire	Signal Name [Specification]
1	-	-
2	-	-
3	-	-

Connector No.	M376
Connector Name	WIRE TO WIRE
Connector Type	GT135CN-2/1PP-HU



Connector No.	M378
Connector Name	ANTENNA BASE (ANTENNA AMP.)
Connector Type	GT135SN-1/1PP-HU

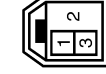

Connector No.	M379
Connector Name	GLASS ANTENNA
Connector Type	GT135CN-1/1PP-HU



Connector No.	RT
Connector Name	WIRE TO WIRE
Connector Type	TH16FW-NH

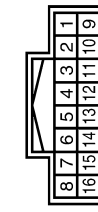

Terminal No.	Color of Wire	Signal Name [Specification]
1	-	-
2	-	-
3	-	-

Terminal No.	Color of Wire	Signal Name [Specification]
1	-	-
3	-	-

Terminal No.	Color of Wire	Signal Name [Specification]
2	-	FM SUB

Terminal No.	Color of Wire	Signal Name [Specification]
1	R/W	-
2	R/L	- [With telephone without navigation system]
3	B	-
4	SHIELD	-

A
B
C
D
E
F
G
H
I
J
K
L
M
O
P

AV

CAMERA CONTROL UNIT

[BOSE AUDIO WITHOUT NAVIGATION]

< ECU DIAGNOSIS >

BOSE AUDIO WITHOUT NAVIGATION WITH DVD ENTERTAINMENT SYSTEM

Connector No.	R20
Connector Name	MICROPHONE
Connector Type	TK04FW



Terminal No.	Color of Wire	Signal Name [Specification]
1	R/W	MICROPHONE SIGNAL (+)
2	R/L	MICROPHONE SIGNAL (-) (Only installed without navigation system)
4	B	MICROPHONE POWER

Connector No.	R152
Connector Name	REAR DISPLAY UNIT
Connector Type	TH02FW-NH



Terminal No.	Color of Wire	Signal Name [Specification]
1	B	GND
2	B	GND
3	Y/R	BATTERY
4	Y/R	BATTERY
5	R	HEADPHONE ON SIGNAL
6	V/Y	ACC
8	SHIELD	SHIELD
9	V	COMM (DISP->DIST)
10	LG	COMM (DISP->DISP)
11	G	IGNITION
12	SHIELD	SHIELD

Connector No.	R153
Connector Name	WIRE TO WIRE
Connector Type	TH02FW-NH



Terminal No.	Color of Wire	Signal Name [Specification]
1	Y/R	-
2	B	-
4	SHIELD	-
5	LG	-
6	V	-
7	SHIELD	-
8	BR	-
9	Y	-
10	SHIELD	-
11	W/L	-
12	Y/G	-

13	G	COMPOSITE SYNC
14	R	COMPOSITE IMAGE SIGNAL
15	B	RGB AREA (Y/S) SIGNAL
16	SHIELD	GND
17	R	V/P
18	W	HP
19	W/L	RGB GND
20	Y/G	RGB (B/BLUE) SIGNAL
21	Y/L	RGB (G/GREEN) SIGNAL
22	BR/L	RGB (R/RED) SIGNAL
23	SHIELD	SHIELD
24	SHIELD	SHIELD
25	LG	HEADPHONE SOUND SIGNAL RH (-)
26	BR	HEADPHONE SOUND SIGNAL LH (-)
27	V	HEADPHONE SOUND SIGNAL RH (+)
28	Y	HEADPHONE SOUND SIGNAL LH (+)

JCNWM1892GI

SYMPTOM DIAGNOSIS

MULTI AV SYSTEM SYMPTOMS

Symptom Table

INFOID:000000003457760

OPERATION

Symptoms	Check items	Possible malfunction location / Action to take
Multifunction switch and preset switch operation does not work.	<ul style="list-style-type: none"> All switches cannot be operated. "MULTI AV" is displayed on system selection screen when the CONSULT-III is started. 	<ul style="list-style-type: none"> Multifunction switch power supply and ground circuit. AV communication circuit between AV control unit and multifunction switch. Perform CONSULT-III self-diagnosis. Refer to AV-83, "CONSULT-III Function (MULTI AV)" .
	<ul style="list-style-type: none"> All switches cannot be operated. "MULTI AV" is not displayed on system selection screen when the CONSULT-III is started. 	AV control unit power supply and ground circuit malfunction. Refer to AV-103, "AV CONTROL UNIT : Diagnosis Procedure" .
	Only specified switch cannot be operated.	Multifunction switch or preset switch malfunction. Replace multifunction switch AV-534, "Exploded View" or preset switch AV-535, "Exploded View" .

RELATED TO HANDS-FREE PHONE

Basic Inspection

- Check that the cellular phone is a corresponding type (Bluetooth™ correspondence) when the hands-free related malfunction vehicle is in service before performing a diagnosis.
- There is a case that malfunction occurs due to the version change of the phone type, etc. even though it is a corresponding type. Therefore, confirm it by changing the cellular phone to another corresponding type phone, and check that it operates normally. It is necessary to distinguish whether the cause is the vehicle or cellular phone.

Simple check for Bluetooth™ communication

- If cellular phone and AV control unit cannot be connected with Bluetooth™ communication, the following procedure allows the technician to judge which device has a malfunction.

- Turn on the cellular phone, not connecting Bluetooth™ communication.
- Start CONSULT-III, then start Windows®.
- Set CONSULT-III near the cellular phone.
- When operating Bluetooth™ registration by cellular phone, check if CONSULT-III* is displayed on the device name.

(If another Bluetooth™ device is located near the cellular phone, the name of the device will also be displayed.)

NOTE:

*:Displayed device name is "NISSAN-*****".

- If no device name is displayed, cellular phone is malfunctioning. Repair the cellular phone first, then perform diagnosis.
- If CONSULT-III is displayed on device name, cellular phone is normal. Perform diagnosis as per the following table.

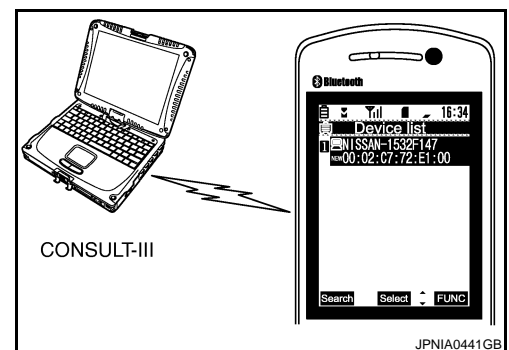

On board self-diagnosis of hands-free phone system

Always perform the on board self-diagnosis at first after completing the basic inspection when the malfunction is detected on the hands-free phone system. Narrow down possible causes using the Diagnosis Chart if there is no malfunction in the on board self-diagnosis.

Trouble diagnosis chart by symptom

MULTI AV SYSTEM SYMPTOMS

[BOSE AUDIO WITHOUT NAVIGATION]

< SYMPTOM DIAGNOSIS >

Symptoms	Check items	Probable malfunction location
Does not recognize cellular phone connection. (No connection is displayed on the display at the guide.)	Repeat the registration of cellular phone.	TEL adapter unit malfunction. Refer to AV-547, "Exploded View" .
Hands-free phone cannot be established.	Both the reception and the speech cannot be performed	<ul style="list-style-type: none"> Perform CONSULT-III self-diagnosis. Refer to AV-83, "CONSULT-III Function (MULTI AV)". No malfunction. TEL adapter unit malfunction. Refer to AV-547, "Exploded View".
The other party's voice cannot be heard by hands-free phone.	The operation of the "☞" switch can be performed.	TEL voice signal circuit malfunction between TEL adapter unit and AV control unit.
	The operation of the "☞" switch cannot be performed.	Control signal circuit. Refer to AV-135, "Diagnosis Procedure" .
Originating sound is not heard by the other party with hands-free phone communication.	Sound operation function is normal.	TEL adapter unit. Refer to AV-547, "Exploded View" .
	Sound operation function does not work.	Microphone signal circuit. Refer to AV-133, "Diagnosis Procedure" .

RELATED TO CAMERA

Trouble diagnosis chart by symptom

Symptoms	Check items	Probable malfunction location
Camera image is not displayed (displayed in black and nothing can be displayed).	For front display unit, AUX image is not displayed.	<ul style="list-style-type: none"> Horizontal synchronizing (HP) signal circuit malfunction between AV control unit and front display unit. Refer to AV-116, "Diagnosis Procedure". Vertical synchronizing (VP) signal circuit malfunction between AV control unit and front display unit. Refer to AV-117, "Diagnosis Procedure".
Camera image is not shown. (Vehicle width and possible route line is displayed.)	—	<ul style="list-style-type: none"> Camera image signal circuit between camera control unit and rear view camera. Refer to AV-136, "Diagnosis Procedure". Rear view camera ON signal circuit. Refer to AV-137, "Diagnosis Procedure".
Camera image is not displayed. (Only warning message under area is displayed.)	There is malfunction in the CONSULT-III self-diagnosis result.	Perform detected DTC self-diagnosis. Refer to AV-83, "CONSULT-III Function (MULTI AV)" .
	For front display unit, AUX image is normal.	Camera image signal circuit malfunction between camera control unit and AV control unit. Refer to AV-138, "Diagnosis Procedure" .
	For front display unit, AUX image is not displayed.	<ul style="list-style-type: none"> RGB area (YS) signal circuit malfunction between AV control unit and front display unit. Refer to AV-115, "Diagnosis Procedure". Composite image signal circuits malfunction between AV control unit and front display unit. Refer to AV-118, "Diagnosis Procedure".
	Select "Camera Cont." of Confirmation/Adjustment mode, Reverse Sensor is not turned ON at "Connection Confirmation".	Reverse signal circuit malfunction (camera control unit).
Camera image is rolling.	For front display unit, AUX image is also rolling.	<ul style="list-style-type: none"> Horizontal synchronizing (HP) signal circuit malfunction between AV control unit and front display unit. Refer to AV-116, "Diagnosis Procedure". Vertical synchronizing (VP) signal circuit malfunction between AV control unit and front display unit. Refer to AV-117, "Diagnosis Procedure".

MULTI AV SYSTEM SYMPTOMS

[BOSE AUDIO WITHOUT NAVIGATION]

< SYMPTOM DIAGNOSIS >

Symptoms	Check items	Probable malfunction location
Camera image does not switch.	Malfunction of self-diagnosis result is indicated.	Camera-connection recognition signal circuit malfunction between AV control unit and camera control unit. Refer to AV-98, "Diagnosis Procedure" .
	Malfunction of self-diagnosis result is not indicated.	Reverse signal circuit malfunction (AV control unit).
Possible route line is indicated abnormally when camera image is displayed.	—	Steering angle sensor signal circuit malfunction. Refer to AV-139, "Diagnosis Procedure" .

RELATED TO RGB IMAGE (FRONT DISPLAY UNIT)

Trouble diagnosis chart by symptom

Symptoms	Check items	Possible malfunction location / Action to take
RGB image is not shown.	<ul style="list-style-type: none"> All RGB images are not shown. "MULTI AV" is displayed on system selection screen when the CONSULT-III is started. 	Perform CONSULT-III self-diagnosis. Refer to AV-83, "CONSULT-III Function (MULTI AV)" .
	<ul style="list-style-type: none"> All RGB images are not shown. "MULTI AV" is not displayed on system selection screen when the CONSULT-III is started. 	AV control unit power supply and ground circuit malfunction. Refer to AV-103, "AV CONTROL UNIT : Diagnosis Procedure" .
Color of RGB image is not proper.	Light blue (Cyan) tint.	RGB signal (R: red) circuit malfunction between AV control unit and front display unit. Refer to AV-111, "Diagnosis Procedure" .
	Purple (Magenta) tint.	RGB signal (G: green) circuit malfunction between AV control unit and front display unit. Refer to AV-112, "Diagnosis Procedure" .
	Screen looks yellowish.	RGB signal (B: blue) circuit malfunction between AV control unit and front display unit. Refer to AV-113, "Diagnosis Procedure" .
RGB screen is rolling.	Front display unit, AUX and DVD image are normal.	RGB synchronizing signal circuit malfunction between AV control unit and front display unit. Refer to AV-114, "Diagnosis Procedure" .

RELATED TO REAR DISPLAY

Trouble diagnosis chart by symptom

Symptoms	Check items	Possible malfunction location / Action to take
The menu screen is not displayed.	For rear display unit, AUX and DVD image are normal.	<ul style="list-style-type: none"> Vertical synchronizing (VP) signal circuit malfunction between video distributor and rear display unit. Refer to AV-126, "Diagnosis Procedure". Horizontal synchronizing (HP) signal circuit malfunction between video distributor and rear display unit. Refer to AV-127, "Diagnosis Procedure". RGB area (YS) signal circuit malfunction between video distributor and rear display unit. Refer to AV-125, "Diagnosis Procedure".
Color of RGB image (menu display screen) is not proper.	Light blue (Cyan) tint.	RGB signal (R: red) circuit malfunction between video distributor and rear display unit. Refer to AV-121, "Diagnosis Procedure" .
	Purple (Magenta) tint.	RGB signal (G: green) circuit malfunction between video distributor and rear display unit. Refer to AV-122, "Diagnosis Procedure" .
	Screen looks yellowish.	RGB signal (B: blue) circuit malfunction between video distributor and rear display unit. Refer to AV-123, "Diagnosis Procedure" .

A
B
C
D
E
F
G
H
I
J
K
L
M
O
P

AV

MULTI AV SYSTEM SYMPTOMS

[BOSE AUDIO WITHOUT NAVIGATION]

< SYMPTOM DIAGNOSIS >

Symptoms	Check items	Possible malfunction location / Action to take
AUX and DVD image are not displayed.	Front display unit is not displayed.	Perform CONSULT-III self-diagnosis. Refer to AV-83, "CONSULT-III Function (MULTI AV)" .
	Front display unit is normal.	Composite image signal circuit malfunction between video distributor and rear display unit. Refer to AV-120, "Diagnosis Procedure" .
AUX and DVD image are rolling.	Front display unit displayed, AUX and DVD image are not rolling.	Composite synchronizing signal circuit malfunction between video distributor and rear display unit. Refer to AV-124, "Diagnosis Procedure" .
Rear display unit does not open.	—	Perform detected DTC self-diagnosis. Refer to AV-83, "CONSULT-III Function (MULTI AV)" .

RELATED TO AUDIO

Trouble diagnosis chart by symptom

Symptoms	Check items	Possible malfunction location / Action to take
The CD cannot be removed.	—	Disk eject signal circuit.
There is no Audio sound.	No sound from all speakers.	<ul style="list-style-type: none"> BOSE amp. power supply and ground circuit. Refer to AV-107, "BOSE AMP. : Diagnosis Procedure". Amp. ON signal circuit between AV control unit and BOSE amp.
	No sound from woofer.	<ul style="list-style-type: none"> Woofer power supply and ground circuit. Refer to AV-108, "WOOFER : Diagnosis Procedure". Sound signal woofer circuit between BOSE amp. and woofer. Woofer amp. ON signal circuit between BOSE amp. and woofer.
	There is no sound from center speaker.	Sound signal center speaker circuit.
	There is sound from only specific places (RH front, RH rear, LH front and LH rear).	Sound signal circuit of malfunctioning system.
Satellite radio is not received.	"ANTENNA" is not displayed even when the channel is turned to 0 in Satellite radio mode.	Perform the following inspection procedure. <ol style="list-style-type: none"> Check antenna base mounting nut for looseness. NOTE: Tightening torque: 6.5 N·m (0.66 kg·m, 58 in·lb.) Visually check for satellite radio antenna feeder. Replace the antenna base. Refer to AV-545, "Exploded View". Replace the satellite radio tuner. Refer to AV-546, "Exploded View".
	"ANTENNA" is displayed when the channel is turned to 0 in Satellite radio mode.	Perform the following inspection procedure. <ol style="list-style-type: none"> Check the connection between satellite radio tuner and antenna connector. Check the connection between satellite radio antenna and antenna feeder. Check antenna feeder for open circuit. Replace the antenna base. Refer to AV-545, "Exploded View". Replace the satellite radio tuner. Refer to AV-546, "Exploded View".
The sound of satellite radio is not heard.	Other audio sounds are normal.	Satellite radio sound signal circuit between AV control unit and satellite radio tuner.
It does not change to satellite radio mode.	There is malfunction in the CONSULT-III self-diagnosis result.	Perform CONSULT-III self-diagnosis. Refer to AV-83, "CONSULT-III Function (MULTI AV)" .
AM/FM radio is not received.	Other audio sounds are normal.	<ul style="list-style-type: none"> Antenna amp. ON signal circuit. Antenna feeder.

RELATED TO iPod®

Connect another iPod® and check if the symptom is reproduced or not. If the symptom is reproduced, diagnose the vehicle. If no malfunction is detected, replace the iPod harness.

NOTE:

MULTI AV SYSTEM SYMPTOMS

[BOSE AUDIO WITHOUT NAVIGATION]

< SYMPTOM DIAGNOSIS >

It is unable to check connection between iPod® and iPod harness.

Trouble diagnosis chart by symptom

Symptoms	Check items	Possible malfunction location / Action to take
The iPod® does not produce sound.	Other audio sounds are normal.	<ul style="list-style-type: none"> iPod sound signal circuit between AV control unit and iPod adapter. iPod sound signal circuit between iPod® and iPod adapter.
It does not change to iPod mode.	There is malfunction in the CONSULT-III self-diagnosis.	Perform CONSULT-III self-diagnosis. Refer to AV-83, "CONSULT-III Function (MULTI AV)" .
"iPod is not connected" is displayed when it comes to iPod mode.	Connected to iPod®.	iPod connection recognition signal circuit between iPod® and iPod adapter.
iPod® cannot charge the battery.	—	iPod battery charge circuit between iPod® and iPod adapter.
The title of music file in the iPod® is not indicated.	—	Serial communication circuit between iPod® and iPod adapter.
Accessing the iPod® is unavailable from the vehicle.		

RELATED TO STEERING SWITCH

Trouble diagnosis chart by symptom

Symptoms	Probable malfunction location
None of the steering switch operations work.	Steering switch signal GND circuit. Refer to AV-145, "Diagnosis Procedure" .
Only specified switch cannot be operated.	Steering switch. Refer to AV-536, "Exploded View" .
"SOURCE", "MENU UP", "MENU DOWN", "⏪ ⏩" switches of steering switch are not operational.	Steering switch signal A circuit. Refer to AV-141, "Diagnosis Procedure" .
"VOL UP", "VOL DOWN", "⏮ ⏭" switches of steering switch are not operational.	Steering switch signal B circuit. Refer to AV-143, "Diagnosis Procedure" .

RELATED TO AUXILIARY INPUT (WITHOUT DVD PLAYER MODELS)

NOTE:

Check that there is no malfunction of AUX equipment main body before performing a diagnosis.

Trouble diagnosis chart by symptom

Symptoms	Check items	Probable malfunction location
For front display unit, AUX image is not displayed (Menu display is not displayed, too).	Camera image is not displayed (Also, menu display is not displayed).	<ul style="list-style-type: none"> Horizontal synchronizing (HP) signal circuit malfunction between AV control unit and front display unit. Refer to AV-116, "Diagnosis Procedure". Vertical synchronizing (VP) signal circuit malfunction between AV control unit and front display unit. Refer to AV-117, "Diagnosis Procedure".
For front display unit, AUX image is not displayed (Menu display is normal).	Camera image is not displayed (Menu display is normal).	<ul style="list-style-type: none"> Composite image signal circuits malfunction between AV control unit and front display unit. Refer to AV-119, "Diagnosis Procedure". RGB area (YS) signal circuit malfunction between AV control unit and front display unit. Refer to AV-115, "Diagnosis Procedure".
	Camera image is normal.	AUX image signal circuit malfunction between AV control unit and auxiliary input jacks. Refer to AV-128, "WITHOUT DVD ENTERTAINMENT SYSTEM : Diagnosis Procedure" .

MULTI AV SYSTEM SYMPTOMS

< SYMPTOM DIAGNOSIS >

[BOSE AUDIO WITHOUT NAVIGATION]

Symptoms	Check items	Probable malfunction location
For front display unit, AUX image is rolling.	Camera image is rolling.	<ul style="list-style-type: none"> Horizontal synchronizing (HP) signal circuit malfunction between AV control unit and front display unit. Refer to AV-116, "Diagnosis Procedure". Vertical synchronizing (VP) signal circuit malfunction between AV control unit and front display unit. Refer to AV-117, "Diagnosis Procedure".
There is no AUX sound from speaker on the right or left side.	The sound other than AUX sound is normal.	AUX sound signal circuit malfunction between auxiliary input jacks and AV control unit at the side where there is no sound.

RELATED TO AUXILIARY INPUT (WITH DVD PLAYER MODELS)

NOTE:

Check that there is no AUX equipment main body malfunction before performing a diagnosis.

Trouble diagnosis chart by symptom

Symptoms	Check items	Probable malfunction location
Front display unit and rear display unit, AUX image is not displayed.	DVD image is not displayed.	Perform CONSULT-III self-diagnosis. Refer to AV-83, "CONSULT-III Function (MULTI AV)" .
For front display unit, AUX image is not displayed (Menu display is normal).	DVD image is normal.	AUX image signal circuit malfunction between auxiliary input jacks and video distributor. Refer to AV-129, "WITH DVD ENTERTAINMENT SYSTEM : Diagnosis Procedure" .
	Camera image is normal.	Perform CONSULT-III self-diagnosis. Refer to AV-83, "CONSULT-III Function (MULTI AV)" . When detecting no malfunction in those components, the following items are a possible cause. Composite image signal circuits malfunction between video distributor and AV control unit. Refer to AV-119, "Diagnosis Procedure" .
	DVD and camera images are not displayed (Menu display is normal).	Perform CONSULT-III self-diagnosis. Refer to AV-83, "CONSULT-III Function (MULTI AV)" . When detecting no malfunction in those components, the following items are a possible cause. <ul style="list-style-type: none"> RGB area (YS) signal circuit malfunction between AV control unit and front display unit. Refer to AV-115, "Diagnosis Procedure". Composite image signal circuits malfunction between front display unit and AV control unit. Refer to AV-118, "Diagnosis Procedure".
For front display unit, AUX image is not displayed (Menu display is not displayed, too).	DVD image is not displayed (Also, menu display is not displayed).	<ul style="list-style-type: none"> Horizontal synchronizing (HP) signal circuit malfunction between AV control unit and front display unit. Refer to AV-116, "Diagnosis Procedure". Vertical synchronizing (VP) signal circuit malfunction between AV control unit and front display unit. Refer to AV-117, "Diagnosis Procedure".
For front display unit, AUX image is rolling.	DVD image is rolling.	<ul style="list-style-type: none"> Horizontal synchronizing (HP) signal circuit malfunction between AV control unit and front display unit. Refer to AV-116, "Diagnosis Procedure". Vertical synchronizing (VP) signal circuit malfunction between AV control unit and front display unit. Refer to AV-117, "Diagnosis Procedure".
For rear display unit, AUX image is not displayed (Menu display is normal).	DVD image is not displayed (Menu display is normal).	Composite image signal circuits malfunction between video distributor and rear display unit. Refer to AV-119, "Diagnosis Procedure" .

MULTI AV SYSTEM SYMPTOMS

[BOSE AUDIO WITHOUT NAVIGATION]

< SYMPTOM DIAGNOSIS >

Symptoms	Check items	Probable malfunction location
At AUX of rear display, menu display is not displayed.	AUX image is normal.	<ul style="list-style-type: none"> Vertical synchronizing (VP) signal circuit malfunction between video distributor and rear display unit. Refer to AV-126, "Diagnosis Procedure". Horizontal synchronizing (HP) signal circuit malfunction between video distributor and rear display unit. Refer to AV-127, "Diagnosis Procedure". RGB area (YS) signal circuit malfunction between video distributor and rear display unit. Refer to AV-125, "Diagnosis Procedure".
For rear display unit, AUX and DVD image are rolling.	Front display unit displayed, AUX and DVD image are not rolling.	Composite synchronizing signal circuit malfunction between video distributor and rear display unit. Refer to AV-124, "Diagnosis Procedure" .
There is no AUX sound.	—	Perform CONSULT-III self-diagnosis. Refer to AV-83, "CONSULT-III Function (MULTI AV)" .
There is no AUX sound from speaker on the right or left side.	DVD sound is not normal, neither.	DVD and AUX sound signal circuit malfunction between DVD player and AV control unit at the side where there is no sound.
	The sound other than AUX sound is normal.	AUX sound signal circuit malfunction between auxiliary input jacks and DVD player at the side where there is no sound.
It does not change to AUX mode.	There is malfunction in the CONSULT-III self-diagnosis result.	Perform CONSULT-III self-diagnosis. Refer to AV-83, "CONSULT-III Function (MULTI AV)" .

RELATED TO DVD MODE

Trouble diagnosis chart by symptom

Symptoms	Check items	Probable malfunction location
Front display unit and rear display unit, DVD image is not displayed.	AUX image is not displayed.	Perform CONSULT-III self-diagnosis. Refer to AV-83, "CONSULT-III Function (MULTI AV)" .
For front display unit, DVD image is not displayed (Menu display is normal).	Camera image is normal.	Perform CONSULT-III self-diagnosis. Refer to AV-83, "CONSULT-III Function (MULTI AV)" . When detecting no malfunction in those components, the following items are a possible cause. Composite image signal circuits malfunction between video distributor and AV control unit. Refer to AV-119, "Diagnosis Procedure" .
	Camera image is not displayed (Only warning message under area is displayed).	<ul style="list-style-type: none"> Composite image signal circuits malfunction between AV control unit and front display unit. Refer to AV-118, "Diagnosis Procedure". RGB area (YS) signal circuit malfunction between AV control unit and front display unit. Refer to AV-115, "Diagnosis Procedure".
For front display unit, DVD image is not displayed (Menu display is not displayed).	AUX image is not displayed (Menu display is not displayed).	<ul style="list-style-type: none"> Horizontal synchronizing (HP) signal circuit malfunction between AV control unit and front display unit. Refer to AV-116, "Diagnosis Procedure". Vertical synchronizing (VP) signal circuit malfunction between AV control unit and front display unit. Refer to AV-117, "Diagnosis Procedure".
For front display, DVD image is rolling.	AUX image is rolling.	<ul style="list-style-type: none"> Horizontal synchronizing (HP) signal circuit malfunction between AV control unit and front display unit. Refer to AV-116, "Diagnosis Procedure". Vertical synchronizing (VP) signal circuit malfunction between AV control unit and front display unit. Refer to AV-117, "Diagnosis Procedure".
For rear display, DVD image is not displayed (Menu display is normal).	AUX image is not displayed (Menu display is normal).	Composite image signal circuits malfunction between video distributor and rear display unit. Refer to AV-120, "Diagnosis Procedure" .

MULTI AV SYSTEM SYMPTOMS

< SYMPTOM DIAGNOSIS >

[BOSE AUDIO WITHOUT NAVIGATION]

Symptoms	Check items	Probable malfunction location
At DVD of rear display unit, menu display is not displayed.	DVD image is normal.	<ul style="list-style-type: none"> • Vertical synchronizing (VP) signal circuit malfunction between video distributor and rear display unit. Refer to AV-126, "Diagnosis Procedure". • Horizontal synchronizing (HP) signal circuit malfunction between video distributor and rear display unit. Refer to AV-127, "Diagnosis Procedure". • RGB area (YS) signal circuit malfunction between video distributor and rear display unit. Refer to AV-125, "Diagnosis Procedure".
For rear display unit, DVD and AUX image are rolling.	Front display unit displayed, DVD and AUX image are not rolling.	Composite synchronizing signal circuit malfunction between video distributor and rear display unit. Refer to AV-124, "Diagnosis Procedure" .
There is no DVD sound.	—	Perform CONSULT-III self-diagnosis. Refer to AV-83, "CONSULT-III Function (MULTI AV)" .
There is no DVD sound from speaker on the right or left side.	AUX sound is not normal, neither.	DVD and AUX sound signal circuit malfunction between DVD player and AV control unit at the side where there is no sound.
It does not change to DVD mode.	There is malfunction in the CONSULT-III self-diagnosis result.	Perform CONSULT-III self-diagnosis. Refer to AV-83, "CONSULT-III Function (MULTI AV)" .

RELATED TO REMOTE CONTROL AND HEADPHONE

Trouble diagnosis chart by symptom

Symptoms	Check items	Probable malfunction location
Headphone does not work	Change headphones to another set.	They operate normally. <ul style="list-style-type: none"> • Battery of headphones. • Headphones.
		It does not operate normally. <ul style="list-style-type: none"> • Headphone sound signal circuit malfunction between DVD player and rear display unit. • Headphone ON signal circuit malfunction between video distributor and rear display unit.
Remote control does not work.	Change remote controller to another one.	They operate normally. <ul style="list-style-type: none"> • Battery of remote controller. • Remote controller body.
		It does not operate normally. Perform CONSULT-III self-diagnosis. Refer to AV-83, "CONSULT-III Function (MULTI AV)" . When detecting no malfunction in those components, the following items are a possible cause. Rear display unit.

NORMAL OPERATING CONDITION

< SYMPTOM DIAGNOSIS >

[BOSE AUDIO WITHOUT NAVIGATION]

NORMAL OPERATING CONDITION

Description

INFOID:000000003486709

NOTE:

Vehicle operation information, refer to Owner's Manual.

BASIC OPERATIONS

Symptom	Possible cause	Possible solution
No image is displayed.	The brightness is at the lowest setting.	Adjust the brightness of the display.
	The system is in the video mode.	Push <DISC> to change the mode.
	The display is turned off.	Push <Day/Night> to turn on the display.
The screen is too dim. The movement is slow.	The temperature in the interior of the vehicle is low.	Wait until the interior of the vehicle has warmed up.
Some pixels in the display are darker or brighter than others.	This condition is an inherent characteristic of liquid crystal displays.	This is not a malfunction.
Some menu items cannot be selected.	Some menu items become unavailable while the vehicle is driven.	Park the vehicle in a safe location, and then operate the multi AV system.

RELATED TO VOICE RECOGNITION

Related to telephone

The system should respond correctly to all voice commands without difficulty. If problems are encountered, try the following solutions.

Where the solutions are listed by number, try each solution in turn, starting with number 1, until the problem is resolved.

Symptom	Solution
System fails to interpret the command correctly.	1. Ensure that the command is valid.
	2. Ensure that the command is spoken after the tone.
	3. Speak clearly without pausing between words and at level appropriate to the ambient noise level in the vehicle.
	4. Ensure that the ambient noise level is not excessive (for example, windows open or defroster on). NOTE: If it is too noisy to use the phone, it is likely that the voice commands will be recognized.
	5. If more than one command was said at a time, try saying the commands separately.
	6. If the system consistently fails to recognize commands, the voice training procedure should be carried out to improve the recognition response for the speaker. See "Speaker adaptation (SA) mode" earlier in this section. Refer to "OWNER'S MANUAL".
The system consistently selects the wrong voicetag	1. Ensure that the phone book entry name requested matches what was originally stored. This can be confirmed by using the "List Names" command.
	2. Replace one of the names being confused with a new name.

RELATED TO AUDIO

- The majority of the audio malfunctions are the result of outside causes (bad CD/cassette, electromagnetic interference, etc.). Check the symptoms below to diagnose the malfunction.
- The vehicle itself can be a source of noise if noise prevention parts or electrical equipment is malfunctioning. Check if noise is caused and/or changed by engine speed, ignition switch turned to each position, and operation of each piece of electrical equipment, and then determine the cause.

NOTE:

- CD-R is not guaranteed to play because they can contain compressed audio (MP3, WMA) or could be incorrectly mastered by the customer on a computer.
- Check if the CDs carry the Compact Disc Logo. If not, the disc is not mastered to the "red book" Compact Disc Standard and may not play.

NORMAL OPERATING CONDITION

< SYMPTOM DIAGNOSIS >

[BOSE AUDIO WITHOUT NAVIGATION]

Symptom	Cause and Counter measure
Cannot play	Check if the CD was inserted correctly.
	Check if the CD is scratched or dirty.
	Check if there is condensation inside the player, and if there is, wait until the condensation is gone (about 1 hour) before using the player.
	If there is a temperature increase error, the player will play correctly after it returns to the normal temperature.
	If there is a mixture of music CD files (CD-DA data) and MP3/WMA files on a CD, only the music CD files (CD-DA data) will be played.
	Files with extensions other than ".MP3", ".WMA", ".mp3", or ".wma" cannot be played. In addition, the character codes and number of characters for folder names and file names should be in compliance with the specifications.
	Check if the disc or the file is generated in an irregular format, This may occur depending on the variation or the setting of MP3/WMA writing applications or other text editing applications.
	Check if the finalization process, such as session close and disc close, is done for the disc.
Poor sound quality	Check if the CD is scratched or dirty.
It takes a relatively long time before the music starts playing.	If there are many folder or file levels on the MP3/WMA CD, or if it is a multisession disc, some time may be required before the music starts playing.
Music cuts off or skips	The writing software and hardware combination might not match, or the writing speed, writing depth, writing width might not match the specifications. Try using the slowest writing speed.
Skipping with high bit rate files	Skipping may occur with large quantities if data such as for high bit rate data.
Move immediately to the next song when playing	When a non-MP3/WMA file has been given an extension of ".MP3", ".WMA", ".mp3", or ".wma", or when play is prohibited by copyright protection, the player will skip to the next song.
The songs do not play back in the desired order.	The playback order is the order in which the files were written by the software, so the files might not play in the desired order.

Noise resulting from variations in field strength, such as fading noise and multi-path noise, or external noise from trains and other sources, is not a malfunction.

NOTE:

- Fading noise: This noise occurs because of variations in the field strength in a narrow range due to mountains or buildings blocking the signal.
- Multi-path noise: This noise results from a time difference between the broadcast waves directly from the station arriving at the antenna and the waves reflected by mountains or buildings.

PRECAUTION

PRECAUTIONS

Precaution for Supplemental Restraint System (SRS) "AIR BAG" and "SEAT BELT PRE-TENSIONER"

INFOID:000000003671425

The Supplemental Restraint System such as "AIR BAG" and "SEAT BELT PRE-TENSIONER", used along with a front seat belt, helps to reduce the risk or severity of injury to the driver and front passenger for certain types of collision. This system includes seat belt switch inputs and dual stage front air bag modules. The SRS system uses the seat belt switches to determine the front air bag deployment, and may only deploy one front air bag, depending on the severity of a collision and whether the front occupants are belted or unbelted. Information necessary to service the system safely is included in the "SRS AIRBAG" and "SEAT BELT" of this Service Manual.

WARNING:

- To avoid rendering the SRS inoperative, which could increase the risk of personal injury or death in the event of a collision which would result in air bag inflation, all maintenance must be performed by an authorized NISSAN/INFINITI dealer.
- Improper maintenance, including incorrect removal and installation of the SRS, can lead to personal injury caused by unintentional activation of the system. For removal of Spiral Cable and Air Bag Module, see the "SRS AIRBAG".
- Never use electrical test equipment on any circuit related to the SRS unless instructed to in this Service Manual. SRS wiring harnesses can be identified by yellow and/or orange harnesses or harness connectors.

PRECAUTIONS WHEN USING POWER TOOLS (AIR OR ELECTRIC) AND HAMMERS

When working near the Airbag Diagnosis Sensor Unit or other Airbag System sensors while ignition switch is ON or engine is running, never use air or electric power tools or strike near the sensor(s) with a hammer. Heavy vibration may activate the sensor(s), deploy the airbag(s), possibly cause serious injury. When using air or electric power tools or hammers, always turn OFF ignition switch, disconnect the battery, and wait 3 minutes or more before performing any service.

Precaution for Trouble Diagnosis

INFOID:000000003356845

AV COMMUNICATION SYSTEM

- Do not apply voltage of 7.0 V or higher to the measurement terminals.
- Use the tester with its open terminal voltage at 7.0 V or less.
- Turn ignition switch OFF and disconnect the battery cable from the negative terminal before checking the circuit.

Precaution for Harness Repair

INFOID:000000003356846

AV COMMUNICATION SYSTEM

- Solder the repaired parts, and wrap with tape. [Frays of twisted line must be within 110 mm (4.33 in).]

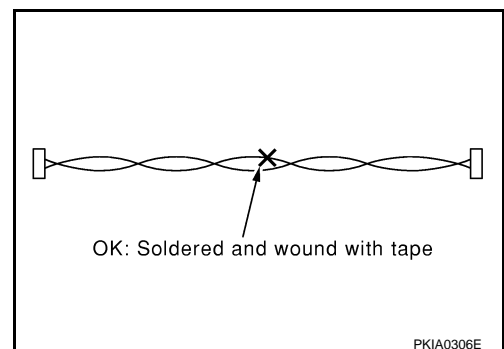

PKIA0306E

A
B
C
D
E
F
G
H
I
J
K
L
M
O
P

AV

PRECAUTIONS

< PRECAUTION >

[BOSE AUDIO WITHOUT NAVIGATION]

- Do not perform bypass wire connections for the repair parts. (The spliced wire will become separated and the characteristics of twisted line will be lost.)

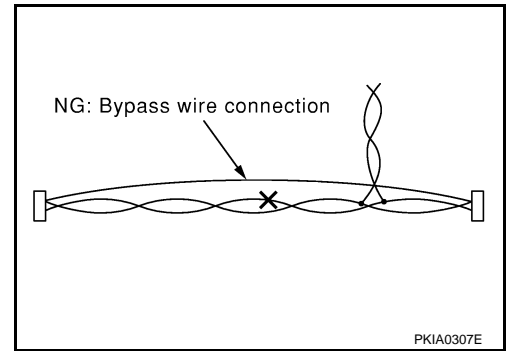

PREPARATION

< PREPARATION >

[BOSE AUDIO WITHOUT NAVIGATION]

PREPARATION

PREPARATION

Commercial Service Tools

INFOID:000000003356847

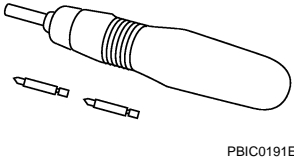
Tool name	Description
<p>Power tool</p>  <p>PBIC0191E</p>	<p>Loosening screws</p>

A
B
C
D
E
F
G
H
I
J
K
L
M
AV
O
P

AV

ON-VEHICLE REPAIR

AV CONTROL UNIT

Exploded View

INFOID:000000003507980

REMOVAL

Refer to [IP-11. "Exploded View"](#).

DISASSEMBLY

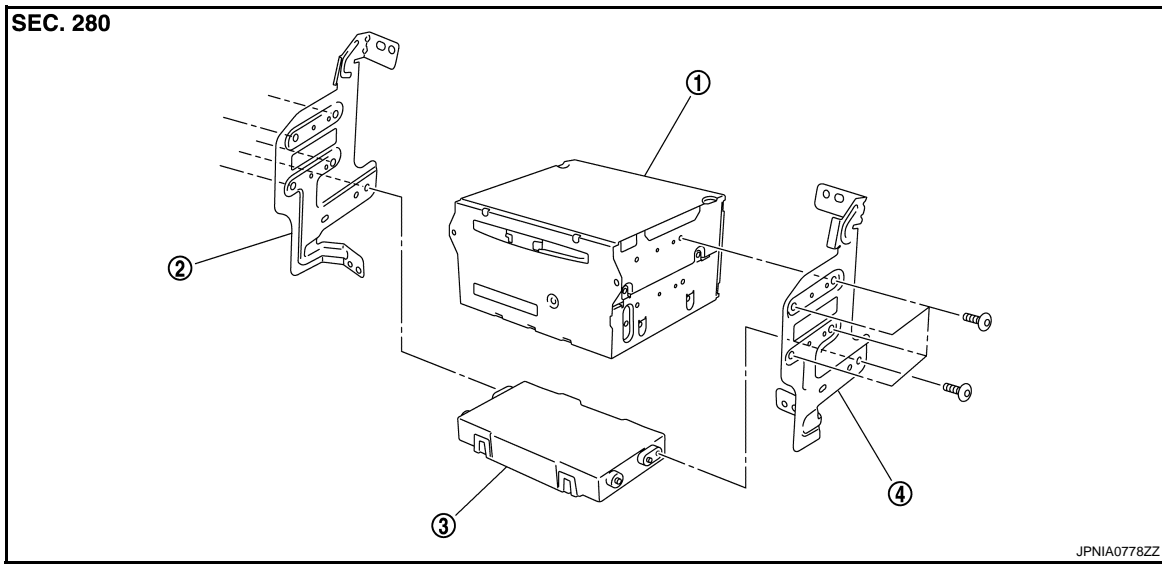

- | | | |
|--------------------|---------------|------------------|
| 1. AV control unit | 2. Bracket LH | 3. A/C auto amp. |
| 4. Bracket RH | | |

Removal and Installation

INFOID:000000003507981

REMOVAL

1. Remove cluster lid C. Refer to [IP-11. "Exploded View"](#).
2. Remove AV control unit with a A/C auto amp. as a single unit from the body.
3. Remove bracket screws, and then remove AV control unit.

INSTALLATION

Install in the reverse order of removal.

FRONT DISPLAY UNIT

< ON-VEHICLE REPAIR >

[BOSE AUDIO WITHOUT NAVIGATION]

FRONT DISPLAY UNIT

Exploded View

INFOID:000000003507982

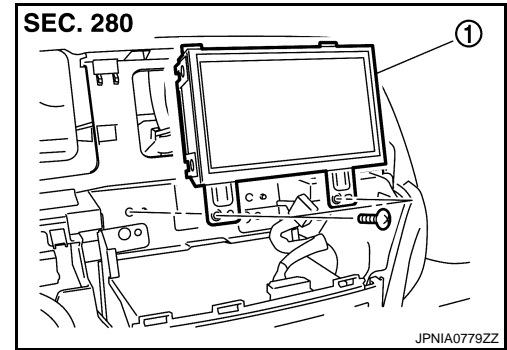

1. Front display unit

Removal and Installation

INFOID:000000003507983

REMOVAL

1. Remove center ventilator assembly. Refer to [IP-11, "Exploded View"](#).
2. Remove display unit with bracket as a single unit.

INSTALLATION

Install in the reverse order of removal.

A
B
C
D
E
F
G
H
I
J
K
L
M
O
P

AV

REAR DISPLAY UNIT

< ON-VEHICLE REPAIR >

[BOSE AUDIO WITHOUT NAVIGATION]

REAR DISPLAY UNIT

Exploded View

INFOID:000000003508042

REMOVAL

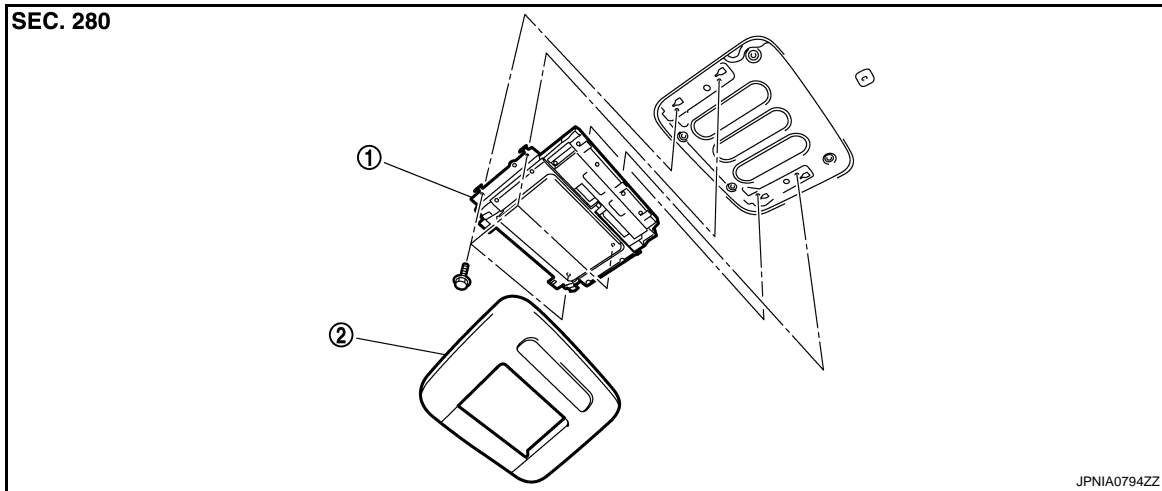

1. Rear display unit

2. Rear display cover

Removal and Installation

INFOID:000000003508019

REMOVAL

1. Insert cloth-covered driver into gaps between rear display cover (1) and headlining, and remove rear display cover.

← Vehicle front

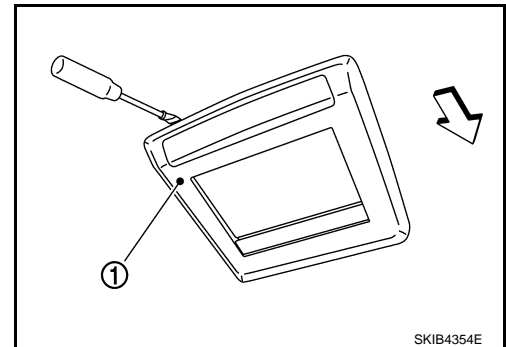

2. Disconnect rear display unit connector, remove rear display unit screws and remove the rear display unit.

INSTALLATION

Install in the reverse order of removal.

VIDEO DISTRIBUTOR

[BOSE AUDIO WITHOUT NAVIGATION]

< ON-VEHICLE REPAIR >

VIDEO DISTRIBUTOR

Exploded View

INFOID:000000003508020

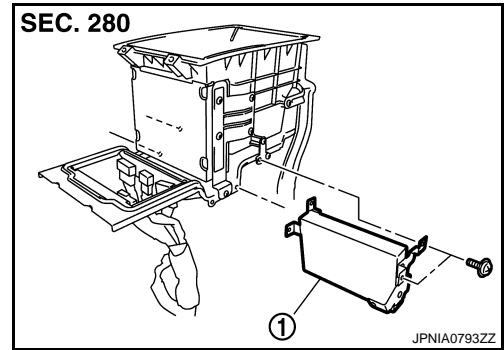

1. Video distributor

Removal and Installation

INFOID:000000003508021

REMOVAL

1. Remove lower console finisher LH and lower console finisher RH. Refer to [IP-19, "Exploded View"](#).
2. Disconnect video distributor connector, remove video distributor screws and remove the video distributor.

INSTALLATION

Install in the reverse order of removal.

A
B
C
D
E
F
G
H
I
J
K
L
M
O
P

AV

DVD PLAYER

< ON-VEHICLE REPAIR >

[BOSE AUDIO WITHOUT NAVIGATION]

DVD PLAYER

Exploded View

INFOID:000000003508022

REMOVAL

Refer to [IP-19, "Exploded View"](#).

DISASSEMBLY

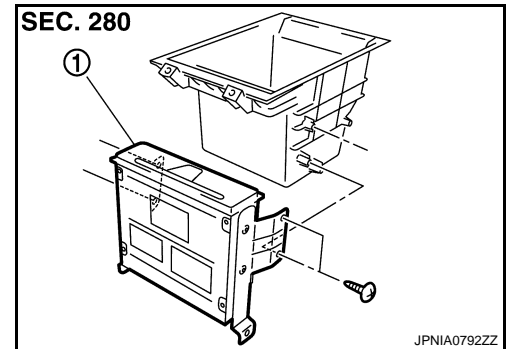

1. DVD player

Removal and Installation

INFOID:000000003508023

REMOVAL

1. Remove center console assembly. Refer to [IP-19, "Exploded View"](#).
2. Disconnect DVD player connector, remove DVD player screws and remove the DVD player.

INSTALLATION

Install in the reverse order of removal.

FRONT DOOR SPEAKER

< ON-VEHICLE REPAIR >

[BOSE AUDIO WITHOUT NAVIGATION]

FRONT DOOR SPEAKER

Exploded View

INFOID:000000003507984

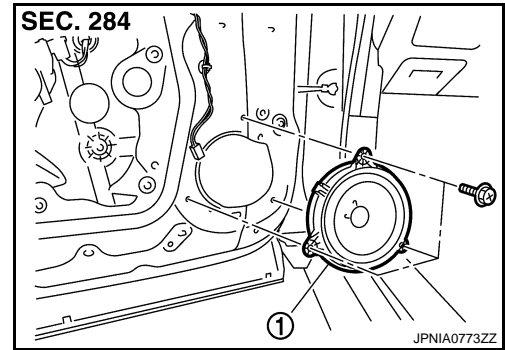

1. Front door speaker

Removal and Installation

INFOID:000000003507985

REMOVAL

1. Remove front door finisher. Refer to [INT-11, "FRONT DOOR FINISHER : Exploded View"](#).
2. Remove front door speaker screws, then disconnect front door speaker connector and remove front door speaker.

INSTALLATION

Install in the reverse order of removal.

A
B
C
D
E
F
G
H
I
J
K
L
M
O
P

AV

REAR DOOR SPEAKER

< ON-VEHICLE REPAIR >

[BOSE AUDIO WITHOUT NAVIGATION]

REAR DOOR SPEAKER

Exploded View

INFOID:000000003507986

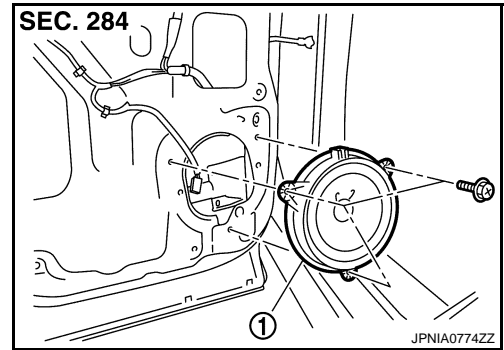

1. Rear door speaker

Removal and Installation

INFOID:000000003507987

REMOVAL

1. Remove rear door finisher. Refer to [INT-15. "REAR DOOR FINISHER : Exploded View"](#).
2. Remove rear door speaker screws, then disconnect rear door speaker connector and remove rear door speaker.

INSTALLATION

Install in the reverse order of removal.

FRONT SQUAWKER

[BOSE AUDIO WITHOUT NAVIGATION]

< ON-VEHICLE REPAIR >

FRONT SQUAWKER

Exploded View

INFOID:000000003507988

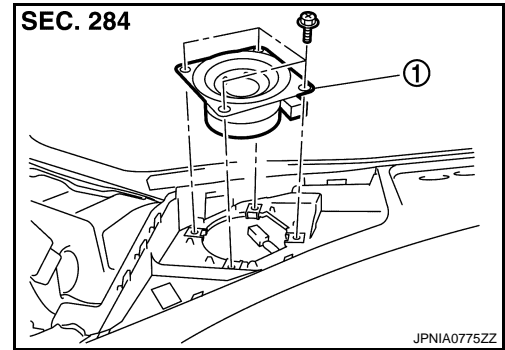

1. Front squawker

Removal and Installation

INFOID:000000003507989

REMOVAL

1. Remove speaker grille. Refer to [JP-11, "Exploded View"](#).
2. Remove front squawker screws, lift up the front squawker and disconnect front squawker connector. Then remove the front squawker.

INSTALLATION

Install in the reverse order of removal.

A
B
C
D
E
F
G
H
I
J
K
L
M
AV
O
P

AV

REAR SPEAKER

[BOSE AUDIO WITHOUT NAVIGATION]

< ON-VEHICLE REPAIR >

REAR SPEAKER

Exploded View

INFOID:000000003507990

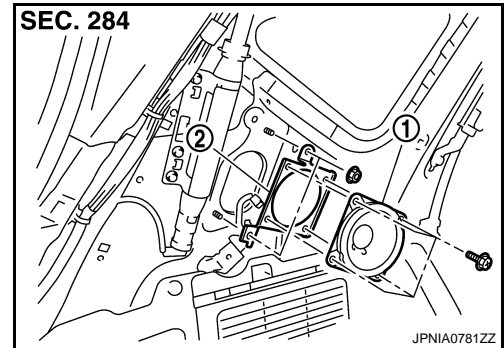

1. Rear speaker
2. Rear speaker bracket

Removal and Installation

INFOID:000000003507991

REMOVAL

1. Remove luggage side finisher upper. Refer to [INT-33, "Exploded View"](#).
2. Remove rear speaker screws, lift up the rear speaker and disconnect rear speaker connector. Then remove the rear speaker.

INSTALLATION

Install in the reverse order of removal.

CENTER SPEAKER

< ON-VEHICLE REPAIR >

[BOSE AUDIO WITHOUT NAVIGATION]

CENTER SPEAKER

Exploded View

INFOID:000000003507993

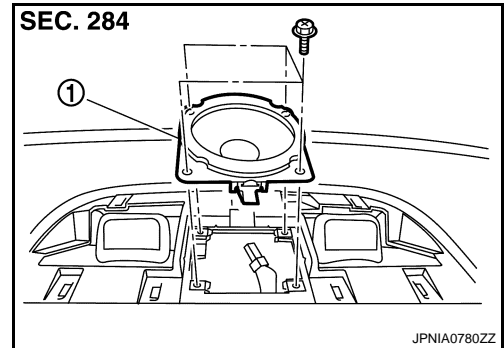

1. Center speaker

Removal and Installation

INFOID:000000003507994

REMOVAL

1. Remove center speaker grille. Refer to [JP-11, "Exploded View"](#).
2. Remove center speaker screws, lift up the center speaker and disconnect center speaker connector. Then remove the center speaker.

INSTALLATION

Install in the reverse order of removal.

A
B
C
D
E
F
G
H
I
J
K
L
M
O
P

AV

WOOFER

< ON-VEHICLE REPAIR >

[BOSE AUDIO WITHOUT NAVIGATION]

WOOFER

Exploded View

INFOID:000000003507997

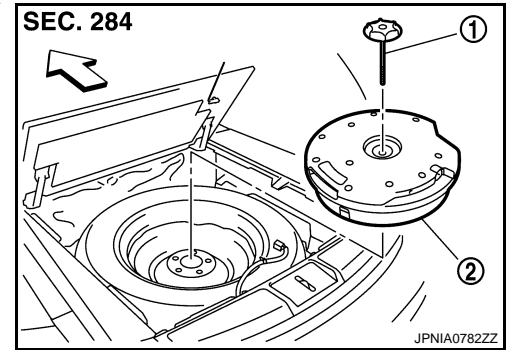

← Vehicle front

1. Clamp

2. Woofer

Removal and Installation

INFOID:000000003507998

REMOVAL

1. Remove luggage floor finisher center (back). Refer to [INT-33. "Exploded View"](#).
2. Remove clamp, disconnect woofer connector and remove the woofer.

INSTALLATION

Install in the reverse order of removal.

BOSE AMP.

< ON-VEHICLE REPAIR >

[BOSE AUDIO WITHOUT NAVIGATION]

BOSE AMP.

Exploded View

INFOID:000000003507999

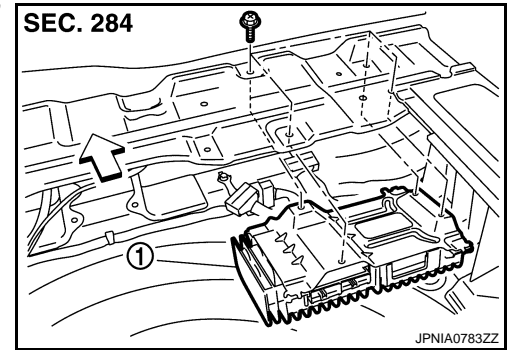

- ← Vehicle front
1. BOSE amp.

Removal and Installation

INFOID:000000003508000

REMOVAL

1. Remove luggage floor finisher. Refer to [INT-33, "Exploded View"](#).
2. Remove BOSE amp. screws, disconnect BOSE amp. connector and remove the BOSE amp.

INSTALLATION

Install in the reverse order of removal.

A
B
C
D
E
F
G
H
I
J
K
L
M
AV
O
P

MULTIFUNCTION SWITCH

< ON-VEHICLE REPAIR >

[BOSE AUDIO WITHOUT NAVIGATION]

MULTIFUNCTION SWITCH

Exploded View

INFOID:000000003508002

REMOVAL

Refer to [IP-11, "Exploded View"](#).

DISASSEMBLY

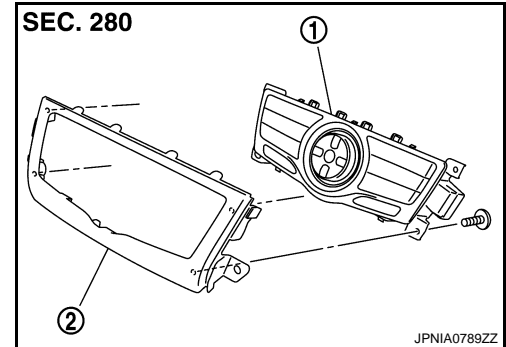

1. Multifunction switch
2. Cluster lid D

Removal and Installation

INFOID:000000003508003

REMOVAL

1. Remove cluster lid D. Refer to [IP-11, "Exploded View"](#).
2. Remove multifunction switch with center ventilator grille as a single unit.
3. Remove multifunction switch screws, remove multifunction switch from cluster lid D.

INSTALLATION

Install in the reverse order of removal.

PRESET SWITCH

< ON-VEHICLE REPAIR >

[BOSE AUDIO WITHOUT NAVIGATION]

PRESET SWITCH

Exploded View

INFOID:000000003508004

REMOVAL

Refer to [IP-11, "Exploded View"](#).

DISASSEMBLY

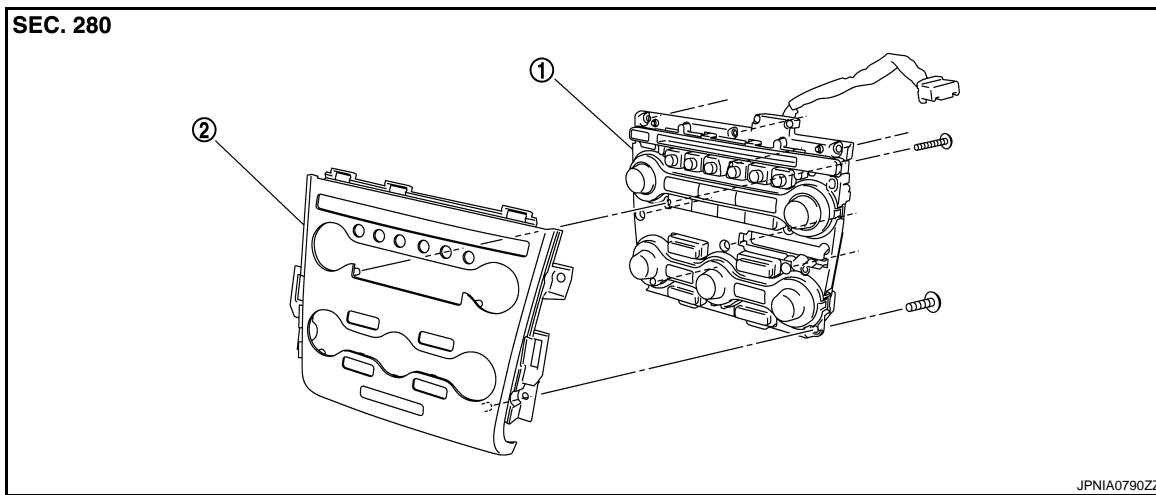

1. Preset switch

2. Cluster lid C

Removal and Installation

INFOID:000000003508005

REMOVAL

1. Remove cluster lid C. Refer to [IP-11, "Exploded View"](#).
2. Remove preset switch screws (A),(B), remove preset switch (1) from cluster lid C.

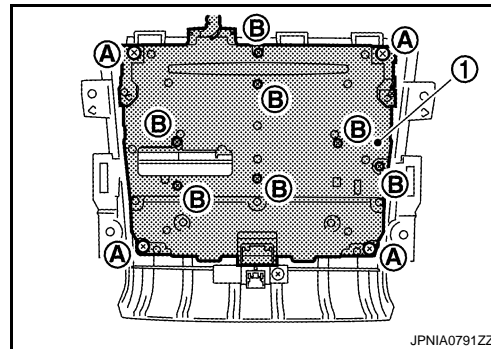

INSTALLATION

Install in the reverse order of removal.

A
B
C
D
E
F
G
H
I
J
K
L
M
AV
O
P

STEERING SWITCH

< ON-VEHICLE REPAIR >

[BOSE AUDIO WITHOUT NAVIGATION]

STEERING SWITCH

Exploded View

INFOID:000000003508007

Refer to [ST-15. "Exploded View"](#).

Removal and Installation

INFOID:000000003508008

REMOVAL

Refer to [ST-15. "Removal and Installation"](#).

INSTALLATION

Install in the reverse order of removal.

IPOD ADAPTER

< ON-VEHICLE REPAIR >

[BOSE AUDIO WITHOUT NAVIGATION]

IPOD ADAPTER

Exploded View

INFOID:000000003508009

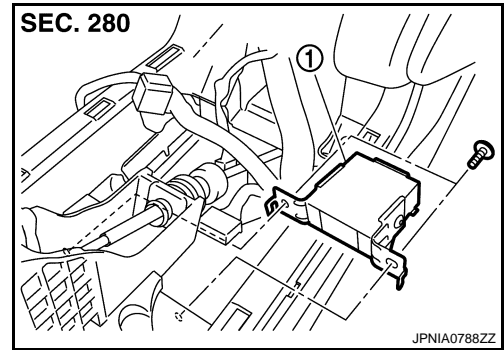

1. iPod adapter

Removal and Installation

INFOID:000000003508010

REMOVAL

1. Remove front console pocket assembly. Refer to [IP-19. "Exploded View"](#).
2. Disconnect iPod adapter connector, remove iPod adapter screws and remove the iPod adapter.

INSTALLATION

Install in the reverse order of removal.

A
B
C
D
E
F
G
H
I
J
K
L
M
O
P

AV

IPOD CONNECTOR

[BOSE AUDIO WITHOUT NAVIGATION]

< ON-VEHICLE REPAIR >

IPOD CONNECTOR

Exploded View

INFOID:000000003508011

REMOVAL

Refer to [IP-19, "Exploded View"](#).

DISASSEMBLY

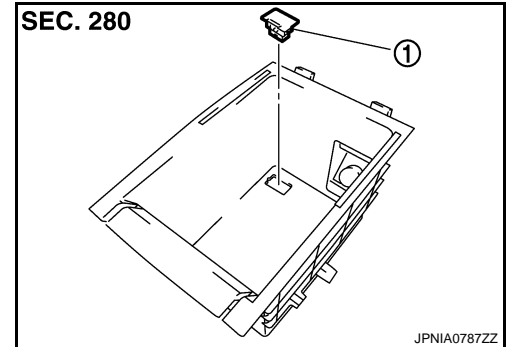

1. iPod connector

Removal and Installation

INFOID:000000003508012

REMOVAL

1. Remove center console. Refer to [IP-19, "Exploded View"](#).
2. Press the pawl from the back of center console to remove iPod connector.

INSTALLATION

Install in the reverse order of removal.

AUXILIARY INPUT JACKS

[BOSE AUDIO WITHOUT NAVIGATION]

< ON-VEHICLE REPAIR >

AUXILIARY INPUT JACKS

Exploded View

INFOID:000000003508013

REMOVAL

Refer to [IP-19, "Exploded View"](#).

DISASSEMBLY

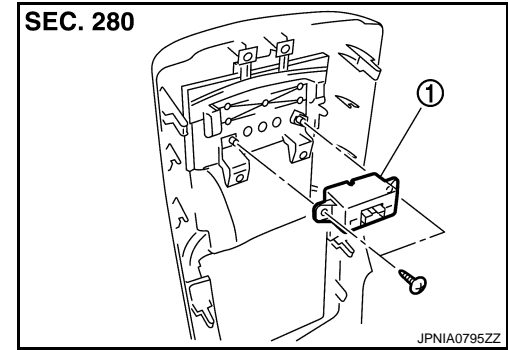

1. Auxiliary input jacks

Removal and Installation

INFOID:000000003508014

REMOVAL

1. Remove console rear finisher. Refer to [IP-19, "Exploded View"](#).
2. Remove auxiliary input jacks from center console.

INSTALLATION

Install in the reverse order of removal.

A
B
C
D
E
F
G
H
I
J
K
L
M
AV
O
P

AV

MICROPHONE

< ON-VEHICLE REPAIR >

[BOSE AUDIO WITHOUT NAVIGATION]

MICROPHONE

Exploded View

INFOID:000000003508015

REMOVAL

Refer to [INL-115, "Exploded View"](#).

DISASSEMBLY

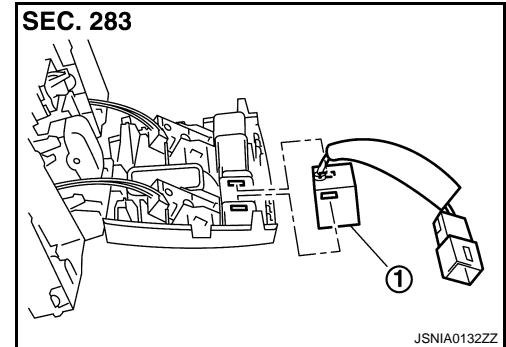

1. Microphone

Removal and Installation

INFOID:000000003508016

REMOVAL

1. Remove map lamp. Refer to [INL-115, "Exploded View"](#).
2. Remove microphone from map lamp.

INSTALLATION

Install in the reverse order of removal.

CAMERA CONTROL UNIT

< ON-VEHICLE REPAIR >

[BOSE AUDIO WITHOUT NAVIGATION]

CAMERA CONTROL UNIT

Exploded View

INFOID:000000003566819

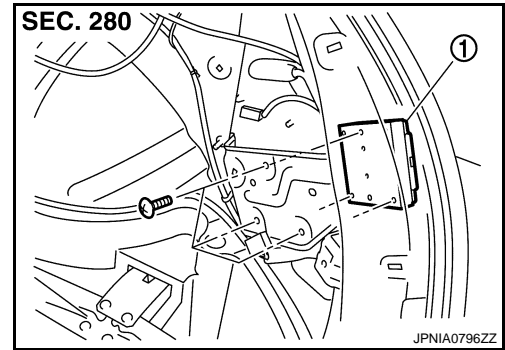

1. Camera control unit

Removal and Installation

INFOID:000000003566820

REMOVAL

1. Remove luggage side finisher lower (RH). Refer to [INT-33, "Exploded View"](#).
2. Remove camera control unit screws, disconnect camera control unit connector and remove the camera control unit.

INSTALLATION

Install in the reverse order of removal.

Adjustment

INFOID:000000003566821

ADJUSTMENT

There may be a misalignment of possible route line center position of rear view monitor after removing camera control unit. Therefore, correct neutral position with the following procedure.

1. Steer the steering wheel to the leftmost and rightmost ends.
2. Drive vehicle at 30 km/h (18.6 MPH) min. speed at least 100 m (328.1 ft).

A
B
C
D
E
F
G
H
I
J
K
L
M
O
P

AV

REAR VIEW CAMERA

[BOSE AUDIO WITHOUT NAVIGATION]

< ON-VEHICLE REPAIR >

REAR VIEW CAMERA

Exploded View

INFOID:000000003566822

REMOVAL

Refer to [INT-37. "Exploded View"](#).

DISASSEMBLY

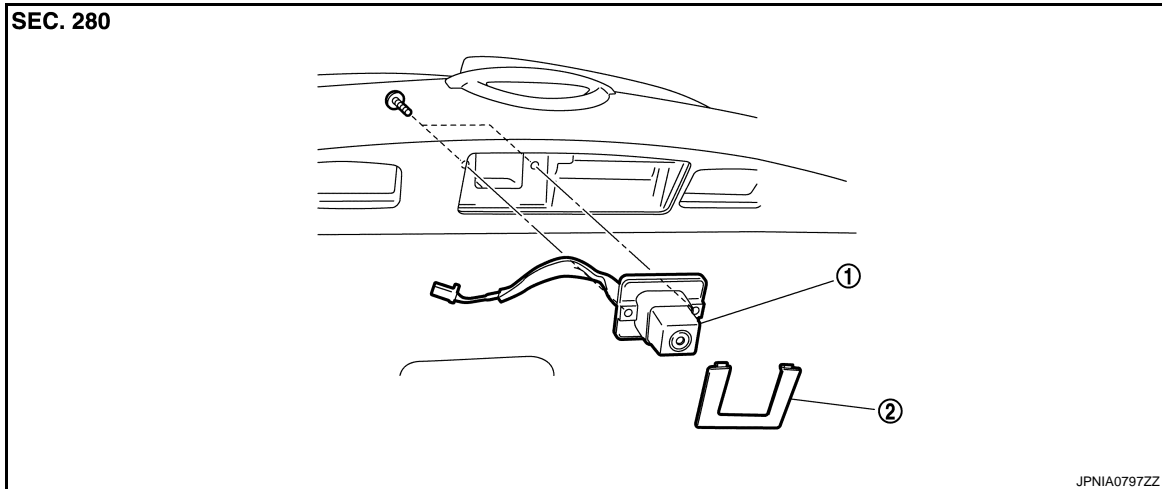

1. Rear view camera

2. Finisher

Removal and Installation

INFOID:000000003566823

REMOVAL

1. Remove back door finisher inner. Refer to [INT-37. "Exploded View"](#).
2. Remove finisher.
3. Remove rear view camera screws, disconnect rear view camera connector and remove rear view camera from back door assembly.

INSTALLATION

Install in the reverse order of removal.

Adjustment

INFOID:000000003566824

Adjust the guide line position if the guide line position is shifted after installing the rear view camera.

REAR VIEW CAMERA

[BOSE AUDIO WITHOUT NAVIGATION]

< ON-VEHICLE REPAIR >

1. Draw lines on rearward area of the vehicle passing through the following points: 200 mm (7.87 in) from both sides of the vehicle, and 0.5 m (1.64 ft), 1.0 m (3.28 ft) from the rear end of the bumper.
2. Set into "Adjust offset of rear view camera" mode of Confirmation / Adjustment mode.

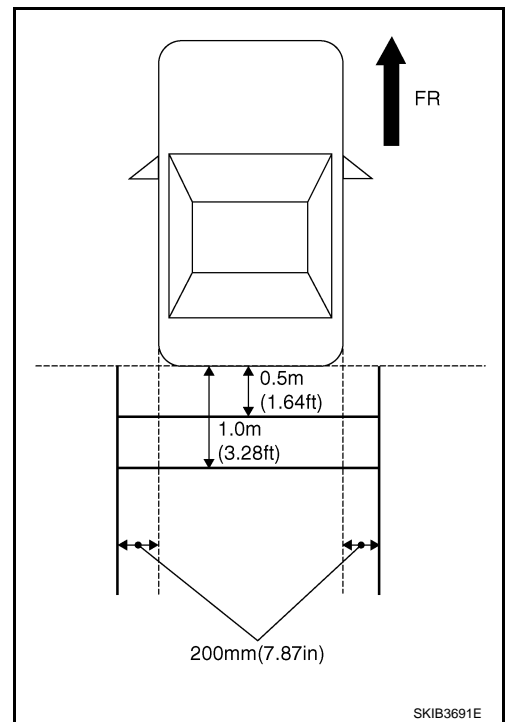

3. Rotate the center dial, and then select the guiding line pattern so that its angle is aligned with the correction line of the rear of the vehicle.

Selected pattern : 7

4. Make fine adjustment to the correction line of the rear of the vehicle with up/down/left/right switches so that its position is aligned with the guiding line. Press "OK" switch and record the adjusted guiding line position to the camera control unit.

Up/Down adjustment range : -20 - 20

Left/Right adjustment range : -20 - 20

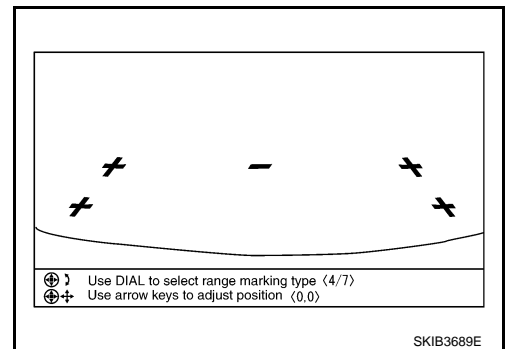

CAUTION:

Never operate other function such as pressing BACK while writing index data.

If Confirmation/Adjustment mode does not function in the above procedure, perform one of the following service to adjust the index again.

- Remove battery for five min. Then reconnect battery.
- Remove camera control unit connector for five min. Then reconnect camera control unit connector.

A
B
C
D
E
F
G
H
I
J
K
L
M
O
P

AV

STEERING ANGLE SENSOR

[BOSE AUDIO WITHOUT NAVIGATION]

< ON-VEHICLE REPAIR >

STEERING ANGLE SENSOR

Exploded View

INFOID:000000003566825

REMOVAL

Refer to [ST-15. "Exploded View"](#).

DISASSEMBLY

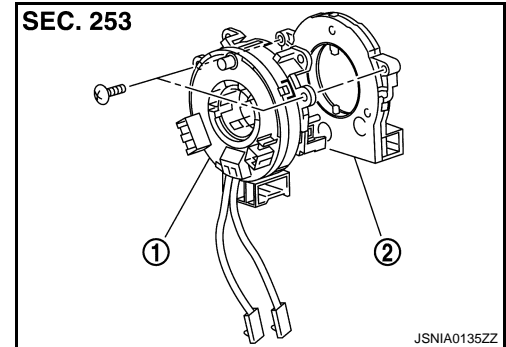

1. Spiral cable
2. Steering angle sensor

Removal and Installation

INFOID:000000003566826

REMOVAL

1. Remove spiral cable.
2. Remove steering angle sensor from spiral cable.

INSTALLATION

Install in the reverse order of removal.

ROOF ANTENNA

< ON-VEHICLE REPAIR >

[BOSE AUDIO WITHOUT NAVIGATION]

ROOF ANTENNA

Exploded View

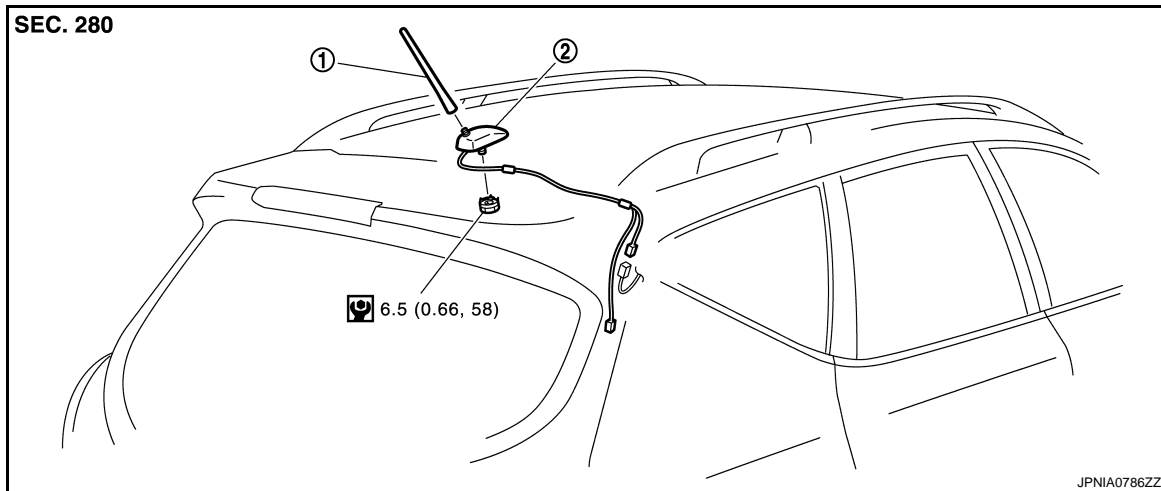

INFOID:000000003508017

1. Rod antenna

2. Antenna base & satellite radio antenna

Refer to [GI-4, "Components"](#) for symbols in the figure.

Removal and Installation

INFOID:000000003508018

REMOVAL

1. Remove headlining assembly (rear) to secure work space between vehicle and headlining. Refer to [INT-25, "NORMAL ROOF : Exploded View"](#) [without sunroof] or [INT-29, "SUNROOF : Exploded View"](#) [with sunroof].
2. Disconnect AM/FM main connector and satellite radio antenna connector.
3. Remove antenna base & satellite radio nut, and then remove antenna base & satellite radio antenna from roof panel.

INSTALLATION

Install in the reverse order of removal.

Antenna base & satellite radio antenna mounting nut

: 6.5 N·m (0.66 kg-m, 58 in-lb)

CAUTION:

When Antenna base & satellite radio antenna mounting nut tightening torque is loose, be careful about tightening torque. Antenna sensitivity becomes poor, and when it is excessive, roof panel may become deformed.

A
B
C
D
E
F
G
H
I
J
K
L
M
O
P

AV

SATELLITE RADIO TUNER

< ON-VEHICLE REPAIR >

[BOSE AUDIO WITHOUT NAVIGATION]

SATELLITE RADIO TUNER

Exploded View

INFOID:000000003356870

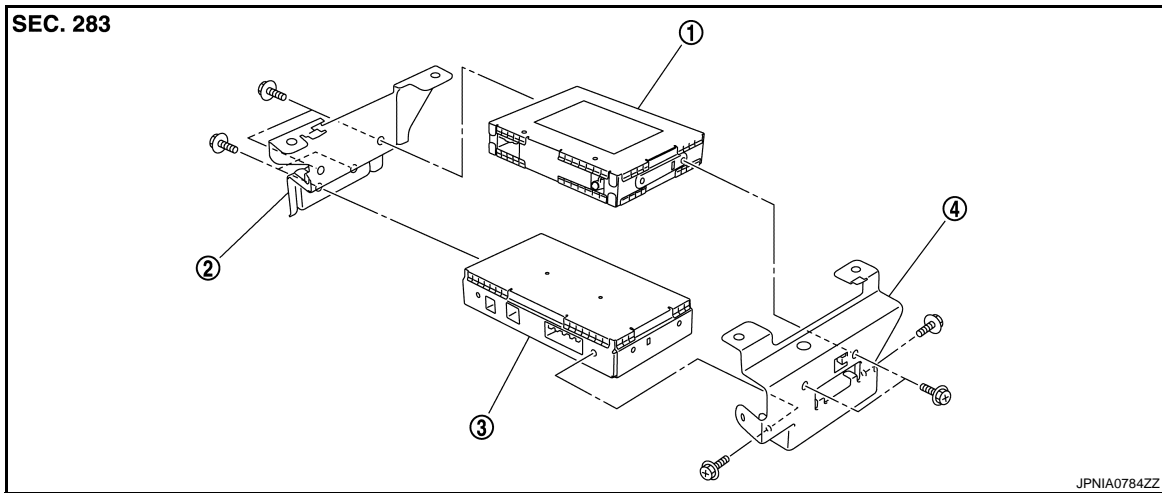

1. Satellite radio tuner

2. Bracket LH

3. TEL adapter unit

4. Bracket RH

Removal and Installation

INFOID:000000003356871

REMOVAL

1. Remove luggage floor finisher front. Refer to [INT-33, "Exploded View"](#).
2. Remove satellite radio tuner (1) with TEL adapter unit as a single unit from the body.

← Vehicle front

3. Remove bracket screws, and then remove satellite tuner.

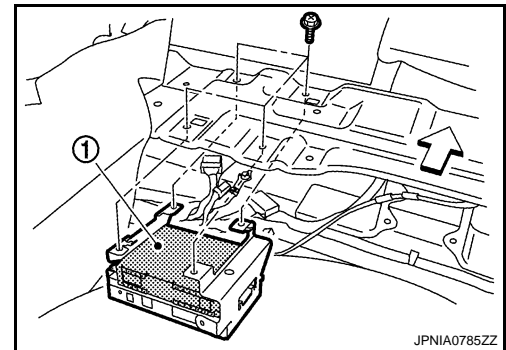

INSTALLATION

Install in the reverse order of removal.

TEL ADAPTER UNIT

< ON-VEHICLE REPAIR >

[BOSE AUDIO WITHOUT NAVIGATION]

TEL ADAPTER UNIT

Exploded View

INFOID:000000003356888

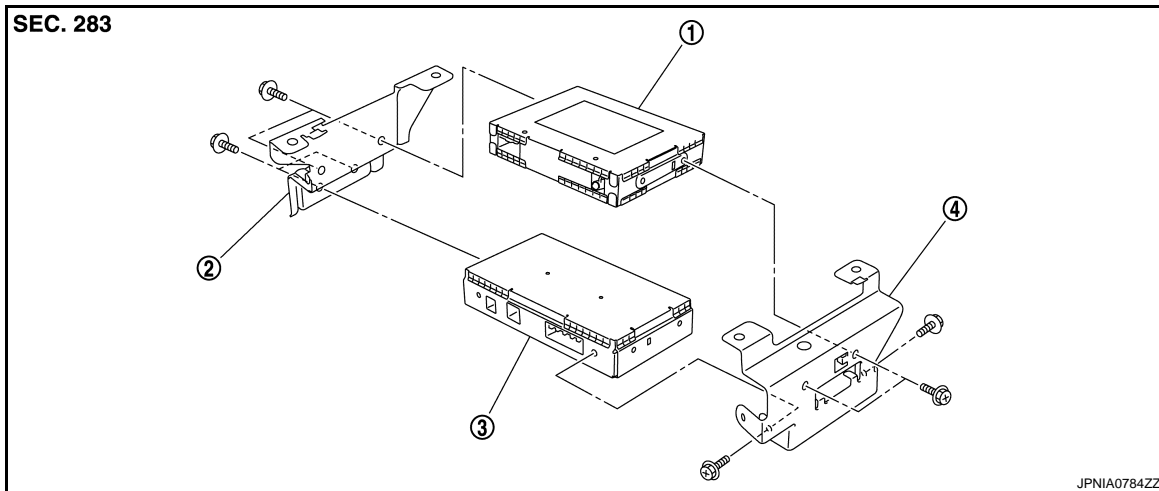

1. Satellite radio tuner

2. Bracket LH

3. TEL adapter unit

4. Bracket RH

Removal and Installation

INFOID:000000003356889

REMOVAL

1. Remove luggage floor finisher front. Refer to [INT-33, "Exploded View"](#).
2. Remove TEL adapter unit (1) with satellite radio tuner as a single unit from the body.
3. Remove bracket screws, and then remove TEL adapter unit.

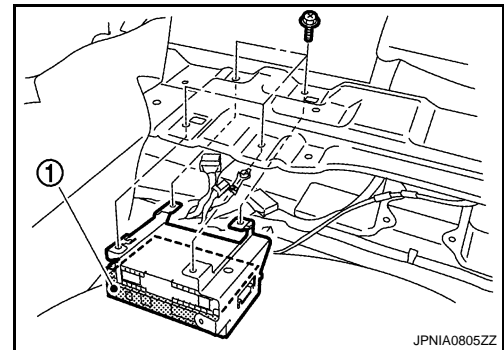

INSTALLATION

Install in the reverse order of removal.

A

B

C

D

E

F

G

H

I

J

K

L

M

AV

O

P

ANTENNA FEEDER (RADIO)

< ON-VEHICLE REPAIR >

[BOSE AUDIO WITHOUT NAVIGATION]

ANTENNA FEEDER (RADIO)

Harness Layout

INFOID:000000003356890

SEC. 280

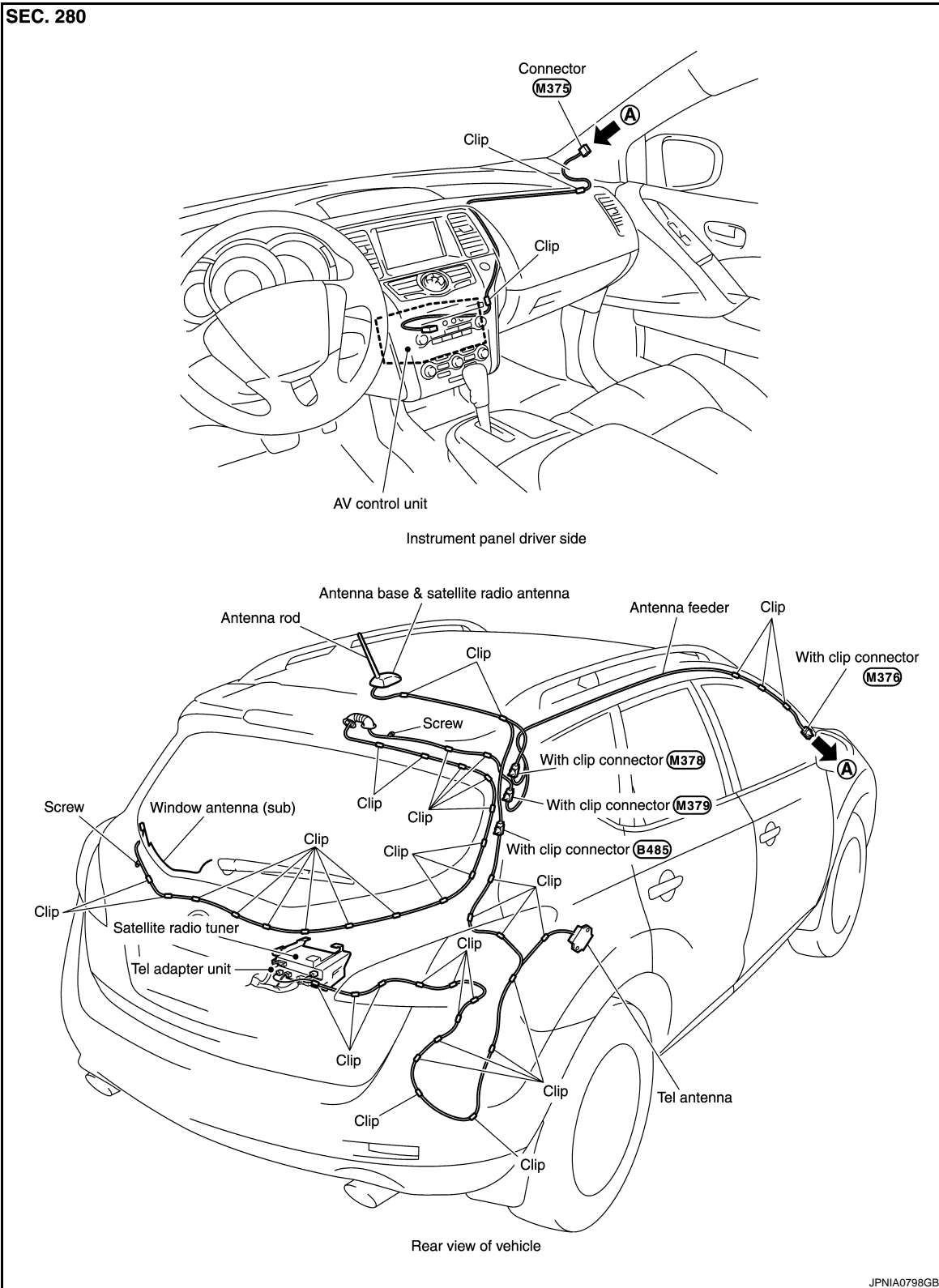

JPNIA0798GB

ANTENNA FEEDER (SATELLITE RADIO)

< ON-VEHICLE REPAIR >

[BOSE AUDIO WITHOUT NAVIGATION]

ANTENNA FEEDER (SATELLITE RADIO)

Harness Layout

INFOID:000000003508994

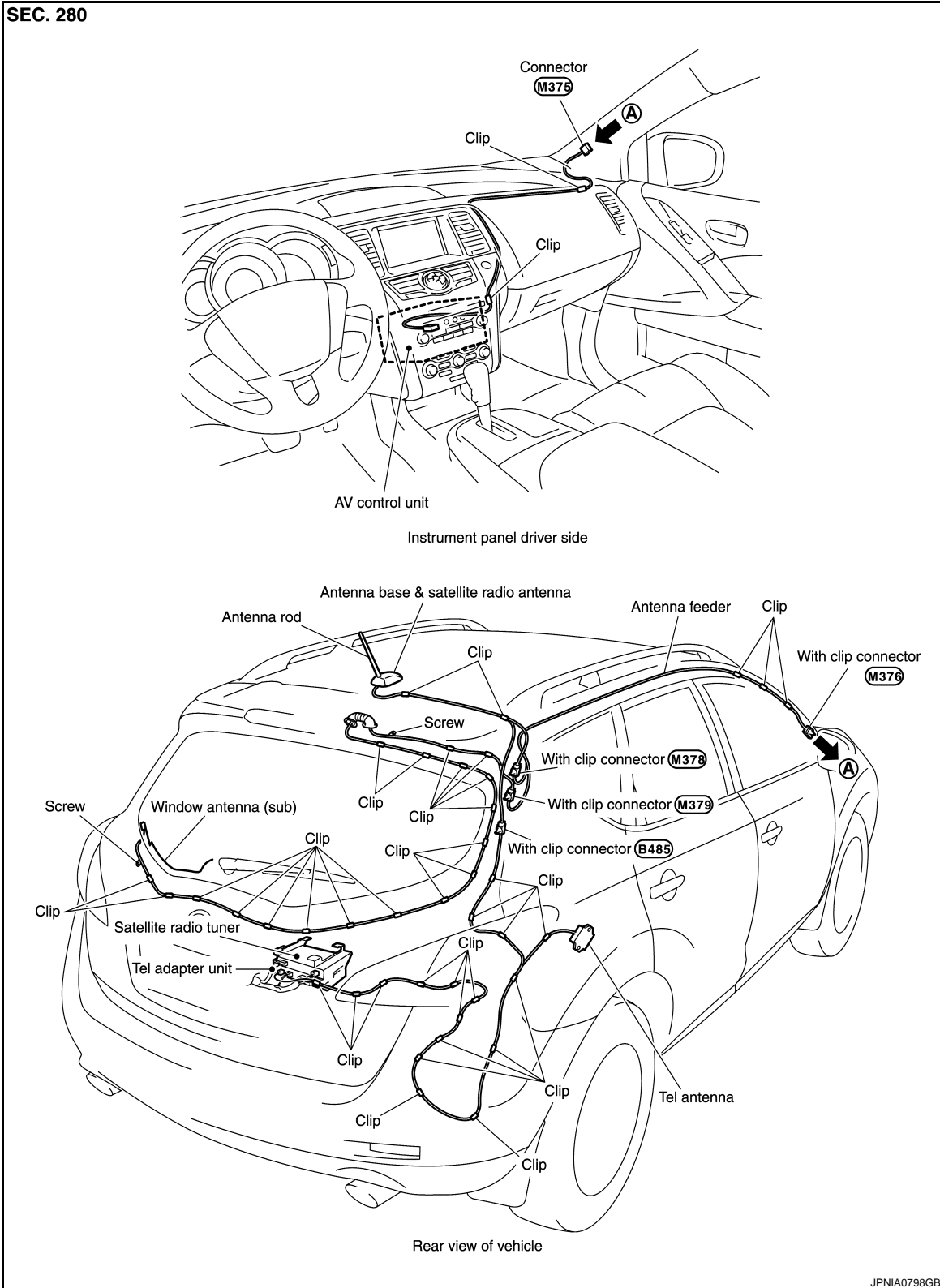

A
B
C
D
E
F
G
H
I
J
K
L
M
N
O
P

AV

ANTENNA FEEDER (TEL)

[BOSE AUDIO WITHOUT NAVIGATION]

< ON-VEHICLE REPAIR >

ANTENNA FEEDER (TEL)

Harness Layout

INFOID:000000003508995

SEC. 280

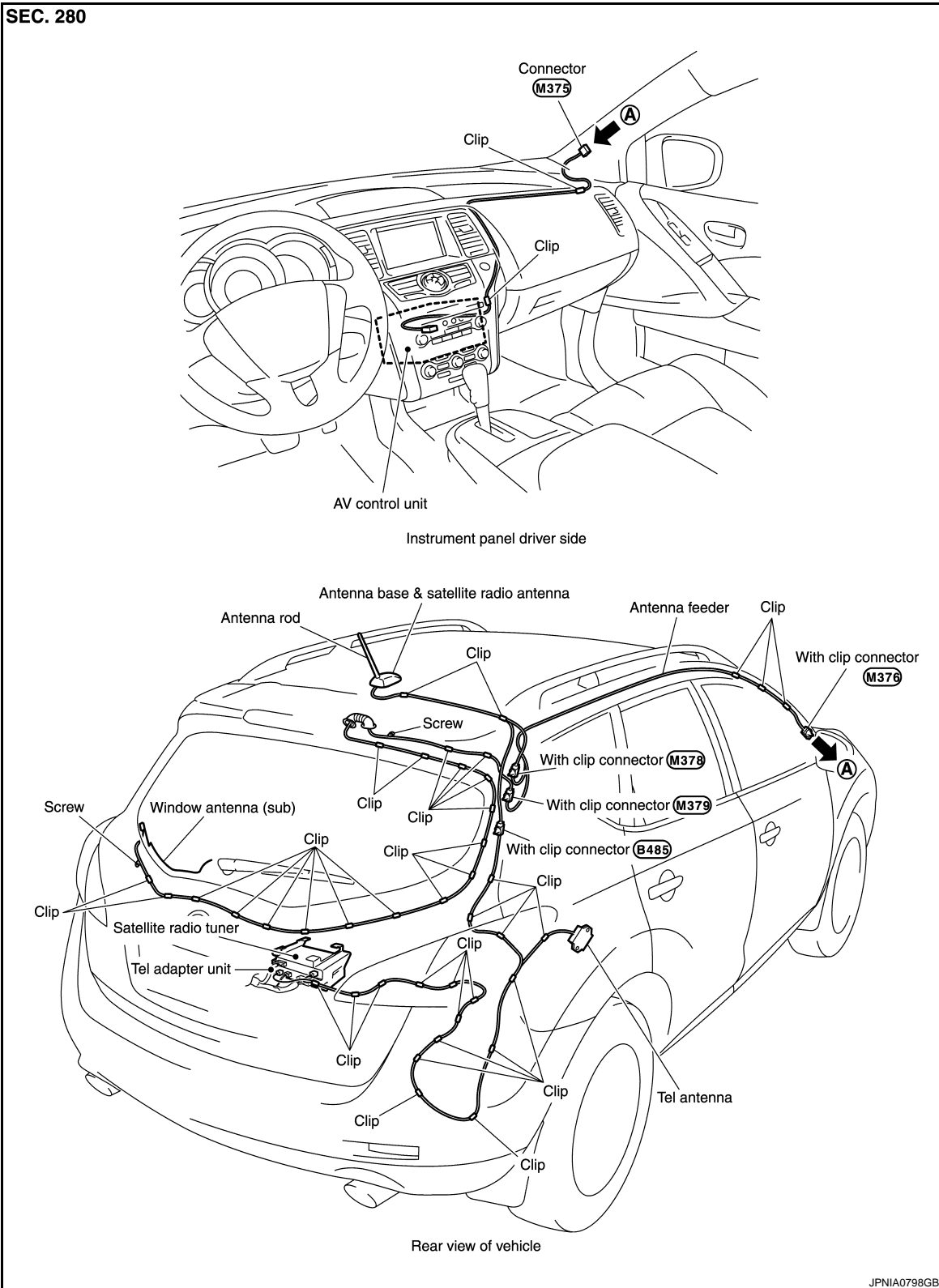

JPNIA0798GB

BASIC INSPECTION

DIAGNOSIS AND REPAIR WORK FLOW

Work Flow

INFOID:000000003356541

OVERALL SEQUENCE

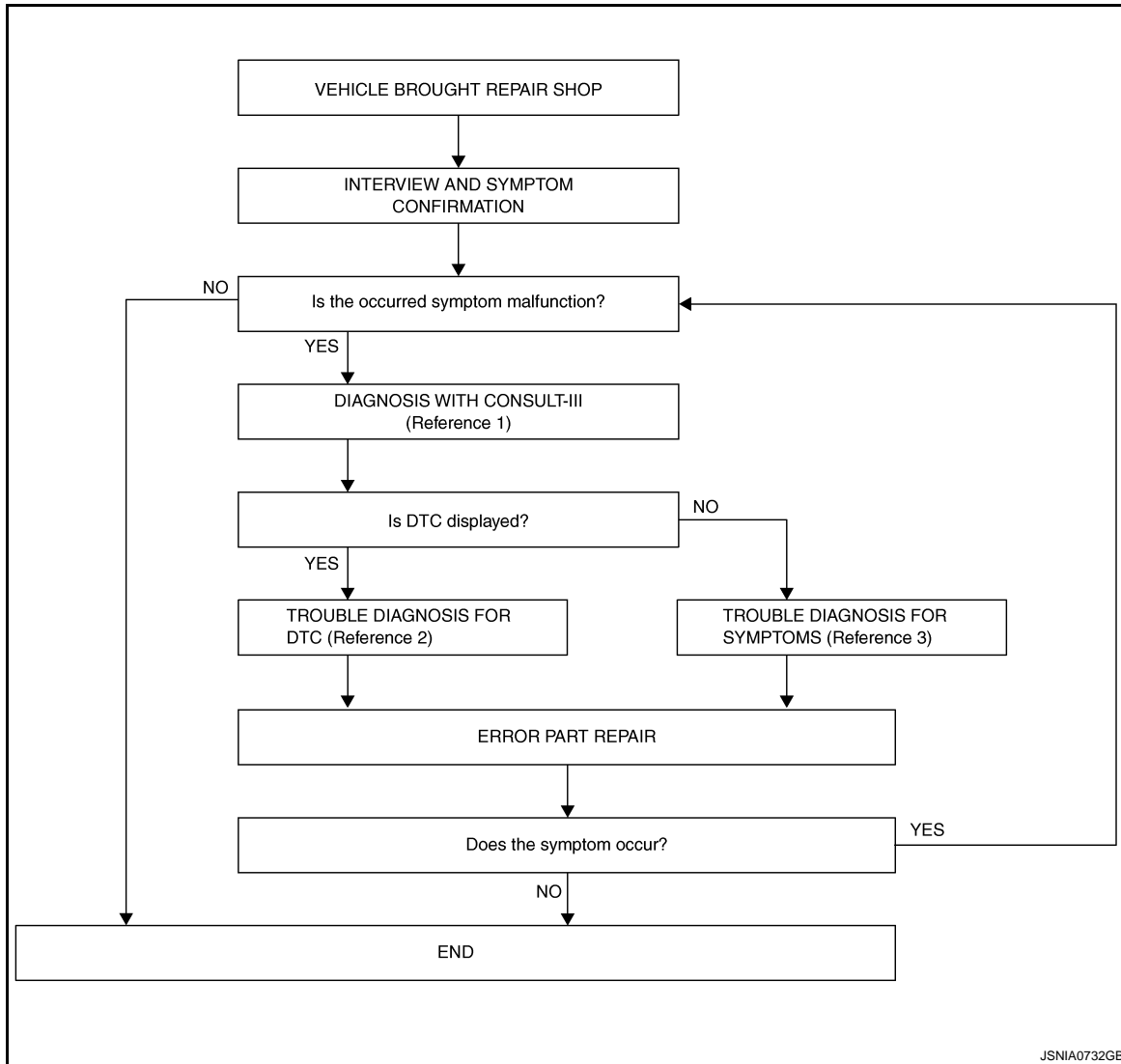

- Reference 1... Refer to [AV-589. "CONSULT-III Function \(MULTI AV\)".](#)
- Reference 2... Refer to [AV-670. "DTC Index".](#)
- Reference 3... Refer to [AV-751. "Symptom Table".](#)

DETAILED FLOW

1. INTERVIEW AND SYMPTOM CONFIRMATION

Check the malfunction symptoms by performing the following items.

- Interview the customer to obtain the malfunction information (conditions and environment when the malfunction occurred).
- Check the symptom.

Is the occurring symptom a malfunction?

YES >> GO TO 2.

NO >> INSPECTION END

2. DIAGNOSIS WITH CONSULT-III

DIAGNOSIS AND REPAIR WORK FLOW

[BOSE AUDIO WITH NAVIGATION]

< BASIC INSPECTION >

1. Connect CONSULT-III and perform a self-diagnosis for "MULTI AV". Refer to [AV-589, "CONSULT-III Function \(MULTI AV\)"](#).

NOTE:

Skip to step 4 of the diagnosis procedure if "MULTI AV" is not displayed.

2. Check if any DTC is displayed in the self-diagnosis results.

Is DTC displayed?

YES >> GO TO 3.

NO >> GO TO 4.

3. TROUBLE DIAGNOSIS FOR DTC

1. Check the DTC indicated in the self-diagnosis results.
2. Perform the relevant diagnosis referring to the DTC Index. Refer to [AV-670, "DTC Index"](#).

>> GO TO 5.

4. TROUBLE DIAGNOSIS FOR SYMPTOMS

Perform the relevant diagnosis referring to the diagnosis chart by symptom. Refer to [AV-751, "Symptom Table"](#).

>> GO TO 5.

5. ERROR PART REPAIR

1. Repair or replace the identified malfunctioning parts.
2. Perform a self-diagnosis for "MULTI AV" with CONSULT-III.

NOTE:

Erase the stored self-diagnosis results after repairing or replacing the relevant components if any DTC has been indicated in the self-diagnosis results.

3. Check that the symptom does not occur.

Does the symptom occur?

YES >> GO TO 1.

NO >> INSPECTION END

INSPECTION AND ADJUSTMENT

< BASIC INSPECTION >

[BOSE AUDIO WITH NAVIGATION]

INSPECTION AND ADJUSTMENT

ADDITIONAL SERVICE WHEN REMOVING BATTERY NEGATIVE TERMINAL

ADDITIONAL SERVICE WHEN REMOVING BATTERY NEGATIVE TERMINAL : Description

INFOID:000000003356542

Always correct the center position of the rear view monitor's possible route line after disconnecting the battery negative terminal.

ADDITIONAL SERVICE WHEN REMOVING BATTERY NEGATIVE TERMINAL : Special Repair Requirement

INFOID:000000003356543

1. CORRECTION OF CENTER POSITION OF REAR VIEW MONITOR'S POSSIBLE ROUTE LINE

Refer to the following for details.

>> Refer to [AV-553, "REAR VIEW MONITOR POSSIBLE ROUTE LINE CENTER POSITION ADJUSTMENT : Special Repair Requirement"](#).

ADDITIONAL SERVICE WHEN REPLACING CONTROL UNIT

ADDITIONAL SERVICE WHEN REPLACING CONTROL UNIT : Description

INFOID:000000003356544

When camera control unit is replaced, the center position of rear view monitor possible route line is corrected.

ADDITIONAL SERVICE WHEN REPLACING CONTROL UNIT : Special Repair Requirement

INFOID:000000003356545

1. CORRECTION OF CENTER POSITION OF REAR VIEW MONITOR'S POSSIBLE ROUTE LINE

Refer to the following for details.

>> Refer to [AV-553, "REAR VIEW MONITOR POSSIBLE ROUTE LINE CENTER POSITION ADJUSTMENT : Special Repair Requirement"](#).

REAR VIEW MONITOR POSSIBLE ROUTE LINE CENTER POSITION ADJUSTMENT

REAR VIEW MONITOR POSSIBLE ROUTE LINE CENTER POSITION ADJUSTMENT : Description

INFOID:000000003356546

Adjust the center position of the possible route line of the rear view monitor if it is shifted.

REAR VIEW MONITOR POSSIBLE ROUTE LINE CENTER POSITION ADJUSTMENT : Special Repair Requirement

INFOID:000000003356547

1. STEERING OPERATION

Steer the steering wheel to the leftmost and rightmost positions.

>> GO TO 2

2. DRIVING

Drive the vehicle straight ahead 100 m (328.1 ft) or more at a speed of 30 km/h (18.6 MPH) or more.

>> END

FUNCTION DIAGNOSIS

MULTI AV SYSTEM

System Diagram

INFOID:000000003356548

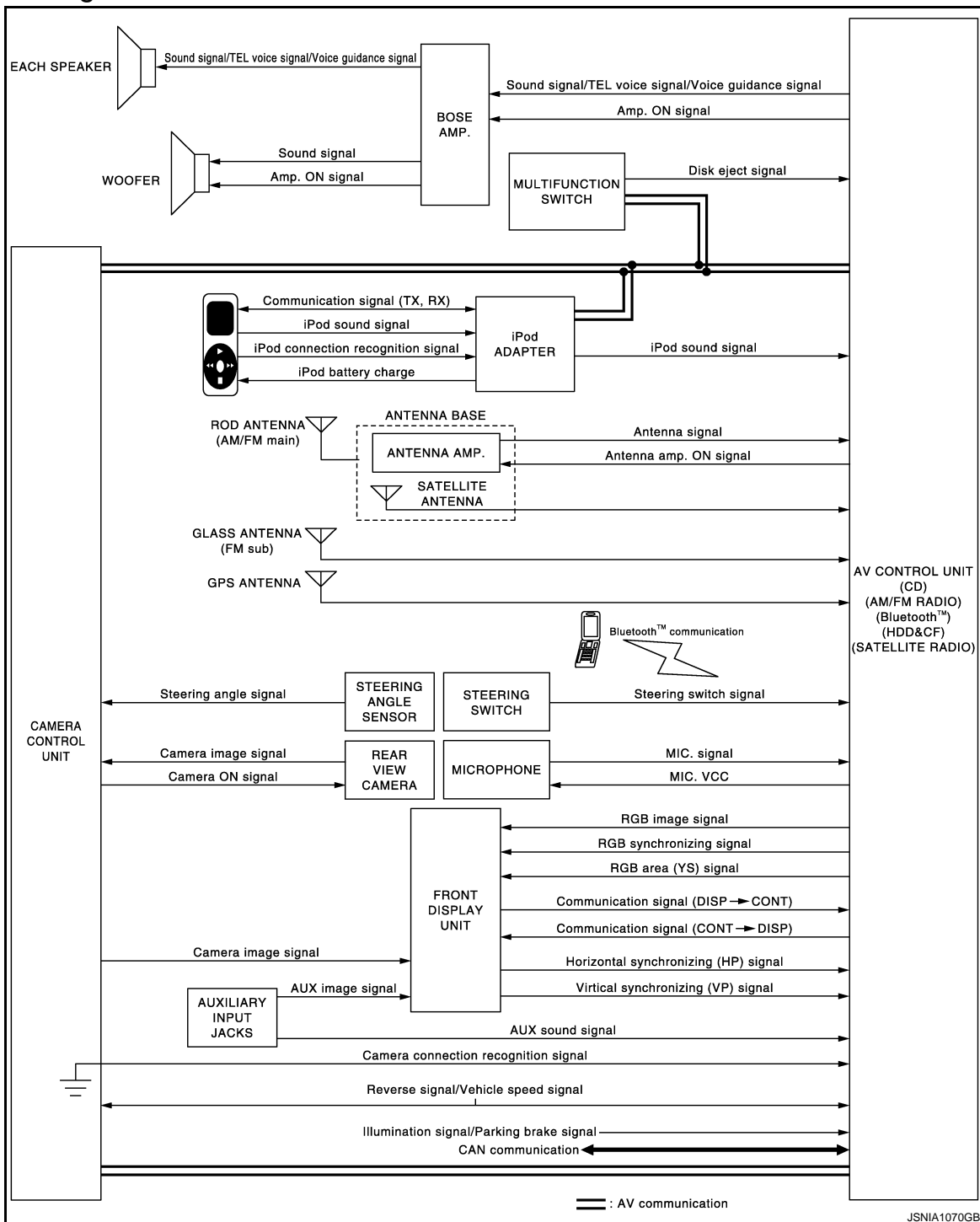

NOTE:

- Woofer, illustrated in the above figure, integrates two woofers and a woofer amp.
- In this section, PRESET SWITCH and MULTIFUNCTION SWITCH are written as the MULTIFUNCTION SWITCH.

MULTI AV SYSTEM

< FUNCTION DIAGNOSIS >

[BOSE AUDIO WITH NAVIGATION]

- An antenna base integrated with radio antenna amp. and satellite radio antenna is adopted.

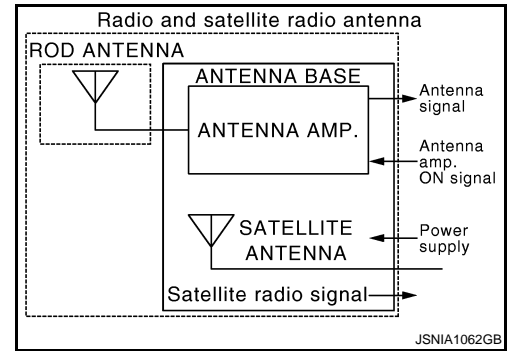

System Description

INFOID:000000003356549

MULTI AV system means that the following systems are integrated.

System name	System explanation
NAVIGATION SYSTEM	AV-560. "System Description"
AUDIO SYSTEM	AV-568. "System Description"
REAR VIEW MONITOR SYSTEM	AV-565. "System Description"
HANDS-FREE PHONE SYSTEM	AV-572. "System Description"
VEHICLE INFORMATION SYSTEM	<ul style="list-style-type: none"> Status of audio, climate control system, fuel economy, maintenance and navigation is displayed. AV control unit displays the fuel consumption status while receiving data signal through CAN communication from ECM and combination meter. AV control unit is connected to BCM via CAN communication transmitting/receiving for the vehicle settings function.
AUXILIARY INPUT SYSTEM	Refer to the following "AUXILIARY INPUT SYSTEM".
VOICE RECOGNITION SYSTEM	Refer to the following "VOICE RECOGNITION SYSTEM".
TOUCH PANEL SYSTEM	Refer to the following "TOUCH PANEL SYSTEM".

- AV control unit function by transmitting/receiving data one by one with each unit (slave unit) that configures them completely as a master unit by connecting between units that configure MULTI AV system with two AV communication lines (H, L).
- Two AV communication lines (H, L) adopt a twisted pair line that is resistant to noise.
- AV control unit is connected by CAN communication, and it receives data signal from ECM, combination meter. It computes and displays fuel economy information value with the obtained information. Transmitting/receiving of data signal is performed by BCM. Also, it transmits the required signal of vehicle setting and receives the response signal.
- AV control unit is connected with front display unit and serial communication, and it transmits the required signal of display and display control and receives the response signal from front display unit.

NOTE:

AV control unit can perform CONSULT-III self-operating function and on board self-diagnosis.

- CONSULT-III self diagnosis: Refer to [AV-589. "CONSULT-III Function \(MULTI AV\)"](#).
- On board self diagnosis: Refer to [AV-575. "Diagnosis Description"](#).

AUXILIARY INPUT SYSTEM

- Image and sound can be output from an external device by connecting a device with auxiliary input jacks.
- Operation can be performed with multifunction switch and steering switch. Multifunction switch transmits operation signal to AV control unit by AV communication.
- The AUX image signal is input from the auxiliary input jacks to the front display unit.

MULTI AV SYSTEM

[BOSE AUDIO WITH NAVIGATION]

< FUNCTION DIAGNOSIS >

- The AUX sound signal is input from the auxiliary input jacks to the AV control unit. The AV control unit outputs the AUX sound signal to the BOSE amp. The BOSE amp. outputs the AUX sound signal to woofer and each speaker.

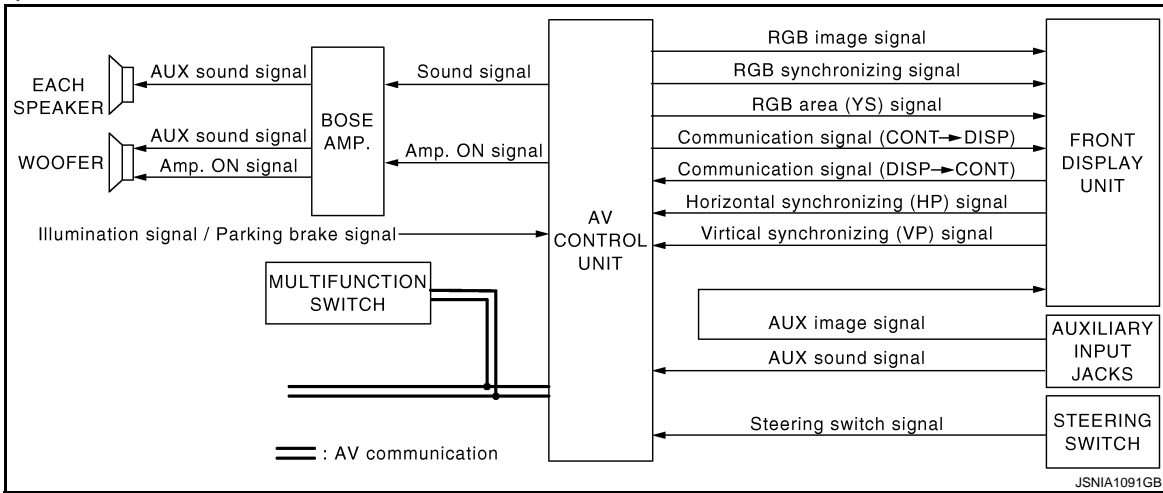

VOICE RECOGNITION SYSTEM

- Each operation of multi AV system can be performed by inputting sound in to a microphone.
- Start of sound recognition system can be performed by steering switch.

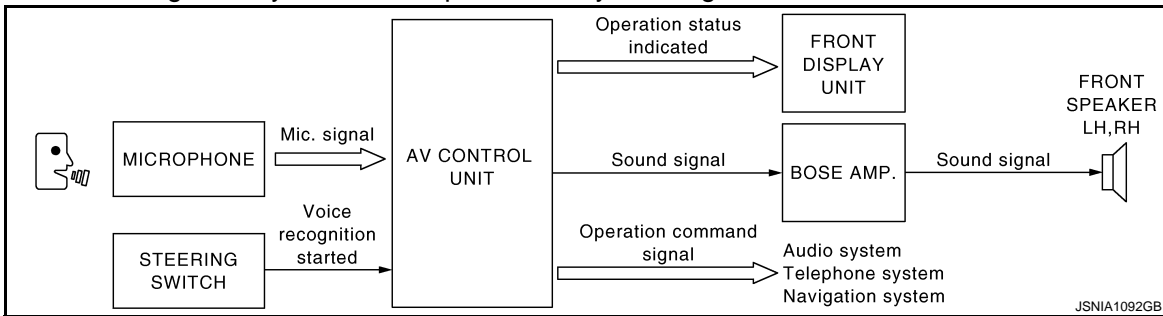

TOUCH PANEL SYSTEM

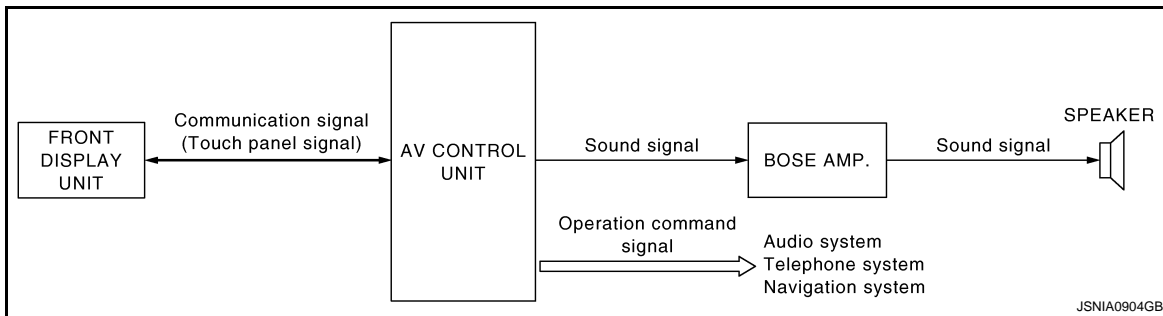

Each operation of multi AV system can be performed by directly touching the appropriate display.

MULTI AV SYSTEM

< FUNCTION DIAGNOSIS >

[BOSE AUDIO WITH NAVIGATION]

Component Parts Location

INFOID:000000003356550

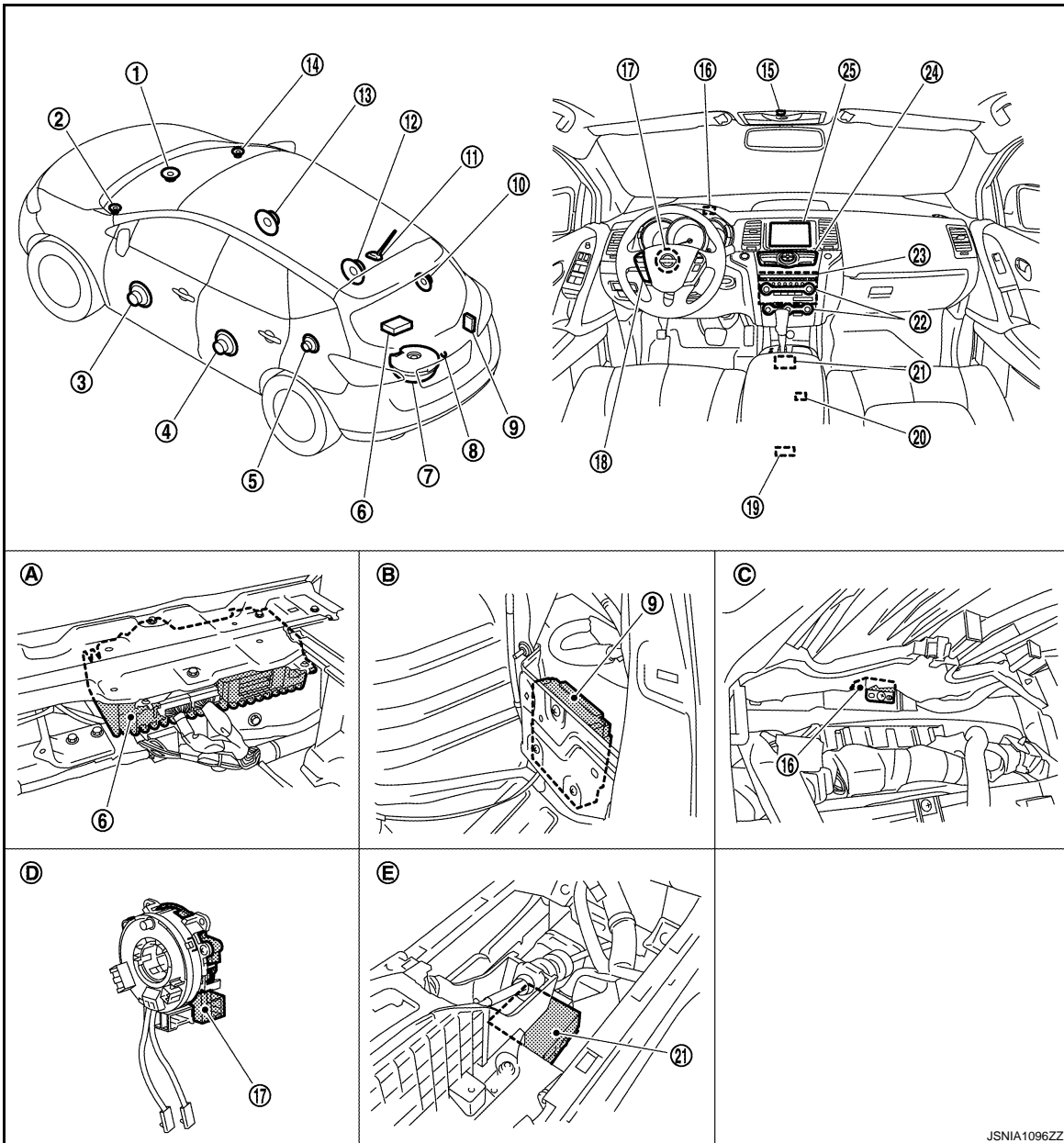

- | | | |
|---------------------------|---|--------------------------|
| 1. Center speaker | 2. Front squawker LH | 3. Front door speaker LH |
| 4. Rear door speaker LH | 5. Rear speaker LH | 6. BOSE amp. |
| 7. Woofer | 8. Rear view camera | 9. Camera control unit |
| 10. Rear speaker RH | 11. Antenna base (antenna amp. and satellite antenna) | 12. Rear door speaker RH |
| 13. Front door speaker RH | 14. Front squawker RH | 15. Microphone |
| 16. GPS antenna | 17. Steering angle sensor | 18. Steering switch |
| 19. Auxiliary input jacks | 20. iPod connector | 21. iPod adapter |
| 22. Preset switch | 23. AV control unit | 24. Multifunction switch |
| 25. Front display unit | | |

A. Luggage floor finisher is removed condition

B. Luggage side finisher lower RH is removed condition

C. Combination meter is removed condition

D. Spiral cable part

E. Console finisher is removed condition

A
B
C
D
E
F
G
H
I
J
K
L
M

AV

O
P

MULTI AV SYSTEM

[BOSE AUDIO WITH NAVIGATION]

< FUNCTION DIAGNOSIS >

Component Description

INFOID:000000003356551

Part name	Description
AV CONTROL UNIT	<ul style="list-style-type: none"> Integrates hard disk drive (HDD) allowing map data and music data to be stored. It is the master unit of the MULTI AV system, and it is connected to each control unit by communication. It operates each system according to communication signals from the AV control unit. The AV control unit includes the audio, hands-free phone, voice control, navigation, satellite radio, and vehicle information functions. It is connected to ECM, A/C auto amp. and combination meter via CAN communication to obtain necessary information for the vehicle information function. It is connected to BCM via CAN communication transmitting/receiving for the vehicle settings function. It inputs the illumination signals that are required for the display dimming control. It inputs the signals for driving status recognition (vehicle speed, reverse and parking brake). Update of map data is performed with the CONSULT-III and the applicable cable. It includes the TEL adapter and Bluetooth™ function.
FRONT DISPLAY UNIT	<ul style="list-style-type: none"> Front display image is controlled by the serial communication from AV control unit. RGB image signal is input from AV control unit (RGB, RGB area and RGB synchronizing). Auxiliary image signal is input from the auxiliary input jack. Camera image signal is input from camera control unit. Synchronize signal (HP, VP) is output to AV control unit. Touch panel function can be operated for each system by touching a display directly.
BOSE AMP.	<ul style="list-style-type: none"> Inputs power (amp. ON) and sound signal from AV control unit, and outputs sound signal to woofer and each speaker. Woofer amp. ON signal is transmitted to woofer.
WOOFER	<ul style="list-style-type: none"> Composed of two woofers and a woofer amp. Inputs power (amp. ON) and sound signal from BOSE amp. Outputs low frequency sound.
FRONT DOOR SPEAKER	<ul style="list-style-type: none"> Outputs sound signal from BOSE amp. Outputs sound (mid and low range).
REAR DOOR SPEAKER	<ul style="list-style-type: none"> Outputs sound signal from BOSE amp. Outputs sound (mid and low range).
FRONT SQUAWKER	<ul style="list-style-type: none"> Outputs sound signal from BOSE amp. Outputs sound (high and mid range).
REAR SPEAKER	<ul style="list-style-type: none"> Outputs sound signal from BOSE amp. Outputs sound (high and mid range).
CENTER SPEAKER	<ul style="list-style-type: none"> Outputs sound signal from BOSE amp. Outputs sound (high and mid range).
MULTIFUNCTION SWITCH	<ul style="list-style-type: none"> Operation panel is equipped with the centralized switch where audio and auxiliary input operations are integrated. The multifunction switch is connected to the preset switch by wiring harness, and it transmits the operation signal to the preset switch.
PRESET SWITCH	<ul style="list-style-type: none"> Operation panel is equipped with the centralized switch where audio and air conditioner operations are integrated. The preset switch is connected via AV communication, and it transmits the operation signals of the preset switch and multifunction switch. The disk ejection operating signal is performed by wiring harness.
STEERING SWITCH	<ul style="list-style-type: none"> Operations for audio, hands-free phone, audio response and navigation, etc. are possible. Steering switch signal (operation signal) is output to AV control unit.

MULTI AV SYSTEM

< FUNCTION DIAGNOSIS >

[BOSE AUDIO WITH NAVIGATION]

Part name	Description
CAMERA CONTROL UNIT	<ul style="list-style-type: none"> • Camera image signal is input from rear view camera. Camera image signal output to front display unit. • Power (camera ON signal) is transmitted to rear view camera. • Controlled by AV communication transmitted from AV control unit. • AV control unit recognizes the presence of camera system with camera connection recognition signal.
REAR VIEW CAMERA	<ul style="list-style-type: none"> • The image of vehicle rear view is transmitted to camera control unit. • It receives the power (camera ON signal) from the camera control unit and operates.
STEERING ANGLE SENSOR	Steering signal necessary for possible route line control is transmitted to camera control unit.
MICROPHONE	<ul style="list-style-type: none"> • Used for hands-free phone operation and voice recognition. • Mic signal is transmitted to AV control unit. • The power (Mic. power supply) is supplied from the AV control unit.
AUXILIARY INPUT JACKS	AUX image signal of auxiliary input is transmitted to front display, and sound signal is transmitted to AV control unit.
GPS ANTENNA	GPS signal is received and transmitted to AV control unit.
ANTENNA BASE	<p>An antenna base integrated with radio antenna amp. and satellite radio antenna is adopted.</p> <p>ANTENNA AMP.</p> <ul style="list-style-type: none"> • Radio signal received by rod antenna is amplified and transmitted to AV control unit. • Power (antenna amp. ON signal) is supplied from AV control unit. <p>SATELLITE RADIO ANTENNA</p> <ul style="list-style-type: none"> • Receives the satellite radio wave and outputs it to the AV control unit.
iPod ADAPTER	<ul style="list-style-type: none"> • Inputs iPod sound signal from iPod®, and outputs iPod sound signal to AV control unit. • Receiving/transmitting of iPod® operation signals are performed as follows: <ul style="list-style-type: none"> - between AV control unit and iPod adapter: AV communication. - between iPod® and iPod adapter: serial communication.

A
B
C
D
E
F
G
H
I
J
K
L
M
N
O
P

AV

NAVIGATION SYSTEM

System Diagram

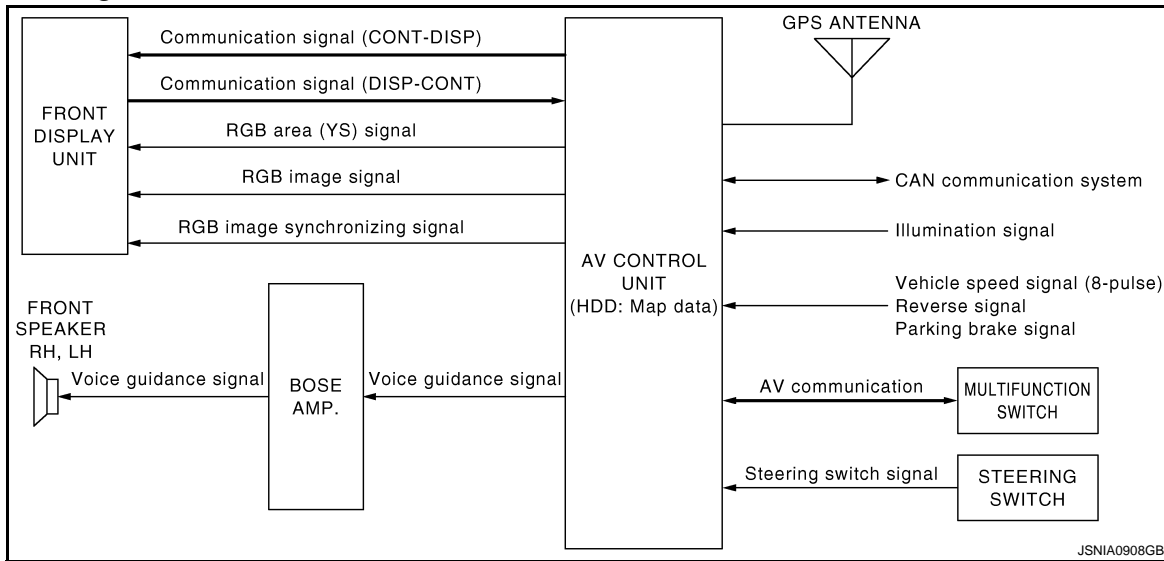

System Description

INFOID:000000003356553

DESCRIPTION

- The AV control unit controls navigation function while GPS tuner has built-in map data, GYRO (angle speed sensor), on the HDD (Hard Disk Drive).
- The AV control unit inputs operation signal with communication signal, through display (touch panel) and multifunction switch and steering switch.
- Guide sound is output to front speaker through BOSE amp. from AV control unit when operating navigation system.
- A vehicle position is calculated with the GYRO (angle speed sensor), vehicle sensor, signal from GPS satellite and map data stored on HDD (Hard Disk Drive), and transmits the map image signal (RGB image, RGB area, RGB image synchronizing) to the front display unit.

POSITION DETECTION PRINCIPLE

The navigation system periodically calculates the current vehicle position according to the following three types of signals.

- Travel distance of the vehicle as determined by the vehicle speed sensor
- Vehicle turning angle determined by the gyroscope (angular speed sensor)
- The travel direction of the vehicle determined by the GPS antenna (GPS information)

The current position of the vehicle is then identified by comparing the calculated vehicle position with map data, which is stored in the HDD (Hard Disk Drive) (map-matching), and indicated on the screen with a current location mark. More accurate data is used by comparing position detection results from GPS to the map-matching.

The current position is calculated by detecting the travel distance from the previous calculation point, and its direction change.

- Travel distance
The travel distance is generated from the vehicle speed sensor input signal. The automatic distance correction function is adopted for preventing a miss-detection of the travel distance because of tire wear etc.
- Travel direction
The gyroscope (angular velocity sensor) and GPS antenna (GPS information) generate the change of the travel direction. Both have advantages and disadvantages as per the following descriptions.

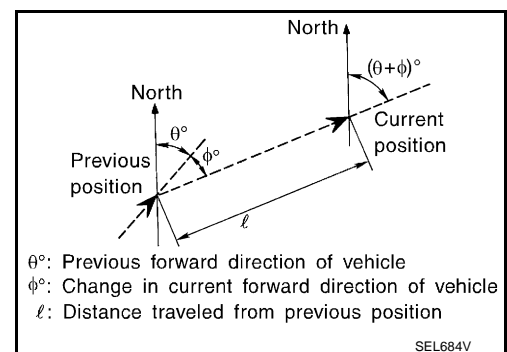
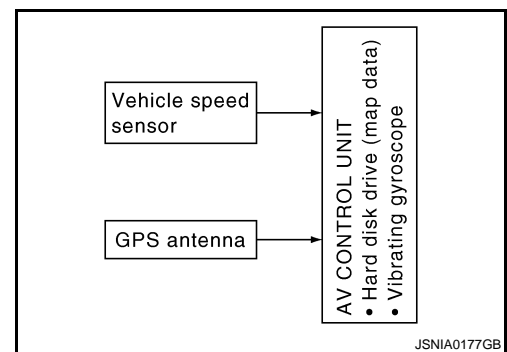

Type	Advantage	Disadvantage
Gyroscope (angular velocity sensor)	The turning angle is precisely detected.	Errors are accumulated when driving a long distance without stopping.
GPS antenna (GPS information)	The travel direction (North/South/East/West) is detected.	The travel direction is not precisely detected when driving slowly.

Input signals are prioritized in each situation. However, this order of priority may change in accordance with more detailed travel conditions so that the travel direction is detected more accurately.

MAP-MATCHING

Map-matching repositions the vehicle on the road map when a new location is judged to be more accurate. This is done by comparing the current vehicle position (calculated by the normal position detection method) from the map data stored in the HDD (Hard Disk Drive).

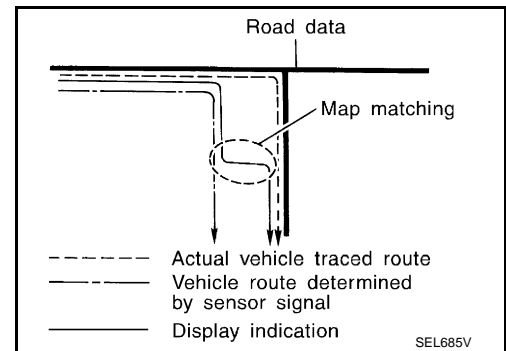

There is a possibility that the vehicle position may not be corrected the when vehicle is driven over a certain distance or time in which GPS information is hard to receive. Manually correct the current location mark on the screen.

- Map-matching detects, prepares, and prioritizes several alternative routes in addition to the road detected as currently being driven on. Therefore, due to errors in the distance and/or direction, an incorrect road may be prioritized, and the current location mark may be repositioned to the incorrect road.

If two roads are running in parallel, they are of the same priority. Therefore, the current location mark may appear on either of them alternately, depending on maneuvering of the steering wheel and configuration of the road, etc.

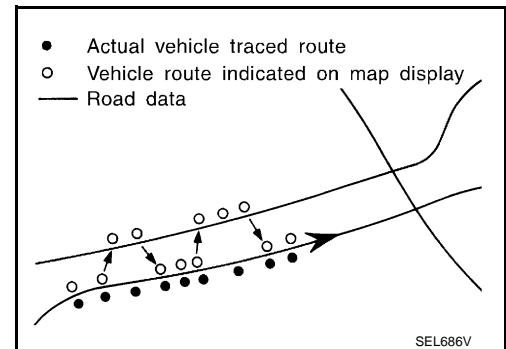

- Map-matching does not function correctly when the road on which the vehicle is driving is new, etc. and not recorded in the map data. In addition map-matching does not function correctly when the road pattern stored in the map data and the actual road pattern are different due to repair, etc.

Therefore, the map-matching function detects other roads as a currently driving road if the road is not in the map, and displays the current location mark on it. Later, the current location mark may be repositioned to the road if the correct road is detected.

- Effective range for comparing the vehicle position and travel direction calculated by the distance and direction with the road data is limited. Therefore, correction by map-matching is not possible when there is an excessive gap between the real-time vehicle position and the position on the map.

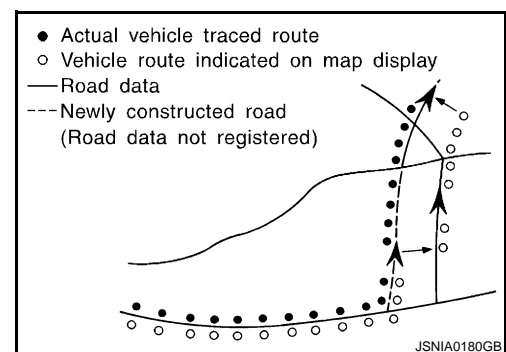

GPS (GLOBAL POSITIONING SYSTEM)

A
B
C
D
E
F
G
H
I
J
K
L
M
AV
O
P

NAVIGATION SYSTEM

< FUNCTION DIAGNOSIS >

[BOSE AUDIO WITH NAVIGATION]

GPS (Global Positioning System) is developed for and is controlled by the US Department of Defense. The system utilizes GPS satellites (NAVSTAR), transmitting out radio waves while flying on an orbit around the earth at an altitude of approximately 21,000 km (13,049 mile).

The receiver calculates the travel position in three dimensions (latitude/longitude/altitude) according to the time lag of the radio waves that four or more GPS satellites transmit (three-dimensional positioning). The GPS receiver calculates the travel position in two dimensions (latitude/longitude) with the previous altitude data if the GPS receiver receives only three radio waves (two-dimensional positioning). GPS position correction is not performed while the vehicle is stopped.

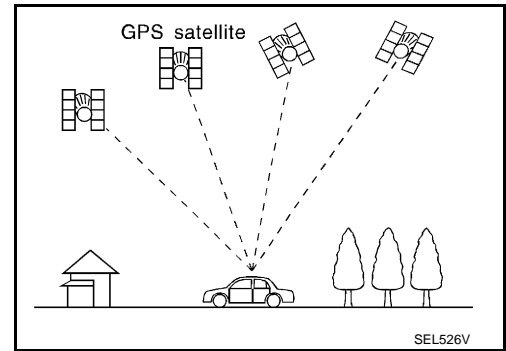

Accuracy of GPS will deteriorate under the following conditions:

- In two-dimensional positioning, GPS accuracy will deteriorate when altitude of the vehicle position changes.
- The position of GPS satellite affects GPS detection precision. The position detection may not be precisely performed.
- The position detection is not performed if GPS receiver does not receive radio waves from GPS satellites. (Inside a tunnel, parking in a building, under an elevated highway etc.) GPS receiver may not receive radio waves from GPS satellites if any object is placed on the GPS antenna.

NOTE:

- The detection result has an error of approximately 10 m (32.81 ft) even with a high-precision three dimensional positioning.
- There may be cases when the accuracy is lowered and radio waves are stopped intentionally because the GPS satellite signal is controlled by the US trace control center.

NAVIGATION SYSTEM

< FUNCTION DIAGNOSIS >

[BOSE AUDIO WITH NAVIGATION]

Component Parts Location

INFOID:000000003464477

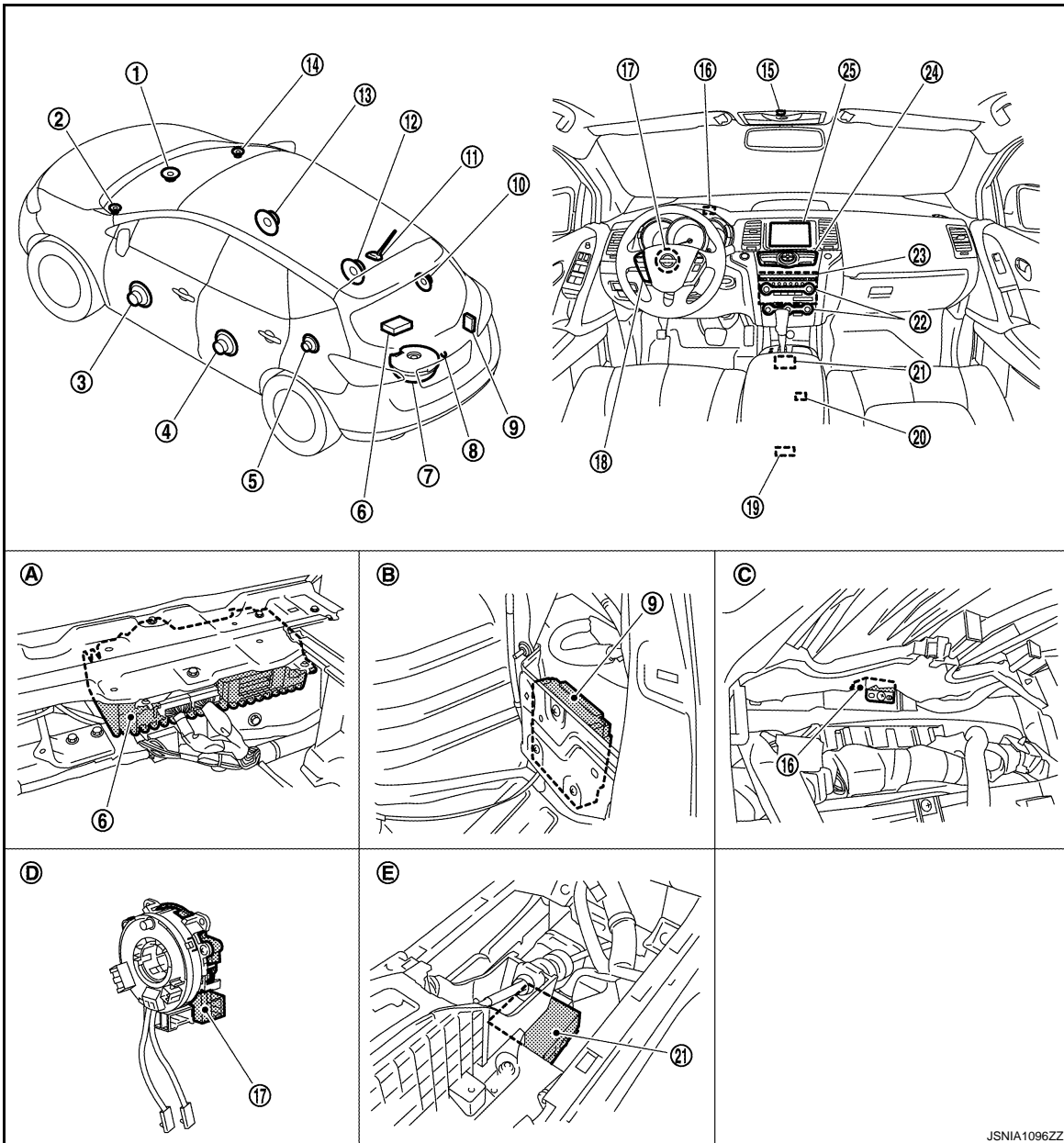

- | | | |
|---------------------------|---|--------------------------|
| 1. Center speaker | 2. Front squawker LH | 3. Front door speaker LH |
| 4. Rear door speaker LH | 5. Rear speaker LH | 6. BOSE amp. |
| 7. Woofer | 8. Rear view camera | 9. Camera control unit |
| 10. Rear speaker RH | 11. Antenna base (antenna amp. and satellite antenna) | 12. Rear door speaker RH |
| 13. Front door speaker RH | 14. Front squawker RH | 15. Microphone |
| 16. GPS antenna | 17. Steering angle sensor | 18. Steering switch |
| 19. Auxiliary input jacks | 20. iPod connector | 21. iPod adapter |
| 22. Preset switch | 23. AV control unit | 24. Multifunction switch |
| 25. Front display unit | | |

A. Luggage floor finisher is removed condition

B. Luggage side finisher lower RH is removed condition

C. Combination meter is removed condition

D. Spiral cable part

E. Console finisher is removed condition

A
B
C
D
E
F
G
H
I
J
K
L
M

AV

O
P

NAVIGATION SYSTEM

< FUNCTION DIAGNOSIS >

[BOSE AUDIO WITH NAVIGATION]

Component Description

INFOID:000000003356555

Part name	Description
AV CONTROL UNIT	<ul style="list-style-type: none">• It is the master unit that controls each operation of the Navigation system.• The HDD (Hard Disk Drive) is built in, and the map data is stored in HDD.• The RGB signal (map information) is output to the front display unit.• The voice guidance signal is output to the BOSE amp.
FRONT DISPLAY UNIT	<ul style="list-style-type: none">• Map image signal is input from AV control unit, and it is indicated on the display.• Each operation of navigation can be performed by the touch panel function.
BOSE AMP.	Voice guidance signal is input from AV control unit, and it is output to front LH/RH speakers.
FRONT DOOR SPEAKER	Voice guidance signal from BOSE amp. is output.
FRONT SQUAWKER	
MULTIFUNCTION SWITCH	<ul style="list-style-type: none">• Each operation of navigation can be performed.• The multifunction switch is connected to the preset switch by wiring harness, and it transmits the operation signal to the preset switch.
PRESET SWITCH	<ul style="list-style-type: none">• Operation panel is equipped with the centralized switch where audio and air conditioner operations are integrated.• The preset switch is connected via AV communication, and it transmits the operation signals of the preset switch and multifunction switch.• The disk ejection operating signal is performed by wiring harness.
STEERING SWITCH	<ul style="list-style-type: none">• Each operation of navigation, etc. can be performed.• Switch operating signal is output to AV control unit.
MICROPHONE	<ul style="list-style-type: none">• Used for hands-free phone operation and voice recognition.• Mic signal is transmitted to AV control unit.• Power (Mic VCC) is supplied from AV control unit.
GPS ANTENNA	GPS signal is received and is output to AV control unit.

REAR VIEW MONITOR SYSTEM

< FUNCTION DIAGNOSIS >

[BOSE AUDIO WITH NAVIGATION]

REAR VIEW MONITOR SYSTEM

System Diagram

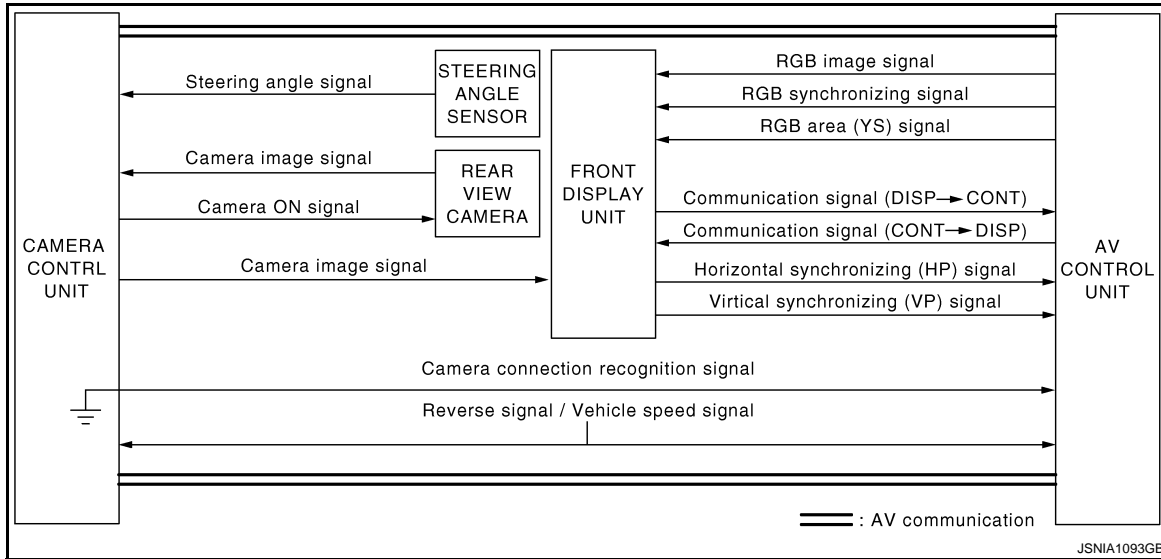

System Description

INFOID:000000003356557

CAMERA IMAGE OPERATION PRINCIPLE

- Power is supplied to rear view camera from camera control unit and outputs camera image signal to camera control unit when selector lever is set to the “R” position and the reverse signal on camera control unit is input.
- Camera control unit synthesizes guide lines and possible route lines with camera image signal from rear view camera, and transmits camera image signal to the front display unit. In this case, since the reverse signal is also input to AV control unit, the AV control unit recognizes that the selector lever is in the “R” position, and it switches communication signal between AV control unit and front display unit, and image that is displayed on the front display unit by RGB image signal with rear view monitor image. In addition, possible route lines are controlled by original sensor signal from steering angle sensor.
- The AV control unit determines whether rear view camera is equipped or not, based on the presence of camera connection recognition signal. It switches to rear view monitor image at the time of reverse signal input when it is equipped.
- Warning message under the rear view monitor display is described by AV control unit.
- AV control unit is connected in communication with camera control unit and front display unit, and it controls operation of rear view monitor system.

A
B
C
D
E
F
G
H
I
J
K
L
M
O
P

AV

REAR VIEW MONITOR SYSTEM

[BOSE AUDIO WITH NAVIGATION]

< FUNCTION DIAGNOSIS >

Component Parts Location

INFOID:000000003464478

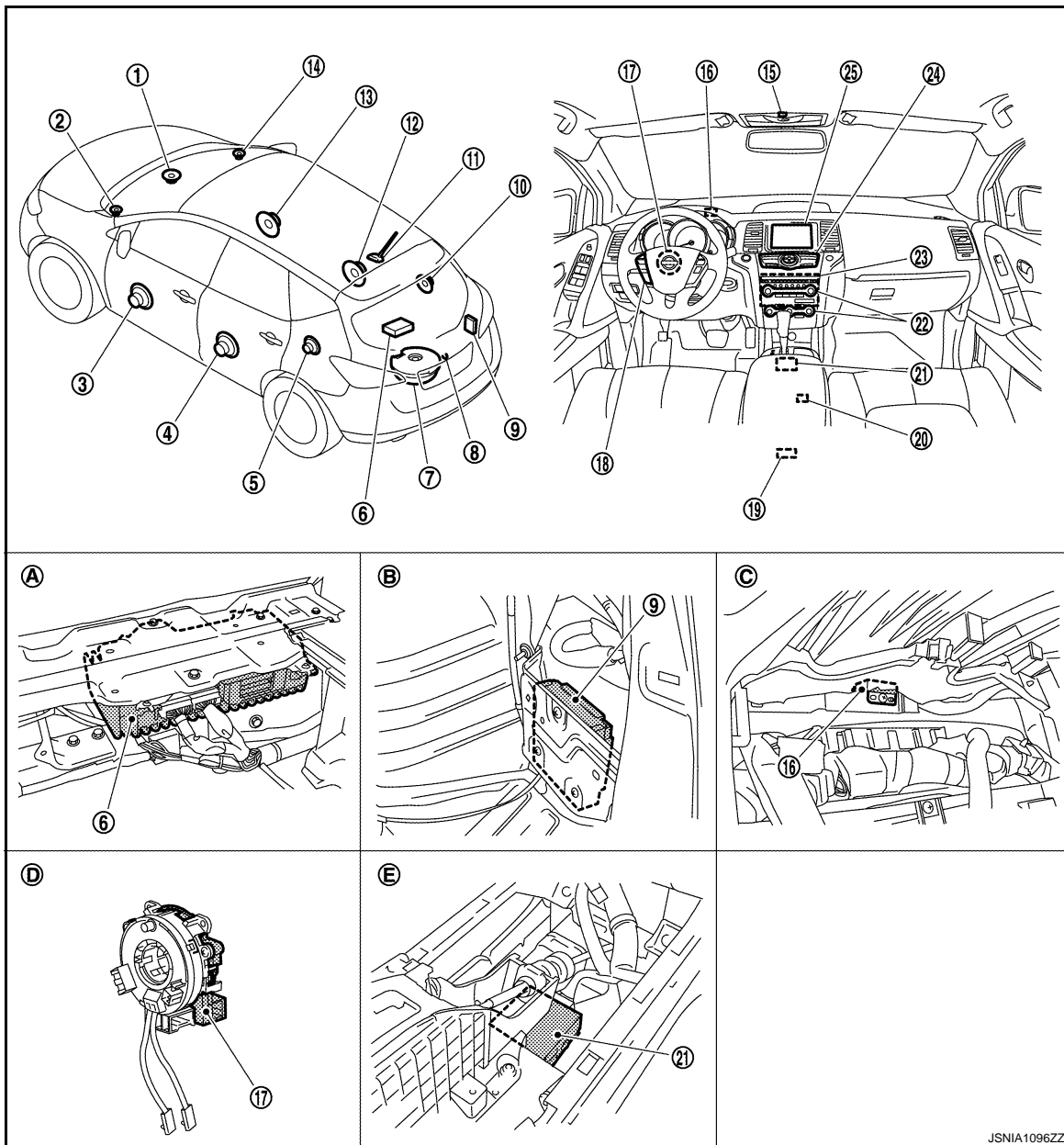

JSNIA1096ZZ

- | | | |
|--|--|---|
| 1. Center speaker | 2. Front squawker LH | 3. Front door speaker LH |
| 4. Rear door speaker LH | 5. Rear speaker LH | 6. BOSE amp. |
| 7. Woofer | 8. Rear view camera | 9. Camera control unit |
| 10. Rear speaker RH | 11. Antenna base (antenna amp. and satellite antenna) | 12. Rear door speaker RH |
| 13. Front door speaker RH | 14. Front squawker RH | 15. Microphone |
| 16. GPS antenna | 17. Steering angle sensor | 18. Steering switch |
| 19. Auxiliary input jacks | 20. iPod connector | 21. iPod adapter |
| 22. Preset switch | 23. AV control unit | 24. Multifunction switch |
| 25. Front display unit | | |
| A. Luggage floor finisher is removed condition | B. Luggage side finisher lower RH is removed condition | C. Combination meter is removed condition |
| D. Spiral cable part | E. Console finisher is removed condition | |

REAR VIEW MONITOR SYSTEM

[BOSE AUDIO WITH NAVIGATION]

< FUNCTION DIAGNOSIS >

Component Description

INFOID:000000003356559

Part name	Description
AV CONTROL UNIT	<ul style="list-style-type: none"> Image on display is changed to rear view monitor image with serial communication between AV control unit and front display unit. Warning displayed in rear view monitor image is illustrated.
FRONT DISPLAY UNIT	<ul style="list-style-type: none"> Camera image signal is transmitted from camera control unit, and RGB signal for warning display is transmitted from AV control unit. Rear view monitor image is changed with the communication for AV control unit.
CAMERA CONTROL UNIT	<ul style="list-style-type: none"> Camera image signal is input from rear view camera, and camera image is indicated on the front display unit. Power (camera ON signal) is transmitted to rear view camera. Controlled by AV communication transmitted from AV control unit. AV control unit recognizes the presence of camera system with camera connection recognition signal.
REAR VIEW CAMERA	The image of vehicle rear view is transmitted to camera control unit.
STEERING ANGLE SENSOR	Steering signal necessary for possible route line control is transmitted to camera control unit.

A

B

C

D

E

F

G

H

I

J

K

L

M

AV

O

P

AUDIO SYSTEM

System Diagram

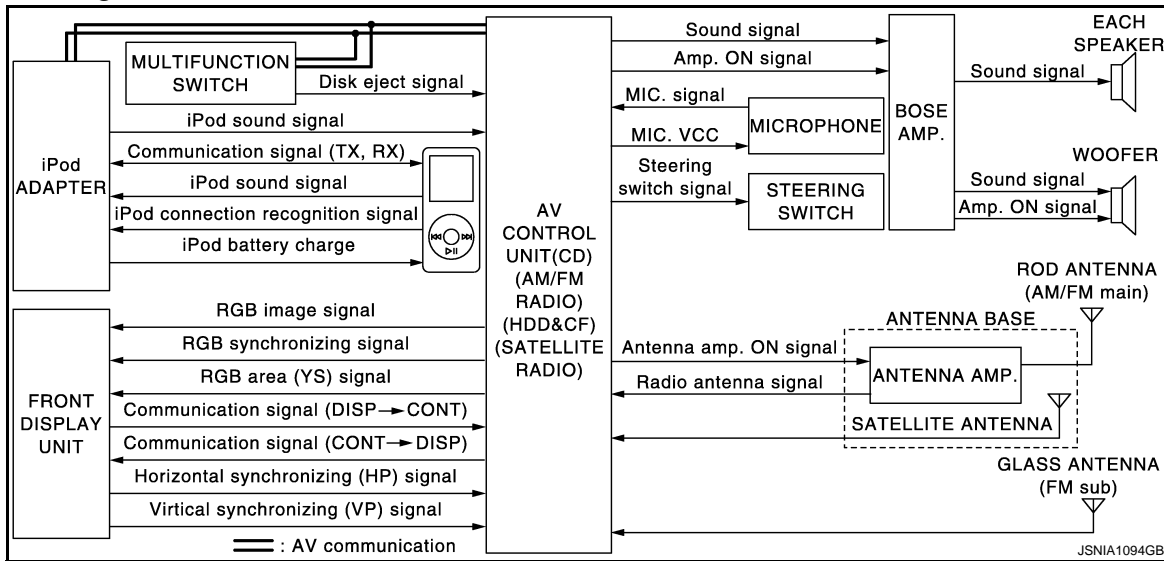

NOTE:

- Woofer, illustrated in the above figure, integrates two woofers and a woofer amp.
- The name MULTIFUNCTION SWITCH indicates the integration of PRESET SWITCH and MULTIFUNCTION SWITCH virtually.
- An antenna base integrated with radio antenna amp. and satellite radio antenna is adopted.

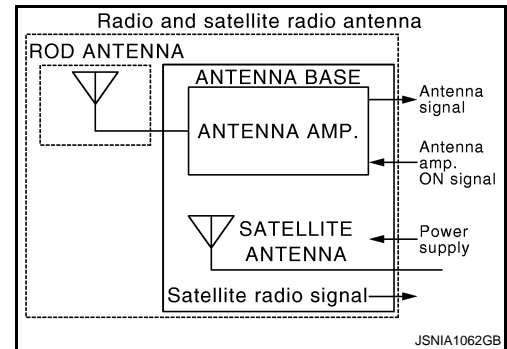

System Description

INFOID:000000003356561

The audio system is equipped with the following functions. Each function is operated with multifunction switch, preset switch, touch panel, steering switch or audio recognition. Operation status of AUDIO is indicated in the display.

Function
AM/FM radio
Satellite radio
CD
Music Box (Hard Disk Drive)
CF (Compact Flash)
iPod connection
AUX mode

FUNCTION DESCRIPTION

Operating Signal

Audio system operation can be performed with multifunction switch, preset switch, steering switch, touch panel function or voice recognition function.

AUDIO SYSTEM

< FUNCTION DIAGNOSIS >

[BOSE AUDIO WITH NAVIGATION]

- Operating signal is transmitted to AV control unit with AV communication when it is operated by multifunction switch or preset switch. The disk ejection operating signal is performed by wiring harness. A
- Operating signal is transmitted to AV control unit with steering switch signal when it is operated by steering switch. B
- Refer to [AV-555, "System Description"](#) for explanation of voice recognition function and touch panel function. B

Screen Front Display

- Switching of display is performed with serial communication between front display unit and AV control unit. C
- The image signal to front display operating condition is performed with RGB image signal, RGB area signal and RGB synchronizing signal. C

AM/FM Radio Mode

- AM/FM radio tuner is built into AV control unit. D
- AM/FM radio wave is received by rod antenna, next it is amplified by antenna amp., and finally it is input to AV control unit. The FM sub antenna is installed on the back door window glass and the AV control unit is received. D
- Audio signal is input to BOSE amp. and BOSE amp. outputs to woofer and each speaker for AV control unit. E

Satellite Radio Mode

- Satellite radio tuner is built into AV control unit. F
- Audio wave (satellite radio) is received by antenna base (satellite antenna), and it is input to AV control unit. AV control unit outputs audio signal to BOSE amp. The signal is also outputted from BOSE amp. to both woofer and each speaker. F

CD Mode

- CD function is built into AV control unit. G
- AV control unit outputs audio signal to BOSE amp. and BOSE amp. outputs to woofer and each speaker when CD is inserted to AV control unit. H

Music Box Mode

- Music CD data is stored on HDD that is built into AV control unit, and it can be played. I
- AV control unit outputs music (audio signal) that is stored on HDD to BOSE amp., and BOSE amp. outputs to woofer and each speaker. I

CF Mode

- AV control unit has built in CF replay function. J
- Music (audio signal) that is stored in CF outputs to BOSE amp., and BOSE amp. outputs to woofer and each speaker when CF is inserted into AV control unit. J

iPod Connection

- Connect iPod® and iPod adapter with wire harness and iPod adapter input iPod sound signal from iPod®. When iPod mode is selected, iPod adapter outputs iPod sound signal to AV control unit. AV control unit output sound signal to BOSE amp., and BOSE amp. output sound signal to woofer and each speaker. L
- Receiving/transmitting of iPod® operation signals are performed as follows: L
 - between AV control unit and iPod adapter: AV communication.
 - between iPod® and iPod adapter: serial communication. M
- The iPod® connection status can be recognized if iPod adapter receives iPod connection recognition signal.
- The iPod adapter can charge iPod®. AV

AUX Mode

Refer to [AV-555, "System Description"](#). O

P

AUDIO SYSTEM

< FUNCTION DIAGNOSIS >

[BOSE AUDIO WITH NAVIGATION]

Component Parts Location

INFOID:000000003464479

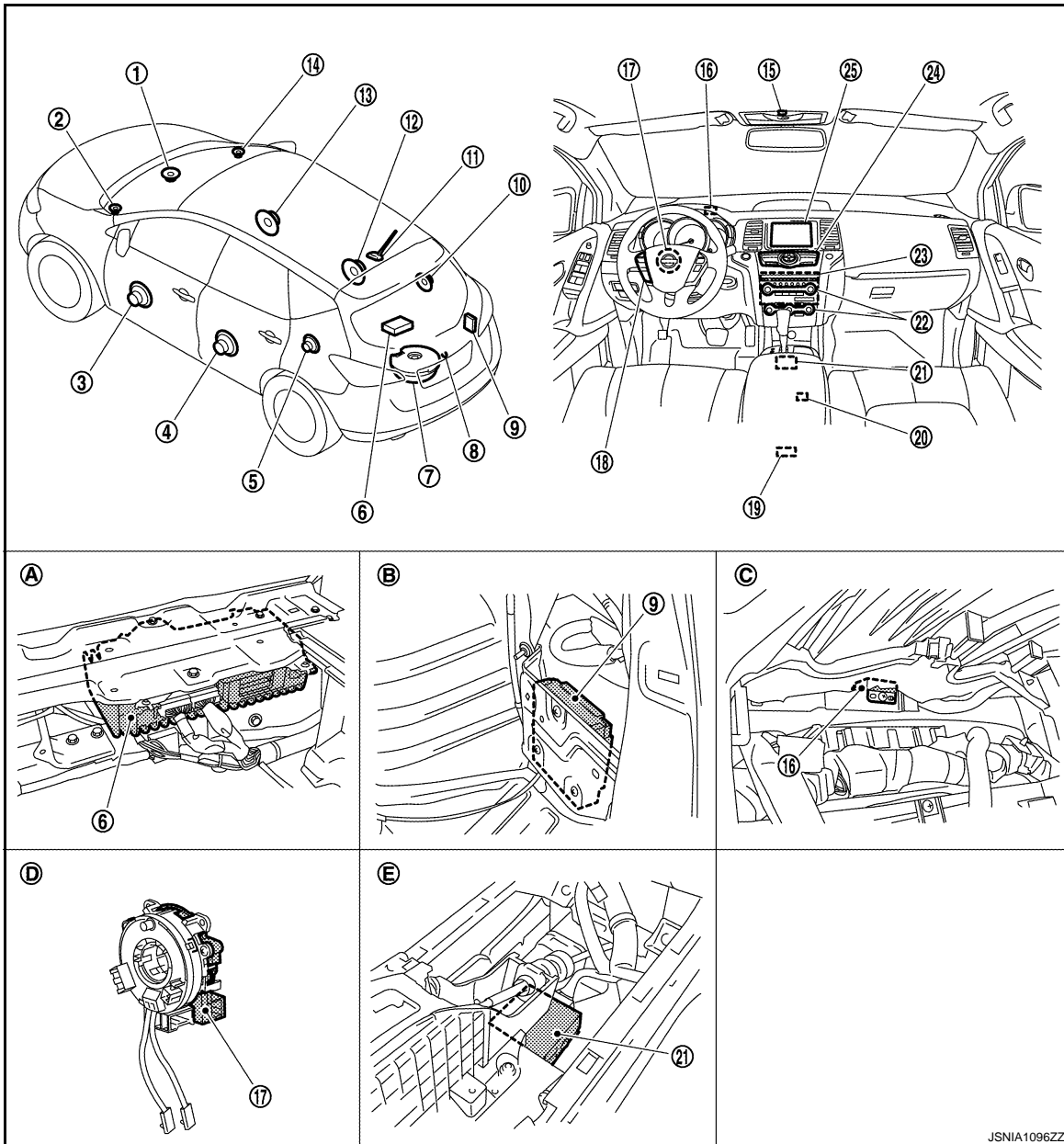

JSNIA1096ZZ

- | | | |
|--|--|---|
| 1. Center speaker | 2. Front squawker LH | 3. Front door speaker LH |
| 4. Rear door speaker LH | 5. Rear speaker LH | 6. BOSE amp. |
| 7. Woofer | 8. Rear view camera | 9. Camera control unit |
| 10. Rear speaker RH | 11. Antenna base (antenna amp. and satellite antenna) | 12. Rear door speaker RH |
| 13. Front door speaker RH | 14. Front squawker RH | 15. Microphone |
| 16. GPS antenna | 17. Steering angle sensor | 18. Steering switch |
| 19. Auxiliary input jacks | 20. iPod connector | 21. iPod adapter |
| 22. Preset switch | 23. AV control unit | 24. Multifunction switch |
| 25. Front display unit | | |
| A. Luggage floor finisher is removed condition | B. Luggage side finisher lower RH is removed condition | C. Combination meter is removed condition |
| D. Spiral cable part | E. Console finisher is removed condition | |

AUDIO SYSTEM

[BOSE AUDIO WITH NAVIGATION]

< FUNCTION DIAGNOSIS >

Component Description

INFOID:000000003356563

Part name	Description
AV CONTROL UNIT	<ul style="list-style-type: none"> Receiving function of AM/FM/satellite radio, replaying function of CD, replaying/saving function of music box (HDD), replaying function of CF and voice recognition function are integrated. BOSE amp. ON signal and sound signal are transmitted to BOSE amp.
FRONT DISPLAY UNIT	<ul style="list-style-type: none"> Front display image is controlled by the serial communication from AV control unit. RGB image signal (audio operation condition) is input from AV control unit. Touch panel function can be operated for each system by touching the display directly.
BOSE AMP.	<ul style="list-style-type: none"> Inputs power (amp. ON) and sound signal from AV control unit, and outputs sound signal to woofer and each speaker. Woofer amp. ON signal is transmitted to woofer.
WOOFER	<ul style="list-style-type: none"> Composed of two woofers and a woofer amp. Inputs power (amp. ON) and sound signal from BOSE amp. Outputs low frequency sound.
FRONT DOOR SPEAKER	<ul style="list-style-type: none"> Outputs sound signal from BOSE amp. Outputs sound (mid and low range).
REAR DOOR SPEAKER	<ul style="list-style-type: none"> Outputs sound signal from BOSE amp. Outputs sound (mid and low range).
FRONT SQUAWKER	<ul style="list-style-type: none"> Outputs sound signal from BOSE amp. Outputs sound (high and mid range).
REAR SPEAKER	<ul style="list-style-type: none"> Outputs sound signal from BOSE amp. Outputs sound (high and mid range).
CENTER SPEAKER	<ul style="list-style-type: none"> Outputs sound signal from BOSE amp. Outputs sound (high and mid range).
MULTIFUNCTION SWITCH	<ul style="list-style-type: none"> Operation panel is equipped with the centralized switch where audio and auxiliary input operations are integrated. The multifunction switch is connected to the preset switch by wiring harness, and it transmits the operation signal to the preset switch.
PRESET SWITCH	<ul style="list-style-type: none"> Operation panel is equipped with the centralized switch where audio and air conditioner operations are integrated. The preset switch is connected via AV communication, and it transmits the operation signals of the preset switch and multifunction switch. The disk ejection operating signal is performed by wiring harness.
STEERING SWITCH	<ul style="list-style-type: none"> Operations for audio, hands-free phone, audio response and navigation, etc. are possible. Steering switch signal (operation signal) is output to AV control unit.
MICROPHONE	<ul style="list-style-type: none"> Used for hands-free phone operation and voice recognition. Mic signal is transmitted to AV control unit. The power (Mic. power supply) is supplied from the AV control unit.
ANTENNA BASE	<p>An antenna base integrated with radio antenna amp. and satellite radio antenna is adopted.</p> <p>ANTENNA AMP.</p> <ul style="list-style-type: none"> Radio signal received by rod antenna is amplified and transmitted to AV control unit. Power (antenna amp. ON signal) is supplied from AV control unit. <p>SATELLITE RADIO ANTENNA</p> <ul style="list-style-type: none"> Receives the satellite radio wave and outputs it to the AV control unit.
iPod ADAPTER	<ul style="list-style-type: none"> Inputs iPod sound signal from iPod®, and outputs iPod sound signal to AV control unit. Receiving/transmitting of iPod® operation signals are performed as follows: <ul style="list-style-type: none"> between AV control unit and iPod adapter: AV communication. between iPod® and iPod adapter: serial communication.

A

B

C

D

E

F

G

H

I

J

K

L

M

AV

O

P

HANDS-FREE PHONE SYSTEM

System Diagram

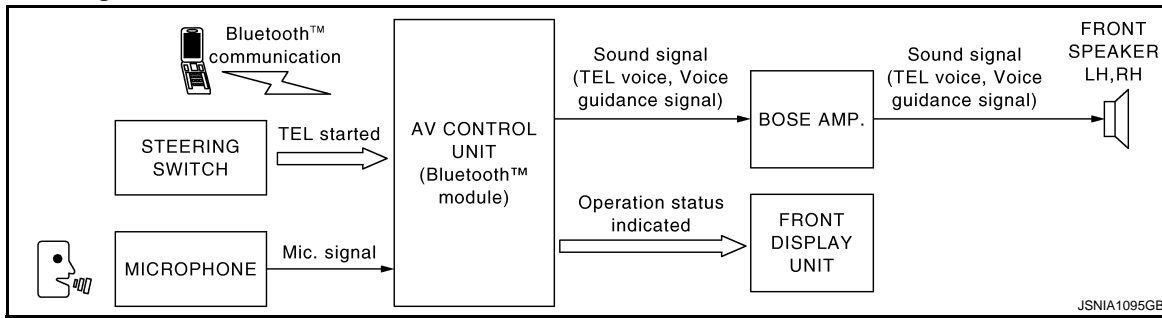

System Description

INFOID:000000003451236

- AV control unit includes hands-free phone function.
- Hands-free communication can be operated by connecting using Bluetooth™ communication with cellular phone.
- Operation is performed by steering switch, and operating condition is indicated on front display.
- Guide sound that is heard during operation is input from AV control unit to BOSE amp., and is output from front speaker.

WHEN A CALL IS ORIGINATED

Spoken voice sound output from the microphone (MIC. signal) is input to AV control unit. AV control unit outputs to cellular phone with Bluetooth™ communication as a TEL voice signal. Vocal sound is then heard at the other party.

WHEN RECEIVING A CALL

Vocal sound is input to own cellular phone from the other party. TEL voice signal is output to front speaker, and the signal is input to BOSE amp. via AV control unit by establishing Bluetooth™ communication from cellular phone.

HANDS-FREE PHONE SYSTEM

[BOSE AUDIO WITH NAVIGATION]

< FUNCTION DIAGNOSIS >

Component Parts Location

INFOID:000000003464480

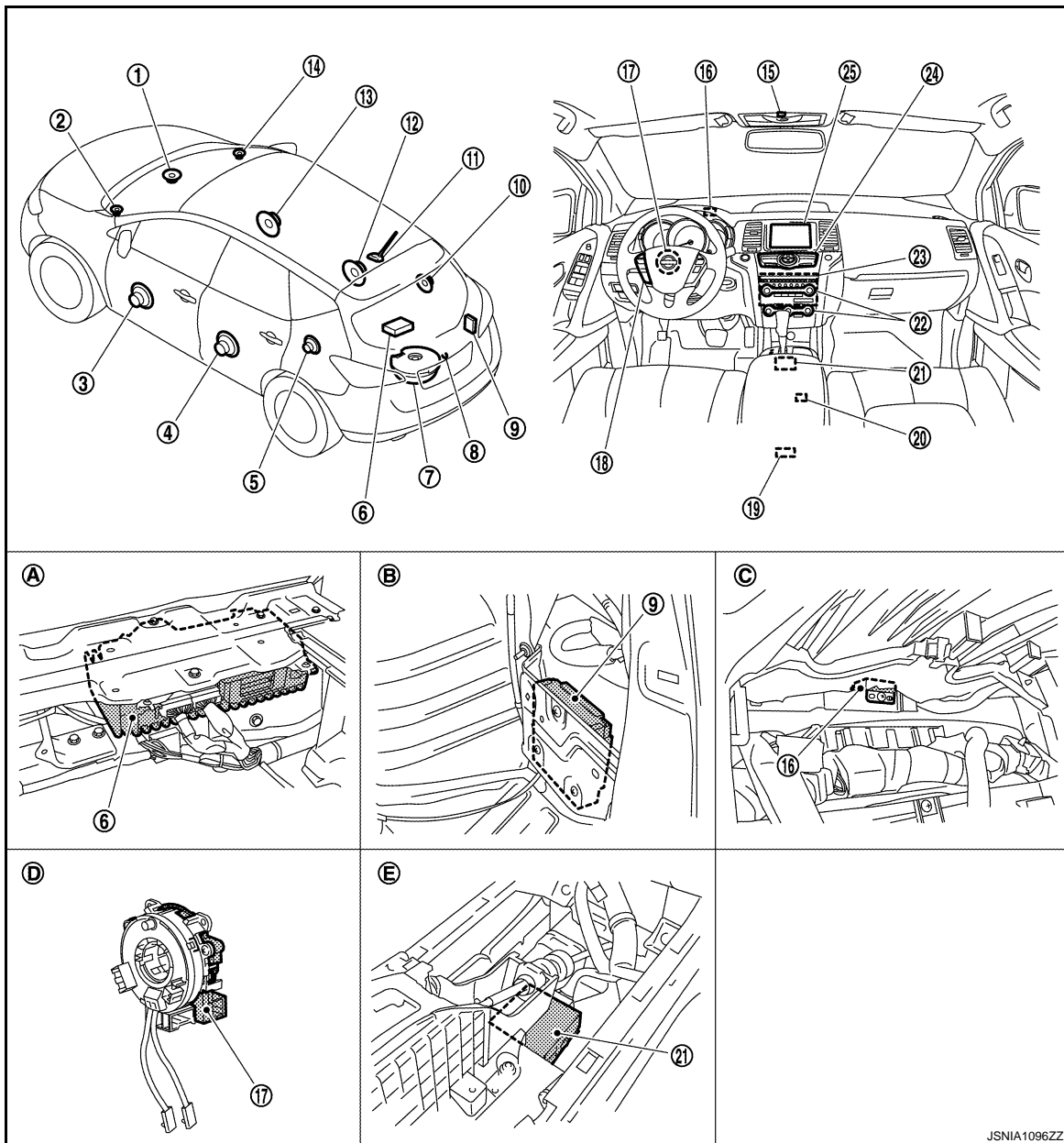

A
B
C
D
E
F
G
H
I
J
K
L
M

- | | | |
|---------------------------|---|--------------------------|
| 1. Center speaker | 2. Front squawker LH | 3. Front door speaker LH |
| 4. Rear door speaker LH | 5. Rear speaker LH | 6. BOSE amp. |
| 7. Woofer | 8. Rear view camera | 9. Camera control unit |
| 10. Rear speaker RH | 11. Antenna base (antenna amp. and satellite antenna) | 12. Rear door speaker RH |
| 13. Front door speaker RH | 14. Front squawker RH | 15. Microphone |
| 16. GPS antenna | 17. Steering angle sensor | 18. Steering switch |
| 19. Auxiliary input jacks | 20. iPod connector | 21. iPod adapter |
| 22. Preset switch | 23. AV control unit | 24. Multifunction switch |
| 25. Front display unit | | |

- | | | |
|--|--|---|
| A. Luggage floor finisher is removed condition | B. Luggage side finisher lower RH is removed condition | C. Combination meter is removed condition |
| D. Spiral cable part | E. Console finisher is removed condition | |

AV

O
P

HANDS-FREE PHONE SYSTEM

[BOSE AUDIO WITH NAVIGATION]

< FUNCTION DIAGNOSIS >

Component Description

INFOID:000000003451238

Part name	Description
AV CONTROL UNIT	<ul style="list-style-type: none">• It includes the TEL adapter and Bluetooth™ function.• It outputs the TEL voice signal and voice guidance sound signal to the BOSE amp.
FRONT DISPLAY UNIT	<ul style="list-style-type: none">• Display image is controlled by the serial communication from AV control unit.• Inputs RGB image signal (RGB, RGB area and RGB synchronizing) from AV control unit and displays the status of hands free phone system.
BOSE AMP.	Inputs TEL voice signal or voice guidance signal from AV control unit and outputs it to front speaker.
FRONT DOOR SPEAKER	Outputs the TEL voice signal or voice guidance signal from BOSE amp.
PRESET SWITCH	<ul style="list-style-type: none">• Adjust the sound when using TEL.• The operation signal is transmitted to the AV control unit via AV communication.
STEERING SWITCH	<ul style="list-style-type: none">• The hands free-phone system can be operated.• Steering switch signal (operation signal) is output to AV control unit.
MICROPHONE	<ul style="list-style-type: none">• Uses when operating the hands-free phone.• Outputs Mic. signal (TEL voice signal) to the AV control unit.• The power (Mic. power supply) is supplied from the AV control unit.

DIAGNOSIS SYSTEM (AV CONTROL UNIT)

< FUNCTION DIAGNOSIS >

[BOSE AUDIO WITH NAVIGATION]

DIAGNOSIS SYSTEM (AV CONTROL UNIT)

Diagnosis Description

INFOID:000000003356564

MULTIFUNCTION SWITCH AND PRESET SWITCH SELF-DIAGNOSIS FUNCTION

The ON/OFF operation (continuity) of each switch in the multifunction switch and preset switch can be checked.

Self-diagnosis Mode

- Press the "BACK" switch and the "▲" switch of the 8-direction switches within 10 seconds after turning the ignition switch from OFF to ACC and hold them for 3 seconds or more. Then the buzzer sounds, all indicators of the preset switch illuminate, and the self-diagnosis mode starts.
- The continuity of each switch at the ON position can be checked by pressing the switch. The buzzer sounds if the switch is normal.

NOTE:

The disk eject switch cannot be checked.

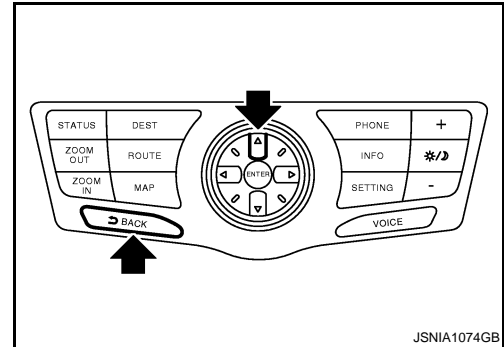

Finishing Self-diagnosis Mode

Self-diagnosis mode is canceled when turning the ignition switch OFF.

MULTI AV SYSTEM ON BOARD DIAGNOSIS FUNCTION

- The AV control unit diagnosis function starts up with multifunction switch operation and the AV control unit performs a diagnosis for each unit in the system during the on board diagnosis.
- Perform a CONSULT-III diagnosis if the on board diagnosis does not start, e.g., the screen does not display anything, the multifunction switch does not function, etc.

ON BOARD DIAGNOSIS

Description

- The trouble diagnosis function has a self-diagnosis mode for conducting trouble diagnosis automatically and a confirmation/adjustment mode for operating manually.
- The self-diagnosis mode performs diagnoses on the AV control unit, connections between system components as well as connections between AV control unit and GPS antenna and between AV control unit and satellite radio antenna. Then it displays the diagnosis results on the display.
- The confirmation/adjustment mode allows the technician to check, modify or adjust the vehicle signals and set values, as well as to monitor the system error records and system communication status. The checking, modifying or adjusting generally require human intervention and judgment (the system cannot automatically).

On Board Diagnosis Item

Mode	Description
Self-Diagnosis	<ul style="list-style-type: none"> • AV control unit diagnosis • Diagnoses the connections across system components, between AV control unit and GPS antenna and between AV control unit and satellite radio antenna.

A
B
C
D
E
F
G
H
I
J
K
L
M
O
P

AV

DIAGNOSIS SYSTEM (AV CONTROL UNIT)

< FUNCTION DIAGNOSIS >

[BOSE AUDIO WITH NAVIGATION]

Mode		Description	
Confirmation/ Adjustment	Display Diagnosis	The following check functions are available: color tone check by color bar display, light and shade check by gray scale display and touch panel calibration response check.	
	Vehicle Signals	Diagnosis of signals can be performed for vehicle speed, parking brake, lights, ignition switch, and reverse.	
	Speaker Test	The connection of a speaker can be confirmed by test tone.	
	Climate Control*	Not used.	
	Navigation	Steering Angle Adjustment	When there is a difference between the actual turning angle and the vehicle mark turning angle, it can be adjusted.
		Speed Calibration	When there is a difference between the current location mark and the actual location, it can be adjusted.
		XM SAT Subscription Status	The XM NavTraffic subscription status can be checked.
	Error History	The system malfunction and the frequency when occurring in the past are displayed. When the malfunctioning item is selected, the time and place that the selected malfunction last occurred are displayed.	
	Vehicle CAN Diagnosis	The transmitting/receiving of CAN communication can be monitored.	
	AV COMM Diagnosis	The communication condition of each unit of MULTI AV system can be monitored.	
	Handsfree Phone	The received volume adjustment of hands-free phone, microphone speaker check, and erase memory can be performed.	
	Camera Cont.	The signal connected to camera control unit can be checked and the guiding line position that overlaps rear view camera image can be adjusted.	
	Bluetooth	The passkey and the device name can be checked and changed.	
	SAT	Change Channel	Any necessary channels required to receive traffic information from the satellite radio system can be set.
		Change Application ID	Any application ID's required to receive traffic information from the satellite radio system can be set.
Diag		Not used.	
Delete Unit Connection Log	Erase the connection history of unit and error history.		
Initialize Settings	Initializes the AV control unit memory.		

NOTE:

*: On-board self-diagnosis is not supported. Only CONSULT-III is supported.

STARTING PROCEDURE

1. Start the engine.
2. Turn the audio system OFF.
3. While pressing the "SETTING" button, turn the volume control dial clockwise or counterclockwise for 40 clicks or more. (When the self-diagnosis mode is started, a short beep will be heard.)
 - Shifting from current screen to previous screen is performed by pressing the "BACK" button.

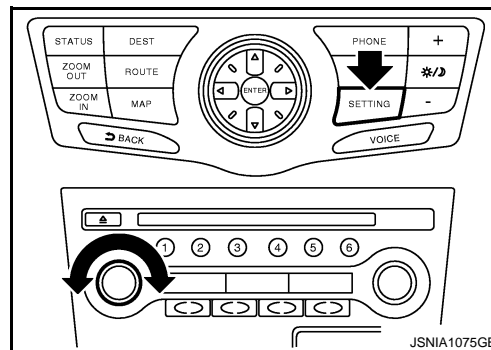

DIAGNOSIS SYSTEM (AV CONTROL UNIT)

[BOSE AUDIO WITH NAVIGATION]

< FUNCTION DIAGNOSIS >

- The trouble diagnosis initial screen is displayed, and then the items of "Self Diagnosis" and "Confirmation/Adjustment" can be selected.

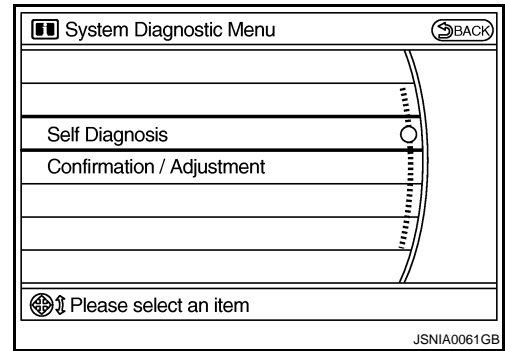

SELF-DIAGNOSIS MODE

- Start the self-diagnosis function and select "Self Diagnosis".
 - Self-diagnosis subdivision screen is displayed, and the self-diagnosis mode starts.
 - The bar graph visible on the center of the self-diagnosis subdivision screen indicates progress of the trouble diagnosis.

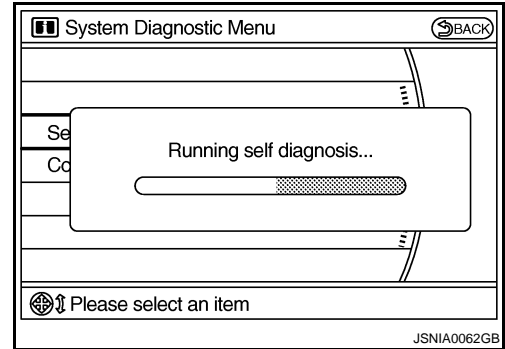

- Diagnosis results are displayed after the self-diagnosis is completed. The unit names and the connection lines are color-coded according to the diagnostic results.

Diagnosis results	Unit	Con- nection line
Normal	Green	Green
Connection malfunction	Gray	Yellow
Unit malfunction ^{Note}	Red	Green

NOTE:

- Only the control unit (AV control unit) is displayed in red.
 - The number of units that is displayed on the on board self-diagnosis display according to equipment.
 - Replace AV control unit if "Self-Diagnosis did not run because of a control unit malfunction" is indicated. The symptom is AV control unit internal error. Refer to [AV-764, "Exploded View"](#).
- If multiple errors occur at the same time for a single unit, the screen switch colors are determined according to the following order of priority: red > gray.

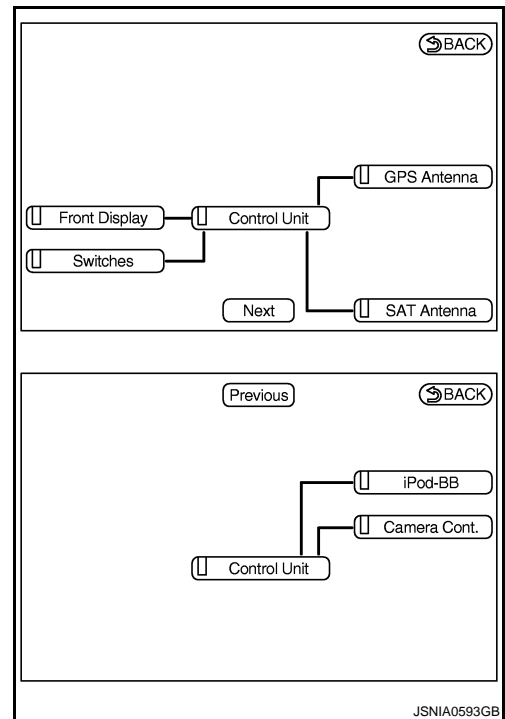

A
B
C
D
E
F
G
H
I
J
K
L
M
O
P

AV

DIAGNOSIS SYSTEM (AV CONTROL UNIT)

[BOSE AUDIO WITH NAVIGATION]

< FUNCTION DIAGNOSIS >

- The comments of the self-diagnosis results can be viewed with a component in the diagnosis result screen.

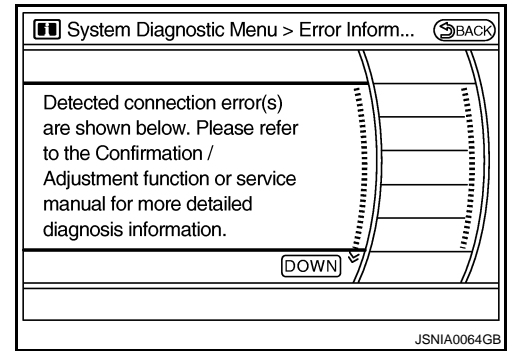

SELF-DIAGNOSIS RESULTS

- The self-diagnosis mode allows the technician to diagnose the connection in the communication line between AV control unit and each unit and the internal operation of the AV control unit.
- Because the start condition of diagnosis function is a switch operation, the on board diagnosis function cannot be started up if any malfunction is detected in the communication circuit between AV control unit and multifunction switch.
- Check the applicable display at the following table, and then repair the malfunctioning parts.

Self-diagnosis Result Chart

Diagnosis results	Detection logic	Possible malfunction location / Action to take
<p>■ : Red</p> <p>NOTE: When a control unit malfunction is detected (red in unit display), connection malfunctions with other connection unit may be displayed.</p> <p>"Self-Diagnosis did not run because of a control unit malfunction"</p>	<p>Malfunction is detected in AV control unit power supply and ground circuits.</p>	<p>Check AV control unit power supply and ground circuits. When detecting no malfunction in those components, replace AV control unit.</p>

DIAGNOSIS SYSTEM (AV CONTROL UNIT)

< FUNCTION DIAGNOSIS >

[BOSE AUDIO WITH NAVIGATION]

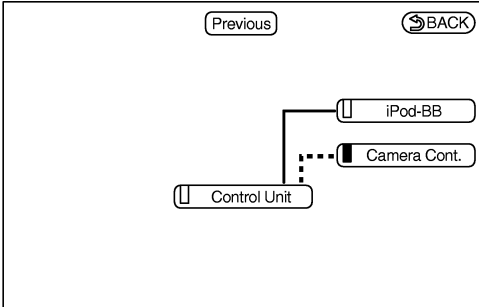
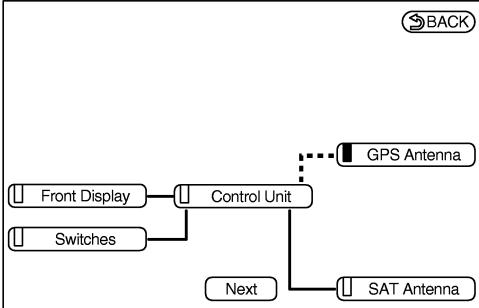
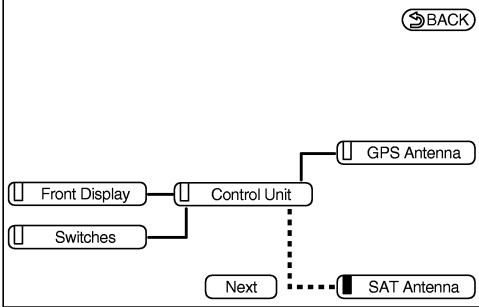
Diagnosis results	Detection logic	Possible malfunction location / Action to take
 <p>■ : Gray - - - - : Yellow</p> <p>JSNIA0596GB</p>	<p>Malfunction is detected in camera-connection recognition signal circuit.</p>	<p>Camera connection recognition signal circuit.</p>
 <p>■ : Gray - - - - : Yellow</p> <p>JSNIA0597GB</p>	<p>GPS antenna connection malfunction is detected.</p>	<p>GPS antenna.</p>
 <p>■ : Gray - - - - : Yellow</p> <p>JSNIA0598GB</p>	<p>Satellite radio antenna connection malfunction is detected.</p>	<ul style="list-style-type: none"> • Satellite radio antenna feeder. • Antenna base.

A
B
C
D
E
F
G
H
I
J
K
L
M
O
P

AV

DIAGNOSIS SYSTEM (AV CONTROL UNIT)

< FUNCTION DIAGNOSIS >

[BOSE AUDIO WITH NAVIGATION]

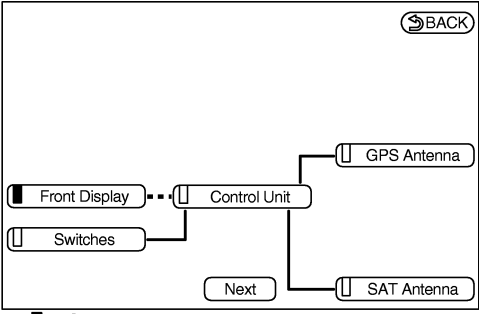
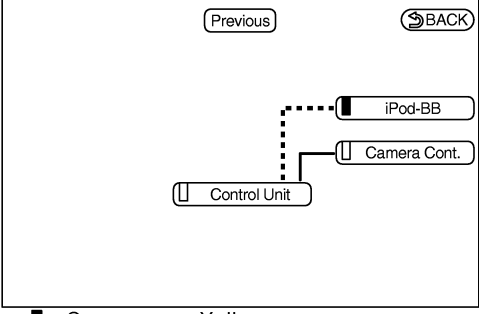
Diagnosis results	Detection logic	Possible malfunction location / Action to take
 <p>■ : Gray - - - : Yellow</p> <p>JSNIA0599GB</p>	<p>When either one of the following items are detected:</p> <ul style="list-style-type: none"> • serial communication circuits between AV control unit and front display unit are malfunctioning. • serial communication signal between AV control unit and front display unit is malfunctioning. 	<p>Serial communication circuits between AV control unit and front display unit.</p>
 <p>■ : Gray - - - : Yellow</p> <p>JSNIA0600GB</p>	<p>When either one of the following items are detected:</p> <ul style="list-style-type: none"> • iPod adapter power supply and ground circuits are malfunctioning. • AV communication circuits between multifunction switch and iPod adapter are malfunctioning. • AV communication signal between AV control unit and iPod adapter is malfunctioning. 	<ul style="list-style-type: none"> • iPod adapter power supply and ground circuits. • AV communication circuits between camera control unit and the junction of AV control unit and multifunction switch. • AV communication circuits between camera control unit and iPod adapter.

NOTE:

The number of units that is displayed on the on board self-diagnosis display according to equipment.

CONFIRMATION/ADJUSTMENT MODE

1. Start the diagnosis function and select "Confirmation/Adjustment". The confirmation/adjustment mode indicates where each item can be checked or adjusted.
2. Select each switch on the "Confirmation/Adjustment Mode" screen to display the relevant trouble diagnosis screen. Press the "BACK" switch to return to the initial Confirmation/Adjustment Mode screen.

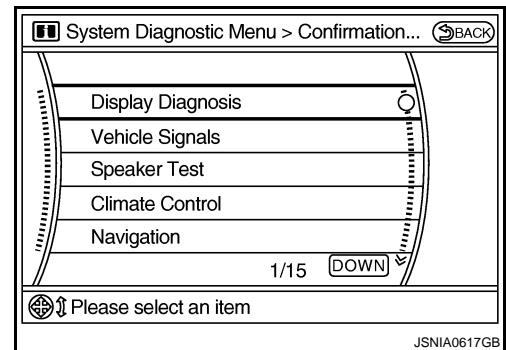

DIAGNOSIS SYSTEM (AV CONTROL UNIT)

< FUNCTION DIAGNOSIS >

[BOSE AUDIO WITH NAVIGATION]

Display Diagnosis

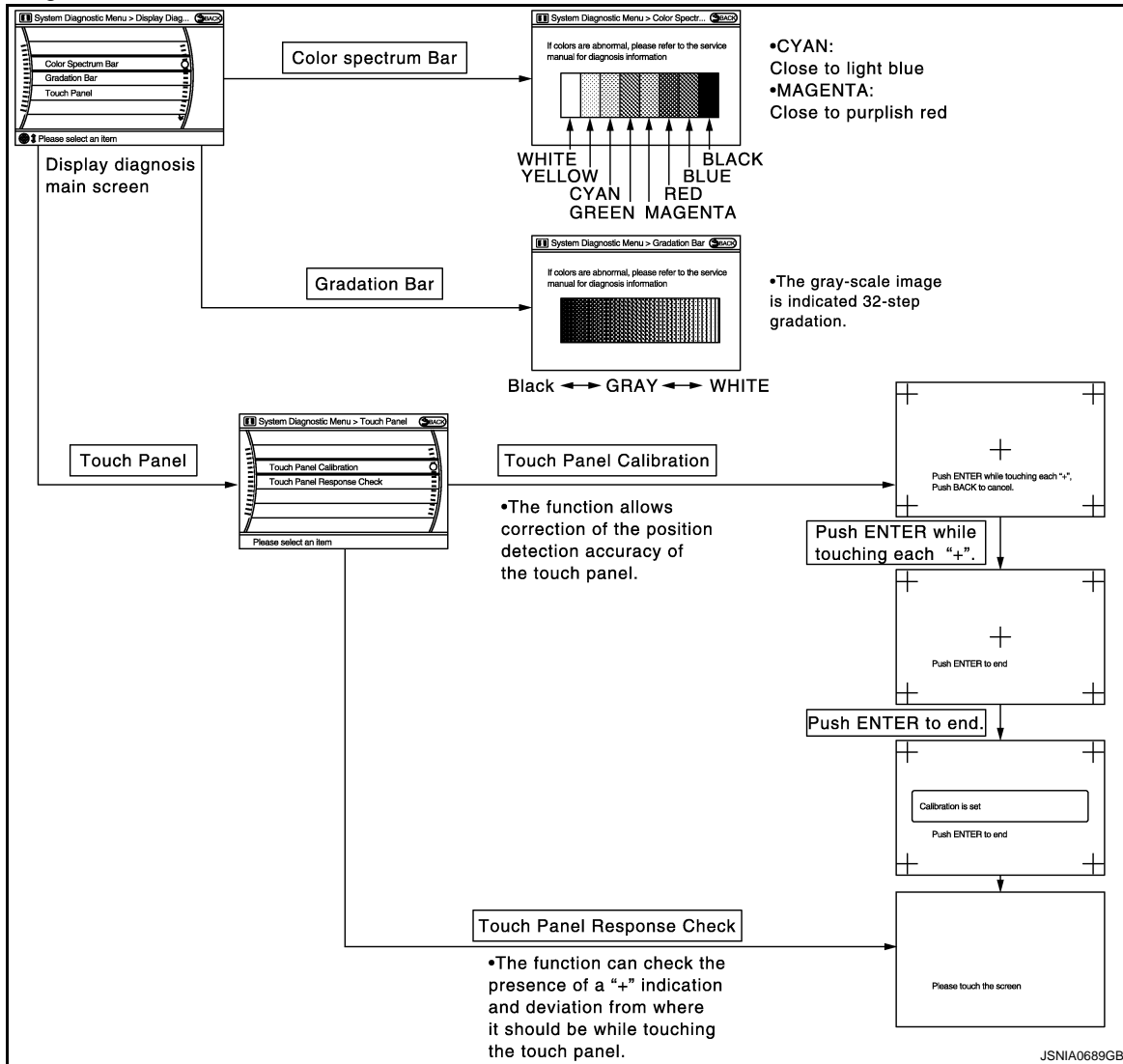

The tint of the color bar indication is as per the following list if RGB signal error is detected.

- R (red) signal error** : Light blue (Cyan) tint
- G (green) signal error** : Purple (Magenta) tint
- B (blue) signal error** : Yellow tint

Vehicle Signals

A comparison check can be made of each actual vehicle signal and the signals recognized by the system.

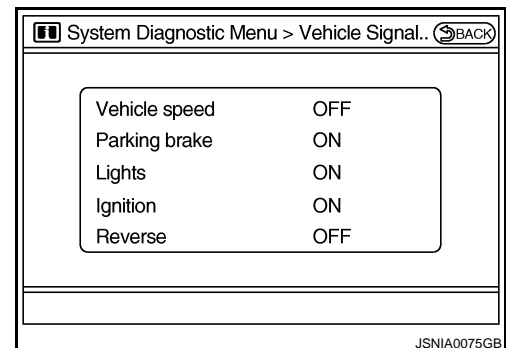

A
B
C
D
E
F
G
H
I
J
K
L
M
O
P

AV

DIAGNOSIS SYSTEM (AV CONTROL UNIT)

< FUNCTION DIAGNOSIS >

[BOSE AUDIO WITH NAVIGATION]

Diagnosis item	Display	Vehicle status	Remarks
Vehicle speed	ON	Vehicle speed > 0 km/h (0 MPH)	Changes in indication may be delayed. This is normal.
	OFF	Vehicle speed = 0 km/h (0 MPH)	
Parking brake	ON	Parking brake is applied.	
	OFF	Parking brake is released.	
Lights	ON	Light switch ON	—
	OFF	Light switch OFF	—
Ignition	ON	Ignition switch ON	—
	OFF	Ignition switch in the ACC position	—
Reverse	ON	Shift the selector lever to the "R" position	Changes in indication may be delayed. This is normal.
	OFF	Shift the selector lever to a position other than the "R" position	

Speaker Test

Select "SPEAKER DIAGNOSIS" to display the Speaker Diagnosis screen. Press "START and NEXT" to generate a test tone in a speaker. Press "Start" to generate a test tone in the next speaker. Press "End" to stop the test tones.

NOTE:

The frequency of test tone emitted from each speaker is as follows.

Tweeter	: 3 kHz
Front speaker	: 300 Hz
Rear speaker	: 1 kHz

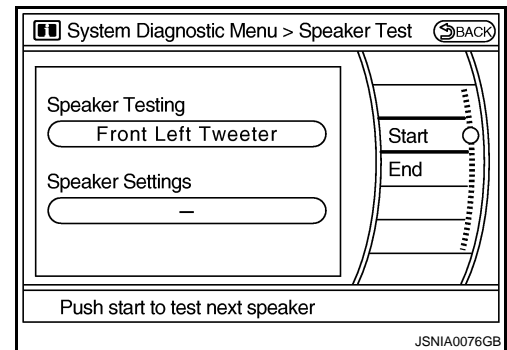

Climate Control

On-board self-diagnosis is not supported. Only CONSULT-III is supported. Refer to [HAC-157, "CONSULT-III Function"](#) [with 7 inch display].

Navigation

STEERING ANGLE ADJUSTMENT

The steering angle output value detected with the gyroscope is adjusted.

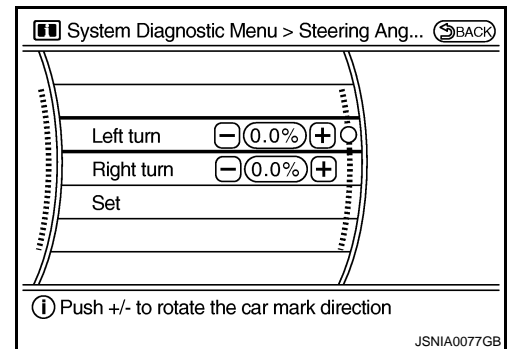

SPEED CALIBRATION

DIAGNOSIS SYSTEM (AV CONTROL UNIT)

< FUNCTION DIAGNOSIS >

[BOSE AUDIO WITH NAVIGATION]

During normal driving, distance error caused by tire wear and tire pressure change is automatically adjusted for by the automatic distance correction function. This function, on the other hand, is for immediate adjustment, in cases such as driving with tire chain fitted on tires.

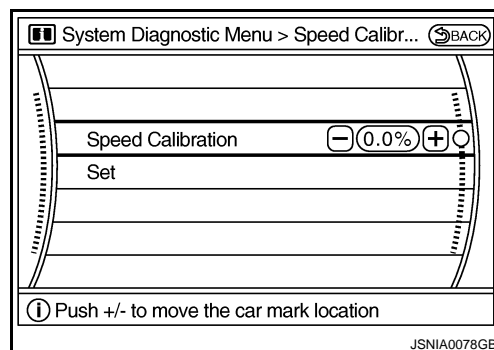

XM SAT SUBSCRIPTION STATUS

The XM NavTraffic subscription status can be checked.

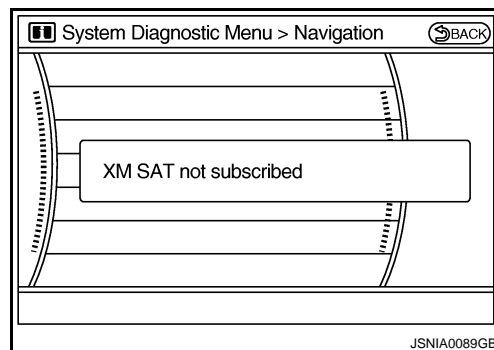

Error History

The self-diagnosis results are judged depending on whether any error occurs from when "Self-diagnosis" is selected until the self-diagnosis results are displayed.

However, the diagnosis results are judged normal if an error has occurred before the ignition switch is turned ON and then no error has occurred until the self-diagnosis start. Check the "Error Record" to detect any error that may have occurred before the self-diagnosis start because of this situation.

The error record displays the time and place of the most recent occurrence of that error. However, take note of the following points.

- If there is a malfunction with the GPS antenna circuit board in the AV control unit, the correct date and time of occurrence may not be able to be displayed.
- Place of the error occurrence is represented by the position of the current location mark at the time the error occurred. If the current location mark has deviated from the correct position, then the place of the error occurrence cannot be correctly located.
- The frequency of occurrence is displayed in a count up manner. The actual count up method differs depending on the error item.

Count up method A

- The counter resets to 0 if an error occurs when IGN switch is turned ON. The counter increases by 1 if the condition is normal at a next IGN ON cycle.
- The counter upper limit is 39. Any counts exceeding 39 are ignored. The counter can be reset (no error record display) with the "Delete log" switch or CONSULT-III.

Count up method B

- The counter increases by 1 if an error occurs when IGN switched is ON. The counter will not decrease even if the status is normal at the next IGN ON cycle.
- The counter upper limit is 50. Any counts exceeding 50 are ignored. The counter can be reset (no error record display) with the "Delete log" switch or CONSULT-III.

Display type of occurrence frequency	Error history display item
Count up method A	CAN communication line, control unit (CAN), AV communication line, control unit (AV communication)
Count up method B	Other than the above

DIAGNOSIS SYSTEM (AV CONTROL UNIT)

< FUNCTION DIAGNOSIS >

[BOSE AUDIO WITH NAVIGATION]

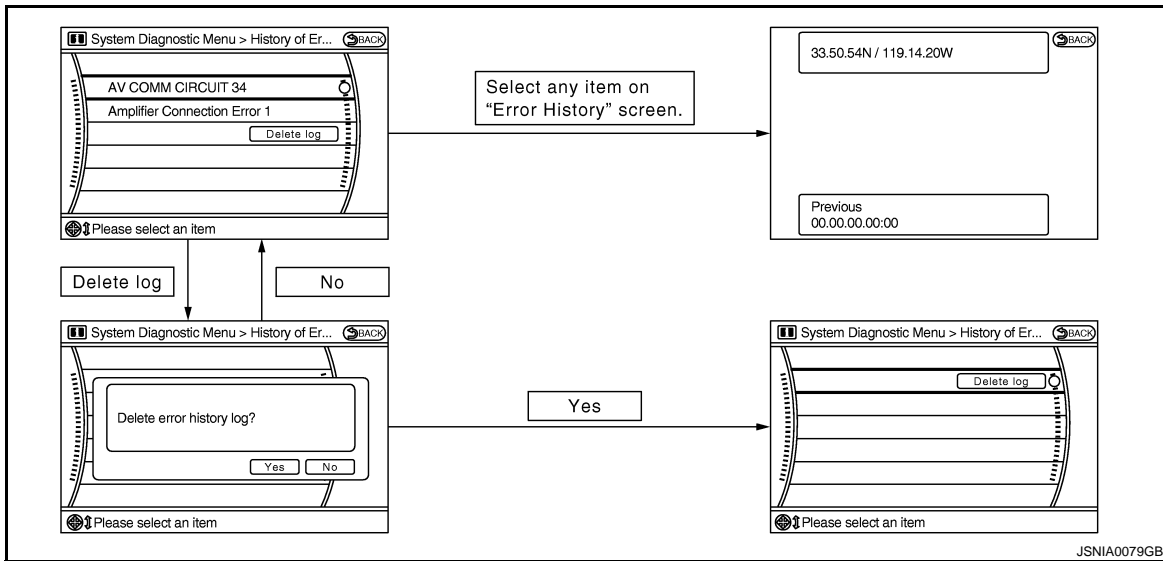

Error item

Some error items may be displayed simultaneously according to the cause. If some error items are displayed simultaneously, the detection of the cause can be performed by the combination of display items

Error item	Description	Possible malfunction factor/Action to take
CAN COMM CIRCUIT	CAN communication malfunction is detected.	Perform diagnosis with CONSULT-III, and then repair the malfunctioning parts according to the diagnosis results. Refer to AV-589, "CONSULT-III Function (MULTI AV)" .
CONTROL UNIT (CAN)	CAN initial diagnosis malfunction is detected.	Replace the AV control unit.
CONTROL UNIT (AV)	AV communication circuit initial diagnosis malfunction is detected.	
FLASH-ROM Error Of Control Unit	AV control unit malfunction is detected.	
Connection Of Gyro		
XM SERIAL COMM Error		
CAN Controller Memory Error		
Bluetooth Module Connection Error		
HDD CONN Error		
HDD READ Error		
HDD WRITE Error		
HDD COMM Error		
HDD ACCESS Error		
DSP CONN Error		
DSP COMM Error		
Internal Communication Error	Malfunction is detected in AV control unit power supply and ground circuits.	Check AV control unit power supply and ground circuits. When detecting no malfunction in those components, replace AV control unit.
GPS Communication Error	GPS malfunction is detected.	An intermittent error caused by strong radio interference may be detected unless a symptom (GPS reception error, etc.) occurs. Replace the AV control unit if the malfunction occurs constantly.
GPS ROM Error		
GPS RAM Error		
GPS RTC Error		

DIAGNOSIS SYSTEM (AV CONTROL UNIT)

< FUNCTION DIAGNOSIS >

[BOSE AUDIO WITH NAVIGATION]

Error item	Description	Possible malfunction factor/Action to take
Front Display Connection Error	When either one of the following items are detected: <ul style="list-style-type: none"> • front display unit power supply and ground circuits are malfunctioning. • serial communication circuits between AV control unit and front display unit are malfunctioning. • serial communication signal between AV control unit and front display unit is malfunctioning. 	<ul style="list-style-type: none"> • Front display unit power supply and ground circuits. • Serial communication circuits between AV control unit and display unit.
GPS Antenna Error	GPS antenna connection malfunction is detected.	GPS antenna.
Camera Control Unit Connection Error	Malfunction is detected in camera connection recognition circuit between AV control unit and camera control unit.	Camera-connection recognition circuit between AV control unit and camera control unit.
XM Antenna Connection Error	Satellite radio antenna connection malfunction is detected.	<ul style="list-style-type: none"> • Satellite radio antenna feeder. • Antenna base.
<ul style="list-style-type: none"> • AV COMM CIRCUIT • Internal Communication Error 	Malfunction is detected in AV control unit power supply and ground circuits.	Check AV control unit power supply and ground circuits. When detecting no malfunction in those components, replace AV control unit.
<ul style="list-style-type: none"> • AV COMM CIRCUIT • Switches Connection Error 	When either one of the following items are detected: <ul style="list-style-type: none"> • multifunction switch power supply and ground circuits are malfunctioning. • AV communication circuits between AV control unit and multifunction switch are malfunctioning. • AV communication signal between AV control unit and multifunction switch is malfunctioning. 	<ul style="list-style-type: none"> • Multifunction switch power supply and ground circuits. • AV communication circuits between AV control unit and multifunction switch.
<ul style="list-style-type: none"> • AV COMM CIRCUIT • Rearview Camera Connection Error 	When either one of the following items are detected: <ul style="list-style-type: none"> • camera control unit power supply and ground circuits are malfunctioning. • AV communication circuits between multifunction switch and camera control unit is malfunctioning. • AV communication signal between AV control unit and camera control unit is malfunctioning. 	<ul style="list-style-type: none"> • Camera control unit power supply and ground circuits. • AV communication circuits between multifunction switch and camera control unit.
<ul style="list-style-type: none"> • AV COMM CIRCUIT • iPod Connection Error 	When either one of the following items are detected: <ul style="list-style-type: none"> • iPod adapter power supply and ground circuits are malfunctioning. • AV communication circuits between multifunction switch and iPod adapter are malfunctioning. • AV communication signal between AV control unit and iPod adapter is malfunctioning. 	<ul style="list-style-type: none"> • iPod adapter power supply and ground circuits. • AV communication circuits between multifunction switch unit and iPod adapter.
<ul style="list-style-type: none"> • AV COMM CIRCUIT • Rearview Camera Connection Error • iPod Connection Error* 	Malfunction is detected in AV communication circuits between camera control unit and the junction of AV control unit and multifunction switch.	AV communication circuits between camera control unit and the junction of AV control unit and multifunction switch.

A
B
C
D
E
F
G
H
I
J
K
L
M
O
P



DIAGNOSIS SYSTEM (AV CONTROL UNIT)

< FUNCTION DIAGNOSIS >

[BOSE AUDIO WITH NAVIGATION]

Error item	Description	Possible malfunction factor/Action to take
<ul style="list-style-type: none"> • AV COMM CIRCUIT • Switches Connection Error • Rearview Camera Connection Error • iPod Connection Error* 	Malfunction is detected in AV communication circuits between AV control unit and multifunction switch.	AV communication circuits between AV control unit and the junction of camera control unit and multifunction switch.
<ul style="list-style-type: none"> • AV COMM CIRCUIT • Internal Communication Error • Switches Connection Error • Rearview Camera Connection Error • iPod Connection Error* 	Malfunction is detected in AV communication circuits.	Check and repair the short circuit in AV communication circuits.

NOTE:

*: Non-equipped item is not displayed.

Vehicle CAN Diagnosis

- CAN communication status and error counter is displayed.
- The error counter displays “OK” if any malfunction was not detected in the past and displays “0” if a malfunction is detected. It increases by 1 if the status is normal at the next ignition switch ON cycle. The upper limit of the counter is 39.
- The error counter is erased if “Reset” is pressed.

Items	Display (Current)	Malfunction counter (Past)
Tx (HVAC)	OK / UNKWN	OK / 0 – 39
Rx (ECM)	OK / UNKWN	OK / 0 – 39
Rx (Cluster)	OK / UNKWN	OK / 0 – 39
Rx (BCM)	OK / UNKWN	OK / 0 – 39
Rx (HVAC)	OK / UNKWN	OK / 0 – 39
Rx (USM)	OK / UNKWN	OK / 0 – 39

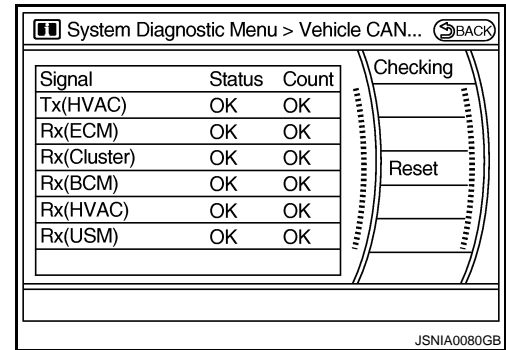

AV COMM Diagnosis

- Displays the communication status between AV control unit (master unit) and each unit.
- The error counter displays “OK” if any malfunction was not detected in the past and displays “0” if a malfunction is detected. It increases by 1 if the condition is normal at the next ignition switch ON cycle. The upper limit of the counter is 39.
- The error counter is erased if “Reset” is pressed.

Items	Status (Current)	Counter (Past)
C Tx(ITM-PrimarySW)	OK / UNKWN	OK / 0 – 39
C Rx(PrimarySW-ITM)	OK / UNKWN	OK / 0 – 39
C Rx(STRG SW-ITM)	OK / UNKWN	OK / 0 – 39
C Rx (Audio-ITM)	OK / UNKWN	OK / 0 – 39
C Rx(Amp-ITM)	OK / UNKWN	OK / 0 – 39
C Rx(RearCamera-ITM)	OK / UNKWN	OK / 0 – 39
C Rx(XM-ITM)	OK / UNKWN	OK / 0 – 39
C Rx(iPod-ITM)	OK / UNKWN	OK / 0 – 39
C Rx(Amp-Audio)	—	—
C Rx(iPod-Audio)	OK / UNKWN	OK / 0 – 39
C Tx(Audio-ITM)	OK / UNKWN	OK / 0 – 39

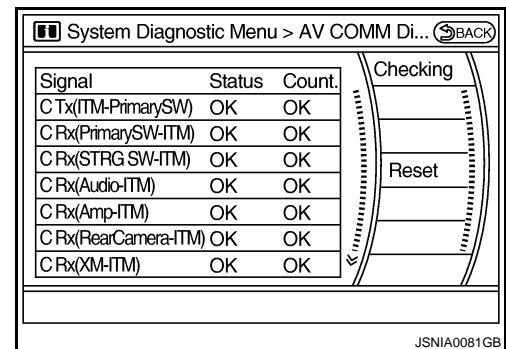

NOTE:

- Any units with “—” displayed have no history of vehicle connection.

DIAGNOSIS SYSTEM (AV CONTROL UNIT)

[BOSE AUDIO WITH NAVIGATION]

< FUNCTION DIAGNOSIS >

- “Audio” and “Amp” indicate the same status because “Amp” indicates the status of the amplifier integrated in the AV control unit.
- “STRG SW”, “Amp”“XM” indicate the same status as “Audio”.

Hands-Free Phone

The hands-free phone reception volume adjustment, microphone and speaker test, and memory erase functions are also available.

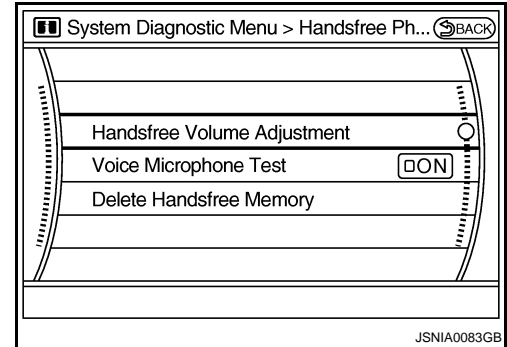

Camera Cont.

The two functions of “Connection Confirmation” and “Adjust Offset of Rear View Camera” are available.

CONNECTION CONFIRMATION

The steering angle sensor, reverse signal and vehicle speed sensor can be inspected.

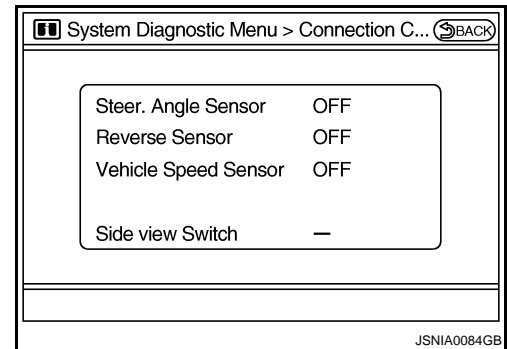

Diagnosis item	Display	Vehicle status
Steer. Angle Sensor	ON	When steering the vehicle with ignition switch ON (remains ON until connection mode is stopped when it is turned ON)
	OFF	<ul style="list-style-type: none"> • Ignition switch at ACC • No steering with ignition switch ON
	—	Malfunction detected in camera connection recognition signal
Reverse Sensor	ON	Selector lever is in “R” with ignition switch ON.
	OFF	<ul style="list-style-type: none"> • Ignition switch at ACC • Selector lever is in position other than “R” with ignition switch ON.
	—	Malfunction detected in camera-connection recognition signal
Vehicle Speed Sensor	ON	Vehicle speed is more than 0 km/h (0 MPH) with ignition switch ON
	OFF	<ul style="list-style-type: none"> • Ignition switch at ACC • Vehicle speed is 0 km/h (0 MPH) with ignition switch ON
	—	Malfunction detected in camera connection recognition signal
Side view Switch	—	Not used

ADJUST OFFSET OF REAR VIEW CAMERA

A
B
C
D
E
F
G
H
I
J
K
L
M
AV
O
P

DIAGNOSIS SYSTEM (AV CONTROL UNIT)

< FUNCTION DIAGNOSIS >

[BOSE AUDIO WITH NAVIGATION]

Use this mode to adjust the guide line display position of the rear-view monitor if necessary after removing the rear view monitor camera.

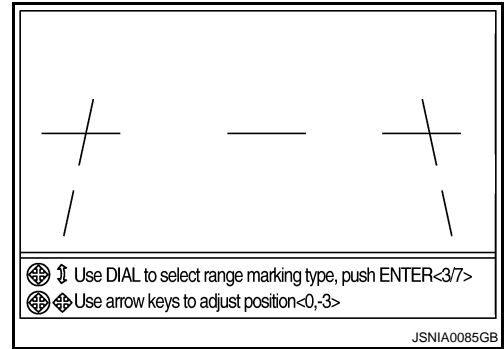

Bluetooth

Confirm / Change Passkey

- The Bluetooth passkey can be confirmed and changed.
- The passkey can be changed by four digits within 0 to 9.

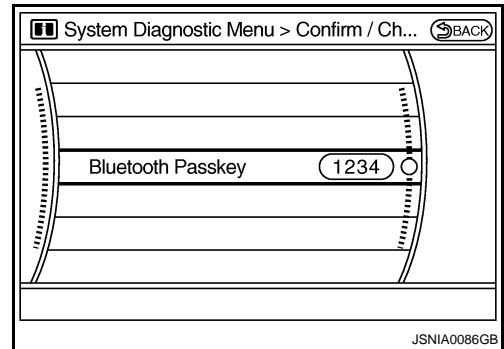

Confirm / Change Device Name

- The Bluetooth device name can be confirmed and changed.
- The device name can be changed by sixteen digits from A to Z (small characters can be used) and "-" (hyphens).

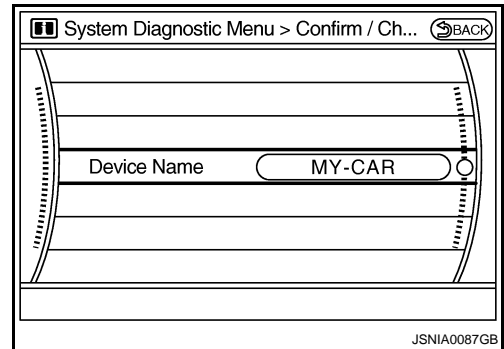

SAT

Change Channel

- Any necessary channels required to receive traffic information from the satellite radio system can be set.

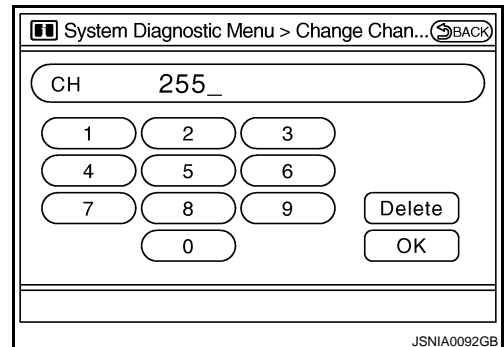

DIAGNOSIS SYSTEM (AV CONTROL UNIT)

< FUNCTION DIAGNOSIS >

[BOSE AUDIO WITH NAVIGATION]

- Change Application ID
- Any application ID's required to receive traffic information from the satellite radio system can be set.

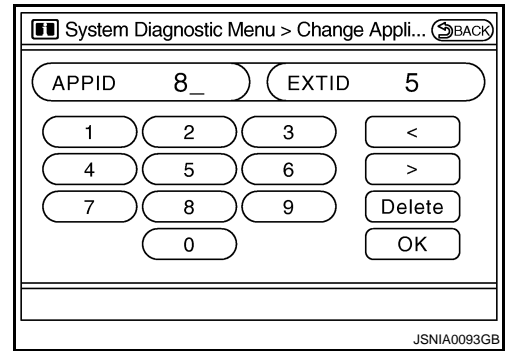

Delete Unit Connection Log

Deletes any unit connection records and error records from the AV control unit memory. (Clear the records of the unit that has been removed.)

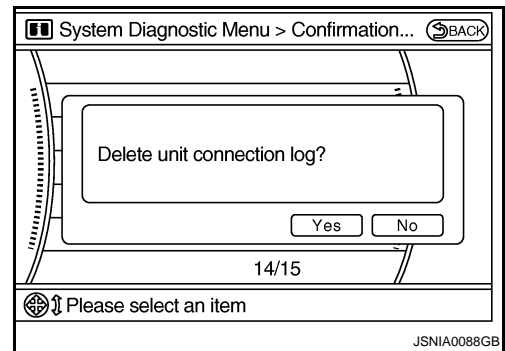

Initialize Settings

Deletes data stored in HDD.

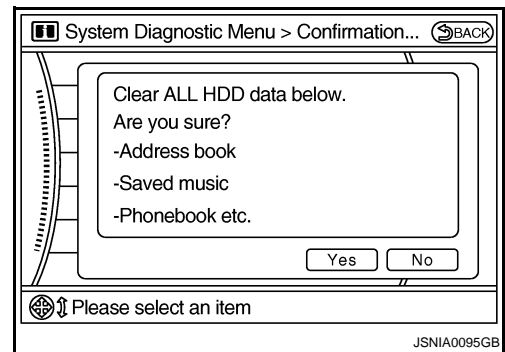

CONSULT-III Function (MULTI AV)

INFOID:000000003356565

CONSULT-III FUNCTIONS

CONSULT-III performs the following functions via the communication with the AV control unit.

Diagnosis mode	Description
Ecu Identification	The part number of AV control unit can be checked.
Self Diagnostic Result	Performs a diagnosis on the AV control unit and a connection diagnosis for the communication circuit of the MULTI AV system, and displays the current and past malfunctions collectively.
Data Monitor	The diagnosis of vehicle signal that is input to the AV control unit can be performed.

AV COMMUNICATION

When "AV communication" of "CAN Diag Support Monitor" is selected, the following function will be performed.

AV communication	AV&NAVI C/U	Displays the communication status from AV control unit to each unit as well as the error counter.
	AUDIO	Displays the AV control unit communication status and the error counter.

ECU IDENTIFICATION

The part number of AV control unit is displayed.

DIAGNOSIS SYSTEM (AV CONTROL UNIT)

[BOSE AUDIO WITH NAVIGATION]

< FUNCTION DIAGNOSIS >

SELF DIAGNOSIS RESULT

- In CONSULT-III self-diagnosis, self-diagnosis results and error history are displayed collectively.
- A current malfunction indicates “crnt”. a past malfunction indicates “past”.
- The timing is displayed as “0” if any of the error codes [U1000], [U1010], [U1300] and [U1310] is detected. the counter increases by 1 if the status is normal at the next ignition switch on cycle.

Self-diagnosis Results Display Item

Error item	Description	Possible malfunction factor/Action to take	
CAN COMM CIRCUIT [U1000]	CAN communication malfunction is detected.	Refer to AV-593, "Diagnosis Procedure" .	
CONTROL UNIT (CAN) [U1010]	CAN initial diagnosis malfunction is detected.	Replace the AV control unit.	
CONTROL UNIT (AV) [U1310]	AV communication circuit initial diagnosis malfunction is detected.		
Control Unit FLASH-ROM [U1200]	AV control unit malfunction is detected.		
Gyro NO CONN [U1201]			
CAN CONT [U1216]			
BLUETOOTH CONN [U1217]			
HDD CONN [U1218]			
HDD READ [U1219]			
XM SERIAL COMM [U1220]			
HDD WRITE [U121A]			
HDD COMM [U121B]			
HDD ACCESS [U121C]			
DSP CONN [U121D]			
DSP COMM [U121E]			
INTERNAL COMM [U121F]		Malfunction is detected in AV control unit power supply and ground circuits.	Check AV control unit power supply and ground circuits. When detecting no malfunction in those components, replace AV control unit.
GPS COMM [U1204]		GPS malfunction is detected.	An intermittent error caused by strong radio interference may be detected unless a symptom (GPS reception error, etc.) occurs. Replace the AV control unit if the malfunction occurs constantly.
GPS ROM [U1205]			
GPS RAM [U1206]			
GPS RTC [U1207]			
FRONT DISP CONN [U1243]	When either one of the following items are detected: <ul style="list-style-type: none"> • front display unit power supply and ground circuits are malfunctioning. • serial communication circuits between AV control unit and front display unit are malfunctioning. • serial communication signal between AV control unit and front display unit is malfunctioning. 	<ul style="list-style-type: none"> • Front display unit power supply and ground circuits. • Serial communication circuits between AV control unit and display unit. 	
GPS ANTENNA CONN [U1244]	GPS antenna connection malfunction is detected.	GPS antenna.	
CAMERA CONT CONN [U1250]	Malfunction is detected in camera connection recognition circuit between AV control unit and camera control unit.	Camera-connection recognition circuit between AV control unit and camera control unit.	
XM ANTENNA CONN [U1258]	Satellite radio antenna connection malfunction is detected.	<ul style="list-style-type: none"> • Satellite radio antenna feeder. • Antenna base. 	

DIAGNOSIS SYSTEM (AV CONTROL UNIT)

< FUNCTION DIAGNOSIS >

[BOSE AUDIO WITH NAVIGATION]

Error item	Description	Possible malfunction factor/Action to take
<ul style="list-style-type: none"> • AV COMM CIRCUIT [U1300] • INTERNAL COMM [U121F] 	Malfunction is detected in AV control unit power supply and ground circuits.	Check AV control unit power supply and ground circuits. When detecting no malfunction in those components, replace AV control unit.
<ul style="list-style-type: none"> • AV COMM CIRCUIT [U1300] • SWITCH CONN [U1240] 	When either one of the following items are detected: <ul style="list-style-type: none"> • multifunction switch power supply and ground circuits are malfunctioning. • AV communication circuits between AV control unit and multifunction switch are malfunctioning. • AV communication signal between AV control unit and multifunction switch is malfunctioning. 	<ul style="list-style-type: none"> • Multifunction switch power supply and ground circuits. • AV communication circuits between AV control unit and multifunction switch.
<ul style="list-style-type: none"> • AV COMM CIRCUIT [U1300] • REAR CAMERA LAN CONN [U1252] 	When either one of the following items are detected: <ul style="list-style-type: none"> • camera control unit power supply and ground circuits are malfunctioning. • AV communication circuits between multifunction switch and camera control unit is malfunctioning. • AV communication signal between AV control unit and camera control unit is malfunctioning. 	<ul style="list-style-type: none"> • Camera control unit power supply and ground circuits. • AV communication circuits between multifunction switch and camera control unit.
<ul style="list-style-type: none"> • AV COMM CIRCUIT [U1300] • iPod CONN [U1254] 	When either one of the following items are detected: <ul style="list-style-type: none"> • iPod adapter power supply and ground circuits are malfunctioning. • AV communication circuits between multifunction switch and iPod adapter are malfunctioning. • AV communication signal between AV control unit and iPod adapter is malfunctioning. 	<ul style="list-style-type: none"> • iPod adapter power supply and ground circuits. • AV communication circuits between multifunction switch unit and iPod adapter.
<ul style="list-style-type: none"> • AV COMM CIRCUIT [U1300] • REAR CAMERA LAN CONN [U1252] • iPod CONN [U1254]* 	Malfunction is detected in AV communication circuits between camera control unit and the junction of AV control unit and multifunction switch.	AV communication circuits between camera control unit and the junction of AV control unit and multifunction switch.
<ul style="list-style-type: none"> • AV COMM CIRCUIT [U1300] • SWITCH CONN [U1240] • REAR CAMERA LAN CONN [U1252] • iPod CONN [U1254]* 	Malfunction is detected in AV communication circuits between AV control unit and multifunction switch.	AV communication circuits between AV control unit and the junction of camera control unit and multifunction switch.
<ul style="list-style-type: none"> • AV COMM CIRCUIT [U1300] • INTERNAL COMM [U121F] • SWITCH CONN [U1240] • REAR CAMERA LAN CONN [U1252] • iPod CONN [U1254]* 	Malfunction is detected in AV communication circuits.	Check and repair the short circuit in AV communication circuits.

NOTE:

*: Non-equipped item is not displayed.

DATA MONITOR

All Signals

- Displays the status of the following vehicle signals inputted into the AV control unit.
- For each signal, the actual signal can be compared with the status recognized on the system.

A
B
C
D
E
F
G
H
I
J
K
L
M
AV

DIAGNOSIS SYSTEM (AV CONTROL UNIT)

< FUNCTION DIAGNOSIS >

[BOSE AUDIO WITH NAVIGATION]

Display Item	Display	Vehicle status	Remarks	
VHCL SPD SIG	On	Vehicle speed >0 km/h (0 MPH)	Changes in indication may be delayed. This is normal.	
	Off	Vehicle speed =0 km/h (0 MPH)		
PKB SIG	On	Parking brake is applied.		
	Off	Parking brake is released.		
ILLUM SIG	On	Block the light beam from the auto light optical sensor when the light SW is ON.	—	
	Off	Expose the auto light optical sensor to light when the light SW is OFF or ON.		
IGN SIG	On	Ignition switch ON		
	Off	Ignition switch in the ACC position		
REV SIG	On	Selector lever in the "R" position		Changes in indication may be delayed. This is normal.
	Off	Selector lever in any position other than the "R" position		

Selection From Menu

allows the technician to select which vehicle signals should be displayed and displays the status of the selected vehicle signals.

Item to be selected	Description
VHCL SPD SIG	The same as when "ALL SIGNALS" is selected.
PKB SIG	
ILLUM SIG	
IGN SIG	
REV SIG	

COMPONENT DIAGNOSIS

U1000 CAN COMM CIRCUIT

Description

INFOID:000000003356566

CAN (Controller Area Network) is a serial communication line for real-time application. It is an on-vehicle multiplex communication line with high data communication speed and excellent error detection ability. Many electronic control units are equipped onto a vehicle, and each control unit shares information and links with other control units during operation (not independently). In CAN communication, control units are connected with 2 communication lines (CAN-H, CAN-L) allowing a high rate of information transmission with less wiring. Each control unit transmits/receives data but selectively reads required data only.

CAN Communication Signal Chart. Refer to [LAN-25, "CAN Communication Signal Chart"](#).

DTC Logic

INFOID:000000003356567

DTC DETECTION LOGIC

DTC	Display contents of CONSULT-III	Diagnostic item is detected when...	Probable malfunction location
U1000	CAN COMM CIRCUIT	AV control unit is not transmitting or receiving CAN communication signal for 2 seconds or more.	CAN communication system.

Diagnosis Procedure

INFOID:000000003356568

1. PERFORM SELF-DIAGNOSTIC

- Turn ignition switch ON and wait for 2 seconds or more.
- Check "Self Diagnostic Result" of "MULTI AV".

Is "CAN COMM CIRCUIT" displayed?

- YES >> Refer to "LAN system". Refer to [LAN-16, "Trouble Diagnosis Flow Chart"](#).
- NO >> Refer to GI section. Refer to [GI-40, "Intermittent Incident"](#).

AV

U1010 CONTROL UNIT (CAN)

< COMPONENT DIAGNOSIS >

[BOSE AUDIO WITH NAVIGATION]

U1010 CONTROL UNIT (CAN)

Description

INFOID:000000003356569

Initial diagnosis of AV control unit.

DTC Logic

INFOID:000000003356570

DTC DETECTION LOGIC

DTC	Display contents of CONSULT-III	Diagnostic item is detected when...	Probable malfunction location
U1010	CONTROL UNIT (CAN)	CAN initial diagnosis malfunction is detected.	AV control unit.

Diagnosis Procedure

INFOID:000000003356571

1. REPLACE AV CONTROL UNIT

When DTC U1010 is detected, replace AV control unit.

>> INSPECTION END

U1310 AV CONTROL UNIT

< COMPONENT DIAGNOSIS >

[BOSE AUDIO WITH NAVIGATION]

U1310 AV CONTROL UNIT

Description

INFOID:000000003356572

Replace the AV control unit if this DTC is displayed. Refer to [AV-764, "Exploded View"](#).

Part name	Description
AV CONTROL UNIT	<ul style="list-style-type: none">• Integrates hard disk drive (HDD) allowing map data and music data to be stored.• It is the master unit of the MULTI AV system, and it is connected to each control unit by communication. It operates each system according to communication signals from the AV control unit.• The AV control unit includes the audio, hands-free phone, voice control, navigation, satellite radio, and vehicle information functions.• It is connected to ECM, A/C auto amp. and combination meter via CAN communication to obtain necessary information for the vehicle information function.• It is connected to BCM via CAN communication transmitting/receiving for the vehicle settings function.• It inputs the illumination signals that are required for the display dimming control.• It inputs the signals for driving status recognition (vehicle speed, reverse and parking brake).• Update of map data is performed with the CONSULT-III and the applicable cable.• It includes the TEL adapter and Bluetooth™ function.

DTC Logic

INFOID:000000003356573

DTC	Display contents of CONSULT-III	DTC Detection Condition	Action to take
U1310	CONTROL UNIT (AV) [U1310]	An initial diagnosis error is detected in AV communication circuit.	Replace AV control unit.

A
B
C
D
E
F
G
H
I
J
K
L
M

AV

O
P

U1200 AV CONTROL UNIT

< COMPONENT DIAGNOSIS >

[BOSE AUDIO WITH NAVIGATION]

U1200 AV CONTROL UNIT

Description

INFOID:000000003356574

Replace the AV control unit if this DTC is displayed. Refer to [AV-764, "Exploded View"](#).

Part name	Description
AV CONTROL UNIT	<ul style="list-style-type: none">• Integrates hard disk drive (HDD) allowing map data and music data to be stored.• It is the master unit of the MULTI AV system, and it is connected to each control unit by communication. It operates each system according to communication signals from the AV control unit.• The AV control unit includes the audio, hands-free phone, voice control, navigation, satellite radio, and vehicle information functions.• It is connected to ECM, A/C auto amp. and combination meter via CAN communication to obtain necessary information for the vehicle information function.• It is connected to BCM via CAN communication transmitting/receiving for the vehicle settings function.• It inputs the illumination signals that are required for the display dimming control.• It inputs the signals for driving status recognition (vehicle speed, reverse and parking brake).• Update of map data is performed with the CONSULT-III and the applicable cable.• It includes the TEL adapter and Bluetooth™ function.

DTC Logic

INFOID:000000003356575

DTC	Display contents of CONSULT-III	DTC Detection Condition	Action to take
U1200	Cont Unit FLASH-ROM [U1200]	An internal malfunction is detected in AV control unit (FLASH-ROM).	Replace AV control unit.

U1201 AV CONTROL UNIT

< COMPONENT DIAGNOSIS >

[BOSE AUDIO WITH NAVIGATION]

U1201 AV CONTROL UNIT

Description

INFOID:000000003356576

Replace the AV control unit if this DTC is displayed. Refer to [AV-764, "Exploded View"](#).

Part name	Description
AV CONTROL UNIT	<ul style="list-style-type: none"> Integrates hard disk drive (HDD) allowing map data and music data to be stored. It is the master unit of the MULTI AV system, and it is connected to each control unit by communication. It operates each system according to communication signals from the AV control unit. The AV control unit includes the audio, hands-free phone, voice control, navigation, satellite radio, and vehicle information functions. It is connected to ECM, A/C auto amp. and combination meter via CAN communication to obtain necessary information for the vehicle information function. It is connected to BCM via CAN communication transmitting/receiving for the vehicle settings function. It inputs the illumination signals that are required for the display dimming control. It inputs the signals for driving status recognition (vehicle speed, reverse and parking brake). Update of map data is performed with the CONSULT-III and the applicable cable. It includes the TEL adapter and Bluetooth™ function.

DTC Logic

INFOID:000000003356577

DTC	Display contents of CONSULT-III	DTC Detection Condition	Action to take
U1201	GYRO NO CONN [U1201]	Internal malfunction of AV control unit (gyrocompass disconnection) is detected.	Replace AV control unit.

A
B
C
D
E
F
G
H
I
J
K
L
M

AV

O
P

U1216 AV CONTROL UNIT

< COMPONENT DIAGNOSIS >

[BOSE AUDIO WITH NAVIGATION]

U1216 AV CONTROL UNIT

Description

INFOID:000000003356578

Replace the AV control unit if this DTC is displayed. Refer to [AV-764, "Exploded View"](#).

Part name	Description
AV CONTROL UNIT	<ul style="list-style-type: none">• Integrates hard disk drive (HDD) allowing map data and music data to be stored.• It is the master unit of the MULTI AV system, and it is connected to each control unit by communication. It operates each system according to communication signals from the AV control unit.• The AV control unit includes the audio, hands-free phone, voice control, navigation, satellite radio, and vehicle information functions.• It is connected to ECM, A/C auto amp. and combination meter via CAN communication to obtain necessary information for the vehicle information function.• It is connected to BCM via CAN communication transmitting/receiving for the vehicle settings function.• It inputs the illumination signals that are required for the display dimming control.• It inputs the signals for driving status recognition (vehicle speed, reverse and parking brake).• Update of map data is performed with the CONSULT-III and the applicable cable.• It includes the TEL adapter and Bluetooth™ function.

DTC Logic

INFOID:000000003356579

DTC	Display contents of CONSULT-III	DTC Detection Condition	Action to take
U1216	CAN CONT [U1216]	Internal malfunction of AV control unit (CAN controller) is detected.	Replace AV control unit.

U1217 AV CONTROL UNIT

< COMPONENT DIAGNOSIS >

[BOSE AUDIO WITH NAVIGATION]

U1217 AV CONTROL UNIT

Description

INFOID:000000003356580

Replace the AV control unit if this DTC is displayed. Refer to [AV-764, "Exploded View"](#).

Part name	Description
AV CONTROL UNIT	<ul style="list-style-type: none"> Integrates hard disk drive (HDD) allowing map data and music data to be stored. It is the master unit of the MULTI AV system, and it is connected to each control unit by communication. It operates each system according to communication signals from the AV control unit. The AV control unit includes the audio, hands-free phone, voice control, navigation, satellite radio, and vehicle information functions. It is connected to ECM, A/C auto amp. and combination meter via CAN communication to obtain necessary information for the vehicle information function. It is connected to BCM via CAN communication transmitting/receiving for the vehicle settings function. It inputs the illumination signals that are required for the display dimming control. It inputs the signals for driving status recognition (vehicle speed, reverse and parking brake). Update of map data is performed with the CONSULT-III and the applicable cable. It includes the TEL adapter and Bluetooth™ function.

DTC Logic

INFOID:000000003356581

DTC	Display contents of CONSULT-III	DTC Detection Condition	Action to take
U1217	BLUETOOTH MODULE CONN [U1217]	Internal malfunction of AV control unit (Bluetooth module connection malfunction) is detected.	Replace AV control unit.

A
B
C
D
E
F
G
H
I
J
K
L
M

AV

O
P

U1218 AV CONTROL UNIT

< COMPONENT DIAGNOSIS >

[BOSE AUDIO WITH NAVIGATION]

U1218 AV CONTROL UNIT

Description

INFOID:000000003356582

Replace the AV control unit if this DTC is displayed. Refer to [AV-764, "Exploded View"](#).

Part name	Description
AV CONTROL UNIT	<ul style="list-style-type: none">• Integrates hard disk drive (HDD) allowing map data and music data to be stored.• It is the master unit of the MULTI AV system, and it is connected to each control unit by communication. It operates each system according to communication signals from the AV control unit.• The AV control unit includes the audio, hands-free phone, voice control, navigation, satellite radio, and vehicle information functions.• It is connected to ECM, A/C auto amp. and combination meter via CAN communication to obtain necessary information for the vehicle information function.• It is connected to BCM via CAN communication transmitting/receiving for the vehicle settings function.• It inputs the illumination signals that are required for the display dimming control.• It inputs the signals for driving status recognition (vehicle speed, reverse and parking brake).• Update of map data is performed with the CONSULT-III and the applicable cable.• It includes the TEL adapter and Bluetooth™ function.

DTC Logic

INFOID:000000003356583

DTC	Display contents of CONSULT-III	DTC Detection Condition	Action to take
U1218	HDD-CONN [U1218]	Internal malfunction of AV control unit (HDD connection malfunction) is detected.	Replace AV control unit.

U1219 AV CONTROL UNIT

< COMPONENT DIAGNOSIS >

[BOSE AUDIO WITH NAVIGATION]

U1219 AV CONTROL UNIT

Description

INFOID:000000003356584

Replace the AV control unit if this DTC is displayed. Refer to [AV-764, "Exploded View"](#).

Part name	Description
AV CONTROL UNIT	<ul style="list-style-type: none"> Integrates hard disk drive (HDD) allowing map data and music data to be stored. It is the master unit of the MULTI AV system, and it is connected to each control unit by communication. It operates each system according to communication signals from the AV control unit. The AV control unit includes the audio, hands-free phone, voice control, navigation, satellite radio, and vehicle information functions. It is connected to ECM, A/C auto amp. and combination meter via CAN communication to obtain necessary information for the vehicle information function. It is connected to BCM via CAN communication transmitting/receiving for the vehicle settings function. It inputs the illumination signals that are required for the display dimming control. It inputs the signals for driving status recognition (vehicle speed, reverse and parking brake). Update of map data is performed with the CONSULT-III and the applicable cable. It includes the TEL adapter and Bluetooth™ function.

DTC Logic

INFOID:000000003356585

DTC	Display contents of CONSULT-III	DTC Detection Condition	Action to take
U1219	HDD-READ [U1219]	Internal malfunction of AV control unit (HDD read malfunction) is detected.	Replace AV control unit.

A
B
C
D
E
F
G
H
I
J
K
L
M

AV

O
P

U1220 AV CONTROL UNIT

< COMPONENT DIAGNOSIS >

[BOSE AUDIO WITH NAVIGATION]

U1220 AV CONTROL UNIT

Description

INFOID:000000003356586

Replace the AV control unit if this DTC is displayed. Refer to [AV-764, "Exploded View"](#).

Part name	Description
AV CONTROL UNIT	<ul style="list-style-type: none">• Integrates hard disk drive (HDD) allowing map data and music data to be stored.• It is the master unit of the MULTI AV system, and it is connected to each control unit by communication. It operates each system according to communication signals from the AV control unit.• The AV control unit includes the audio, hands-free phone, voice control, navigation, satellite radio, and vehicle information functions.• It is connected to ECM, A/C auto amp. and combination meter via CAN communication to obtain necessary information for the vehicle information function.• It is connected to BCM via CAN communication transmitting/receiving for the vehicle settings function.• It inputs the illumination signals that are required for the display dimming control.• It inputs the signals for driving status recognition (vehicle speed, reverse and parking brake).• Update of map data is performed with the CONSULT-III and the applicable cable.• It includes the TEL adapter and Bluetooth™ function.

DTC Logic

INFOID:000000003356587

DTC	Display contents of CONSULT-III	DTC Detection Condition	Action to take
U1220	XM SERIAL COMM [U1220]	Internal malfunction of AV control unit (satellite radio tuner communication error) is detected.	Replace AV control unit.

U121A AV CONTROL UNIT

< COMPONENT DIAGNOSIS >

[BOSE AUDIO WITH NAVIGATION]

U121A AV CONTROL UNIT

Description

INFOID:000000003356588

Replace the AV control unit if this DTC is displayed. Refer to [AV-764, "Exploded View"](#).

Part name	Description
AV CONTROL UNIT	<ul style="list-style-type: none">Integrates hard disk drive (HDD) allowing map data and music data to be stored.It is the master unit of the MULTI AV system, and it is connected to each control unit by communication. It operates each system according to communication signals from the AV control unit.The AV control unit includes the audio, hands-free phone, voice control, navigation, satellite radio, and vehicle information functions.It is connected to ECM, A/C auto amp. and combination meter via CAN communication to obtain necessary information for the vehicle information function.It is connected to BCM via CAN communication transmitting/receiving for the vehicle settings function.It inputs the illumination signals that are required for the display dimming control.It inputs the signals for driving status recognition (vehicle speed, reverse and parking brake).Update of map data is performed with the CONSULT-III and the applicable cable.It includes the TEL adapter and Bluetooth™ function.

DTC Logic

INFOID:000000003356589

DTC	Display contents of CONSULT-III	DTC Detection Condition	Action to take
U121A	HDD-WRITE [U121A]	Internal malfunction of AV control unit (HDD write malfunction) is detected.	Replace AV control unit.

A
B
C
D
E
F
G
H
I
J
K
L
M
O
P

AV

U121B AV CONTROL UNIT

< COMPONENT DIAGNOSIS >

[BOSE AUDIO WITH NAVIGATION]

U121B AV CONTROL UNIT

Description

INFOID:000000003356590

Replace the AV control unit if this DTC is displayed. Refer to [AV-764, "Exploded View"](#).

Part name	Description
AV CONTROL UNIT	<ul style="list-style-type: none">• Integrates hard disk drive (HDD) allowing map data and music data to be stored.• It is the master unit of the MULTI AV system, and it is connected to each control unit by communication. It operates each system according to communication signals from the AV control unit.• The AV control unit includes the audio, hands-free phone, voice control, navigation, satellite radio, and vehicle information functions.• It is connected to ECM, A/C auto amp. and combination meter via CAN communication to obtain necessary information for the vehicle information function.• It is connected to BCM via CAN communication transmitting/receiving for the vehicle settings function.• It inputs the illumination signals that are required for the display dimming control.• It inputs the signals for driving status recognition (vehicle speed, reverse and parking brake).• Update of map data is performed with the CONSULT-III and the applicable cable.• It includes the TEL adapter and Bluetooth™ function.

DTC Logic

INFOID:000000003356591

DTC	Display contents of CONSULT-III	DTC Detection Condition	Action to take
U121B	HDD-COMM [U121B]	Internal malfunction of AV control unit (HDD communication error) is detected.	Replace AV control unit.

U121C AV CONTROL UNIT

< COMPONENT DIAGNOSIS >

[BOSE AUDIO WITH NAVIGATION]

U121C AV CONTROL UNIT

Description

INFOID:000000003356592

Replace the AV control unit if this DTC is displayed. Refer to [AV-764, "Exploded View"](#).

Part name	Description
AV CONTROL UNIT	<ul style="list-style-type: none"> Integrates hard disk drive (HDD) allowing map data and music data to be stored. It is the master unit of the MULTI AV system, and it is connected to each control unit by communication. It operates each system according to communication signals from the AV control unit. The AV control unit includes the audio, hands-free phone, voice control, navigation, satellite radio, and vehicle information functions. It is connected to ECM, A/C auto amp. and combination meter via CAN communication to obtain necessary information for the vehicle information function. It is connected to BCM via CAN communication transmitting/receiving for the vehicle settings function. It inputs the illumination signals that are required for the display dimming control. It inputs the signals for driving status recognition (vehicle speed, reverse and parking brake). Update of map data is performed with the CONSULT-III and the applicable cable. It includes the TEL adapter and Bluetooth™ function.

DTC Logic

INFOID:000000003356593

DTC	Display contents of CONSULT-III	DTC Detection Condition	Action to take
U121C	HDD-ACCESS [U121C]	Internal malfunction of AV control unit (HDD access error) is detected.	Replace AV control unit.

A
B
C
D
E
F
G
H
I
J
K
L
M

AV

O
P

U121D AV CONTROL UNIT

< COMPONENT DIAGNOSIS >

[BOSE AUDIO WITH NAVIGATION]

U121D AV CONTROL UNIT

Description

INFOID:000000003356594

Replace the AV control unit if this DTC is displayed. Refer to [AV-764, "Exploded View"](#).

Part name	Description
AV CONTROL UNIT	<ul style="list-style-type: none">• Integrates hard disk drive (HDD) allowing map data and music data to be stored.• It is the master unit of the MULTI AV system, and it is connected to each control unit by communication. It operates each system according to communication signals from the AV control unit.• The AV control unit includes the audio, hands-free phone, voice control, navigation, satellite radio, and vehicle information functions.• It is connected to ECM, A/C auto amp. and combination meter via CAN communication to obtain necessary information for the vehicle information function.• It is connected to BCM via CAN communication transmitting/receiving for the vehicle settings function.• It inputs the illumination signals that are required for the display dimming control.• It inputs the signals for driving status recognition (vehicle speed, reverse and parking brake).• Update of map data is performed with the CONSULT-III and the applicable cable.• It includes the TEL adapter and Bluetooth™ function.

DTC Logic

INFOID:000000003356595

DTC	Display contents of CONSULT-III	DTC Detection Condition	Action to take
U121D	DSP CONN [U121D]	Internal malfunction of AV control unit (DSP connection error) is detected.	Replace AV control unit.

U121E AV CONTROL UNIT

< COMPONENT DIAGNOSIS >

[BOSE AUDIO WITH NAVIGATION]

U121E AV CONTROL UNIT

Description

INFOID:000000003356596

Replace the AV control unit if this DTC is displayed. Refer to [AV-764, "Exploded View"](#).

Part name	Description
AV CONTROL UNIT	<ul style="list-style-type: none">Integrates hard disk drive (HDD) allowing map data and music data to be stored.It is the master unit of the MULTI AV system, and it is connected to each control unit by communication. It operates each system according to communication signals from the AV control unit.The AV control unit includes the audio, hands-free phone, voice control, navigation, satellite radio, and vehicle information functions.It is connected to ECM, A/C auto amp. and combination meter via CAN communication to obtain necessary information for the vehicle information function.It is connected to BCM via CAN communication transmitting/receiving for the vehicle settings function.It inputs the illumination signals that are required for the display dimming control.It inputs the signals for driving status recognition (vehicle speed, reverse and parking brake).Update of map data is performed with the CONSULT-III and the applicable cable.It includes the TEL adapter and Bluetooth™ function.

DTC Logic

INFOID:000000003356597

DTC	Display contents of CONSULT-III	DTC Detection Condition	Action to take
U121E	DSP COMM [U121E]	Internal malfunction of AV control unit (DSP communication error) is detected.	Replace AV control unit.

A
B
C
D
E
F
G
H
I
J
K
L
M
O
P

AV

U121F AV CONTROL UNIT

< COMPONENT DIAGNOSIS >

[BOSE AUDIO WITH NAVIGATION]

U121F AV CONTROL UNIT

Description

INFOID:000000003356598

Replace the AV control unit if this DTC is displayed. Refer to [AV-764, "Exploded View"](#).

Part name	Description
AV CONTROL UNIT	<ul style="list-style-type: none">Integrates hard disk drive (HDD) allowing map data and music data to be stored.It is the master unit of the MULTI AV system, and it is connected to each control unit by communication. It operates each system according to communication signals from the AV control unit.The AV control unit includes the audio, hands-free phone, voice control, navigation, satellite radio, and vehicle information functions.It is connected to ECM, A/C auto amp. and combination meter via CAN communication to obtain necessary information for the vehicle information function.It is connected to BCM via CAN communication transmitting/receiving for the vehicle settings function.It inputs the illumination signals that are required for the display dimming control.It inputs the signals for driving status recognition (vehicle speed, reverse and parking brake).Update of map data is performed with the CONSULT-III and the applicable cable.It includes the TEL adapter and Bluetooth™ function.

DTC Logic

INFOID:000000003356599

DTC	Display contents of CONSULT-III	DTC Detection Condition	Action to take
U121F	INTERNAL COMM [U121F]	Internal malfunction of AV control unit (internal communication error) is detected.	AV control unit power supply and ground circuit.

Diagnosis Procedure

INFOID:000000003356600

1. CHECK AV CONTROL UNIT POWER SUPPLY AND GROUND CIRCUIT

Check AV control unit power supply and ground circuit. Refer to [AV-619, "AV CONTROL UNIT : Diagnosis Procedure"](#).

Is the inspection result normal?

- YES >> Replace AV control unit.
- NO >> Repair or replace malfunctioning parts.

U1204 GPS

Description

INFOID:000000003356601

An intermittent error caused by strong radio interference may be detected unless any symptom (GPS reception error, etc.) occurs. Replace the AV control unit if the malfunction occurs constantly. Refer to [AV-764, "Exploded View"](#).

Part name	Description
AV CONTROL UNIT	<ul style="list-style-type: none"> Integrates hard disk drive (HDD) allowing map data and music data to be stored. It is the master unit of the MULTI AV system, and it is connected to each control unit by communication. It operates each system according to communication signals from the AV control unit. The AV control unit includes the audio, hands-free phone, voice control, navigation, satellite radio, and vehicle information functions. It is connected to ECM and combination meter via CAN communication to obtain necessary information for the vehicle information function. It is connected to BCM via CAN communication transmitting/receiving for the vehicle settings function. It inputs the illumination signals that are required for the display dimming control. It inputs the signals for driving status recognition (vehicle speed, reverse and parking brake). Update of map data is performed with the CONSULT-III and the applicable cable. It includes the TEL adapter and Bluetooth™ function.

DTC Logic

INFOID:000000003356602

DTC	Display contents of CONSULT-III	DTC Detection Condition	Action to take
U1204	GPS CONN [U1204]	Internal malfunction of AV control unit (GPS malfunction) is detected.	An intermittent error caused by strong radio interference may be detected unless a symptom (GPS reception error, etc.) occurs. Replace the AV control unit if the malfunction occurs constantly.

Diagnosis Procedure

INFOID:000000003356603

1. PERFORM THE SELF-DIAGNOSIS

- Delete the self-diagnosis results. Turn ignition switch OFF.
- Turn ignition switch ON. Perform the self-diagnosis again.
- Check that the DTC is detected again.

Is any DTC detected?

- YES >> Replace AV control unit.
 NO >> The intermittent malfunction caused by strong radio interference can be detected.



U1205 GPS

Description

INFOID:000000003556528

An intermittent error caused by strong radio interference may be detected unless any symptom (GPS reception error, etc.) occurs. Replace the AV control unit if the malfunction occurs constantly. Refer to [AV-764](#), "[Exploded View](#)".

Part name	Description
AV CONTROL UNIT	<ul style="list-style-type: none"> Integrates hard disk drive (HDD) allowing map data and music data to be stored. It is the master unit of the MULTI AV system, and it is connected to each control unit by communication. It operates each system according to communication signals from the AV control unit. The AV control unit includes the audio, hands-free phone, voice control, navigation, satellite radio, and vehicle information functions. It is connected to ECM and combination meter via CAN communication to obtain necessary information for the vehicle information function. It is connected to BCM via CAN communication transmitting/receiving for the vehicle settings function. It inputs the illumination signals that are required for the display dimming control. It inputs the signals for driving status recognition (vehicle speed, reverse and parking brake). Update of map data is performed with the CONSULT-III and the applicable cable. It includes the TEL adapter and Bluetooth™ function.

DTC Logic

INFOID:000000003356605

DTC	Display contents of CONSULT-III	DTC Detection Condition	Action to take
U1205	GPS ROM [U1205]	Internal malfunction of AV control unit (GPS malfunction) is detected.	An intermittent error caused by strong radio interference may be detected unless a symptom (GPS reception error, etc.) occurs. Replace the AV control unit if the malfunction occurs constantly.

Diagnosis Procedure

INFOID:000000003356606

1. PERFORM THE SELF-DIAGNOSIS

1. Delete the self-diagnosis results. Turn ignition switch OFF.
2. Turn ignition switch ON. Perform the self-diagnosis again.
3. Check that the DTC is detected again.

Is any DTC detected?

- YES >> Replace AV control unit.
 NO >> The intermittent malfunction caused by strong radio interference can be detected.

U1206 GPS

Description

INFOID:000000003556529

An intermittent error caused by strong radio interference may be detected unless any symptom (GPS reception error, etc.) occurs. Replace the AV control unit if the malfunction occurs constantly. Refer to [AV-764](#), "Exploded View".

Part name	Description
AV CONTROL UNIT	<ul style="list-style-type: none"> Integrates hard disk drive (HDD) allowing map data and music data to be stored. It is the master unit of the MULTI AV system, and it is connected to each control unit by communication. It operates each system according to communication signals from the AV control unit. The AV control unit includes the audio, hands-free phone, voice control, navigation, satellite radio, and vehicle information functions. It is connected to ECM and combination meter via CAN communication to obtain necessary information for the vehicle information function. It is connected to BCM via CAN communication transmitting/receiving for the vehicle settings function. It inputs the illumination signals that are required for the display dimming control. It inputs the signals for driving status recognition (vehicle speed, reverse and parking brake). Update of map data is performed with the CONSULT-III and the applicable cable. It includes the TEL adapter and Bluetooth™ function.

DTC Logic

INFOID:000000003356608

DTC	Display contents of CONSULT-III	DTC Detection Condition	Action to take
U1206	GPS RAM [U1206]	Internal malfunction of AV control unit (GPS malfunction) is detected.	An intermittent error caused by strong radio interference may be detected unless a symptom (GPS reception error, etc.) occurs. Replace the AV control unit if the malfunction occurs constantly.

Diagnosis Procedure

INFOID:000000003356609

1. PERFORM THE SELF-DIAGNOSIS

- Delete the self-diagnosis results. Turn ignition switch OFF.
- Turn ignition switch ON. Perform the self-diagnosis again.
- Check that the DTC is detected again.

Is any DTC detected?

- YES >> Replace AV control unit.
 NO >> The intermittent malfunction caused by strong radio interference can be detected.



U1207 GPS

Description

INFOID:000000003556530

An intermittent error caused by strong radio interference may be detected unless any symptom (GPS reception error, etc.) occurs. Replace the AV control unit if the malfunction occurs constantly. Refer to [AV-764](#), "[Exploded View](#)".

Part name	Description
AV CONTROL UNIT	<ul style="list-style-type: none"> Integrates hard disk drive (HDD) allowing map data and music data to be stored. It is the master unit of the MULTI AV system, and it is connected to each control unit by communication. It operates each system according to communication signals from the AV control unit. The AV control unit includes the audio, hands-free phone, voice control, navigation, satellite radio, and vehicle information functions. It is connected to ECM and combination meter via CAN communication to obtain necessary information for the vehicle information function. It is connected to BCM via CAN communication transmitting/receiving for the vehicle settings function. It inputs the illumination signals that are required for the display dimming control. It inputs the signals for driving status recognition (vehicle speed, reverse and parking brake). Update of map data is performed with the CONSULT-III and the applicable cable. It includes the TEL adapter and Bluetooth™ function.

DTC Logic

INFOID:000000003356611

DTC	Display contents of CONSULT-III	DTC Detection Condition	Action to take
U1207	GPS RTC [U1207]	Internal malfunction of AV control unit (GPS malfunction) is detected.	An intermittent error caused by strong radio interference may be detected unless a symptom (GPS reception error, etc.) occurs. Replace the AV control unit if the malfunction occurs constantly.

Diagnosis Procedure

INFOID:000000003356612

1. PERFORM THE SELF-DIAGNOSIS

1. Delete the self-diagnosis results. Turn ignition switch OFF.
2. Turn ignition switch ON. Perform the self-diagnosis again.
3. Check that the DTC is detected again.

Is any DTC detected?

- YES >> Replace AV control unit.
 NO >> The intermittent malfunction caused by strong radio interference can be detected.

U1243 DISPLAY UNIT

< COMPONENT DIAGNOSIS >

[BOSE AUDIO WITH NAVIGATION]

U1243 DISPLAY UNIT

Description

INFOID:000000003356613

Part name	Description
FRONT DISPLAY UNIT	<ul style="list-style-type: none"> • Front display image is controlled by the serial communication from AV control unit. • RGB image signal is input from AV control unit (RGB, RGB area and RGB synchronizing). Auxiliary image signal is input from the auxiliary input jack. Camera image signal is input from camera control unit. • Synchronize signal (HP, VP) is output to AV control unit. • Touch panel function can be operated for each system by touching a display directly.

DTC Logic

INFOID:000000003356614

DTC	Display contents of CONSULT-III	DTC Detection Condition	Possible causes
U1243	FRONT DISP CONN [U1243]	When either one of the following items are detected: <ul style="list-style-type: none"> • serial communication circuits between AV control unit and front display unit are malfunctioning. • serial communication signal between AV control unit and front display unit is malfunctioning. 	<ul style="list-style-type: none"> • Front display unit power supply and ground circuits. • Serial communication circuits between AV control unit and display unit.

Diagnosis Procedure

INFOID:000000003356615

1. CHECK FRONT DISPLAY UNIT POWER SUPPLY AND GROUND CIRCUIT

Check front display unit power supply and ground circuit. Refer to [AV-619. "FRONT DISPLAY UNIT : Diagnosis Procedure"](#).

Is the inspection result normal?

YES >> GO TO 2.

NO >> Repair malfunctioning parts.

2. CHECK CONTINUITY COMMUNICATION CIRCUIT

1. Turn ignition switch OFF.
2. Disconnect front display unit connector and AV control unit connector.
3. Check continuity between front display unit harness connector and AV control unit harness connector.

Front display unit		AV control unit		Continuity
Connector	Terminals	Connector	Terminals	
M49	11	M146	70	Existed
	22		71	

4. Check continuity between front display unit harness connector and ground.

Front display unit		Ground	Continuity
Connector	Terminals		
M49	11		Not existed
	22		

Is the inspection result normal?

YES >> GO TO 3.

NO >> Repair harness or connector.

3. CHECK COMMUNICATION SIGNAL

1. Connect front display unit connector and AV control unit connector.

U1243 DISPLAY UNIT

[BOSE AUDIO WITH NAVIGATION]

< COMPONENT DIAGNOSIS >

2. Turn ignition switch ON.
3. Check signal between front display unit harness connector terminal and ground using an oscilloscope.

(+)		(-)	Condition	Signal
Front display unit				
Connector	Terminal			
M49	11	Ground	When adjusting display brightness.	

Is the inspection result normal?

- YES >> GO TO 4.
 NO >> Replace AV control unit.

4. CHECK COMMUNICATION SIGNAL

Check signal between display unit harness connector and ground using an oscilloscope.

(+)		(-)	Condition	Signal
Front display unit				
Connector	Terminal			
M49	22	Ground	When adjusting display brightness.	

Is the inspection result normal?

- YES >> INSPECTION END
 NO >> Replace front display unit.

U1244 GPS ANTENNA

< COMPONENT DIAGNOSIS >

[BOSE AUDIO WITH NAVIGATION]

U1244 GPS ANTENNA

Description

INFOID:000000003356616

Part name	Description
GPS ANTENNA	GPS signal is received and transmitted to AV control unit.

DTC Logic

INFOID:000000003356617

DTC	Display contents of CONSULT-III	DTC Detection Condition	Possible causes
U1244	GPS ANTENNA CONN [U1244]	GPS antenna connection malfunction is detected.	GPS antenna disconnection.

Diagnosis Procedure

INFOID:000000003356618

1. GPS ANTENNA CHECK

Visually check GPS antenna and antenna feeder.

Is the inspection result normal?

YES >> GO TO 2.

NO >> Repair malfunctioning parts.

2. CHECK AV CONTROL UNIT VOLTAGE

1. Disconnect GPS antenna connector.
2. Turn ignition switch ON.
3. Check voltage between AV control unit terminal and ground.

(+)		(-)	Voltage (Approx.)
AV control unit			
Connector	Terminal		
M380	110	Ground	5.0 V

Is the inspection result normal?

YES >> INSPECTION END

NO >> Replace AV control unit.

A
B
C
D
E
F
G
H
I
J
K
L
M
O
P

AV

U1250 CAMERA CONTROL UNIT

< COMPONENT DIAGNOSIS >

[BOSE AUDIO WITH NAVIGATION]

U1250 CAMERA CONTROL UNIT

Description

INFOID:000000003356619

Part name	Description
CAMERA CONTROL UNIT	<ul style="list-style-type: none"> • Camera image signal is input from rear view camera, and camera image is indicated on the display. • Power (camera ON signal) is transmitted to rear view camera. • Controlled by AV communication transmitted from AV control unit. • AV control unit recognizes the presence of camera system with camera connection recognition signal.

DTC Logic

INFOID:000000003356620

DTC	Display contents of CONSULT-III	DTC Detection Condition	Possible causes
U1250	CAMERA CONT. CONN [U1250]	Malfunction is detected in camera connection recognition circuit between AV control unit and camera control unit.	Camera-connection recognition circuit between AV control unit and camera control unit.

Diagnosis Procedure

INFOID:000000003356621

1. CHECK CAMERA-CONNECTION RECOGNITION SIGNAL CIRCUIT

1. Disconnect AV control unit connector and camera control unit connector.
2. Check continuity between AV control unit harness connector and camera control unit harness connector.

AV control unit		Camera control unit		Continuity
Connector	Terminal	Connector	Terminal	
M145	40	B60	14	Existed

Is the inspection result normal?

YES >> GO TO 2.

NO >> Repair harness or connector.

2. CHECK AV CONTROL UNIT VOLTAGE

1. Connect AV control unit connector.
2. Turn ignition switch ON.
3. Check voltage between AV control unit harness connector and ground.

(+)		(-)	Voltage (Approx.)
AV control unit			
Connector	Terminal		
M145	40	Ground	5.0 V

Is the inspection result normal?

YES >> Replace camera control unit.

NO >> Replace AV control unit.

U1258 SATELLITE RADIO ANTENNA

< COMPONENT DIAGNOSIS >

[BOSE AUDIO WITH NAVIGATION]

U1258 SATELLITE RADIO ANTENNA

Description

INFOID:000000003356622

Part name	Description
SATELLITE RADIO ANTENNA	Satellite radio waves are received and transmitted to AV control unit.

DTC Logic

INFOID:000000003356623

DTC	Display contents of CONSULT-III	DTC Detection Condition	Possible causes
U1258	XM ANTENNA CONN [U1258]	Satellite radio antenna connection malfunction is detected.	<ul style="list-style-type: none">Satellite radio antenna feeder.Satellite radio antenna.

Diagnosis Procedure

INFOID:000000003356624

1. SATELLITE RADIO ANTENNA CHECK

Visually check satellite radio antenna and antenna feeder.

Is the inspection result normal?

YES >> GO TO 2.

NO >> Repair malfunctioning parts.

2. CHECK AV CONTROL UNIT VOLTAGE

1. Disconnect satellite radio antenna connector.
2. Turn ignition switch ON.
3. Check voltage between AV control unit terminal and ground.

(+)		(-)	Voltage (Approx.)
AV control unit			
Connector	Terminal		
M372	108	Ground	5.0 V

Is the inspection result normal?

YES >> INSPECTION END

NO >> Replace AV control unit.

A
B
C
D
E
F
G
H
I
J
K
L
M
O
P

AV

U1300 AV COMM CIRCUIT

< COMPONENT DIAGNOSIS >

[BOSE AUDIO WITH NAVIGATION]

U1300 AV COMM CIRCUIT

Description

INFOID:000000003356625

U1300 is indicated when malfunction occurs in communication signal of multi AV system. Indicated simultaneously, without fail, with the malfunction of control units connected to AV control unit with communication line. Determine the possible malfunction cause from the table below.

SELF-DIAGNOSIS RESULTS DISPLAY ITEM

DTC	Display contents of CONSULT-III	Description	Possible malfunction factor/Action to take
U1300 U121F	<ul style="list-style-type: none"> AV COMM CIRCUIT [U1300] INTERNAL COMM [U121F] 	Malfunction is detected in AV control unit power supply and ground circuits.	Check AV control unit power supply and ground circuits. When detecting no malfunction in those components, replace AV control unit.
U1300 U1240	<ul style="list-style-type: none"> AV COMM CIRCUIT [U1300] SWITCH CONN [U1240] 	When either one of the following items are detected: <ul style="list-style-type: none"> multifunction switch power supply and ground circuits are malfunctioning. AV communication circuits between AV control unit and multifunction switch are malfunctioning. AV communication signal between AV control unit and multifunction switch is malfunctioning. 	<ul style="list-style-type: none"> Multifunction switch power supply and ground circuits. AV communication circuits between AV control unit and multifunction switch.
U1300 U1252	<ul style="list-style-type: none"> AV COMM CIRCUIT [U1300] REAR CAMERA LAN CONN [U1252] 	When either one of the following items are detected: <ul style="list-style-type: none"> camera control unit power supply and ground circuits are malfunctioning. AV communication circuits between multifunction and camera control unit are malfunctioning. AV communication signal between AV control unit and camera control unit is malfunctioning. 	<ul style="list-style-type: none"> Camera control unit power supply and ground circuits. AV communication circuits between multifunction switch and camera control unit.
U1300 U1254	<ul style="list-style-type: none"> AV COMM CIRCUIT [U1300] IPod CONN [U1254] 	When either one of the following items are detected: <ul style="list-style-type: none"> iPod adapter power supply and ground circuits are malfunctioning. AV communication circuits between multifunction switch and iPod adapter are malfunctioning. AV communication signal between AV control unit and iPod adapter is malfunctioning. 	<ul style="list-style-type: none"> iPod adapter power supply and ground circuits. AV communication circuits between multifunction switch unit and iPod adapter.
U1300 U1252 U1254*	<ul style="list-style-type: none"> AV COMM CIRCUIT [U1300] REAR CAMERA LAN CONN [U1252] IPod CONN [U1254]* 	Malfunction is detected in AV communication circuits between camera control unit and the junction of AV control unit and multifunction switch.	AV communication circuits between camera control unit and the junction of AV control unit and multifunction switch.
U1300 U1240 U1252 U1254*	<ul style="list-style-type: none"> AV COMM CIRCUIT [U1300] SWITCH CONN [U1240] REAR CAMERA LAN CONN [U1252] IPod CONN [U1254]* 	Malfunction is detected in AV communication circuits between AV control unit and multifunction switch.	AV communication circuits between AV control unit and the junction of camera control unit and multifunction switch.
U1300 U121F U1240 U1252 U1254*	<ul style="list-style-type: none"> AV COMM CIRCUIT [U1300] INTERNAL COMM [U121F] SWITCH CONN [U1240] REAR CAMERA LAN CONN [U1252] IPod CONN [U1254]* 	Malfunction is detected in AV communication circuits.	Check and repair the short circuit in AV communication circuits.

NOTE:

*: Non-equipped item is not displayed.

POWER SUPPLY AND GROUND CIRCUIT

< COMPONENT DIAGNOSIS >

[BOSE AUDIO WITH NAVIGATION]

POWER SUPPLY AND GROUND CIRCUIT

AV CONTROL UNIT

AV CONTROL UNIT : Diagnosis Procedure

INFOID:000000003356626

1.CHECK FUSE

Check for blown fuses.

Power source	Fuse No.
Battery	35
Ignition switch ACC or ON	19
Ignition switch ON or START	3

Is the inspection result normal?

YES >> GO TO 2.

NO >> Be sure to eliminate the cause of malfunction before installing new fuse.

2.CHECK POWER SUPPLY CIRCUIT

Check voltage between AV control unit harness connectors and ground.

Signal name	Connector No.	Terminal No.	Ignition switch position	Value (Approx.)
Battery power supply	M144	19	OFF	Battery voltage
	M145	22		
		24		
ACC power supply	M144	7	ACC	Battery voltage
	M145	25		
Ignition signal	M145	35	ON	Battery voltage

Is the inspection result normal?

YES >> GO TO 3.

NO >> Check harness between AV control unit and fuse.

3.CHECK GROUND CIRCUIT

1. Turn ignition switch OFF.
2. Disconnect AV control unit connectors.
3. Check continuity between AV control unit harness connectors and ground.

Signal name	Connector No.	Terminal No.	Ignition switch position	Continuity
Ground	M145	21	OFF	Existed
		23		

Is the inspection result normal?

YES >> INSPECTION END

NO >> Repair harness or connector.

FRONT DISPLAY UNIT

FRONT DISPLAY UNIT : Diagnosis Procedure

INFOID:000000003356627

1.CHECK FUSE

Check for blown fuses.

Power source	Fuse No.
Battery	35
Ignition switch ACC or ON	19

A
B
C
D
E
F
G
H
I
J
K
L
M
O
P

AV

POWER SUPPLY AND GROUND CIRCUIT

[BOSE AUDIO WITH NAVIGATION]

< COMPONENT DIAGNOSIS >

Is the inspection result normal?

YES >> GO TO 2.

NO >> Be sure to eliminate the cause of malfunction before installing new fuse.

2.CHECK POWER SUPPLY CIRCUIT

Check voltage between display unit harness connector and ground.

Signal name	Connector No.	Terminal No.	Ignition switch position	Value (Approx.)
Battery power supply	M49	2	OFF	Battery voltage
ACC power supply		3	ACC	

Is the inspection result normal?

YES >> GO TO 3.

NO >> Check harness between Display unit and fuse.

3.CHECK GROUND CIRCUIT

1. Turn ignition switch OFF.
2. Disconnect display unit connector.
3. Check continuity between display unit harness connector and ground.

Signal name	Connector No.	Terminal No.	Ignition switch position	Continuity
Ground	M49	1	OFF	Existed
		13		

Is the inspection result normal?

YES >> INSPECTION END

NO >> Repair harness or connector.

MULTIFUNCTION SWITCH

MULTIFUNCTION SWITCH : Diagnosis Procedure

INFOID:000000003356628

1.CHECK FUSE

Check for blown fuses.

Power source	Fuse No.
Ignition switch ACC or ON	19

Is the inspection result normal?

YES >> GO TO 2.

NO >> Be sure to eliminate the cause of malfunction before installing new fuse.

2.CHECK POWER SUPPLY CIRCUIT

Check voltage between multifunction switch harness connector and ground.

Signal name	Connector No.	Terminal No.	Ignition switch position	Value (Approx.)
ACC power supply	M125	3	ACC	Battery voltage

Is the inspection result normal?

YES >> GO TO 3.

NO >> Check harness between multifunction switch and fuse.

3.CHECK GROUND CIRCUIT

1. Turn ignition switch OFF.
2. Disconnect multifunction switch connector.
3. Check continuity between multifunction switch harness connector and ground.

Signal name	Connector No.	Terminal No.	Ignition switch position	Continuity
Ground	M125	1	OFF	Existed

POWER SUPPLY AND GROUND CIRCUIT

[BOSE AUDIO WITH NAVIGATION]

< COMPONENT DIAGNOSIS >

Is the inspection result normal?

YES >> INSPECTION END

NO >> Repair harness or connector.

CAMERA CONTROL UNIT

CAMERA CONTROL UNIT : Diagnosis Procedure

INFOID:000000003356629

1.CHECK FUSE

Check for blown fuses.

Power source	Fuse No.
Battery	35
Ignition switch ACC or ON	19

Is the inspection result normal?

YES >> GO TO 2.

NO >> Be sure to eliminate the cause of malfunction before installing new fuse.

2.CHECK POWER SUPPLY CIRCUIT

Check voltage between camera control unit harness connector and ground.

Signal name	Connector No.	Terminal No.	Ignition switch position	Value (Approx.)
Battery power supply	B60	32	OFF	Battery voltage
ACC power supply		30	ACC	

Is the inspection result normal?

YES >> GO TO 3.

NO >> Check harness between camera control unit and fuse.

3.CHECK GROUND CIRCUIT

1. Turn ignition switch OFF.
2. Disconnect camera control unit connector.
3. Check continuity between camera control unit harness connector and ground.

Signal name	Connector No.	Terminal No.	Ignition switch position	Continuity
Ground	B60	31	OFF	Existed

Is the inspection result normal?

YES >> INSPECTION END

NO >> Repair harness or connector.

BOSE AMP.

BOSE AMP. : Diagnosis Procedure

INFOID:000000003356630

1.CHECK FUSE

Check for blown fuses.

Power source	Fuse No.
Battery	23, 24

Is the inspection result normal?

YES >> GO TO 2.

NO >> Be sure to eliminate the cause of malfunction before installing new fuse.

2.CHECK POWER SUPPLY CIRCUIT

Check voltage between BOSE amp. harness connector and ground.

A
B
C
D
E
F
G
H
I
J
K
L
M

AV

O
P

POWER SUPPLY AND GROUND CIRCUIT

< COMPONENT DIAGNOSIS >

[BOSE AUDIO WITH NAVIGATION]

Signal name	Connector No.	Terminal No.	Ignition switch position	Value (Approx.)
Battery power supply	B224	10	OFF	Battery voltage
		11		

Is the inspection result normal?

YES >> GO TO 3.

NO >> Check harness between BOSE amp. and fuse.

3.CHECK GROUND CIRCUIT

1. Turn ignition switch OFF.
2. Disconnect BOSE amp. connector.
3. Check continuity between BOSE amp. harness connector and ground.

Signal name	Connector No.	Terminal No.	Ignition switch position	Continuity
Ground	B224	7	OFF	Existed
		12		

Is the inspection result normal?

YES >> INSPECTION END

NO >> Repair harness or connector.

WOOFER

WOOFER : Diagnosis Procedure

INFOID:000000003356631

1.CHECK FUSE

Check for blown fuses.

Power source	Fuse No.
Battery	25

Is the inspection result normal?

YES >> GO TO 2.

NO >> Be sure to eliminate the cause of malfunction before installing new fuse.

2.CHECK POWER SUPPLY CIRCUIT

Check voltage between woofer amp. harness connector and ground.

Signal name	Connector No.	Terminal No.	Ignition switch position	Value (Approx.)
Battery power supply	B28	6	OFF	Battery voltage

Is the inspection result normal?

YES >> GO TO 3.

NO >> Check harness between woofer amp. and fuse.

3.CHECK GROUND CIRCUIT

1. Turn ignition switch OFF.
2. Disconnect woofer amp. connector.
3. Check continuity between woofer amp. harness connector and ground.

Signal name	Connector No.	Terminal No.	Ignition switch position	Continuity
Ground	B28	5	OFF	Existed

Is the inspection result normal?

YES >> INSPECTION END

NO >> Repair harness or connector.

iPod ADAPTER

POWER SUPPLY AND GROUND CIRCUIT

< COMPONENT DIAGNOSIS >

[BOSE AUDIO WITH NAVIGATION]

iPod ADAPTER : Diagnosis Procedure

INFOID:000000003356632

1.CHECK FUSE

Check for blown fuses.

Power source	Fuse No.
Battery	35
Ignition switch ACC or ON	19

Is the inspection result normal?

YES >> GO TO 2.

NO >> Be sure to eliminate the cause of malfunction before installing new fuse.

2.CHECK POWER SUPPLY CIRCUIT

Check voltage between iPod adapter harness connector and ground.

Signal name	Connector No.	Terminal No.	Ignition switch position	Value (Approx.)
Battery power supply	M148	5	OFF	Battery voltage
ACC power supply		3	ACC	

Is the inspection result normal?

YES >> INSPECTION END

NO >> Check harness between iPod adapter and fuse.

A
B
C
D
E
F
G
H
I
J
K
L
M

AV

O
P

RGB (R: RED) SIGNAL CIRCUIT (AV CONTROL UNIT TO FRONT DISPLAY UNIT)

< COMPONENT DIAGNOSIS >

[BOSE AUDIO WITH NAVIGATION]

RGB (R: RED) SIGNAL CIRCUIT (AV CONTROL UNIT TO FRONT DISPLAY UNIT)

Description

INFOID:000000003356633

Transmit the image displayed with AV control unit with RGB signal to the front display unit.

Diagnosis Procedure

INFOID:000000003356634

1. CHECK CONTINUITY RGB (R: RED) SIGNAL CIRCUIT

1. Turn ignition switch OFF.
2. Disconnect front display unit connector and AV control unit connector.
3. Check continuity between front display unit harness connector and AV control unit harness connector.

Front display unit		AV control unit		Continuity
Connector	Terminal	Connector	Terminal	
M49	17	M146	61	Existed

4. Check continuity between front display unit harness connector and ground.

Front display unit		Ground	Continuity
Connector	Terminal		
M49	17		Not existed

Is the inspection result normal?

YES >> GO TO 2.

NO >> Repair harness or connector.

2. CHECK RGB (R: RED) SIGNAL

1. Connect front display unit connector and AV control unit connector.
2. Turn ignition switch ON.
3. Check signal between front display unit harness connector and ground using an oscilloscope.

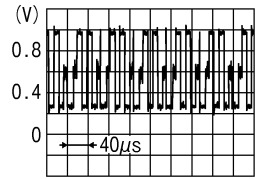
(+) Front display unit		(-)	Condition	Signal
Connector	Terminal			
M49	17	Ground	Start confirmation/adjustment mode, and then display color bar by selecting "Color Spectrum Bar" on DISPLAY DIAGNOSIS screen.	 <p>(V) 0.8 0.4 0 ← 40µs</p>

JSNIA1029ZZ

Is the inspection result normal?

YES >> Replace front display unit.

NO >> Replace AV control unit.

RGB (G: GREEN) SIGNAL CIRCUIT (AV CONTROL UNIT TO FRONT DISPLAY UNIT)

< COMPONENT DIAGNOSIS >

[BOSE AUDIO WITH NAVIGATION]

RGB (G: GREEN) SIGNAL CIRCUIT (AV CONTROL UNIT TO FRONT DISPLAY UNIT)

Description

INFOID:000000003356635

Transmit the image displayed with AV control unit with RGB signal to the front display unit.

Diagnosis Procedure

INFOID:000000003356636

1. CHECK CONTINUITY RGB (G: GREEN) SIGNAL CIRCUIT

1. Turn ignition switch OFF.
2. Disconnect front display unit connector and AV control unit connector.
3. Check continuity between front display unit harness connector and AV control unit harness connector.

Front display unit		AV control unit		Continuity
Connector	Terminal	Connector	Terminal	
M49	6	M146	62	Existed

4. Check continuity between front display unit harness connector and ground.

Front display unit		Ground	Continuity
Connector	Terminal		
M49	6		Not existed

Is the inspection result normal?

- YES >> GO TO 2.
 NO >> Repair harness or connector.

2. CHECK RGB (G: GREEN) SIGNAL

1. Connect front display unit connector and AV control unit connector.
2. Turn ignition switch ON.
3. Check signal between front display unit harness connector and ground using an oscilloscope.

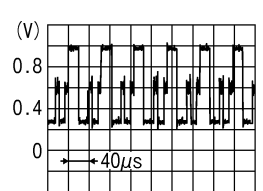
(+)		(-)	Condition	Signal
Front display unit				
Connector	Terminal			
M49	6	Ground	Start confirmation/adjustment mode, and then display color bar by selecting "Color Spectrum Bar" on DISPLAY DIAGNOSIS screen.	 <p style="text-align: right;">JSNIA1030ZZ</p>

Is the inspection result normal?

- YES >> Replace front display unit.
 NO >> Replace AV control unit.

RGB (B: BLUE) SIGNAL CIRCUIT (AV CONTROL UNIT TO FRONT DISPLAY UNIT)

< COMPONENT DIAGNOSIS >

[BOSE AUDIO WITH NAVIGATION]

RGB (B: BLUE) SIGNAL CIRCUIT (AV CONTROL UNIT TO FRONT DISPLAY UNIT)

Description

INFOID:000000003356637

Transmit the image displayed with AV control unit with RGB signal to the front display unit.

Diagnosis Procedure

INFOID:000000003356638

1. CHECK CONTINUITY RGB (B: BLUE) SIGNAL CIRCUIT

1. Turn ignition switch OFF.
2. Disconnect front display unit connector and AV control unit connector.
3. Check continuity between front display unit harness connector and AV control unit harness connector.

Front display unit		AV control unit		Continuity
Connector	Terminal	Connector	Terminal	
M49	18	M146	63	Existed

4. Check continuity between front display unit harness connector and ground.

Front display unit		Ground	Continuity
Connector	Terminal		
M49	18		Not existed

Is the inspection result normal?

- YES >> GO TO 2.
 NO >> Repair harness or connector.

2. CHECK RGB (B: BLUE) SIGNAL

1. Connect front display unit connector and AV control unit connector.
2. Turn ignition switch ON.
3. Check signal between front display unit harness connector and ground using an oscilloscope.

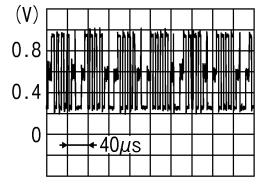
(+)		(-)	Condition	Signal
Front display unit				
Connector	Terminal			
M49	18	Ground	Start confirmation/adjustment mode, and then display color bar by selecting "Color Spectrum Bar" on DISPLAY DIAGNOSIS screen.	

JSNIA1031ZZ

Is the inspection result normal?

- YES >> Replace front display unit.
 NO >> Replace AV control unit.

RGB SYNCHRONIZING SIGNAL CIRCUIT

< COMPONENT DIAGNOSIS >

[BOSE AUDIO WITH NAVIGATION]

RGB SYNCHRONIZING SIGNAL CIRCUIT

Description

INFOID:000000003356639

Transmit the RGB synchronizing signal to the front display unit so as to synchronize the RGB image displayed with AV control unit.

Diagnosis Procedure

INFOID:000000003356640

1. CHECK CONTINUITY RGB SYNCHRONIZING SIGNAL CIRCUIT

1. Turn ignition switch OFF.
2. Disconnect front display unit connector and AV control unit connector.
3. Check continuity between front display unit harness connector and AV control unit harness connector.

Front display unit		AV control unit		Continuity
Connector	Terminal	Connector	Terminal	
M49	19	M146	65	Existed

4. Check continuity between front display unit harness connector and ground.

Front display unit		Ground	Continuity
Connector	Terminal		
M49	19		Not existed

Is the inspection result normal?

YES >> GO TO 2.

NO >> Repair harness or connector.

2. CHECK RGB SYNCHRONIZING SIGNAL

1. Connect front display unit connector and AV control unit connector.
2. Turn ignition switch ON.
3. Check signal between front display unit harness connector and ground using an oscilloscope.

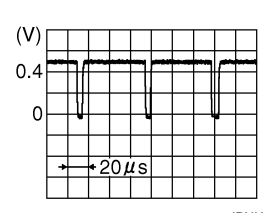
(+)		(-)	Condition	Signal
Front display unit				
Connector	Terminal			
M49	19	Ground	—	 <p style="text-align: right;">JPNIA0461GB</p>

Is the inspection result normal?

YES >> Replace front display unit.

NO >> Replace AV control unit.

A
B
C
D
E
F
G
H
I
J
K
L
M
N
O
P

AV

RGB AREA (YS) SIGNAL CIRCUIT (AV CONTROL UNIT TO FRONT DISPLAY UNIT)

< COMPONENT DIAGNOSIS >

[BOSE AUDIO WITH NAVIGATION]

RGB AREA (YS) SIGNAL CIRCUIT (AV CONTROL UNIT TO FRONT DISPLAY UNIT)

Description

INFOID:000000003356641

Transmits the display area of RGB image displayed by AV control unit with RGB area (YS) signal to front display unit.

Diagnosis Procedure

INFOID:000000003356642

1. CHECK CONTINUITY RGB AREA (YS) SIGNAL CIRCUIT

1. Turn ignition switch OFF.
2. Disconnect front display unit connector and AV control unit connector.
3. Check continuity between front display unit harness connector and AV control unit harness connector.

Front display unit		AV control unit		Continuity
Connector	Terminal	Connector	Terminal	
M49	9	M146	67	Existed

4. Check continuity between front display unit harness connector and ground.

Front display unit		Ground	Continuity
Connector	Terminal		
M49	9		Not existed

Is the inspection result normal?

YES >> GO TO 2.

NO >> Repair harness or connector.

2. CHECK RGB AREA (YS) SIGNAL

1. Connect front display unit connector and AV control unit connector.
2. Turn ignition switch ON.
3. Check signal between front display unit harness connector and ground using an oscilloscope.

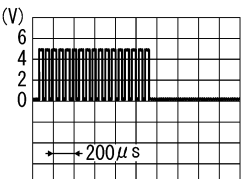
(+)		(-)	Condition	Signal
Front display unit				
Connector	Terminal			
M49	9	Ground	When RGB image is displayed.	Approx. 5.0 V
			When AUX image is displayed.	

PKIB4948J

Is the inspection result normal?

YES >> Replace front display unit.

NO >> Replace AV control unit.

HP SIGNAL CIRCUIT (FRONT DISPLAY UNIT TO AV CONTROL UNIT)

< COMPONENT DIAGNOSIS >

[BOSE AUDIO WITH NAVIGATION]

HP SIGNAL CIRCUIT (FRONT DISPLAY UNIT TO AV CONTROL UNIT)

Description

INFOID:000000003356643

In composite image (AUX image, camera image), transmit the vertical synchronizing (VP) signal and horizontal synchronizing (HP) signal from front display unit to AV control unit so as to synchronize the RGB images displayed with AV control unit such as the image quality adjusting menu, etc.

Diagnosis Procedure

INFOID:000000003356644

1. CHECK CONTINUITY HORIZONTAL SYNCHRONIZING (HP) SIGNAL CIRCUIT

1. Turn ignition switch OFF.
2. Disconnect front display unit connector and AV control unit connector.
3. Check continuity between front display unit harness connector and AV control unit harness connector.

Front display unit		AV control unit		Continuity
Connector	Terminal	Connector	Terminal	
M49	8	M146	68	Existed

4. Check continuity between front display unit harness connector and ground.

Front display unit		Ground	Continuity
Connector	Terminal		
M49	8		Not existed

Is the inspection result normal?

YES >> GO TO 2.

NO >> Repair harness or connector.

2. CHECK HORIZONTAL SYNCHRONIZING (HP) SIGNAL

1. Connect front display unit connector and AV control unit connector.
2. Turn ignition switch ON.
3. Check signal between front display unit harness connector and ground using an oscilloscope.

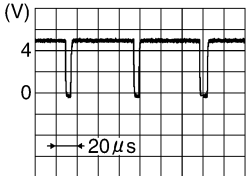
(+) Front display unit		(-)	Condition	Signal
Connector	Terminal			
M49	8	Ground	—	 <p>SKIB3603E</p>

Is the inspection result normal?

YES >> Replace AV control unit.

NO >> Replace front display unit.

A
B
C
D
E
F
G
H
I
J
K
L
M
N
O
P

AV

VP SIGNAL CIRCUIT (FRONT DISPLAY UNIT TO AV CONTROL UNIT)

< COMPONENT DIAGNOSIS >

[BOSE AUDIO WITH NAVIGATION]

VP SIGNAL CIRCUIT (FRONT DISPLAY UNIT TO AV CONTROL UNIT)

Description

INFOID:000000003356645

In composite image (AUX image, camera image), transmit the vertical synchronizing (VP) signal and horizontal synchronizing (HP) signal from front display unit to AV control unit so as to synchronize the RGB images displayed with AV control unit such as the image quality adjusting menu, etc.

Diagnosis Procedure

INFOID:000000003356646

1. CHECK CONTINUITY VERTICAL SYNCHRONIZING (VP) SIGNAL CIRCUIT

1. Turn ignition switch OFF.
2. Disconnect front display unit connector and AV control unit connector.
3. Check continuity between front display unit harness connector and AV control unit harness connector.

Front display unit		AV control unit		Continuity
Connector	Terminal	Connector	Terminal	
M49	20	M146	69	Existed

4. Check continuity between front display unit harness connector and ground.

Front display unit		Ground	Continuity
Connector	Terminal		
M49	20		Not existed

Is the inspection result normal?

- YES >> GO TO 2.
 NO >> Repair harness or connector.

2. CHECK VERTICAL SYNCHRONIZING (VP) SIGNAL

1. Connect front display unit connector and AV control unit connector.
2. Turn ignition switch ON.
3. Check signal between front display unit harness connector and ground using an oscilloscope.

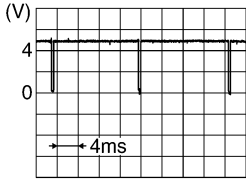
(+)		(-)	Condition	Signal
Front display unit				
Connector	Terminal			
M49	20	Ground	—	 <p>SKIB3598E</p>

Is the inspection result normal?

- YES >> Replace AV control unit.
 NO >> Replace front display unit.

AUX IMAGE SIGNAL CIRCUIT

< COMPONENT DIAGNOSIS >

[BOSE AUDIO WITH NAVIGATION]

AUX IMAGE SIGNAL CIRCUIT

Description

INFOID:000000003356647

Transmits the image signal of external device from auxiliary input jacks to front display unit.

Diagnosis Procedure

INFOID:000000003356648

1. CHECK CONTINUITY AUX IMAGE SIGNAL CIRCUIT

1. Turn ignition switch OFF.
2. Disconnect auxiliary input jacks connector and front display unit connector.
3. Check continuity between auxiliary input jacks harness connector and front display unit harness connector.

Auxiliary input jacks		Front display unit		Continuity
Connector	Terminals	Connector	Terminals	
M253	7	M49	15	Existed
	8		5	

4. Check continuity between front display unit harness connector and ground.

Front display unit		Ground	Continuity
Connector	Terminal		
M49	15		Not existed

Is the inspection result normal?

YES >> GO TO 2.

NO >> Repair harness or connector.

2. CHECK AUX IMAGE SIGNAL

1. Connect auxiliary input jacks connector and front display unit connector.
2. Turn ignition switch ON.
3. Check signal between AV control unit harness connector using an oscilloscope.

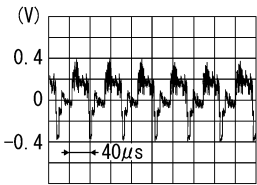
(+) Front display unit		(-) Front display unit		Condition	Signal
Connector	Terminal	Connector	Terminal		
M49	15	M49	5	When AUX image is displayed.	 <p>SKIB2251J</p>

Is the inspection result normal?

YES >> Replace front display unit.

NO >> Check that there is no malfunction in the external device.

A
B
C
D
E
F
G
H
I
J
K
L
M
N
O
P

AV

DISK EJECT SIGNAL CIRCUIT

< COMPONENT DIAGNOSIS >

[BOSE AUDIO WITH NAVIGATION]

DISK EJECT SIGNAL CIRCUIT

Description

INFOID:000000003356651

The disk eject signal is output to AV control unit when the disk eject switch of preset switch is pressed.

Diagnosis Procedure

INFOID:000000003356652

1. CHECK CONTINUITY CD EJECT SIGNAL CIRCUIT

1. Turn ignition switch OFF.
2. Disconnect multifunction switch connector and AV control unit connector.
3. Check continuity between multifunction switch harness connector and AV control unit harness connector.

Multifunction switch		AV control unit		Continuity
Connector	Terminal	Connector	Terminal	
M125	14	M147	85	Existed

4. Check continuity between multifunction switch harness connector and ground.

Multifunction switch		Ground	Continuity
Connector	Terminal		
M125	14		Not existed

Is the inspection result normal?

- YES >> GO TO 2.
NO >> Repair harness or connector.

2. CHECK AV CONTROL UNIT VOLTAGE

1. Connect AV control unit connector.
2. Turn ignition switch ON.
3. Check voltage between AV control unit harness connector terminal 85 and ground.

(+)		(-)	Voltage (Approx.)
AV control unit			
Connector	Terminal		
M147	85	Ground	5.0 V

Is the inspection result normal?

- YES >> Replace preset switch.
NO >> Replace AV control unit.

MICROPHONE SIGNAL CIRCUIT

< COMPONENT DIAGNOSIS >

[BOSE AUDIO WITH NAVIGATION]

MICROPHONE SIGNAL CIRCUIT

Description

INFOID:000000003356653

Supply power from AV control unit to microphone. The microphone transmits the sound/voice to the AV control unit.

Diagnosis Procedure

INFOID:000000003356654

1.CHECK CONTINUITY BETWEEN AV CONTROL UNIT AND MICROPHONE CIRCUIT

1. Turn ignition switch OFF.
2. Disconnect AV control unit connector and microphone connector.
3. Check continuity between AV control unit harness connector and microphone harness connector.

AV control unit		Microphone		Continuity
Connector	Terminals	Connector	Terminals	
M145	26	R20	4	Existed
	27		2	
	28		1	

4. Check continuity between AV control unit harness connector and ground.

AV control unit		Ground	Continuity
Connector	Terminals		
M145	26		Not existed
	28		

Is the inspection result normal?

YES >> GO TO 2.

NO >> Repair harness or connector.

2.CHECK VOLTAGE MICROPHONE VCC

1. Connect AV control unit connector.
2. Turn ignition switch ON.
3. Check voltage between AV control unit harness connector.

(+)		(-)		Voltage (Approx.)
AV control unit		AV control unit		
Connector	Terminal	Connector	Terminal	
M145	26	M145	27	5.0 V

Is the inspection result normal?

YES >> GO TO 3.

NO >> Replace AV control unit.

3.CHECK MICROPHONE SIGNAL

1. Connect microphone connector.
2. Check signal between AV control unit harness connector using an oscilloscope.

A
B
C
D
E
F
G
H
I
J
K
L
M
O
P

AV

MICROPHONE SIGNAL CIRCUIT

< COMPONENT DIAGNOSIS >

[BOSE AUDIO WITH NAVIGATION]

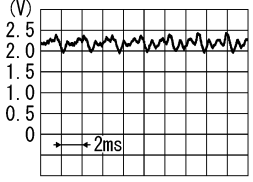
(+)		(-)		Condition	Signal
AV control unit		AV control unit			
Connector	Terminal	Connector	Terminal		
M145	28	M145	27	Give a voice	 <p style="text-align: right; font-size: small;">PKIB5037J</p>

Is the inspection result normal?

YES >> Replace AV control unit.

NO >> Replace microphone.

CAMERA IMAGE SIGNAL CIRCUIT (REAR VIEW CAMERA TO CAMERA CONTROL UNIT)

< COMPONENT DIAGNOSIS >

[BOSE AUDIO WITH NAVIGATION]

CAMERA IMAGE SIGNAL CIRCUIT (REAR VIEW CAMERA TO CAMERA CONTROL UNIT)

Description

INFOID:000000003356655

- Camera control unit outputs camera ON signal to rear view camera and inputs rear view camera image signal from rear view camera when the reverse signal is input.
- The camera control unit that inputs the camera image signal transmits the camera image signal to the front display unit.

Diagnosis Procedure

INFOID:000000003356656

1. CHECK CONTINUITY CAMERA IMAGE SIGNAL CIRCUIT

1. Turn ignition switch OFF.
2. Disconnect camera control unit connector and rear view camera connector.
3. Check continuity between camera control unit harness connector and rear view camera harness connector.

Camera control unit		Rear view camera		Continuity
Connector	Terminal	Connector	Terminal	
B60	6	D192	3	Existed

4. Check continuity between camera control unit harness connector and ground.

Camera control unit		Ground	Continuity
Connector	Terminal		
B60	6		Not existed

Is the inspection result normal?

YES >> GO TO 2.

NO >> Repair harness or connector.

2. CHECK CAMERA IMAGE SIGNAL

1. Connect camera control unit connector and rear view camera connector.
2. Turn ignition switch ON.
3. Check signal between camera control unit harness connector and ground using an oscilloscope.

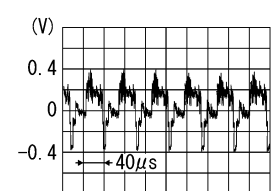
(+)		(-)	Condition	Signal
Camera control unit				
Connector	Terminal			
B60	6	Ground	Shift the selector lever to "R" position.	 <p style="text-align: right; font-size: small;">SKIB2251J</p>

Is the inspection result normal?

YES >> Replace camera control unit.

NO >> Replace rear view camera.

CAMERA ON SIGNAL CIRCUIT

< COMPONENT DIAGNOSIS >

[BOSE AUDIO WITH NAVIGATION]

CAMERA ON SIGNAL CIRCUIT

Description

INFOID:000000003356657

- Camera control unit outputs camera ON signal to rear view camera and inputs rear view camera image signal from rear view camera when the reverse signal is input.
- The camera control unit that inputs the camera image signal transmits the camera image signal to the front display unit.

Diagnosis Procedure

INFOID:000000003356658

1. CHECK CONTINUITY CAMERA ON SIGNAL CIRCUIT

1. Turn ignition switch OFF.
2. Disconnect camera control unit connector and rear view camera connector.
3. Check continuity between camera control unit harness connector and rear view camera harness connector.

Camera control unit		Rear view camera		Continuity
Connector	Terminal	Connector	Terminal	
B60	8	D192	1	Existed

4. Check continuity between camera control unit harness connector and ground.

Camera control unit		Ground	Continuity
Connector	Terminal		
B60	8		Not existed

Is the inspection result normal?

YES >> GO TO 2.

NO >> Repair harness or connector.

2. CHECK VOLTAGE CAMERA ON SIGNAL

1. Connect camera control unit connector and rear view camera connector.
2. Turn ignition switch ON.
3. Check signal between camera control unit harness connector and ground.

(+) Camera control unit		(-)	Condition	Voltage (Approx.)
Connector	Terminal			
B60	8	Ground	Shift the selector lever to "R" position.	6.0 V

Is the inspection result normal?

YES >> Replace rear view camera.

NO >> Replace camera control unit.

CAMERA IMAGE SIGNAL CIRCUIT (CAMERA CONTROL UNIT TO FRONT DISPLAY UNIT)

< COMPONENT DIAGNOSIS >

[BOSE AUDIO WITH NAVIGATION]

CAMERA IMAGE SIGNAL CIRCUIT (CAMERA CONTROL UNIT TO FRONT DISPLAY UNIT)

Description

INFOID:000000003356659

- Camera control unit outputs camera ON signal to rear view camera and inputs rear view camera image signal from rear view camera when the reverse signal is input.
- The camera control unit that inputs the camera image signal transmits the camera image signal to the front display unit.

Diagnosis Procedure

INFOID:000000003356660

1. CHECK CONTINUITY CAMERA IMAGE SIGNAL CIRCUIT

1. Turn ignition switch OFF.
2. Disconnect camera control unit connector and front display unit connector.
3. Check continuity between camera control unit harness connector and front display unit harness connector.

Camera control unit		Front display unit		Continuity
Connector	Terminals	Connector	Terminals	
B60	12	M49	12	Existed
	11		14	

4. Check continuity between camera control unit harness connector and ground.

Camera control unit		Ground	Continuity
Connector	Terminal		
B60	12		Not existed

Is the inspection result normal?

- YES >> GO TO 2.
 NO >> Repair harness or connector.

2. CHECK CAMERA IMAGE SIGNAL

1. Connect camera control unit connector and front display unit connector.
2. Turn ignition switch ON.
3. Check signal between camera control unit harness connector and ground using an oscilloscope.

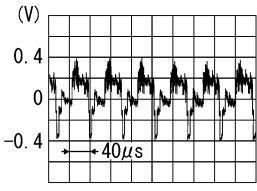
(+)		(-)	Condition	Signal
Camera control unit				
Connector	Terminal			
B60	12	Ground	Shift the selector lever to "R" position.	 <p style="text-align: right; font-size: small;">SKIB2251J</p>

Is the inspection result normal?

- YES >> Replace front display unit.
 NO >> Replace camera control unit.

STEERING ANGLE SENSOR SIGNAL CIRCUIT

< COMPONENT DIAGNOSIS >

[BOSE AUDIO WITH NAVIGATION]

STEERING ANGLE SENSOR SIGNAL CIRCUIT

Description

INFOID:000000003566413

- Steering angle sensor signal 1, 2 detects the turning direction and quantity of the steering and transmits it to the camera control unit.
- Steering angle sensor signal 3 detects the neutral position of the steering and transmits it to the camera control unit.
- Camera control unit performs the correction of neutral position with sensor signal 1, 2, 3 and vehicle speed signal.

Diagnosis Procedure

INFOID:000000003566414

1. CHECK CONTINUITY STEERING ANGLE SENSOR SIGNAL CIRCUIT

1. Turn ignition switch OFF.
2. Disconnect camera control unit connector and steering angle sensor connector.
3. Check continuity between camera control unit harness connector and steering angle sensor harness connector.

Camera control unit		Steering angle sensor		Continuity
Connector	Terminals	Connector	Terminals	
B60	23	M30	3	Existed
	24		6	
	25		8	

4. Check continuity between camera control unit harness connector and ground.

Camera control unit		Ground	Continuity
Connector	Terminals		
B60	23	Ground	Not existed
	24		
	25		

Is the inspection result normal?

YES >> GO TO 2.

NO >> Repair harness or connector.

2. CHECK VOLTAGE CAMERA CONTROL UNIT

1. Connect camera control unit connector.
2. Turn ignition switch ON.
3. Check voltage between camera control unit harness connector and ground.

(+)		(-)	Reference value (Approx.)
Camera control unit			
Connector	Terminals	Ground	5.0 V
B60	23		
	24		
	25		

Is the inspection result normal?

YES >> GO TO 3.

NO >> Replace camera control unit.

3. CHECK STEERING ANGLE SENSOR SIGNAL

1. Turn ignition switch OFF.
2. Connect steering angle sensor connector.

STEERING ANGLE SENSOR SIGNAL CIRCUIT

[BOSE AUDIO WITH NAVIGATION]

< COMPONENT DIAGNOSIS >

3. Turn ignition switch ON.
4. Check signal between camera control unit harness connector and ground.

(+)		(-)	Condition	Reference value
Connector	Terminals			
B60	23, 24	Ground	Turn the steering to the right	<p>SKIB3827E</p> <p>A: Sensor signal 1 B: Sensor signal 2</p>
			Turn the steering to the left	<p>SKIB3828E</p> <p>A: Sensor signal 1 B: Sensor signal 2</p>
	25	Ground	Turn the steering around the neutral position	<p>SKIB3829E</p> <p>A: Sensor signal 3 B: Sensor signal 1</p>

Is the inspection result normal?

- YES >> INSPECTION END
 NO >> Replace steering angle sensor.

A
B
C
D
E
F
G
H
I
J
K
L
M
O
P

AV

STEERING SWITCH SIGNAL A CIRCUIT

< COMPONENT DIAGNOSIS >

[BOSE AUDIO WITH NAVIGATION]

STEERING SWITCH SIGNAL A CIRCUIT

Description

INFOID:000000003356665

Transmits the steering switch signal to AV control unit.

Diagnosis Procedure

INFOID:000000003356666

1.CHECK STEERING SWITCH SIGNAL A CIRCUIT

1. Disconnect AV control unit connector and spiral cable connector.
2. Check continuity between AV control unit harness connector and spiral cable harness connector.

AV control unit		Spiral cable		Continuity
Connector	Terminal	Connector	Terminal	
M144	6	M33	24	Existed

3. Check continuity between AV control unit harness connector and ground.

AV control unit		Ground	Continuity
Connector	Terminal		
M144	6		Not existed

Is the inspection result normal?

- YES >> GO TO 2.
NO >> Repair harness or connector.

2.CHECK SPIRAL CABLE

Check spiral cable.

Is the inspection result normal?

- YES >> GO TO 3.
NO >> Replace spiral cable.

3.CHECK AV CONTROL UNIT VOLTAGE

1. Connect AV control unit connector and spiral cable connector.
2. Turn ignition switch ON.
3. Check voltage between AV control unit harness connector.

(+)		(-)		Voltage (Approx.)
AV control unit		AV control unit		
Connector	Terminal	Connector	Terminal	
M144	6	M144	15	5.0 V

Is the inspection result normal?

- YES >> GO TO 4.
NO >> Replace AV control unit.

4.CHECK STEERING SWITCH

1. Turn ignition switch OFF.
2. Check steering switch. Refer to [AV-641, "Component Inspection"](#).

Is the inspection result normal?

- YES >> INSPECTION END
NO >> Replace steering switch.

STEERING SWITCH SIGNAL A CIRCUIT

< COMPONENT DIAGNOSIS >

[BOSE AUDIO WITH NAVIGATION]

Component Inspection

INFOID:000000003356667

Measure the resistance between the steering switch connector terminals 14 to 17 and 15 to 17.

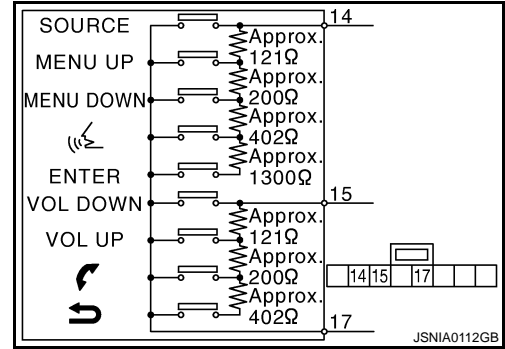

Standard

Steering switch				Condition	Resistance Ω
Con- nector	Termi- nal	Con- nector	Termi- nal		
M303	14	M303	17	ENTER switch ON	1983 – 2063
				↵ switch ON	709 – 737
				MENU DOWN switch ON	315 – 327
				MENU UP switch ON	119 – 123
				SOURCE switch ON	0
	15			↶ switch ON	709 – 737
				↷ switch ON	315 – 327
				VOL UP switch ON	119 – 123
				VOL DOWN switch ON	0

A
B
C
D
E
F
G
H
I
J
K
L
M

AV

STEERING SWITCH SIGNAL B CIRCUIT

< COMPONENT DIAGNOSIS >

[BOSE AUDIO WITH NAVIGATION]

STEERING SWITCH SIGNAL B CIRCUIT

Description

INFOID:000000003356668

Transmits the steering switch signal to AV control unit.

Diagnosis Procedure

INFOID:000000003356669

1. CHECK STEERING SWITCH SIGNAL B CIRCUIT

1. Disconnect AV control unit connector and spiral cable connector.
2. Check continuity between AV control unit harness connector and spiral cable harness connector.

AV control unit		Spiral cable		Continuity
Connector	Terminal	Connector	Terminal	
M144	16	M33	31	Existed

3. Check continuity between AV control unit harness connector and ground.

AV control unit		Ground	Continuity
Connector	Terminal		
M144	16		Not existed

Is the inspection result normal?

- YES >> GO TO 2.
NO >> Repair harness or connector.

2. CHECK SPIRAL CABLE

Check spiral cable.

Is the inspection result normal?

- YES >> GO TO 3.
NO >> Replace spiral cable.

3. CHECK AV CONTROL UNIT VOLTAGE

1. Connect AV control unit connector and spiral cable connector.
2. Turn ignition switch ON.
3. Check voltage between AV control unit harness connector.

(+)		(-)		Voltage (Approx.)
AV control unit		AV control unit		
Connector	Terminal	Connector	Terminal	
M144	16	M144	15	5.0 V

Is the inspection result normal?

- YES >> GO TO 4.
NO >> Replace AV control unit.

4. CHECK STEERING SWITCH

1. Turn ignition switch OFF.
2. Check steering switch. Refer to [AV-643, "Component Inspection"](#).

Is the inspection result normal?

- YES >> INSPECTION END
NO >> Replace steering switch.

STEERING SWITCH SIGNAL B CIRCUIT

< COMPONENT DIAGNOSIS >

[BOSE AUDIO WITH NAVIGATION]

INFOID:000000003470188

Component Inspection

Measure the resistance between the steering switch connector terminals 14 to 17 and 15 to 17.

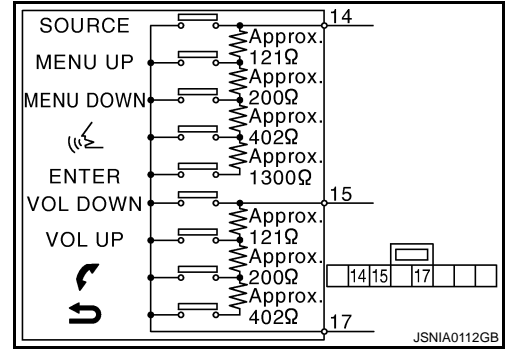

Standard

Steering switch				Condition	Resistance Ω
Con- nector	Termi- nal	Con- nector	Termi- nal		
M303	14	M303	17	ENTER switch ON	1983 – 2063
				⏏ switch ON	709 – 737
				MENU DOWN switch ON	315 – 327
				MENU UP switch ON	119 – 123
				SOURCE switch ON	0
	15			↶ switch ON	709 – 737
				↷ switch ON	315 – 327
				VOL UP switch ON	119 – 123
				VOL DOWN switch ON	0

A
B
C
D
E
F
G
H
I
J
K
L
M
N
O
P

AV

STEERING SWITCH SIGNAL GND CIRCUIT

< COMPONENT DIAGNOSIS >

[BOSE AUDIO WITH NAVIGATION]

STEERING SWITCH SIGNAL GND CIRCUIT

Description

INFOID:000000003356671

Transmits the steering switch signal to AV control unit.

Diagnosis Procedure

INFOID:000000003356672

1.CHECK STEERING SWITCH SIGNAL GND CIRCUIT

1. Disconnect AV control unit connector and spiral cable connector.
2. Check continuity between AV control unit harness connector and spiral cable harness connector.

AV control unit		Spiral cable		Continuity
Connector	Terminal	Connector	Terminal	
M144	15	M33	33	Existed

3. Connect AV control unit connector.

Is the inspection result normal?

- YES >> GO TO 2.
NO >> Repair harness or connector.

2.CHECK SPIRAL CABLE

Check spiral cable.

Is the inspection result normal?

- YES >> GO TO 3.
NO >> Replace spiral cable.

3.CHECK GROUND CIRCUIT

1. Connect AV control unit connector.
2. Check continuity between AV control unit harness connector and ground.

AV control unit		Ground	Continuity
Connector	Terminal		
M144	15		Existed

Is the inspection result normal?

- YES >> GO TO 4.
NO >> Replace AV control unit.

4.CHECK STEERING SWITCH

1. Turn ignition switch OFF.
2. Check steering switch. Refer to [AV-645. "Component Inspection"](#).

Is the inspection result normal?

- YES >> INSPECTION END
NO >> Replace steering switch.

STEERING SWITCH SIGNAL GND CIRCUIT

< COMPONENT DIAGNOSIS >

[BOSE AUDIO WITH NAVIGATION]

INFOID:000000003470189

Component Inspection

Measure the resistance between the steering switch connector terminals 14 to 17 and 15 to 17.

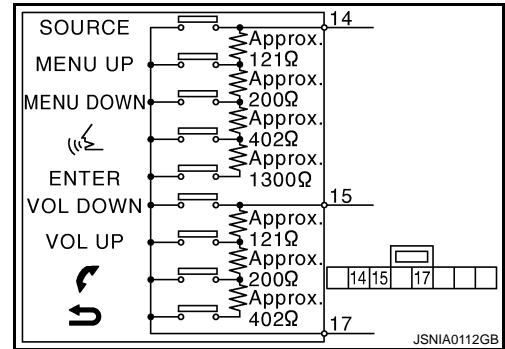

Standard

Steering switch				Condition	Resistance Ω
Con- nector	Termi- nal	Con- nector	Termi- nal		
M303	14	M303	17	ENTER switch ON	1983 – 2063
				⏏ switch ON	709 – 737
				MENU DOWN switch ON	315 – 327
				MENU UP switch ON	119 – 123
				SOURCE switch ON	0
	15			↶ switch ON	709 – 737
				↷ switch ON	315 – 327
				VOL UP switch ON	119 – 123
				VOL DOWN switch ON	0

A
B
C
D
E
F
G
H
I
J
K
L
M

AV

O
P

AV CONTROL UNIT

< ECU DIAGNOSIS >

[BOSE AUDIO WITH NAVIGATION]

ECU DIAGNOSIS

AV CONTROL UNIT

Reference Values

INFOID:000000003457761

VALUES ON THE DIAGNOSIS TOOL

CONSULT-III MONITOR ITEM

Monitor Item	Condition		Value/Status
VHCL SPD SIG	Ignition switch ON	Vehicle speed > 0 km/h (0 MPH)	On
		Vehicle speed = 0 km/h (0 MPH)	Off
PKB SIG	Ignition switch ON	Parking brake is applied.	On
		Parking brake is released.	Off
ILLUM SIG	Ignition switch ON	Light switch ON	On
		Light switch OFF	Off
IGN SIG	Ignition switch ON	—	On
	Ignition switch ACC	—	Off
REV SIG	Ignition switch ON	Selector lever in R position	On
		Selector lever in any position other than R	Off

TERMINAL LAYOUT

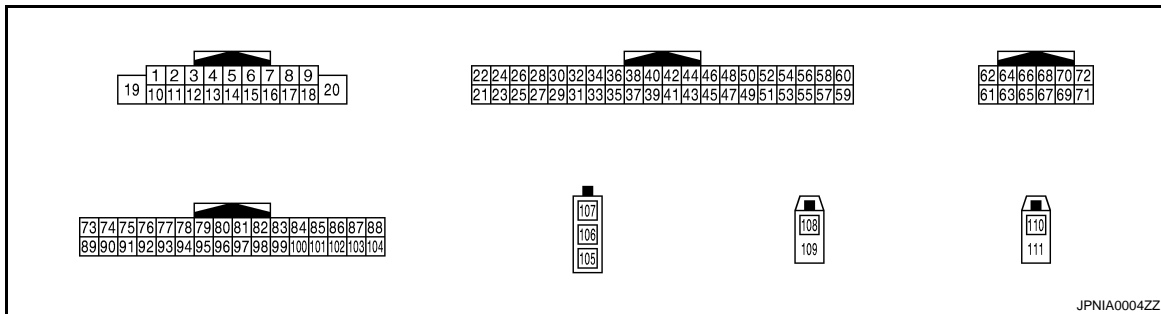

PHYSICAL VALUES





Terminal (Wire color)		Description		Input/Output	Condition	Reference value (Approx.)
+	-	Signal name				
1 (P)	Ground	Amp. ON signal	Output	Ignition switch ON	—	12.0 V
2 (G)	3 (R)	Sound signal front LH	Output	Ignition switch ON	Sound output.	

SKIB3609E

AV CONTROL UNIT

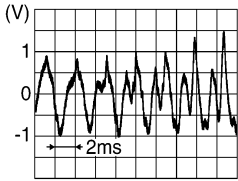
< ECU DIAGNOSIS >

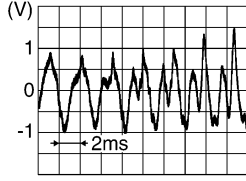
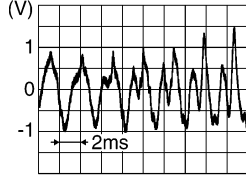
[BOSE AUDIO WITH NAVIGATION]

Terminal (Wire color)		Description		Condition		Reference value (Approx.)
+	-	Signal name	Input/ Output			
4 (O) ^{*1} (L) ^{*2}	5 (SB) ^{*1} (R) ^{*2}	Sound signal rear LH	Output	Ignition switch ON	Sound output.	 SKIB3609E
6 (BR)	15 (L)	Steering switch signal A	Input	Ignition switch ON	Keep pressing SOURCE switch.	0 V
					Keep pressing MENU UP switch.	1.0 V
					Keep pressing MENU DOWN switch.	2.0 V
					Keep pressing  switch.	3.0 V
					Keep pressing ENTER switch.	4.0 V
					Except for above.	5.0 V
7 (R)	Ground	ACC power supply	Input	Ignition switch ACC	—	Battery voltage
9 (R)	Ground	Illumination signal	Input	OFF	Lighting switch is OFF.	0 V
					Lighting switch is ON.	12.0 V
10	—	Shield	—	—	—	—
11 (B)	12 (W)	Sound signal front RH	Output	Ignition switch ON	Sound output.	 SKIB3609E
13 (V)	14 (LG)	Sound signal rear RH	Output	Ignition switch ON	Sound output.	 SKIB3609E
15 (L)	Ground	Steering switch signal GND	—	Ignition switch ON	—	0 V
16 (G)	15 (L)	Steering switch signal B	Input	Ignition switch ON	Keep pressing VOL DOWN switch.	0 V
					Keep pressing VOL UP switch.	1.0 V
					Keep pressing  switch.	2.0 V
					Keep pressing  switch.	3.0 V
					Except for above.	5.0 V

A
B
C
D
E
F
G
H
I
J
K
L
M
O
P

AV

AV CONTROL UNIT

< ECU DIAGNOSIS >

[BOSE AUDIO WITH NAVIGATION]

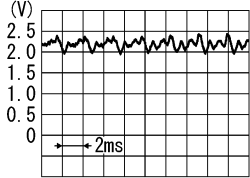
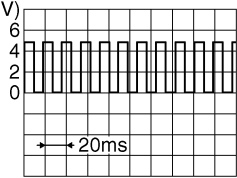
Terminal (Wire color)		Description		Condition		Reference value (Approx.)
+	-	Signal name	Input/ Output			
19 (Y)	Ground	Battery power supply	Input	Ignition switch OFF	—	Battery voltage
21 (B)	Ground	Ground	—	Ignition switch ON	—	0 V
22 (Y)	Ground	Battery power supply	Input	Ignition switch OFF	—	Battery voltage
23 (B)	Ground	Ground	—	Ignition switch ON	—	0 V
24 (Y)	Ground	Battery power supply	Input	Ignition switch OFF	—	Battery voltage
25 (R)	Ground	ACC power supply	Input	Ignition switch ACC	—	Battery voltage
26 (B)	27	Microphone VCC	Output	Ignition switch ON	—	5.0 V
27	Ground	Shield (Microphone ground)	—	Ignition switch ON	—	0 V
28 (W)	27	Microphone signal	Input	Ignition switch ON	Make a sound with your voice	 <p style="text-align: right; font-size: small;">PKIB5037J</p>
35 (G)	Ground	Ignition signal	Input	Ignition switch ON	—	Battery voltage
36 (G)	Ground	Parking brake signal	Input	Ignition switch ON	Parking brake ON.	0 V
					Parking brake OFF.	5.0 V
37 (SB)	Ground	Reverse signal	Input	Ignition switch ON	R position.	12.0 V
					Other than R position.	0 V
38 (V)	Ground	Vehicle speed signal (8- pulse)	Input	Ignition switch ON	When vehicle speed is ap- prox. 40 km/h (25MPH).	<p>NOTE: Maximum voltage may be 12 V due to specifications (connected units).</p>  <p style="text-align: right; font-size: small;">SKIA6649J</p>

AV CONTROL UNIT

< ECU DIAGNOSIS >

[BOSE AUDIO WITH NAVIGATION]

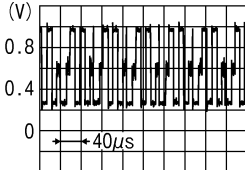
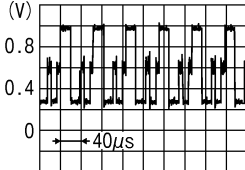
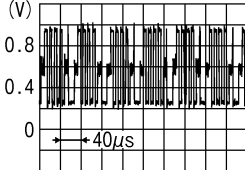
Terminal (Wire color)		Description		Condition		Reference value (Approx.)
+	-	Signal name	Input/ Output			
40 (P)	Ground	Camera-connection recognition signal	Input	Ignition switch ON	Connected to camera control unit connector.	0 V
					Not connected to camera control unit connector.	5.0 V
42 (B)	Ground	Control signal 2	Input	Ignition switch ON	—	0 V
43 (B)	Ground	Control signal 3	Input	Ignition switch ON	—	0 V
48 (G)	—	AV communication signal (H)	Input/ Output	—	—	—
49 (L)	—	AV communication signal (L)	Input/ Output	—	—	—
50 (R)	—	AV communication signal (H)	Input/ Output	—	—	—
51 (L)	—	AV communication signal (L)	Input/ Output	—	—	—
52 (L)	—	CAN-H	Input/ Output	—	—	—
53 (P)	—	CAN-L	Input/ Output	—	—	—
61 (G)	Ground	RGB image signal (R: red)	Output	Ignition switch ON	Start confirmation/adjustment mode, and then display color bar by selecting "Color Spectrum Bar" on DISPLAY DIAGNOSIS screen.	 <p style="text-align: right; font-size: small;">JSNIA1029ZZ</p>
62 (R)	Ground	RGB image signal (G: green)	Output	Ignition switch ON	Start confirmation/adjustment mode, and then display color bar by selecting "Color Spectrum Bar" on DISPLAY DIAGNOSIS screen.	 <p style="text-align: right; font-size: small;">JSNIA1030ZZ</p>
63 (W)	Ground	RGB image signal (B: blue)	Output	Ignition switch ON	Start confirmation/adjustment mode, and then display color bar by selecting "Color Spectrum Bar" on DISPLAY DIAGNOSIS screen.	 <p style="text-align: right; font-size: small;">JSNIA1031ZZ</p>
64	—	Shield	—	—	—	—

A
B
C
D
E
F
G
H
I
J
K
L
M
AV
O
P

AV CONTROL UNIT

< ECU DIAGNOSIS >

[BOSE AUDIO WITH NAVIGATION]

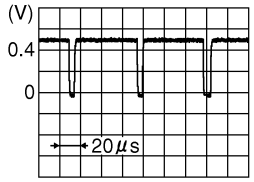
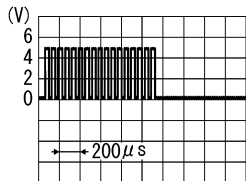
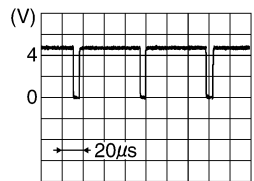
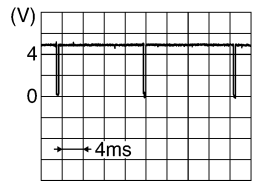
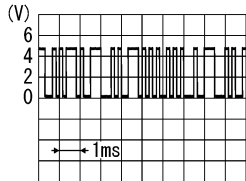
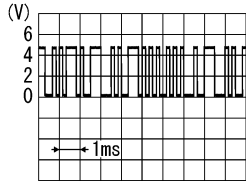
Terminal (Wire color)		Description		Condition		Reference value (Approx.)
+	-	Signal name	Input/ Output			
65 (B)	Ground	RGB synchronizing signal	Output	Ignition switch ON	—	 <p style="text-align: right; font-size: small;">JPNIA0461GB</p>
66	—	Shield	—	—	—	—
67 (W)	Ground	RGB area (YS) signal	Output	Ignition switch ON	When RGB image is displayed.	5.0 V
				Ignition switch ON	When rear view camera image is displayed.	 <p style="text-align: right; font-size: small;">PKIB4948J</p>
68 (B)	Ground	Horizontal synchronizing (HP) signal	Input	Ignition switch ON	—	 <p style="text-align: right; font-size: small;">SKIB3601E</p>
69 (R)	Ground	Vertical synchronizing (VP) signal	Input	Ignition switch ON	—	 <p style="text-align: right; font-size: small;">SKIB3598E</p>
70 (R)	Ground	Communication signal (CONT→DISP)	Output	Ignition switch ON	When adjusting display brightness.	 <p style="text-align: right; font-size: small;">PKIB5039J</p>
71 (G)	Ground	Communication signal (DISP→CONT)	Input	Ignition switch ON	When adjusting display brightness.	 <p style="text-align: right; font-size: small;">PKIB5039J</p>
72	—	Shield	—	—	—	—

AV CONTROL UNIT

< ECU DIAGNOSIS >

[BOSE AUDIO WITH NAVIGATION]

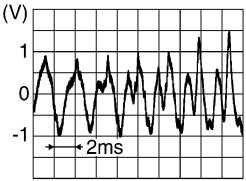
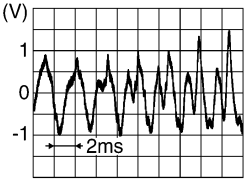
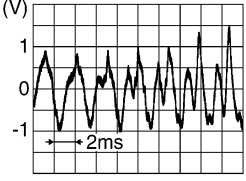
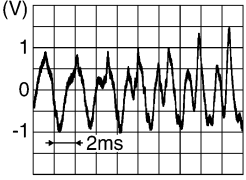
Terminal (Wire color)		Description		Condition		Reference value (Approx.)
+	-	Signal name	Input/ Output			
79 (BR)	95 (L)	iPod sound signal LH	Input	Ignition switch ON	When iPod mode is select- ed.	 <small>SKIB3609E</small>
80 (R)	96 (W)	iPod sound signal RH	Input	Ignition switch ON	When iPod mode is select- ed.	 <small>SKIB3609E</small>
81	—	Shield	—	—	—	—
85 (W)	Ground	Eject signal	Input	—	Pressing the eject switch.	0 V
					Except for above.	5.0 V
86	—	Shield	—	—	—	—
87 (B)	88 (W)	AUX sound signal LH	Input	Ignition switch ON	When AUX mode is select- ed.	 <small>SKIB3609E</small>
102 (V)	Ground	SW ground	—	Ignition switch ON	—	0 V
103 (R)	88 (W)	AUX sound signal RH	Input	Ignition switch ON	When AUX mode is select- ed.	 <small>SKIB3609E</small>
105	—	FM sub	Input	—	—	—
106	—	AM-FM main	Input	—	—	—
107	Ground	Antenna amp. ON signal	Output	Ignition switch ON	—	12.0 V
108	Ground	Satellite antenna signal	Input	Ignition switch ON	Not connected to satellite antenna connector.	5.0 V
109	—	Shield	—	—	—	—
110	Ground	GPS antenna signal	Input	Ignition switch ON	Not connected to GPS an- tenna connector.	5.0 V
111	—	Shield	—	—	—	—

A
B
C
D
E
F
G
H
I
J
K
L
M
AV

AV CONTROL UNIT

< ECU DIAGNOSIS >

[BOSE AUDIO WITH NAVIGATION]

*1: Type A

*2: Type B

Wiring Diagram - BOSE AUDIO WITH NAVIGATION SYSTEM -

INFOID:000000003457762

NOTE:

In this section, PRESET SWITCH and MULTIFUNCTION SWITCH are written as the MULTIFUNCTION SWITCH.

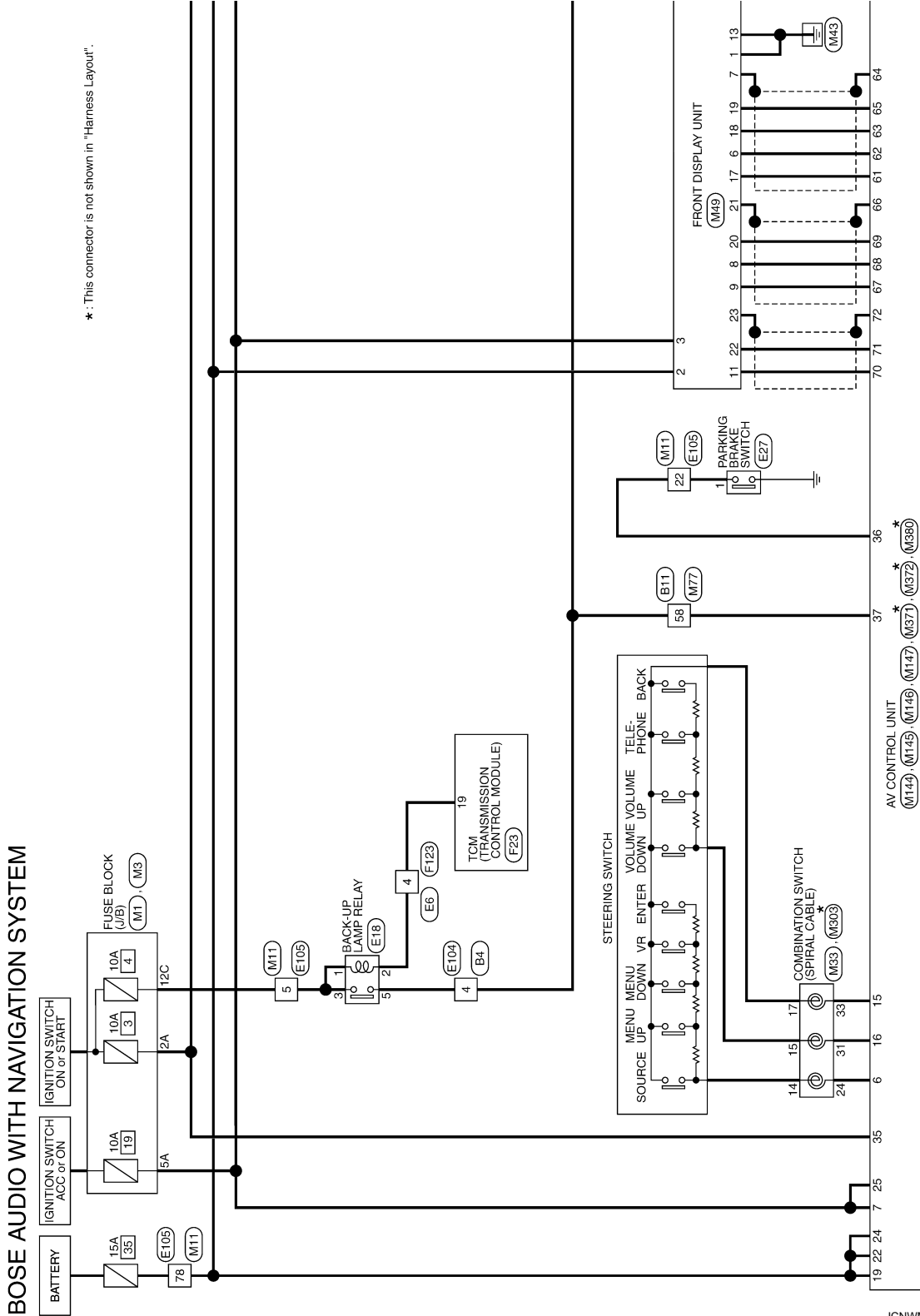

*: This connector is not shown in "Harness Layout".

2008/09/23

JCNWM1838GI

AV CONTROL UNIT

[BOSE AUDIO WITH NAVIGATION]

< ECU DIAGNOSIS >

WI: With iPod

*: This connector is not shown in "Harness Layout".

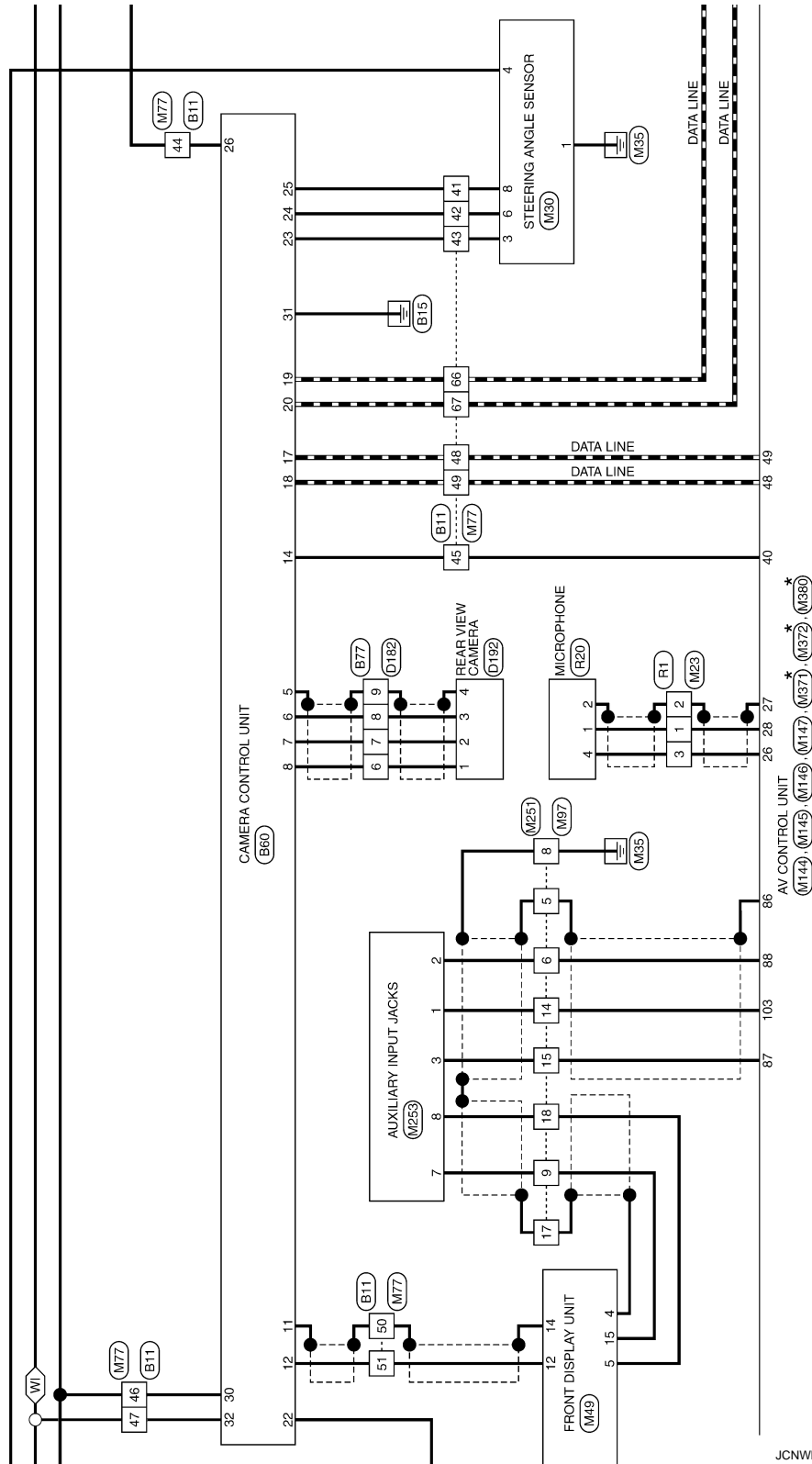

JCNWM1839GI

A
B
C
D
E
F
G
H
I
J
K
L
M
N
O
P

AV

AV CONTROL UNIT

[BOSE AUDIO WITH NAVIGATION]

< ECU DIAGNOSIS >

WI : With iPod
AB : With automatic back door
OA : Without automatic back door

* : This connector is not shown in "Harness Layout".

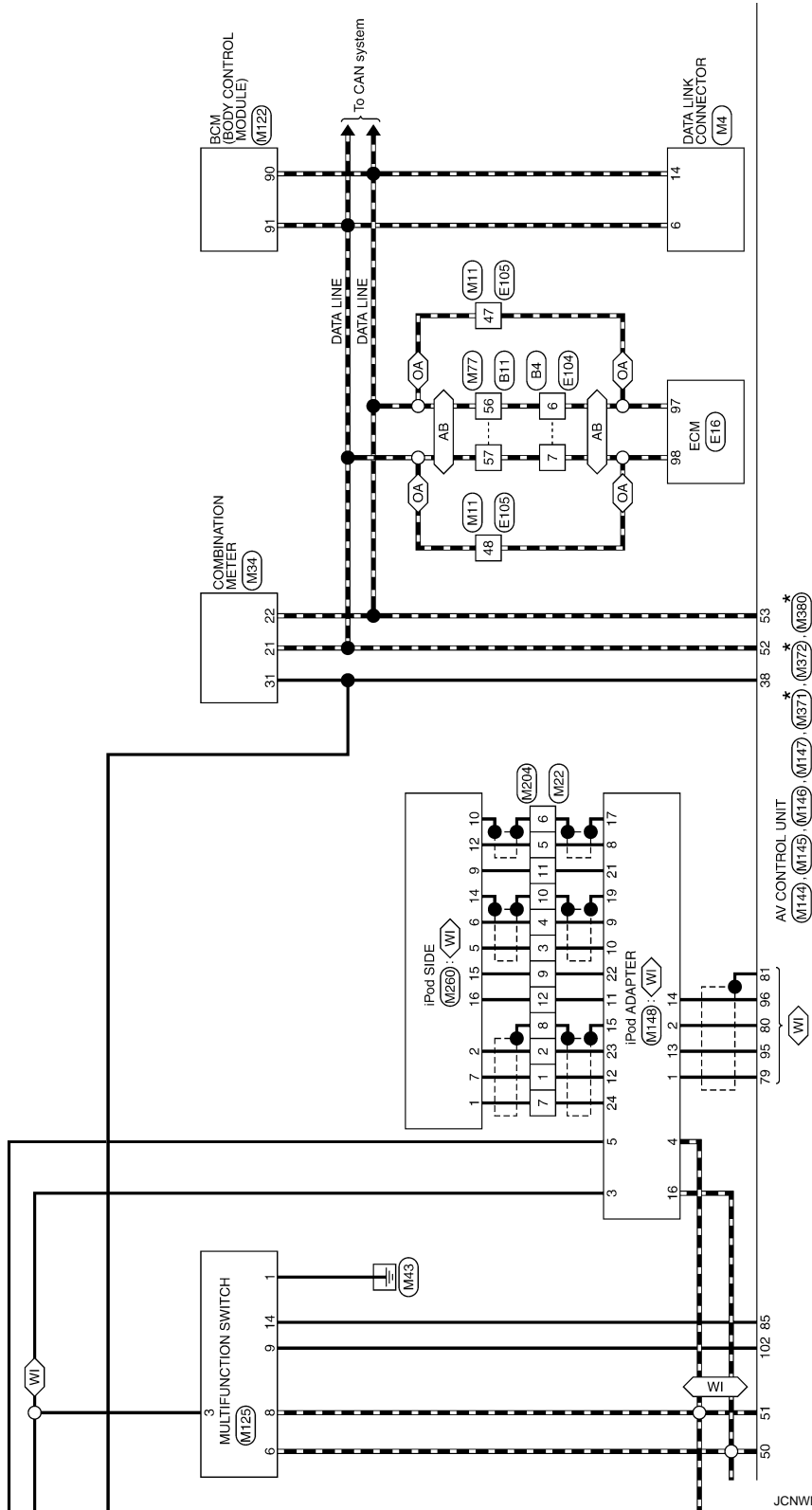

JCNWM1840GI

AV CONTROL UNIT

< ECU DIAGNOSIS >

[BOSE AUDIO WITH NAVIGATION]

*: This connector is not shown in "Harness Layout".

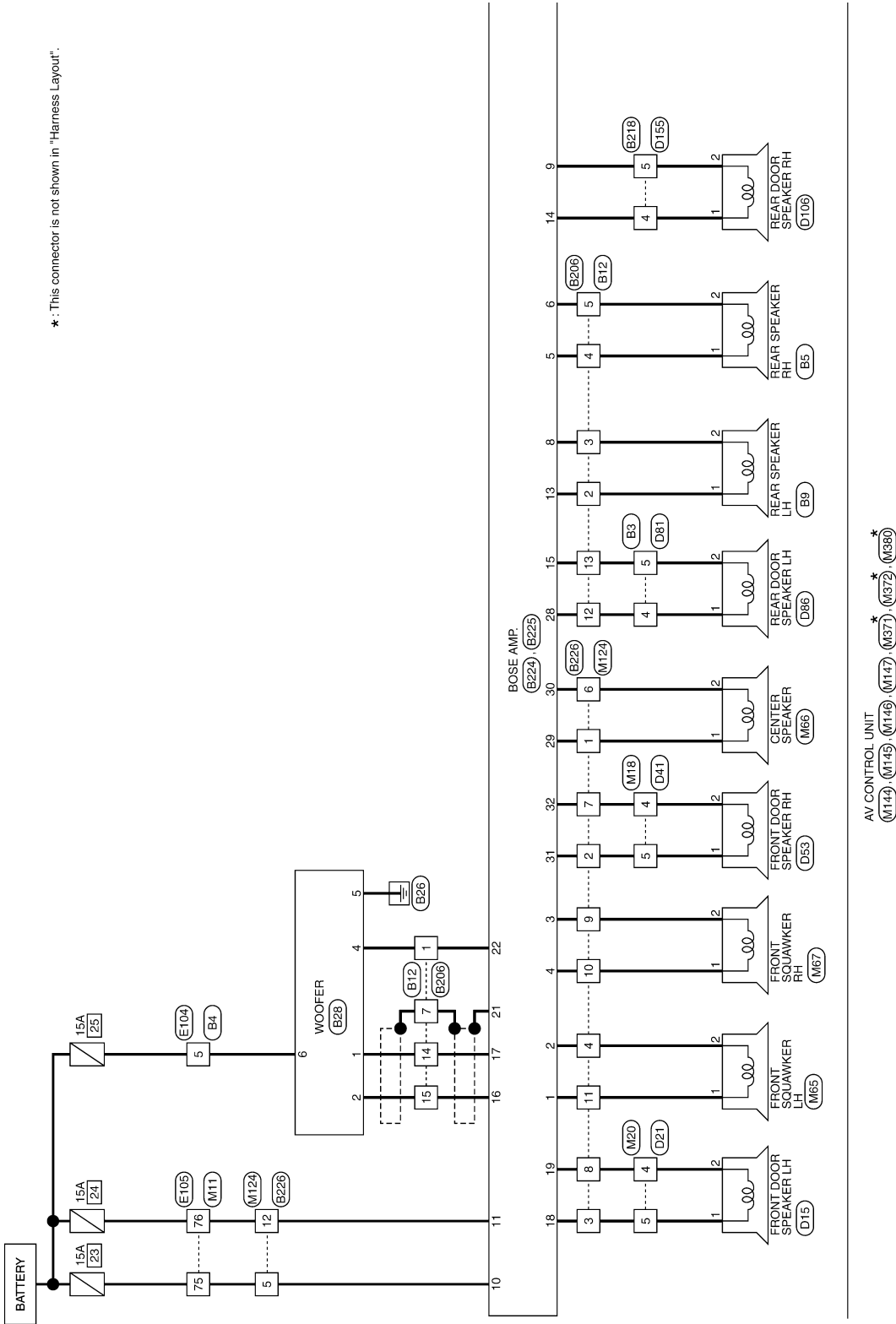

JCNWM1841G1

A
B
C
D
E
F
G
H
I
J
K
L
M
N
O
P

AV

AV CONTROL UNIT

< ECU DIAGNOSIS >

[BOSE AUDIO WITH NAVIGATION]

* This connector is not shown in "Harness Layout".

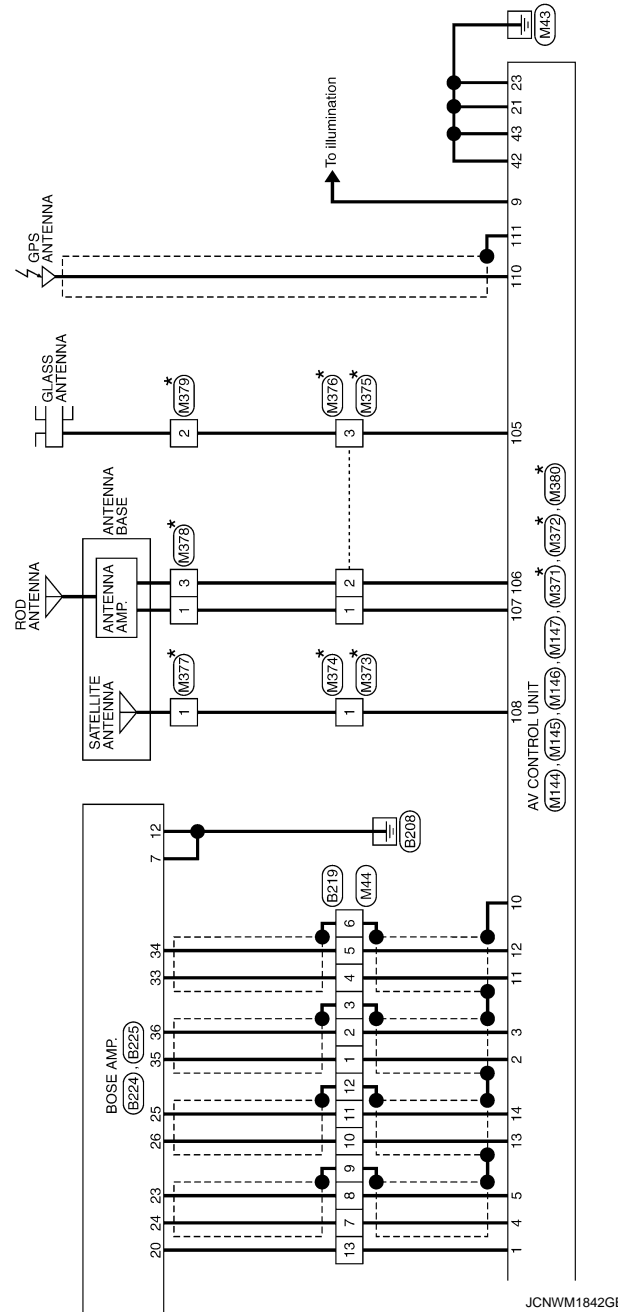

















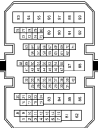





AV CONTROL UNIT

< ECU DIAGNOSIS >

[BOSE AUDIO WITH NAVIGATION]

BOSE AUDIO WITH NAVIGATION SYSTEM

<table border="1"> <tr><td>Connector No.</td><td>B3</td></tr> <tr><td>Connector Name</td><td>WIRE TO WIRE</td></tr> <tr><td>Connector Type</td><td>TK0FW-ANS</td></tr> </table>   <table border="1"> <tr><th>Terminal No.</th><th>Color of Wire</th><th>Signal Name [Specification]</th></tr> <tr><td>4</td><td>LG</td><td>-</td></tr> <tr><td>5</td><td>O</td><td>-</td></tr> </table>	Connector No.	B3	Connector Name	WIRE TO WIRE	Connector Type	TK0FW-ANS	Terminal No.	Color of Wire	Signal Name [Specification]	4	LG	-	5	O	-	<table border="1"> <tr><td>Connector No.</td><td>B4</td></tr> <tr><td>Connector Name</td><td>WIRE TO WIRE</td></tr> <tr><td>Connector Type</td><td>NS16MW-CS</td></tr> </table>   <table border="1"> <tr><th>Terminal No.</th><th>Color of Wire</th><th>Signal Name [Specification]</th></tr> <tr><td>4</td><td>R</td><td>-</td></tr> <tr><td>5</td><td>O</td><td>-</td></tr> <tr><td>6</td><td>P</td><td>-</td></tr> <tr><td>7</td><td>L</td><td>-</td></tr> </table>	Connector No.	B4	Connector Name	WIRE TO WIRE	Connector Type	NS16MW-CS	Terminal No.	Color of Wire	Signal Name [Specification]	4	R	-	5	O	-	6	P	-	7	L	-	<table border="1"> <tr><td>Connector No.</td><td>B5</td></tr> <tr><td>Connector Name</td><td>REAR SPEAKER RH</td></tr> <tr><td>Connector Type</td><td>TK0ZFBR</td></tr> </table>   <table border="1"> <tr><th>Terminal No.</th><th>Color of Wire</th><th>Signal Name [Specification]</th></tr> <tr><td>1</td><td>V</td><td>-</td></tr> <tr><td>2</td><td>LG</td><td>-</td></tr> </table>	Connector No.	B5	Connector Name	REAR SPEAKER RH	Connector Type	TK0ZFBR	Terminal No.	Color of Wire	Signal Name [Specification]	1	V	-	2	LG	-	<table border="1"> <tr><td>Connector No.</td><td>B8</td></tr> <tr><td>Connector Name</td><td>REAR SPEAKER LH</td></tr> <tr><td>Connector Type</td><td>TK0ZFBR</td></tr> </table>   <table border="1"> <tr><th>Terminal No.</th><th>Color of Wire</th><th>Signal Name [Specification]</th></tr> <tr><td>1</td><td>SB</td><td>-</td></tr> <tr><td>2</td><td>GR</td><td>-</td></tr> </table>	Connector No.	B8	Connector Name	REAR SPEAKER LH	Connector Type	TK0ZFBR	Terminal No.	Color of Wire	Signal Name [Specification]	1	SB	-	2	GR	-																																																															
Connector No.	B3																																																																																																																																			
Connector Name	WIRE TO WIRE																																																																																																																																			
Connector Type	TK0FW-ANS																																																																																																																																			
Terminal No.	Color of Wire	Signal Name [Specification]																																																																																																																																		
4	LG	-																																																																																																																																		
5	O	-																																																																																																																																		
Connector No.	B4																																																																																																																																			
Connector Name	WIRE TO WIRE																																																																																																																																			
Connector Type	NS16MW-CS																																																																																																																																			
Terminal No.	Color of Wire	Signal Name [Specification]																																																																																																																																		
4	R	-																																																																																																																																		
5	O	-																																																																																																																																		
6	P	-																																																																																																																																		
7	L	-																																																																																																																																		
Connector No.	B5																																																																																																																																			
Connector Name	REAR SPEAKER RH																																																																																																																																			
Connector Type	TK0ZFBR																																																																																																																																			
Terminal No.	Color of Wire	Signal Name [Specification]																																																																																																																																		
1	V	-																																																																																																																																		
2	LG	-																																																																																																																																		
Connector No.	B8																																																																																																																																			
Connector Name	REAR SPEAKER LH																																																																																																																																			
Connector Type	TK0ZFBR																																																																																																																																			
Terminal No.	Color of Wire	Signal Name [Specification]																																																																																																																																		
1	SB	-																																																																																																																																		
2	GR	-																																																																																																																																		
<table border="1"> <tr><td>Connector No.</td><td>B11</td></tr> <tr><td>Connector Name</td><td>WIRE TO WIRE</td></tr> <tr><td>Connector Type</td><td>TH80MW-CS19</td></tr> </table>   <table border="1"> <tr><th>Terminal No.</th><th>Color of Wire</th><th>Signal Name [Specification]</th></tr> <tr><td>56</td><td>P</td><td>-</td></tr> <tr><td>57</td><td>L</td><td>-</td></tr> <tr><td>58</td><td>R</td><td>-</td></tr> <tr><td>66</td><td>GR</td><td>-</td></tr> <tr><td>67</td><td>G</td><td>-</td></tr> </table>	Connector No.	B11	Connector Name	WIRE TO WIRE	Connector Type	TH80MW-CS19	Terminal No.	Color of Wire	Signal Name [Specification]	56	P	-	57	L	-	58	R	-	66	GR	-	67	G	-	<table border="1"> <tr><td>Connector No.</td><td>B12</td></tr> <tr><td>Connector Name</td><td>WIRE TO WIRE</td></tr> <tr><td>Connector Type</td><td>NS18FW-CS</td></tr> </table>   <table border="1"> <tr><th>Terminal No.</th><th>Color of Wire</th><th>Signal Name [Specification]</th></tr> <tr><td>7</td><td>W</td><td>-</td></tr> <tr><td>2</td><td>SB</td><td>-</td></tr> <tr><td>3</td><td>GR</td><td>-</td></tr> <tr><td>4</td><td>V</td><td>-</td></tr> <tr><td>5</td><td>LG</td><td>-</td></tr> <tr><td>7</td><td>SHIELD</td><td>-</td></tr> <tr><td>12</td><td>LG</td><td>-</td></tr> <tr><td>13</td><td>O</td><td>-</td></tr> <tr><td>14</td><td>W/R</td><td>-</td></tr> <tr><td>15</td><td>B/R</td><td>-</td></tr> </table>	Connector No.	B12	Connector Name	WIRE TO WIRE	Connector Type	NS18FW-CS	Terminal No.	Color of Wire	Signal Name [Specification]	7	W	-	2	SB	-	3	GR	-	4	V	-	5	LG	-	7	SHIELD	-	12	LG	-	13	O	-	14	W/R	-	15	B/R	-	<table border="1"> <tr><td>Connector No.</td><td>B17Z</td></tr> <tr><td>Connector Name</td><td>WOOFER</td></tr> <tr><td>Connector Type</td><td>RS08FGY-PR</td></tr> </table>   <table border="1"> <tr><th>Terminal No.</th><th>Color of Wire</th><th>Signal Name [Specification]</th></tr> <tr><td>1</td><td>W/R</td><td>SOUND SIGNAL WOOFER (-)</td></tr> <tr><td>2</td><td>B/R</td><td>SOUND SIGNAL WOOFER (+)</td></tr> <tr><td>4</td><td>W</td><td>WOOFER AMP. ON SIGNAL</td></tr> <tr><td>5</td><td>B/W</td><td>GND</td></tr> <tr><td>6</td><td>O</td><td>BAT</td></tr> </table>	Connector No.	B17Z	Connector Name	WOOFER	Connector Type	RS08FGY-PR	Terminal No.	Color of Wire	Signal Name [Specification]	1	W/R	SOUND SIGNAL WOOFER (-)	2	B/R	SOUND SIGNAL WOOFER (+)	4	W	WOOFER AMP. ON SIGNAL	5	B/W	GND	6	O	BAT	<table border="1"> <tr><td>Connector No.</td><td>B28</td></tr> <tr><td>Connector Name</td><td>WOOFER</td></tr> <tr><td>Connector Type</td><td>RS08FGY-PR</td></tr> </table>   <table border="1"> <tr><th>Terminal No.</th><th>Color of Wire</th><th>Signal Name [Specification]</th></tr> <tr><td>1</td><td>W/R</td><td>SOUND SIGNAL WOOFER (-)</td></tr> <tr><td>2</td><td>B/R</td><td>SOUND SIGNAL WOOFER (+)</td></tr> <tr><td>4</td><td>W</td><td>WOOFER AMP. ON SIGNAL</td></tr> <tr><td>5</td><td>B/W</td><td>GND</td></tr> <tr><td>6</td><td>O</td><td>BAT</td></tr> </table>	Connector No.	B28	Connector Name	WOOFER	Connector Type	RS08FGY-PR	Terminal No.	Color of Wire	Signal Name [Specification]	1	W/R	SOUND SIGNAL WOOFER (-)	2	B/R	SOUND SIGNAL WOOFER (+)	4	W	WOOFER AMP. ON SIGNAL	5	B/W	GND	6	O	BAT																		
Connector No.	B11																																																																																																																																			
Connector Name	WIRE TO WIRE																																																																																																																																			
Connector Type	TH80MW-CS19																																																																																																																																			
Terminal No.	Color of Wire	Signal Name [Specification]																																																																																																																																		
56	P	-																																																																																																																																		
57	L	-																																																																																																																																		
58	R	-																																																																																																																																		
66	GR	-																																																																																																																																		
67	G	-																																																																																																																																		
Connector No.	B12																																																																																																																																			
Connector Name	WIRE TO WIRE																																																																																																																																			
Connector Type	NS18FW-CS																																																																																																																																			
Terminal No.	Color of Wire	Signal Name [Specification]																																																																																																																																		
7	W	-																																																																																																																																		
2	SB	-																																																																																																																																		
3	GR	-																																																																																																																																		
4	V	-																																																																																																																																		
5	LG	-																																																																																																																																		
7	SHIELD	-																																																																																																																																		
12	LG	-																																																																																																																																		
13	O	-																																																																																																																																		
14	W/R	-																																																																																																																																		
15	B/R	-																																																																																																																																		
Connector No.	B17Z																																																																																																																																			
Connector Name	WOOFER																																																																																																																																			
Connector Type	RS08FGY-PR																																																																																																																																			
Terminal No.	Color of Wire	Signal Name [Specification]																																																																																																																																		
1	W/R	SOUND SIGNAL WOOFER (-)																																																																																																																																		
2	B/R	SOUND SIGNAL WOOFER (+)																																																																																																																																		
4	W	WOOFER AMP. ON SIGNAL																																																																																																																																		
5	B/W	GND																																																																																																																																		
6	O	BAT																																																																																																																																		
Connector No.	B28																																																																																																																																			
Connector Name	WOOFER																																																																																																																																			
Connector Type	RS08FGY-PR																																																																																																																																			
Terminal No.	Color of Wire	Signal Name [Specification]																																																																																																																																		
1	W/R	SOUND SIGNAL WOOFER (-)																																																																																																																																		
2	B/R	SOUND SIGNAL WOOFER (+)																																																																																																																																		
4	W	WOOFER AMP. ON SIGNAL																																																																																																																																		
5	B/W	GND																																																																																																																																		
6	O	BAT																																																																																																																																		
<table border="1"> <tr><td>Connector No.</td><td>B31</td></tr> <tr><td>Connector Name</td><td>WIRE TO WIRE</td></tr> <tr><td>Connector Type</td><td>TH80MW-CS19</td></tr> </table>   <table border="1"> <tr><th>Terminal No.</th><th>Color of Wire</th><th>Signal Name [Specification]</th></tr> <tr><td>41</td><td>O</td><td>-</td></tr> <tr><td>42</td><td>SB</td><td>-</td></tr> <tr><td>43</td><td>G</td><td>-</td></tr> <tr><td>44</td><td>BR</td><td>-</td></tr> <tr><td>45</td><td>L</td><td>-</td></tr> <tr><td>46</td><td>GR</td><td>-</td></tr> <tr><td>47</td><td>V</td><td>-</td></tr> <tr><td>48</td><td>BR</td><td>-</td></tr> <tr><td>49</td><td>Y</td><td>-</td></tr> <tr><td>50</td><td>SHIELD</td><td>-</td></tr> <tr><td>51</td><td>B</td><td>-</td></tr> </table>	Connector No.	B31	Connector Name	WIRE TO WIRE	Connector Type	TH80MW-CS19	Terminal No.	Color of Wire	Signal Name [Specification]	41	O	-	42	SB	-	43	G	-	44	BR	-	45	L	-	46	GR	-	47	V	-	48	BR	-	49	Y	-	50	SHIELD	-	51	B	-	<table border="1"> <tr><td>Connector No.</td><td>B12Z</td></tr> <tr><td>Connector Name</td><td>WIRE TO WIRE</td></tr> <tr><td>Connector Type</td><td>NS18FW-CS</td></tr> </table>   <table border="1"> <tr><th>Terminal No.</th><th>Color of Wire</th><th>Signal Name [Specification]</th></tr> <tr><td>1</td><td>W</td><td>-</td></tr> <tr><td>2</td><td>SB</td><td>-</td></tr> <tr><td>3</td><td>GR</td><td>-</td></tr> <tr><td>4</td><td>V</td><td>-</td></tr> <tr><td>5</td><td>LG</td><td>-</td></tr> <tr><td>7</td><td>SHIELD</td><td>-</td></tr> <tr><td>12</td><td>LG</td><td>-</td></tr> <tr><td>13</td><td>O</td><td>-</td></tr> <tr><td>14</td><td>W/R</td><td>-</td></tr> <tr><td>15</td><td>B/R</td><td>-</td></tr> </table>	Connector No.	B12Z	Connector Name	WIRE TO WIRE	Connector Type	NS18FW-CS	Terminal No.	Color of Wire	Signal Name [Specification]	1	W	-	2	SB	-	3	GR	-	4	V	-	5	LG	-	7	SHIELD	-	12	LG	-	13	O	-	14	W/R	-	15	B/R	-	<table border="1"> <tr><td>Connector No.</td><td>B28</td></tr> <tr><td>Connector Name</td><td>WOOFER</td></tr> <tr><td>Connector Type</td><td>RS08FGY-PR</td></tr> </table>   <table border="1"> <tr><th>Terminal No.</th><th>Color of Wire</th><th>Signal Name [Specification]</th></tr> <tr><td>1</td><td>W/R</td><td>SOUND SIGNAL WOOFER (-)</td></tr> <tr><td>2</td><td>B/R</td><td>SOUND SIGNAL WOOFER (+)</td></tr> <tr><td>4</td><td>W</td><td>WOOFER AMP. ON SIGNAL</td></tr> <tr><td>5</td><td>B/W</td><td>GND</td></tr> <tr><td>6</td><td>O</td><td>BAT</td></tr> </table>	Connector No.	B28	Connector Name	WOOFER	Connector Type	RS08FGY-PR	Terminal No.	Color of Wire	Signal Name [Specification]	1	W/R	SOUND SIGNAL WOOFER (-)	2	B/R	SOUND SIGNAL WOOFER (+)	4	W	WOOFER AMP. ON SIGNAL	5	B/W	GND	6	O	BAT	<table border="1"> <tr><td>Connector No.</td><td>B28</td></tr> <tr><td>Connector Name</td><td>WOOFER</td></tr> <tr><td>Connector Type</td><td>RS08FGY-PR</td></tr> </table>   <table border="1"> <tr><th>Terminal No.</th><th>Color of Wire</th><th>Signal Name [Specification]</th></tr> <tr><td>1</td><td>W/R</td><td>SOUND SIGNAL WOOFER (-)</td></tr> <tr><td>2</td><td>B/R</td><td>SOUND SIGNAL WOOFER (+)</td></tr> <tr><td>4</td><td>W</td><td>WOOFER AMP. ON SIGNAL</td></tr> <tr><td>5</td><td>B/W</td><td>GND</td></tr> <tr><td>6</td><td>O</td><td>BAT</td></tr> </table>	Connector No.	B28	Connector Name	WOOFER	Connector Type	RS08FGY-PR	Terminal No.	Color of Wire	Signal Name [Specification]	1	W/R	SOUND SIGNAL WOOFER (-)	2	B/R	SOUND SIGNAL WOOFER (+)	4	W	WOOFER AMP. ON SIGNAL	5	B/W	GND	6	O	BAT
Connector No.	B31																																																																																																																																			
Connector Name	WIRE TO WIRE																																																																																																																																			
Connector Type	TH80MW-CS19																																																																																																																																			
Terminal No.	Color of Wire	Signal Name [Specification]																																																																																																																																		
41	O	-																																																																																																																																		
42	SB	-																																																																																																																																		
43	G	-																																																																																																																																		
44	BR	-																																																																																																																																		
45	L	-																																																																																																																																		
46	GR	-																																																																																																																																		
47	V	-																																																																																																																																		
48	BR	-																																																																																																																																		
49	Y	-																																																																																																																																		
50	SHIELD	-																																																																																																																																		
51	B	-																																																																																																																																		
Connector No.	B12Z																																																																																																																																			
Connector Name	WIRE TO WIRE																																																																																																																																			
Connector Type	NS18FW-CS																																																																																																																																			
Terminal No.	Color of Wire	Signal Name [Specification]																																																																																																																																		
1	W	-																																																																																																																																		
2	SB	-																																																																																																																																		
3	GR	-																																																																																																																																		
4	V	-																																																																																																																																		
5	LG	-																																																																																																																																		
7	SHIELD	-																																																																																																																																		
12	LG	-																																																																																																																																		
13	O	-																																																																																																																																		
14	W/R	-																																																																																																																																		
15	B/R	-																																																																																																																																		
Connector No.	B28																																																																																																																																			
Connector Name	WOOFER																																																																																																																																			
Connector Type	RS08FGY-PR																																																																																																																																			
Terminal No.	Color of Wire	Signal Name [Specification]																																																																																																																																		
1	W/R	SOUND SIGNAL WOOFER (-)																																																																																																																																		
2	B/R	SOUND SIGNAL WOOFER (+)																																																																																																																																		
4	W	WOOFER AMP. ON SIGNAL																																																																																																																																		
5	B/W	GND																																																																																																																																		
6	O	BAT																																																																																																																																		
Connector No.	B28																																																																																																																																			
Connector Name	WOOFER																																																																																																																																			
Connector Type	RS08FGY-PR																																																																																																																																			
Terminal No.	Color of Wire	Signal Name [Specification]																																																																																																																																		
1	W/R	SOUND SIGNAL WOOFER (-)																																																																																																																																		
2	B/R	SOUND SIGNAL WOOFER (+)																																																																																																																																		
4	W	WOOFER AMP. ON SIGNAL																																																																																																																																		
5	B/W	GND																																																																																																																																		
6	O	BAT																																																																																																																																		

JCNWM1843GI

A
B
C
D
E
F
G
H
I
J
K
L
M
N
O
P

AV

AV CONTROL UNIT

< ECU DIAGNOSIS >

[BOSE AUDIO WITH NAVIGATION]

BOSE AUDIO WITH NAVIGATION SYSTEM

Connector No.	B80
Connector Name	CAMERA CONTROL UNIT
Connector Type	TH22FW-NH

Terminal No.	Color of Wire	Signal Name [Specification]
5	SHIELD	SHIELD
6	B	CAMERA IMAGE SIGNAL
7	R/W	GND
8	R/L	CAMERA ON SIGNAL
11	SHIELD	SHIELD
12	B	CAMERA IMAGE SIGNAL
14	L	CONNECTION RECOGNITION
17	BR	AV COMM (L)
18	Y	AV COMM (H)
19	GR	AV COMM (L)
20	G	AV COMM (H)



1	2	3	4	5	6	7	8	9	10	11	12	13	14	15	16	17	18	19	20	21	22	23	24	25	26	27	28	29	30	31	32
---	---	---	---	---	---	---	---	---	----	----	----	----	----	----	----	----	----	----	----	----	----	----	----	----	----	----	----	----	----	----	----

22	R	REVERSE
23	G	SENSOR SIGNAL 1
24	SR	SENSOR SIGNAL 2
25	O	SENSOR SIGNAL 3
28	BR	VEHICLE SPEED (3-PULSE)
30	GR	ACC
31	B	GND
32	V	BATTERY



1	2	3	4	5
6	7	8	9	10
11	12	13	14	15
16	17	18	19	20

Connector No.	B77
Connector Name	WIRE TO WIRE
Connector Type	TK12MW



1	2	3	4	5	6	7
8	9	10	11	12	13	14
15	16	17	18	19	20	21

Terminal No.	Color of Wire	Signal Name [Specification]
1	W	
2	GR	
3	BR	
4	Y	
5	BR	
7	SHIELD	
12	G	
13	R	
14	W/R	
15	B/R	

Terminal No.	Color of Wire	Signal Name [Specification]
6	R/L	
7	R/W	
8	B	
9	SHIELD	

Terminal No.	Color of Wire	Signal Name [Specification]
1	W	
2	GR	
3	BR	
4	Y	
5	BR	
7	SHIELD	
12	G	
13	R	
14	W/R	
15	B/R	

Connector No.	B218
Connector Name	WIRE TO WIRE
Connector Type	TK10FW-NS8



10	9	8	7	6	5	4	3	2	1
18	17	16	15	14	13	12	11		

Connector No.	B219
Connector Name	WIRE TO WIRE
Connector Type	TH32MW-NH



1	2	3	4	5	6	7	8	9	10	11	12	13	14	15	16
17	18	19	20	21	22	23	24	25	26	27	28	29	30	31	32

Terminal No.	Color of Wire	Signal Name [Specification]
4	L	-[With BOSE system]
5	O	-[With BOSE system]

Terminal No.	Color of Wire	Signal Name [Specification]
1	W/R	
2	B/R	
3	SHIELD	
4	W/R	
5	B/R	
6	SHIELD	
7	GR/V	
8	W/L	
9	SHIELD	
10	GR/V	
11	W/L	

AV CONTROL UNIT

< ECU DIAGNOSIS >

[BOSE AUDIO WITH NAVIGATION]

BOSE AUDIO WITH NAVIGATION SYSTEM

Connector No.	B224
Connector Name	BOSE AMP.
Connector Type	SSA1PBR-SJ42



14	13	12	11	10
9	8	7	6	5
4	3	2	1	

Terminal No.	Color of Wire	Signal Name [Specification]
1	LG	SOUND SIGNAL FRONT SQUAWKER LH (+)
2	V	SOUND SIGNAL FRONT SQUAWKER LH (-)
3	L	SOUND SIGNAL FRONT SQUAWKER RH (+)
4	P	SOUND SIGNAL FRONT SQUAWKER RH (-)
5	Y	SOUND SIGNAL REAR SPEAKER RH (+)
6	BR	SOUND SIGNAL REAR SPEAKER RH (-)
7	B	GND
8	BR	SOUND SIGNAL REAR SPEAKER LH (-)
9	O	SOUND SIGNAL REAR DOOR SPEAKER RH (-)
10	SB	BATTERY
11	GR	BATTERY

Connector No.	B226
Connector Name	WIRE TO WIRE
Connector Type	NS12MBR-CS



1	2	3	4	5
6	7	8	9	10
11	12			

Terminal No.	Color of Wire	Signal Name [Specification]
1	V	-
2	BR	-
3	W	-
4	V	-
5	SB	-
6	P	-
7	Y	-
8	B	-
9	L	-
10	P	-
11	LG	-

12	B	GND
13	GR	SOUND SIGNAL REAR SPEAKER LH (+)
14	L	SOUND SIGNAL REAR DOOR SPEAKER RH (+)

Connector No.	B225
Connector Name	BOSE AMP.
Connector Type	SCA1PBR-SG44



37	36	35	34	33
27	26	25	24	23
22	21	20	19	18
17	16	15		

Terminal No.	Color of Wire	Signal Name [Specification]
15	R	SOUND SIGNAL REAR DOOR SPEAKER LH (-)
16	B/R	SOUND SIGNAL WOOFER (+)
17	W/R	SOUND SIGNAL WOOFER (-)
18	W	SOUND SIGNAL FRONT DOOR SPEAKER LH (+)
19	B	SOUND SIGNAL FRONT DOOR SPEAKER LH (-)
20	SB	AMP. ON SIGNAL
21	SHIELD	SHIELD
22	W	WOOFER AMP. ON SIGNAL
23	W/L	SOUND SIGNAL REAR LH (-)
24	GR/V	SOUND SIGNAL REAR LH (+)
25	W/L	SOUND SIGNAL REAR RH (-)

Connector No.	B15
Connector Name	FRONT DOOR SPEAKER LH (WITH BOSE SYSTEM)
Connector Type	NS02FBR-CS



2	1
---	---

Terminal No.	Color of Wire	Signal Name [Specification]
1	L	- [Type A]
1	W	- [Type B]
2	B/W	- [Type A]
2	B	- [Type B]

26	GR/V	SOUND SIGNAL REAR RH (+)
28	G	SOUND SIGNAL REAR DOOR SPEAKER LH (+)
29	V	SOUND SIGNAL CENTER SPEAKER (+)
30	P	SOUND SIGNAL CENTER SPEAKER (-)
31	BR	SOUND SIGNAL FRONT DOOR SPEAKER RH (+)
32	Y	SOUND SIGNAL FRONT DOOR SPEAKER RH (-)
33	W/R	SOUND SIGNAL FRONT RH (+)
34	B/R	SOUND SIGNAL FRONT RH (-)
35	W/R	SOUND SIGNAL FRONT LH (+)
36	B/R	SOUND SIGNAL FRONT LH (-)

Connector No.	D21
Connector Name	WIRE TO WIRE
Connector Type	TH4DFW-CS15



15	14	13	12	11	10	9	8	7	6	5	4	3	2	1
16	17	18	19	20	21	22	23	24	25	26	27	28	29	30

Terminal No.	Color of Wire	Signal Name [Specification]
4	B/W	- [Type A]
4	B	- [Type B]
5	L	- [Type A]
5	W	- [Type B]

A
B
C
D
E
F
G
H
I
J
K
L
M
N
O
P

AV

JCNWM1845GI

AV CONTROL UNIT

< ECU DIAGNOSIS >

[BOSE AUDIO WITH NAVIGATION]

BOSE AUDIO WITH NAVIGATION SYSTEM

Connector No.	D86
Connector Name	REAR DOOR SPEAKER LH (WITH BOSE SYSTEM)
Connector Type	NS02FBR-CS



Terminal No.	Color of Wire	Signal Name [Specification]
1	L	
2	W	

Connector No.	D81
Connector Name	WIRE TO WIRE
Connector Type	TK10MW-NSB

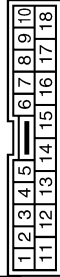

Terminal No.	Color of Wire	Signal Name [Specification]
4	L	
5	W	

Connector No.	D63
Connector Name	FRONT DOOR SPEAKER RH (WITH BOSE SYSTEM)
Connector Type	NS02FBR-CS



Terminal No.	Color of Wire	Signal Name [Specification]
1	BR	-[Type A]
2	W	-[Type B]
2	B/R	-[Type A]
2	B	-[Type B]

Connector No.	D41
Connector Name	WIRE TO WIRE
Connector Type	TK10MW-CS15



Terminal No.	Color of Wire	Signal Name [Specification]
4	B/R	-[Type A]
4	B	-[Type B]
5	BR	-[Type A]
5	W	-[Type B]

Connector No.	D192
Connector Name	REAR VIEW CAMERA
Connector Type	TK10MW-NH



Connector No.	D182
Connector Name	WIRE TO WIRE
Connector Type	TK12FW



Connector No.	D155
Connector Name	WIRE TO WIRE
Connector Type	TK10MW-NSB



Connector No.	D106
Connector Name	REAR DOOR SPEAKER RH (WITH BOSE SYSTEM)
Connector Type	NS02FBR-CS



Terminal No.	Color of Wire	Signal Name [Specification]
1	R	CAMERA ON SIGNAL
2	G	GND
3	B	CAMERA IMAGE SIGNAL
4	SHIELD	SHIELD

Terminal No.	Color of Wire	Signal Name [Specification]
6	R	
7	G	
8	B	
9	SHIELD	

Terminal No.	Color of Wire	Signal Name [Specification]
4	O	-[Type A]
4	L	-[Type B]
5	B/P	-[Type A]
5	W	-[Type B]

Terminal No.	Color of Wire	Signal Name [Specification]
1	O	-[Type A]
1	L	-[Type B]
2	B/P	-[Type A]
2	W	-[Type B]

JCNWM1846GI

AV CONTROL UNIT

< ECU DIAGNOSIS >

[BOSE AUDIO WITH NAVIGATION]

BOSE AUDIO WITH NAVIGATION SYSTEM

Connector No.	E27
Connector Name	PARKING BRAKE SWITCH
Connector Type	PH1FB-A



Terminal No.	Color of Wire	Signal Name [Specification]
1	P	-

Connector No.	E18
Connector Name	BACK-UP LAMP RELAY
Connector Type	MS22FL-M2-LC



Terminal No.	Color of Wire	Signal Name [Specification]
1	LG	-
2	R	-
3	LG	-
5	R	-

Connector No.	E16
Connector Name	ECM
Connector Type	RH2ZFB-R28-L-LH

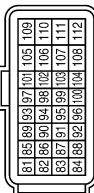

Terminal No.	Color of Wire	Signal Name [Specification]
97	P	VEHCAN-L
98	L	VEHCAN-H

Connector No.	E6
Connector Name	WIRE TO WIRE
Connector Type	TK1BMGY-TV



Terminal No.	Color of Wire	Signal Name [Specification]
4	R	-

Connector No.	F123
Connector Name	WIRE TO WIRE
Connector Type	TK1BFGY-TV



Terminal No.	Color of Wire	Signal Name [Specification]
4	G/B	-

Connector No.	F23
Connector Name	TCM (TRANSMISSION CONTROL MODULE)
Connector Type	RH4QFB-R28-L-RH

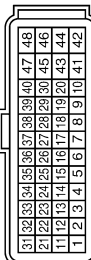

Terminal No.	Color of Wire	Signal Name [Specification]
19	G/B	REV LAMP RELAY

Connector No.	E105
Connector Name	WIRE TO WIRE
Connector Type	TH70MW-CS10-M3

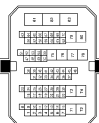

Terminal No.	Color of Wire	Signal Name [Specification]
5	LG	-
22	P	-
47	P	-
48	L	-
75	BR	-
76	GR	-
78	V	-

Connector No.	E104
Connector Name	WIRE TO WIRE
Connector Type	NS16FW-CS



Terminal No.	Color of Wire	Signal Name [Specification]
4	R	-
5	L	-
6	P	-
7	L	-

JCNWM1847GI

A
B
C
D
E
F
G
H
I
J
K
L
M
N
O
P

AV

AV CONTROL UNIT

< ECU DIAGNOSIS >

[BOSE AUDIO WITH NAVIGATION]

BOSE AUDIO WITH NAVIGATION SYSTEM

Connector No.	M11
Connector Name	WIRE TO WIRE
Connector Type	TH70FW-CS1D-H3

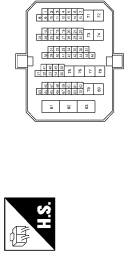

Terminal No.	Color of Wire	Signal Name [Specification]
5	O	-
22	G	-
47	P	-
48	L	-
75	BR	-
76	R	-
78	Y	-

Connector No.	M4
Connector Name	DATA LINK CONNECTOR
Connector Type	BD16FW

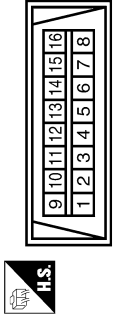

Terminal No.	Color of Wire	Signal Name [Specification]
6	L	-
14	P	-

Connector No.	M22
Connector Name	WIRE TO WIRE
Connector Type	TH12FW-NH



Terminal No.	Color of Wire	Signal Name [Specification]
1	V	-
2	R	-
3	R	-
4	G	-
5	W	-
6	SHIELD	-
7	LG	-
8	SHIELD	-
9	BR	-
10	SHIELD	-
11	L	-

Connector No.	M3
Connector Name	FUSE BLOCK (J/B)
Connector Type	NS12FW-CS

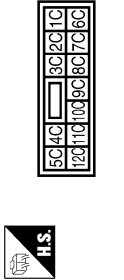

Terminal No.	Color of Wire	Signal Name [Specification]
12C	O	-

Connector No.	M20
Connector Name	WIRE TO WIRE
Connector Type	TH40MW-CS15

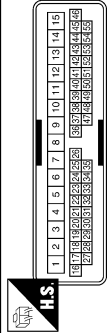

Terminal No.	Color of Wire	Signal Name [Specification]
4	B	-
5	L	-

Connector No.	M1
Connector Name	FUSE BLOCK (J/B)
Connector Type	NS6FW-M2

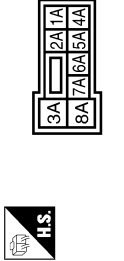

Terminal No.	Color of Wire	Signal Name [Specification]
2A	G	-
5A	R	-

Connector No.	M1B
Connector Name	WIRE TO WIRE
Connector Type	TH40MW-CS15

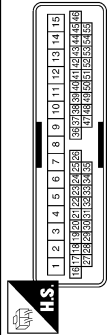

Terminal No.	Color of Wire	Signal Name [Specification]
4	W	-
5	BR	- [Type A and without BOSE system type B]
5	B	- [With BOSE system type B]

JCNWM1848GI

AV CONTROL UNIT

< ECU DIAGNOSIS >

[BOSE AUDIO WITH NAVIGATION]

BOSE AUDIO WITH NAVIGATION SYSTEM

Connector No.	M23
Connector Name	WIRE TO WIRE
Connector Type	TH18MW-NH



Connector No.	M30
Connector Name	STEERING ANGLE SENSOR
Connector Type	TH08FW-NH

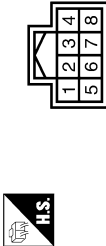

Connector No.	M33
Connector Name	COMBINATION SWITCH (SPIRAL CABLE)
Connector Type	TK08FGY-IV



Connector No.	M34
Connector Name	COMBINATION METER
Connector Type	TH40FW-NH

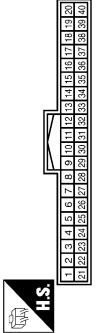

Terminal No.	Color of Wire	Signal Name [Specification]
1	W	-
2	SHIELD	[With telephone and navigation system]
3	B	-

Terminal No.	Color of Wire	Signal Name [Specification]
1	B	-
3	L	-
4	G	-
6	SB	-
8	O	-

Terminal No.	Color of Wire	Signal Name [Specification]
24	BR	[With audio steering switch and telephone]
31	G	[With audio steering switch and telephone]
33	L	[With audio steering switch and telephone]

Terminal No.	Color of Wire	Signal Name [Specification]
21	L	CAN-H
22	P	CAN-L
31	V	VEHICLE SPEED (8-PULSE)

Connector No.	M44
Connector Name	WIRE TO WIRE
Connector Type	TH22FW-NH

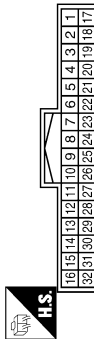

Terminal No.	Color of Wire	Signal Name [Specification]
10	V	-
11	LG	-
12	SHIELD	-
13	P	-

Connector No.	M49
Connector Name	FRONT DISPLAY UNIT
Connector Type	TH24FW-NH



Terminal No.	Color of Wire	Signal Name [Specification]
13	B	GND[With navigation system]
14	SHIELD	SHIELD[With navigation system]
15	Y	AUX IMAGE SIGNAL[With navigation system]
17	G	RGB (RED) SIGNAL
18	W	RGB (BLUE) SIGNAL[With navigation system]
19	B	RGB SYNC
20	R	VP
21	SHIELD	SHIELD
22	G	COMM (DISP->CONT)
23	SHIELD	SHIELD

Terminal No.	Color of Wire	Signal Name [Specification]
1	G	-
2	R	-
3	SHIELD	-
4	B	-
5	W	-
6	SHIELD	-
7	O	- [Type A]
7	L	- [Type B]
8	SB	- [Type A]
8	R	- [Type B]
9	SHIELD	-

Terminal No.	Color of Wire	Signal Name [Specification]
1	B	GND
2	Y	BATTERY[With navigation system]
3	R	ACC[With navigation system]
4	SHIELD	SHIELD[With navigation system]
5	B	AUX IMAGE GND[With navigation system]
6	R	RGB (GREEN) SIGNAL[With navigation system]
7	SHIELD	SHIELD
8	B	HPI[With navigation system]
9	W	RGB AREA (YS) SIGNAL
11	R	COMM (CONT->DISP)
12	W	CAMERA IMAGE SIGNAL

JCNWM1849GI

A
B
C
D
E
F
G
H
I
J
K
L
M
N
O
P

AV

AV CONTROL UNIT

< ECU DIAGNOSIS >

[BOSE AUDIO WITH NAVIGATION]

BOSE AUDIO WITH NAVIGATION SYSTEM

Connector No.	M65
Connector Name	FRONT SQUAWKER LH
Connector Type	TK02FBR



Terminal No.	Color of Wire	Signal Name [Specification]
1	LG	- [With BOSE system]
2	Y	- [With BOSE system]

Connector No.	M66
Connector Name	CENTER SPEAKER
Connector Type	TK02FBR



Terminal No.	Color of Wire	Signal Name [Specification]
1	P	-
2	O	-

Connector No.	M67
Connector Name	FRONT SQUAWKER RH
Connector Type	TK02FBR



Terminal No.	Color of Wire	Signal Name [Specification]
1	BR	-
2	R	- [With BOSE system]

Connector No.	M77
Connector Name	WIRE TO WIRE
Connector Type	TH80FW-CS19

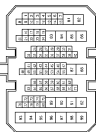

Terminal No.	Color of Wire	Signal Name [Specification]
41	O	-
42	SB	-
43	L	-
44	V	-
45	P	-
46	R	-
47	Y	-
48	L	-
49	G	-
50	SHIELD	-
51	W	-

56	P	-
57	L	-
58	SB	-
66	L	-
67	R	-

Connector No.	M97
Connector Name	WIRE TO WIRE
Connector Type	TH18FW-GS2

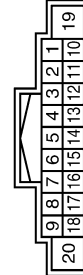

Terminal No.	Color of Wire	Signal Name [Specification]
5	SHIELD	-
6	W	-
8	B	-
9	Y	-
14	R	-
15	B	-
17	SHIELD	-
18	B	- [Type A and With navigation system type B]

Connector No.	M122
Connector Name	BCM (BODY CONTROL MODULE)
Connector Type	TH40FB-NH



Terminal No.	Color of Wire	Signal Name [Specification]
90	P	CAN-L
91	L	CAN-H

JCNWM1850G1

AV CONTROL UNIT

< ECU DIAGNOSIS >

[BOSE AUDIO WITH NAVIGATION]

BOSE AUDIO WITH NAVIGATION SYSTEM

Connector No.	M124		
Connector Name	WIRE TO WIRE	LG	R
Connector Type	MS12BF-C5		

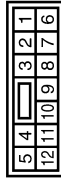

Terminal No.	Color of Wire	Signal Name [Specification]
1	P	-
2	BR	- [Type A]
3	L	- [Type B]
4	Y	-
5	BR	-
6	O	-
7	W	-
8	B	-
9	R	-
10	BR	-

Connector No.	M144
Connector Name	AV CONTROL UNIT (WITH NAVIGATION SYSTEM)
Connector Type	TH18FW-CS2



Terminal No.	Color of Wire	Signal Name [Specification]
1	P	AMP ON SIGNAL
2	G	SOUND SIGNAL FRONT LH (+)
3	R	SOUND SIGNAL FRONT LH (-)
4	O	SOUND SIGNAL REAR LH (+) [Type A]
5	SB	SOUND SIGNAL REAR LH (+) [Type B]
6	R	SOUND SIGNAL REAR LH (-) [Type A]
7	R	SOUND SIGNAL REAR LH (-) [Type B]
8	A	STRG SW A
9	ACC	ACC
10	SHIELD	ILLUMINATION SHIELD

Connector No.	M125
Connector Name	MULTIFUNCTION SWITCH
Connector Type	TH18FW-NH

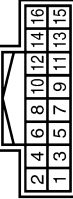

Terminal No.	Color of Wire	Signal Name [Specification]
1	B	GND
3	R	ACC
6	R	AV COMM (H)
8	L	AV COMM (L)
9	V	SW GND
14	W	EJECT SIGNAL

Connector No.	M145
Connector Name	AV CONTROL UNIT (WITH NAVIGATION SYSTEM)
Connector Type	TH18FW-NH



Terminal No.	Color of Wire	Signal Name [Specification]
21	B	GND
22	Y	BATTERY
23	B	GND
24	Y	BATTERY
25	R	ACC
26	B	MICROPHONE VCC
27	SHIELD	MICROPHONE GND
28	W	MICROPHONE SIGNAL
35	G	IGNITION
36	G	PARKING BRAKE
37	SB	REVERSE

38	V	VEHICLE SPEED (8-PULSE)
40	P	CONNECTION RECOGNITION
42	B	CONTROL SIGNAL
43	B	CONTROL SIGNAL
48	G	AV COMM (H)
49	L	AV COMM (L)
50	R	AV COMM (H)
51	L	AV COMM (L)
52	L	CAN-H
53	P	CAN-L

A
B
C
D
E
F
G
H
I
J
K
L
M
N
O
P

AV

AV CONTROL UNIT

< ECU DIAGNOSIS >

[BOSE AUDIO WITH NAVIGATION]

BOSE AUDIO WITH NAVIGATION SYSTEM

Connector No.	M146
Connector Name	AV CONTROL UNIT (WITH NAVIGATION SYSTEM)
Connector Type	TH12FW-NH



62	64	66	68	70	72
61	63	65	67	69	71

Terminal No.	Color of Wire	Signal Name [Specification]
61	G	RGB (R/RED) SIGNAL
62	R	RGB (G/GREEN) SIGNAL
63	W	RGB (B/BLUE) SIGNAL
64	SHIELD	SHIELD
65	B	RGB SYNC
66	SHIELD	SHIELD
67	W	RGB AREA (VS) SIGNAL
68	B	HP
69	R	VP
70	R	COMM (CONT->DISP)
71	G	COMM (DISP->CONT)

Connector No.	M148
Connector Name	POD ADAPTER
Connector Type	TH12FW-NH



1	2	3	4	5	6	7	8	9	10	11	12
13	14	15	16	17	18	19	20	21	22	23	24

Terminal No.	Color of Wire	Signal Name [Specification]
1	BR	POD SOUND SIGNAL LH (+)
2	R	POD SOUND SIGNAL RH (+)
3	R	ACC
4	L	AV COMM (L)
5	Y	BATTERY
8	W	CHARGE POWER
9	G	COMM (POD ADAPTER->IPOD)
10	R	COMM (IPOD->POD ADAPTER)
11	R	ACCESSORY IDENTITY
12	V	POD SOUND SIGNAL RH (+)
13	L	POD SOUND SIGNAL LH (-)

72	SHIELD	SHIELD
----	--------	--------

Connector No.	M147
Connector Name	AV CONTROL UNIT (WITH NAVIGATION SYSTEM)
Connector Type	TH12FW-NH



73	74	75	76	77	78	79	80	81	82	83	84	85	86	87	88
89	90	91	92	93	94	95	96	97	98	99	100	101	102	103	104

Terminal No.	Color of Wire	Signal Name [Specification]
79	BR	POD SOUND SIGNAL LH (+)
80	R	POD SOUND SIGNAL RH (+)
81	SHIELD	SHIELD
85	W	EJECT SIGNAL
86	SHIELD	SHIELD
87	B	AUX SOUND SIGNAL LH (+)
88	W	AUX SOUND SIGNAL GND
93	L	POD SOUND SIGNAL LH (-)
96	W	POD SOUND SIGNAL RH (-)
102	V	SW GND
103	R	AUX SOUND SIGNAL RH (+)

Connector No.	M204
Connector Name	WIRE TO WIRE
Connector Type	TH12MW-NH



1	2	3	4	5	6
7	8	9	10	11	12

Terminal No.	Color of Wire	Signal Name [Specification]
1	V	-
2	R	-
3	R	-
4	G	-
5	W	-
6	SHIELD	-
7	LG	-
8	SHIELD	-
9	BR	-
10	SHIELD	-
11	L	-

















12	R	-
----	---	---

AV CONTROL UNIT

< ECU DIAGNOSIS >

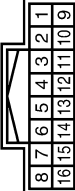
[BOSE AUDIO WITH NAVIGATION]

BOSE AUDIO WITH NAVIGATION SYSTEM

Connector No. M375	WIRE TO WIRE GT13SH-2/1S-HU			Terminal No.	Color of Wire	Signal Name [Specification]
				1	-	-
				2	-	-
				3	-	-
Connector No. M376	WIRE TO WIRE GT13SON-2/1PP-HU			Terminal No.	Color of Wire	Signal Name [Specification]
				1	-	-
				2	-	-
				3	-	-
Connector No. M377	ANTENNA BASE (SATELLITE ANTENNA) (WITH NAVIGATION SYSTEM) GT16C-1PP-HU			Terminal No.	Color of Wire	Signal Name [Specification]
				1	-	SATELLITE ANTENNA
Connector No. M378	ANTENNA BASE (ANTENNA AMP.) GT13SSN-1/1PP-HU			Terminal No.	Color of Wire	Signal Name [Specification]
				1	-	-
				2	-	-
				3	-	-
Connector No. M379	GLASS ANTENNA GT13SCN-1/1PP-HU			Terminal No.	Color of Wire	Signal Name [Specification]
				2	-	FM SUB
Connector No. M880	AV CONTROL UNIT (WITH NAVIGATION SYSTEM) GT5-1S-HU			Terminal No.	Color of Wire	Signal Name [Specification]
				110	-	GPS ANTENNA
				111	-	SHIELD
Connector No. R1	WIRE TO WIRE TH16FW-NH			Terminal No.	Color of Wire	Signal Name [Specification]
				1	-	-
				2	SHIELD	-[With telephone and navigation system]
				3	B	-
Connector No. R20	MICROPHONE TK04FW			Terminal No.	Color of Wire	Signal Name [Specification]
				1	R/W	MICROPHONE SIGNAL (-)
				2	SHIELD	SHIELD[With telephone and navigation system]
				4	B	MICROPHONE POWER

Fail-Safe

When the ambient temperature becomes extremely low or extremely high, or when HDD is malfunctioning, AV control unit displays the message and limits the AV control unit function.

FAIL-SAFE CONDITIONS

- When the ambient temperature is -20°C (-4°F) or lower, or when it is 70°C (158°F) or higher
- when HDD is malfunctioning

JCNWM1854GI

INFOID:0000000003457763

AV CONTROL UNIT

< ECU DIAGNOSIS >

[BOSE AUDIO WITH NAVIGATION]

Display

The messages displayed on fail-safe conditions are as shown below:

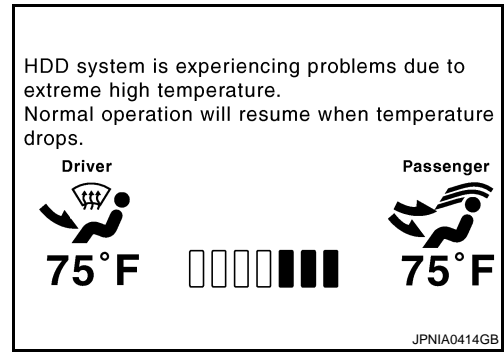

Fail-safe mode	Display (display of the fail-safe condition)
When HDD temperature is low	HDD system is experiencing problems due to extreme low temperature. Normal operation will resume when temperature rises.
When HDD temperature is high	HDD system is experiencing problems due to extreme high temperature. Normal operation will resume when temperature drops.
When HDD is malfunctioning	HDD system is not functioning. Please contact your dealer for assistance.

DESCRIPTION OF CONTROLS

Function	When Fail-safe Function is activated	
Air conditioner	Operation	Only multifunction switch (preset switch) can be operated.
	Display	<ul style="list-style-type: none"> • LED of multifunction switch (preset switch) illuminates. • Aimed temperature, blow angle, and flow rate are displayed in simplified mode.
Audio	Operation	Only ON/OFF and volume control operations by multifunction switch (preset switch) are possible.
	Display	No display ("Fail-safe mode" is displayed.)
Camera	Operation	Image tone cannot be controlled.
	Display	Cannot be superimposed. (warning display, tone control display)
Hands-free phone	Operation	Cannot be operated.
Navigation	Operation	Cannot be operated.
Self diagnosis		The display in simplified mode of fail-safe condition
CONSULT-III diagnosis		Cannot be operated.

Ability Operation Mode

There is an ability operation mode for Fail-safes due to low or high ambient temperature.

If HDD data can be read, fail-safe is shown, then normal displays are displayed only for functions which can be operated.

RELEASE CONDITIONS OF FAIL-SAFE

Fail-safe is released on the following conditions and normal mode is restored.

When the temperature of HDD is low or high.

If the ambient temperature becomes out of the fail-safe conditional range, normal mode is restored.

When HDD is malfunctioning.

If the malfunction disappears, normal mode is restored.

NOTE:

- If fail-safe mode due to HDD malfunction is seen continuously, replace AV control unit.
- If fail-safe mode due to HDD malfunction is seen temporarily, check the "Error History" of Confirmation/Adjustment mode. If this is normal, then continue the normal operation, observing the function. (It might be a temporary malfunction of HDD.)

AV CONTROL UNIT

< ECU DIAGNOSIS >

[BOSE AUDIO WITH NAVIGATION]

DTC Index

INFOID:000000003457764

SELF-DIAGNOSIS RESULTS DISPLAY ITEM

DTC	Display item	Refer to
U1000	CAN COMM CIRCUIT [U1000]	AV-593, "Diagnosis Procedure"
U1010	CONTROL UNIT (CAN) [1010]	AV-594, "Diagnosis Procedure"
U1310	CONTROL UNIT (AV) [U1310]	AV-595, "DTC Logic"
U1200	Control Unit FLASH-ROM [1200]	AV-596, "DTC Logic"
U1201	Gyro NO CONN [1201]	AV-597, "DTC Logic"
U1216	CAN CONT [U1216]	AV-598, "DTC Logic"
U1217	BLUETOOTH CONN [U1217]	AV-599, "DTC Logic"
U1218	HDD CONN [U1218]	AV-600, "DTC Logic"
U1219	HDD READ [U1219]	AV-601, "DTC Logic"
U1220	XM SERIAL COMM [U1220]	AV-602, "DTC Logic"
U121A	HDD WRITE [U121A]	AV-603, "DTC Logic"
U121B	HDD COMM [U121B]	AV-604, "DTC Logic"
U121C	HDD ACCESS [U121C]	AV-605, "DTC Logic"
U121D	DSP CONN [U121D]	AV-606, "DTC Logic"
U121E	DSP COMM [U121E]	AV-607, "DTC Logic"
U121F	INTERNAL COMM [U121F]	AV-608, "DTC Logic"
U1204	GPS COMM [U1204]	AV-609, "DTC Logic"
U1205	GPS ROM [U1205]	AV-610, "DTC Logic"
U1206	GPS RAM [U1206]	AV-611, "DTC Logic"
U1207	GPS RTC [U1207]	AV-612, "DTC Logic"
U1243	FRONT DISP CONN [U1243]	AV-613, "DTC Logic"
U1244	GPS ANTENNA CONN [U1244]	AV-615, "DTC Logic"
U1250	CAMERA CONT. CONN [U1250]	AV-616, "DTC Logic"
U1258	XM ANTENNA CONN [U1258]	AV-617, "DTC Logic"
U1300 U121F	<ul style="list-style-type: none"> • AV COMM CIRCUIT [U1300] • INTERNAL COMM [U121F] 	AV-618, "Description"
U1300 U1240	<ul style="list-style-type: none"> • AV COMM CIRCUIT [U1300] • SWITCH CONN [U1240] 	AV-618, "Description"
U1300 U1252	<ul style="list-style-type: none"> • AV COMM CIRCUIT [U1300] • REAR CAMERA LAN CONN [U1252] 	AV-618, "Description"
U1300 U1254	<ul style="list-style-type: none"> • AV COMM CIRCUIT [U1300] • IPOD CONN [U1254] 	AV-618, "Description"
U1300 U1252 U1254*	<ul style="list-style-type: none"> • AV COMM CIRCUIT [U1300] • REAR CAMERA LAN CONN [U1252] • IPOD CONN [U1254]* 	AV-618, "Description"
U1300 U1240 U1252 U1254*	<ul style="list-style-type: none"> • AV COMM CIRCUIT [U1300] • SWITCH CONN [U1240] • REAR CAMERA LAN CONN [U1252] • IPOD CONN [U1254]* 	AV-618, "Description"
U1300 U121F U1240 U1252 U1254*	<ul style="list-style-type: none"> • AV COMM CIRCUIT [U1300] • INTERNAL COMM [U121F] • SWITCH CONN [U1240] • REAR CAMERA LAN CONN [U1252] • IPOD CONN [U1254]* 	AV-618, "Description"

NOTE:

AV CONTROL UNIT

< ECU DIAGNOSIS >

[BOSE AUDIO WITH NAVIGATION]

*: Non-equipped item is not displayed.

A

B

C

D

E

F

G

H

I

J

K

L

M

AV

O

P

FRONT DISPLAY UNIT

< ECU DIAGNOSIS >

[BOSE AUDIO WITH NAVIGATION]

FRONT DISPLAY UNIT

Reference Values

INFOID:000000003457765

TERMINAL LAYOUT

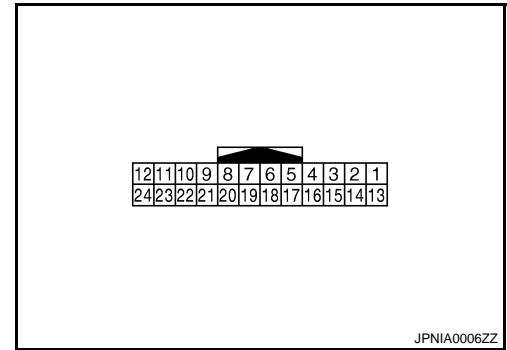

PHYSICAL VALUES

Terminal (Wire color)		Description		Condition		Reference value (Approx.)
+	-	Signal name	Input/ Output			
1 (B)	Ground	Ground	—	Ignition switch ON	—	0 V
2 (Y)	Ground	Battery power supply	Input	Ignition switch OFF	—	Battery voltage
3 (R)	Ground	ACC power supply	Input	Ignition switch ACC	—	Battery voltage
4	—	Shield	—	—	—	—
5 (B)	Ground	AUX image ground	—	Ignition switch ON	—	0 V
6 (R)	Ground	RGB image signal (G: green)	Input	Ignition switch ON	Start confirmation/adjust- ment mode, and then dis- play color bar by selecting “Color Spectrum Bar” on DISPLAY DIAGNOSIS screen.	<p style="text-align: right;">JSNIA1030ZZ</p>
7	—	Shield	—	—	—	—
8 (B)	Ground	Horizontal synchronizing (HP) signal	Output	Ignition switch ON	—	<p style="text-align: right;">SKIB3601E</p>

FRONT DISPLAY UNIT

< ECU DIAGNOSIS >

[BOSE AUDIO WITH NAVIGATION]

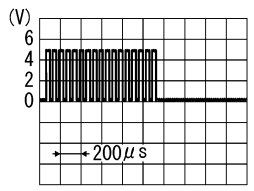
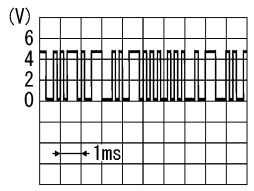
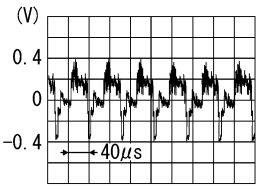
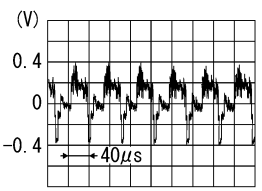
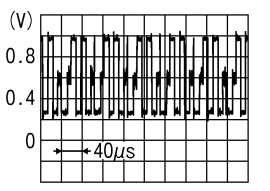
Terminal (Wire color)		Description		Condition	Reference value (Approx.)	
+	-	Signal name	Input/ Output			
9 (W)	Ground	RGB area (YS) signal	Input	Ignition switch ON	5.0 V	
				When rear view camera image is displayed.	 <p style="text-align: right; font-size: small;">PKIB4948J</p>	
11 (R)	Ground	Communication signal (CONT→DISP)	Input	Ignition switch ON	When adjusting display brightness.	 <p style="text-align: right; font-size: small;">PKIB5039J</p>
12 (W)	14	Camera image signal	Input	Ignition switch ON	When rear view camera image is displayed.	 <p style="text-align: right; font-size: small;">SKIB2251J</p>
13 (B)	Ground	Ground	—	Ignition switch ON	—	0 V
14	Ground	Shield (camera image ground)	—	Ignition switch ON	—	0 V
15 (Y)	5	AUX image signal	Input	Ignition switch ON	When AUX image is displayed.	 <p style="text-align: right; font-size: small;">SKIB2251J</p>
17 (G)	Ground	RGB image signal (R: red)	Input	Ignition switch ON	Start confirmation/adjustment mode, and then display color bar by selecting "Color Spectrum Bar" on DISPLAY DIAGNOSIS screen.	 <p style="text-align: right; font-size: small;">JSNIA1029ZZ</p>

A
B
C
D
E
F
G
H
I
J
K
L
M
AV
O
P

FRONT DISPLAY UNIT

< ECU DIAGNOSIS >

[BOSE AUDIO WITH NAVIGATION]

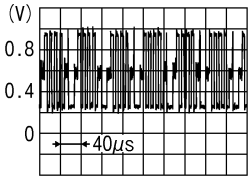
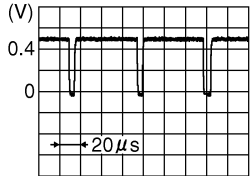
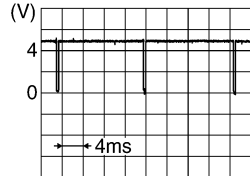
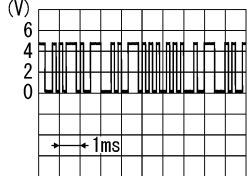
Terminal (Wire color)		Description		Condition		Reference value (Approx.)
+	-	Signal name	Input/ Output			
18 (W)	Ground	RGB image signal (B: blue)	Input	Ignition switch ON	Start confirmation/adjustment mode, and then display color bar by selecting "Color Spectrum Bar" on DISPLAY DIAGNOSIS screen.	 <p style="text-align: right; font-size: small;">JSNIA1031ZZ</p>
19 (B)	Ground	RGB synchronizing signal	Input	Ignition switch ON	—	 <p style="text-align: right; font-size: small;">JPNIA0461GB</p>
20 (R)	Ground	Vertical synchronizing (VP) signal	Output	Ignition switch ON	—	 <p style="text-align: right; font-size: small;">SKIB3598E</p>
21	—	Shield	—	—	—	—
22 (G)	Ground	Communication signal (DISP→CONT)	Output	Ignition switch ON	When adjusting display brightness.	 <p style="text-align: right; font-size: small;">PKIB5039J</p>
23	—	Shield	—	—	—	—

Wiring Diagram - BOSE AUDIO WITH NAVIGATION SYSTEM -

INFOID:000000003702902

NOTE:

FRONT DISPLAY UNIT

[BOSE AUDIO WITH NAVIGATION]

< ECU DIAGNOSIS >

In this section, PRESET SWITCH and MULTIFUNCTION SWITCH are written as the MULTIFUNCTION SWITCH.

BOSE AUDIO WITH NAVIGATION SYSTEM

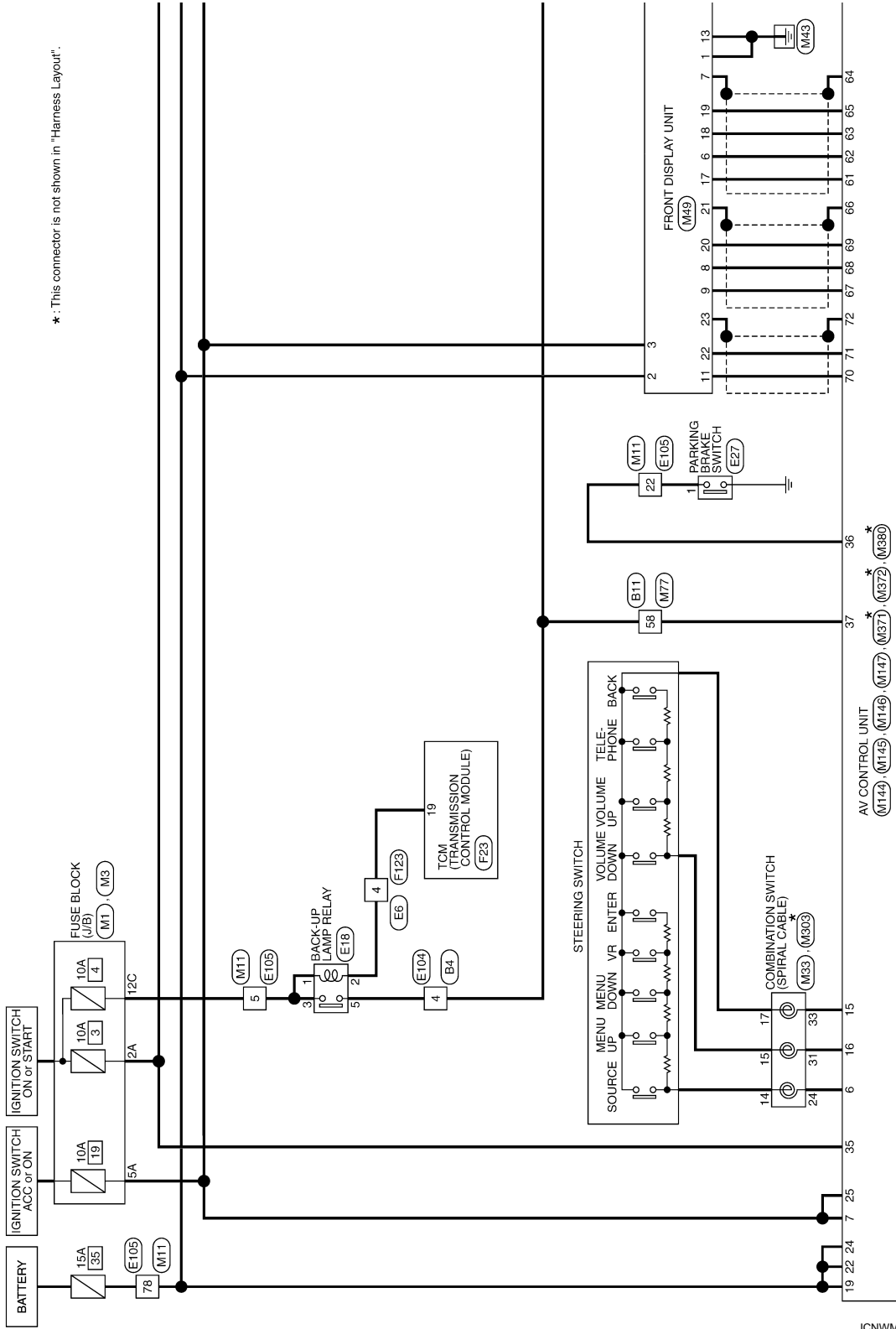

*: This connector is not shown in "Harness Layout".

JCNWM1838GI

2008/09/23

A
B
C
D
E
F
G
H
I
J
K
L
M
N
O
P

AV

FRONT DISPLAY UNIT

[BOSE AUDIO WITH NAVIGATION]

< ECU DIAGNOSIS >

WI : With iPod

*: This connector is not shown in "Harness Layout".

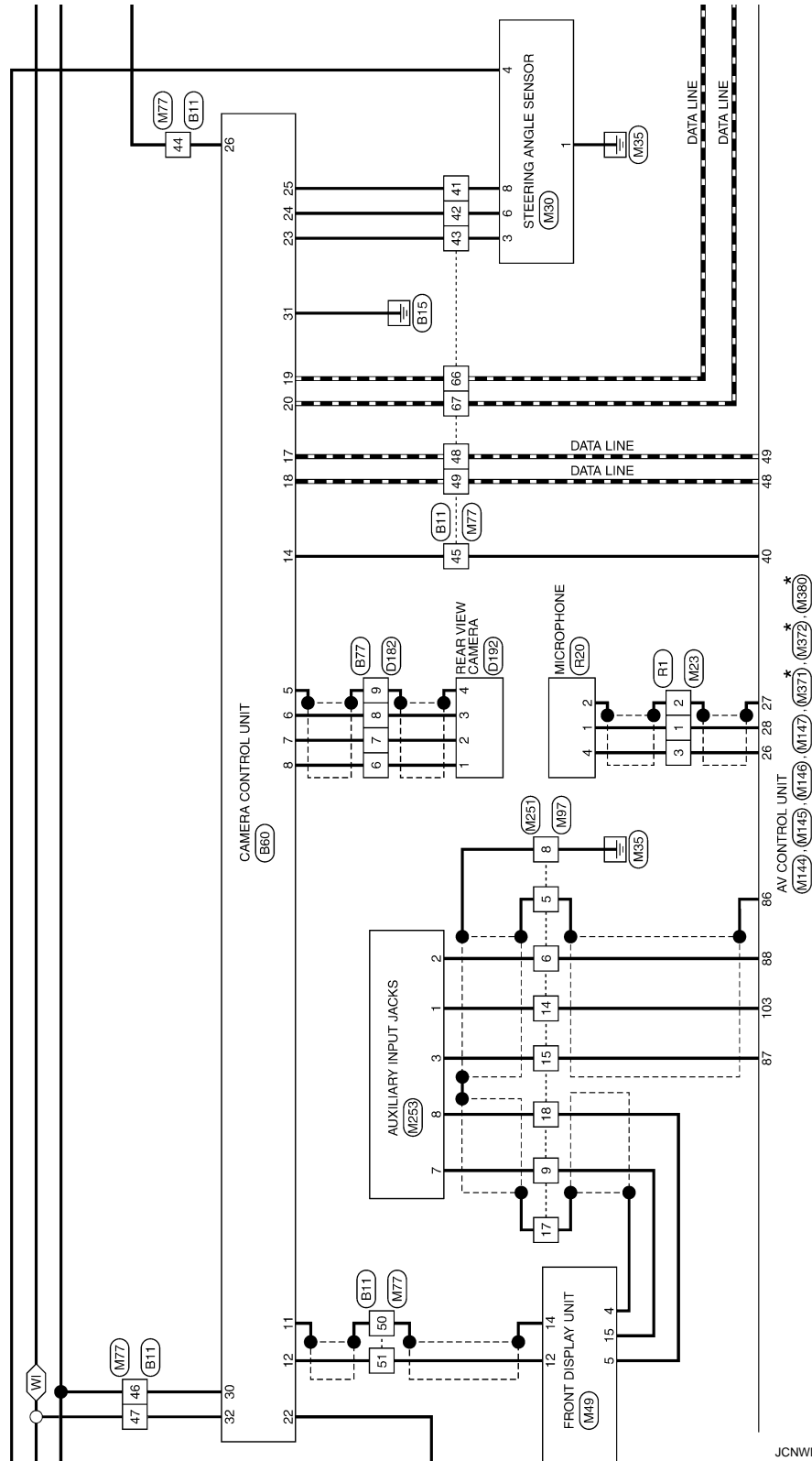

JCNWM1839GI

FRONT DISPLAY UNIT

[BOSE AUDIO WITH NAVIGATION]

< ECU DIAGNOSIS >

AB : With automatic back door
OA : Without automatic back door
WI : With iPod

* : This connector is not shown in "Harness Layout".

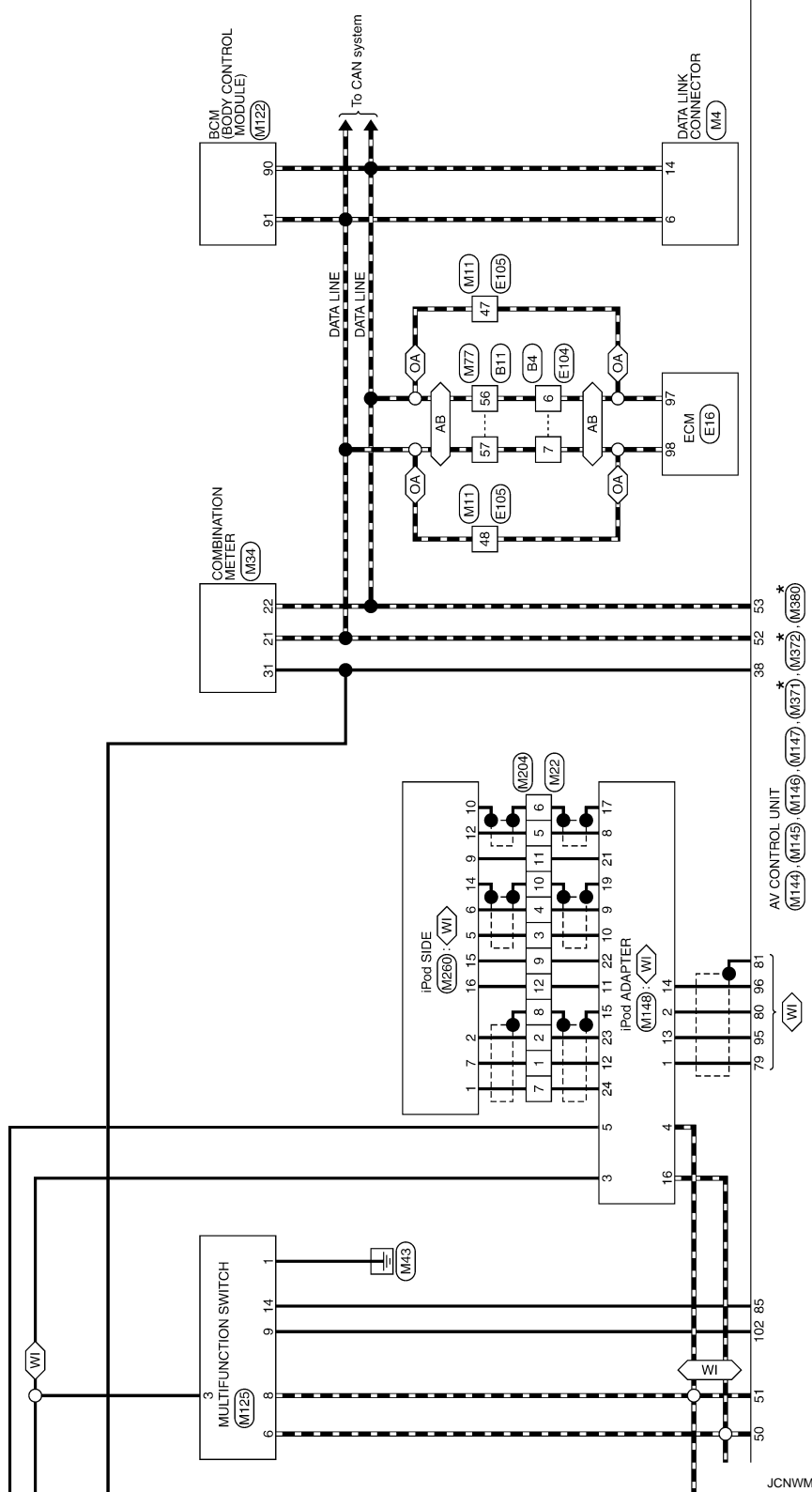

JCNWM1840GI

A
B
C
D
E
F
G
H
I
J
K
L
M
AV
O
P

FRONT DISPLAY UNIT

[BOSE AUDIO WITH NAVIGATION]

< ECU DIAGNOSIS >

*: This connector is not shown in "Harness Layout".

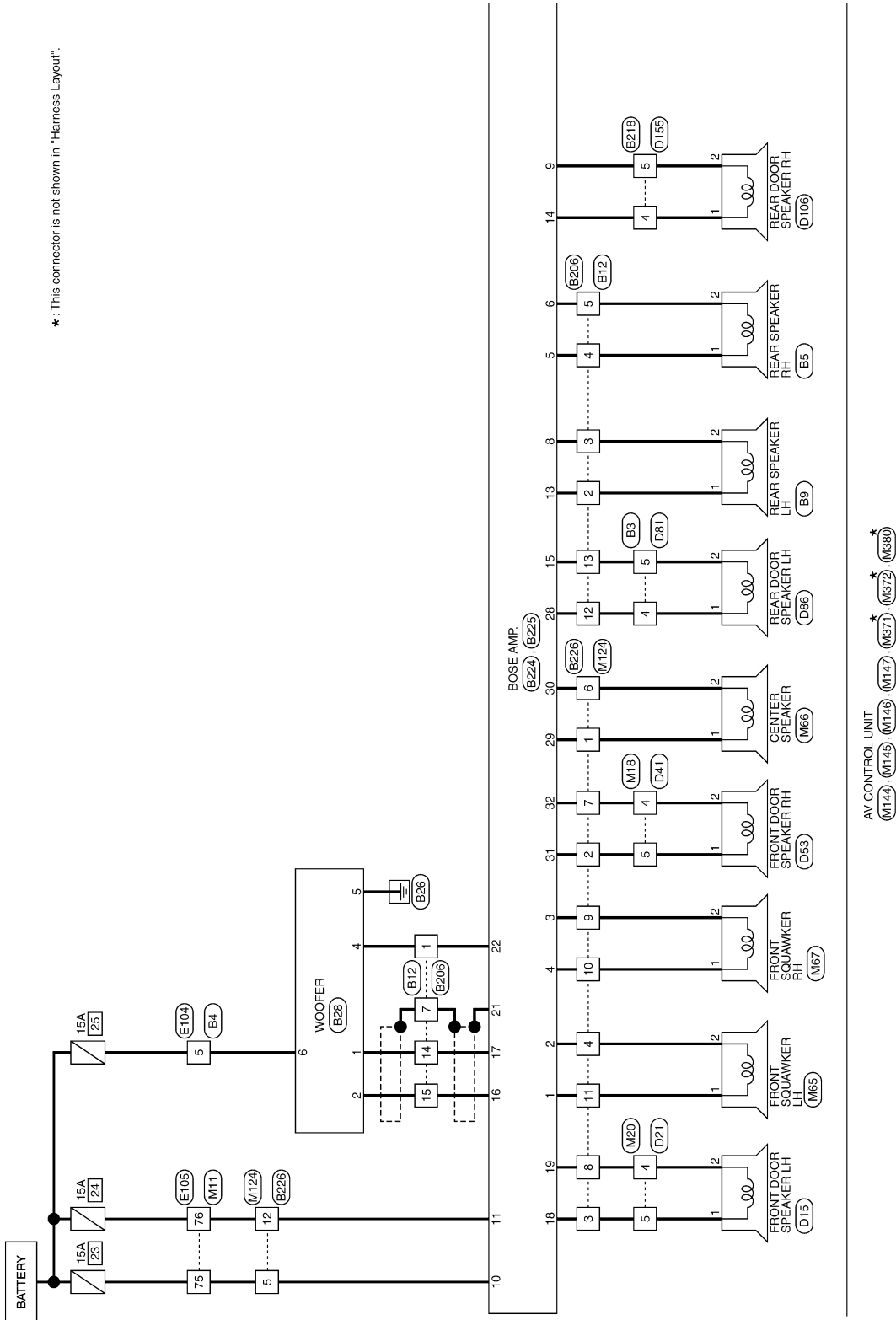

JCNWM1841GI

FRONT DISPLAY UNIT

[BOSE AUDIO WITH NAVIGATION]

< ECU DIAGNOSIS >

*: This connector is not shown in "Harness Layout".

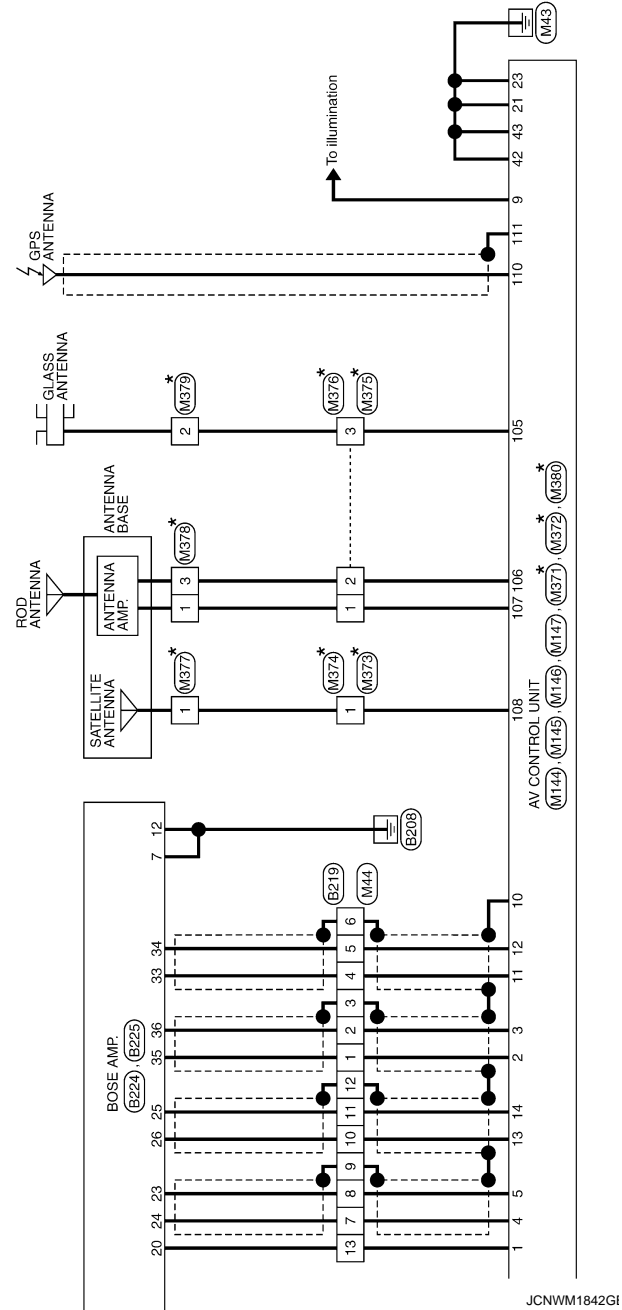

A
B
C
D
E
F
G
H
I
J
K
L
M
N
O
P

AV

FRONT DISPLAY UNIT

< ECU DIAGNOSIS >

[BOSE AUDIO WITH NAVIGATION]

BOSE AUDIO WITH NAVIGATION SYSTEM

Connector No.	B3
Connector Name	WIRE TO WIRE
Connector Type	TK10FW-NS8



Terminal No.	Color of Wire	Signal Name [Specification]
4	LG	-
5	O	-

Connector No.	B4
Connector Name	WIRE TO WIRE
Connector Type	NS18MW-CS



Terminal No.	Color of Wire	Signal Name [Specification]
4	R	-
5	O	-
6	P	-
7	L	-

Connector No.	B5
Connector Name	REAR SPEAKER RH
Connector Type	TK2FBR



Terminal No.	Color of Wire	Signal Name [Specification]
1	V	-
2	LG	-

Connector No.	B9
Connector Name	REAR SPEAKER LH
Connector Type	TK2FBR



Terminal No.	Color of Wire	Signal Name [Specification]
1	SB	-
2	GR	-

Connector No.	B11
Connector Name	WIRE TO WIRE
Connector Type	TH80MW-CS19

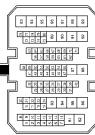

Terminal No.	Color of Wire	Signal Name [Specification]
41	O	-
42	SB	-
43	G	-
44	BR	-
45	L	-
46	GR	-
47	V	-
48	BR	- [With rear view camera without telephone]
49	Y	-
50	SHIELD	-
51	B	-

56	P	-
57	L	-
58	R	-
66	GR	-
67	G	-

Connector No.	B12
Connector Name	WIRE TO WIRE
Connector Type	NS18FW-CS



Terminal No.	Color of Wire	Signal Name [Specification]
1	W	-
2	SB	-
3	GR	-
4	V	-
5	LG	-
7	SHIELD	-
12	LG	-
13	O	-
14	W/R	-
15	B/R	-

Connector No.	B28
Connector Name	WOOFER
Connector Type	RS3DFGY-PR



Terminal No.	Color of Wire	Signal Name [Specification]
1	W/R	SOUND SIGNAL WOOFER (-)
2	B/R	SOUND SIGNAL WOOFER (+)
4	W	WOOFER AMP. ON SIGNAL
5	B/W	GND
6	O	BAT

FRONT DISPLAY UNIT

< ECU DIAGNOSIS >

[BOSE AUDIO WITH NAVIGATION]

BOSE AUDIO WITH NAVIGATION SYSTEM

Connector No.	B60
Connector Name	CAMERA CONTROL UNIT
Connector Type	TH2FW-NH

Terminal No.	2	4	6	8	10	12	14	16	18	20	22	24	26	28	30	32
Color of Wire	SHIELD	B	R/W	R/W	SHIELD	GND	CAMERA IMAGE SIGNAL	CAMERA ON SIGNAL	SHIELD	B	CAMERA IMAGE SIGNAL	CONNECTION RECOGNITION	AV COMM (L)	AV COMM (H)	AV COMM (L)	AV COMM (H)
Signal Name [Specification]																

Terminal No.	5	6	7	8	11	12	14	17	18	19	20
Color of Wire	SHIELD	B	R/W	R/W	SHIELD	B	L	BR	Y	GR	G
Signal Name [Specification]											

Connector No.	B218
Connector Name	WIRE TO WIRE
Connector Type	TK10FW-NS8

Terminal No.	10	9	8	7	6	5	4	3	2	1
Color of Wire	SHIELD	B	R/W	R/W	SHIELD	B	L	BR	Y	GR
Signal Name [Specification]										

Terminal No.	4	L	O
Color of Wire	L	L	O
Signal Name [Specification]			

Terminal No.	22	R	REVERSE
Color of Wire	G	G	SENSOR SIGNAL 1
Signal Name [Specification]			
Terminal No.	23	SB	SENSOR SIGNAL 2
Color of Wire	SB	SB	SENSOR SIGNAL 3
Signal Name [Specification]			
Terminal No.	26	BR	VEHICLE SPEED (8-PULSE)
Color of Wire	BR	BR	ACC
Signal Name [Specification]			
Terminal No.	31	B	GND
Color of Wire	B	B	BATTERY
Signal Name [Specification]			
Terminal No.	32	V	BATTERY
Color of Wire	V	V	BATTERY
Signal Name [Specification]			

Terminal No.	6	R/L	
Color of Wire	R/L	R/L	
Signal Name [Specification]			
Terminal No.	7	R/W	
Color of Wire	R/W	R/W	
Signal Name [Specification]			
Terminal No.	8	B	
Color of Wire	B	B	
Signal Name [Specification]			
Terminal No.	9	SHIELD	
Color of Wire	SHIELD	SHIELD	
Signal Name [Specification]			

Terminal No.	12	SHIELD	
Color of Wire	SHIELD	SHIELD	
Signal Name [Specification]			
Terminal No.	13	SB	
Color of Wire	SB	SB	
Signal Name [Specification]			

Connector No.	B77
Connector Name	WIRE TO WIRE
Connector Type	TK2MW

Terminal No.	1	2	3	4	5
Color of Wire	SHIELD	B	R/W	R/W	SHIELD
Signal Name [Specification]					

Terminal No.	1	2	3	4	5	7
Color of Wire	W	GR	GR	Y	BR	SHIELD
Signal Name [Specification]						
Terminal No.	12	G				
Color of Wire	G	G				
Signal Name [Specification]						
Terminal No.	13	R				
Color of Wire	R	R				
Signal Name [Specification]						
Terminal No.	14	W/R				
Color of Wire	W/R	W/R				
Signal Name [Specification]						
Terminal No.	15	B/R				
Color of Wire	B/R	B/R				
Signal Name [Specification]						

Connector No.	B206
Connector Name	WIRE TO WIRE
Connector Type	NS3.6MP-CS

Terminal No.	1	2	3	4	5	6	7
Color of Wire	SHIELD	B	R/W	R/W	SHIELD	B	CAMERA IMAGE SIGNAL
Signal Name [Specification]							

JCNWM1844GI

A
B
C
D
E
F
G
H
I
J
K
L
M
N
O
P

AV

FRONT DISPLAY UNIT

< ECU DIAGNOSIS >

[BOSE AUDIO WITH NAVIGATION]

BOSE AUDIO WITH NAVIGATION SYSTEM

12	B	GND
13	GR	SOUND SIGNAL REAR SPEAKER LH (+)
14	L	SOUND SIGNAL REAR DOOR SPEAKER RH (+)

Connector No.	B224
Connector Name	BOSE AMP.
Connector Type	SGA12FBR-SJA2

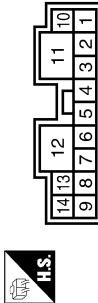

Terminal No.	Color of Wire	Signal Name [Specification]
1	LG	SOUND SIGNAL FRONT SQUAWKER LH (+)
2	V	SOUND SIGNAL FRONT SQUAWKER LH (-)
3	L	SOUND SIGNAL FRONT SQUAWKER RH (-)
4	P	SOUND SIGNAL FRONT SQUAWKER RH (+)
5	Y	SOUND SIGNAL REAR SPEAKER RH (+)
6	BR	SOUND SIGNAL REAR SPEAKER RH (-)
7	B	GND
8	BR	SOUND SIGNAL REAR SPEAKER LH (-)
9	O	SOUND SIGNAL REAR DOOR SPEAKER RH (-)
10	SB	BATTERY
11	GR	BATTERY

Connector No.	B226
Connector Name	WIRE TO WIRE
Connector Type	NS12MBR-CS

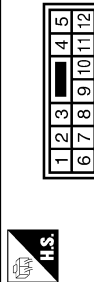

Connector No.	B225
Connector Name	BOSE AMP.
Connector Type	SCA18FBR-SGA4

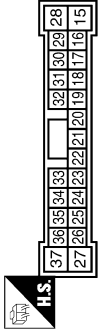

Terminal No.	Color of Wire	Signal Name [Specification]
15	R	SOUND SIGNAL REAR DOOR SPEAKER LH (-)
16	B/R	SOUND SIGNAL WOOFER (+)
17	W/R	SOUND SIGNAL WOOFER (-)
18	W	SOUND SIGNAL FRONT DOOR SPEAKER LH (-)
19	B	SOUND SIGNAL FRONT DOOR SPEAKER LH (+)
20	SB	AMP. ON SIGNAL
21	SHIELD	SHIELD
22	W	WOOFER AMP. ON SIGNAL
23	W/L	SOUND SIGNAL REAR LH (-)
24	GR/V	SOUND SIGNAL REAR LH (+)
25	W/L	SOUND SIGNAL REAR RH (-)

Connector No.	D15
Connector Name	FRONT DOOR SPEAKER LH (WITH BOSE SYSTEM)
Connector Type	NS02FBR-CS



26	GR/V	SOUND SIGNAL REAR RH (+)
28	G	SOUND SIGNAL REAR DOOR SPEAKER LH (+)
29	V	SOUND SIGNAL CENTER SPEAKER (+)
30	P	SOUND SIGNAL CENTER SPEAKER (-)
31	BR	SOUND SIGNAL FRONT DOOR SPEAKER RH (+)
32	Y	SOUND SIGNAL FRONT DOOR SPEAKER RH (-)
33	W/R	SOUND SIGNAL FRONT RH (+)
34	B/R	SOUND SIGNAL FRONT RH (-)
35	W/R	SOUND SIGNAL FRONT LH (+)
36	B/R	SOUND SIGNAL FRONT LH (-)

Connector No.	D21
Connector Name	WIRE TO WIRE
Connector Type	TH40FW-CS15

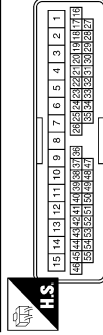

Terminal No.	Color of Wire	Signal Name [Specification]
1	L	-[Type A]
1	W	-[Type B]
2	B/W	-[Type A]
2	B	-[Type B]

Terminal No.	Color of Wire	Signal Name [Specification]
4	B/W	-[Type A]
4	B	-[Type B]
5	L	-[Type A]
5	W	-[Type B]

Terminal No.	Color of Wire	Signal Name [Specification]
1	V	-
2	BR	-
3	W	-
4	V	-
5	SB	-
6	P	-
7	Y	-
8	B	-
9	L	-
10	P	-
11	LG	-

JCNWM1845GI

FRONT DISPLAY UNIT

< ECU DIAGNOSIS >

[BOSE AUDIO WITH NAVIGATION]

BOSE AUDIO WITH NAVIGATION SYSTEM

<table border="1"> <tr><td>Connector No.</td><td>D41</td></tr> <tr><td>Connector Name</td><td>WIRE TO WIRE</td></tr> <tr><td>Connector Type</td><td>TH40PW-CS1.5</td></tr> </table> <table border="1"> <tr><td>Terminal No.</td><td>Color of Wire</td><td>Signal Name [Specification]</td></tr> <tr><td>4</td><td>B/R</td><td>- [Type A]</td></tr> <tr><td>4</td><td>B</td><td>- [Type B]</td></tr> <tr><td>5</td><td>BR</td><td>- [Type A]</td></tr> <tr><td>5</td><td>W</td><td>- [Type B]</td></tr> </table>	Connector No.	D41	Connector Name	WIRE TO WIRE	Connector Type	TH40PW-CS1.5	Terminal No.	Color of Wire	Signal Name [Specification]	4	B/R	- [Type A]	4	B	- [Type B]	5	BR	- [Type A]	5	W	- [Type B]	<table border="1"> <tr><td>Connector No.</td><td>D63</td></tr> <tr><td>Connector Name</td><td>FRONT DOOR SPEAKER RH (WITH BOSE SYSTEM)</td></tr> <tr><td>Connector Type</td><td>NS02FBR-CS</td></tr> </table> <table border="1"> <tr><td>Terminal No.</td><td>Color of Wire</td><td>Signal Name [Specification]</td></tr> <tr><td>1</td><td>BR</td><td>- [Type A]</td></tr> <tr><td>2</td><td>B/R</td><td>- [Type A]</td></tr> <tr><td>2</td><td>B</td><td>- [Type B]</td></tr> </table>	Connector No.	D63	Connector Name	FRONT DOOR SPEAKER RH (WITH BOSE SYSTEM)	Connector Type	NS02FBR-CS	Terminal No.	Color of Wire	Signal Name [Specification]	1	BR	- [Type A]	2	B/R	- [Type A]	2	B	- [Type B]	<table border="1"> <tr><td>Connector No.</td><td>D81</td></tr> <tr><td>Connector Name</td><td>WIRE TO WIRE</td></tr> <tr><td>Connector Type</td><td>TK10MW-NS5</td></tr> </table> <table border="1"> <tr><td>Terminal No.</td><td>Color of Wire</td><td>Signal Name [Specification]</td></tr> <tr><td>4</td><td>L</td><td>-</td></tr> <tr><td>5</td><td>W</td><td>-</td></tr> </table>	Connector No.	D81	Connector Name	WIRE TO WIRE	Connector Type	TK10MW-NS5	Terminal No.	Color of Wire	Signal Name [Specification]	4	L	-	5	W	-	<table border="1"> <tr><td>Connector No.</td><td>D155</td></tr> <tr><td>Connector Name</td><td>WIRE TO WIRE</td></tr> <tr><td>Connector Type</td><td>TK10MW-NS5</td></tr> </table> <table border="1"> <tr><td>Terminal No.</td><td>Color of Wire</td><td>Signal Name [Specification]</td></tr> <tr><td>4</td><td>O</td><td>- [Type A]</td></tr> <tr><td>4</td><td>L</td><td>- [Type B]</td></tr> <tr><td>5</td><td>B/P</td><td>- [Type A]</td></tr> <tr><td>5</td><td>W</td><td>- [Type B]</td></tr> </table>	Connector No.	D155	Connector Name	WIRE TO WIRE	Connector Type	TK10MW-NS5	Terminal No.	Color of Wire	Signal Name [Specification]	4	O	- [Type A]	4	L	- [Type B]	5	B/P	- [Type A]	5	W	- [Type B]
Connector No.	D41																																																																													
Connector Name	WIRE TO WIRE																																																																													
Connector Type	TH40PW-CS1.5																																																																													
Terminal No.	Color of Wire	Signal Name [Specification]																																																																												
4	B/R	- [Type A]																																																																												
4	B	- [Type B]																																																																												
5	BR	- [Type A]																																																																												
5	W	- [Type B]																																																																												
Connector No.	D63																																																																													
Connector Name	FRONT DOOR SPEAKER RH (WITH BOSE SYSTEM)																																																																													
Connector Type	NS02FBR-CS																																																																													
Terminal No.	Color of Wire	Signal Name [Specification]																																																																												
1	BR	- [Type A]																																																																												
2	B/R	- [Type A]																																																																												
2	B	- [Type B]																																																																												
Connector No.	D81																																																																													
Connector Name	WIRE TO WIRE																																																																													
Connector Type	TK10MW-NS5																																																																													
Terminal No.	Color of Wire	Signal Name [Specification]																																																																												
4	L	-																																																																												
5	W	-																																																																												
Connector No.	D155																																																																													
Connector Name	WIRE TO WIRE																																																																													
Connector Type	TK10MW-NS5																																																																													
Terminal No.	Color of Wire	Signal Name [Specification]																																																																												
4	O	- [Type A]																																																																												
4	L	- [Type B]																																																																												
5	B/P	- [Type A]																																																																												
5	W	- [Type B]																																																																												
<table border="1"> <tr><td>Connector No.</td><td>D106</td></tr> <tr><td>Connector Name</td><td>REAR DOOR SPEAKER RH (WITH BOSE SYSTEM)</td></tr> <tr><td>Connector Type</td><td>NS02FBR-CS</td></tr> </table> <table border="1"> <tr><td>Terminal No.</td><td>Color of Wire</td><td>Signal Name [Specification]</td></tr> <tr><td>1</td><td>O</td><td>- [Type A]</td></tr> <tr><td>1</td><td>L</td><td>- [Type B]</td></tr> <tr><td>2</td><td>B/P</td><td>- [Type A]</td></tr> <tr><td>2</td><td>W</td><td>- [Type B]</td></tr> </table>	Connector No.	D106	Connector Name	REAR DOOR SPEAKER RH (WITH BOSE SYSTEM)	Connector Type	NS02FBR-CS	Terminal No.	Color of Wire	Signal Name [Specification]	1	O	- [Type A]	1	L	- [Type B]	2	B/P	- [Type A]	2	W	- [Type B]	<table border="1"> <tr><td>Connector No.</td><td>D182</td></tr> <tr><td>Connector Name</td><td>WIRE TO WIRE</td></tr> <tr><td>Connector Type</td><td>TK12FW</td></tr> </table> <table border="1"> <tr><td>Terminal No.</td><td>Color of Wire</td><td>Signal Name [Specification]</td></tr> <tr><td>6</td><td>R</td><td>-</td></tr> <tr><td>7</td><td>G</td><td>-</td></tr> <tr><td>8</td><td>B</td><td>-</td></tr> <tr><td>9</td><td>SHIELD</td><td>-</td></tr> </table>	Connector No.	D182	Connector Name	WIRE TO WIRE	Connector Type	TK12FW	Terminal No.	Color of Wire	Signal Name [Specification]	6	R	-	7	G	-	8	B	-	9	SHIELD	-																																			
Connector No.	D106																																																																													
Connector Name	REAR DOOR SPEAKER RH (WITH BOSE SYSTEM)																																																																													
Connector Type	NS02FBR-CS																																																																													
Terminal No.	Color of Wire	Signal Name [Specification]																																																																												
1	O	- [Type A]																																																																												
1	L	- [Type B]																																																																												
2	B/P	- [Type A]																																																																												
2	W	- [Type B]																																																																												
Connector No.	D182																																																																													
Connector Name	WIRE TO WIRE																																																																													
Connector Type	TK12FW																																																																													
Terminal No.	Color of Wire	Signal Name [Specification]																																																																												
6	R	-																																																																												
7	G	-																																																																												
8	B	-																																																																												
9	SHIELD	-																																																																												
<table border="1"> <tr><td>Connector No.</td><td>D166</td></tr> <tr><td>Connector Name</td><td>REAR DOOR SPEAKER LH (WITH BOSE SYSTEM)</td></tr> <tr><td>Connector Type</td><td>NS02FBR-CS</td></tr> </table> <table border="1"> <tr><td>Terminal No.</td><td>Color of Wire</td><td>Signal Name [Specification]</td></tr> <tr><td>1</td><td>L</td><td>-</td></tr> <tr><td>2</td><td>W</td><td>-</td></tr> </table>	Connector No.	D166	Connector Name	REAR DOOR SPEAKER LH (WITH BOSE SYSTEM)	Connector Type	NS02FBR-CS	Terminal No.	Color of Wire	Signal Name [Specification]	1	L	-	2	W	-	<table border="1"> <tr><td>Connector No.</td><td>D192</td></tr> <tr><td>Connector Name</td><td>REAR VIEW CAMERA</td></tr> <tr><td>Connector Type</td><td>TH04MW-NH</td></tr> </table> <table border="1"> <tr><td>Terminal No.</td><td>Color of Wire</td><td>Signal Name [Specification]</td></tr> <tr><td>1</td><td>R</td><td>CAMERA ON SIGNAL</td></tr> <tr><td>2</td><td>G</td><td>GND</td></tr> <tr><td>3</td><td>B</td><td>CAMERA IMAGE SIGNAL</td></tr> <tr><td>4</td><td>SHIELD</td><td>SHIELD</td></tr> </table>	Connector No.	D192	Connector Name	REAR VIEW CAMERA	Connector Type	TH04MW-NH	Terminal No.	Color of Wire	Signal Name [Specification]	1	R	CAMERA ON SIGNAL	2	G	GND	3	B	CAMERA IMAGE SIGNAL	4	SHIELD	SHIELD																																									
Connector No.	D166																																																																													
Connector Name	REAR DOOR SPEAKER LH (WITH BOSE SYSTEM)																																																																													
Connector Type	NS02FBR-CS																																																																													
Terminal No.	Color of Wire	Signal Name [Specification]																																																																												
1	L	-																																																																												
2	W	-																																																																												
Connector No.	D192																																																																													
Connector Name	REAR VIEW CAMERA																																																																													
Connector Type	TH04MW-NH																																																																													
Terminal No.	Color of Wire	Signal Name [Specification]																																																																												
1	R	CAMERA ON SIGNAL																																																																												
2	G	GND																																																																												
3	B	CAMERA IMAGE SIGNAL																																																																												
4	SHIELD	SHIELD																																																																												

JCNWM1846GI







A
B
C
D
E
F
G
H
I
J
K
L
M
AV
O
P

FRONT DISPLAY UNIT

< ECU DIAGNOSIS >

[BOSE AUDIO WITH NAVIGATION]

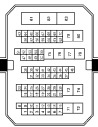
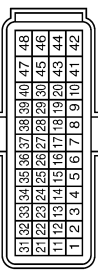
BOSE AUDIO WITH NAVIGATION SYSTEM

<table border="1"> <tr><td>Connector No.</td><td>E6</td></tr> <tr><td>Connector Name</td><td>WIRE TO WIRE</td></tr> <tr><td>Connector Type</td><td>TK16MGY-TV</td></tr> </table>  <table border="1"> <tr><td>Terminal No.</td><td>Color of Wire</td><td>Signal Name [Specification]</td></tr> <tr><td>4</td><td>R</td><td>-</td></tr> </table>	Connector No.	E6	Connector Name	WIRE TO WIRE	Connector Type	TK16MGY-TV	Terminal No.	Color of Wire	Signal Name [Specification]	4	R	-	<table border="1"> <tr><td>Connector No.</td><td>E16</td></tr> <tr><td>Connector Name</td><td>ECM</td></tr> <tr><td>Connector Type</td><td>RH2ZFB-RZ8-L-LH</td></tr> </table>  <table border="1"> <tr><td>Terminal No.</td><td>Color of Wire</td><td>Signal Name [Specification]</td></tr> <tr><td>97</td><td>P</td><td>VEHGAN-L</td></tr> <tr><td>98</td><td>L</td><td>VEHGAN-H</td></tr> </table>	Connector No.	E16	Connector Name	ECM	Connector Type	RH2ZFB-RZ8-L-LH	Terminal No.	Color of Wire	Signal Name [Specification]	97	P	VEHGAN-L	98	L	VEHGAN-H	<table border="1"> <tr><td>Connector No.</td><td>E18</td></tr> <tr><td>Connector Name</td><td>BACK-UP LAMP RELAY</td></tr> <tr><td>Connector Type</td><td>MS2ZFL-M2-LC</td></tr> </table>  <table border="1"> <tr><td>Terminal No.</td><td>Color of Wire</td><td>Signal Name [Specification]</td></tr> <tr><td>1</td><td>LG</td><td>-</td></tr> <tr><td>2</td><td>R</td><td>-</td></tr> <tr><td>3</td><td>LG</td><td>-</td></tr> <tr><td>5</td><td>R</td><td>-</td></tr> </table>	Connector No.	E18	Connector Name	BACK-UP LAMP RELAY	Connector Type	MS2ZFL-M2-LC	Terminal No.	Color of Wire	Signal Name [Specification]	1	LG	-	2	R	-	3	LG	-	5	R	-	<table border="1"> <tr><td>Connector No.</td><td>E27</td></tr> <tr><td>Connector Name</td><td>PARKING BRAKE SWITCH</td></tr> <tr><td>Connector Type</td><td>P01FB-A</td></tr> </table>  <table border="1"> <tr><td>Terminal No.</td><td>Color of Wire</td><td>Signal Name [Specification]</td></tr> <tr><td>1</td><td>P</td><td>-</td></tr> </table>	Connector No.	E27	Connector Name	PARKING BRAKE SWITCH	Connector Type	P01FB-A	Terminal No.	Color of Wire	Signal Name [Specification]	1	P	-	<table border="1"> <tr><td>Connector No.</td><td>E104</td></tr> <tr><td>Connector Name</td><td>WIRE TO WIRE</td></tr> <tr><td>Connector Type</td><td>NS16FW-CS</td></tr> </table>  <table border="1"> <tr><td>Terminal No.</td><td>Color of Wire</td><td>Signal Name [Specification]</td></tr> <tr><td>4</td><td>R</td><td>-</td></tr> <tr><td>5</td><td>L</td><td>-</td></tr> <tr><td>6</td><td>P</td><td>-</td></tr> <tr><td>7</td><td>L</td><td>-</td></tr> </table>	Connector No.	E104	Connector Name	WIRE TO WIRE	Connector Type	NS16FW-CS	Terminal No.	Color of Wire	Signal Name [Specification]	4	R	-	5	L	-	6	P	-	7	L	-	<table border="1"> <tr><td>Connector No.</td><td>E105</td></tr> <tr><td>Connector Name</td><td>WIRE TO WIRE</td></tr> <tr><td>Connector Type</td><td>TH70MW-CS10-M3</td></tr> </table>  <table border="1"> <tr><td>Terminal No.</td><td>Color of Wire</td><td>Signal Name [Specification]</td></tr> <tr><td>5</td><td>LG</td><td>-</td></tr> <tr><td>22</td><td>P</td><td>-</td></tr> <tr><td>47</td><td>P</td><td>-</td></tr> <tr><td>48</td><td>L</td><td>-</td></tr> <tr><td>75</td><td>BR</td><td>-</td></tr> <tr><td>76</td><td>GR</td><td>-</td></tr> <tr><td>78</td><td>V</td><td>-</td></tr> </table>	Connector No.	E105	Connector Name	WIRE TO WIRE	Connector Type	TH70MW-CS10-M3	Terminal No.	Color of Wire	Signal Name [Specification]	5	LG	-	22	P	-	47	P	-	48	L	-	75	BR	-	76	GR	-	78	V	-	<table border="1"> <tr><td>Connector No.</td><td>F23</td></tr> <tr><td>Connector Name</td><td>TCM (TRANSMISSION CONTROL MODULE)</td></tr> <tr><td>Connector Type</td><td>RH4QFB-RZ8-L-RH</td></tr> </table>  <table border="1"> <tr><td>Terminal No.</td><td>Color of Wire</td><td>Signal Name [Specification]</td></tr> <tr><td>19</td><td>G/B</td><td>REV LAMP RELAY</td></tr> </table>	Connector No.	F23	Connector Name	TCM (TRANSMISSION CONTROL MODULE)	Connector Type	RH4QFB-RZ8-L-RH	Terminal No.	Color of Wire	Signal Name [Specification]	19	G/B	REV LAMP RELAY	<table border="1"> <tr><td>Connector No.</td><td>F23</td></tr> <tr><td>Connector Name</td><td>WIRE TO WIRE</td></tr> <tr><td>Connector Type</td><td>TK16FGY-TV</td></tr> </table>  <table border="1"> <tr><td>Terminal No.</td><td>Color of Wire</td><td>Signal Name [Specification]</td></tr> <tr><td>4</td><td>G/B</td><td>-</td></tr> </table>	Connector No.	F23	Connector Name	WIRE TO WIRE	Connector Type	TK16FGY-TV	Terminal No.	Color of Wire	Signal Name [Specification]	4	G/B	-
Connector No.	E6																																																																																																																																													
Connector Name	WIRE TO WIRE																																																																																																																																													
Connector Type	TK16MGY-TV																																																																																																																																													
Terminal No.	Color of Wire	Signal Name [Specification]																																																																																																																																												
4	R	-																																																																																																																																												
Connector No.	E16																																																																																																																																													
Connector Name	ECM																																																																																																																																													
Connector Type	RH2ZFB-RZ8-L-LH																																																																																																																																													
Terminal No.	Color of Wire	Signal Name [Specification]																																																																																																																																												
97	P	VEHGAN-L																																																																																																																																												
98	L	VEHGAN-H																																																																																																																																												
Connector No.	E18																																																																																																																																													
Connector Name	BACK-UP LAMP RELAY																																																																																																																																													
Connector Type	MS2ZFL-M2-LC																																																																																																																																													
Terminal No.	Color of Wire	Signal Name [Specification]																																																																																																																																												
1	LG	-																																																																																																																																												
2	R	-																																																																																																																																												
3	LG	-																																																																																																																																												
5	R	-																																																																																																																																												
Connector No.	E27																																																																																																																																													
Connector Name	PARKING BRAKE SWITCH																																																																																																																																													
Connector Type	P01FB-A																																																																																																																																													
Terminal No.	Color of Wire	Signal Name [Specification]																																																																																																																																												
1	P	-																																																																																																																																												
Connector No.	E104																																																																																																																																													
Connector Name	WIRE TO WIRE																																																																																																																																													
Connector Type	NS16FW-CS																																																																																																																																													
Terminal No.	Color of Wire	Signal Name [Specification]																																																																																																																																												
4	R	-																																																																																																																																												
5	L	-																																																																																																																																												
6	P	-																																																																																																																																												
7	L	-																																																																																																																																												
Connector No.	E105																																																																																																																																													
Connector Name	WIRE TO WIRE																																																																																																																																													
Connector Type	TH70MW-CS10-M3																																																																																																																																													
Terminal No.	Color of Wire	Signal Name [Specification]																																																																																																																																												
5	LG	-																																																																																																																																												
22	P	-																																																																																																																																												
47	P	-																																																																																																																																												
48	L	-																																																																																																																																												
75	BR	-																																																																																																																																												
76	GR	-																																																																																																																																												
78	V	-																																																																																																																																												
Connector No.	F23																																																																																																																																													
Connector Name	TCM (TRANSMISSION CONTROL MODULE)																																																																																																																																													
Connector Type	RH4QFB-RZ8-L-RH																																																																																																																																													
Terminal No.	Color of Wire	Signal Name [Specification]																																																																																																																																												
19	G/B	REV LAMP RELAY																																																																																																																																												
Connector No.	F23																																																																																																																																													
Connector Name	WIRE TO WIRE																																																																																																																																													
Connector Type	TK16FGY-TV																																																																																																																																													
Terminal No.	Color of Wire	Signal Name [Specification]																																																																																																																																												
4	G/B	-																																																																																																																																												

JCNWM1847GI

FRONT DISPLAY UNIT

< ECU DIAGNOSIS >

[BOSE AUDIO WITH NAVIGATION]

BOSE AUDIO WITH NAVIGATION SYSTEM

Connector No. M1	FUSE BLOCK (J/B)	NS06FW-M2		Terminal No. 2A 5A	Color of Wire G R	Signal Name [Specification]	
Connector No. M3	FUSE BLOCK (J/B)	NS12FW-CS		Terminal No. 12C	Color of Wire O	Signal Name [Specification]	
Connector No. M4	DATA LINK CONNECTOR	BD16FW		Terminal No. 6 14	Color of Wire L P	Signal Name [Specification]	
Connector No. M11	WIRE TO WIRE	TH10FW-CS (P-M3)		Terminal No. 5 22 47 48 75 78	Color of Wire O G P L BR R Y	Signal Name [Specification]	
Connector No. M20	WIRE TO WIRE	TH40MW-CS15		Terminal No. 4 5	Color of Wire B L	Signal Name [Specification]	
Connector No. M18	WIRE TO WIRE	TH40MW-CS15		Terminal No. 4 5	Color of Wire W BR	Signal Name [Specification]	- [Type A and without BOSE system type B] - [With BOSE system type B]
Connector No. M22	WIRE TO WIRE	TH12FW-NH		Terminal No. 1 2 3 4 5 6 7 8 9 10 11	Color of Wire V R R G W SHIELD LG SHIELD BR SHIELD L	Signal Name [Specification]	

JCNWM1848GI

A
B
C
D
E
F
G
H
I
J
K
L
M
AV
O
P

FRONT DISPLAY UNIT

< ECU DIAGNOSIS >

[BOSE AUDIO WITH NAVIGATION]

BOSE AUDIO WITH NAVIGATION SYSTEM

Connector No.	M23
Connector Name	WIRE TO WIRE
Connector Type	TH16MW-NH

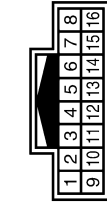

Terminal No.	Color of Wire	Signal Name [Specification]
1	W	-
2	SHIELD	[With telephone and navigation system]
3	B	-

Connector No.	M30
Connector Name	STEERING ANGLE SENSOR
Connector Type	TH08FW-NH

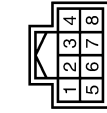

Terminal No.	Color of Wire	Signal Name [Specification]
1	B	-
3	L	-
4	G	-
6	SB	-
8	O	-

Connector No.	M33
Connector Name	COMBINATION SWITCH (SPIRAL CABLE)
Connector Type	TK08FGY-1V

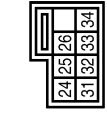

Terminal No.	Color of Wire	Signal Name [Specification]
24	BR	[With audio steering switch and telephone]
31	G	[With audio steering switch and telephone]
33	L	[With audio steering switch and telephone]

Connector No.	M34
Connector Name	COMBINATION METER
Connector Type	TH40FW-NH

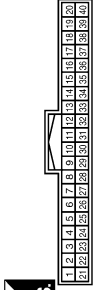

Terminal No.	Color of Wire	Signal Name [Specification]
21	L	CAN-H
22	P	CAN-L
31	V	VEHICLE SPEED (8-PULSE)

Connector No.	M44
Connector Name	WIRE TO WIRE
Connector Type	TH32FW-NH

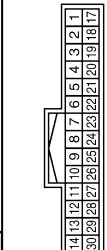

Terminal No.	Color of Wire	Signal Name [Specification]
1	G	-
2	R	-
3	SHIELD	-
4	B	-
5	W	-
6	SHIELD	-
7	O	- [Type A]
8	SB	- [Type B]
9	R	- [Type A]
		- [Type B]

Connector No.	M49
Connector Name	FRONT DISPLAY UNIT
Connector Type	TH24FW-NH

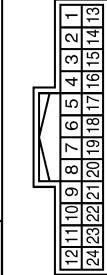

Terminal No.	Color of Wire	Signal Name [Specification]
1	B	GND
2	Y	BATTERY [With navigation system]
3	R	ACC [With navigation system]
4	SHIELD	SHIELD [With navigation system]
5	B	AUX IMAGE GND [With navigation system]
6	R	RGB (GREEN) SIGNAL [With navigation system]
7	SHIELD	SHIELD
8	B	HPI [With navigation system]
9	W	RGB AREA (YS) SIGNAL
11	R	COMM (CONT->DISP)
12	W	CAMERA IMAGE SIGNAL

Terminal No.	Color of Wire	Signal Name [Specification]
13	B	GND [With navigation system]
14	SHIELD	SHIELD [With navigation system]
15	Y	AUX IMAGE SIGNAL [With navigation system]
17	G	RGB (RED) SIGNAL
18	W	RGB (BLUE) SIGNAL [With navigation system]
19	B	RGB SYNC
20	R	VP
21	SHIELD	SHIELD
22	G	COMM (DISP->CONT)
23	SHIELD	SHIELD

FRONT DISPLAY UNIT

< ECU DIAGNOSIS >

[BOSE AUDIO WITH NAVIGATION]

BOSE AUDIO WITH NAVIGATION SYSTEM

Connector No.	M65
Connector Name	FRONT SQUAWKER LH
Connector Type	TK02FBR



Terminal No.	Color of Wire	Signal Name [Specification]
1	LG	- [With BOSE system]
2	Y	- [With BOSE system]

Connector No.	M66
Connector Name	CENTER SPEAKER
Connector Type	TK02FBR



Terminal No.	Color of Wire	Signal Name [Specification]
1	P	-
2	O	-

Connector No.	M67
Connector Name	FRONT SQUAWKER RH
Connector Type	TK02FBR



Terminal No.	Color of Wire	Signal Name [Specification]
1	BR	-
2	R	- [With BOSE system]

Connector No.	M77
Connector Name	WIRE TO WIRE
Connector Type	TH80FW-CS19

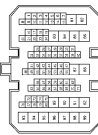

Terminal No.	Color of Wire	Signal Name [Specification]
41	O	-
42	SB	-
43	L	-
44	V	-
45	P	-
46	R	-
47	Y	-
48	L	-
49	G	-
50	SHIELD	-
51	W	-

56	P	-
57	L	-
58	SB	-
66	L	-
67	R	-

Connector No.	M97
Connector Name	WIRE TO WIRE
Connector Type	TH18FW-CS2

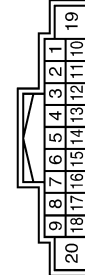

Terminal No.	Color of Wire	Signal Name [Specification]
5	SHIELD	-
6	W	-
8	B	-
9	Y	-
14	R	-
15	B	-
17	SHIELD	-
18	B	- [Type A and With navigation system type B]

Connector No.	M122
Connector Name	BCM (BODY CONTROL MODULE)
Connector Type	TH40FB-NH



Terminal No.	Color of Wire	Signal Name [Specification]
90	P	CAN-L
91	L	CAN-H

JCNWM1850GI

A
B
C
D
E
F
G
H
I
J
K
L
M
N
O
P

AV

FRONT DISPLAY UNIT

< ECU DIAGNOSIS >

[BOSE AUDIO WITH NAVIGATION]

BOSE AUDIO WITH NAVIGATION SYSTEM

Connector No.	M124
Connector Name	WIRE TO WIRE
Connector Type	TH12FB-CS

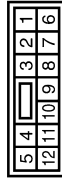

Terminal No.	Color of Wire	Signal Name [Specification]
1	P	-
2	BR	- [Type A]
3	L	- [Type B]
4	Y	-
5	BR	-
6	O	-
7	W	-
8	B	-
9	R	-
10	BR	-

Connector No.	M144
Connector Name	AV CONTROL UNIT (WITH NAVIGATION SYSTEM)
Connector Type	TH18FW-CS2

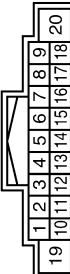

Terminal No.	Color of Wire	Signal Name [Specification]
1	P	AMP ON SIGNAL
2	G	SOUND SIGNAL FRONT LH (+)
3	R	SOUND SIGNAL FRONT LH (-)
4	O	SOUND SIGNAL REAR LH (+) [Type A]
4	L	SOUND SIGNAL REAR LH (+) [Type B]
5	SB	SOUND SIGNAL REAR LH (-) [Type A]
5	R	SOUND SIGNAL REAR LH (-) [Type B]
6	BR	STRG SW A
7	R	ACC
9	R	ILLUMINATION
10	SHIELD	SHIELD

11	LG
12	R

Connector No.	M125
Connector Name	MULTIFUNCTION SWITCH
Connector Type	TH16FW-NH



Terminal No.	Color of Wire	Signal Name [Specification]
1	B	GND
3	R	ACC
6	R	AV COMM (H)
8	L	AV COMM (L)
9	V	SW GND
14	W	EJECT SIGNAL

11	B	SOUND SIGNAL FRONT RH (+)
12	W	SOUND SIGNAL FRONT RH (-)
13	V	SOUND SIGNAL REAR RH (+)
14	LG	SOUND SIGNAL REAR RH (-)
15	L	STRG SW GND
16	G	STRG SW B
19	Y	BATTERY

Connector No.	M145
Connector Name	AV CONTROL UNIT (WITH NAVIGATION SYSTEM)
Connector Type	TH40FW-NH



Terminal No.	Color of Wire	Signal Name [Specification]
21	B	GND
22	Y	BATTERY
23	B	GND
24	Y	BATTERY
25	R	ACC
26	B	MICROPHONE VCC
27	SHIELD	MICROPHONE GND
28	W	MICROPHONE SIGNAL
35	G	IGNITION
36	G	PARKING BRAKE
37	SB	REVERSE

38	V	VEHICLE SPEED (8-PULSE)
40	P	CONNECTION RECOGNITION CONTROL SIGNAL
42	B	CONNECTION RECOGNITION CONTROL SIGNAL
43	B	CONNECTION RECOGNITION CONTROL SIGNAL
48	G	AV COMM (H)
49	L	AV COMM (L)
50	R	AV COMM (H)
51	L	AV COMM (L)
52	L	CAN-H
53	P	CAN-L

FRONT DISPLAY UNIT

[BOSE AUDIO WITH NAVIGATION]

< ECU DIAGNOSIS >

BOSE AUDIO WITH NAVIGATION SYSTEM

Connector No.	M146
Connector Name	AV CONTROL UNIT (WITH NAVIGATION SYSTEM)
Connector Type	TH12FW-NH



62	64	66	68	70	72
61	63	65	67	69	71

Terminal No.	Color of Wire	Signal Name [Specification]
61	G	RGB (R/RED) SIGNAL
62	R	RGB (G/GREEN) SIGNAL
63	W	RGB (B/BLUE) SIGNAL
64	SHIELD	SHIELD
65	B	RGB SYNC
66	SHIELD	SHIELD
67	W	RGB AREA (YS) SIGNAL
68	B	HP
69	R	VP
70	R	COMM (CONT->DISP)
71	G	COMM (DISP->CONT)

Connector No.	M148
Connector Name	iPod ADAPTER
Connector Type	TH12FW-NH



1	2	3	4	5	6	7	8	9	10	11	12
13	14	15	16	17	18	19	20	21	22	23	24

Terminal No.	Color of Wire	Signal Name [Specification]
1	BR	iPod SOUND SIGNAL LH (+)
2	R	iPod SOUND SIGNAL RH (+)
3	R	ACC
4	L	AV COMM (L)
5	Y	BATTERY
8	W	CHARGE POWER
9	G	COMM (iPod ADAPTER->iPod)
10	R	COMM (iPod->iPod ADAPTER)
11	R	ACCESSORY IDENTITY
12	V	iPod SOUND SIGNAL RH (+)
13	L	iPod SOUND SIGNAL LH (+)

72	SHIELD	SHIELD
----	--------	--------

Connector No.	M147
Connector Name	AV CONTROL UNIT (WITH NAVIGATION SYSTEM)
Connector Type	TH12FW-NH



73	74	75	76	77	78	79	80	81	82	83	84	85	86	87	88
89	90	91	92	93	94	95	96	97	98	99	100	101	102	103	104

Terminal No.	Color of Wire	Signal Name [Specification]
79	BR	iPod SOUND SIGNAL LH (+)
80	R	iPod SOUND SIGNAL RH (+)
81	SHIELD	SHIELD
85	W	EJECT SIGNAL
86	SHIELD	SHIELD
87	B	AUX SOUND SIGNAL LH (+)
88	W	AUX SOUND SIGNAL GND
95	L	iPod SOUND SIGNAL LH (+)
96	W	iPod SOUND SIGNAL RH (+)
102	V	SW GND
103	R	AUX SOUND SIGNAL RH (+)

Connector No.	M204
Connector Name	WIRE TO WIRE
Connector Type	TH12MW-NH



1	2	3	4	5	6
7	8	9	10	11	12

Terminal No.	Color of Wire	Signal Name [Specification]
1	V	-
2	R	-
3	R	-
4	G	-
5	W	-
6	SHIELD	-
7	LG	-
8	SHIELD	-
9	BR	-
10	SHIELD	-
11	L	-

12	R	-
----	---	---

A
B
C
D
E
F
G
H
I
J
K
L
M
N
O
P

AV

JCNWM1852GI

FRONT DISPLAY UNIT

< ECU DIAGNOSIS >

[BOSE AUDIO WITH NAVIGATION]

BOSE AUDIO WITH NAVIGATION SYSTEM

Connector No.	M260
Connector Name	iPod SIDE
Connector Type	IP18FGY

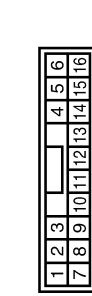

Terminal No.	Color of Wire	Signal Name [Specification]
1	LG	iPod SOUND SIGNAL LH (+)
2	R	iPod SOUND SIGNAL GND
5	R	COMM (iPod->iPod ADAPTER)
6	G	COMM (iPod ADAPTER->iPod)
7	V	iPod SOUND SIGNAL RH (+)
9	L	iPod CONNECTION RECOGNITION
10	SHIELD	GND
12	W	CHARGE POWER
14	SHIELD	SHIELD
15	BR	ACCESSORY DETECT
16	R	ACCESSORY IDENTITY

Connector No.	M253
Connector Name	AUXILIARY INPUT JACKS
Connector Type	AB8FW

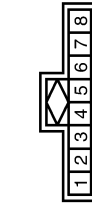

Terminal No.	Color of Wire	Signal Name [Specification]
1	R	SOUND SIGNAL RH (+)
2	W	SOUND SIGNAL GND
3	B	SOUND SIGNAL LH (+) [Without DVD player]
7	G	AUX IMAGE SIGNAL
8	R	AUX IMAGE GND [Without DVD player]

Terminal No.	Color of Wire	Signal Name [Specification]
14	-	-
15	-	-
17	-	-

Terminal No.	Color of Wire	Signal Name [Specification]
1	LG	iPod SOUND SIGNAL LH (+)
2	R	iPod SOUND SIGNAL GND
5	R	COMM (iPod->iPod ADAPTER)
6	G	COMM (iPod ADAPTER->iPod)
7	V	iPod SOUND SIGNAL RH (+)
9	L	iPod CONNECTION RECOGNITION
10	SHIELD	GND
12	W	CHARGE POWER
14	SHIELD	SHIELD
15	BR	ACCESSORY DETECT
16	R	ACCESSORY IDENTITY

Terminal No.	Color of Wire	Signal Name [Specification]
1	R	SOUND SIGNAL RH (+)
2	W	SOUND SIGNAL GND
3	B	SOUND SIGNAL LH (+) [Without DVD player]
7	G	AUX IMAGE SIGNAL
8	R	AUX IMAGE GND [Without DVD player]

Terminal No.	Color of Wire	Signal Name [Specification]
5	SHIELD	-
6	W	-
8	SHIELD	-
9	G	-
14	R	-
15	B	-
17	SHIELD	-
18	R	-

Connector No.	M374
Connector Name	WIRE TO WIRE
Connector Type	GT16C-1PP-HU



Terminal No.	Color of Wire	Signal Name [Specification]
1	-	-
2	-	-

Connector No.	M372
Connector Name	AV CONTROL UNIT (WITH NAVIGATION SYSTEM)
Connector Type	FAKRA



Terminal No.	Color of Wire	Signal Name [Specification]
108	-	-
109	-	-

Terminal No.	Color of Wire	Signal Name [Specification]
1	-	-

Terminal No.	Color of Wire	Signal Name [Specification]
1	-	-

Terminal No.	Color of Wire	Signal Name [Specification]
108	-	SATELLITE ANTENNA

Terminal No.	Color of Wire	Signal Name [Specification]
105	-	FM SUB
106	-	AM-FM MAIN
107	-	ANTENNA AMP. ON SIGNAL

JCNWM1853GI

FRONT DISPLAY UNIT

< ECU DIAGNOSIS >

[BOSE AUDIO WITH NAVIGATION]

BOSE AUDIO WITH NAVIGATION SYSTEM

Connector No.	M378
Connector Name	ANTENNA BASE (ANTENNA AMP.)
Connector Type	GT13SSN-1 / IPP-HU



Terminal No.	Color of Wire	Signal Name [Specification]
1	-	-
3	-	-

Connector No.	M377
Connector Name	ANTENNA BASE (SATELLITE ANTENNA) (WITH NAVIGATION SYSTEM)
Connector Type	GT16C-IPP-HU



Terminal No.	Color of Wire	Signal Name [Specification]
1	-	SATELLITE ANTENNA

Connector No.	M376
Connector Name	WIRE TO WIRE
Connector Type	GT13SSN-2 / IPP-HU



Terminal No.	Color of Wire	Signal Name [Specification]
1	-	-
2	-	-
3	-	-

Connector No.	M375
Connector Name	WIRE TO WIRE
Connector Type	GT13SH-2 / IS-HU



Terminal No.	Color of Wire	Signal Name [Specification]
1	-	-
2	-	-
3	-	-

Connector No.	R20
Connector Name	MICROPHONE
Connector Type	TK04FW



Terminal No.	Color of Wire	Signal Name [Specification]
1	R/W	MICROPHONE SIGNAL (+)
2	SHIELD	SHIELD (With telephone and navigation system)
4	B	MICROPHONE POWER

Connector No.	R1
Connector Name	WIRE TO WIRE
Connector Type	TH16FW-NH

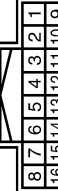

Terminal No.	Color of Wire	Signal Name [Specification]
1	R/W	-
2	SHIELD	-(With telephone and navigation system)
3	B	-

Connector No.	M380
Connector Name	AV CONTROL UNIT (WITH NAVIGATION SYSTEM)
Connector Type	GT5-IS-HU



Terminal No.	Color of Wire	Signal Name [Specification]
110	-	GPS ANTENNA
111	-	SHIELD

Connector No.	M379
Connector Name	GLASS ANTENNA
Connector Type	GT13SSN-1 / IPP-HU



Terminal No.	Color of Wire	Signal Name [Specification]
2	-	FM SUB

A
B
C
D
E
F
G
H
I
J
K
L
M
AV
O
P

JCNWM1854GI

BOSE AMP.

< ECU DIAGNOSIS >

[BOSE AUDIO WITH NAVIGATION]

BOSE AMP.

Reference Values

INFOID:000000003457767

TERMINAL LAYOUT

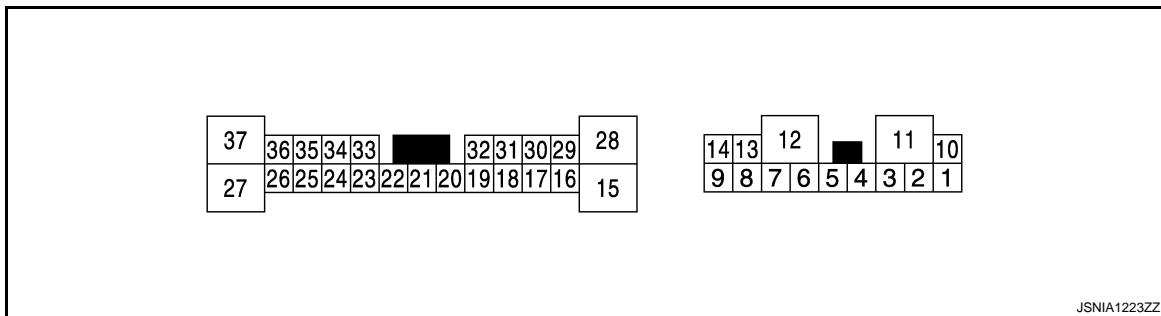

PHYSICAL VALUES

Terminal (Wire color)		Description		Condition		Reference value (Approx.)
+	-	Signal name	Input/ Output			
1 (LG)	2 (V)	Sound signal front squawker LH	Output	Ignition switch ON	Sound output.	<p>SKIB3609E</p>
4 (P)	3 (L)	Sound signal front squawker RH	Output	Ignition switch ON	Sound output.	<p>SKIB3609E</p>
5 (Y)	6 (BR)	Sound signal rear speaker RH	Output	Ignition switch ON	Sound output.	<p>SKIB3609E</p>
7 (B)	Ground	Ground	—	Ignition switch ON	—	0 V
10 (SB)	Ground	Battery power supply	Input	Ignition switch OFF	—	Battery voltage
11 (GR)	Ground	Battery power supply	Input	Ignition switch OFF	—	Battery voltage
12 (B)	Ground	Ground	—	Ignition switch ON	—	0 V

BOSE AMP.

< ECU DIAGNOSIS >

[BOSE AUDIO WITH NAVIGATION]

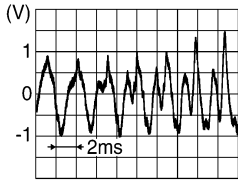
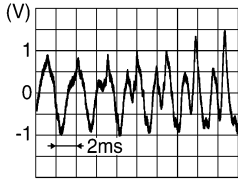
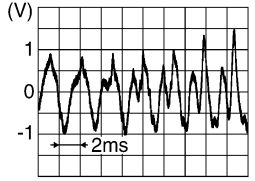
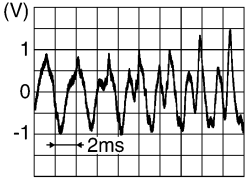
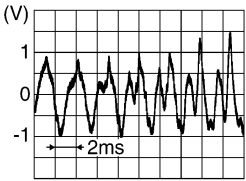
Terminal (Wire color)		Description		Condition		Reference value (Approx.)
+	-	Signal name	Input/ Output			
13 (GR)	8 (BR)	Sound signal rear speaker LH	Output	Ignition switch ON	Sound output.	 <p style="text-align: right; font-size: small;">SKIB3609E</p>
14 (L)	9 (O)	Sound signal rear door speaker RH	Output	Ignition switch ON	Sound output.	 <p style="text-align: right; font-size: small;">SKIB3609E</p>
16 (B/R)	17 (W/R)	Sound signal woofer	Output	Ignition switch ON	Sound output.	 <p style="text-align: right; font-size: small;">SKIB3609E</p>
18 (W)	19 (B)	Sound signal front door speaker LH	Output	Ignition switch ON	Sound output.	 <p style="text-align: right; font-size: small;">SKIB3609E</p>
20 (SB)	Ground	Amp. ON signal	Input	Ignition switch ACC	—	12.0 V
21	—	Shield	—	—	—	—
22 (W)	Ground	Woofer Amp. ON signal	Output	Ignition switch ACC	—	12.0 V
24 (GR/V)	23 (W/L)	Sound signal rear LH	Input	Ignition switch ON	Sound output.	 <p style="text-align: right; font-size: small;">SKIB3609E</p>

A
B
C
D
E
F
G
H
I
J
K
L
M
AV
O
P

AV

BOSE AMP.

< ECU DIAGNOSIS >

[BOSE AUDIO WITH NAVIGATION]

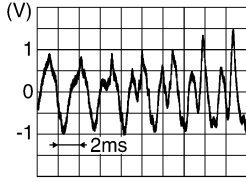
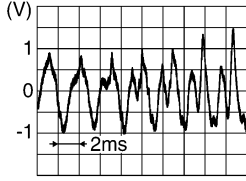
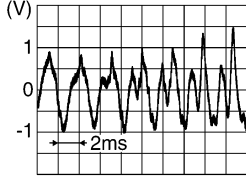
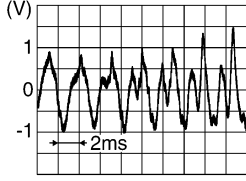
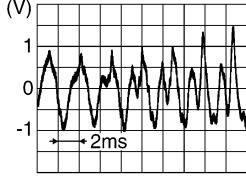
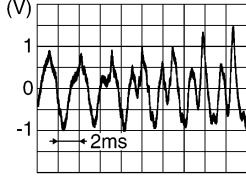
Terminal (Wire color)		Description		Condition		Reference value (Approx.)
+	-	Signal name	Input/ Output			
26 (GR/V)	25 (W/L)	Sound signal rear RH	Input	Ignition switch ON	Sound output.	 <p style="text-align: right; font-size: small;">SKIB3609E</p>
28 (G)	15 (R)	Sound signal rear door speaker LH	Output	Ignition switch ON	Sound output.	 <p style="text-align: right; font-size: small;">SKIB3609E</p>
29 (V)	30 (P)	Sound signal center speak- er	Output	Ignition switch ON	Sound output.	 <p style="text-align: right; font-size: small;">SKIB3609E</p>
31 (BR)	32 (Y)	Sound signal front door speaker RH	Output	Ignition switch ON	Sound output.	 <p style="text-align: right; font-size: small;">SKIB3609E</p>
33 (W/R)	34 (B/R)	Sound signal front RH	Input	Ignition switch ON	Sound output.	 <p style="text-align: right; font-size: small;">SKIB3609E</p>
35 (W/R)	36 (B/R)	Sound signal front LH	Input	Ignition switch ON	Sound output.	 <p style="text-align: right; font-size: small;">SKIB3609E</p>

Wiring Diagram - BOSE AUDIO WITH NAVIGATION SYSTEM -

INFOID:000000003702903

NOTE:

BOSE AMP.

< ECU DIAGNOSIS >

[BOSE AUDIO WITH NAVIGATION]

In this section, PRESET SWITCH and MULTIFUNCTION SWITCH are written as the MULTIFUNCTION SWITCH.

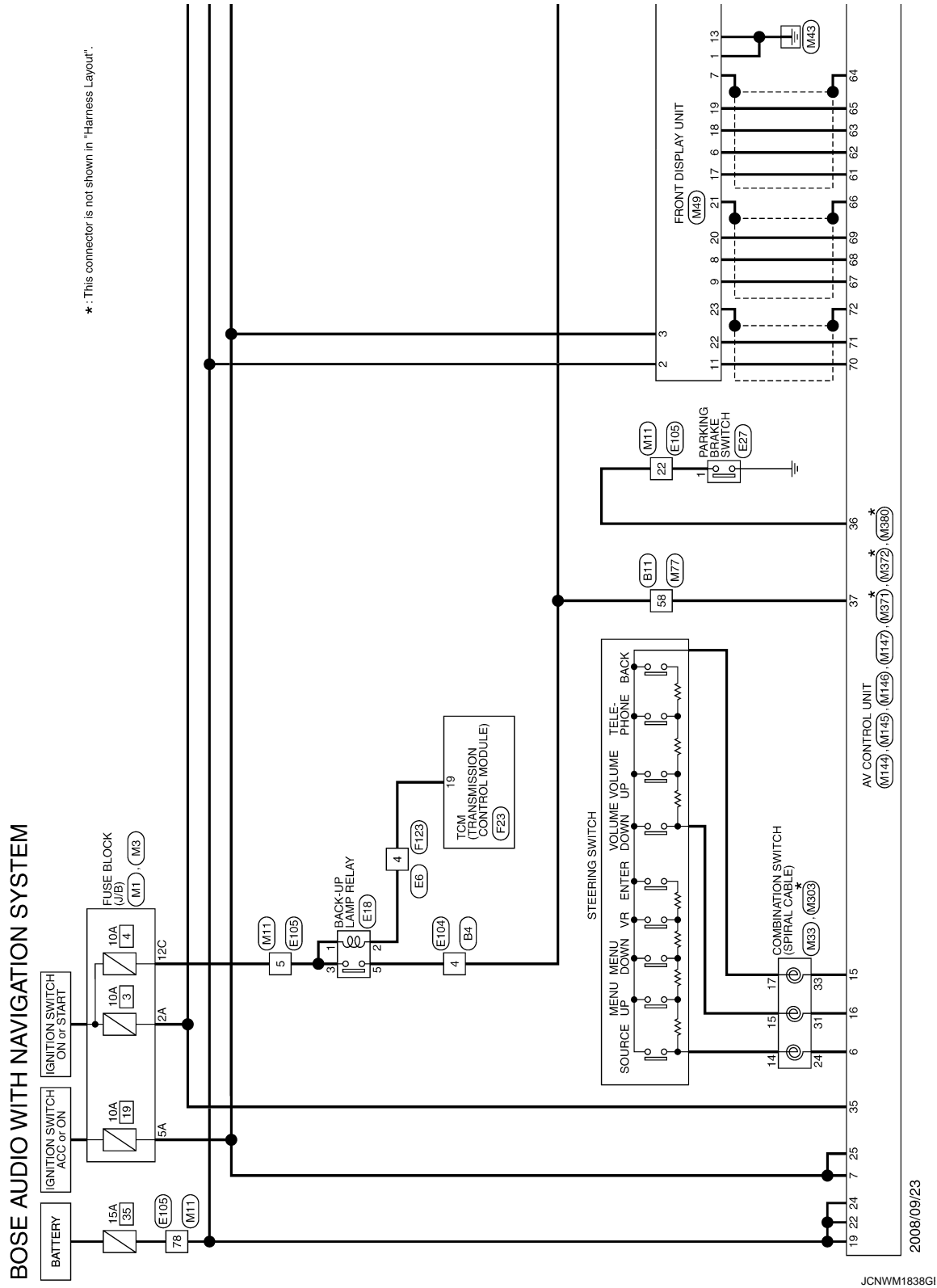

A
B
C
D
E
F
G
H
I
J
K
L
M
N
O
P

AV

BOSE AMP.

< ECU DIAGNOSIS >

[BOSE AUDIO WITH NAVIGATION]

◁ WI ▷ : With iPod

* : This connector is not shown in "Harness Layout".

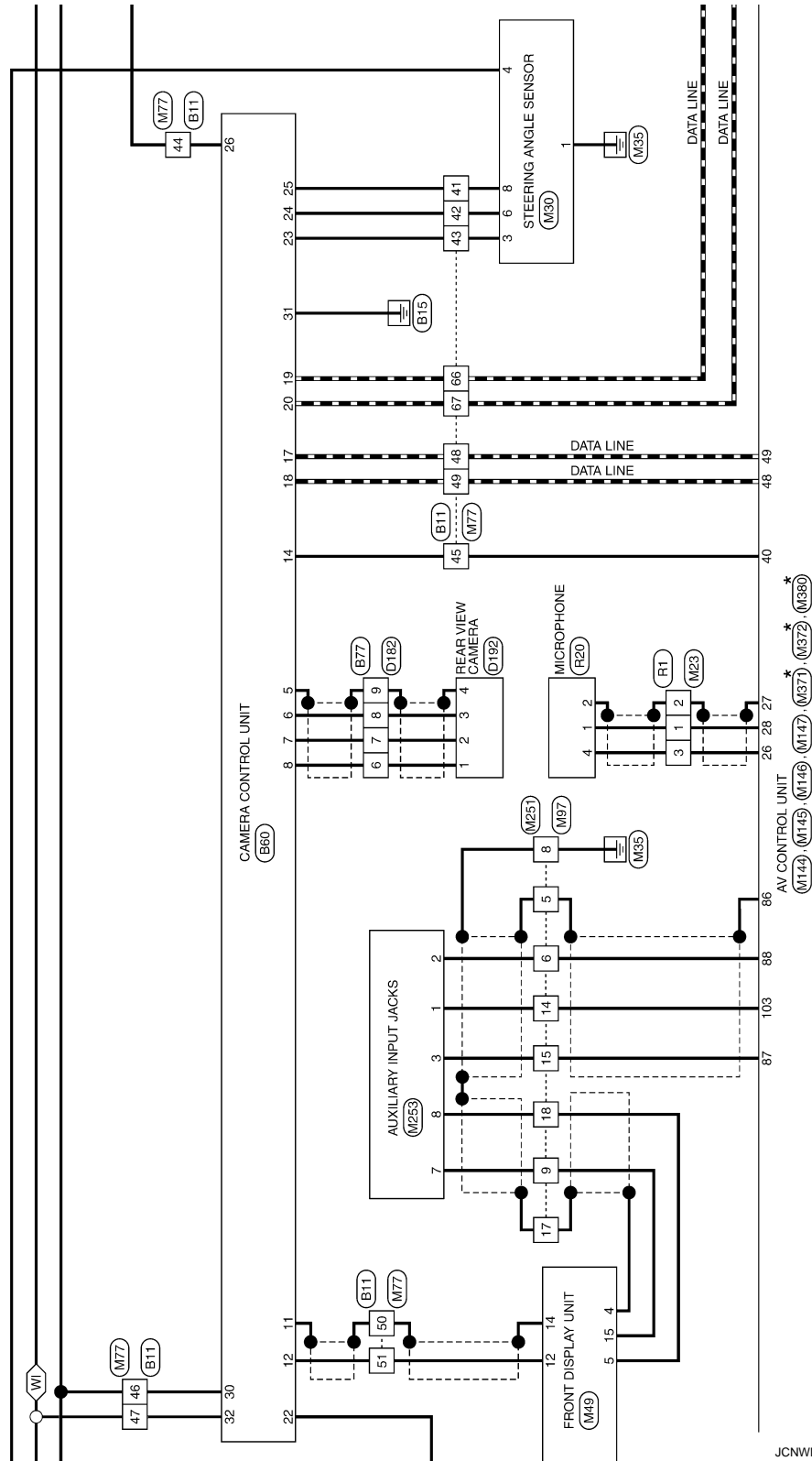

JCNWM1839GI

BOSE AMP.

< ECU DIAGNOSIS >

[BOSE AUDIO WITH NAVIGATION]

AB : With automatic back door
OA : Without automatic back door
WI : With iPod
WO : Without automatic back door

* : This connector is not shown in "Harness Layout".

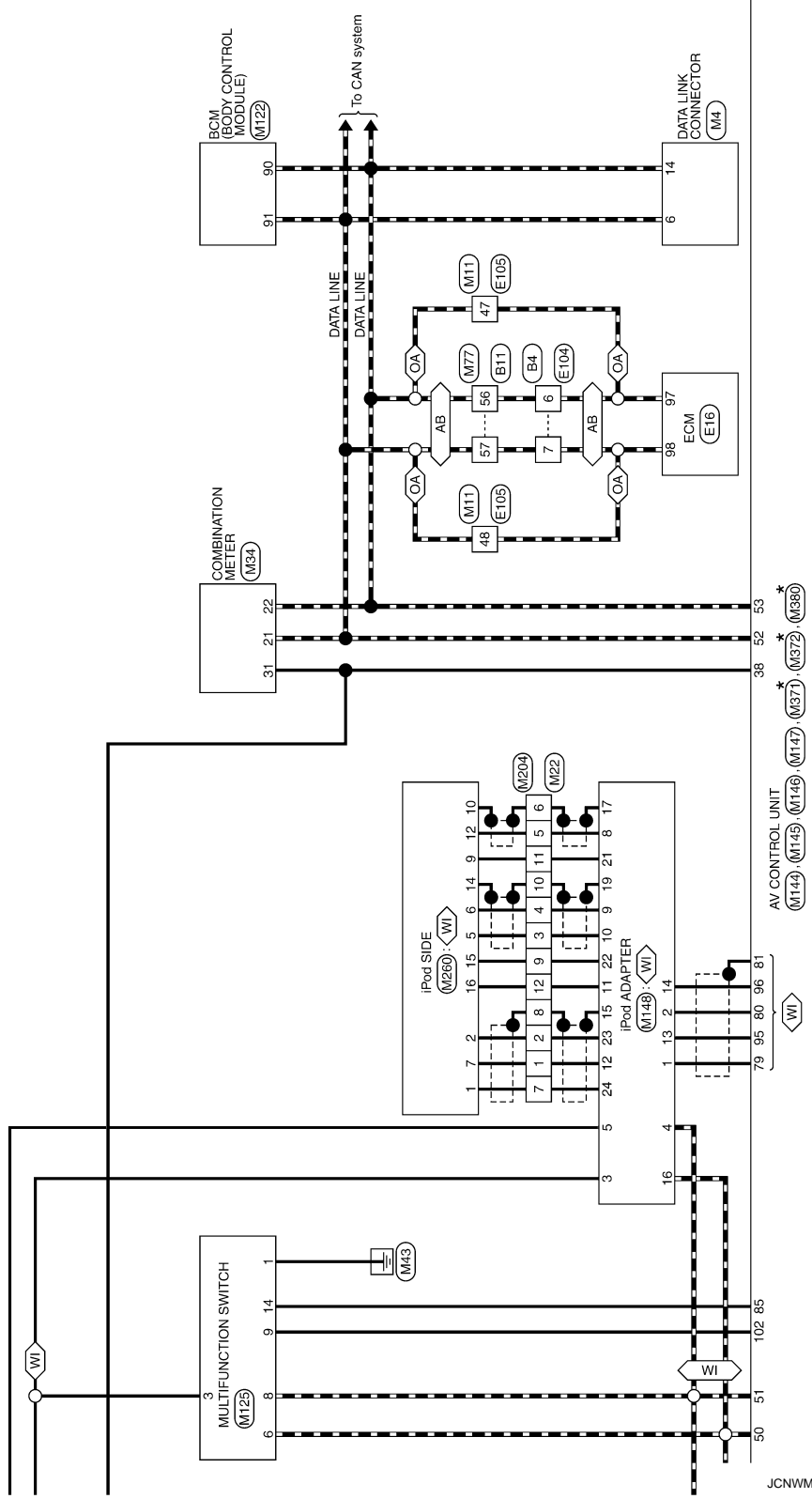

JCNWM1840GI

A
B
C
D
E
F
G
H
I
J
K
L
M
AV
O
P

BOSE AMP.

< ECU DIAGNOSIS >

[BOSE AUDIO WITH NAVIGATION]

*: This connector is not shown in "Harness Layout".

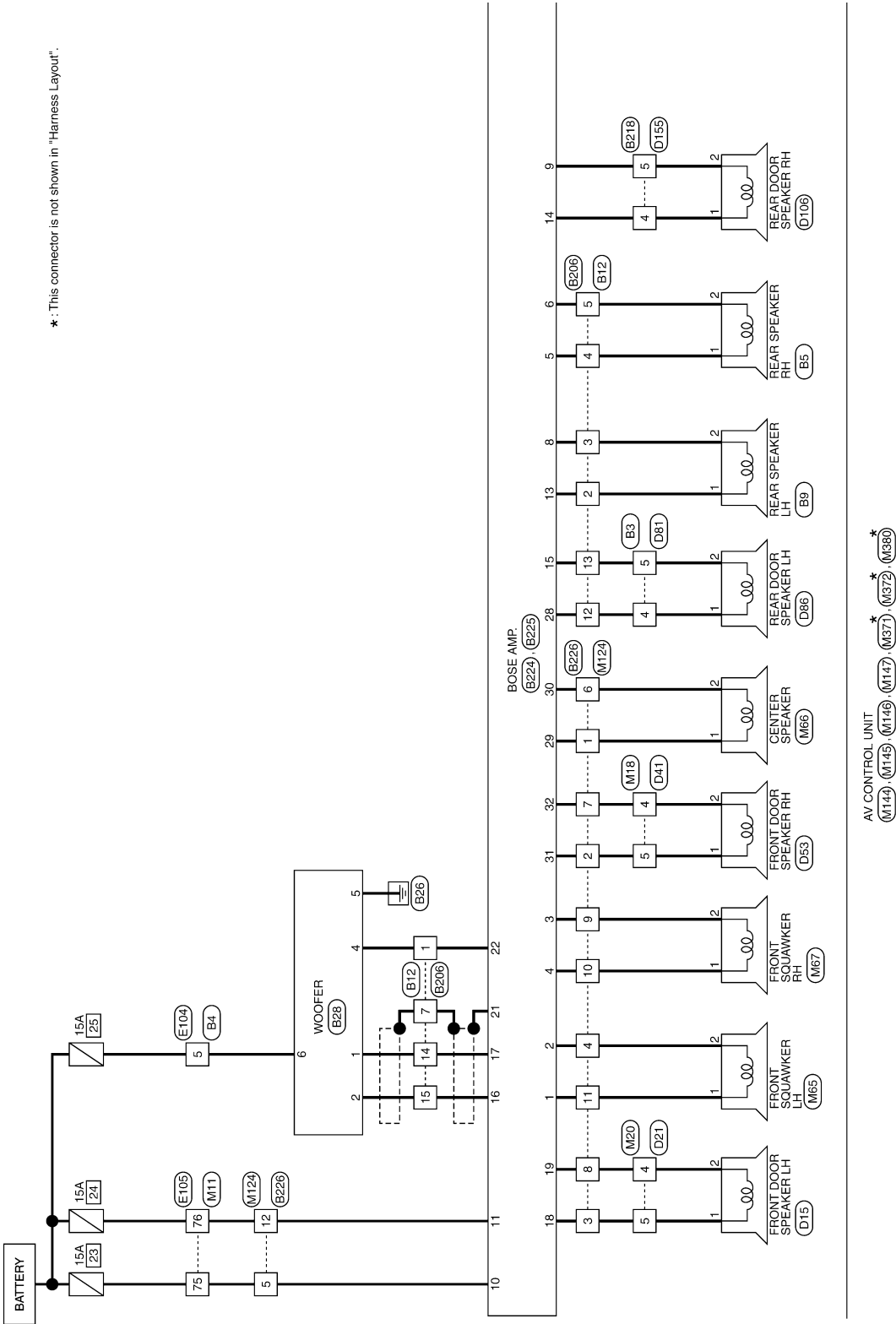

JCNWM1841GI

BOSE AMP.

< ECU DIAGNOSIS >

[BOSE AUDIO WITH NAVIGATION]

*: This connector is not shown in "Harness Layout".

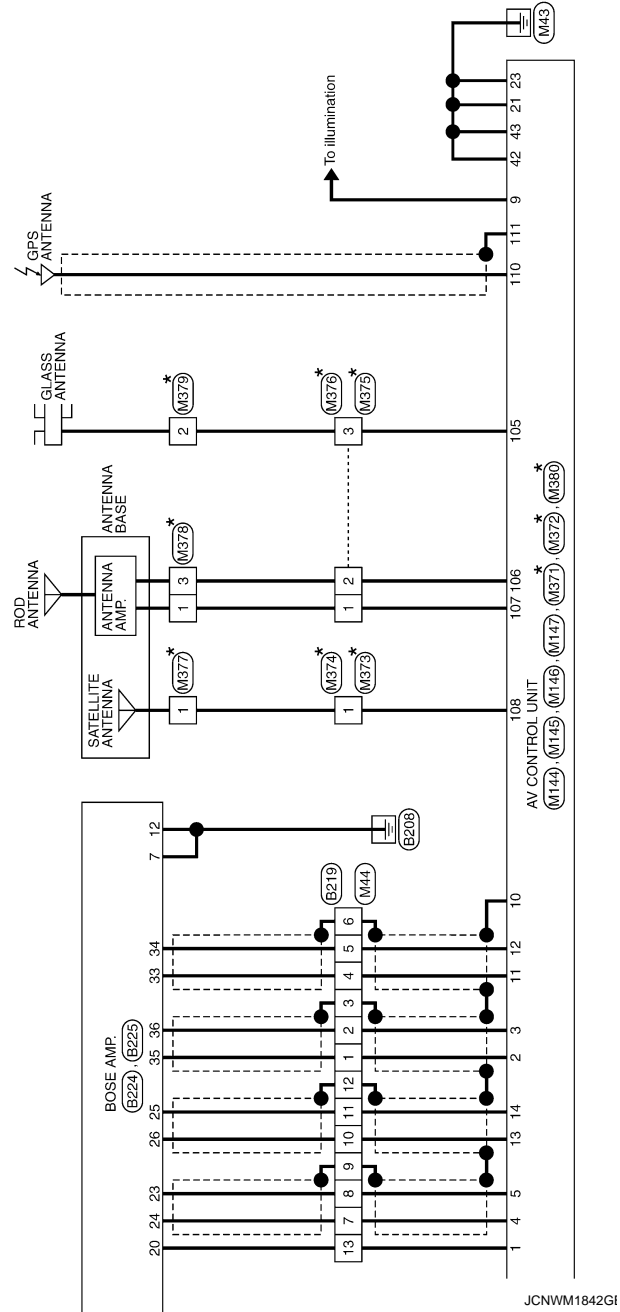

A
B
C
D
E
F
G
H
I
J
K
L
M
N
O
P

AV

BOSE AMP.

< ECU DIAGNOSIS >

[BOSE AUDIO WITH NAVIGATION]

BOSE AUDIO WITH NAVIGATION SYSTEM

Connector No.	B3
Connector Name	WIRE TO WIRE
Connector Type	TK10FW-NSB



Terminal No.	Color of Wire	Signal Name [Specification]
4	LG	-
5	O	-

Connector No.	B4
Connector Name	WIRE TO WIRE
Connector Type	NS18MW-CS



Terminal No.	Color of Wire	Signal Name [Specification]
4	R	-
5	O	-
6	P	-
7	L	-

Connector No.	B5
Connector Name	REAR SPEAKER RH
Connector Type	TK2FBR



Terminal No.	Color of Wire	Signal Name [Specification]
1	V	-
2	LG	-

Connector No.	B9
Connector Name	REAR SPEAKER LH
Connector Type	TK2FBR



Terminal No.	Color of Wire	Signal Name [Specification]
1	SB	-
2	GR	-

Connector No.	B11
Connector Name	WIRE TO WIRE
Connector Type	TH80MW-CS19

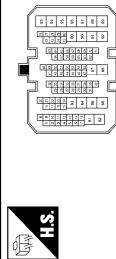

Terminal No.	Color of Wire	Signal Name [Specification]
41	O	-
42	SB	-
43	G	-
44	BR	-
45	L	-
46	GR	-
47	V	-
48	BR	- [With rear view camera without telephone]
49	Y	-
50	SHIELD	-
51	B	-

56	P	-
57	L	-
58	R	-
66	GR	-
67	G	-

Connector No.	B12
Connector Name	WIRE TO WIRE
Connector Type	NS18FW-CS

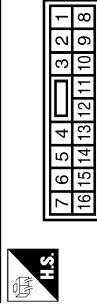

Terminal No.	Color of Wire	Signal Name [Specification]
1	W	-
2	SB	-
3	GR	-
4	V	-
5	LG	-
7	SHIELD	-
12	LG	-
13	O	-
14	W/R	-
15	B/R	-

Connector No.	B28
Connector Name	WOOFER
Connector Type	RS38FGY-PR



Terminal No.	Color of Wire	Signal Name [Specification]
1	W/R	SOUND SIGNAL WOOFER (-)
2	B/R	SOUND SIGNAL WOOFER (+)
4	W	WOOFER AMP. ON SIGNAL
5	B/W	GND
6	O	BAT

BOSE AUDIO WITH NAVIGATION SYSTEM

Connector No.	B60
Connector Name	CAMERA CONTROL UNIT
Connector Type	TH2FW-NH

Terminal No.	2	4	6	8	10	12	14	16	18	20	22	24	26	28	30	32
Color of Wire	SHIELD	B	R/W	R/L	SHIELD	GND	CAMERA IMAGE SIGNAL	CAMERA ON SIGNAL	SHIELD	B	CAMERA IMAGE SIGNAL	CONNECTION RECOGNITION	AV COMM (L)	AV COMM (H)	AV COMM (L)	AV COMM (H)
Signal Name [Specification]																

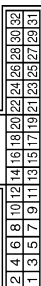

22	R	REVERSE
23	G	SENSOR SIGNAL 1
24	SB	SENSOR SIGNAL 2
25	O	SENSOR SIGNAL 3
26	BR	VEHICLE SPEED (8-PULSE)
30	GR	ACC
31	B	GND
32	V	BATTERY

Connector No.	B77
Connector Name	WIRE TO WIRE
Connector Type	TK2MW

Terminal No.	6	7	8	9
Color of Wire	R/L	R/W	B	SHIELD
Signal Name [Specification]				



Connector No.	B206
Connector Name	WIRE TO WIRE
Connector Type	NS36MP-CS

Terminal No.	1	2	3	4	5	6	7
Color of Wire	W	GR	BR	Y	BR	SHIELD	G
Signal Name [Specification]							

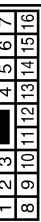

Terminal No.	5	6	7	8	11	12	14	17	18	19	20
Color of Wire	SHIELD	B	R/W	R/L	SHIELD	B	L	BR	Y	GR	G
Signal Name [Specification]											

Terminal No.	6	7	8	9
Color of Wire	R/L	R/W	B	SHIELD
Signal Name [Specification]				

Terminal No.	1	2	3	4	5	12	13	14	15
Color of Wire	W	GR	BR	Y	BR	SHIELD	G	R	W/R
Signal Name [Specification]									

Connector No.	B218
Connector Name	WIRE TO WIRE
Connector Type	TK10FW-NS8

Terminal No.	10	9	8	7	6	5	4	3	2	1
Color of Wire	SHIELD	B	R/W	R/L	SHIELD	B	L	BR	Y	GR
Signal Name [Specification]										



Connector No.	B219
Connector Name	WIRE TO WIRE
Connector Type	TH32MW-NH

Terminal No.	17	18	19	20	21	22	23	24	25	26	27	28	29	30	31	32
Color of Wire	SHIELD	B	R/W	R/L	SHIELD	B	L	BR	Y	GR	G	SHIELD	G	R	W/R	B/R
Signal Name [Specification]																

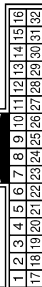

Terminal No.	4	L	O
Color of Wire	L	L	O
Signal Name [Specification]			

Terminal No.	1	2	3	4	5	6	7	8	9	10	11
Color of Wire	W/R	B/R	SHIELD	W/R	B/R	SHIELD	GR/V	W/L	SHIELD	GR/V	W/L
Signal Name [Specification]											

JCNWM1844GI

A
B
C
D
E
F
G
H
I
J
K
L
M
N
O
P

AV

BOSE AUDIO WITH NAVIGATION SYSTEM

Connector No.	B224
Connector Name	BOSE AMP.
Connector Type	SGA12FBR-SJA2

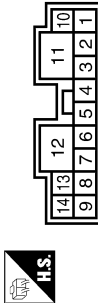

Terminal No.	Color of Wire	Signal Name [Specification]
1	LG	SOUND SIGNAL FRONT SQUAWKER LH (+)
2	V	SOUND SIGNAL FRONT SQUAWKER LH (-)
3	L	SOUND SIGNAL FRONT SQUAWKER RH (+)
4	P	SOUND SIGNAL FRONT SQUAWKER RH (-)
5	Y	SOUND SIGNAL REAR SQUAWKER LH (+)
6	BR	SOUND SIGNAL REAR SQUAWKER RH (+)
7	B	GND
8	BR	SOUND SIGNAL REAR SPEAKER LH (-)
9	O	SOUND SIGNAL REAR DOOR SPEAKER RH (-)
10	SB	BATTERY
11	GR	BATTERY

Connector No.	B226
Connector Name	WIRE TO WIRE
Connector Type	NS12MBR-CS

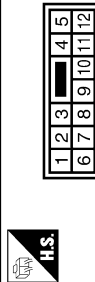

12	B	GND
13	GR	SOUND SIGNAL REAR SPEAKER LH (+)
14	L	SOUND SIGNAL REAR DOOR SPEAKER RH (+)

Connector No.	B225
Connector Name	BOSE AMP.
Connector Type	SCA18FBR-SG44

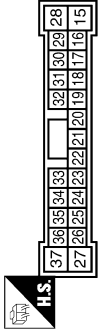

Terminal No.	Color of Wire	Signal Name [Specification]
15	R	SOUND SIGNAL REAR DOOR SPEAKER LH (-)
16	B/R	SOUND SIGNAL WOOFER (+)
17	W/R	SOUND SIGNAL WOOFER (-)
18	W	SOUND SIGNAL FRONT DOOR SPEAKER LH (-)
19	B	SOUND SIGNAL FRONT DOOR SPEAKER LH (-)
20	SB	AMP. ON SIGNAL
21	SHIELD	SHIELD
22	W	WOOFER AMP. ON SIGNAL
23	W/L	SOUND SIGNAL REAR LH (-)
24	GR/V	SOUND SIGNAL REAR LH (-)
25	W/L	SOUND SIGNAL REAR RH (-)

Connector No.	D15
Connector Name	FRONT DOOR SPEAKER LH (WITH BOSE SYSTEM)
Connector Type	NS02FBR-CS



26	GR/V	SOUND SIGNAL REAR RH (+)
28	G	SOUND SIGNAL REAR DOOR SPEAKER LH (+)
29	V	SOUND SIGNAL CENTER SPEAKER (+)
30	P	SOUND SIGNAL CENTER SPEAKER (-)
31	BR	SOUND SIGNAL FRONT DOOR SPEAKER RH (+)
32	Y	SOUND SIGNAL FRONT DOOR SPEAKER RH (-)
33	W/R	SOUND SIGNAL FRONT RH (+)
34	B/R	SOUND SIGNAL FRONT RH (-)
35	W/R	SOUND SIGNAL FRONT LH (+)
36	B/R	SOUND SIGNAL FRONT LH (-)

Connector No.	D21
Connector Name	WIRE TO WIRE
Connector Type	TH40FW-CS15

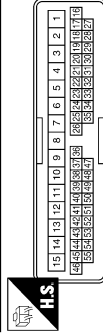

Terminal No.	Color of Wire	Signal Name [Specification]
1	L	-[Type A]
1	W	-[Type B]
2	B/W	-[Type A]
2	B	-[Type B]



Terminal No.	Color of Wire	Signal Name [Specification]
4	B/W	-[Type A]
4	B	-[Type B]
5	L	-[Type A]
5	W	-[Type B]

Terminal No.	Color of Wire	Signal Name [Specification]
1	V	-
2	BR	-
3	W	-
4	V	-
5	SB	-
6	P	-
7	Y	-
8	B	-
9	L	-
10	P	-
11	LG	-

JCNWM1845GI



BOSE AUDIO WITH NAVIGATION SYSTEM

Connector No.	D186
Connector Name	REAR DOOR SPEAKER LH (WITH BOSE SYSTEM)
Connector Type	NS02FBR-CS



Terminal No.	Color of Wire	Signal Name [Specification]
1	L	-
2	W	-

Connector No.	D181
Connector Name	WIRE TO WIRE
Connector Type	TK10MW-NS



Terminal No.	Color of Wire	Signal Name [Specification]
4	L	-
5	W	-

Connector No.	D153
Connector Name	FRONT DOOR SPEAKER RH (WITH BOSE SYSTEM)
Connector Type	NS02FBR-CS



Terminal No.	Color of Wire	Signal Name [Specification]
1	BR	-[Type A]
2	B/R	-[Type A]
2	B	-[Type B]

Connector No.	D141
Connector Name	WIRE TO WIRE
Connector Type	TH40PW-CS1.5



Terminal No.	Color of Wire	Signal Name [Specification]
4	B/R	-[Type A]
4	B	-[Type B]
5	BR	-[Type A]
5	W	-[Type B]

Connector No.	D192
Connector Name	REAR VIEW CAMERA
Connector Type	TH04MW-NH



Terminal No.	Color of Wire	Signal Name [Specification]
1	R	CAMERA ON SIGNAL
2	G	GND
3	B	CAMERA IMAGE SIGNAL
4	SHIELD	SHIELD

Connector No.	D182
Connector Name	WIRE TO WIRE
Connector Type	TK12FW



Terminal No.	Color of Wire	Signal Name [Specification]
6	R	-
7	G	-
8	B	-
9	SHIELD	-

Connector No.	D155
Connector Name	WIRE TO WIRE
Connector Type	TK10MW-NS

Terminal No.	Color of Wire	Signal Name [Specification]
4	O	-[Type A]
4	L	-[Type B]
5	B/P	-[Type A]
5	W	-[Type B]

Connector No.	D106
Connector Name	REAR DOOR SPEAKER RH (WITH BOSE SYSTEM)
Connector Type	NS02FBR-CS

Terminal No.	Color of Wire	Signal Name [Specification]
1	O	-[Type A]
1	L	-[Type B]
2	B/P	-[Type A]
2	W	-[Type B]

JCNWM1846GI

A
B
C
D
E
F
G
H
I
J
K
L
M
AV
O
P

BOSE AUDIO WITH NAVIGATION SYSTEM

Connector No.	E27
Connector Name	PARKING BRAKE SWITCH
Connector Type	P01FB-A



Terminal No.	Color of Wire	Signal Name [Specification]
1	P	-

Connector No.	E18
Connector Name	BACK-UP LAMP RELAY
Connector Type	MS2FL-M2-LC



Terminal No.	Color of Wire	Signal Name [Specification]
1	LG	-
2	R	-
3	LG	-
5	R	-

Connector No.	E16
Connector Name	ECM
Connector Type	RH2FB-RZ8-L-LH

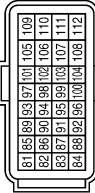

Terminal No.	Color of Wire	Signal Name [Specification]
97	P	VEHGAN-L
98	L	VEHGAN-H

Connector No.	E6
Connector Name	WIRE TO WIRE
Connector Type	TK16MGY-TV



Terminal No.	Color of Wire	Signal Name [Specification]
4	R	-

Connector No.	F23
Connector Name	WIRE TO WIRE
Connector Type	TK16FGY-TV



Terminal No.	Color of Wire	Signal Name [Specification]
4	G/B	-

Connector No.	F23
Connector Name	TCM (TRANSMISSION CONTROL MODULE)
Connector Type	RH40FB-RZ8-L-RH



Terminal No.	Color of Wire	Signal Name [Specification]
19	G/B	REV LAMP RELAY

Connector No.	E105
Connector Name	WIRE TO WIRE
Connector Type	TH70MW-CS10-M3



Terminal No.	Color of Wire	Signal Name [Specification]
5	LG	-
22	P	-
47	P	-
48	L	-
75	BR	-
76	GR	-
78	V	-

Connector No.	E104
Connector Name	WIRE TO WIRE
Connector Type	NS16FW-CS



Terminal No.	Color of Wire	Signal Name [Specification]
4	R	-
5	L	-
6	P	-
7	L	-

JCNWM1847GI

BOSE AUDIO WITH NAVIGATION SYSTEM

Connector No.	M11
Connector Name	WIRE TO WIRE
Connector Type	TH10FW-CS (P-M3)

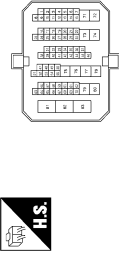

Terminal No.	Color of Wire	Signal Name [Specification]
5	O	-
22	G	-
47	P	-
48	L	-
75	BR	-
78	R	-
78	Y	-

Connector No.	M4
Connector Name	DATA LINK CONNECTOR
Connector Type	BD16FW

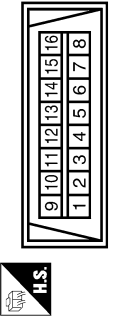

Terminal No.	Color of Wire	Signal Name [Specification]
6	L	-
14	P	-

Connector No.	M3
Connector Name	FUSE BLOCK (J/B)
Connector Type	NS12FW-CS

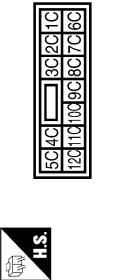

Terminal No.	Color of Wire	Signal Name [Specification]
12C	O	-

Connector No.	M1
Connector Name	FUSE BLOCK (J/B)
Connector Type	NS06FW-M2

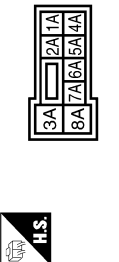

Terminal No.	Color of Wire	Signal Name [Specification]
2A	G	-
5A	R	-

Connector No.	M22
Connector Name	WIRE TO WIRE
Connector Type	TH12FW-NH

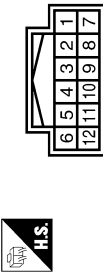

Terminal No.	Color of Wire	Signal Name [Specification]
12	R	-

Connector No.	M20
Connector Name	WIRE TO WIRE
Connector Type	TH40MW-CS15

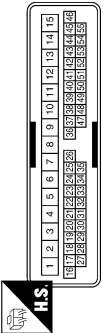

Connector No.	M18
Connector Name	WIRE TO WIRE
Connector Type	TH40MW-CS15

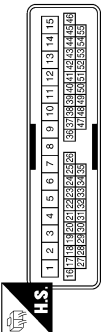

Terminal No.	Color of Wire	Signal Name [Specification]
1	V	-
2	R	-
3	R	-
4	G	-
5	W	-
6	SHIELD	-
7	LG	-
8	SHIELD	-
9	BR	-
10	SHIELD	-
11	L	-

Terminal No.	Color of Wire	Signal Name [Specification]
4	B	-
5	L	-

Terminal No.	Color of Wire	Signal Name [Specification]
4	W	-
5	BR	- [Type A and without BOSE system type B]
5	B	- [With BOSE system type B]

A
B
C
D
E
F
G
H
I
J
K
L
M
AV
O
P

JCNWM1848GI

BOSE AUDIO WITH NAVIGATION SYSTEM

Connector No.	M34
Connector Name	COMBINATION METER
Connector Type	TH40FW-NH

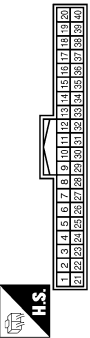

Terminal No.	Color of Wire	Signal Name [Specification]
21	L	CAN-H
22	P	CAN-L
31	V	VEHICLE SPEED (8-PULSE)

Connector No.	M33
Connector Name	COMBINATION SWITCH (SPIRAL CABLE)
Connector Type	TK6BFGY-1V

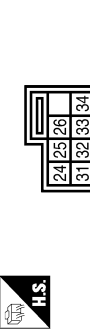

Terminal No.	Color of Wire	Signal Name [Specification]
24	BR	-[With audio steering switch and telephone]
31	G	-[With audio steering switch and telephone]
33	L	-[With audio steering switch and telephone]

Connector No.	M30
Connector Name	STEERING ANGLE SENSOR
Connector Type	TH08FW-NH



Terminal No.	Color of Wire	Signal Name [Specification]
1	B	
3	L	
4	G	
6	SB	
8	O	

Connector No.	M23
Connector Name	WIRE TO WIRE
Connector Type	TH16MW-NH



Terminal No.	Color of Wire	Signal Name [Specification]
1	W	
2	SHIELD	-[With telephone and navigation system]
3	B	

Connector No.	M49
Connector Name	FRONT DISPLAY UNIT
Connector Type	TH24FW-NH



Terminal No.	Color of Wire	Signal Name [Specification]
13	B	GND[With navigation system]
14	SHIELD	SHIELD[With navigation system]
15	Y	AUX IMAGE SIGNAL[With navigation system]
17	G	RGB (RED) SIGNAL
18	W	RGB (BLUE) SIGNAL[With navigation system]
19	B	RGB SYNC
20	R	VP
21	SHIELD	SHIELD
22	G	COMM (DISP->CONT)
23	SHIELD	SHIELD

Connector No.	M48
Connector Name	FRONT DISPLAY UNIT
Connector Type	TH24FW-NH



Terminal No.	Color of Wire	Signal Name [Specification]
1	B	GND
2	Y	BATTERY[With navigation system]
3	R	ACC[With navigation system]
4	SHIELD	SHIELD[With navigation system]
5	B	AUX IMAGE GND[With navigation system]
6	R	RGB (GREEN) SIGNAL[With navigation system]
7	SHIELD	SHIELD
8	B	HPI[With navigation system]
9	W	RGB AREA (YS) SIGNAL
11	R	COMM (CONT->DISP)
12	W	CAMERA IMAGE SIGNAL

Connector No.	M44
Connector Name	WIRE TO WIRE
Connector Type	TH32FW-NH



Terminal No.	Color of Wire	Signal Name [Specification]
10	V	
11	LG	
12	SHIELD	
13	P	

Connector No.	M44
Connector Name	WIRE TO WIRE
Connector Type	TH32FW-NH

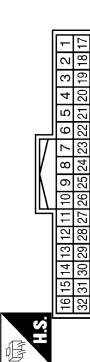

Terminal No.	Color of Wire	Signal Name [Specification]
1	G	
2	R	
3	SHIELD	
4	B	
5	W	
6	SHIELD	
7	O	-[Type A]
8	L	-[Type B]
8	SB	-[Type A]
8	R	-[Type B]
9	SHIELD	

Connector No.	M49
Connector Name	FRONT DISPLAY UNIT
Connector Type	TH24FW-NH

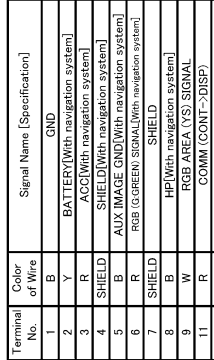

Terminal No.	Color of Wire	Signal Name [Specification]
1	B	GND
2	Y	BATTERY[With navigation system]
3	R	ACC[With navigation system]
4	SHIELD	SHIELD[With navigation system]
5	B	AUX IMAGE GND[With navigation system]
6	R	RGB (GREEN) SIGNAL[With navigation system]
7	SHIELD	SHIELD
8	B	HPI[With navigation system]
9	W	RGB AREA (YS) SIGNAL
11	R	COMM (CONT->DISP)
12	W	CAMERA IMAGE SIGNAL

Connector No.	M44
Connector Name	WIRE TO WIRE
Connector Type	TH32FW-NH

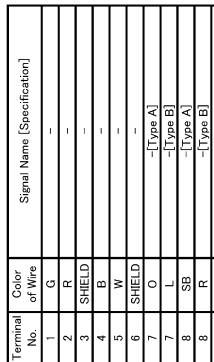

Terminal No.	Color of Wire	Signal Name [Specification]
1	G	
2	R	
3	SHIELD	
4	B	
5	W	
6	SHIELD	
7	O	-[Type A]
8	L	-[Type B]
8	SB	-[Type A]
8	R	-[Type B]
9	SHIELD	

JCNWM1849GI

BOSE AUDIO WITH NAVIGATION SYSTEM

Connector No.	M65
Connector Name	FRONT SQUAWKER LH
Connector Type	TK02FBR



Terminal No.	Color of Wire	Signal Name [Specification]
1	LG	[With BOSE system]
2	Y	[With BOSE system]

Connector No.	M66
Connector Name	CENTER SPEAKER
Connector Type	TK02FBR



Terminal No.	Color of Wire	Signal Name [Specification]
1	P	-
2	O	-

Connector No.	M67
Connector Name	FRONT SQUAWKER RH
Connector Type	TK02FBR



Terminal No.	Color of Wire	Signal Name [Specification]
1	BR	-
2	R	[With BOSE system]

Connector No.	M77
Connector Name	WIRE TO WIRE
Connector Type	TH80FW-CS19

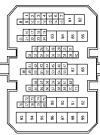

Terminal No.	Color of Wire	Signal Name [Specification]
41	O	-
42	SB	-
43	L	-
44	V	-
45	P	-
46	R	-
47	Y	-
48	L	-
49	G	-
50	SHIELD	-
51	W	-

56	P	-
57	L	-
58	SB	-
66	L	-
67	R	-

Connector No.	M97
Connector Name	WIRE TO WIRE
Connector Type	TH18FW-CS2

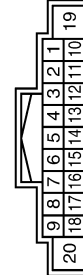

Terminal No.	Color of Wire	Signal Name [Specification]
5	SHIELD	-
6	W	-
8	B	-
9	Y	-
14	R	-
15	B	-
17	SHIELD	-
18	B	[Type A and With navigation system type B]

Connector No.	MT22
Connector Name	BCM (BODY CONTROL MODULE)
Connector Type	TH40FB-NH

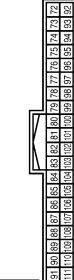

Terminal No.	Color of Wire	Signal Name [Specification]
90	P	CAN-L
91	L	CAN-H

JCNWM1850GI

A
B
C
D
E
F
G
H
I
J
K
L
M
N
O
P

AV

BOSE AMP.

< ECU DIAGNOSIS >

[BOSE AUDIO WITH NAVIGATION]

BOSE AUDIO WITH NAVIGATION SYSTEM

Connector No.	M124
Connector Name	WIRE TO WIRE
Connector Type	TH18FW-CS

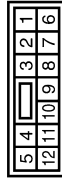

Terminal No.	Color of Wire	Signal Name [Specification]
1	P	-
2	BR	- [Type A]
3	L	- [Type B]
4	Y	-
5	BR	-
6	O	-
7	W	-
8	B	-
9	R	-
10	BR	-

Connector No.	M144
Connector Name	AV CONTROL UNIT (WITH NAVIGATION SYSTEM)
Connector Type	TH18FW-CS2

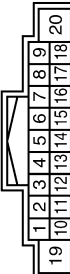

Terminal No.	11	B	SOUND SIGNAL FRONT RH (+)
	12	W	SOUND SIGNAL FRONT RH (-)
	13	V	SOUND SIGNAL REAR RH (+)
	14	LG	SOUND SIGNAL REAR RH (-)
	15	L	STRG SW GND
	16	G	STRG SW B
	19	Y	BATTERY

Connector No.	M125
Connector Name	MULTIFUNCTION SWITCH
Connector Type	TH16FW-NH



Terminal No.	Color of Wire	Signal Name [Specification]
1	B	GND
3	R	ACC
6	R	AV COMM (H)
8	L	AV COMM (L)
9	V	SW GND
14	W	EJECT SIGNAL

Connector No.	M145
Connector Name	AV CONTROL UNIT (WITH NAVIGATION SYSTEM)
Connector Type	TH40FW-NH



Terminal No.	38	V	VEHICLE SPEED (8-PULSE)
	40	P	CONNECTION RECOGNITION CONTROL SIGNAL
	42	B	CONNECTION RECOGNITION CONTROL SIGNAL
	43	B	CONNECTION RECOGNITION CONTROL SIGNAL
	48	G	AV COMM (H)
	49	L	AV COMM (L)
	50	R	AV COMM (H)
	51	L	AV COMM (L)
	52	L	CAN-H
	53	P	CAN-L

Terminal No.	Color of Wire	Signal Name [Specification]
21	B	GND
22	Y	BATTERY
23	B	GND
24	Y	BATTERY
25	R	ACC
26	B	MICROPHONE VCC
27	SHIELD	MICROPHONE GND
28	W	MICROPHONE SIGNAL
35	G	IGNITION
36	G	PARKING BRAKE
37	SB	REVERSE

Terminal No.	Color of Wire	Signal Name [Specification]
1	P	AMP ON SIGNAL
2	G	SOUND SIGNAL FRONT LH (+)
3	R	SOUND SIGNAL FRONT LH (-)
4	O	SOUND SIGNAL REAR LH (+) [Type A]
4	L	SOUND SIGNAL REAR LH (+) [Type B]
5	SB	SOUND SIGNAL REAR LH (-) [Type A]
5	R	SOUND SIGNAL REAR LH (-) [Type B]
6	BR	STRG SW A
7	R	ACC
9	R	ILLUMINATION
10	SHIELD	SHIELD

JCNWM1851G1

BOSE AUDIO WITH NAVIGATION SYSTEM

Connector No.	M146
Connector Name	AV CONTROL UNIT (WITH NAVIGATION SYSTEM)
Connector Type	TH12FW-NH



62	64	66	68	70	72
61	63	65	67	69	71

Terminal No.	Color of Wire	Signal Name [Specification]
61	G	RGB (R/RED) SIGNAL
62	R	RGB (G/GREEN) SIGNAL
63	W	RGB (B/BLUE) SIGNAL
64	SHIELD	SHIELD
65	B	RGB SYNC
66	SHIELD	SHIELD
67	W	RGB AREA (YS) SIGNAL
68	B	HP
69	R	VP
70	R	COMM (CONT->DISP)
71	G	COMM (DISP->CONT)

Connector No.	M148
Connector Name	iPod ADAPTER
Connector Type	TH12FW-NH



1	2	3	4	5	6	7	8	9	10	11	12
13	14	15	16	17	18	19	20	21	22	23	24

Terminal No.	Color of Wire	Signal Name [Specification]
1	BR	iPod SOUND SIGNAL LH (+)
2	R	iPod SOUND SIGNAL RH (+)
3	R	ACC
4	L	AV COMM (L)
5	Y	BATTERY
8	W	CHARGE POWER
9	G	COMM (iPod ADAPTER->iPod)
10	R	COMM (iPod->iPod ADAPTER)
11	R	ACCESSORY IDENTITY
12	V	iPod SOUND SIGNAL RH (+)
13	L	iPod SOUND SIGNAL LH (+)

72	SHIELD	SHIELD
----	--------	--------

Connector No.	M147
Connector Name	AV CONTROL UNIT (WITH NAVIGATION SYSTEM)
Connector Type	TH12FW-NH



73	74	75	76	77	78	79	80	81	82	83	84	85	86	87	88
89	90	91	92	93	94	95	96	97	98	99	100	101	102	103	104

Terminal No.	Color of Wire	Signal Name [Specification]
79	BR	iPod SOUND SIGNAL LH (+)
80	R	iPod SOUND SIGNAL RH (+)
81	SHIELD	SHIELD
85	W	EJECT SIGNAL
86	SHIELD	SHIELD
87	B	AUX SOUND SIGNAL LH (+)
88	W	AUX SOUND SIGNAL GND
95	L	iPod SOUND SIGNAL LH (+)
96	W	iPod SOUND SIGNAL RH (+)
102	V	SW GND
103	R	AUX SOUND SIGNAL RH (+)

Connector No.	M204
Connector Name	WIRE TO WIRE
Connector Type	TH12MW-NH



1	2	3	4	5	6
7	8	9	10	11	12

Terminal No.	Color of Wire	Signal Name [Specification]
1	V	-
2	R	-
3	R	-
4	G	-
5	W	-
6	SHIELD	-
7	LG	-
8	SHIELD	-
9	BR	-
10	SHIELD	-
11	L	-

12	R
----	---

A
B
C
D
E
F
G
H
I
J
K
L
M
N
O
P

AV

BOSE AUDIO WITH NAVIGATION SYSTEM

Connector No.	M375	Connector No.	M376	Connector No.	M377	Connector No.	M378
Connector Name	WIRE TO WIRE	Connector Name	WIRE TO WIRE	Connector Name	ANTENNA BASE (SATELLITE ANTENNA)	Connector Name	ANTENNA BASE (ANTENNA AMP.)
Connector Type	GT13SH-2/1S-HU	Connector Type	GT13SCN-2/1PP-HU	Connector Type	GT16C-1PP-HU	Connector Type	GT13SSN-1/1PP-HU

Terminal No.	1	2	3	Terminal No.	1	2	3
Color of Wire	-	-	-	Color of Wire	-	-	-
Signal Name [Specification]	-	-	-	Signal Name [Specification]	SATELLITE ANTENNA	-	-

Terminal No.	1	2	3	Terminal No.	1	2	3
Color of Wire	-	-	-	Color of Wire	-	-	-
Signal Name [Specification]	-	-	-	Signal Name [Specification]	-	-	-

Terminal No.	1	2	3	Terminal No.	1	2	3
Color of Wire	-	-	-	Color of Wire	-	-	-
Signal Name [Specification]	-	-	-	Signal Name [Specification]	-	-	-

Connector No.	M379	Connector No.	M380	Connector No.	R1	Connector No.	R20
Connector Name	GLASS ANTENNA	Connector Name	AV CONTROL UNIT (WITH NAVIGATION SYSTEM)	Connector Name	WIRE TO WIRE	Connector Name	MICROPHONE
Connector Type	GT13SCN-1/1PP-HU	Connector Type	GT5-1S-HU	Connector Type	TH16FW-NH	Connector Type	TK04FW

Terminal No.	1	2	Terminal No.	1	2	3	4
Color of Wire	-	-	Color of Wire	-	-	-	-
Signal Name [Specification]	FM SUB	-	Signal Name [Specification]	GPS ANTENNA SHIELD	-	-	MICROPHONE SIGNAL (+)

Terminal No.	1	2	3	Terminal No.	1	2	3
Color of Wire	-	-	-	Color of Wire	-	-	-
Signal Name [Specification]	-	-	-	Signal Name [Specification]	-	-	-

Terminal No.	1	2	3	Terminal No.	1	2	3
Color of Wire	-	-	-	Color of Wire	-	-	-
Signal Name [Specification]	-	-	-	Signal Name [Specification]	-	-	-

JCNWM1854GI

A
B
C
D
E
F
G
H
I
J
K
L
M
N
O
P

AV

IPOD ADAPTER

< ECU DIAGNOSIS >

[BOSE AUDIO WITH NAVIGATION]

IPOD ADAPTER

Reference Values

INFOID:000000003457769

TERMINAL LAYOUT

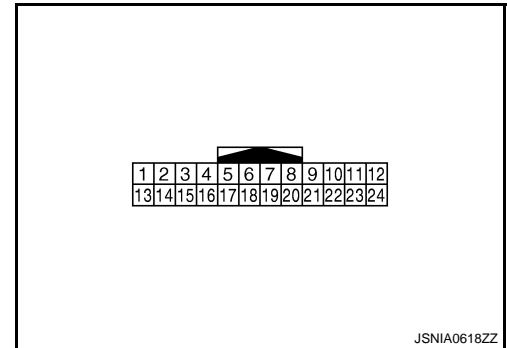

PHYSICAL VALUES

Terminal (Wire color)		Description		Condition		Reference value (Approx.)
+	-	Signal name	Input/ Output			
1 (BR)	13 (L)	iPod sound signal LH	Output	Ignition switch ON	When iPod mode is select- ed.	<p style="text-align: right;">SKIB3609E</p>
2 (R)	14 (W)	iPod sound signal RH	Output	Ignition switch ON	When iPod mode is select- ed.	<p style="text-align: right;">SKIB3609E</p>
3 (R)	Ground	ACC power supply	Input	Ignition switch ACC	—	Battery voltage
4 (L)	—	AV communication signal (L)	Input/ Output	—	—	—
5 (Y)	Ground	Battery power supply	Input	Ignition switch OFF	—	Battery voltage
8 (W)	Ground	iPod battery charge	Output	Ignition switch ON	Connected to iPod®.	12.0 V

IPOD ADAPTER

< ECU DIAGNOSIS >

[BOSE AUDIO WITH NAVIGATION]

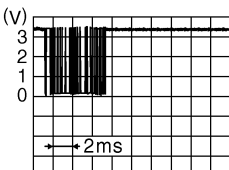
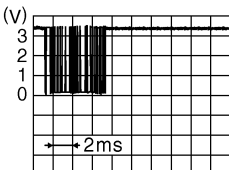
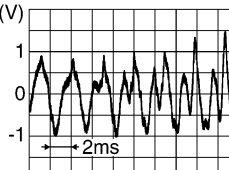
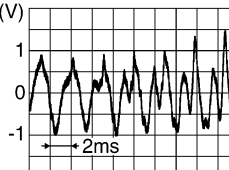
Terminal (Wire color)		Description		Condition		Reference value (Approx.)
+	-	Signal name	Input/ Output			
9 (G)	Ground	Communication signal (iPod adapter→iPod®)	Output	Ignition switch ON	The wave pattern is displayed just after iPod connection.	 <p style="text-align: right; font-size: small;">JPNIA0462GB</p> <p>NOTE: After the wave pattern display, the value continues Approx 3.3 V</p>
10 (R)	Ground	Communication signal (iPod®→iPod adapter)	Input	Ignition switch ON	Connected to iPod®.	 <p style="text-align: right; font-size: small;">JPNIA0462GB</p>
11 (R)	Ground	ACCESSORY-IDENTIFY	—	Ignition switch ON	Connected to iPod®.	0 V
12 (V)	23 (R)	iPod sound signal RH	Input	Ignition switch ON	When iPod mode is selected.	 <p style="text-align: right; font-size: small;">SKIB3609E</p>
15	—	Shield	—	—	—	—
16 (R)	—	AV communication signal (H)	Input/ Output	—	—	—
17	Ground	Ground	—	Ignition switch ON	—	0 V
19	—	Shield	—	—	—	—
21 (L)	Ground	iPod connection recognition signal	Input	Ignition switch ON	Not connected to iPod®.	4.0 V
					Connected to iPod®.	0 V
22 (BR)	Ground	ACCESSORY-DETECT	—	Ignition switch ON	Connected to iPod®.	0 V
24 (LG)	23 (R)	iPod sound signal LH	Input	Ignition switch ON	When iPod mode is selected.	 <p style="text-align: right; font-size: small;">SKIB3609E</p>

A
B
C
D
E
F
G
H
I
J
K
L
M
O
P

AV

IPOD ADAPTER

< ECU DIAGNOSIS >

[BOSE AUDIO WITH NAVIGATION]

Wiring Diagram - BOSE AUDIO WITH NAVIGATION SYSTEM -

INFOID:000000003702904

NOTE:

In this section, PRESET SWITCH and MULTIFUNCTION SWITCH are written as the MULTIFUNCTION SWITCH.

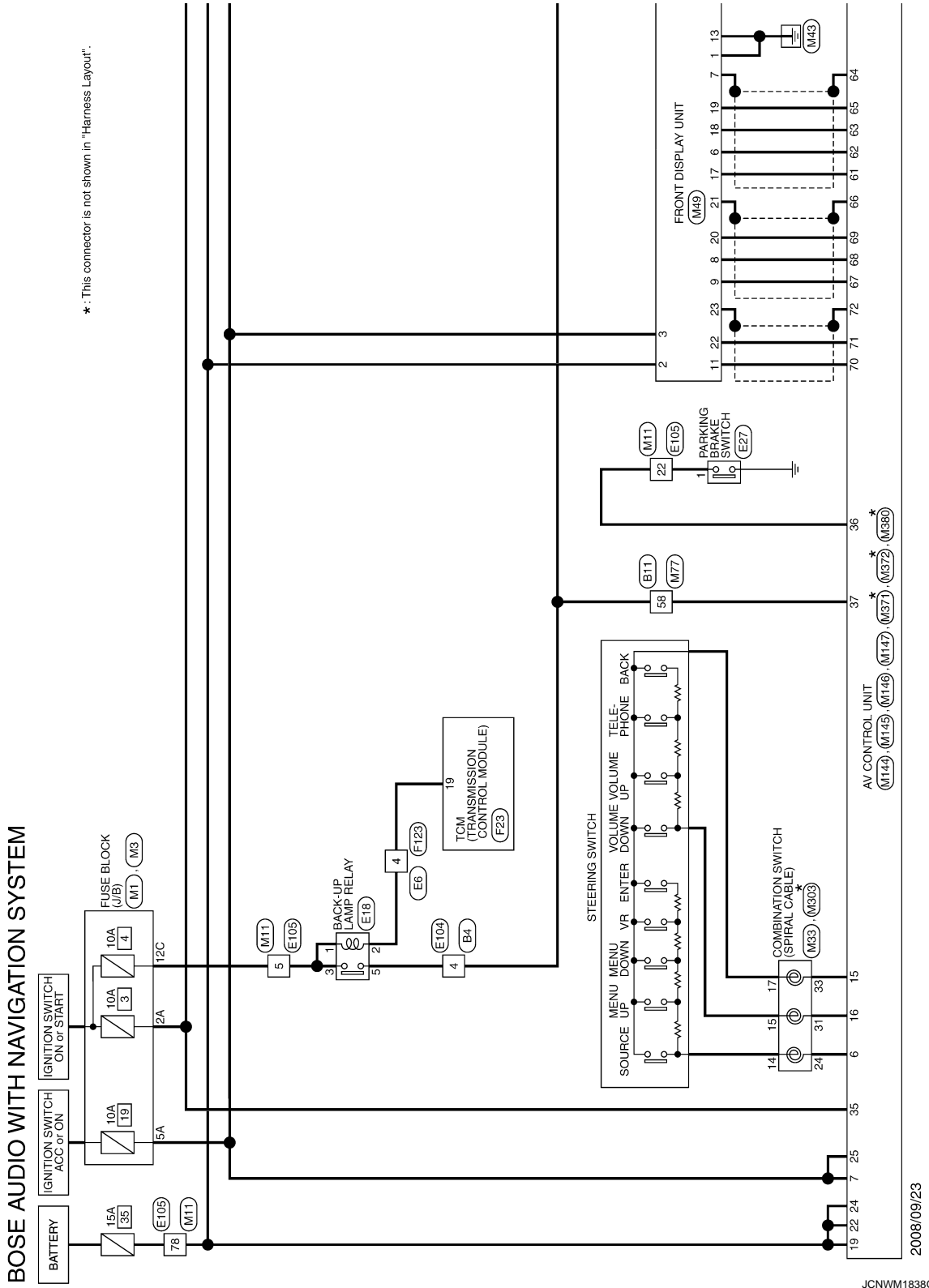

IPOD ADAPTER

< ECU DIAGNOSIS >

[BOSE AUDIO WITH NAVIGATION]

◀ WI ▶ : With iPod

* : This connector is not shown in "Harness Layout".

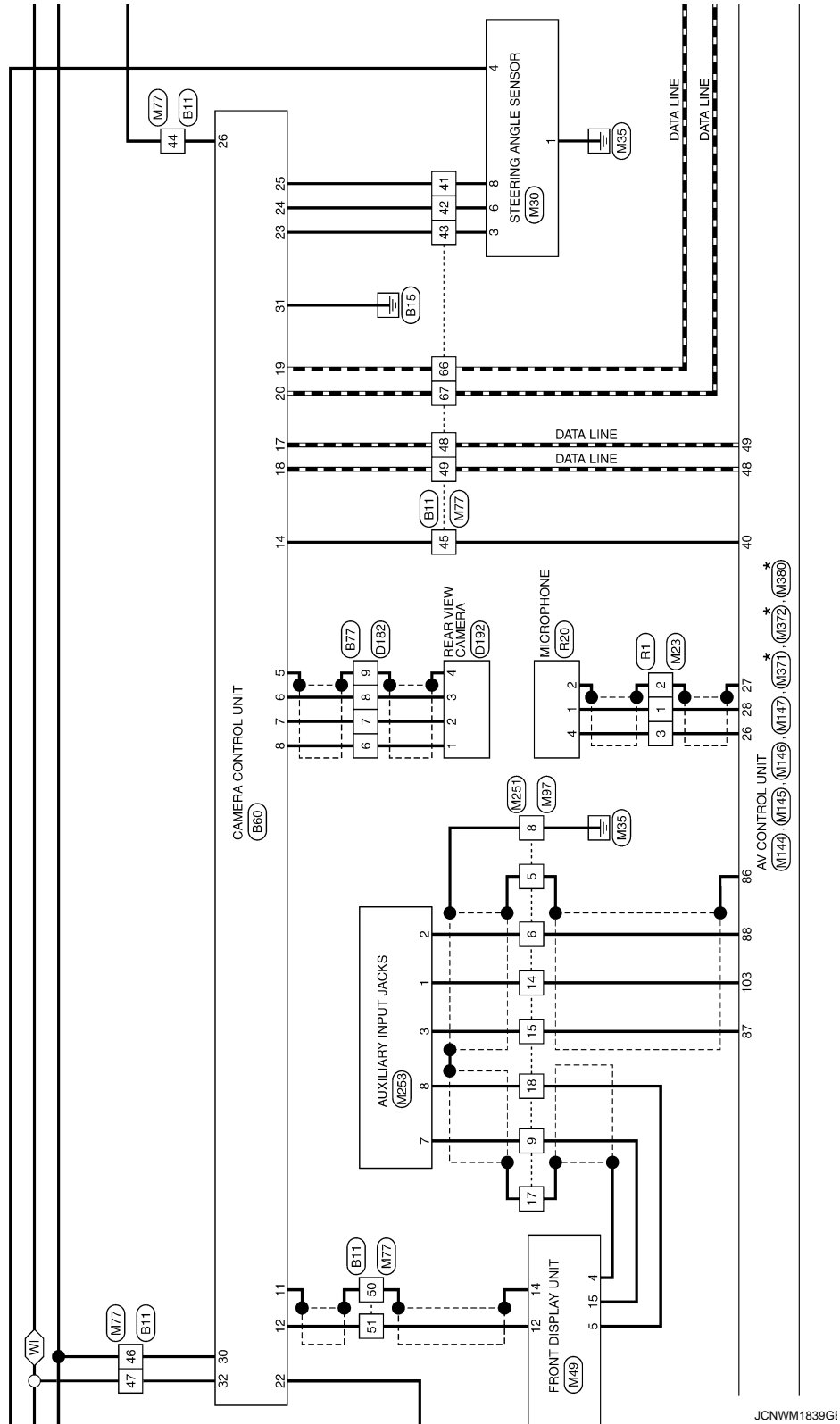

JCNWM1839GI

A
B
C
D
E
F
G
H
I
J
K
L
M
N
O
P

AV

IPOD ADAPTER

[BOSE AUDIO WITH NAVIGATION]

< ECU DIAGNOSIS >

WI: With iPod
AB: With automatic back door
OA: Without automatic back door

*: This connector is not shown in "Harness Layout".

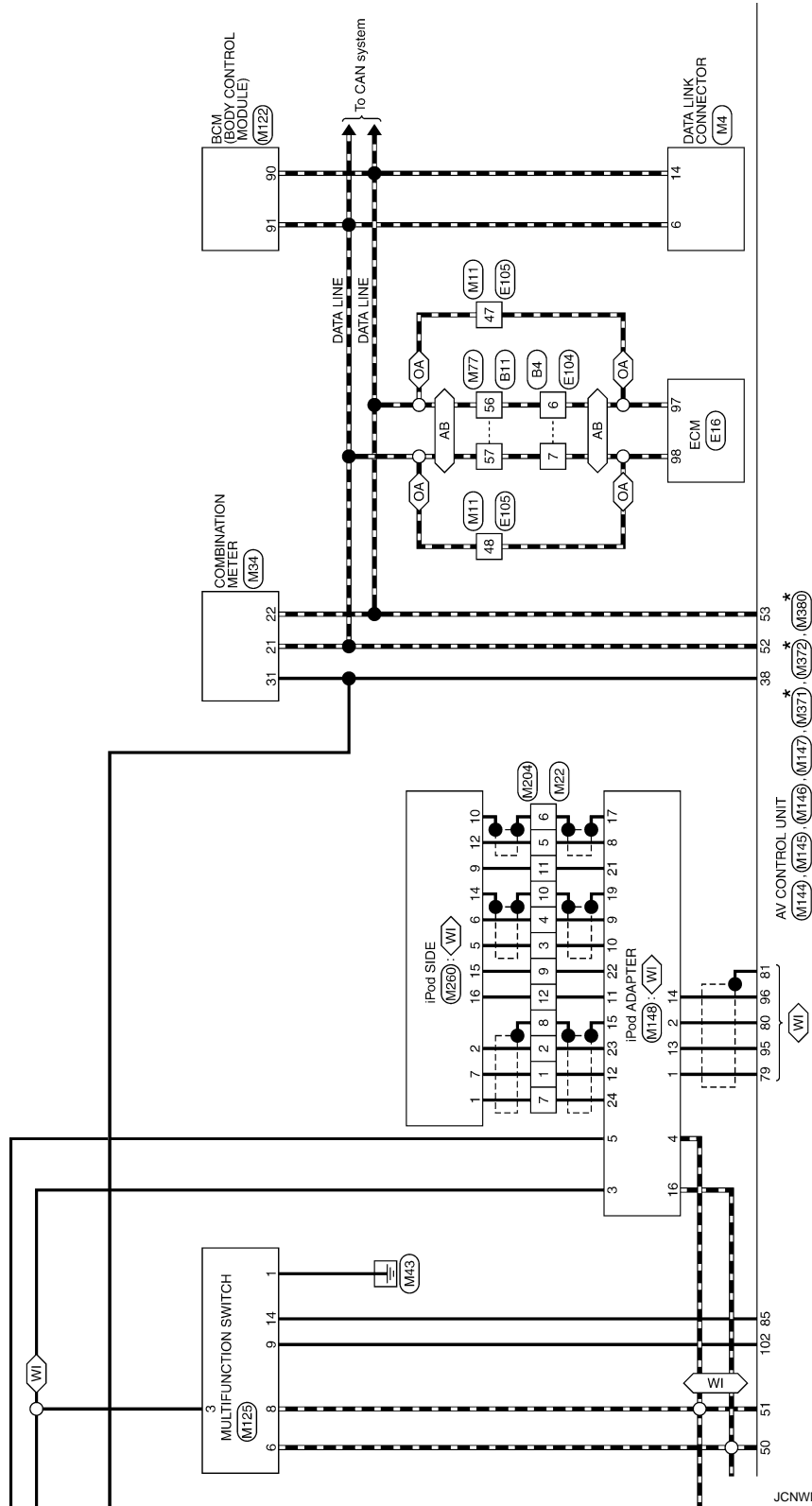

JCNWM1840GI

IPOD ADAPTER

< ECU DIAGNOSIS >

[BOSE AUDIO WITH NAVIGATION]

*: This connector is not shown in "Harness Layout".

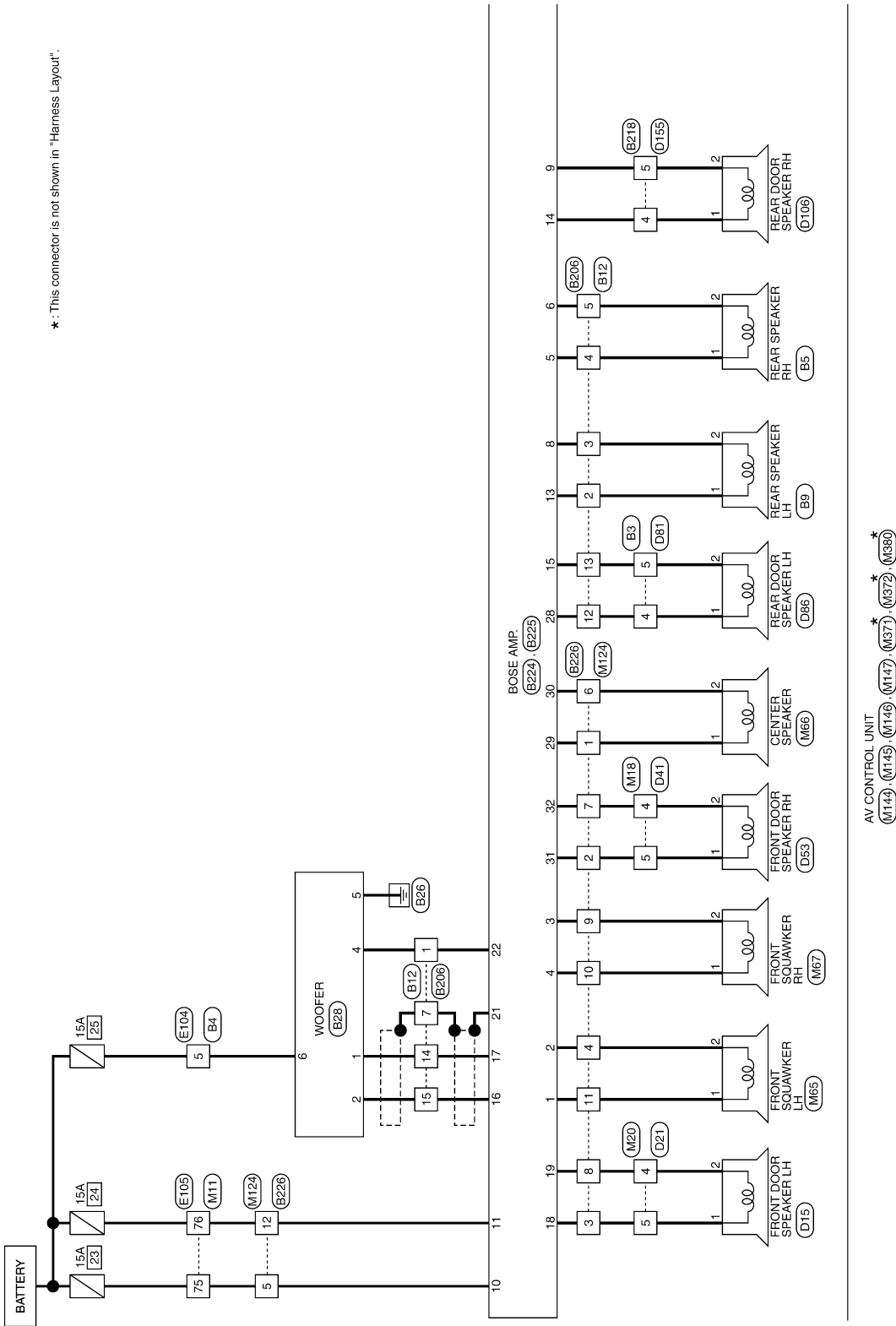

JCNWM1841G1

A
B
C
D
E
F
G
H
I
J
K
L
M
N
O
P

AV

IPOD ADAPTER

< ECU DIAGNOSIS >

[BOSE AUDIO WITH NAVIGATION]

BOSE AUDIO WITH NAVIGATION SYSTEM

Connector No.	Connector Name	Connector Type	Terminal No.	Color of Wire	Signal Name [Specification]
B3	WIRE TO WIRE	TK0FW-ANS	4	LG	
B3	WIRE TO WIRE	TK0FW-ANS	5	O	
B4	WIRE TO WIRE	NS16MW-CS	4	R	
B4	WIRE TO WIRE	NS16MW-CS	5	O	
B4	WIRE TO WIRE	NS16MW-CS	6	P	
B4	WIRE TO WIRE	NS16MW-CS	7	L	
B5	REAR SPEAKER RH	TK0ZFBR	1	V	
B5	REAR SPEAKER RH	TK0ZFBR	2	LG	
B8	REAR SPEAKER LH	TK0ZFBR	1	SB	
B8	REAR SPEAKER LH	TK0ZFBR	2	GR	
B11	WIRE TO WIRE	TH80MW-CS19	56	P	
B11	WIRE TO WIRE	TH80MW-CS19	57	L	
B11	WIRE TO WIRE	TH80MW-CS19	58	R	
B11	WIRE TO WIRE	TH80MW-CS19	66	GR	
B11	WIRE TO WIRE	TH80MW-CS19	67	G	
B12	WIRE TO WIRE	NS18FW-CS	7	W	
B12	WIRE TO WIRE	NS18FW-CS	8	SB	
B12	WIRE TO WIRE	NS18FW-CS	9	GR	
B12	WIRE TO WIRE	NS18FW-CS	10	V	
B12	WIRE TO WIRE	NS18FW-CS	11	LG	
B12	WIRE TO WIRE	NS18FW-CS	12	LG	
B12	WIRE TO WIRE	NS18FW-CS	13	O	
B12	WIRE TO WIRE	NS18FW-CS	14	W/R	
B12	WIRE TO WIRE	NS18FW-CS	15	B/R	
B28	WOOFER	RS08FGY-PR	1	W/R	SOUND SIGNAL WOOFER (-)
B28	WOOFER	RS08FGY-PR	2	B/R	SOUND SIGNAL WOOFER (+)
B28	WOOFER	RS08FGY-PR	4	W	WOOFER AMP. ON SIGNAL
B28	WOOFER	RS08FGY-PR	5	B/W	GND
B28	WOOFER	RS08FGY-PR	6	O	BAT

JCNWM1843GI

A
B
C
D
E
F
G
H
I
J
K
L
M
AV
O
P

IPOD ADAPTER

< ECU DIAGNOSIS >

[BOSE AUDIO WITH NAVIGATION]

BOSE AUDIO WITH NAVIGATION SYSTEM

Connector No.	B80
Connector Name	CAMERA CONTROL UNIT
Connector Type	TH22FW-NH

Terminal No.	Color of Wire	Signal Name [Specification]
2	SHIELD	SHIELD
4	B	CAMERA IMAGE SIGNAL
6	R/W	GND
8	R/L	CAMERA ON SIGNAL
11	SHIELD	SHIELD
12	B	CAMERA IMAGE SIGNAL
14	L	CONNECTION RECOGNITION
17	BR	AV COMM (L)
18	Y	AV COMM (H)
19	GR	AV COMM (L)
20	G	AV COMM (H)

Terminal No.	Color of Wire	Signal Name [Specification]
5	SHIELD	SHIELD
6	B	CAMERA IMAGE SIGNAL
7	R/W	GND
8	R/L	CAMERA ON SIGNAL
11	SHIELD	SHIELD
12	B	CAMERA IMAGE SIGNAL
14	L	CONNECTION RECOGNITION
17	BR	AV COMM (L)
18	Y	AV COMM (H)
19	GR	AV COMM (L)
20	G	AV COMM (H)

Connector No.	B218
Connector Name	WIRE TO WIRE
Connector Type	TK10FW-NS8

Terminal No.	Color of Wire	Signal Name [Specification]
10	SHIELD	SHIELD
9	B	CAMERA IMAGE SIGNAL
8	R/W	GND
7	R/L	CAMERA ON SIGNAL
6	SHIELD	SHIELD
5	B	CAMERA IMAGE SIGNAL
4	L	CONNECTION RECOGNITION
3	Y	AV COMM (H)
2	GR	AV COMM (L)
1	G	AV COMM (H)

Terminal No.	Color of Wire	Signal Name [Specification]
4	L	-[With BOSE system]
5	O	-[With BOSE system]

22	R	REVERSE
23	G	SENSOR SIGNAL 1
24	SR	SENSOR SIGNAL 2
25	O	SENSOR SIGNAL 3
28	BR	VEHICLE SPEED (3-PULSE)
30	GR	ACC
31	B	GND
32	V	BATTERY

Terminal No.	Color of Wire	Signal Name [Specification]
6	R/L	-
7	R/W	-
8	B	-
9	SHIELD	-

Terminal No.	Color of Wire	Signal Name [Specification]
12	SHIELD	-
13	SB	-

Connector No.	B77
Connector Name	WIRE TO WIRE
Connector Type	TK12MW

Terminal No.	Color of Wire	Signal Name [Specification]
1	W	-
2	GR	-
3	BR	-
4	Y	-
5	BR	-
7	SHIELD	-
12	G	-
13	R	-
14	W/R	-
15	B/R	-

Connector No.	B206
Connector Name	WIRE TO WIRE
Connector Type	NS16MM-CS

Terminal No.	Color of Wire	Signal Name [Specification]
1	W	-
2	GR	-
3	BR	-
4	Y	-
5	BR	-
7	SHIELD	-
12	G	-
13	R	-
14	W/R	-
15	B/R	-

JCNWM1844GI

IPOD ADAPTER

< ECU DIAGNOSIS >

[BOSE AUDIO WITH NAVIGATION]

BOSE AUDIO WITH NAVIGATION SYSTEM

Connector No.	B224
Connector Name	BOSE AMP.
Connector Type	SSA1PFR-SJ42

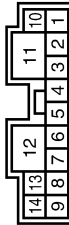

Terminal No.	Color of Wire	Signal Name [Specification]
1	LG	SOUND SIGNAL FRONT SQUAWKER LH (+)
2	V	SOUND SIGNAL FRONT SQUAWKER LH (-)
3	L	SOUND SIGNAL FRONT SQUAWKER RH (-)
4	P	SOUND SIGNAL FRONT SQUAWKER RH (+)
5	Y	SOUND SIGNAL REAR SPEAKER RH (+)
6	BR	SOUND SIGNAL REAR SPEAKER RH (-)
7	B	GND
8	BR	SOUND SIGNAL REAR SPEAKER LH (-)
9	O	SOUND SIGNAL REAR DOOR SPEAKER RH (-)
10	SB	BATTERY
11	GR	BATTERY

Connector No.	B226
Connector Name	WIRE TO WIRE
Connector Type	NS12MBR-CS



Terminal No.	Color of Wire	Signal Name [Specification]
1	V	-
2	BR	-
3	W	-
4	V	-
5	SB	-
6	P	-
7	Y	-
8	B	-
9	L	-
10	P	-
11	LG	-

12	B	GND
13	GR	SOUND SIGNAL REAR SPEAKER LH (+)
14	L	SOUND SIGNAL REAR DOOR SPEAKER RH (+)

Connector No.	B225
Connector Name	BOSE AMP.
Connector Type	SCA1PFR-SG44



Terminal No.	Color of Wire	Signal Name [Specification]
15	R	SOUND SIGNAL REAR DOOR SPEAKER LH (-)
16	B/R	SOUND SIGNAL WOOFER (+)
17	W/R	SOUND SIGNAL WOOFER (-)
18	W	SOUND SIGNAL FRONT DOOR SPEAKER LH (+)
19	B	SOUND SIGNAL FRONT DOOR SPEAKER LH (-)
20	SB	AMP. ON SIGNAL
21	SHIELD	SHIELD
22	W	WOOFER AMP. ON SIGNAL
23	W/L	SOUND SIGNAL REAR LH (-)
24	GR/V	SOUND SIGNAL REAR LH (+)
25	W/L	SOUND SIGNAL REAR RH (-)

Connector No.	B15
Connector Name	FRONT DOOR SPEAKER LH (WITH BOSE SYSTEM)
Connector Type	NS02FBR-CS



Terminal No.	Color of Wire	Signal Name [Specification]
1	L	- [Type A]
1	W	- [Type B]
2	B/W	- [Type A]
2	B	- [Type B]

26	GR/V	SOUND SIGNAL REAR RH (+)
28	G	SOUND SIGNAL REAR DOOR SPEAKER LH (+)
29	V	SOUND SIGNAL CENTER SPEAKER (+)
30	P	SOUND SIGNAL CENTER SPEAKER (-)
31	BR	SOUND SIGNAL FRONT DOOR SPEAKER RH (+)
32	Y	SOUND SIGNAL FRONT DOOR SPEAKER RH (-)
33	W/R	SOUND SIGNAL FRONT RH (+)
34	B/R	SOUND SIGNAL FRONT RH (-)
35	W/R	SOUND SIGNAL FRONT LH (+)
36	B/R	SOUND SIGNAL FRONT LH (-)

Connector No.	D21
Connector Name	WIRE TO WIRE
Connector Type	TH4DFW-CS15



Terminal No.	Color of Wire	Signal Name [Specification]
4	B/W	- [Type A]
4	B	- [Type B]
5	L	- [Type A]
5	W	- [Type B]

JCNWM1845GI

A
B
C
D
E
F
G
H
I
J
K
L
M
N
O
P











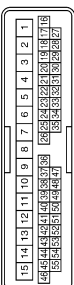

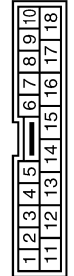

AV

IPOD ADAPTER

< ECU DIAGNOSIS >

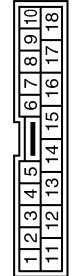
[BOSE AUDIO WITH NAVIGATION]

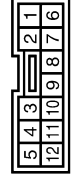
BOSE AUDIO WITH NAVIGATION SYSTEM

<table border="1"> <tr><td>Connector No.</td><td>D41</td></tr> <tr><td>Connector Name</td><td>WIRE TO WIRE</td></tr> <tr><td>Connector Type</td><td>THQDMV-CS15</td></tr> </table>   <table border="1"> <tr><td>Terminal No.</td><td>Color of Wire</td><td>Signal Name [Specification]</td></tr> <tr><td>4</td><td>B/R</td><td>-[Type A]</td></tr> <tr><td>4</td><td>B</td><td>-[Type B]</td></tr> <tr><td>5</td><td>BR</td><td>-[Type A]</td></tr> <tr><td>5</td><td>W</td><td>-[Type B]</td></tr> </table>	Connector No.	D41	Connector Name	WIRE TO WIRE	Connector Type	THQDMV-CS15	Terminal No.	Color of Wire	Signal Name [Specification]	4	B/R	-[Type A]	4	B	-[Type B]	5	BR	-[Type A]	5	W	-[Type B]	<table border="1"> <tr><td>Connector No.</td><td>D63</td></tr> <tr><td>Connector Name</td><td>FRONT DOOR SPEAKER RH (WITH BOSE SYSTEM)</td></tr> <tr><td>Connector Type</td><td>NS02FBR-CS</td></tr> </table>   <table border="1"> <tr><td>Terminal No.</td><td>Color of Wire</td><td>Signal Name [Specification]</td></tr> <tr><td>1</td><td>BR</td><td>-[Type A]</td></tr> <tr><td>2</td><td>B/R</td><td>-[Type A]</td></tr> <tr><td>2</td><td>B</td><td>-[Type B]</td></tr> </table>	Connector No.	D63	Connector Name	FRONT DOOR SPEAKER RH (WITH BOSE SYSTEM)	Connector Type	NS02FBR-CS	Terminal No.	Color of Wire	Signal Name [Specification]	1	BR	-[Type A]	2	B/R	-[Type A]	2	B	-[Type B]	<table border="1"> <tr><td>Connector No.</td><td>D81</td></tr> <tr><td>Connector Name</td><td>WIRE TO WIRE</td></tr> <tr><td>Connector Type</td><td>TK10MW-NS8</td></tr> </table>   <table border="1"> <tr><td>Terminal No.</td><td>Color of Wire</td><td>Signal Name [Specification]</td></tr> <tr><td>4</td><td>L</td><td>-</td></tr> <tr><td>5</td><td>W</td><td>-</td></tr> </table>	Connector No.	D81	Connector Name	WIRE TO WIRE	Connector Type	TK10MW-NS8	Terminal No.	Color of Wire	Signal Name [Specification]	4	L	-	5	W	-	<table border="1"> <tr><td>Connector No.</td><td>D86</td></tr> <tr><td>Connector Name</td><td>REAR DOOR SPEAKER LH (WITH BOSE SYSTEM)</td></tr> <tr><td>Connector Type</td><td>NS02FBR-CS</td></tr> </table>   <table border="1"> <tr><td>Terminal No.</td><td>Color of Wire</td><td>Signal Name [Specification]</td></tr> <tr><td>1</td><td>L</td><td>-</td></tr> <tr><td>2</td><td>W</td><td>-</td></tr> </table>	Connector No.	D86	Connector Name	REAR DOOR SPEAKER LH (WITH BOSE SYSTEM)	Connector Type	NS02FBR-CS	Terminal No.	Color of Wire	Signal Name [Specification]	1	L	-	2	W	-															
Connector No.	D41																																																																																						
Connector Name	WIRE TO WIRE																																																																																						
Connector Type	THQDMV-CS15																																																																																						
Terminal No.	Color of Wire	Signal Name [Specification]																																																																																					
4	B/R	-[Type A]																																																																																					
4	B	-[Type B]																																																																																					
5	BR	-[Type A]																																																																																					
5	W	-[Type B]																																																																																					
Connector No.	D63																																																																																						
Connector Name	FRONT DOOR SPEAKER RH (WITH BOSE SYSTEM)																																																																																						
Connector Type	NS02FBR-CS																																																																																						
Terminal No.	Color of Wire	Signal Name [Specification]																																																																																					
1	BR	-[Type A]																																																																																					
2	B/R	-[Type A]																																																																																					
2	B	-[Type B]																																																																																					
Connector No.	D81																																																																																						
Connector Name	WIRE TO WIRE																																																																																						
Connector Type	TK10MW-NS8																																																																																						
Terminal No.	Color of Wire	Signal Name [Specification]																																																																																					
4	L	-																																																																																					
5	W	-																																																																																					
Connector No.	D86																																																																																						
Connector Name	REAR DOOR SPEAKER LH (WITH BOSE SYSTEM)																																																																																						
Connector Type	NS02FBR-CS																																																																																						
Terminal No.	Color of Wire	Signal Name [Specification]																																																																																					
1	L	-																																																																																					
2	W	-																																																																																					
<table border="1"> <tr><td>Connector No.</td><td>D106</td></tr> <tr><td>Connector Name</td><td>REAR DOOR SPEAKER RH (WITH BOSE SYSTEM)</td></tr> <tr><td>Connector Type</td><td>NS02FBR-CS</td></tr> </table>   <table border="1"> <tr><td>Terminal No.</td><td>Color of Wire</td><td>Signal Name [Specification]</td></tr> <tr><td>1</td><td>O</td><td>-[Type A]</td></tr> <tr><td>1</td><td>L</td><td>-[Type B]</td></tr> <tr><td>2</td><td>B/P</td><td>-[Type A]</td></tr> <tr><td>2</td><td>W</td><td>-[Type B]</td></tr> </table>	Connector No.	D106	Connector Name	REAR DOOR SPEAKER RH (WITH BOSE SYSTEM)	Connector Type	NS02FBR-CS	Terminal No.	Color of Wire	Signal Name [Specification]	1	O	-[Type A]	1	L	-[Type B]	2	B/P	-[Type A]	2	W	-[Type B]	<table border="1"> <tr><td>Connector No.</td><td>D155</td></tr> <tr><td>Connector Name</td><td>WIRE TO WIRE</td></tr> <tr><td>Connector Type</td><td>TK10MW-NS8</td></tr> </table>   <table border="1"> <tr><td>Terminal No.</td><td>Color of Wire</td><td>Signal Name [Specification]</td></tr> <tr><td>4</td><td>O</td><td>-[Type A]</td></tr> <tr><td>4</td><td>L</td><td>-[Type B]</td></tr> <tr><td>5</td><td>B/P</td><td>-[Type A]</td></tr> <tr><td>5</td><td>W</td><td>-[Type B]</td></tr> </table>	Connector No.	D155	Connector Name	WIRE TO WIRE	Connector Type	TK10MW-NS8	Terminal No.	Color of Wire	Signal Name [Specification]	4	O	-[Type A]	4	L	-[Type B]	5	B/P	-[Type A]	5	W	-[Type B]	<table border="1"> <tr><td>Connector No.</td><td>D182</td></tr> <tr><td>Connector Name</td><td>WIRE TO WIRE</td></tr> <tr><td>Connector Type</td><td>TK12FW</td></tr> </table>   <table border="1"> <tr><td>Terminal No.</td><td>Color of Wire</td><td>Signal Name [Specification]</td></tr> <tr><td>6</td><td>R</td><td>-</td></tr> <tr><td>7</td><td>G</td><td>-</td></tr> <tr><td>8</td><td>B</td><td>-</td></tr> <tr><td>9</td><td>SHIELD</td><td>-</td></tr> </table>	Connector No.	D182	Connector Name	WIRE TO WIRE	Connector Type	TK12FW	Terminal No.	Color of Wire	Signal Name [Specification]	6	R	-	7	G	-	8	B	-	9	SHIELD	-	<table border="1"> <tr><td>Connector No.</td><td>D192</td></tr> <tr><td>Connector Name</td><td>REAR VIEW CAMERA</td></tr> <tr><td>Connector Type</td><td>THQDMV-NH</td></tr> </table>   <table border="1"> <tr><td>Terminal No.</td><td>Color of Wire</td><td>Signal Name [Specification]</td></tr> <tr><td>1</td><td>R</td><td>CAMERA ON SIGNAL</td></tr> <tr><td>2</td><td>G</td><td>GND</td></tr> <tr><td>3</td><td>B</td><td>CAMERA IMAGE SIGNAL</td></tr> <tr><td>4</td><td>SHIELD</td><td>SHIELD</td></tr> </table>	Connector No.	D192	Connector Name	REAR VIEW CAMERA	Connector Type	THQDMV-NH	Terminal No.	Color of Wire	Signal Name [Specification]	1	R	CAMERA ON SIGNAL	2	G	GND	3	B	CAMERA IMAGE SIGNAL	4	SHIELD	SHIELD
Connector No.	D106																																																																																						
Connector Name	REAR DOOR SPEAKER RH (WITH BOSE SYSTEM)																																																																																						
Connector Type	NS02FBR-CS																																																																																						
Terminal No.	Color of Wire	Signal Name [Specification]																																																																																					
1	O	-[Type A]																																																																																					
1	L	-[Type B]																																																																																					
2	B/P	-[Type A]																																																																																					
2	W	-[Type B]																																																																																					
Connector No.	D155																																																																																						
Connector Name	WIRE TO WIRE																																																																																						
Connector Type	TK10MW-NS8																																																																																						
Terminal No.	Color of Wire	Signal Name [Specification]																																																																																					
4	O	-[Type A]																																																																																					
4	L	-[Type B]																																																																																					
5	B/P	-[Type A]																																																																																					
5	W	-[Type B]																																																																																					
Connector No.	D182																																																																																						
Connector Name	WIRE TO WIRE																																																																																						
Connector Type	TK12FW																																																																																						
Terminal No.	Color of Wire	Signal Name [Specification]																																																																																					
6	R	-																																																																																					
7	G	-																																																																																					
8	B	-																																																																																					
9	SHIELD	-																																																																																					
Connector No.	D192																																																																																						
Connector Name	REAR VIEW CAMERA																																																																																						
Connector Type	THQDMV-NH																																																																																						
Terminal No.	Color of Wire	Signal Name [Specification]																																																																																					
1	R	CAMERA ON SIGNAL																																																																																					
2	G	GND																																																																																					
3	B	CAMERA IMAGE SIGNAL																																																																																					
4	SHIELD	SHIELD																																																																																					







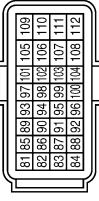

JCNWM1846GI

IPOD ADAPTER

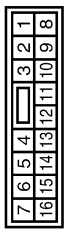
< ECU DIAGNOSIS >

[BOSE AUDIO WITH NAVIGATION]

BOSE AUDIO WITH NAVIGATION SYSTEM

<table border="1"> <tr><td>Connector No.</td><td>E6</td></tr> <tr><td>Connector Name</td><td>WIRE TO WIRE</td></tr> <tr><td>Connector Type</td><td>TK16MGY-TV</td></tr> </table>  <table border="1"> <tr><td>Terminal No.</td><td>Color of Wire</td><td>Signal Name [Specification]</td></tr> <tr><td>4</td><td>R</td><td>-</td></tr> </table>	Connector No.	E6	Connector Name	WIRE TO WIRE	Connector Type	TK16MGY-TV	Terminal No.	Color of Wire	Signal Name [Specification]	4	R	-	<table border="1"> <tr><td>Connector No.</td><td>E16</td></tr> <tr><td>Connector Name</td><td>ECM</td></tr> <tr><td>Connector Type</td><td>RH2FEB-RZ8-L-LH</td></tr> </table>  <table border="1"> <tr><td>Terminal No.</td><td>Color of Wire</td><td>Signal Name [Specification]</td></tr> <tr><td>97</td><td>P</td><td>VEHGAN-L</td></tr> <tr><td>98</td><td>L</td><td>VEHGAN-H</td></tr> </table>	Connector No.	E16	Connector Name	ECM	Connector Type	RH2FEB-RZ8-L-LH	Terminal No.	Color of Wire	Signal Name [Specification]	97	P	VEHGAN-L	98	L	VEHGAN-H	<table border="1"> <tr><td>Connector No.</td><td>E18</td></tr> <tr><td>Connector Name</td><td>BACK-UP LAMP RELAY</td></tr> <tr><td>Connector Type</td><td>MS22FL-M2-LC</td></tr> </table>  <table border="1"> <tr><td>Terminal No.</td><td>Color of Wire</td><td>Signal Name [Specification]</td></tr> <tr><td>1</td><td>LG</td><td>-</td></tr> <tr><td>2</td><td>R</td><td>-</td></tr> <tr><td>3</td><td>LG</td><td>-</td></tr> <tr><td>5</td><td>R</td><td>-</td></tr> </table>	Connector No.	E18	Connector Name	BACK-UP LAMP RELAY	Connector Type	MS22FL-M2-LC	Terminal No.	Color of Wire	Signal Name [Specification]	1	LG	-	2	R	-	3	LG	-	5	R	-	<table border="1"> <tr><td>Connector No.</td><td>E104</td></tr> <tr><td>Connector Name</td><td>WIRE TO WIRE</td></tr> <tr><td>Connector Type</td><td>NS16FW-CS</td></tr> </table>  <table border="1"> <tr><td>Terminal No.</td><td>Color of Wire</td><td>Signal Name [Specification]</td></tr> <tr><td>4</td><td>R</td><td>-</td></tr> <tr><td>5</td><td>L</td><td>-</td></tr> <tr><td>6</td><td>P</td><td>-</td></tr> <tr><td>7</td><td>L</td><td>-</td></tr> </table>	Connector No.	E104	Connector Name	WIRE TO WIRE	Connector Type	NS16FW-CS	Terminal No.	Color of Wire	Signal Name [Specification]	4	R	-	5	L	-	6	P	-	7	L	-	<table border="1"> <tr><td>Connector No.</td><td>E105</td></tr> <tr><td>Connector Name</td><td>WIRE TO WIRE</td></tr> <tr><td>Connector Type</td><td>TH70MW-CS10-M3</td></tr> </table>  <table border="1"> <tr><td>Terminal No.</td><td>Color of Wire</td><td>Signal Name [Specification]</td></tr> <tr><td>5</td><td>LG</td><td>-</td></tr> <tr><td>22</td><td>P</td><td>-</td></tr> <tr><td>47</td><td>P</td><td>-</td></tr> <tr><td>48</td><td>L</td><td>-</td></tr> <tr><td>75</td><td>BR</td><td>-</td></tr> <tr><td>76</td><td>GR</td><td>-</td></tr> <tr><td>78</td><td>V</td><td>-</td></tr> </table>	Connector No.	E105	Connector Name	WIRE TO WIRE	Connector Type	TH70MW-CS10-M3	Terminal No.	Color of Wire	Signal Name [Specification]	5	LG	-	22	P	-	47	P	-	48	L	-	75	BR	-	76	GR	-	78	V	-	<table border="1"> <tr><td>Connector No.</td><td>E109</td></tr> <tr><td>Connector Name</td><td>TH70MW-CS10-M3</td></tr> <tr><td>Connector Type</td><td>TH70MW-CS10-M3</td></tr> </table>  <table border="1"> <tr><td>Terminal No.</td><td>Color of Wire</td><td>Signal Name [Specification]</td></tr> <tr><td>19</td><td>G/B</td><td>REV LAMP RELAY</td></tr> </table>	Connector No.	E109	Connector Name	TH70MW-CS10-M3	Connector Type	TH70MW-CS10-M3	Terminal No.	Color of Wire	Signal Name [Specification]	19	G/B	REV LAMP RELAY	<table border="1"> <tr><td>Connector No.</td><td>F23</td></tr> <tr><td>Connector Name</td><td>TCM (TRANSMISSION CONTROL MODULE)</td></tr> <tr><td>Connector Type</td><td>RH40FB-RZ8-L-RH</td></tr> </table>  <table border="1"> <tr><td>Terminal No.</td><td>Color of Wire</td><td>Signal Name [Specification]</td></tr> <tr><td>4</td><td>G/B</td><td>-</td></tr> </table>	Connector No.	F23	Connector Name	TCM (TRANSMISSION CONTROL MODULE)	Connector Type	RH40FB-RZ8-L-RH	Terminal No.	Color of Wire	Signal Name [Specification]	4	G/B	-	<table border="1"> <tr><td>Connector No.</td><td>E27</td></tr> <tr><td>Connector Name</td><td>PARKING BRAKE SWITCH</td></tr> <tr><td>Connector Type</td><td>PO1FB-A</td></tr> </table>  <table border="1"> <tr><td>Terminal No.</td><td>Color of Wire</td><td>Signal Name [Specification]</td></tr> <tr><td>1</td><td>P</td><td>-</td></tr> </table>	Connector No.	E27	Connector Name	PARKING BRAKE SWITCH	Connector Type	PO1FB-A	Terminal No.	Color of Wire	Signal Name [Specification]	1	P	-	<table border="1"> <tr><td>Connector No.</td><td>F23</td></tr> <tr><td>Connector Name</td><td>WIRE TO WIRE</td></tr> <tr><td>Connector Type</td><td>TK16FGY-TV</td></tr> </table>  <table border="1"> <tr><td>Terminal No.</td><td>Color of Wire</td><td>Signal Name [Specification]</td></tr> <tr><td>4</td><td>G/B</td><td>-</td></tr> </table>	Connector No.	F23	Connector Name	WIRE TO WIRE	Connector Type	TK16FGY-TV	Terminal No.	Color of Wire	Signal Name [Specification]	4	G/B	-
Connector No.	E6																																																																																																																																																										
Connector Name	WIRE TO WIRE																																																																																																																																																										
Connector Type	TK16MGY-TV																																																																																																																																																										
Terminal No.	Color of Wire	Signal Name [Specification]																																																																																																																																																									
4	R	-																																																																																																																																																									
Connector No.	E16																																																																																																																																																										
Connector Name	ECM																																																																																																																																																										
Connector Type	RH2FEB-RZ8-L-LH																																																																																																																																																										
Terminal No.	Color of Wire	Signal Name [Specification]																																																																																																																																																									
97	P	VEHGAN-L																																																																																																																																																									
98	L	VEHGAN-H																																																																																																																																																									
Connector No.	E18																																																																																																																																																										
Connector Name	BACK-UP LAMP RELAY																																																																																																																																																										
Connector Type	MS22FL-M2-LC																																																																																																																																																										
Terminal No.	Color of Wire	Signal Name [Specification]																																																																																																																																																									
1	LG	-																																																																																																																																																									
2	R	-																																																																																																																																																									
3	LG	-																																																																																																																																																									
5	R	-																																																																																																																																																									
Connector No.	E104																																																																																																																																																										
Connector Name	WIRE TO WIRE																																																																																																																																																										
Connector Type	NS16FW-CS																																																																																																																																																										
Terminal No.	Color of Wire	Signal Name [Specification]																																																																																																																																																									
4	R	-																																																																																																																																																									
5	L	-																																																																																																																																																									
6	P	-																																																																																																																																																									
7	L	-																																																																																																																																																									
Connector No.	E105																																																																																																																																																										
Connector Name	WIRE TO WIRE																																																																																																																																																										
Connector Type	TH70MW-CS10-M3																																																																																																																																																										
Terminal No.	Color of Wire	Signal Name [Specification]																																																																																																																																																									
5	LG	-																																																																																																																																																									
22	P	-																																																																																																																																																									
47	P	-																																																																																																																																																									
48	L	-																																																																																																																																																									
75	BR	-																																																																																																																																																									
76	GR	-																																																																																																																																																									
78	V	-																																																																																																																																																									
Connector No.	E109																																																																																																																																																										
Connector Name	TH70MW-CS10-M3																																																																																																																																																										
Connector Type	TH70MW-CS10-M3																																																																																																																																																										
Terminal No.	Color of Wire	Signal Name [Specification]																																																																																																																																																									
19	G/B	REV LAMP RELAY																																																																																																																																																									
Connector No.	F23																																																																																																																																																										
Connector Name	TCM (TRANSMISSION CONTROL MODULE)																																																																																																																																																										
Connector Type	RH40FB-RZ8-L-RH																																																																																																																																																										
Terminal No.	Color of Wire	Signal Name [Specification]																																																																																																																																																									
4	G/B	-																																																																																																																																																									
Connector No.	E27																																																																																																																																																										
Connector Name	PARKING BRAKE SWITCH																																																																																																																																																										
Connector Type	PO1FB-A																																																																																																																																																										
Terminal No.	Color of Wire	Signal Name [Specification]																																																																																																																																																									
1	P	-																																																																																																																																																									
Connector No.	F23																																																																																																																																																										
Connector Name	WIRE TO WIRE																																																																																																																																																										
Connector Type	TK16FGY-TV																																																																																																																																																										
Terminal No.	Color of Wire	Signal Name [Specification]																																																																																																																																																									
4	G/B	-																																																																																																																																																									

JCNWM1847GI

A
B
C
D
E
F
G
H
I
J
K
L
M
AV
O
P

IPOD ADAPTER

< ECU DIAGNOSIS >

[BOSE AUDIO WITH NAVIGATION]

BOSE AUDIO WITH NAVIGATION SYSTEM

Connector No.	M11
Connector Name	WIRE TO WIRE
Connector Type	TH170FW-CS1D-H3



Terminal No.	Color of Wire	Signal Name [Specification]
5	O	-
22	G	-
47	P	-
48	L	-
75	BR	-
76	R	-
78	Y	-

Connector No.	M4
Connector Name	DATA LINK CONNECTOR
Connector Type	BD16FW

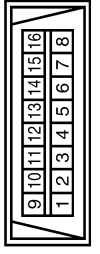

Terminal No.	Color of Wire	Signal Name [Specification]
6	L	-
14	P	-

Connector No.	M3
Connector Name	FUSE BLOCK (J/B)
Connector Type	NS12FW-CS



Terminal No.	Color of Wire	Signal Name [Specification]
12C	O	-

Connector No.	M1
Connector Name	FUSE BLOCK (J/B)
Connector Type	NS6FW-M2



Terminal No.	Color of Wire	Signal Name [Specification]
2A	G	-
5A	R	-

Connector No.	M22
Connector Name	WIRE TO WIRE
Connector Type	TH12FW-NH

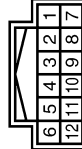

Terminal No.	Color of Wire	Signal Name [Specification]
12	R	-

Connector No.	M20
Connector Name	WIRE TO WIRE
Connector Type	TH40MW-CS15

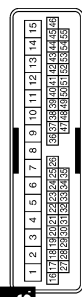

Terminal No.	Color of Wire	Signal Name [Specification]
4	B	-
5	L	-

Connector No.	M1B
Connector Name	WIRE TO WIRE
Connector Type	TH40MW-CS15

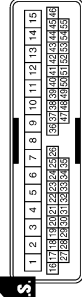

Terminal No.	Color of Wire	Signal Name [Specification]
4	W	- [Type A and without BOSE system type B]
5	BR	- [With BOSE system type B]

Terminal No.	Color of Wire	Signal Name [Specification]
1	V	-
2	R	-
3	R	-
4	G	-
5	W	-
6	SHIELD	-
7	LG	-
8	SHIELD	-
9	BR	-
10	SHIELD	-
11	L	-

Terminal No.	Color of Wire	Signal Name [Specification]
4	B	-
5	L	-

Terminal No.	Color of Wire	Signal Name [Specification]
4	W	-
5	BR	- [Type A and without BOSE system type B]
5	B	- [With BOSE system type B]

JCNWM1848GI

IPOD ADAPTER

< ECU DIAGNOSIS >

[BOSE AUDIO WITH NAVIGATION]

BOSE AUDIO WITH NAVIGATION SYSTEM

Connector No.	M23
Connector Name	WIRE TO WIRE
Connector Type	TH18MW-NH

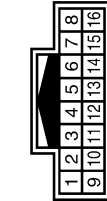

Terminal No.	Color of Wire	Signal Name [Specification]
1	W	-
2	SHIELD	[With telephone and navigation system]
3	B	-

Connector No.	M30
Connector Name	STEERING ANGLE SENSOR
Connector Type	TH08FW-NH

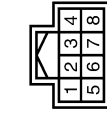

Terminal No.	Color of Wire	Signal Name [Specification]
1	B	-
3	L	-
4	G	-
6	SB	-
8	O	-

Connector No.	M33
Connector Name	COMBINATION SWITCH (SPIRAL CABLE)
Connector Type	TK08FGY-IV

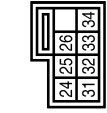

Terminal No.	Color of Wire	Signal Name [Specification]
24	BR	[With audio steering switch and telephone]
31	G	[With audio steering switch and telephone]
33	L	[With audio steering switch and telephone]

Connector No.	M34
Connector Name	COMBINATION METER
Connector Type	TH40FW-NH

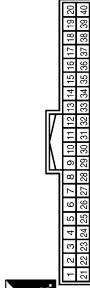

Terminal No.	Color of Wire	Signal Name [Specification]
21	L	CAN-H
22	P	CAN-L
31	V	VEHICLE SPEED (8-PULSE)

Connector No.	M44
Connector Name	WIRE TO WIRE
Connector Type	TH22FW-NH

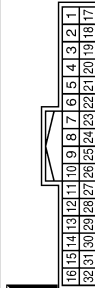

Terminal No.	Color of Wire	Signal Name [Specification]
1	G	-
2	R	-
3	SHIELD	-
4	B	-
5	W	-
6	SHIELD	-
7	O	- [Type A]
7	L	- [Type B]
8	SB	- [Type A]
8	R	- [Type B]
9	SHIELD	-

Connector No.	M49
Connector Name	FRONT DISPLAY UNIT
Connector Type	TH24FW-NH



Terminal No.	Color of Wire	Signal Name [Specification]
1	B	GND
2	Y	BATTERY[With navigation system]
3	R	ACC[With navigation system]
4	SHIELD	SHIELD[With navigation system]
5	B	AUX IMAGE GND[With navigation system]
6	R	RGB (GREEN) SIGNAL[With navigation system]
7	SHIELD	SHIELD
8	B	HPI[With navigation system]
9	W	RGB AREA (YS) SIGNAL
11	R	COMM (CONT->DISP)
12	W	CAMERA IMAGE SIGNAL

Terminal No.	Color of Wire	Signal Name [Specification]
13	B	GND[With navigation system]
14	SHIELD	SHIELD[With navigation system]
15	Y	AUX IMAGE SIGNAL[With navigation system]
17	G	RGB (RED) SIGNAL
18	W	RGB (BLUE) SIGNAL[With navigation system]
19	B	RGB SYNC
20	R	VP
21	SHIELD	SHIELD
22	G	COMM (DISP->CONT)
23	SHIELD	SHIELD

JCNWM1849GI

A
B
C
D
E
F
G
H
I
J
K
L
M
N
O
P



IPOD ADAPTER

< ECU DIAGNOSIS >

[BOSE AUDIO WITH NAVIGATION]

BOSE AUDIO WITH NAVIGATION SYSTEM

Connector No.	M65
Connector Name	FRONT SQUAWKER LH
Connector Type	TK02FBR



Terminal No.	Color of Wire	Signal Name [Specification]
1	LG	- [With BOSE system]
2	Y	- [With BOSE system]

Connector No.	M66
Connector Name	CENTER SPEAKER
Connector Type	TK02FBR



Terminal No.	Color of Wire	Signal Name [Specification]
1	P	-
2	O	-

Connector No.	M67
Connector Name	FRONT SQUAWKER RH
Connector Type	TK02FBR



Terminal No.	Color of Wire	Signal Name [Specification]
1	BR	-
2	R	- [With BOSE system]

Connector No.	M77
Connector Name	WIRE TO WIRE
Connector Type	TH80FW-CS19

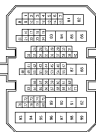

Terminal No.	Color of Wire	Signal Name [Specification]
41	O	-
42	SB	-
43	L	-
44	V	-
45	P	-
46	R	-
47	Y	-
48	L	-
49	G	-
50	SHIELD	-
51	W	-

56	P	-
57	L	-
58	SB	-
66	L	-
67	R	-

Connector No.	M97
Connector Name	WIRE TO WIRE
Connector Type	TH18FW-GS2

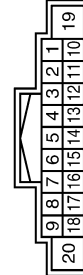

Terminal No.	Color of Wire	Signal Name [Specification]
5	SHIELD	-
6	W	-
8	B	-
9	Y	-
14	R	-
15	B	-
17	SHIELD	-
18	B	- [Type A and With navigation system type B]

Connector No.	M122
Connector Name	BCM (BODY CONTROL MODULE)
Connector Type	TH40FB-NH



Terminal No.	Color of Wire	Signal Name [Specification]
90	P	CAN-L
91	L	CAN-H

JCNWM1850GI

IPOD ADAPTER

< ECU DIAGNOSIS >

[BOSE AUDIO WITH NAVIGATION]

BOSE AUDIO WITH NAVIGATION SYSTEM

Connector No.	M124
Connector Name	WIRE TO WIRE
Connector Type	TH12BFW-CS

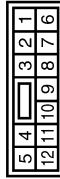

Terminal No.	Color of Wire	Signal Name [Specification]
1	P	-
2	BR	- [Type A]
3	L	- [Type B]
4	Y	-
5	BR	-
6	O	-
7	W	-
8	B	-
9	R	-
10	BR	-

Connector No.	M144
Connector Name	AV CONTROL UNIT (WITH NAVIGATION SYSTEM)
Connector Type	TH18FW-CS2

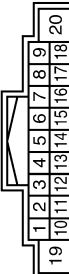

Terminal No.	Color of Wire	Signal Name [Specification]
1	P	AMP ON SIGNAL
2	G	SOUND SIGNAL FRONT LH (+)
3	R	SOUND SIGNAL FRONT LH (-)
4	O	SOUND SIGNAL REAR LH (+) [Type A]
4	L	SOUND SIGNAL REAR LH (+) [Type B]
5	SB	SOUND SIGNAL REAR LH (-) [Type A]
5	R	SOUND SIGNAL REAR LH (-) [Type B]
6	BR	STRG SW A
7	R	ACC
8	R	ILLUMINATION
10	SHIELD	SHIELD

11	LG
12	R

Connector No.	M125
Connector Name	MULTIFUNCTION SWITCH
Connector Type	TH18FW-NH

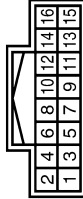

Terminal No.	Color of Wire	Signal Name [Specification]
1	B	GND
3	R	ACC
6	R	AV COMM (H)
8	L	AV COMM (L)
9	V	SW GND
14	W	EJECT SIGNAL

11	B	SOUND SIGNAL FRONT RH (+)
12	W	SOUND SIGNAL FRONT RH (-)
13	V	SOUND SIGNAL REAR RH (+)
14	LG	SOUND SIGNAL REAR RH (-)
15	L	STRG SW GND
16	G	STRG SW B
19	Y	BATTERY

Connector No.	M145
Connector Name	AV CONTROL UNIT (WITH NAVIGATION SYSTEM)
Connector Type	TH40FW-NH



Terminal No.	Color of Wire	Signal Name [Specification]
21	B	GND
22	Y	BATTERY
23	B	GND
24	Y	BATTERY
25	R	ACC
26	B	MICROPHONE VCC
27	SHIELD	MICROPHONE GND
28	W	MICROPHONE SIGNAL
35	G	IGNITION
36	G	PARKING BRAKE
37	SB	REVERSE

38	V	VEHICLE SPEED (8-PULSE)
40	P	CONNECTION RECOGNITION
42	B	CONTROL SIGNAL
43	B	CONTROL SIGNAL
48	G	AV COMM (H)
49	L	AV COMM (L)
50	R	AV COMM (H)
51	L	AV COMM (L)
52	L	CAN-H
53	P	CAN-L

A
B
C
D
E
F
G
H
I
J
K
L
M
N
O
P

AV

IPOD ADAPTER

< ECU DIAGNOSIS >

[BOSE AUDIO WITH NAVIGATION]

BOSE AUDIO WITH NAVIGATION SYSTEM

Connector No.	M146
Connector Name	AV CONTROL UNIT (WITH NAVIGATION SYSTEM)
Connector Type	TH12FW-NH



62	64	66	68	70	72
61	63	65	67	69	71

Terminal No.	Color of Wire	Signal Name [Specification]
61	G	RGB (R/RED) SIGNAL
62	R	RGB (G/GREEN) SIGNAL
63	W	RGB (B/BLUE) SIGNAL
64	SHIELD	SHIELD
65	B	RGB SYNC
66	SHIELD	SHIELD
67	W	RGB AREA (VS) SIGNAL
68	B	HP
69	R	VP
70	R	COMM (CONT->DISP)
71	G	COMM (DISP->CONT)

Connector No.	M148
Connector Name	IPOD ADAPTER
Connector Type	TH12FW-NH



1	2	3	4	5	6	7	8	9	10	11	12
13	14	15	16	17	18	19	20	21	22	23	24

Terminal No.	Color of Wire	Signal Name [Specification]
1	BR	iPod SOUND SIGNAL LH (+)
2	R	iPod SOUND SIGNAL RH (+)
3	R	ACC
4	L	AV COMM (L)
5	Y	BATTERY
8	W	CHARGE POWER
9	G	COMM (iPod ADAPTER->iPod)
10	R	COMM (iPod->iPod ADAPTER)
11	R	ACCESSORY IDENTITY
12	V	iPod SOUND SIGNAL RH (+)
13	L	iPod SOUND SIGNAL LH (-)

Connector No.	M147
Connector Name	AV CONTROL UNIT (WITH NAVIGATION SYSTEM)
Connector Type	TH12FW-NH



73	74	75	76	77	78	79	80	81	82	83	84	85	86	87	88
89	90	91	92	93	94	95	96	97	98	99	100	101	102	103	104

Terminal No.	Color of Wire	Signal Name [Specification]
79	BR	iPod SOUND SIGNAL LH (+)
80	R	iPod SOUND SIGNAL RH (+)
81	SHIELD	SHIELD
85	W	EJECT SIGNAL
86	SHIELD	SHIELD
87	B	AUX SOUND SIGNAL LH (+)
88	W	AUX SOUND SIGNAL GND
93	L	iPod SOUND SIGNAL LH (-)
96	W	iPod SOUND SIGNAL RH (-)
102	V	SW GND
103	R	AUX SOUND SIGNAL RH (+)

Connector No.	M204
Connector Name	WIRE TO WIRE
Connector Type	TH12MW-NH



1	2	3	4	5	6
7	8	9	10	11	12

Terminal No.	Color of Wire	Signal Name [Specification]
1	V	-
2	R	-
3	R	-
4	G	-
5	W	-
6	SHIELD	-
7	LG	-
8	SHIELD	-
9	BR	-
10	SHIELD	-
11	L	-

12	R
----	---

IPOD ADAPTER

< ECU DIAGNOSIS >

[BOSE AUDIO WITH NAVIGATION]

BOSE AUDIO WITH NAVIGATION SYSTEM

Connector No. M251	WIRE TO WIRE	TH18MW-CS2		
Terminal No.	Color of Wire	Signal Name [Specification]		
5	SHIELD			
6	W			
8	SHIELD			
9	G			
14	R			
15	B			
17	SHIELD			
18	R			
Connector No. M253	AUXILIARY INPUT JACKS	AB8FW		
Terminal No.	Color of Wire	Signal Name [Specification]		
1	R	SOUND SIGNAL RH (+)		
2	W	SOUND SIGNAL GND		
3	B	SOUND SIGNAL LH (+) [Without DVD player]		
7	G	AUX IMAGE SIGNAL		
8	R	AUX IMAGE GND [Without DVD player]		
Connector No. M260	iPod SIDE	IP18FGY		
Terminal No.	Color of Wire	Signal Name [Specification]		
1	LG	iPod SOUND SIGNAL LH (+)		
2	R	iPod SOUND SIGNAL GND		
5	R	COMM (iPod->iPod ADAPTER)		
6	G	COMM (iPod ADAPTER->iPod)		
7	V	iPod SOUND SIGNAL RH (+)		
9	L	iPod CONNECTION RECOGNITION		
10	SHIELD	GND		
12	W	CHARGE POWER		
14	SHIELD	SHIELD		
15	BR	ACCESSORY DETECT		
16	R	ACCESSORY IDENTITY		
Connector No. M274	WIRE TO WIRE	GT16C-1PP-HU		
Terminal No.	Color of Wire	Signal Name [Specification]		
1				
2				
Connector No. M371	AV CONTROL UNIT (WITH NAVIGATION SYSTEM)	GT13SC-2/1S-HU		
Terminal No.	Color of Wire	Signal Name [Specification]		
105		FM SUB		
106		AM-FM MAIN		
107		ANTENNA AMP. ON SIGNAL		
Connector No. M372	AV CONTROL UNIT (WITH NAVIGATION SYSTEM)	FAKRA		
Terminal No.	Color of Wire	Signal Name [Specification]		
108		SATELLITE ANTENNA		
109				
Connector No. M373	WIRE TO WIRE	GT16C-1PP-HU		
Terminal No.	Color of Wire	Signal Name [Specification]		
1				
2				
Connector No. M374	WIRE TO WIRE	GT16C-1PP-HU		
Terminal No.	Color of Wire	Signal Name [Specification]		
1				
2				

JCNWM1853GI

A
B
C
D
E
F
G
H
I
J
K
L
M
N
O
P











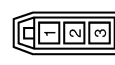
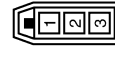

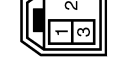
AV

IPOD ADAPTER

< ECU DIAGNOSIS >

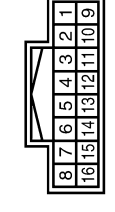
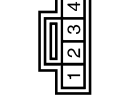
[BOSE AUDIO WITH NAVIGATION]

BOSE AUDIO WITH NAVIGATION SYSTEM

Connector No.	M375	Connector No.	M376	Connector No.	M377	Connector No.	M378
Connector Name	WIRE TO WIRE	Connector Name	WIRE TO WIRE	Connector Name	ANTENNA BASE (SATELLITE ANTENNA) (WITH NAVIGATION SYSTEM)	Connector Name	ANTENNA BASE (ANTENNA AMP.)
Connector Type	GT13SH-Z/1S-HU	Connector Type	GT13SON-Z/1PP-HU	Connector Type	GT16C-1PP-HU	Connector Type	GT13SSN-1/1PP-HU
							
							
Terminal No.		Terminal No.		Terminal No.		Terminal No.	
1	Signal Name [Specification]	1	Signal Name [Specification]	1	Signal Name [Specification]	1	Signal Name [Specification]
2	-	2	-	2	SATELLITE ANTENNA	2	-
3	-	3	-	3	-	3	-
Color of Wire	-	Color of Wire	-	Color of Wire	-	Color of Wire	-
Connector No.	M379	Connector No.	M380	Connector No.	R1	Connector No.	R20
Connector Name	GLASS ANTENNA	Connector Name	AV CONTROL UNIT (WITH NAVIGATION SYSTEM)	Connector Name	WIRE TO WIRE	Connector Name	MICROPHONE
Connector Type	GT13SON-1/1PP-HU	Connector Type	GT5-1S-HU	Connector Type	TH16FW-NH	Connector Type	TKQ4FW
							
							
Terminal No.		Terminal No.		Terminal No.		Terminal No.	
2	Signal Name [Specification]	110	Signal Name [Specification]	1	Signal Name [Specification]	1	Signal Name [Specification]
	FM SUB	111	GPS ANTENNA SHIELD	2	-	2	SHIELD (with telephone and navigation system)
				3	-	3	SHIELD (with telephone and navigation system)
						4	MICROPHONE POWER
Color of Wire	-	Color of Wire	-	Color of Wire	-	Color of Wire	-
R/W	-	R/W	-	R/W	-	R/W	-

JCNWM1854GI

CAMERA CONTROL UNIT

< ECU DIAGNOSIS >

[BOSE AUDIO WITH NAVIGATION]

CAMERA CONTROL UNIT

Reference Values

INFOID:000000003457771

TERMINAL LAYOUT

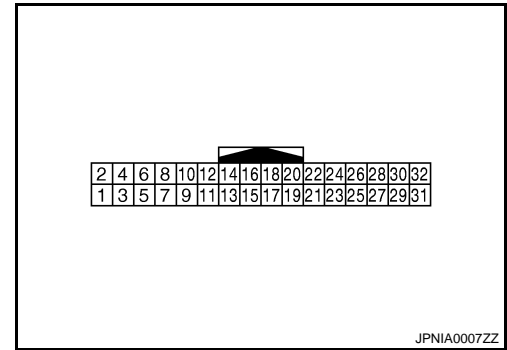

PHYSICAL VALUES

Terminal (Wire color)		Description		Condition		Reference value (Approx.)
+	-	Signal name	Input/ Output			
5	—	Shield	—	—	—	—
6 (B)	Ground	Camera image signal	Input	Ignition switch ON	when rear view camera im- age is displayed.	
7 (R/W)	Ground	Rear view camera ground	—	Ignition switch ON	—	0 V
8 (R/L)	Ground	Camera ON signal	Output	Ignition switch ON	R position. Other than R position.	6.0 V 0 V
11	Ground	Shield (camera image ground)	—	Ignition switch ON	—	0 V
12 (B)	11	Camera image signal	Output	Ignition switch ON	when rear view camera im- age is displayed.	
14 (L)	Ground	Camera-connection recog- nition signal	Output	Ignition switch ON	Connected to camera con- trol unit connector. Not connected to camera control unit connector.	0 V 5.0 V
17 (BR)	—	AV communication signal (L)	Input/ Output	—	—	—
18 (Y)	—	AV communication signal (H)	Input/ Output	—	—	—

A
B
C
D
E
F
G
H
I
J
K
L
M

AV

P

CAMERA CONTROL UNIT

< ECU DIAGNOSIS >

[BOSE AUDIO WITH NAVIGATION]

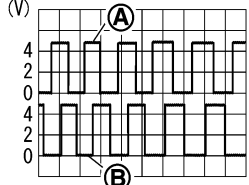
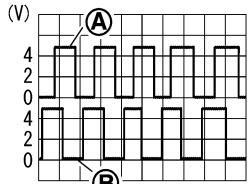
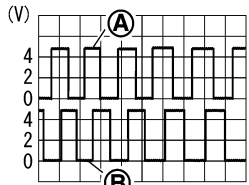
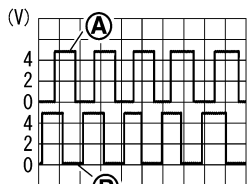
Terminal (Wire color)		Description		Condition		Reference value (Approx.)
+	-	Signal name	Input/ Output			
19 (GR)	—	AV communication signal (L)	Input/ Output	—	—	—
20 (G)	—	AV communication signal (H)	Input/ Output	—	—	—
22 (R)	Ground	Reverse signal	Input	Ignition switch ON	R position.	12.0 V
				Other than R position.	0 V	
23 (G)	Ground	Sensor signal 1	Input	Ignition switch ON	Turn the steering to the right.	 <p style="text-align: right; font-size: small;">SKIB3827E</p> <p style="text-align: center;">A: Sensor signal 1 B: Sensor signal 2</p>
					Turn the steering to the left.	 <p style="text-align: right; font-size: small;">SKIB3828E</p> <p style="text-align: center;">A: Sensor signal 1 B: Sensor signal 2</p>
24 (SB)	Ground	Sensor signal 2	Input	Ignition switch ON	Turn the steering to the right.	 <p style="text-align: right; font-size: small;">SKIB3827E</p> <p style="text-align: center;">A: Sensor signal 1 B: Sensor signal 2</p>
					Turn the steering to the left.	 <p style="text-align: right; font-size: small;">SKIB3828E</p> <p style="text-align: center;">A: Sensor signal 1 B: Sensor signal 2</p>

CAMERA CONTROL UNIT

< ECU DIAGNOSIS >

[BOSE AUDIO WITH NAVIGATION]

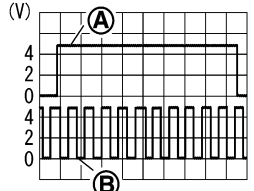
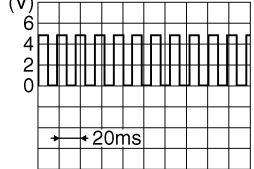
Terminal (Wire color)		Description		Condition		Reference value (Approx.)
+	-	Signal name	Input/ Output			
25 (O)	Ground	Sensor signal 3	Input	Ignition switch ON	Turn the steering around the neutral position.	 <p style="font-size: small;">A: Sensor signal 3 B: Sensor signal 1</p>
26 (BR)	Ground	Vehicle speed signal (8-pulse)	Input	Ignition switch ON	When vehicle speed is ap- prox. 40 km/h (25 MPH).	<p>NOTE: Maximum voltage may be 12 V due to specifications (connected units).</p> 
30 (GR)	Ground	ACC power supply	Input	Ignition switch ACC	—	Battery voltage
31 (B)	Ground	Ground	—	Ignition switch ON	—	0 V
32 (V)	Ground	Battery power supply	Input	Ignition switch OFF	—	Battery voltage

Wiring Diagram - BOSE AUDIO WITH NAVIGATION SYSTEM -

INFOID:000000003702905

NOTE:

A
B
C
D
E
F
G
H
I
J
K
L
M
AV
O
P



CAMERA CONTROL UNIT

[BOSE AUDIO WITH NAVIGATION]

< ECU DIAGNOSIS >

In this section, PRESET SWITCH and MULTIFUNCTION SWITCH are written as the MULTIFUNCTION SWITCH.

BOSE AUDIO WITH NAVIGATION SYSTEM

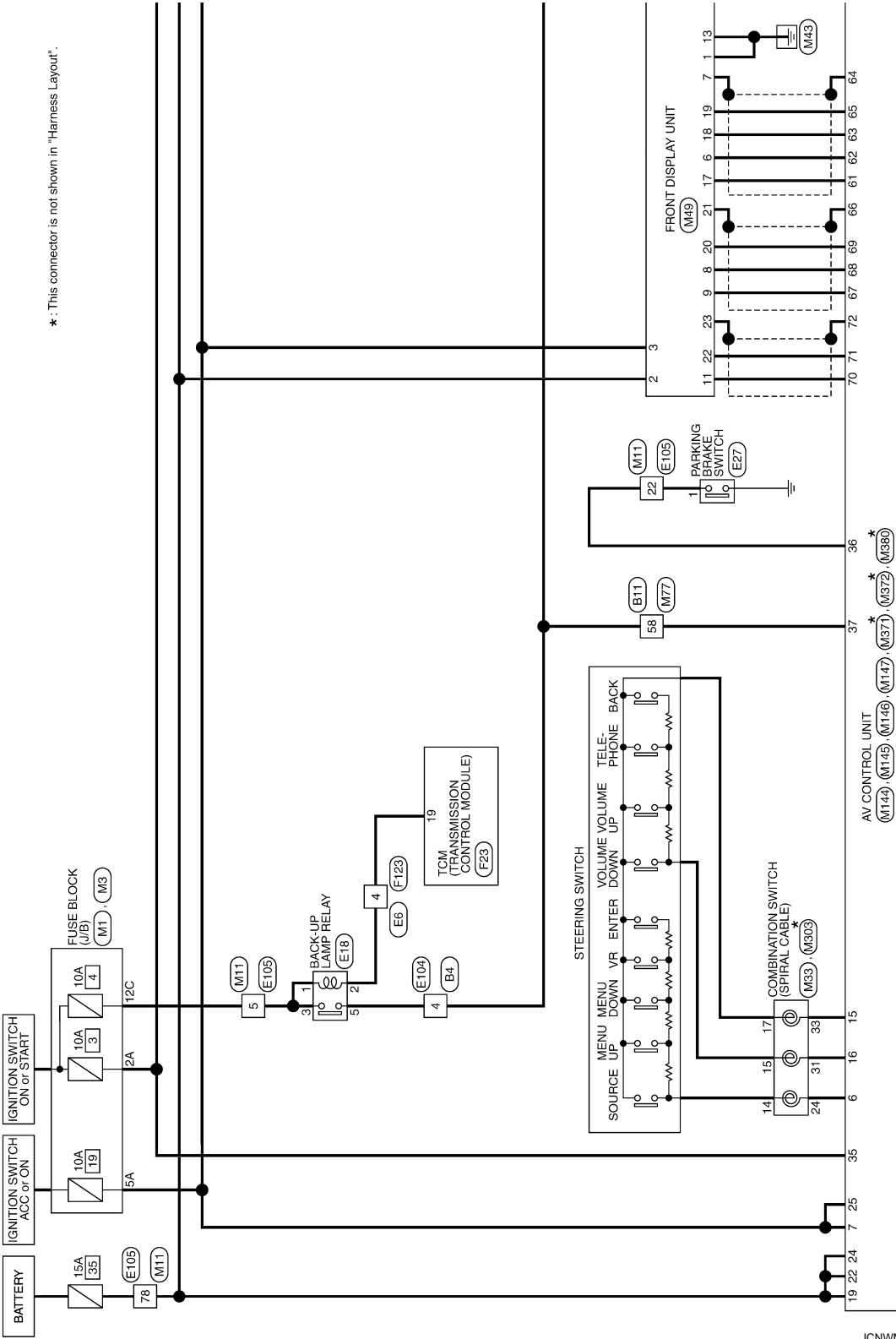

*: This connector is not shown in "Harness Layout".

JCNWM1838GI

2008/09/23

CAMERA CONTROL UNIT

[BOSE AUDIO WITH NAVIGATION]

< ECU DIAGNOSIS >

◁ WI ▷ : With iPod

* : This connector is not shown in "Harness Layout".

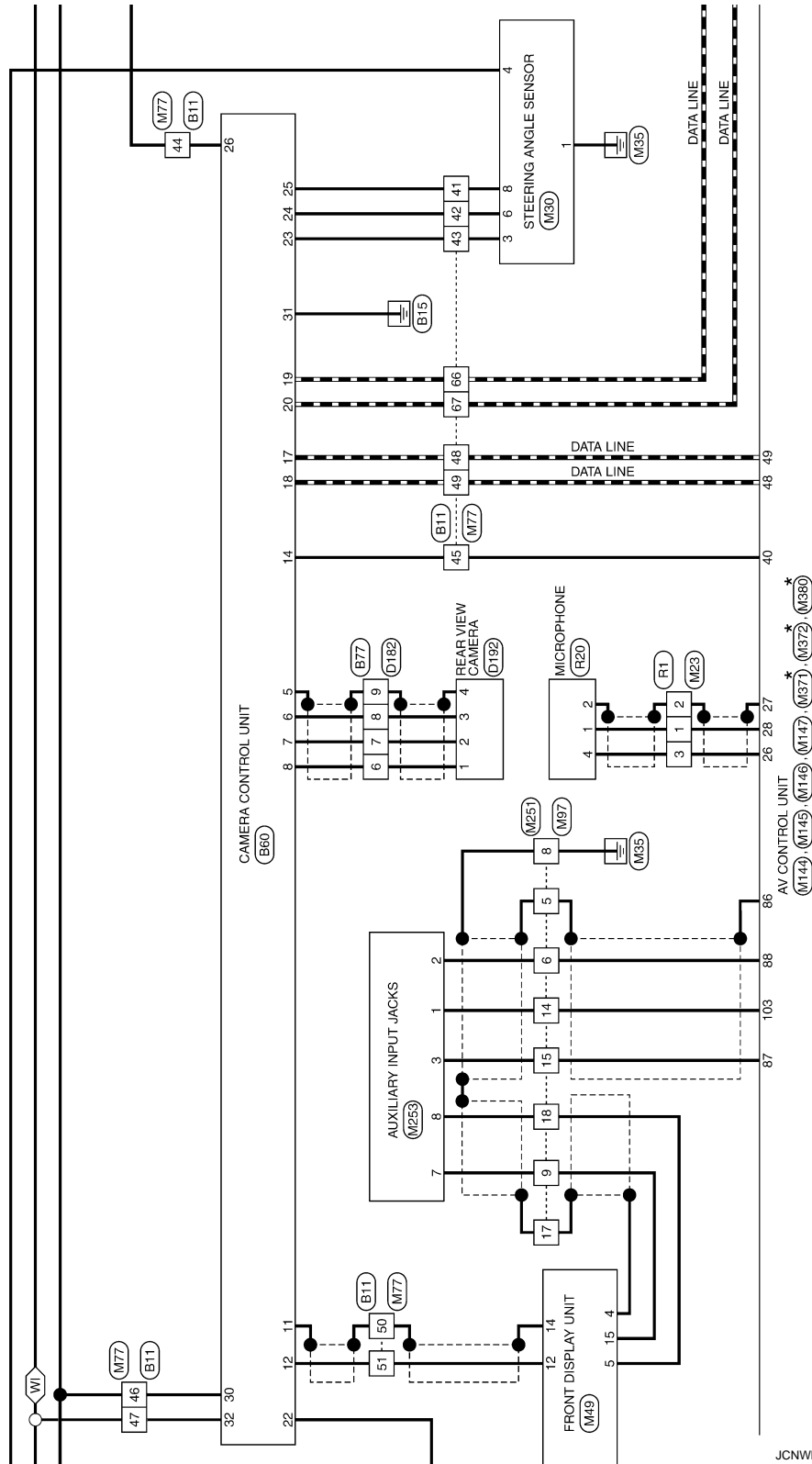

JCNWM1839GI

A
B
C
D
E
F
G
H
I
J
K
L
M
AV
O
P

CAMERA CONTROL UNIT

[BOSE AUDIO WITH NAVIGATION]

< ECU DIAGNOSIS >

WI : With iPod
AB : With automatic back door
OA : Without automatic back door

* : This connector is not shown in "Harness Layout".

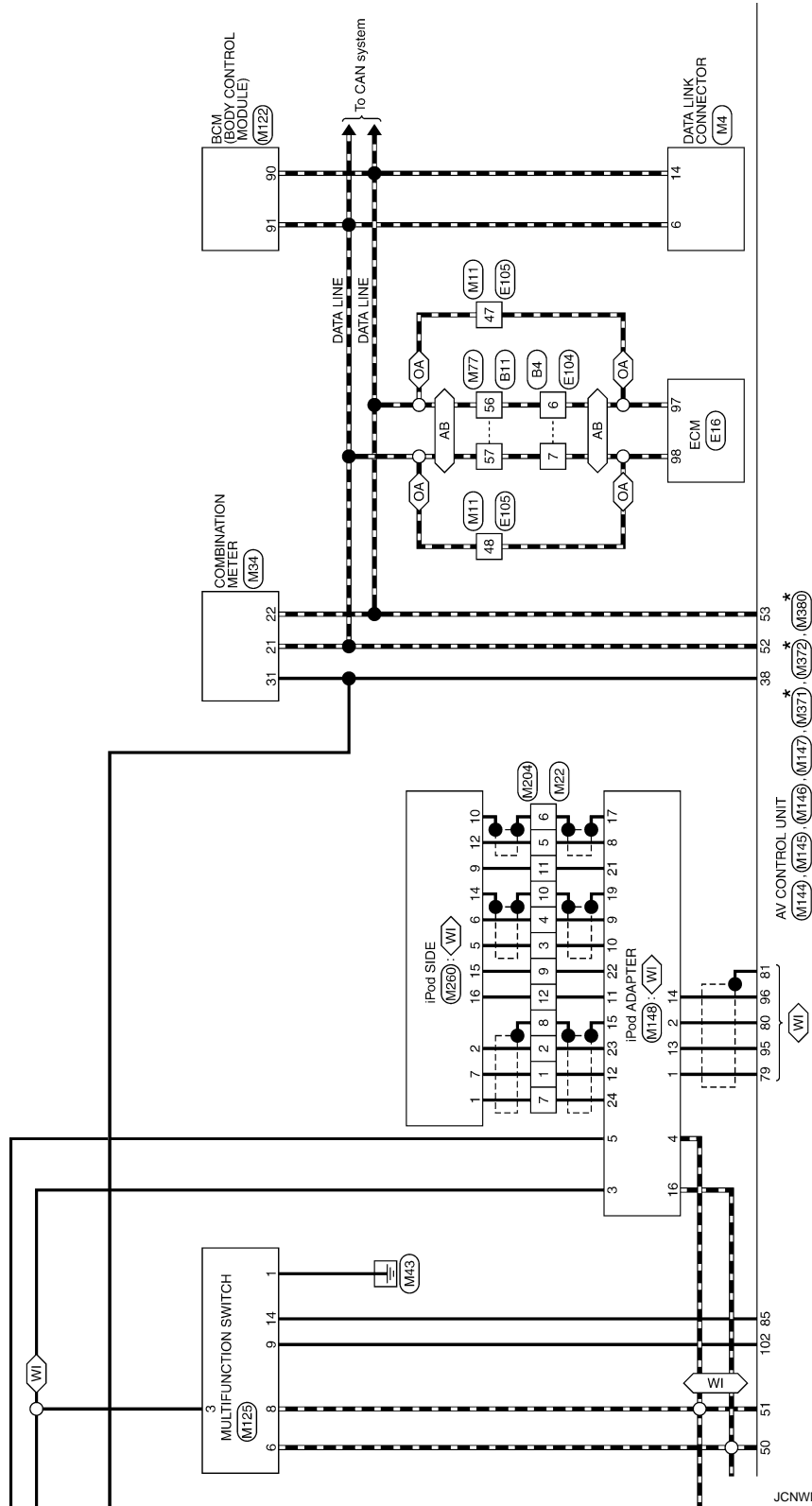

JCNWM1840GI

CAMERA CONTROL UNIT

[BOSE AUDIO WITH NAVIGATION]

< ECU DIAGNOSIS >

*: This connector is not shown in "Harness Layout".

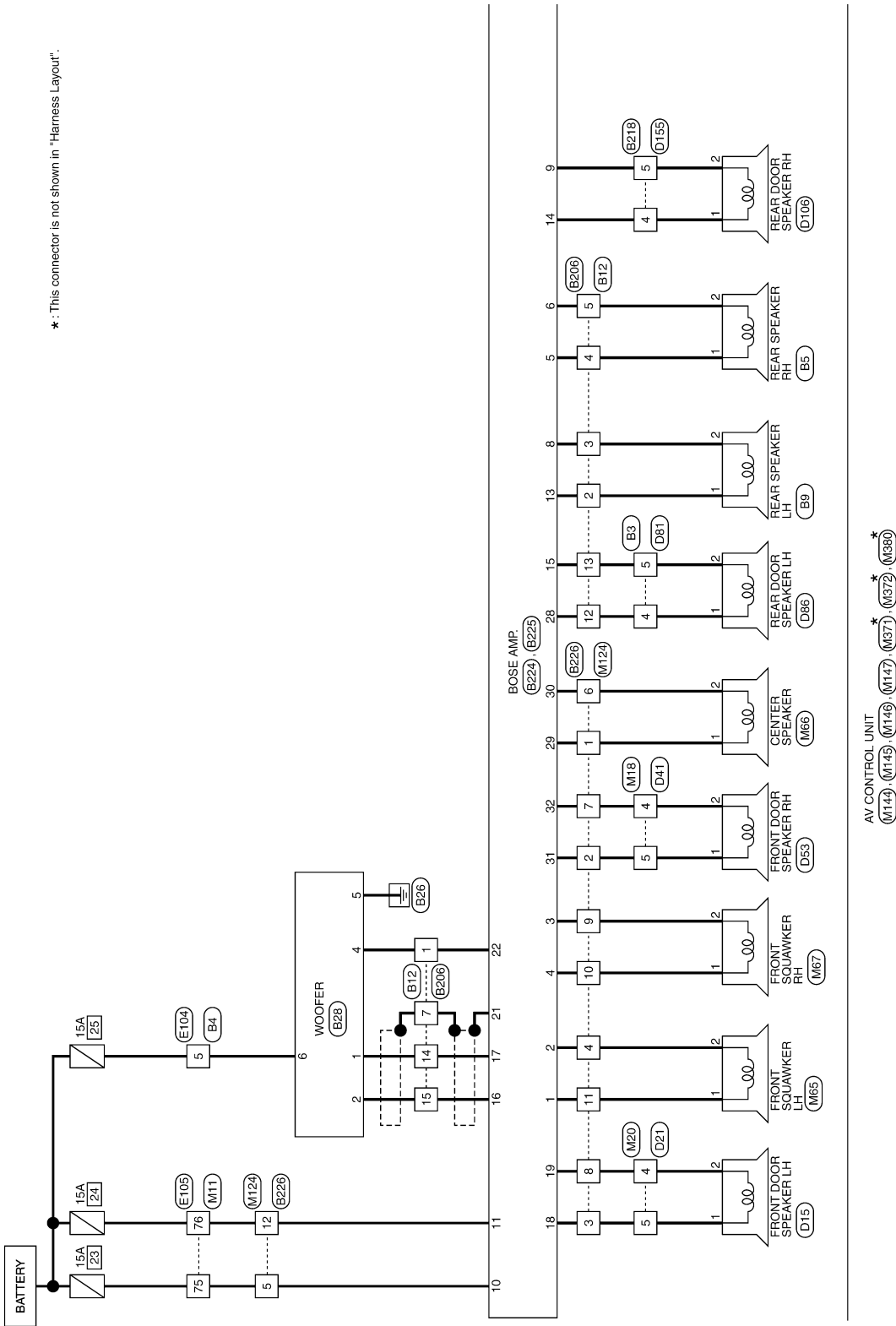

JCNWM1841G1

A
B
C
D
E
F
G
H
I
J
K
L
M
N
O
P

AV

CAMERA CONTROL UNIT

[BOSE AUDIO WITH NAVIGATION]

< ECU DIAGNOSIS >

*: This connector is not shown in "Harness Layout".

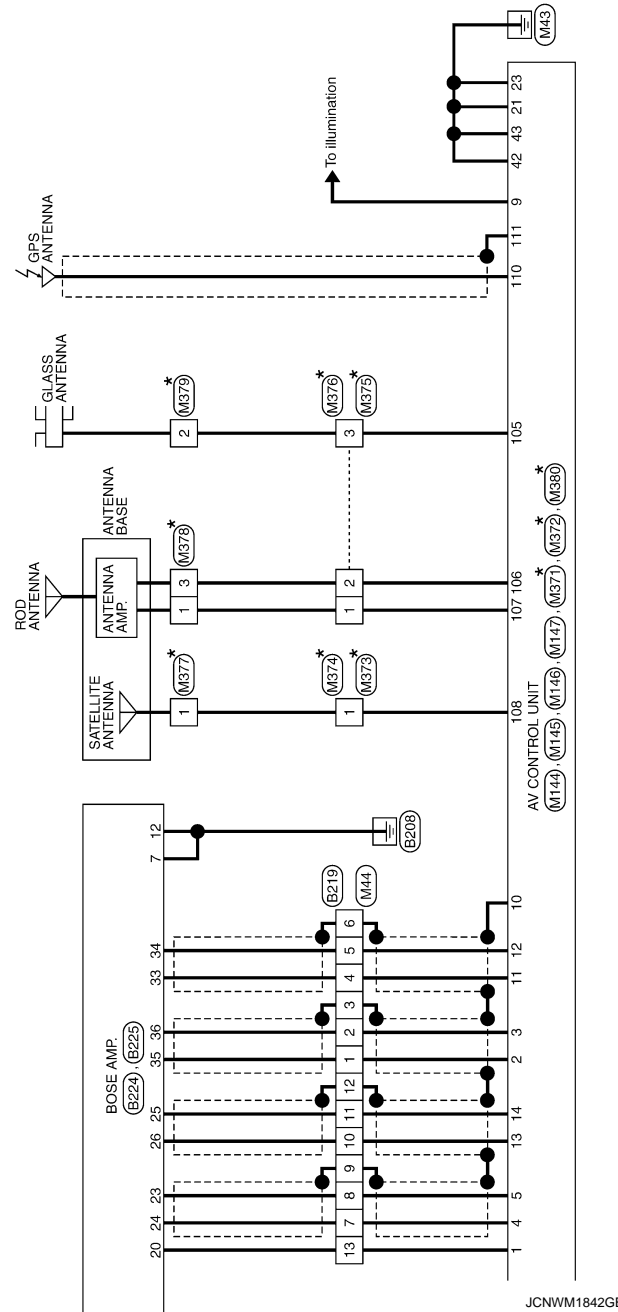

CAMERA CONTROL UNIT

[BOSE AUDIO WITH NAVIGATION]

< ECU DIAGNOSIS >

BOSE AUDIO WITH NAVIGATION SYSTEM

Connector No. B3	WIRE TO WIRE	TK0FW-NSB	10 9 8 7 6 5 4 3 2 1 18 17 16 15 14 13 12 11	H.S.	Connector No. B3	REAR SPEAKER LH	TK0ZFBR	2 1	H.S.	Terminal No.	Color of Wire	Signal Name [Specification]
Connector Name	WIRE TO WIRE	TK0FW-NSB			Connector Name	REAR SPEAKER LH	TK0ZFBR			1	SB	
Connector Type	TK0FW-NSB				Connector Type	TK0ZFBR				2	GR	
Terminal No.	Color of Wire	Signal Name [Specification]			Terminal No.	Color of Wire	Signal Name [Specification]					
4	LG											
5	O											
Connector No. B4	WIRE TO WIRE	NS16MW-CS	1 2 3 4 5 6 7 8 9 10 11 12 13 14 15 16	H.S.	Connector No. B5	REAR SPEAKER RH	TK0ZFBR	2 1	H.S.	Terminal No.	Color of Wire	Signal Name [Specification]
Connector Name	WIRE TO WIRE	NS16MW-CS			Connector Name	REAR SPEAKER RH	TK0ZFBR			1	V	
Connector Type	NS16MW-CS				Connector Type	TK0ZFBR				2	LG	
Terminal No.	Color of Wire	Signal Name [Specification]			Terminal No.	Color of Wire	Signal Name [Specification]					
4	R											
5	O											
6	P											
7	L											
Connector No. B11	WIRE TO WIRE	TH80MW-CS19		H.S.	Connector No. B12	WIRE TO WIRE	NS18FW-CS	7 6 5 4 3 2 1 16 15 14 13 12 11 10 9 8	H.S.	Terminal No.	Color of Wire	Signal Name [Specification]
Connector Name	WIRE TO WIRE	TH80MW-CS19			Connector Name	WIRE TO WIRE	NS18FW-CS			1	W	
Connector Type	TH80MW-CS19				Connector Type	NS18FW-CS				2	SB	
Terminal No.	Color of Wire	Signal Name [Specification]			Terminal No.	Color of Wire	Signal Name [Specification]			3	GR	
41	O									4	V	
42	SB									5	LG	
43	G									7	SHIELD	
44	BR									12	LG	
45	L									13	O	
46	GR									14	W/R	
47	V									15	B/R	
48	BR											
49	Y											
50	SHIELD											
51	B											
Terminal No.	Color of Wire	Signal Name [Specification]			Terminal No.	Color of Wire	Signal Name [Specification]					
41	O											
42	SB											
43	G											
44	BR											
45	L											
46	GR											
47	V											
48	BR											
49	Y											
50	SHIELD											
51	B											
Terminal No.	Color of Wire	Signal Name [Specification]			Terminal No.	Color of Wire	Signal Name [Specification]					
1	W/R											
2	B/R											
4	W											
5	B/W											
6	O											
Terminal No.	Color of Wire	Signal Name [Specification]			Terminal No.	Color of Wire	Signal Name [Specification]					
1	W/R											
2	B/R											
4	W											
5	B/W											
6	O											
Terminal No.	Color of Wire	Signal Name [Specification]			Terminal No.	Color of Wire	Signal Name [Specification]					
1	W/R											
2	B/R											
4	W											
5	B/W											
6	O											
Terminal No.	Color of Wire	Signal Name [Specification]			Terminal No.	Color of Wire	Signal Name [Specification]					
1	W/R											
2	B/R											
4	W											
5	B/W											
6	O											

JCNWM1843GI

A
B
C
D
E
F
G
H
I
J
K
L
M
AV
O
P

CAMERA CONTROL UNIT

[BOSE AUDIO WITH NAVIGATION]

< ECU DIAGNOSIS >

BOSE AUDIO WITH NAVIGATION SYSTEM

Connector No.	B80
Connector Name	CAMERA CONTROL UNIT
Connector Type	TH22FW-NH

Terminal No.	2	4	6	8	10	12	14	16	18	20	22	24	26	28	30	32
Color of Wire	SHIELD	B	R/W	R/L	SHIELD	B	L	BR	Y	GR	GR	AV COMM (L)	AV COMM (H)	AV COMM (L)	AV COMM (H)	
Signal Name [Specification]	SHIELD	CAMERA IMAGE SIGNAL	CAMERA ON SIGNAL	SHIELD	CAMERA IMAGE SIGNAL	CONNECTION RECOGNITION	AV COMM (L)	AV COMM (H)	AV COMM (L)	AV COMM (H)						



1	2	3	4	5	6	7	8	9	10	11	12	13	14	15	16	17	18	19	20	21	22	23	24	25	26	27	28	29	30	31	32
---	---	---	---	---	---	---	---	---	----	----	----	----	----	----	----	----	----	----	----	----	----	----	----	----	----	----	----	----	----	----	----

22	R	REVERSE
23	G	SENSOR SIGNAL 1
24	SR	SENSOR SIGNAL 2
25	O	SENSOR SIGNAL 3
26	BR	VEHICLE SPEED (3-PULSE)
30	GR	ACC
31	B	GND
32	V	BATTERY



1	2	3	4	5
---	---	---	---	---

Connector No.	B77
Connector Name	WIRE TO WIRE
Connector Type	TK12MW



1	2	3	4	5	6	7
---	---	---	---	---	---	---

Connector No.	B206
Connector Name	WIRE TO WIRE
Connector Type	NS16MM-CS



8	9	10	11	12	13	14	15	16
---	---	----	----	----	----	----	----	----

Terminal No.	5	6	7	8	11	12	14	17	18	19	20
Color of Wire	SHIELD	B	R/W	R/L	SHIELD	B	L	BR	Y	GR	G
Signal Name [Specification]	SHIELD	CAMERA IMAGE SIGNAL	CAMERA ON SIGNAL	SHIELD	CAMERA IMAGE SIGNAL	CONNECTION RECOGNITION	AV COMM (L)	AV COMM (H)	AV COMM (L)	AV COMM (H)	

Connector No.	B218
Connector Name	WIRE TO WIRE
Connector Type	TK10FW-NS8



10	9	8	7	6	5	4	3	2	1
----	---	---	---	---	---	---	---	---	---

Connector No.	B219
Connector Name	WIRE TO WIRE
Connector Type	TH32MW-NH



1	2	3	4	5	6	7	8	9	10	11	12	13	14	15	16
---	---	---	---	---	---	---	---	---	----	----	----	----	----	----	----

Terminal No.	6	7	8	9
Color of Wire	R/L	R/W	B	SHIELD
Signal Name [Specification]	-	-	-	-

Terminal No.	12	13
Color of Wire	SHIELD	SB
Signal Name [Specification]	-	-

Terminal No.	1	2	3	4	5	7	12	13	14	15
Color of Wire	W	GR	BR	Y	BR	SHIELD	G	R	W/R	B/R
Signal Name [Specification]	-	-	-	-	-	-	-	-	-	-

Terminal No.	4	5
Color of Wire	L	O
Signal Name [Specification]	-[With BOSE system]	-[With BOSE system]

Terminal No.	1	2	3	4	5	6	7	8	9	10	11
Color of Wire	W/R	B/R	SHIELD	W/R	B/R	SHIELD	GR/V	W/L	SHIELD	GR/V	W/L
Signal Name [Specification]	-	-	-	-	-	-	-	-	-	-	-

JCNWM1844GI

CAMERA CONTROL UNIT

[BOSE AUDIO WITH NAVIGATION]

< ECU DIAGNOSIS >

BOSE AUDIO WITH NAVIGATION SYSTEM

Connector No.	B224
Connector Name	BOSE AMP.
Connector Type	SSA12FER-SJ22

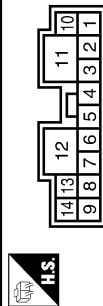

Terminal No.	Color of Wire	Signal Name [Specification]
1	LG	SOUND SIGNAL FRONT SQUAWKER LH (+)
2	V	SOUND SIGNAL FRONT SQUAWKER LH (-)
3	L	SOUND SIGNAL FRONT SQUAWKER RH (+)
4	P	SOUND SIGNAL FRONT SQUAWKER RH (-)
5	Y	SOUND SIGNAL REAR SPEAKER RH (+)
6	BR	SOUND SIGNAL REAR SPEAKER RH (-)
7	B	GND
8	BR	SOUND SIGNAL REAR SPEAKER LH (-)
9	O	SOUND SIGNAL REAR DOOR SPEAKER RH (-)
10	SB	BATTERY
11	GR	BATTERY

Connector No.	B226
Connector Name	WIRE TO WIRE
Connector Type	NS12MBR-CS

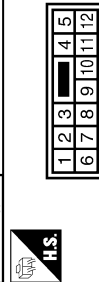

Terminal No.	Color of Wire	Signal Name [Specification]
1	V	-
2	BR	-
3	W	-
4	V	-
5	SB	-
6	P	-
7	Y	-
8	B	-
9	L	-
10	P	-
11	LG	-

12	B	GND
13	GR	SOUND SIGNAL REAR SPEAKER LH (+)
14	L	SOUND SIGNAL REAR DOOR SPEAKER RH (+)



Terminal No.	Color of Wire	Signal Name [Specification]
15	R	SOUND SIGNAL REAR DOOR SPEAKER LH (-)
16	B/R	SOUND SIGNAL WOOFER (+)
17	W/R	SOUND SIGNAL WOOFER (-)
18	W	SOUND SIGNAL FRONT DOOR SPEAKER LH (+)
19	B	SOUND SIGNAL FRONT DOOR SPEAKER LH (-)
20	SB	AMP. ON SIGNAL
21	SHIELD	SHIELD
22	W	WOOFER AMP. ON SIGNAL
23	W/L	SOUND SIGNAL REAR LH (-)
24	GR/V	SOUND SIGNAL REAR LH (+)
25	W/L	SOUND SIGNAL REAR RH (-)

Connector No.	B15
Connector Name	FRONT DOOR SPEAKER LH (WITH BOSE SYSTEM)
Connector Type	NS02FBR-CS

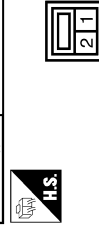

Terminal No.	Color of Wire	Signal Name [Specification]
1	L	- [Type A]
1	W	- [Type B]
2	B/W	- [Type A]
2	B	- [Type B]

Connector No.	B225
Connector Name	BOSE AMP.
Connector Type	SCA12FER-SG44

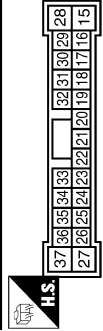

26	GR/V	SOUND SIGNAL REAR RH (+)
28	G	SOUND SIGNAL REAR DOOR SPEAKER LH (+)
29	V	SOUND SIGNAL CENTER SPEAKER (+)
30	P	SOUND SIGNAL CENTER SPEAKER (-)
31	BR	SOUND SIGNAL FRONT DOOR SPEAKER RH (+)
32	Y	SOUND SIGNAL FRONT DOOR SPEAKER RH (-)
33	W/R	SOUND SIGNAL FRONT RH (+)
34	B/R	SOUND SIGNAL FRONT RH (-)
35	W/R	SOUND SIGNAL FRONT LH (+)
36	B/R	SOUND SIGNAL FRONT LH (-)

Connector No.	D21
Connector Name	WIRE TO WIRE
Connector Type	TH4DFW-CS15

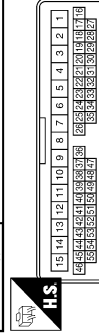

Terminal No.	Color of Wire	Signal Name [Specification]
4	B/W	- [Type A]
4	B	- [Type B]
5	L	- [Type A]
5	W	- [Type B]

JCNWM1845GI

A
B
C
D
E
F
G
H
I
J
K
L
M
N
O
P

AV

CAMERA CONTROL UNIT

< ECU DIAGNOSIS >

[BOSE AUDIO WITH NAVIGATION]

BOSE AUDIO WITH NAVIGATION SYSTEM

Connector No.	D41
Connector Name	WIRE TO WIRE
Connector Type	TH40PW-CS15

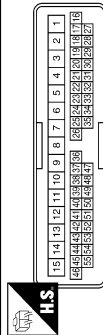

Terminal No.	Color of Wire	Signal Name [Specification]
4	B/R	-[Type A]
4	B	-[Type B]
5	BR	-[Type A]
5	W	-[Type B]

Connector No.	D53
Connector Name	FRONT DOOR SPEAKER RH (WITH BOSE SYSTEM)
Connector Type	NS02FBR-CS



Terminal No.	Color of Wire	Signal Name [Specification]
1	BR	-[Type A]
1	W	-[Type B]
2	B/R	-[Type A]
2	B	-[Type B]

Connector No.	D81
Connector Name	WIRE TO WIRE
Connector Type	TK10MW-NS8

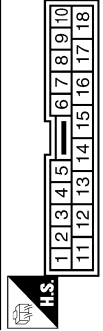

Terminal No.	Color of Wire	Signal Name [Specification]
4	L	-
5	W	-

Connector No.	DB6
Connector Name	REAR DOOR SPEAKER LH (WITH BOSE SYSTEM)
Connector Type	NS02FBR-CS



Terminal No.	Color of Wire	Signal Name [Specification]
1	L	-
2	W	-

Connector No.	D106
Connector Name	REAR DOOR SPEAKER RH (WITH BOSE SYSTEM)
Connector Type	NS02FBR-CS

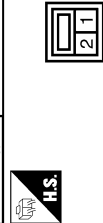

Terminal No.	Color of Wire	Signal Name [Specification]
1	O	-[Type A]
1	L	-[Type B]
2	B/P	-[Type A]
2	W	-[Type B]

Connector No.	D155
Connector Name	WIRE TO WIRE
Connector Type	TK10MW-NS8

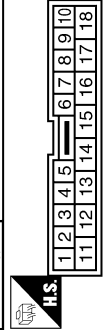

Terminal No.	Color of Wire	Signal Name [Specification]
4	O	-[Type A]
4	L	-[Type B]
5	B/P	-[Type A]
5	W	-[Type B]

Connector No.	D182
Connector Name	WIRE TO WIRE
Connector Type	TK12FW

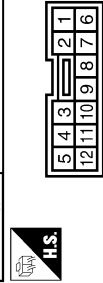

Terminal No.	Color of Wire	Signal Name [Specification]
6	R	-
7	G	-
8	B	-
9	SHIELD	-

Connector No.	D192
Connector Name	REAR VIEW CAMERA
Connector Type	TH40MW-NH



Terminal No.	Color of Wire	Signal Name [Specification]
1	R	CAMERA ON SIGNAL
2	G	GND
3	B	CAMERA IMAGE SIGNAL
4	SHIELD	SHIELD







JCNWM1846GI

CAMERA CONTROL UNIT

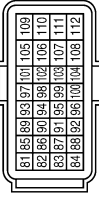
< ECU DIAGNOSIS >

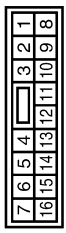
[BOSE AUDIO WITH NAVIGATION]

BOSE AUDIO WITH NAVIGATION SYSTEM

<table border="1"> <tr><td>Connector No.</td><td>E6</td></tr> <tr><td>Connector Name</td><td>WIRE TO WIRE</td></tr> <tr><td>Connector Type</td><td>TK16MGY-TV</td></tr> </table>  <table border="1"> <tr><td>Terminal No.</td><td>Color of Wire</td><td>Signal Name [Specification]</td></tr> <tr><td>4</td><td>R</td><td>-</td></tr> </table>	Connector No.	E6	Connector Name	WIRE TO WIRE	Connector Type	TK16MGY-TV	Terminal No.	Color of Wire	Signal Name [Specification]	4	R	-	<table border="1"> <tr><td>Connector No.</td><td>E16</td></tr> <tr><td>Connector Name</td><td>ECM</td></tr> <tr><td>Connector Type</td><td>RH2FEB-RZ8-L-LH</td></tr> </table>  <table border="1"> <tr><td>Terminal No.</td><td>Color of Wire</td><td>Signal Name [Specification]</td></tr> <tr><td>97</td><td>P</td><td>VEHGAN-L</td></tr> <tr><td>98</td><td>L</td><td>VEHGAN-H</td></tr> </table>	Connector No.	E16	Connector Name	ECM	Connector Type	RH2FEB-RZ8-L-LH	Terminal No.	Color of Wire	Signal Name [Specification]	97	P	VEHGAN-L	98	L	VEHGAN-H	<table border="1"> <tr><td>Connector No.</td><td>E18</td></tr> <tr><td>Connector Name</td><td>BACK-UP LAMP RELAY</td></tr> <tr><td>Connector Type</td><td>MS22FL-M2-LC</td></tr> </table>  <table border="1"> <tr><td>Terminal No.</td><td>Color of Wire</td><td>Signal Name [Specification]</td></tr> <tr><td>1</td><td>LG</td><td>-</td></tr> <tr><td>2</td><td>R</td><td>-</td></tr> <tr><td>3</td><td>LG</td><td>-</td></tr> <tr><td>5</td><td>R</td><td>-</td></tr> </table>	Connector No.	E18	Connector Name	BACK-UP LAMP RELAY	Connector Type	MS22FL-M2-LC	Terminal No.	Color of Wire	Signal Name [Specification]	1	LG	-	2	R	-	3	LG	-	5	R	-	<table border="1"> <tr><td>Connector No.</td><td>E27</td></tr> <tr><td>Connector Name</td><td>PARKING BRAKE SWITCH</td></tr> <tr><td>Connector Type</td><td>PO1FB-A</td></tr> </table>  <table border="1"> <tr><td>Terminal No.</td><td>Color of Wire</td><td>Signal Name [Specification]</td></tr> <tr><td>1</td><td>P</td><td>-</td></tr> </table>	Connector No.	E27	Connector Name	PARKING BRAKE SWITCH	Connector Type	PO1FB-A	Terminal No.	Color of Wire	Signal Name [Specification]	1	P	-															
Connector No.	E6																																																																													
Connector Name	WIRE TO WIRE																																																																													
Connector Type	TK16MGY-TV																																																																													
Terminal No.	Color of Wire	Signal Name [Specification]																																																																												
4	R	-																																																																												
Connector No.	E16																																																																													
Connector Name	ECM																																																																													
Connector Type	RH2FEB-RZ8-L-LH																																																																													
Terminal No.	Color of Wire	Signal Name [Specification]																																																																												
97	P	VEHGAN-L																																																																												
98	L	VEHGAN-H																																																																												
Connector No.	E18																																																																													
Connector Name	BACK-UP LAMP RELAY																																																																													
Connector Type	MS22FL-M2-LC																																																																													
Terminal No.	Color of Wire	Signal Name [Specification]																																																																												
1	LG	-																																																																												
2	R	-																																																																												
3	LG	-																																																																												
5	R	-																																																																												
Connector No.	E27																																																																													
Connector Name	PARKING BRAKE SWITCH																																																																													
Connector Type	PO1FB-A																																																																													
Terminal No.	Color of Wire	Signal Name [Specification]																																																																												
1	P	-																																																																												
<table border="1"> <tr><td>Connector No.</td><td>E104</td></tr> <tr><td>Connector Name</td><td>WIRE TO WIRE</td></tr> <tr><td>Connector Type</td><td>NS16FW-CS</td></tr> </table>  <table border="1"> <tr><td>Terminal No.</td><td>Color of Wire</td><td>Signal Name [Specification]</td></tr> <tr><td>4</td><td>R</td><td>-</td></tr> <tr><td>5</td><td>L</td><td>-</td></tr> <tr><td>6</td><td>P</td><td>-</td></tr> <tr><td>7</td><td>L</td><td>-</td></tr> </table>	Connector No.	E104	Connector Name	WIRE TO WIRE	Connector Type	NS16FW-CS	Terminal No.	Color of Wire	Signal Name [Specification]	4	R	-	5	L	-	6	P	-	7	L	-	<table border="1"> <tr><td>Connector No.</td><td>E105</td></tr> <tr><td>Connector Name</td><td>WIRE TO WIRE</td></tr> <tr><td>Connector Type</td><td>TH70MW-CS10-M3</td></tr> </table>  <table border="1"> <tr><td>Terminal No.</td><td>Color of Wire</td><td>Signal Name [Specification]</td></tr> <tr><td>5</td><td>LG</td><td>-</td></tr> <tr><td>22</td><td>P</td><td>-</td></tr> <tr><td>47</td><td>P</td><td>-</td></tr> <tr><td>48</td><td>L</td><td>-</td></tr> <tr><td>75</td><td>BR</td><td>-</td></tr> <tr><td>76</td><td>GR</td><td>-</td></tr> <tr><td>78</td><td>V</td><td>-</td></tr> </table>	Connector No.	E105	Connector Name	WIRE TO WIRE	Connector Type	TH70MW-CS10-M3	Terminal No.	Color of Wire	Signal Name [Specification]	5	LG	-	22	P	-	47	P	-	48	L	-	75	BR	-	76	GR	-	78	V	-	<table border="1"> <tr><td>Connector No.</td><td>F23</td></tr> <tr><td>Connector Name</td><td>TCM (TRANSMISSION CONTROL MODULE)</td></tr> <tr><td>Connector Type</td><td>RH40FB-RZ8-L-RH</td></tr> </table>  <table border="1"> <tr><td>Terminal No.</td><td>Color of Wire</td><td>Signal Name [Specification]</td></tr> <tr><td>19</td><td>G/B</td><td>REV LAMP RELAY</td></tr> </table>	Connector No.	F23	Connector Name	TCM (TRANSMISSION CONTROL MODULE)	Connector Type	RH40FB-RZ8-L-RH	Terminal No.	Color of Wire	Signal Name [Specification]	19	G/B	REV LAMP RELAY	<table border="1"> <tr><td>Connector No.</td><td>F123</td></tr> <tr><td>Connector Name</td><td>WIRE TO WIRE</td></tr> <tr><td>Connector Type</td><td>TK16FGY-TV</td></tr> </table>  <table border="1"> <tr><td>Terminal No.</td><td>Color of Wire</td><td>Signal Name [Specification]</td></tr> <tr><td>4</td><td>G/B</td><td>-</td></tr> </table>	Connector No.	F123	Connector Name	WIRE TO WIRE	Connector Type	TK16FGY-TV	Terminal No.	Color of Wire	Signal Name [Specification]	4	G/B	-
Connector No.	E104																																																																													
Connector Name	WIRE TO WIRE																																																																													
Connector Type	NS16FW-CS																																																																													
Terminal No.	Color of Wire	Signal Name [Specification]																																																																												
4	R	-																																																																												
5	L	-																																																																												
6	P	-																																																																												
7	L	-																																																																												
Connector No.	E105																																																																													
Connector Name	WIRE TO WIRE																																																																													
Connector Type	TH70MW-CS10-M3																																																																													
Terminal No.	Color of Wire	Signal Name [Specification]																																																																												
5	LG	-																																																																												
22	P	-																																																																												
47	P	-																																																																												
48	L	-																																																																												
75	BR	-																																																																												
76	GR	-																																																																												
78	V	-																																																																												
Connector No.	F23																																																																													
Connector Name	TCM (TRANSMISSION CONTROL MODULE)																																																																													
Connector Type	RH40FB-RZ8-L-RH																																																																													
Terminal No.	Color of Wire	Signal Name [Specification]																																																																												
19	G/B	REV LAMP RELAY																																																																												
Connector No.	F123																																																																													
Connector Name	WIRE TO WIRE																																																																													
Connector Type	TK16FGY-TV																																																																													
Terminal No.	Color of Wire	Signal Name [Specification]																																																																												
4	G/B	-																																																																												

JCNWM1847GI

A
B
C
D
E
F
G
H
I
J
K
L
M
AV
O
P

CAMERA CONTROL UNIT

[BOSE AUDIO WITH NAVIGATION]

< ECU DIAGNOSIS >

BOSE AUDIO WITH NAVIGATION SYSTEM

Connector No.	M1
Connector Name	FUSE BLOCK (J/B)
Connector Type	NS06FW-M2

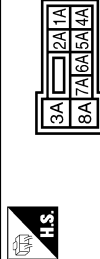

Terminal No.	Color of Wire	Signal Name [Specification]
2A	G	-
5A	R	-

Connector No.	M3
Connector Name	FUSE BLOCK (J/B)
Connector Type	NS12FW-CS



Terminal No.	Color of Wire	Signal Name [Specification]
12C	O	-

Connector No.	M4
Connector Name	DATA LINK CONNECTOR
Connector Type	BD16FW

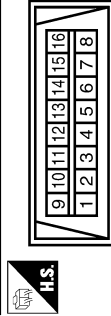

Terminal No.	Color of Wire	Signal Name [Specification]
6	L	-
14	P	-

Connector No.	M11
Connector Name	WIRE TO WIRE
Connector Type	TH170FW-CS17-M3

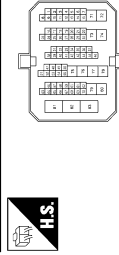

Terminal No.	Color of Wire	Signal Name [Specification]
5	O	-
22	G	-
47	P	-
48	L	-
75	BR	-
76	R	-
78	Y	-

Connector No.	M1B
Connector Name	WIRE TO WIRE
Connector Type	TH40MW-CS15

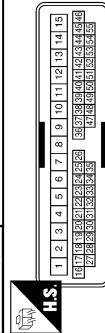

Terminal No.	Color of Wire	Signal Name [Specification]
4	W	-
5	BR	- [Type A and without BOSE system type B]
5	B	- [With BOSE system type B]

Connector No.	M20
Connector Name	WIRE TO WIRE
Connector Type	TH40MW-CS15

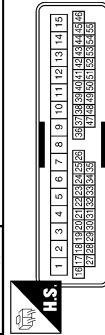

Terminal No.	Color of Wire	Signal Name [Specification]
4	B	-
5	L	-

Connector No.	M22
Connector Name	WIRE TO WIRE
Connector Type	TH12FW-NH

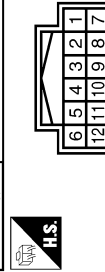

Terminal No.	Color of Wire	Signal Name [Specification]
1	V	-
2	R	-
3	R	-
4	G	-
5	W	-
6	SHIELD	-
7	LG	-
8	SHIELD	-
9	BR	-
10	SHIELD	-
11	L	-

CAMERA CONTROL UNIT

[BOSE AUDIO WITH NAVIGATION]

< ECU DIAGNOSIS >

BOSE AUDIO WITH NAVIGATION SYSTEM

Connector No.	M23
Connector Name	WIRE TO WIRE
Connector Type	TH18MW-NH

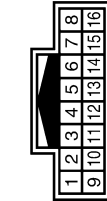

Terminal No.	Color of Wire	Signal Name [Specification]
1	W	-
2	SHIELD	[With telephone and navigation system]
3	B	-

Connector No.	M30
Connector Name	STEERING ANGLE SENSOR
Connector Type	TH08FW-NH

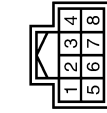

Terminal No.	Color of Wire	Signal Name [Specification]
1	B	-
3	L	-
4	G	-
6	SB	-
8	O	-

Connector No.	M33
Connector Name	COMBINATION SWITCH (SPIRAL CABLE)
Connector Type	TK08FGY-IV

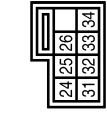

Terminal No.	Color of Wire	Signal Name [Specification]
24	BR	[With audio steering switch and telephone]
31	G	[With audio steering switch and telephone]
33	L	[With audio steering switch and telephone]

Connector No.	M34
Connector Name	COMBINATION METER
Connector Type	TH40FW-NH

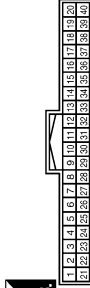

Terminal No.	Color of Wire	Signal Name [Specification]
21	L	CAN-H
22	P	CAN-L
31	V	VEHICLE SPEED (8-PULSE)

Connector No.	M44
Connector Name	WIRE TO WIRE
Connector Type	TH22FW-NH

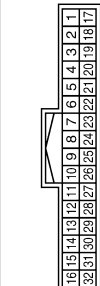

Terminal No.	Color of Wire	Signal Name [Specification]
1	G	-
2	R	-
3	SHIELD	-
4	B	-
5	W	-
6	SHIELD	-
7	O	- [Type A]
7	L	- [Type B]
8	SB	- [Type A]
8	R	- [Type B]
9	SHIELD	-

Connector No.	M49
Connector Name	FRONT DISPLAY UNIT
Connector Type	TH24FW-NH



Terminal No.	Color of Wire	Signal Name [Specification]
1	B	GND
2	Y	BATTERY[With navigation system]
3	R	ACC[With navigation system]
4	SHIELD	SHIELD[With navigation system]
5	B	AUX IMAGE GND[With navigation system]
6	R	RGB (GREEN) SIGNAL[With navigation system]
7	SHIELD	SHIELD
8	B	HPI[With navigation system]
9	W	RGB AREA (YS) SIGNAL
11	R	COMM (CONT->DISP)
12	W	CAMERA IMAGE SIGNAL

Terminal No.	Color of Wire	Signal Name [Specification]
13	B	GND[With navigation system]
14	SHIELD	SHIELD[With navigation system]
15	Y	AUX IMAGE SIGNAL[With navigation system]
17	G	RGB (RED) SIGNAL
18	W	RGB (BLUE) SIGNAL[With navigation system]
19	B	RGB SYNC
20	R	VP
21	SHIELD	SHIELD
22	G	COMM (DISP->CONT)
23	SHIELD	SHIELD

JCNWM1849GI

A
B
C
D
E
F
G
H
I
J
K
L
M
N
O
P

AV

CAMERA CONTROL UNIT

< ECU DIAGNOSIS >

[BOSE AUDIO WITH NAVIGATION]

BOSE AUDIO WITH NAVIGATION SYSTEM

Connector No.	M65
Connector Name	FRONT SQUAWKER LH
Connector Type	TK02FBR



Terminal No.	Color of Wire	Signal Name [Specification]
1	LG	- [With BOSE system]
2	Y	- [With BOSE system]

Connector No.	M66
Connector Name	CENTER SPEAKER
Connector Type	TK02FBR



Terminal No.	Color of Wire	Signal Name [Specification]
1	P	-
2	O	-

Connector No.	M67
Connector Name	FRONT SQUAWKER RH
Connector Type	TK02FBR



Terminal No.	Color of Wire	Signal Name [Specification]
1	BR	-
2	R	- [With BOSE system]

Connector No.	M77
Connector Name	WIRE TO WIRE
Connector Type	TH80FW-CS19

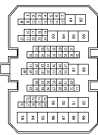

Terminal No.	Color of Wire	Signal Name [Specification]
41	O	-
42	SB	-
43	L	-
44	V	-
45	P	-
46	R	-
47	Y	-
48	L	-
49	G	-
50	SHIELD	-
51	W	-

56	P	-
57	L	-
58	SB	-
66	L	-
67	R	-

Connector No.	M97
Connector Name	WIRE TO WIRE
Connector Type	TH18FW-GS2

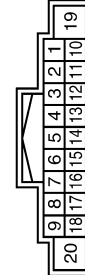

Terminal No.	Color of Wire	Signal Name [Specification]
5	SHIELD	-
6	W	-
8	B	-
9	Y	-
14	R	-
15	B	-
17	SHIELD	-
18	B	- [Type A and With navigation system type B]

Connector No.	M122
Connector Name	BCM (BODY CONTROL MODULE)
Connector Type	TH40FB-NH



Terminal No.	Color of Wire	Signal Name [Specification]
90	P	CAN-L
91	L	CAN-H

JCNWM1850GI

CAMERA CONTROL UNIT

< ECU DIAGNOSIS >

[BOSE AUDIO WITH NAVIGATION]

BOSE AUDIO WITH NAVIGATION SYSTEM

Connector No.	M124		
Connector Name	WIRE TO WIRE	LG	R
Connector Type	MS12BFW-CS		

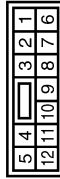

Terminal No.	Color of Wire	Signal Name [Specification]
1	P	-
2	BR	- [Type A]
3	L	- [Type B]
4	Y	-
5	BR	-
6	O	-
7	W	-
8	B	-
9	R	-
10	BR	-

Connector No.	M144
Connector Name	AV CONTROL UNIT (WITH NAVIGATION SYSTEM)
Connector Type	TH18FW-CS2



Terminal No.	Color of Wire	Signal Name [Specification]
1	P	AMP ON SIGNAL
2	G	SOUND SIGNAL FRONT LH (+)
3	R	SOUND SIGNAL FRONT LH (-)
4	O	SOUND SIGNAL REAR LH (+) [Type A]
5	SB	SOUND SIGNAL REAR LH (+) [Type B]
6	R	SOUND SIGNAL REAR LH (-) [Type A]
7	R	SOUND SIGNAL REAR LH (-) [Type B]
8	BR	STRG SW A
9	R	ACC
10	SHIELD	ILLUMINATION SHIELD

Connector No.	M125
Connector Name	MULTIFUNCTION SWITCH
Connector Type	TH18FW-NH

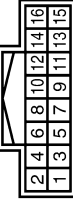

Terminal No.	Color of Wire	Signal Name [Specification]
1	B	GND
3	R	ACC
6	R	AV COMM (H)
8	L	AV COMM (L)
9	V	SW GND
14	W	EJECT SIGNAL

Connector No.	M145
Connector Name	AV CONTROL UNIT (WITH NAVIGATION SYSTEM)
Connector Type	TH40FW-NH



Terminal No.	Color of Wire	Signal Name [Specification]
21	B	GND
22	Y	BATTERY
23	B	GND
24	Y	BATTERY
25	R	ACC
26	B	MICROPHONE VCC
27	SHIELD	MICROPHONE GND
28	W	MICROPHONE SIGNAL
35	G	IGNITION
36	G	PARKING BRAKE
37	SB	REVERSE

38	V	VEHICLE SPEED (8-PULSE)
40	P	CONNECTION RECOGNITION
42	B	CONTROL SIGNAL
43	B	CONTROL SIGNAL
48	G	AV COMM (H)
49	L	AV COMM (L)
50	R	AV COMM (H)
51	L	AV COMM (L)
52	L	CAN-H
53	P	CAN-L

A
B
C
D
E
F
G
H
I
J
K
L
M
N
O
P

AV

CAMERA CONTROL UNIT

[BOSE AUDIO WITH NAVIGATION]

< ECU DIAGNOSIS >

BOSE AUDIO WITH NAVIGATION SYSTEM

Connector No.	M146
Connector Name	AV CONTROL UNIT (WITH NAVIGATION SYSTEM)
Connector Type	TH12FW-NH



62	64	66	68	70	72
61	63	65	67	69	71

Terminal No.	Color of Wire	Signal Name [Specification]
61	G	RGB (R/RED) SIGNAL
62	R	RGB (G/GREEN) SIGNAL
63	W	RGB (B/BLUE) SIGNAL
64	SHIELD	SHIELD
65	B	RGB SYNC
66	SHIELD	SHIELD
67	W	RGB AREA (VS) SIGNAL
68	B	HP
69	R	VP
70	R	COMM (CONT->DISP)
71	G	COMM (DISP->CONT)

Connector No.	M148
Connector Name	POD ADAPTER
Connector Type	TH12FW-NH



1	2	3	4	5	6	7	8	9	10	11	12
13	14	15	16	17	18	19	20	21	22	23	24

Terminal No.	Color of Wire	Signal Name [Specification]
1	BR	POD SOUND SIGNAL LH (+)
2	R	POD SOUND SIGNAL RH (+)
3	R	ACC
4	L	AV COMM (L)
5	Y	BATTERY
8	W	CHARGE POWER
9	G	COMM (POD ADAPTER->IPOD)
10	R	COMM (IPOD->POD ADAPTER)
11	R	ACCESSORY IDENTITY
12	V	POD SOUND SIGNAL RH (+)
13	L	POD SOUND SIGNAL LH (-)

72	SHIELD	SHIELD
----	--------	--------

Connector No.	M147
Connector Name	AV CONTROL UNIT (WITH NAVIGATION SYSTEM)
Connector Type	TH12FW-NH



73	74	75	76	77	78	79	80	81	82	83	84	85	86	87	88
89	90	91	92	93	94	95	96	97	98	99	100	101	102	103	104

Terminal No.	Color of Wire	Signal Name [Specification]
79	BR	POD SOUND SIGNAL LH (+)
80	R	POD SOUND SIGNAL RH (+)
81	SHIELD	SHIELD
85	W	EJECT SIGNAL
86	SHIELD	SHIELD
87	B	AUX SOUND SIGNAL LH (+)
88	W	AUX SOUND SIGNAL GND
93	L	POD SOUND SIGNAL LH (-)
96	W	POD SOUND SIGNAL RH (-)
102	V	SW GND
103	R	AUX SOUND SIGNAL RH (+)

Connector No.	M204
Connector Name	WIRE TO WIRE
Connector Type	TH12MW-NH



1	2	3	4	5	6
7	8	9	10	11	12

Terminal No.	Color of Wire	Signal Name [Specification]
1	V	-
2	R	-
3	R	-
4	G	-
5	W	-
6	SHIELD	-
7	LG	-
8	SHIELD	-
9	BR	-
10	SHIELD	-
11	L	-

12	R	-
----	---	---

CAMERA CONTROL UNIT

< ECU DIAGNOSIS >

[BOSE AUDIO WITH NAVIGATION]

BOSE AUDIO WITH NAVIGATION SYSTEM

Connector No.	M251
Connector Name	WIRE TO WIRE
Connector Type	TH18MW-CS2

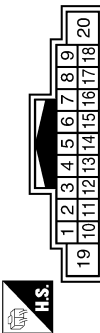

Connector No.	M253
Connector Name	AUXILIARY INPUT JACKS
Connector Type	AB8FW

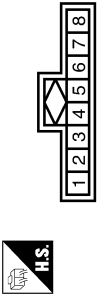

Connector No.	M260
Connector Name	iPod SIDE
Connector Type	IP18FGY

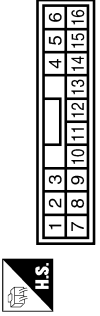

Connector No.	M263
Connector Name	COMBINATION SWITCH (SPIRAL CABLE)
Connector Type	TK08FGY



Terminal No.	Color of Wire	Signal Name [Specification]
5	SHIELD	
6	W	
8	SHIELD	
9	G	
14	R	
15	B	
17	SHIELD	
18	R	

Terminal No.	Color of Wire	Signal Name [Specification]
1	R	SOUND SIGNAL RH (+)
2	W	SOUND SIGNAL GND
3	B	SOUND SIGNAL LH (+) [Without DVD player]
7	G	AUX IMAGE SIGNAL
8	R	AUX IMAGE GND [Without DVD player]

Terminal No.	Color of Wire	Signal Name [Specification]
1	LG	iPod SOUND SIGNAL LH (+)
2	R	iPod SOUND SIGNAL GND
5	R	COMM (iPod->iPod ADAPTER)
6	G	COMM (iPod ADAPTER->iPod)
7	V	iPod SOUND SIGNAL RH (+)
9	L	iPod CONNECTION RECOGNITION
10	SHIELD	GND
12	W	CHARGE POWER
14	SHIELD	SHIELD
15	BR	ACCESSORY DETECT
16	R	ACCESSORY IDENTITY

Connector No.	M371
Connector Name	AV CONTROL UNIT (WITH NAVIGATION SYSTEM)
Connector Type	GT13SC-2/1S-HU



Connector No.	M372
Connector Name	AV CONTROL UNIT (WITH NAVIGATION SYSTEM)
Connector Type	FAKRA



Connector No.	M373
Connector Name	WIRE TO WIRE
Connector Type	GT16C-1PP-HU



Connector No.	M374
Connector Name	WIRE TO WIRE
Connector Type	GT16C-1PP-HU



Terminal No.	Color of Wire	Signal Name [Specification]
105	-	FM SUB
106	-	AM-FM MAIN
107	-	ANTENNA AMP. ON SIGNAL

Terminal No.	Color of Wire	Signal Name [Specification]
108	-	SATELLITE ANTENNA

Terminal No.	Color of Wire	Signal Name [Specification]
1	-	
2	-	

Terminal No.	Color of Wire	Signal Name [Specification]
1	-	
2	-	

JCNWM1853GI

A
B
C
D
E
F
G
H
I
J
K
L
M
O
P

AV

CAMERA CONTROL UNIT

< ECU DIAGNOSIS >

[BOSE AUDIO WITH NAVIGATION]

BOSE AUDIO WITH NAVIGATION SYSTEM

Connector No.	M378
Connector Name	ANTENNA BASE (ANTENNA AMP.)
Connector Type	GT13SSN-1/1PP-HU



Terminal No.	Color of Wire	Signal Name [Specification]
1	-	-
2	-	-
3	-	-

Connector No.	M377
Connector Name	ANTENNA BASE (SATELLITE ANTENNA) (WITH NAVIGATION SYSTEM)
Connector Type	GT16C-1PP-HU



Terminal No.	Color of Wire	Signal Name [Specification]
1	-	SATELLITE ANTENNA

Connector No.	M376
Connector Name	WIRE TO WIRE
Connector Type	GT13SON-2/1PP-HU



Terminal No.	Color of Wire	Signal Name [Specification]
1	-	-
2	-	-
3	-	-

Connector No.	M375
Connector Name	WIRE TO WIRE
Connector Type	GT13SH-2/1S-HU



Terminal No.	Color of Wire	Signal Name [Specification]
1	-	-
2	-	-
3	-	-

Connector No.	R20
Connector Name	MICROPHONE
Connector Type	TKQ4FW



Terminal No.	Color of Wire	Signal Name [Specification]
1	R/W	MICROPHONE SIGNAL (+)
2	SHIELD	SHIELD (with telephone and navigation system)
4	B	MICROPHONE POWER

Connector No.	R1
Connector Name	WIRE TO WIRE
Connector Type	TH16FW-NH



Terminal No.	Color of Wire	Signal Name [Specification]
1	R/W	-
2	SHIELD	- (with telephone and navigation system)
3	B	-

Connector No.	M880
Connector Name	AV CONTROL UNIT (WITH NAVIGATION SYSTEM)
Connector Type	GT5-1S-HU



Terminal No.	Color of Wire	Signal Name [Specification]
110	-	GPS ANTENNA
111	-	SHIELD

Connector No.	M379
Connector Name	GLASS ANTENNA
Connector Type	GT13SON-1/1PP-HU



Terminal No.	Color of Wire	Signal Name [Specification]
2	-	FM SUB

JCNWM1854GI

MULTI AV SYSTEM SYMPTOMS

[BOSE AUDIO WITH NAVIGATION]

< SYMPTOM DIAGNOSIS >

SYMPTOM DIAGNOSIS

MULTI AV SYSTEM SYMPTOMS

Symptom Table

INFOID:000000003356688

RELATED TO NAVIGATION

Trouble diagnosis chart by symptom

Symptoms	Check items	Possible malfunction location / Action to take
Multifunction switch and preset switch operation does not work.	<ul style="list-style-type: none"> All switches cannot be operated. "MULTI AV" is displayed on system selection screen when the CONSULT-III is started. 	<ul style="list-style-type: none"> Multifunction switch power supply and ground circuit. AV communication circuit between AV control unit and multifunction switch. Perform CONSULT-III self-diagnosis. Refer to AV-589, "CONSULT-III Function (MULTI AV)" .
	<ul style="list-style-type: none"> All switches cannot be operated. "MULTI AV" is not displayed on system selection screen when the CONSULT-III is initialized. 	AV control unit power supply and ground circuit malfunction. Refer to AV-619, "AV CONTROL UNIT : Diagnosis Procedure" .
	Only specified switch cannot be operated.	Multifunction switch or preset switch malfunction. Replace multifunction switch AV-534, "Exploded View" or preset switch AV-535, "Exploded View" .
Fuel economy display, vehicle setting operation is abnormal.	There is malfunction in the CONSULT-III self-diagnosis result.	Perform detected DTC self-diagnosis. Refer to AV-589, "CONSULT-III Function (MULTI AV)" .
	There is no malfunction in the self-diagnosis results.	Ignition signal circuit malfunction. Refer to AV-619, "AV CONTROL UNIT : Diagnosis Procedure" .
There is no guide sound	On the setting display select "system sound (guide sound volume, etc.)," and confirm that guide sound is ON.	AV control unit malfunction. Replace AV control unit. Refer to AV-764, "Exploded View" .

RELATED TO HANDS-FREE PHONE

- Check that the cellular phone is a corresponding type (Bluetooth™ correspondence) when the hands-free related malfunction vehicle is in service before performing a diagnosis.
- There is a case that malfunction occurs due to the version change of the phone type, etc. even though it is a corresponding type. Therefore, confirm it by changing the cellular phone to another corresponding type phone, and check that it operates normally. It is necessary to distinguish whether the cause is the vehicle or cellular phone.

Simple check for Bluetooth™ communication

If cellular phone and AV control unit cannot be connected with Bluetooth™ communication, the following procedure allows the technician to judge which device has a malfunction.

- Turn on the cellular phone, not connecting Bluetooth™ communication.
- Start CONSULT-III, then start Windows®.
- Set CONSULT-III near the cellular phone.
- When operating Bluetooth™ registration by cellular phone, check if CONSULT-III* is displayed on the device name.

(If another Bluetooth™ device is located near the cellular phone, the name of the device will also be displayed.)

NOTE:

*:Displayed device name is "NISSAN-*****".

- If no device name is displayed, cellular phone is malfunctioning. Repair the cellular phone first, then perform diagnosis.
- If CONSULT-III is displayed on device name, cellular phone is normal. Perform diagnosis as per the following table.

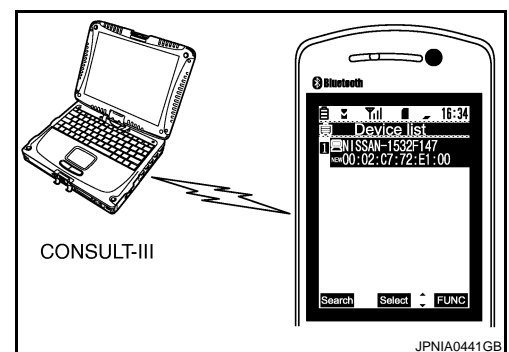

JPNIA0441GB

MULTI AV SYSTEM SYMPTOMS

[BOSE AUDIO WITH NAVIGATION]

< SYMPTOM DIAGNOSIS >

Trouble diagnosis chart by symptom

Symptoms	Check items	Probable malfunction location
Does not recognize cellular phone connection. (no connection is displayed on the display at the guide.)	Repeat the registration of cellular phone.	AV control unit malfunction. Replace AV control unit. Refer to AV-764, "Exploded View" .
Hands-free phone cannot be established.	<ul style="list-style-type: none"> Hands-free phone operation can be made, but the communication cannot be established. Hands-free phone operation can be performed, however, voice between each other cannot be heard during the conversation. 	AV control unit malfunction. Replace AV control unit. Refer to AV-764, "Exploded View" .
The other party's voice cannot be heard by hands-free phone.	Check the "microphone speaker" in Inspection & Adjustment Mode if sound is heard.	AV control unit malfunction. Replace AV control unit. Refer to AV-764, "Exploded View" .
	Check the "microphone speaker" in Inspection & Adjustment Mode if sound is not heard.	AV control unit malfunction. Replace AV control unit. Refer to AV-764, "Exploded View" .
Sound is not heard by the other party with hands-free phone communication.	Sound operation function is normal.	AV control unit malfunction. Replace AV control unit. Refer to AV-764, "Exploded View" .
	Sound operation function does not work.	Microphone signal circuit malfunction. Refer to AV-633, "Diagnosis Procedure" .

RELATED TO CAMERA

Trouble diagnosis chart by symptom

Symptoms	Check items	Probable malfunction location
Camera image is not displayed (displayed in black and nothing can be displayed)	AUX image is not displayed.	<ul style="list-style-type: none"> Horizontal synchronizing (HP) signal circuit malfunction between AV control unit and display unit. Refer to AV-629, "Diagnosis Procedure". Vertical synchronizing (VP) signal circuit malfunction between AV control unit and display unit. Refer to AV-630, "Diagnosis Procedure".
Camera image is not shown. (Vehicle width and possible route line is displayed.)	—	<ul style="list-style-type: none"> Camera image signal circuit between camera control unit and rear view camera. Refer to AV-635, "Diagnosis Procedure". Rear view camera ON signal circuit. Refer to AV-636, "Diagnosis Procedure".
Camera image is not displayed. (Only warning message under area is displayed.)	There is malfunction in the CONSULT-III self-diagnosis result.	Perform detected DTC self-diagnosis. Refer to AV-589, "CONSULT-III Function (MULTI AV)" .
	AUX image is normal.	Camera image signal circuit malfunction between camera control unit and front display unit. Refer to AV-637, "Diagnosis Procedure" .
	AUX image is not displayed.	RGB area (YS) signal circuit malfunction between AV control unit and front display unit. Refer to AV-628, "Diagnosis Procedure" .
	Select "Camera Cont." of confirmation/Adjustment mode, Reverse Sensor is not turned ON at "Connection Confirmation".	Reverse signal circuit malfunction (camera control unit).
CAMERA image is rolling.	AUX image is also rolling.	<ul style="list-style-type: none"> Horizontal synchronizing (HP) signal circuit malfunction between AV control unit and display unit. Refer to AV-629, "Diagnosis Procedure". Vertical synchronizing (VP) signal circuit malfunction between AV control unit and display unit. Refer to AV-630, "Diagnosis Procedure".

MULTI AV SYSTEM SYMPTOMS

[BOSE AUDIO WITH NAVIGATION]

< SYMPTOM DIAGNOSIS >

Symptoms	Check items	Probable malfunction location
Camera image does not switch.	Malfunction of self-diagnosis result is indicated.	Camera-connection recognition signal circuit malfunction between AV control unit and camera control unit. Refer to AV-616, "Diagnosis Procedure" .
	Malfunction of self-diagnosis result is not indicated.	Reverse signal circuit malfunction (AV control unit).
Possible route line is indicated abnormally when camera image is displayed.	—	Steering angle sensor signal circuit malfunction. Refer to AV-638, "Diagnosis Procedure" .

RELATED TO RGB IMAGE

Trouble diagnosis chart by symptom

Symptoms	Check items	Possible malfunction location / Action to take
RGB image is not shown.	<ul style="list-style-type: none"> All RGB images are not shown. "MULTI AV" is displayed on system selection screen when the CONSULT-III is started. 	Perform CONSULT-III self-diagnosis. Refer to AV-589, "CONSULT-III Function (MULTI AV)" .
	<ul style="list-style-type: none"> All RGB images are not shown. "MULTI AV" is not displayed on system selection screen when the CONSULT-III is started. 	AV control unit power supply and ground circuit malfunction. Refer to AV-619, "AV CONTROL UNIT : Diagnosis Procedure" .
Color of RGB image is not proper.	Light blue (Cyan) tint.	RGB signal (R: red) circuit malfunction between AV control unit and display unit. Refer to AV-624, "Diagnosis Procedure" .
	Purple (Magenta) tint.	RGB signal (G: green) circuit malfunction between AV control unit and display unit. Refer to AV-625, "Diagnosis Procedure" .
	Screen looks yellowish.	RGB signal (B: blue) circuit malfunction between AV control unit and display unit. Refer to AV-626, "Diagnosis Procedure" .
RGB screen is rolling.	—	RGB synchronizing signal circuit malfunction between AV control unit and front display unit. Refer to AV-627, "Diagnosis Procedure" .

RELATED TO VOICE CONTROL

Trouble diagnosis chart by symptom

Symptoms	Check items	Probable malfunction location
The voice cannot be controlled even if the voice control screen is displayed.	Voice sounds at "Voice Microphone Test" of Confirmation/Adjustment mode.	AV control unit malfunction. Replace AV control unit. Refer to AV-764, "Exploded View" .
	Voice does not sound at "Voice Microphone Test" of Confirmation/Adjustment mode.	Microphone circuit malfunction. Refer to AV-633, "Diagnosis Procedure" .
The voice cannot be controlled (Voice control screen is not displayed).	Steering switch "SOURCE", "MENU UP", "MENU DOWN", "ENTER" operates, but "↵" does not operate.	Steering switch malfunction. Replace steering switch. Refer to AV-775, "Removal and Installation" .
	Steering switch's "SOURCE", "MENU UP", "MENU DOWN", "↵", "ENTER" does not operate.	Steering switch signal A circuit malfunction. Refer to AV-640, "Diagnosis Procedure" .
	All steering switches do not work.	Steering switch signal GND circuit malfunction. Refer to AV-644, "Diagnosis Procedure" .

RELATED TO AUDIO

Trouble diagnosis chart by symptom

MULTI AV SYSTEM SYMPTOMS

[BOSE AUDIO WITH NAVIGATION]

< SYMPTOM DIAGNOSIS >

Symptoms	Check items	Possible malfunction location / Action to take
The CD cannot be removed.	—	Disk eject signal circuit malfunction between AV control unit and preset switch. Refer to AV-632, "Diagnosis Procedure" .
Audio sound is not heard.	No sound from all speakers.	<ul style="list-style-type: none"> • Amp. ON signal circuit. • BOSE amp. power supply and ground circuit. Refer to AV-621, "BOSE AMP. : Diagnosis Procedure" .
	There is no sound from the woofer.	<ul style="list-style-type: none"> • Woofer amp. power supply and ground circuit. • Sound signal woofer circuit between BOSE amp. and woofer. • Sound signal woofer circuit between BOSE amp. and woofer. • Woofer amp. ON signal circuit between BOSE amp. and woofer.
	There is no sound from the center speaker.	Sound signal center speaker circuit.
	There is sound only from specific places (RH front, RH rear, LH front and LH rear).	Sound signal circuit of suspect system.
Satellite radio is not received.	There is malfunction in the CONSULT-III self-diagnosis result.	Perform CONSULT-III self-diagnosis. Refer to AV-589, "CONSULT-III Function (MULTI AV)" .
	There is no malfunction in the CONSULT-III self-diagnosis result.	Perform the following inspection procedure. <ol style="list-style-type: none"> 1. Check antenna base mounting nut for looseness. NOTE: Tightening torque: 6.5 N·m (0.66 kg·m, 58 in·lb) 2. Visually check for satellite radio antenna feeder. 3. Replace the antenna base. Refer to AV-786, "Exploded View". 4. Replace the AV control unit. Refer to AV-764, "Exploded View".
AM/FM radio is not received.	Other audio sounds are normal.	<ul style="list-style-type: none"> • Antenna amp. ON signal circuit. • Antenna feeder.

RELATED TO iPod®

Trouble diagnosis chart by symptom

Connect another iPod® and check if the symptom is reproduced or not. If the symptom is reproduced, diagnose the vehicle. If no malfunction is detected, replace the iPod harness.

NOTE:

It is unable to read a connection between iPod® and iPod harness.

Trouble diagnosis chart by symptom

Symptoms	Check items	Possible malfunction location / Action to take
There is no sound from the iPod®.	Other audio sounds are normal.	<ul style="list-style-type: none"> • iPod sound signal circuit between AV control unit and iPod adapter. • iPod sound signal circuit between iPod® and iPod adapter.
It does not change to iPod mode.	There is malfunction in the CONSULT-III self-diagnosis.	Perform CONSULT-III self-diagnosis. Refer to AV-589, "CONSULT-III Function (MULTI AV)" .
"iPod is not connected" is displayed when it comes to iPod mode.	Connected to iPod®.	iPod connection recognition signal circuit between iPod® and iPod adapter.
iPod® cannot charge the battery.	—	iPod battery charge circuit between iPod® and iPod adapter.
The title of music file in the iPod® is not indicated.	—	Communication circuit between iPod® and iPod adapter.
Accessing the iPod® is unavailable from the vehicle.		

MULTI AV SYSTEM SYMPTOMS

< SYMPTOM DIAGNOSIS >

[BOSE AUDIO WITH NAVIGATION]

RELATED TO STEERING SWITCH

Trouble diagnosis chart by symptom

Trouble diagnosis chart by symptom

Symptoms	Probable malfunction location
None of the steering switch operations work.	Steering switch signal GND circuit malfunction. Refer to AV-644, "Diagnosis Procedure" .
Only specified switch (1) cannot be operated.	Steering switch malfunction. Refer to AV-775, "Exploded View" .
Steering switch's "SOURCE", "MENU UP", "MENU DOWN", "↖", "ENTER" switches do not work.	Steering switch signal A circuit malfunction. Refer to AV-640, "Diagnosis Procedure" .
Steering switch's "↷", "VOL UP", "VOL DOWN", "↶" switches do not work.	Steering switch signal B circuit malfunction. Refer to AV-642, "Diagnosis Procedure" .

RELATED TO AUXILIARY INPUT

NOTE:

Check that there is no malfunction of AUX equipment main body before performing a diagnosis.

Trouble diagnosis chart by symptom

Symptoms	Check items	Probable malfunction location
No vocal sound is heard when AUX mode is selected.	Vocal sound is heard when other modes are selected.	AUX sound signal circuit (auxiliary input jacks to AV control unit).
Image is not displayed when AUX mode is selected.	Camera image is displayed.	AUX image signal circuit malfunction. Refer to AV-631, "Diagnosis Procedure" .

A
B
C
D
E
F
G
H
I
J
K
L
M
O
P

AV

NORMAL OPERATING CONDITION

< SYMPTOM DIAGNOSIS >

[BOSE AUDIO WITH NAVIGATION]

NORMAL OPERATING CONDITION

Description

INFOID:000000003356689

NOTE:

- For Navigation system operation information, refer to Navigation system Owner's Manual.
- Vehicle operation information, refer to Owner's Manual.

BASIC OPERATIONS



Symptom	Possible cause	Possible solution
No image is displayed.	The brightness is at the lowest setting.	Adjust the brightness of the display.
	The systems in the video mode.	Press <DISC-AUX> to change the mode.
	The display is turned off.	Press <Day/Night> to turn on the display.
No voice guidance is available. Or The volume is too high or too low.	The volume is not set correctly, or it is turned off.	Adjust the volume of voice guidance.
	Voice guidance is not provided for certain streets (roads displayed in gray).	This is not a malfunction.
No map is displayed on the screen.	A screen other than map screen is displayed.	Press <MAP>.
The screen is too dim. The movement is slow.	The temperature in the interior of the vehicle is low.	Wait until the interior of the vehicle has warmed up.
Some pixels in the display are darker or brighter than others.	This condition is an inherent characteristic of liquid crystal displays.	This is not a malfunction.
Some menu items cannot be selected.	Some menu items become unavailable while the vehicle is driven.	Park the vehicle in a safe location, and then operate the navigation system.

NOTE:

Locations stored in the Address Book and other memory functions may be lost if the vehicle's battery is disconnected or becomes discharged. If this occurs, service the vehicle's battery as necessary and re-enter the information in the Address Book.

RELATED TO VOICE RECOGNITION

Related to Basic Operation

Symptom	Possible cause	Possible solution
The system does not recognize your command. or The system recognizes your command incorrectly	The interior of the vehicle is too noisy.	Close the windows or have other occupants quiet.
	The volume of your voice is too low.	Speak louder.
	The volume if your voice is too loud.	Speak softer.
	Your pronunciation is unclear.	Speak clearly.
	You are speaking before the voice recognition is ready	Press and release “  ” switch on the steering switch, and speak a command after the tone sounds.
	8 seconds or more have passed after you pressed and released “  ” switch on the steering switch.	Make sure to speak a command within 8 seconds after you press and release “  ” switch on the steering switch.
	Only a limited range of voice commands is usable for each screen.	Use a correct voice command appropriate for the current screen.
	The fan of the air conditioner is too loud.	If the air conditioner is set to “Auto”, the fan speed is automatically lowered and voice commands can be recognized more easily. Lower the fan speed as necessary or set the air conditioner to “Auto”.

Related to Item Choice

The system should respond correctly to all voice commands without difficulty. If problems are encountered, follow the solutions given in this guide for the appropriate error.

NORMAL OPERATING CONDITION

< SYMPTOM DIAGNOSIS >

[BOSE AUDIO WITH NAVIGATION]

Where the solutions are listed by number, try each solution in turn, starting with number one, until the problem is resolved.

Symptom/ error message	Solution
Displays "COMMAND NOT RECOGNIZED" or the system fails to interpret the command correctly.	1. Ensure that the command format is valid.
	2. Speak clearly without pausing between words and at a level appropriate to the ambient noise level.
	3. Ensure that the ambient noise level is not excessive, for example, windows open or defrost on. NOTE: If it is too noisy to use the phone, it is likely that voice commands will not be recognized.
	4. If optional words of the command have been omitted, then command should be tried with these in place.
The system consistently selects the wrong voicetag	1. Ensure that the voicetag requested matches what was originally stored. This can be confirmed by giving the "Addressbook" Directory or Phone Directory command.
	2. Replace one of the voicetags being confused with a different voicetag.

Related to Telephone

The system should respond correctly to all voice commands without difficulty. If problems are encountered, try the following solutions.

Where the solutions are listed by number, try each solution in turn, starting with number 1, until the problem is resolved.

Symptom	Solution
System fails to interpret the command correctly.	1. Ensure that the command is valid.
	2. Ensure that the command is spoken after the tone.
	3. Speak clearly without pausing between words and at level appropriate to the ambient noise level in the vehicle.
	4. Ensure that the ambient noise level is not excessive (for example, windows open or defroster on). NOTE: If it is too noisy to use the phone, it is likely that the voice commands will not be recognized.
	5. If more than one command was said at a time, try saying the commands separately.
	6. If the system consistently fails to recognize commands, the voice training procedure should be carried out to improve the recognition response for the speaker. See "Speaker adaptation (SA) mode" earlier in this section. Refer to "OWNER'S MANUAL".
The system consistently selects the wrong voicetag	1. Ensure that the phone book entry name requested matches what was originally stored. This can be confirmed by using the "List Names" command.
	2. Replace one of the names being confused with a new name.

RELATED TO AUDIO

- The majority of the audio malfunctions are the result of outside causes (bad CD/cassette, electromagnetic interference, etc.). Check the symptoms below to diagnose the malfunction.
- The vehicle itself can be a source of noise if noise prevention parts or electrical equipment is malfunctioning. Check if noise is caused and/or changed by engine speed, ignition switch turned to each position, and operation of each piece of electrical equipment, and then determine the cause.

NOTE:

- CD-R is not guaranteed to play because they can contain compressed audio (MP3, WMA) or could be incorrectly mastered by the customer on a computer.
- Check if the CDs carry the Compact Disc Logo. If not, the disc is not mastered to the "red book" Compact Disc Standard and may not play.

NORMAL OPERATING CONDITION

< SYMPTOM DIAGNOSIS >

[BOSE AUDIO WITH NAVIGATION]

Symptom	Cause and Counter measure
Cannot play	Check if the CD/CF was inserted correctly.
	Check if the CD/CF is scratched or dirty.
	Check if there is condensation inside the player, and if there is, wait until the condensation is gone (about 1 hour) before using the player.
	If there is a temperature increase error, the player will play correctly after it returns to the normal temperature.
	If there is a mixture of music CD files (CD-DA data) and MP3/WMA files on a CD, only the music CD files (CD-DA data) will be played.
	Files with extensions other than ".MP3", ".WMA", ".mp3", or ".wma" cannot be played. In addition, the character codes and number of characters for folder names and file names should be in compliance with the specifications.
	Check if the disc or the file is generated in an irregular format, This may occur depending on the variation or the setting of MP3/WMA writing applications or other text editing applications.
Poor sound quality	Check if the CD/CF is scratched or dirty.
	If there are many folder or file levels on the MP3/WMA CD/CF, or if it is a multisession disc, some time may be required before the music starts playing.
	The writing software and hardware combination might not match, or the writing speed, writing depth, writing width might not match the specifications. Try using the slowest writing speed.
	Skipping may occur with large quantities of data such as high bit rate data.
It takes a relatively long time before the music starts playing.	When a non-MP3/WMA file has been given an extension of ".MP3", ".WMA", ".mp3", or ".wma", or when play is prohibited by copyright protection, the player will skip to the next song.
Music cuts off or skips	The playback order is the order in which the files were written by the software, so the files might not play in the desired order.
Skipping with high bit rate files	
Move immediately to the next song when playing	
The songs do not play back in the desired order.	

Noise resulting from variations in field strength, such as fading noise and multi-path noise, or external noise from trains and other sources, is not a malfunction.

NOTE:

- Fading noise: This noise occurs because of variations in the field strength in a narrow range due to mountains or buildings blocking the signal.
- Multi-path noise: This noise results from a time difference between the broadcast waves directly from the station arriving at the antenna and the waves reflected by mountains or buildings.

RELATED TO VEHICLE ICON

Symptom	Possible cause	Possible solution
Names of roads differ between Plan View and Birdview™.	This is because the quantity of the displayed information is reduced so that the screen does not become too crowded. There is also a chance that names of the roads may be displayed multiple times, and the names appearing on the screen may be different because of a processing procedure.	This is not a malfunction.
The vehicle icon is not displayed in the correct position.	The vehicle was transported after the ignition switch was pressed off, for example, by a ferry or car transporter.	Drive the vehicle for a while on a road where GPS signals can be received.
	The position and direction of the vehicle icon may be incorrect depending on the driving environments and the levels of positioning accuracy of the navigation system.	This is not a malfunction. Drive the vehicle for a while to automatically correct the position and direction of the vehicle icon.
When the vehicle is traveling on a new road, the vehicle icon is located on another road nearby.	Because the new road is not stored in the map data, the system automatically places the vehicle icon on the nearest road available.	Updated road information will be included in the next version of the map data.

NORMAL OPERATING CONDITION

< SYMPTOM DIAGNOSIS >

[BOSE AUDIO WITH NAVIGATION]

Symptom	Possible cause	Possible solution
The screen does not switch to the night screen even after turning on the headlights.	The daytime screen was set the last time the headlights were turned on.	Set the screen to the night screen mode using <Day/Night> when you turn on the headlights.
The map does not scroll even when the vehicle is moving.	The current location map screen is not displayed.	Press <MAP>.
The vehicle icon is not displayed.	The current location map screen is not displayed.	Press <MAP>.
The location of the vehicle icon is misaligned from the actual position.	When using tire chains or replacing the tires, speed calculations based on the speed sensor may be incorrect.	Drive the vehicle for a while (at approximately 19 MPH for about 30 minutes) to automatically correct the vehicle icon position. If this does not correct the vehicle icon position, contact an INFINITI dealer.
	The map data has a mistake or is incomplete (the vehicle icon position is always misaligned in the same area).	Updated road information will be included in the next version of the map data.

RELATED TO ROUTE CALCULATION AND VISUAL GUIDANCE

Symptom	Possible cause	Possible solution
Waypoints are not included in the auto reroute calculation.	Waypoints that you have already passed are not included in the auto reroute calculation.	If you want to go to that waypoint again, you need to edit the route.
Route information is not displayed.	Route calculation has not yet been performed.	Set the destination and perform route calculation.
	You are not driving on the suggested route.	Drive on the suggested route.
	Route guidance is set to off.	Turn on route guidance.
	Route information is not provided for certain types of roads (roads displayed in gray).	This is not a malfunction.
The auto reroute calculation (or detour calculation) suggests the same route as the one previously suggested.	Route calculations took priority conditions into consideration, but the same route was calculated.	This is not a malfunction.
A waypoint cannot be added.	Five waypoints are already set on the route, including ones that you have already passed.	A maximum of 5 waypoints can be set on the route. If you want to go to 6 or more waypoints, perform route calculations multiple times as necessary.
The suggested route is not displayed.	Roads near the destination cannot be calculated.	Reset the destination to a main or ordinary road, and recalculate the route.
	The starting point and destination are too close.	Set a more distant destination.
	The starting point and destination are too far away.	Divide your trip by selecting one or two intermediate destinations, and perform route calculations multiple times.
	There are time restricted roads (by the day of the week, by time) near the current vehicle location or destination.	Set [Use Time Restricted Roads] to off.
The part of the route that you have already passed is deleted.	A route is managed by sections between waypoints. If you passed the first waypoint, the section between the starting point and the waypoint is deleted. (It may not be deleted depending on the area.)	This is not a malfunction.
An indirect route is suggested.	If there are restrictions (such as one-way streets) on roads close to the starting point or destination, the system may suggest an indirect route.	Adjust the location of the starting point or destination.
	The system may suggest an indirect route because route calculation does not take into consideration some areas such as narrow streets (gray roads.)	Reset the destination to a main or ordinary road, and recalculate the route.

NORMAL OPERATING CONDITION

< SYMPTOM DIAGNOSIS >

[BOSE AUDIO WITH NAVIGATION]

Symptom	Possible cause	Possible solution
The landmark information does not correspond to the actual information.	This may be caused by insufficient or incorrect map data.	Updated information will be included in the next version of the data.
The suggested route does not exactly connect to the starting point, waypoints, or destination.	There is no data for route calculation closes to these locations.	Set the starting point, waypoints and destination on a main road, and perform route calculation.

RELATED TO VOICE GUIDANCE

Symptom	Possible cause	Possible solution
Voice guidance is not available	Voice guidance is only available at certain intersections marked with? In some cases, voice guidance is not available even when the vehicle should make a turn.	This is not a malfunction.
	The vehicle has deviated from the suggested route.	Go back to the suggested route or request route calculation again
	Voice guidance is set to off.	Turn on voice guidance.
	Route guidance is set to off.	Turn on voice guidance.
The guidance contact does not correspond to the actual condition.	The contact of voice guidance may vary, depending on the types of intersections at which turn are made.	Follow all traffic rules and regulations.

RELATED TO TRAFFIC INFORMATION

Symptom	Possible cause	Possible solution
The traffic information is not displayed	The traffic information is not set to on.	Set the traffic information to on.
	You are in an area where traffic information is not available	Scroll to an area where traffic information is available
	You have not subscribed to XM NavTraffic or, your subscription to XM NavTraffic has expired.	Check your subscription status of XM NavTraffic.
	The map scale is set at a level where the display of icons is impossible.	Check that the map scale is set at a level in which the display of icons is possible.
With the automatic detour route search ON, no detour route is set to avoid congested areas.	There is no faster route compared to the current route, based on the road network and traffic information.	The automatic detour search is not intended for avoiding traffic jams. It searches for the fastest route taking into consideration such things as traffic jams.
The route does not avoid road section with traffic information stating it is closed due to road construction.	The navigation system is designed not to avoid this event because the actual period of closure may differ from the declared roadwork period.	Observe the actual road condition and follow the instructions on road for detour when necessary. If the road closure is for certain, use detour function and set the detour distance to avoid the closed road section.
Traffic information displayed differs from information from other media (e.g. radio).	Other media may use different information sources.	Observe the actual road conditions and regulations. Always observe safe driving practices and follow all traffic regulations.

PRECAUTION

PRECAUTIONS

Precaution for Supplemental Restraint System (SRS) "AIR BAG" and "SEAT BELT PRE-TENSIONER"

INFOID:000000003671424

The Supplemental Restraint System such as "AIR BAG" and "SEAT BELT PRE-TENSIONER", used along with a front seat belt, helps to reduce the risk or severity of injury to the driver and front passenger for certain types of collision. This system includes seat belt switch inputs and dual stage front air bag modules. The SRS system uses the seat belt switches to determine the front air bag deployment, and may only deploy one front air bag, depending on the severity of a collision and whether the front occupants are belted or unbelted. Information necessary to service the system safely is included in the "SRS AIRBAG" and "SEAT BELT" of this Service Manual.

WARNING:

- To avoid rendering the SRS inoperative, which could increase the risk of personal injury or death in the event of a collision which would result in air bag inflation, all maintenance must be performed by an authorized NISSAN/INFINITI dealer.
- Improper maintenance, including incorrect removal and installation of the SRS, can lead to personal injury caused by unintentional activation of the system. For removal of Spiral Cable and Air Bag Module, see the "SRS AIRBAG".
- Never use electrical test equipment on any circuit related to the SRS unless instructed to in this Service Manual. SRS wiring harnesses can be identified by yellow and/or orange harnesses or harness connectors.

PRECAUTIONS WHEN USING POWER TOOLS (AIR OR ELECTRIC) AND HAMMERS

When working near the Airbag Diagnosis Sensor Unit or other Airbag System sensors while ignition switch is ON or engine is running, never use air or electric power tools or strike near the sensor(s) with a hammer. Heavy vibration may activate the sensor(s), deploy the airbag(s), possibly cause serious injury. When using air or electric power tools or hammers, always turn OFF ignition switch, disconnect the battery, and wait 3 minutes or more before performing any service.

Precaution for Trouble Diagnosis

INFOID:000000003356691

AV COMMUNICATION SYSTEM

- Do not apply voltage of 7.0 V or higher to the measurement terminals.
- Use the tester with its open terminal voltage at 7.0 V or less.
- Turn ignition switch OFF and disconnect the battery cable from the negative terminal before checking the circuit.

Precaution for Harness Repair

INFOID:000000003356692

AV COMMUNICATION SYSTEM

- Solder the repaired parts, and wrap with tape. [Frays of twisted line must be within 110 mm (4.33 in).]

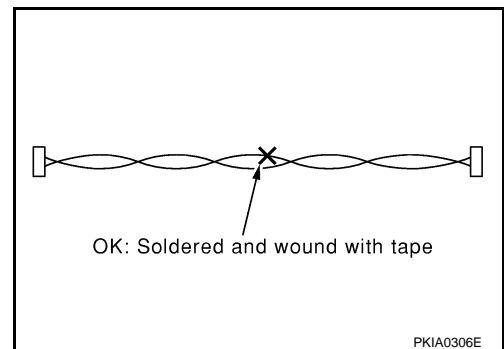

A
B
C
D
E
F
G
H
I
J
K
L
M
O
P

AV

PRECAUTIONS

< PRECAUTION >

[BOSE AUDIO WITH NAVIGATION]

- Do not perform bypass wire connections for the repair parts. (The spliced wire will become separated and the characteristics of twisted line will be lost.)

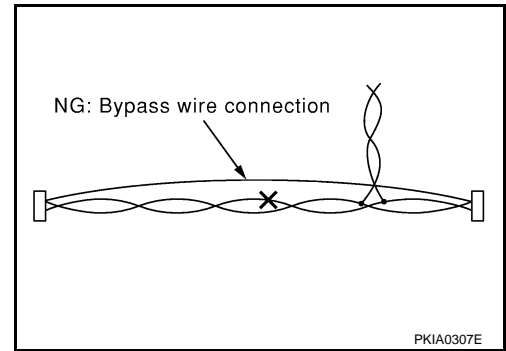

PREPARATION

PREPARATION

Commercial Service Tools

INFOID:000000003356693

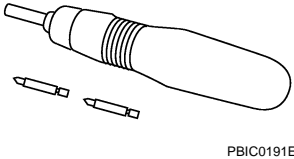
Tool name	Description
<p>Power tool</p>  <p>PBIC0191E</p>	<p>Loosening screws</p>

A
B
C
D
E
F
G
H
I
J
K
L
M
AV
O
P

AV

ON-VEHICLE REPAIR

AV CONTROL UNIT

Exploded View

INFOID:000000003356694

REMOVAL

Refer to [IP-11. "Exploded View"](#).

DISASSEMBLY

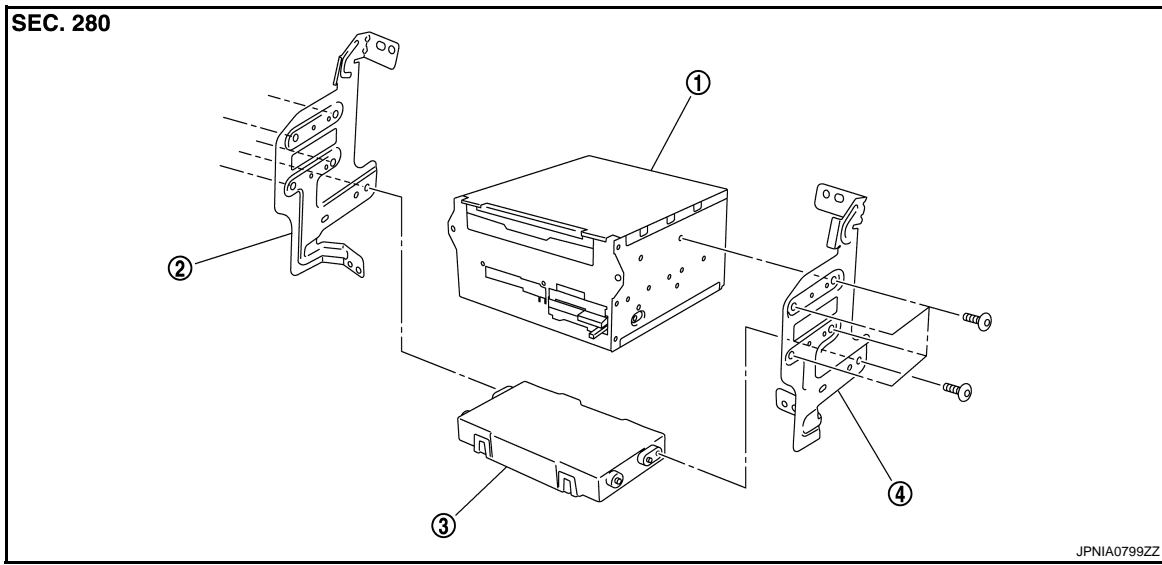

- | | | |
|--------------------|---------------|------------------|
| 1. AV control unit | 2. Bracket LH | 3. A/C auto amp. |
| 4. Bracket RH | | |

Removal and Installation

INFOID:000000003356695

REMOVAL

1. Remove cluster lid C. Refer to [IP-11. "Exploded View"](#).
2. Remove AV control unit with a A/C auto amp. as a single unit from the body.
3. Remove bracket screws, and then remove AV control unit.

INSTALLATION

Install in the reverse order of removal.

FRONT DISPLAY UNIT

< ON-VEHICLE REPAIR >

[BOSE AUDIO WITH NAVIGATION]

FRONT DISPLAY UNIT

Exploded View

INFOID:000000003356696

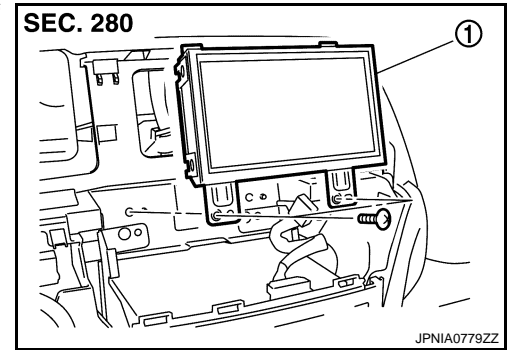

1. Front display unit

Removal and Installation

INFOID:000000003356697

REMOVAL

1. Remove center ventilator assembly. Refer to [IP-11, "Exploded View"](#).
2. Remove display unit with bracket as a single unit.

INSTALLATION

Install in the reverse order of removal.

A
B
C
D
E
F
G
H
I
J
K
L
M
O
P

AV

FRONT DOOR SPEAKER

< ON-VEHICLE REPAIR >

[BOSE AUDIO WITH NAVIGATION]

FRONT DOOR SPEAKER

Exploded View

INFOID:000000003356698

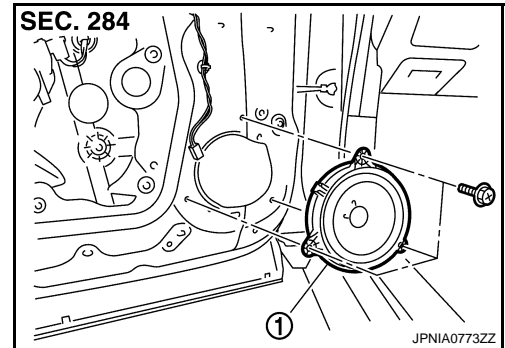

1. Front door speaker

Removal and Installation

INFOID:000000003356699

REMOVAL

1. Remove front door finisher. Refer to [INT-11, "FRONT DOOR FINISHER : Exploded View"](#).
2. Remove front door speaker screws, then disconnect front door speaker connector and remove front door speaker.

INSTALLATION

Install in the reverse order of removal.

REAR DOOR SPEAKER

< ON-VEHICLE REPAIR >

[BOSE AUDIO WITH NAVIGATION]

REAR DOOR SPEAKER

Exploded View

INFOID:000000003356702

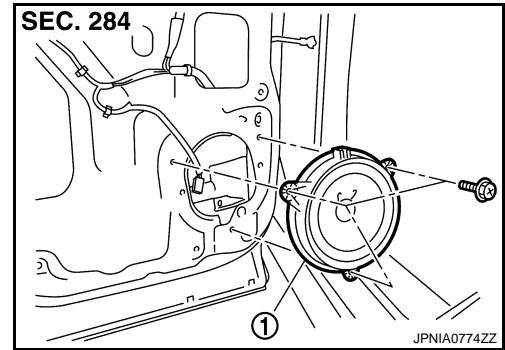

1. Rear door speaker

Removal and Installation

INFOID:000000003356703

REMOVAL

1. Remove rear door finisher. Refer to [INT-15. "REAR DOOR FINISHER : Exploded View"](#).
2. Remove rear door speaker screws, then disconnect rear door speaker connector and remove rear door speaker.

INSTALLATION

Install in the reverse order of removal.

A
B
C
D
E
F
G
H
I
J
K
L
M
O
P

AV

FRONT SQUAWKER

< ON-VEHICLE REPAIR >

[BOSE AUDIO WITH NAVIGATION]

FRONT SQUAWKER

Exploded View

INFOID:000000003356704

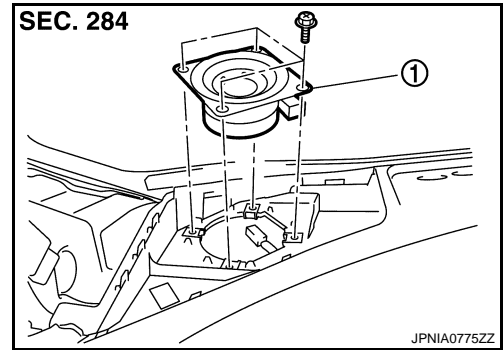

1. Front squawker

Removal and Installation

INFOID:000000003356705

REMOVAL

1. Remove speaker grille. Refer to [IP-11. "Exploded View"](#).
2. Remove front squawker screws, lift up the front squawker and disconnect front squawker connector. Then remove the front squawker.

INSTALLATION

Install in the reverse order of removal.

REAR SPEAKER

< ON-VEHICLE REPAIR >

[BOSE AUDIO WITH NAVIGATION]

REAR SPEAKER

Exploded View

INFOID:000000003470919

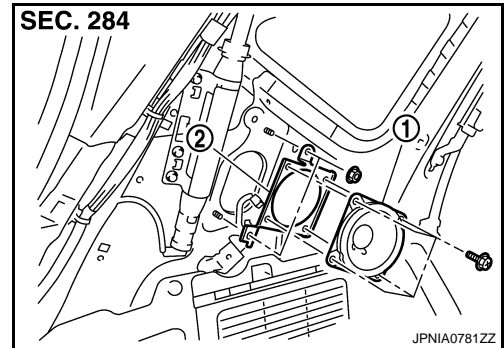

1. Rear speaker
2. Rear speaker bracket

Removal and Installation

INFOID:000000003470920

REMOVAL

1. Remove luggage side finisher upper. Refer to [INT-33. "Exploded View"](#).
2. Remove rear speaker screws, lift up the rear speaker and disconnect rear speaker connector. Then remove the rear speaker.

INSTALLATION

Install in the reverse order of removal.

A
B
C
D
E
F
G
H
I
J
K
L
M
AV
O
P

CENTER SPEAKER

< ON-VEHICLE REPAIR >

[BOSE AUDIO WITH NAVIGATION]

CENTER SPEAKER

Exploded View

INFOID:000000003356706

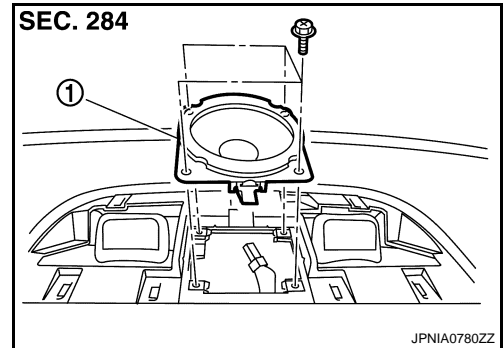

1. Center speaker

Removal and Installation

INFOID:000000003356707

REMOVAL

1. Remove center speaker grille. Refer to [JP-11. "Exploded View"](#).
2. Remove center speaker screws, lift up the center speaker and disconnect center speaker connector. Then remove the center speaker.

INSTALLATION

Install in the reverse order of removal.

WOOFER

< ON-VEHICLE REPAIR >

[BOSE AUDIO WITH NAVIGATION]

WOOFER

Exploded View

INFOID:000000003356708

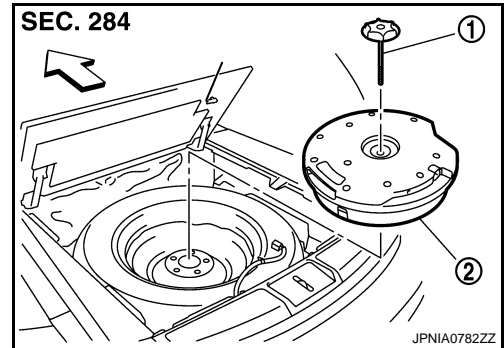

- ← Vehicle front
1. Clamp
 2. Woofer

Removal and Installation

INFOID:000000003356709

REMOVAL

1. Remove luggage floor finisher center (back). Refer to [INT-33. "Exploded View"](#).
2. Remove clamp, disconnect woofer connector and remove the woofer.

INSTALLATION

Install in the reverse order of removal.

A
B
C
D
E
F
G
H
I
J
K
L
M
N
O
P

AV

BOSE AMP.

< ON-VEHICLE REPAIR >

[BOSE AUDIO WITH NAVIGATION]

BOSE AMP.

Exploded View

INFOID:000000003356710

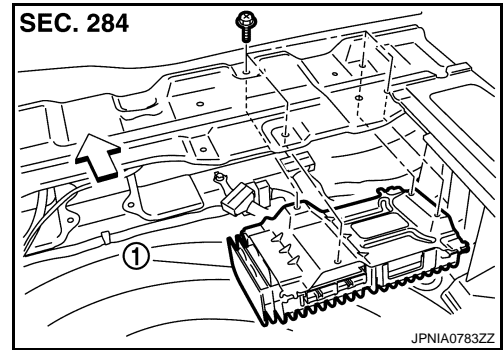

- ← Vehicle front
1. BOSE amp.

Removal and Installation

INFOID:000000003356711

REMOVAL

1. Remove luggage floor finisher. Refer to [INT-33. "Exploded View"](#).
2. Remove BOSE amp. screws, disconnect BOSE amp. connector and remove the BOSE amp.

INSTALLATION

Install in the reverse order of removal.

MULTIFUNCTION SWITCH

< ON-VEHICLE REPAIR >

[BOSE AUDIO WITH NAVIGATION]

MULTIFUNCTION SWITCH

Exploded View

INFOID:000000003356718

REMOVAL

Refer to [IP-11, "Exploded View"](#).

DISASSEMBLY

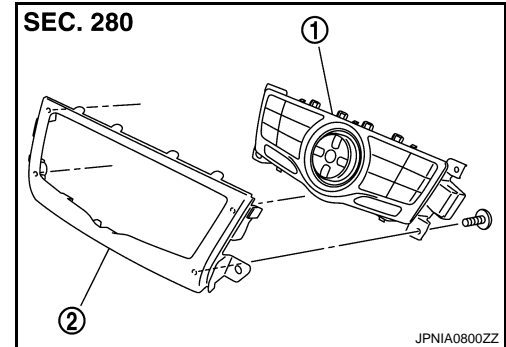

1. Multifunction switch
2. Cluster lid D

Removal and Installation

INFOID:000000003356719

REMOVAL

1. Remove cluster lid D. Refer to [IP-11, "Exploded View"](#).
2. Remove multifunction switch with center ventilator grille as a single unit.
3. Remove multifunction switch screws, remove multifunction switch from cluster lid D.

INSTALLATION

Install in the reverse order of removal.

A
B
C
D
E
F
G
H
I
J
K
L
M

AV

O
P

PRESET SWITCH

< ON-VEHICLE REPAIR >

[BOSE AUDIO WITH NAVIGATION]

PRESET SWITCH

Exploded View

INFOID:000000003356720

REMOVAL

Refer to [IP-11, "Exploded View"](#).

DISASSEMBLY

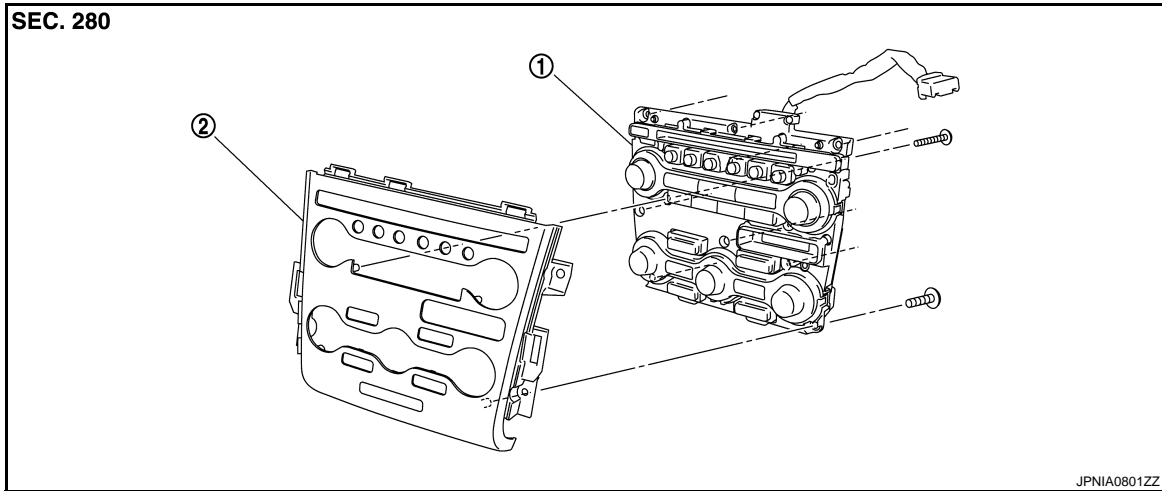

1. Preset switch

2. Cluster lid C

Removal and Installation

INFOID:000000003356721

REMOVAL

1. Remove cluster lid C. Refer to [IP-11, "Exploded View"](#).
2. Remove preset switch screws (A) (B), remove preset switch (1) from cluster lid C.

- 1. Preset switch
- A. Screw
- B. Screw

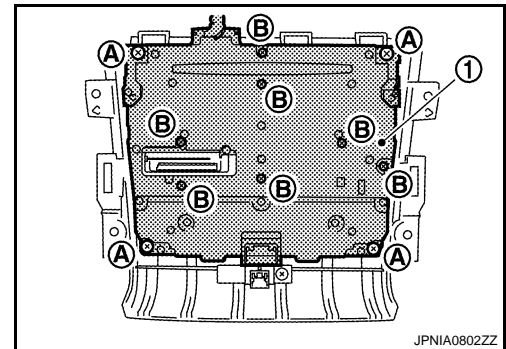

INSTALLATION

Install in the reverse order of removal.

STEERING SWITCH

< ON-VEHICLE REPAIR >

[BOSE AUDIO WITH NAVIGATION]

STEERING SWITCH

Exploded View

INFOID:000000003356722

Refer to [ST-15. "Exploded View"](#).

Removal and Installation

INFOID:000000003356723

REMOVAL

Refer to [ST-15. "Removal and Installation"](#).

INSTALLATION

Install in the reverse order of removal.

A

B

C

D

E

F

G

H

I

J

K

L

M

AV

O

P

IPOD ADAPTER

< ON-VEHICLE REPAIR >

[BOSE AUDIO WITH NAVIGATION]

IPOD ADAPTER

Exploded View

INFOID:000000003356724

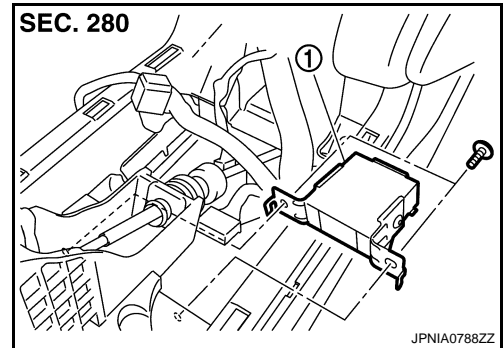

1. iPod adapter

Removal and Installation

INFOID:000000003356725

REMOVAL

1. Remove front console pocket assembly. Refer to [IP-19, "Exploded View"](#).
2. Disconnect iPod adapter connector, remove iPod adapter screws and remove the iPod adapter.

INSTALLATION

Install in the reverse order of removal.

IPOD CONNECTOR

< ON-VEHICLE REPAIR >

[BOSE AUDIO WITH NAVIGATION]

IPOD CONNECTOR

Exploded View

INFOID:000000003356726

REMOVAL

Refer to [IP-19, "Exploded View"](#).

DISASSEMBLY

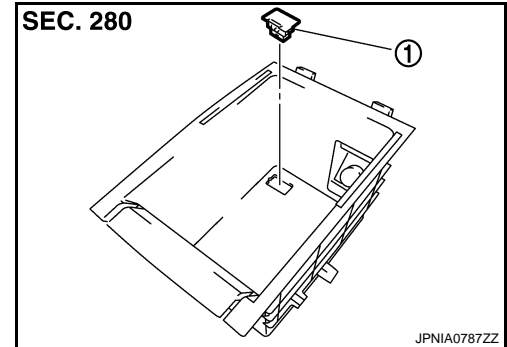

1. iPod connector

Removal and Installation

INFOID:000000003356727

REMOVAL

1. Remove center console. Refer to [IP-19, "Exploded View"](#).
2. Press the pawl from the back of center console to remove iPod connector.

INSTALLATION

Install in the reverse order of removal.

A
B
C
D
E
F
G
H
I
J
K
L
M
O
P

AV

AUXILIARY INPUT JACKS

< ON-VEHICLE REPAIR >

[BOSE AUDIO WITH NAVIGATION]

AUXILIARY INPUT JACKS

Exploded View

INFOID:000000003356728

REMOVAL

Refer to [IP-19, "Exploded View"](#).

DISASSEMBLY

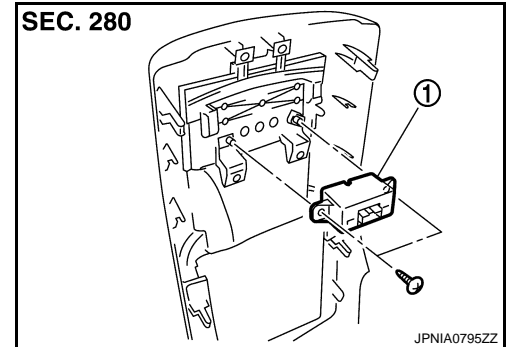

1. Auxiliary input jacks

Removal and Installation

INFOID:000000003356729

REMOVAL

1. Remove console rear finisher. Refer to [IP-19, "Exploded View"](#).
2. Remove auxiliary input jacks from center console.

INSTALLATION

Install in the reverse order of removal.

MICROPHONE

< ON-VEHICLE REPAIR >

[BOSE AUDIO WITH NAVIGATION]

MICROPHONE

Exploded View

INFOID:000000003356730

REMOVAL

Refer to [INL-115, "Exploded View"](#).

DISASSEMBLY

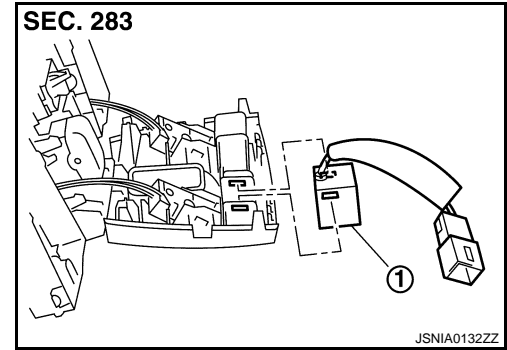

1. Microphone

Removal and Installation

INFOID:000000003356731

REMOVAL

1. Remove map lamp. Refer to [INL-115, "Exploded View"](#).
2. Remove microphone from map lamp.

INSTALLATION

Install in the reverse order of removal.

A
B
C
D
E
F
G
H
I
J
K
L
M
O
P

AV

GPS ANTENNA

< ON-VEHICLE REPAIR >

[BOSE AUDIO WITH NAVIGATION]

GPS ANTENNA

Exploded View

INFOID:000000003356732

Harness Layout

INFOID:000000003356733

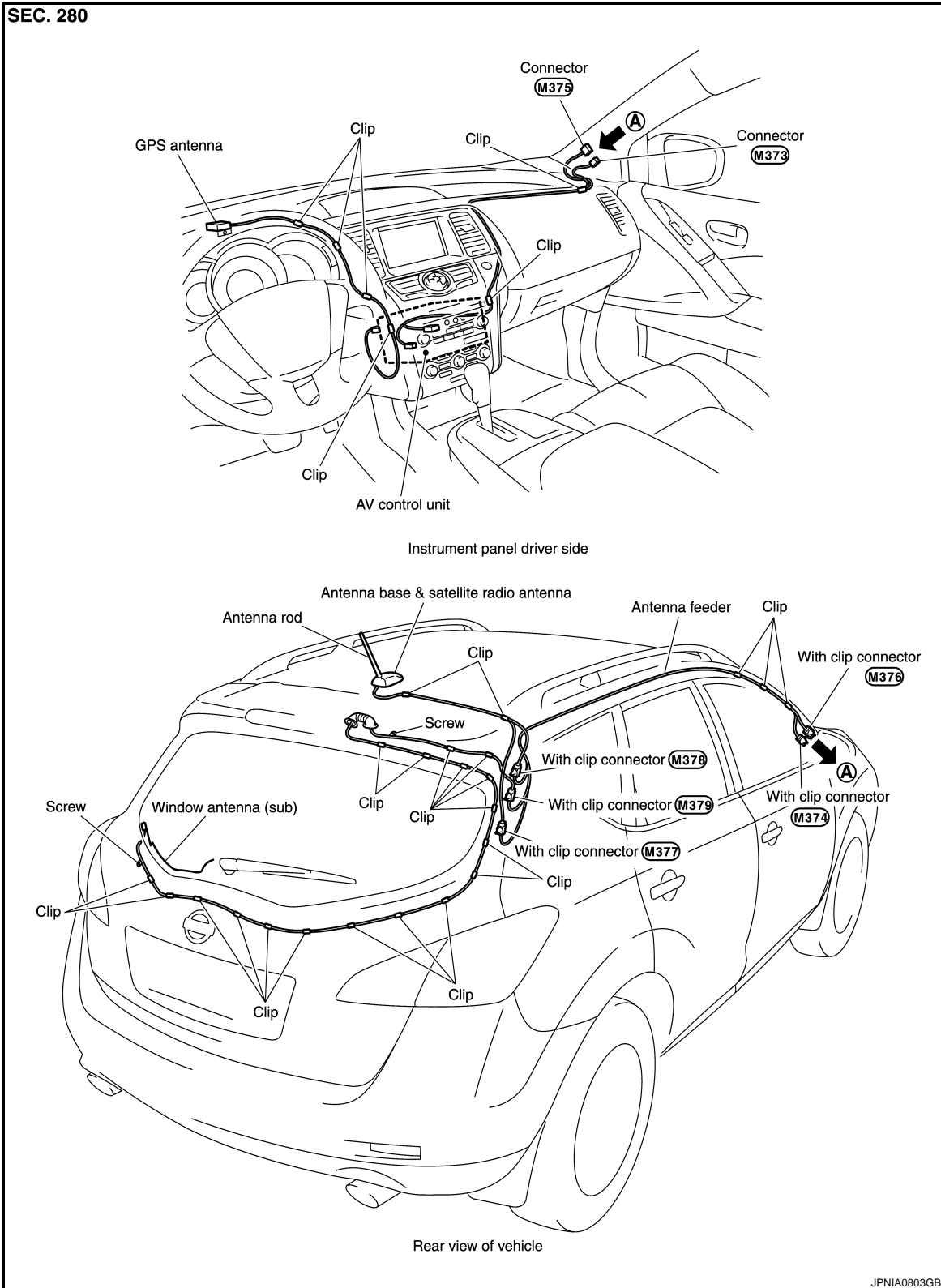

GPS ANTENNA

< ON-VEHICLE REPAIR >

[BOSE AUDIO WITH NAVIGATION]

Removal and Installation

INFOID:000000003356734

REMOVAL

1. Remove combination meter. Refer to [MWI-145. "Exploded View"](#).
2. Disconnect GPS antenna connector from AV control unit.
3. Remove GPS antenna (1) from instrument panel.

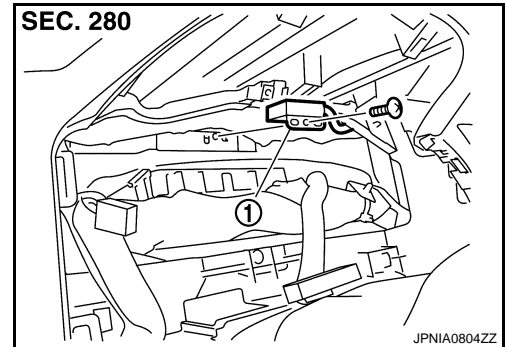

INSTALLATION

Install in the reverse order of removal.

A
B
C
D
E
F
G
H
I
J
K
L
M
AV
O
P

CAMERA CONTROL UNIT

< ON-VEHICLE REPAIR >

[BOSE AUDIO WITH NAVIGATION]

CAMERA CONTROL UNIT

Exploded View

INFOID:000000003356735

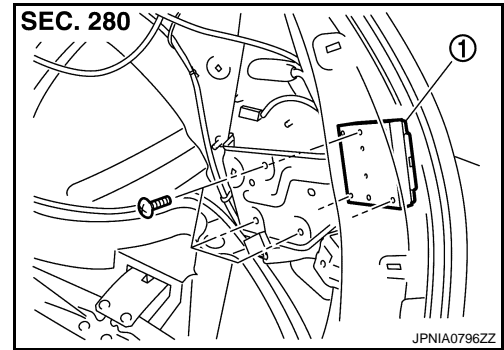

1. Camera control unit

Removal and Installation

INFOID:000000003356736

REMOVAL

1. Remove luggage side finisher lower (RH). Refer to [INT-33, "Exploded View"](#).
2. Remove camera control unit screws, disconnect camera control unit connector and remove the camera control unit.

INSTALLATION

Install in the reverse order of removal.

Adjustment

INFOID:000000003356737

ADJUSTMENT

There may be a misalignment of possible route line center position of rear view monitor after removing camera control unit. Therefore, correct neutral position with the following procedure.

1. Steer the steering wheel to the leftmost and rightmost ends.
2. Drive vehicle at 30 km/h (18.6 MPH) min. speed at least 100 m (328.1 ft).

REAR VIEW CAMERA

< ON-VEHICLE REPAIR >

[BOSE AUDIO WITH NAVIGATION]

REAR VIEW CAMERA

Exploded View

INFOID:000000003356738

REMOVAL

Refer to [INT-37. "Exploded View"](#).

DISASSEMBLY

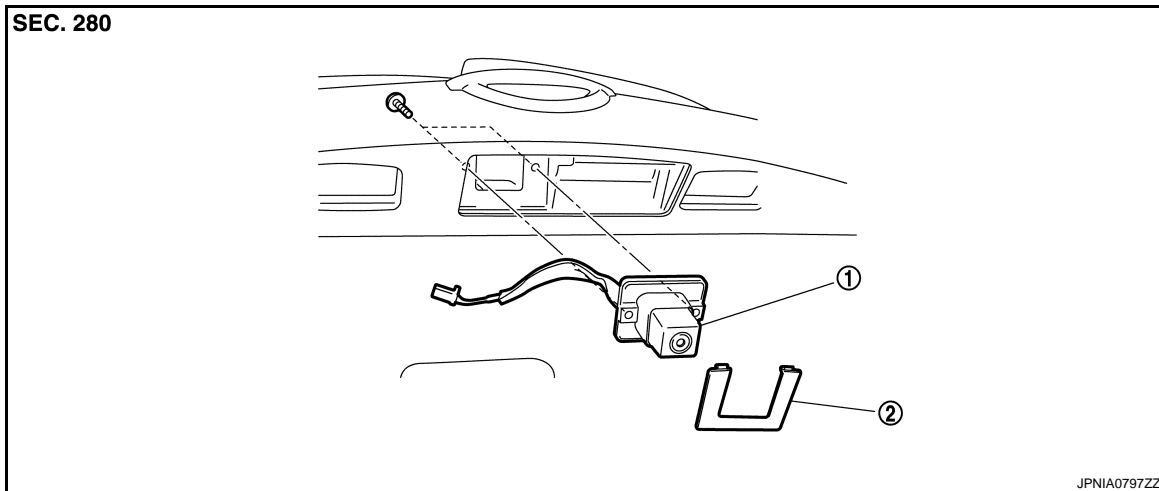

1. Rear view camera

2. Finisher

Removal and Installation

INFOID:000000003356739

REMOVAL

1. Remove back door finisher inner. Refer to [INT-37. "Exploded View"](#).
2. Remove finisher.
3. Remove rear view camera screws, disconnect rear view camera connector and remove rear view camera from back door assembly.

INSTALLATION

Install in the reverse order of removal.

Adjustment

INFOID:000000003356740

Adjust the guide line position if the guide line position is shifted after installing the rear view camera.

A
B
C
D
E
F
G
H
I
J
K
L
M
O
P

AV

REAR VIEW CAMERA

< ON-VEHICLE REPAIR >

[BOSE AUDIO WITH NAVIGATION]

1. Draw lines on rearward area of the vehicle passing through the following points: 200 mm (7.87 in) from both sides of the vehicle, and 0.5 m (1.64 ft), 1.0 m (3.28 ft) from the rear end of the bumper.
2. Set into "Adjust offset of rear view camera" mode of Confirmation / Adjustment mode.

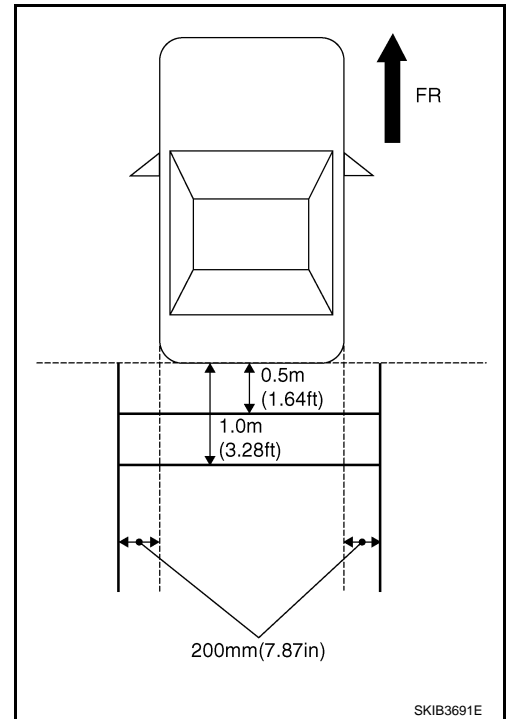

3. Rotate the center dial, and then select the guiding line pattern so that its angle is aligned with the correction line of the rear of the vehicle.

Selected pattern : 7

4. Make fine adjustment to the correction line of the rear of the vehicle with up/down/left/right switches so that its position is aligned with the guiding line. Press "OK" switch and record the adjusted guiding line position to the camera control unit.

Up/Down adjustment range : -20 - 20

Left/Right adjustment range : -20 - 20

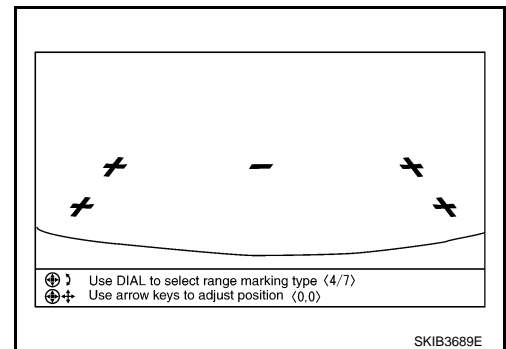

CAUTION:

Never operate other function such as pressing BACK while writing index data.

If Confirmation/Adjustment mode does not function in the above procedure, perform one of the following service to adjust the index again.

- Remove battery for five min. Then reconnect battery.
- Remove camera control unit connector for five min. Then reconnect camera control unit connector.

STEERING ANGLE SENSOR

< ON-VEHICLE REPAIR >

[BOSE AUDIO WITH NAVIGATION]

STEERING ANGLE SENSOR

Exploded View

INFOID:000000003356741

REMOVAL

Refer to [ST-15. "Exploded View"](#).

DISASSEMBLY

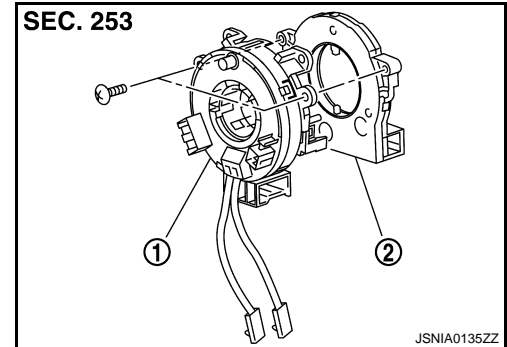

1. Spiral cable
2. Steering angle sensor

Removal and Installation

INFOID:000000003356742

REMOVAL

1. Remove spiral cable.
2. Remove steering angle sensor from spiral cable.

INSTALLATION

Install in the reverse order of removal.

A
B
C
D
E
F
G
H
I
J
K
L
M
O
P

AV

ROOF ANTENNA

< ON-VEHICLE REPAIR >

[BOSE AUDIO WITH NAVIGATION]

ROOF ANTENNA

Exploded View

INFOID:000000003356716

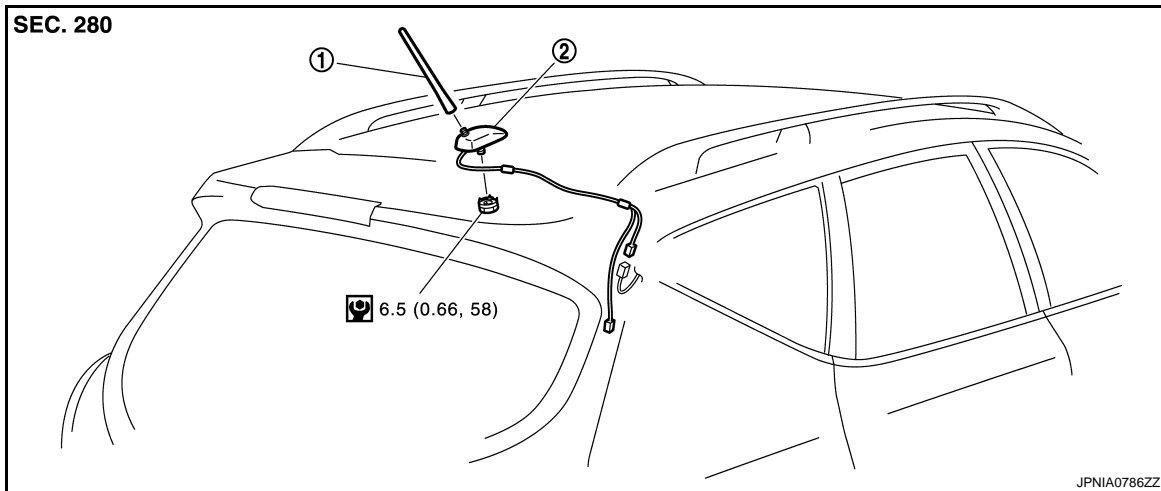

1. Rod antenna

2. Antenna base & satellite radio antenna

Refer to [GI-4, "Components"](#) for symbols in the figure.

Removal and Installation

INFOID:000000003356717

REMOVAL

1. Remove headlining assembly (rear) to secure work space between vehicle and headlining. Refer to [INT-25, "NORMAL ROOF : Exploded View"](#) [without sunroof] or [INT-29, "SUNROOF : Exploded View"](#) [with sunroof].
2. Disconnect AM/FM main connector and satellite radio antenna connector.
3. Remove antenna base & satellite radio nut, and then remove antenna base & satellite radio antenna from roof panel.

INSTALLATION

Install in the reverse order of removal.

Antenna base & satellite radio antenna mounting nut : 6.5 N·m (0.66 kg·m, 58 in·lb)

CAUTION:

When Antenna base & satellite radio antenna mounting nut tightening torque is loose, be careful about tightening torque. Antenna sensitivity becomes poor, and when it is excessive, roof panel may become deformed.

ANTENNA FEEDER (RADIO)

< ON-VEHICLE REPAIR >

[BOSE AUDIO WITH NAVIGATION]

ANTENNA FEEDER (RADIO)

Harness Layout

INFOID:000000003356744

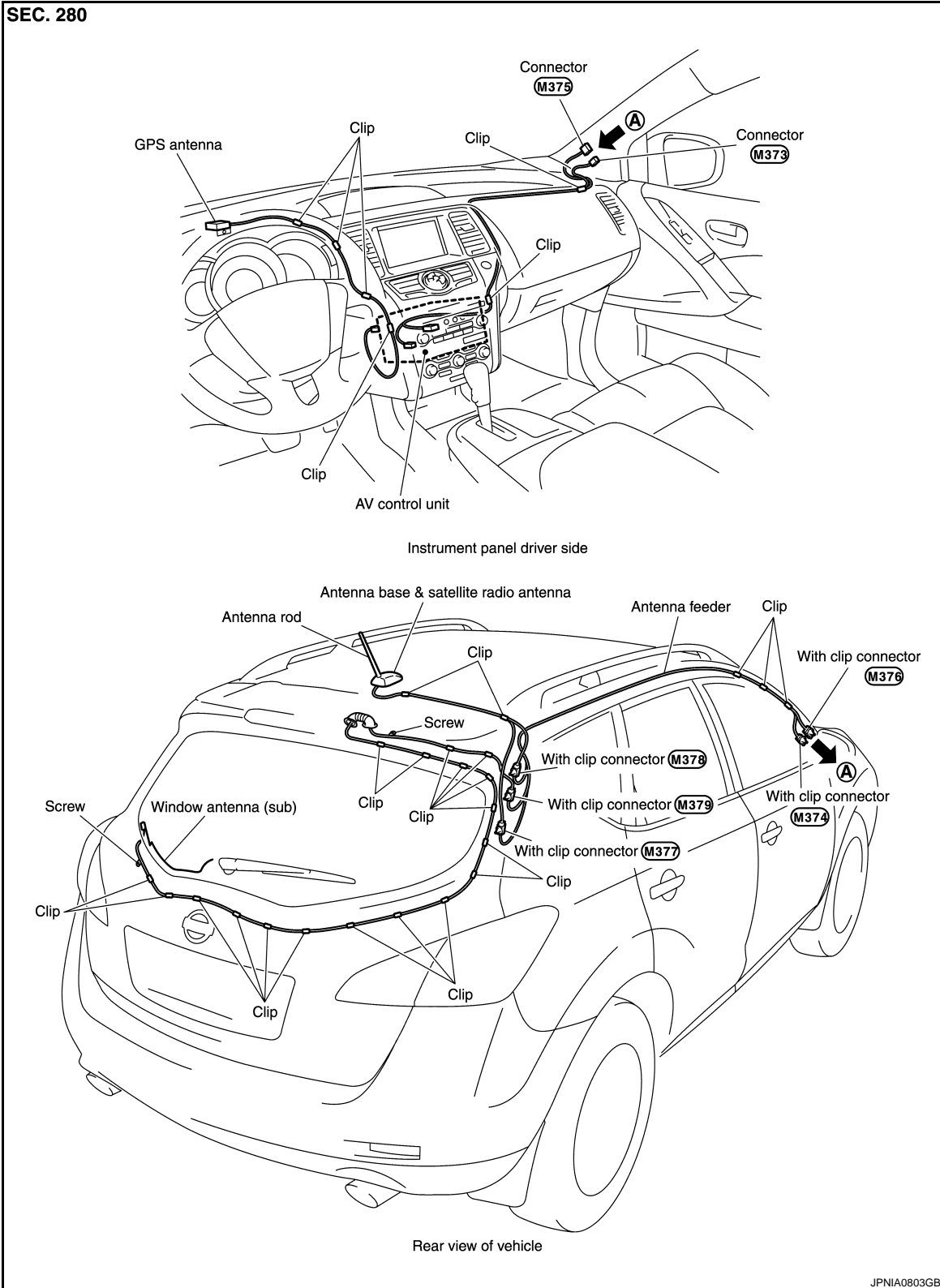

A
B
C
D
E
F
G
H
I
J
K
L
M
N
O
P

AV

ANTENNA FEEDER (SATELLITE RADIO)

< ON-VEHICLE REPAIR >

[BOSE AUDIO WITH NAVIGATION]

ANTENNA FEEDER (SATELLITE RADIO)

Harness Layout

INFOID:000000003507978

SEC. 280

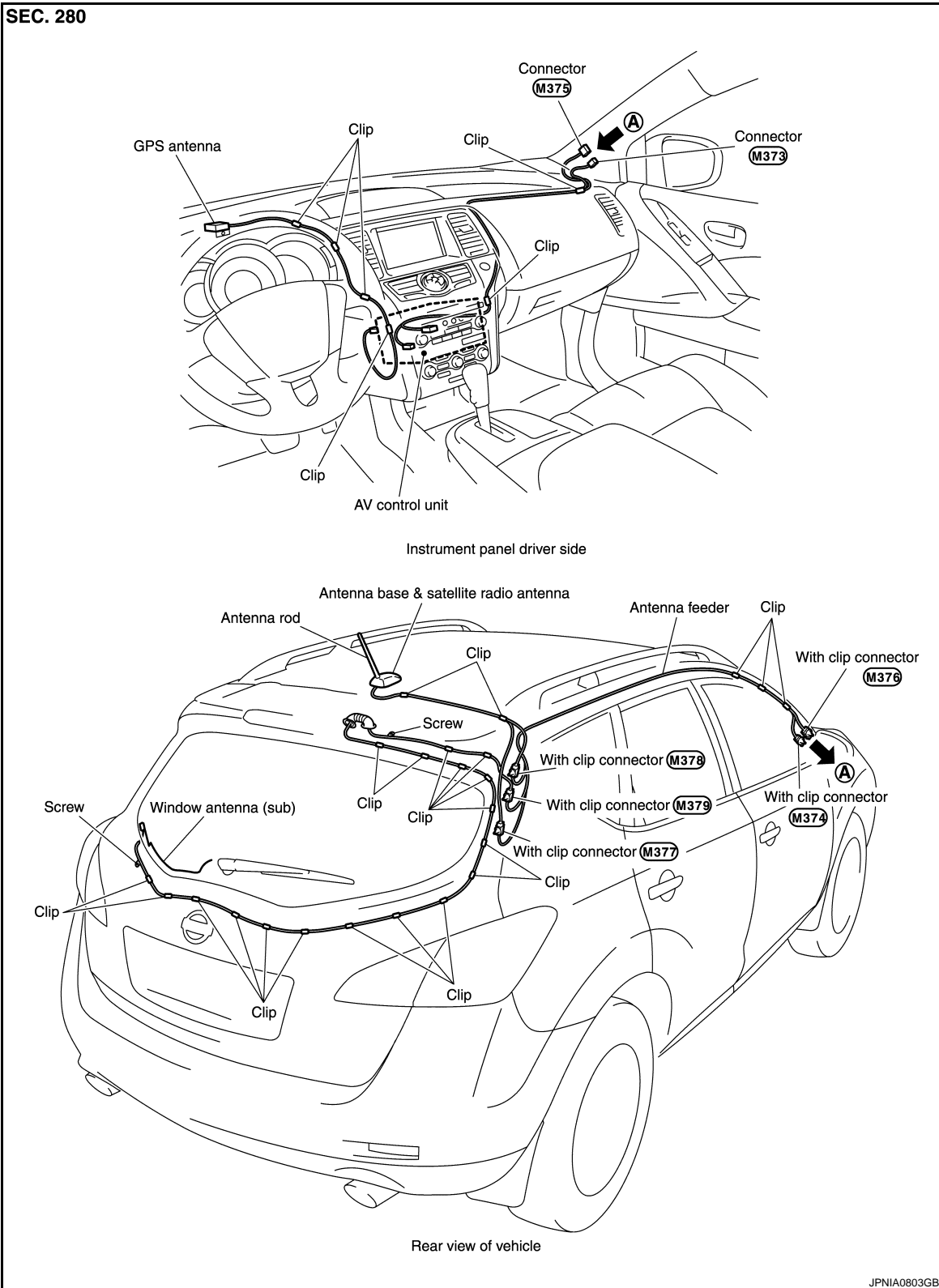

JPNIA0803GB

ANTENNA FEEDER (GPS)

< ON-VEHICLE REPAIR >

[BOSE AUDIO WITH NAVIGATION]

ANTENNA FEEDER (GPS)

Harness Layout

INFOID:000000003507979

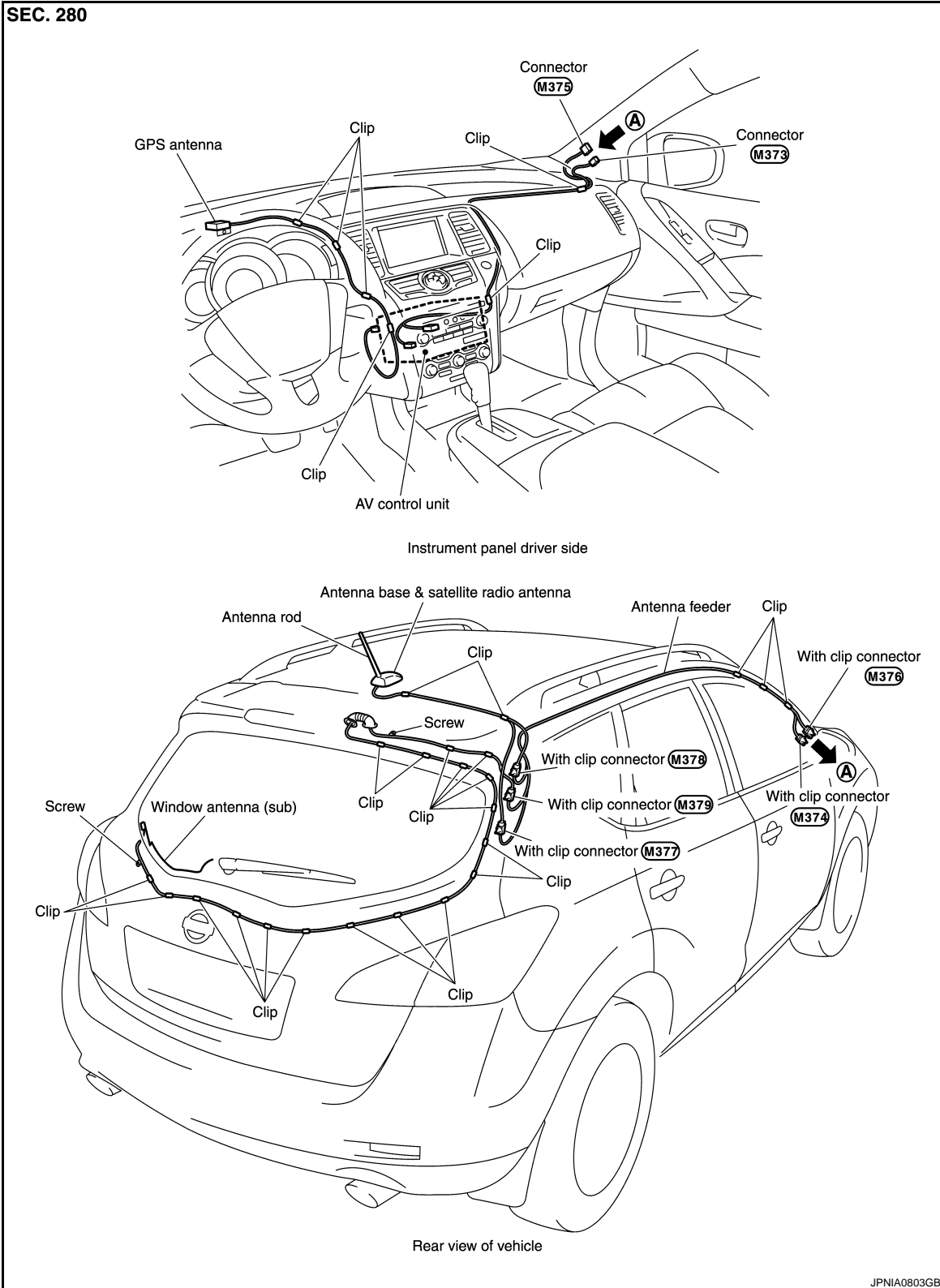

A
B
C
D
E
F
G
H
I
J
K
L
M
N
O
P

AV