

SECTION PCS

POWER CONTROL SYSTEM

CONTENTS

IPDM E/R	CONSULT - III Function (IPDM E/R)	15	F
BASIC INSPECTION	COMPONENT DIAGNOSIS	18	G
DIAGNOSIS AND REPAIR WORKFLOW	U1000 CAN COMM CIRCUIT	18	H
Work Flow	Description	18	I
FUNCTION DIAGNOSIS	DTC Logic	18	J
RELAY CONTROL SYSTEM	Diagnosis Procedure	18	K
System Diagram	POWER SUPPLY AND GROUND CIRCUIT	19	L
System Description	Diagnosis Procedure	19	
Component Parts Location	ECU DIAGNOSIS	20	
POWER DISTRIBUTION SYSTEM	IPDM E/R (INTELLIGENT POWER DISTRI-	20	
System Description	BUTION MODULE ENGINE ROOM)	20	
Component Parts Location	Reference Value	20	
Component Description	Terminal Layout	22	
POWER CONTROL SYSTEM	Physical Values	22	
System Diagram	Wiring Diagram	26	
System Description	Fail Safe	30	
SIGNAL BUFFER SYSTEM	DTC Index	32	
System Diagram	PRECAUTION	33	
System Description	PRECAUTIONS	33	
POWER CONSUMPTION CONTROL SYSTEM	Precaution for Supplemental Restraint System	33	
System Diagram	(SRS) "AIR BAG" and "SEAT BELT PRE-TENSIONER"	33	
System Description	ON-VEHICLE REPAIR	34	
Component Parts Location	IPDM E/R (INTELLIGENT POWER DISTRI-	34	
DIAGNOSIS SYSTEM (IPDM E/R)	BUTION MODULE ENGINE ROOM)	34	
Diagnosis Description	Removal and Installation of IPDM E/R	34	

A
B
C
D
E
F
G
H
I
J
K
L
PCS
N
O
P

BASIC INSPECTION

DIAGNOSIS AND REPAIR WORKFLOW

Work Flow

INFOID:000000004056796

OVERALL SEQUENCE

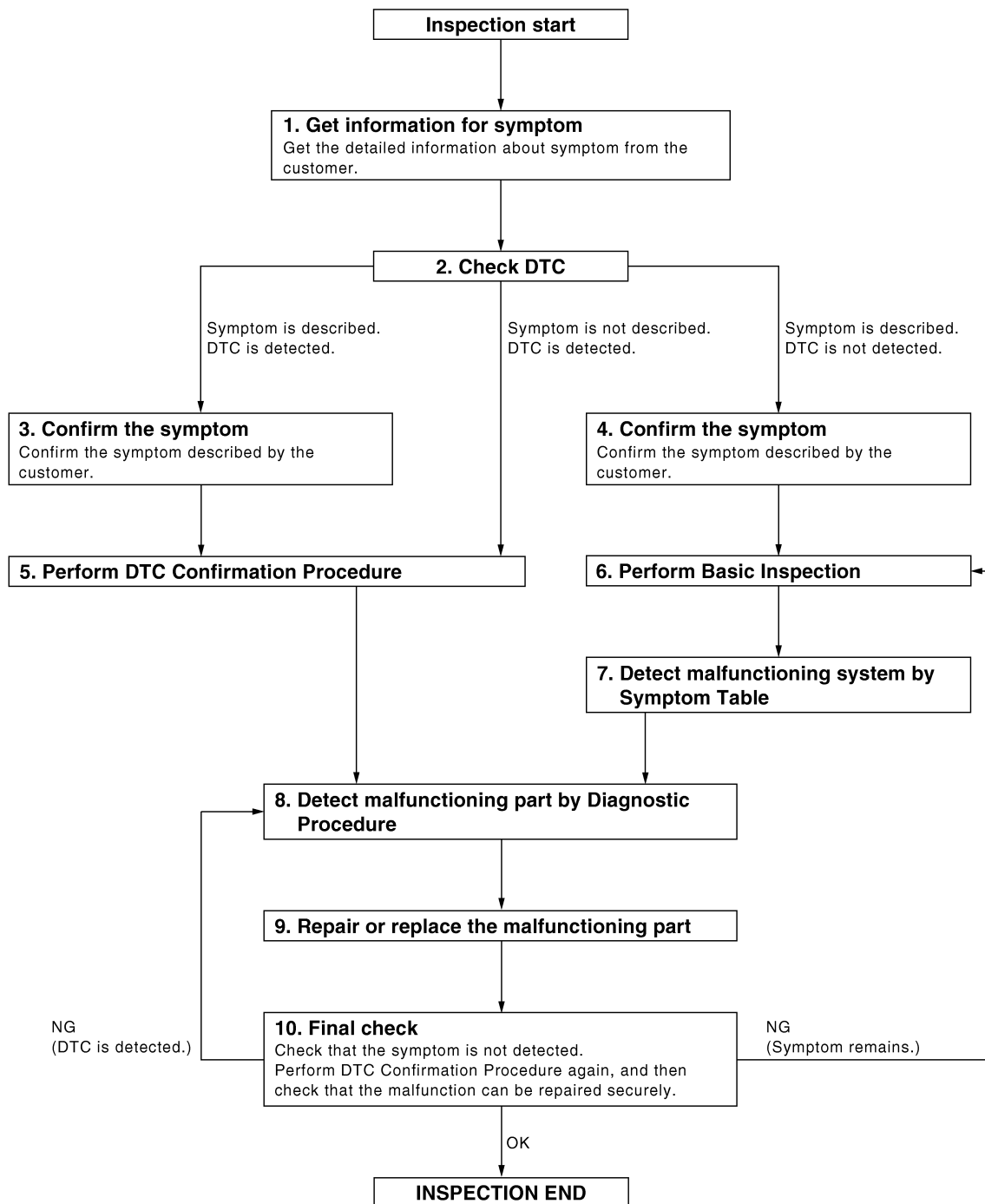

DIAGNOSIS AND REPAIR WORKFLOW

[IPDM E/R]

< BASIC INSPECTION >

1. GET INFORMATION FOR SYMPTOM

Get the detailed information from the customer about the symptom (the condition and the environment when the incident/malfunction occurred).

>> GO TO 2

2. CHECK DTC

1. Check DTC.
2. Perform the following procedure if DTC is displayed.
 - Record DTC and freeze frame data.
 - Erase DTC.
 - Study the relationship between the cause detected by DTC and the symptom described by the customer.
3. Check related service bulletins for information.

Is any symptom described and any DTC detected?

- Symptom is described, DTC is displayed>>GO TO 3
- Symptom is described, DTC is not displayed>>GO TO 4
- Symptom is not described, DTC is displayed>>GO TO 5

3. CONFIRM THE SYMPTOM

Confirm the symptom described by the customer.
Connect CONSULT-III to the vehicle in "DATA MONITOR" mode and check real time diagnosis results.
Verify relationship between the symptom and the condition when the symptom is detected.

>> GO TO 5

4. CONFIRM THE SYMPTOM

Confirm the symptom described by the customer.
Connect CONSULT-III to the vehicle in "DATA MONITOR" mode and check real time diagnosis results.
Verify relationship between the symptom and the condition when the symptom is detected.

>> GO TO 6

5. PERFORM DTC CONFIRMATION PROCEDURE

Perform DTC Confirmation Procedure for the displayed DTC, and then check that DTC is detected again.
At this time, always connect CONSULT-III to the vehicle, and check diagnostic results in real time.

NOTE:

- Freeze frame data is useful if the DTC is not detected.
- Perform Component Function Check if DTC Confirmation Procedure is not included in Service Manual. This simplified check procedure is an effective alternative though DTC cannot be detected during this check. If the result of Component Function Check is NG, it is the same as the detection of DTC by DTC Confirmation Procedure.

Is DTC detected?

- YES >> GO TO 8
- NO >> Refer to [GI-49. "Intermittent Incident"](#).

6. PERFORM BASIC INSPECTION

Perform basic inspection of system.

Inspection End>>GO TO 7

7. DETECT MALFUNCTIONING SYSTEM BY SYMPTOM TABLE

Detect malfunctioning system according to [PCS-8. "System Description"](#) based on the confirmed symptom in step 4, and determine the trouble diagnosis order based on possible causes and symptom.

>> GO TO 8

8. DETECT MALFUNCTIONING PART BY DIAGNOSTIC PROCEDURE

A
B
C
D
E
F
G
H
I
J
K
L
N
O
P

PCS

DIAGNOSIS AND REPAIR WORKFLOW

[IPDM E/R]

< BASIC INSPECTION >

Inspect according to Diagnostic Procedure of the system.

NOTE:

The Diagnostic Procedure described based on open circuit inspection. A short circuit inspection is also required for the circuit check in the Diagnostic Procedure.

Is malfunctioning part detected?

YES >> GO TO 9

NO >> Check voltage of related BCM terminals using CONSULT-III.

9. REPAIR OR REPLACE THE MALFUNCTIONING PART

1. Repair or replace the malfunctioning part.
2. Reconnect parts or connectors disconnected during Diagnostic Procedure again after repair and replacement.
3. Check DTC. If DTC is displayed, erase it.

>> GO TO 10

10. FINAL CHECK

When DTC was detected in step 2, perform DTC Confirmation Procedure or Component Function Check again, and then check that the malfunction have been fully repaired.

When symptom was described from the customer, refer to confirmed symptom in step 3 or 4 and check that the symptom is not detected.

OK or NG

NG (DTC is detected)>>GO TO 8

NG (Symptom remains)>>GO TO 6

OK >> Inspection End.

RELAY CONTROL SYSTEM

< FUNCTION DIAGNOSIS >

[IPDM E/R]

FUNCTION DIAGNOSIS

RELAY CONTROL SYSTEM

System Diagram

INFOID:000000004056797

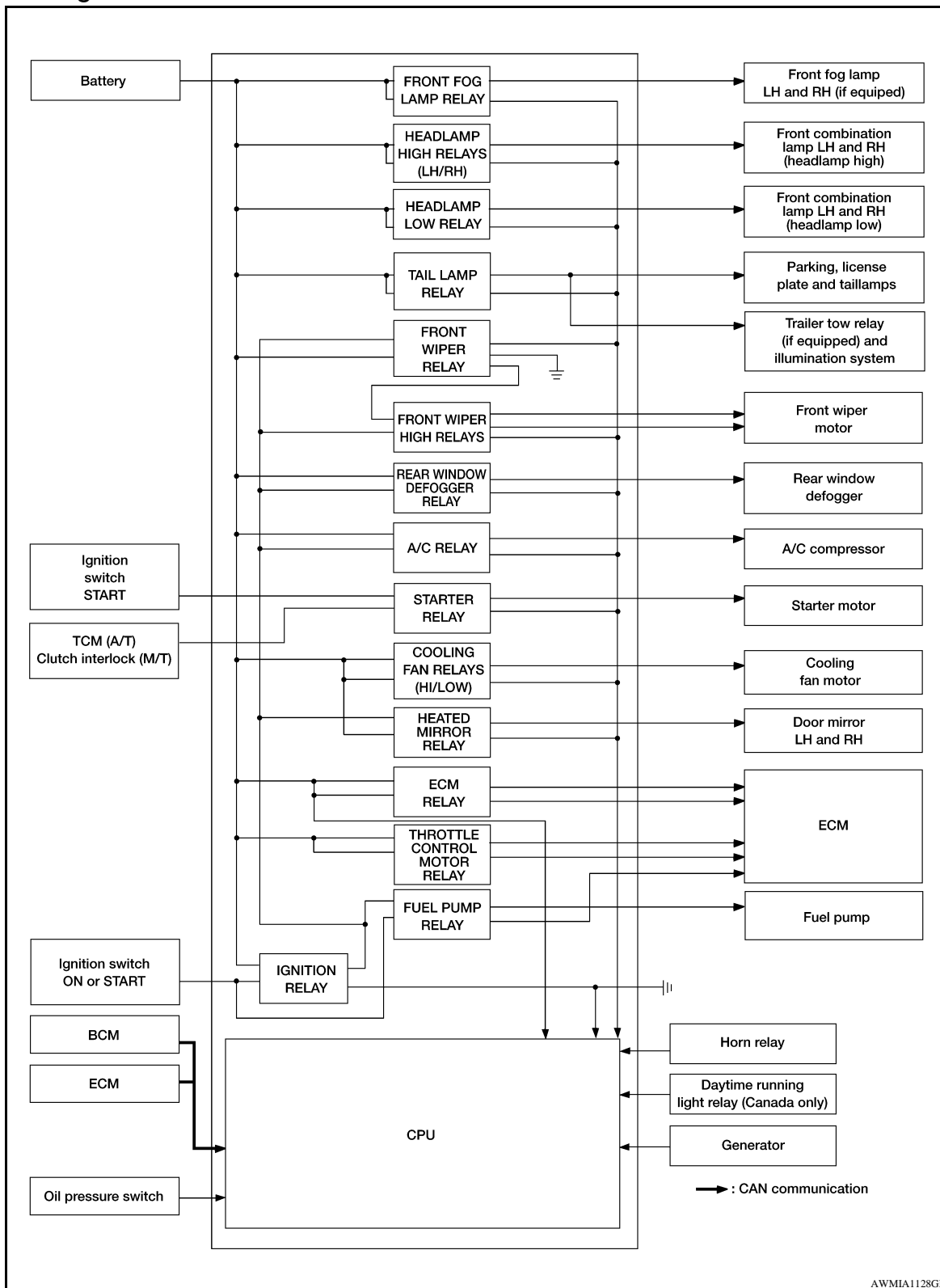

AWMIA1128G

A
B
C
D
E
F
G
H
I
J
K
L
PCS
N
O
P

RELAY CONTROL SYSTEM

< FUNCTION DIAGNOSIS >

[IPDM E/R]

System Description

INFOID:000000004056798

IPDM E/R activates the internal control circuit to perform the relay ON-OFF control according to the input signals from various sensors and the request signals received from control units via CAN communication.

CAUTION:

IPDM E/R integrated relays cannot be removed.

Control relay	Input/output	Transmit unit	Control part	Reference page
Front fog lamp relay (if equipped)	Front fog lamp request signal	BCM (CAN)	Front fog lamps (if equipped)	EXL-40
<ul style="list-style-type: none"> • Headlamp (LH) high relay • Headlamp (RH) high relay • Headlamp low relay 	<ul style="list-style-type: none"> • High beam request signal • Low beam request signal 	BCM (CAN)	<ul style="list-style-type: none"> • Headlamp high • Headlamp low 	EXL-36 EXL-38
Tail lamp relay	Position light request signal	BCM (CAN)	<ul style="list-style-type: none"> • Parking lamps • License plate lamps • Tail lamps • Trailer tow relay (if equipped) • Illumination system 	EXL-42
<ul style="list-style-type: none"> • Front wiper relay • Front wiper high relay 	Front wiper request signal	BCM (CAN)	Front wiper motor	WW-57
Rear window defogger relay	Rear window defogger request signal	BCM (CAN)	Rear window defogger	DEF-4
A/C relay	A/C request signal	<ul style="list-style-type: none"> • BCM (CAN) • ECM (CAN) 	A/C compressor	HAC-40
Starter relay	Ignition switch START signal	TCM	Starter motor	STR-34
Cooling fan relays	Cooling fan request signal	ECM (CAN)	Cooling fan relay	EC-494
Heated mirror relay	Heated mirror request signal	BCM (CAN)	Door mirrors	DEF-4
ECM relay	ECM relay control signal	ECM (CAN)	ECM relay	EC-27 , EC-478
Throttle control motor relay	Throttle control motor control signal	ECM (CAN)	Throttle control motor relay	EC-34 , EC-486
Fuel pump relay	Fuel pump request signal	ECM (CAN)	Fuel pump	EC-858
Ignition relay	Ignition switch ON signal	Ignition switch	Ignition relay	EC-862

RELAY CONTROL SYSTEM

< FUNCTION DIAGNOSIS >

[IPDM E/R]

Component Parts Location

INFOID:000000004056799

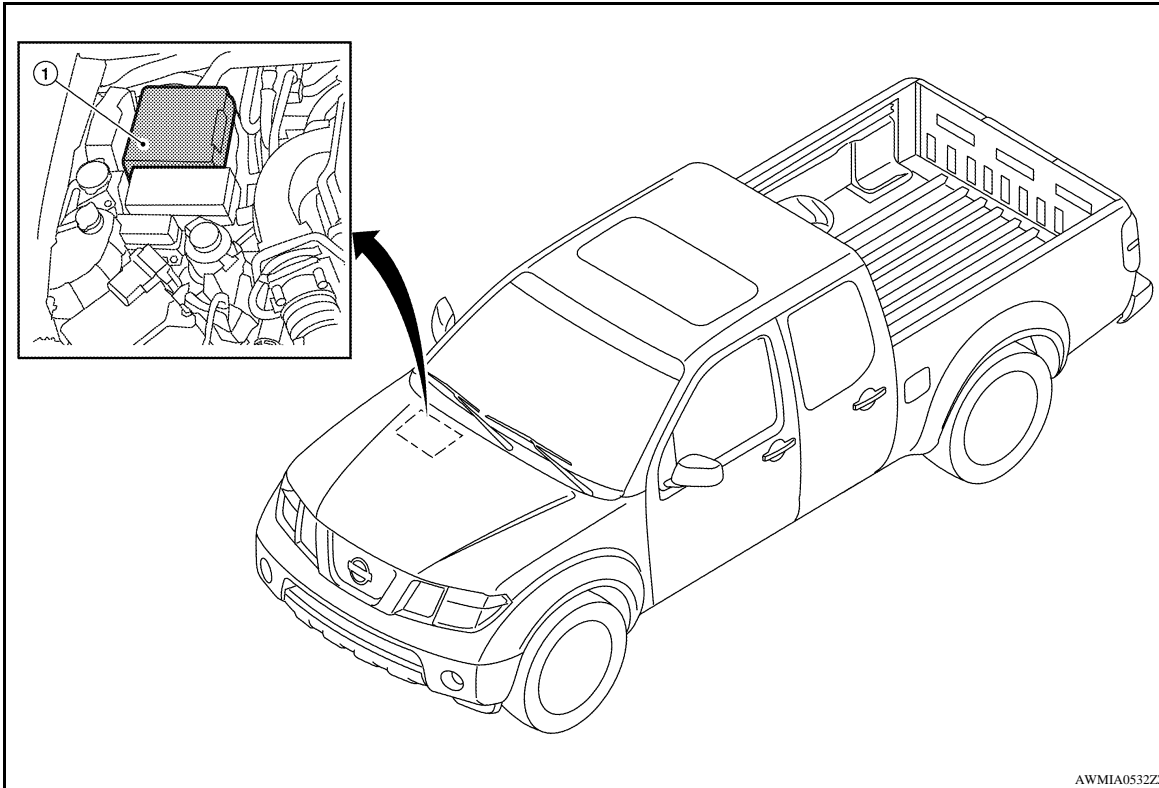

1. IPDM E/R E118, E119, E120, E121, E122, E123, E124

A
B
C
D
E
F
G
H
I
J
K
L

PCS

N
O
P

POWER DISTRIBUTION SYSTEM

< FUNCTION DIAGNOSIS >

[IPDM E/R]

POWER DISTRIBUTION SYSTEM

System Description

INFOID:000000004056800

INPUT/OUTPUT SIGNAL CHART

Switch	Input Signal to BCM	BCM system	Actuator
Ignition switch	Ignition switch	Power distribution system	<ul style="list-style-type: none"> • Ignition relay (IPDM E/R) • ACC relay • Blower relay
A/T device	P range		
PNP switch	N, P range		

SYSTEM DESCRIPTION

- PDS (POWER DISTRIBUTION SYSTEM) is the system that BCM controls with the operation of the ignition switch and performs the power distribution to each power circuit.
- The ignition switch operation is input to BCM as a signal. BCM changes the power supply position according to the status and operates the ignition relay (inside IPDM E/R) to supply power to each power circuit.

Component Parts Location

INFOID:000000004056801

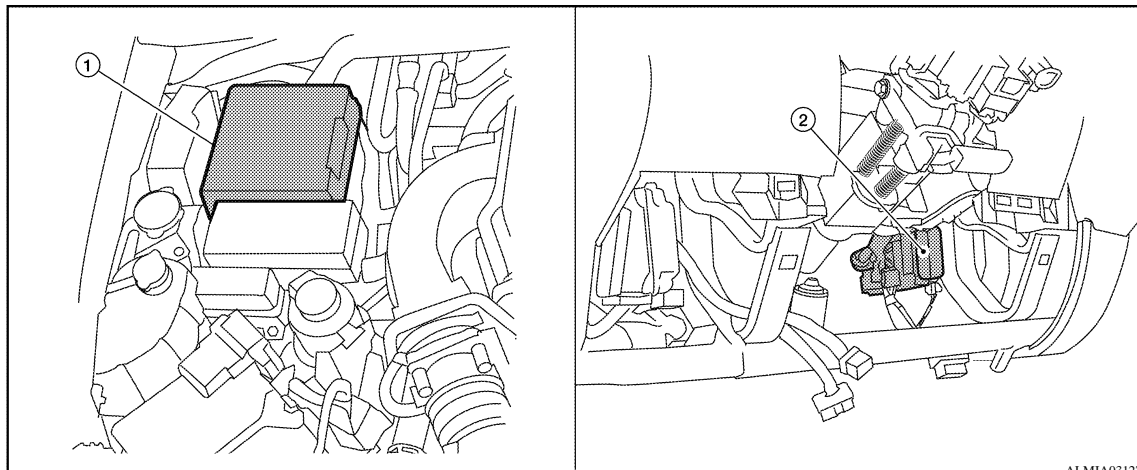

1. IPDM E/R (contains ignition relay) E118, E119, E120, E121, E122, E123, E124
2. BCM (view with lower instrument panel LH removed) M18, M19, M20

Component Description

INFOID:000000004056802

BCM	Reference
IPDM E/R	PCS-6
Ignition relay (in IPDM E/R)	PCS-6
Park/neutral position switch	TM-163

POWER CONTROL SYSTEM

System Diagram

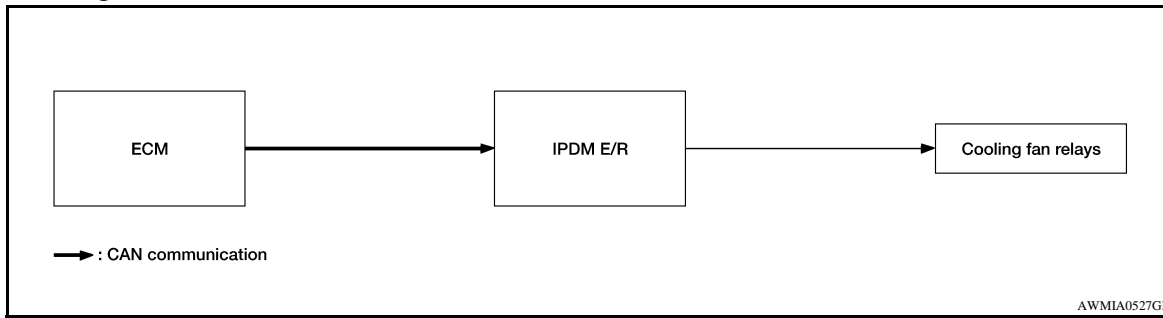

INFOID:000000004056803

AWMLA0527G

System Description

INFOID:000000004056804

COOLING FAN CONTROL

IPDM E/R controls the cooling fan according to the status of the cooling fan speed request signal received from ECM via CAN communication. Refer to [LAN-4, "System Description"](#).

A
B
C
D
E
F
G
H
I
J
K
L
N
O
P

PCS

SIGNAL BUFFER SYSTEM

< FUNCTION DIAGNOSIS >

[IPDM E/R]

SIGNAL BUFFER SYSTEM

System Diagram

INFOID:000000004056805

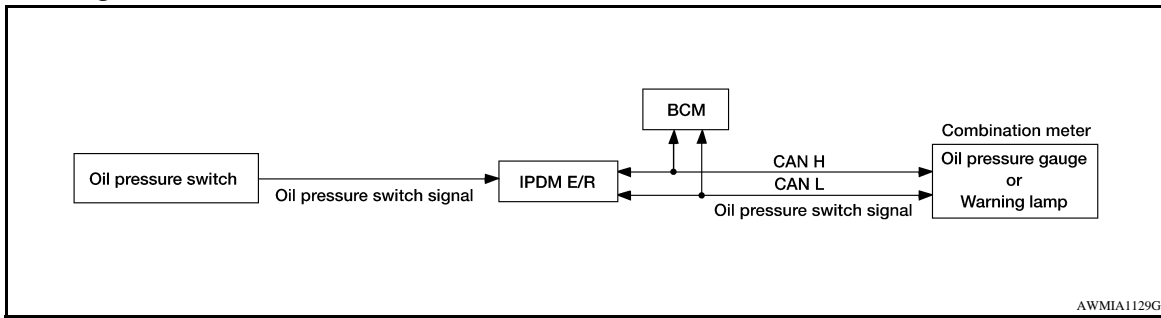

System Description

INFOID:000000004056806

IPDM E/R reads the status of the oil pressure switch and transmits the oil pressure switch signal to BCM via CAN communication. Refer to [LAN-4, "System Description"](#).

POWER CONSUMPTION CONTROL SYSTEM

System Diagram

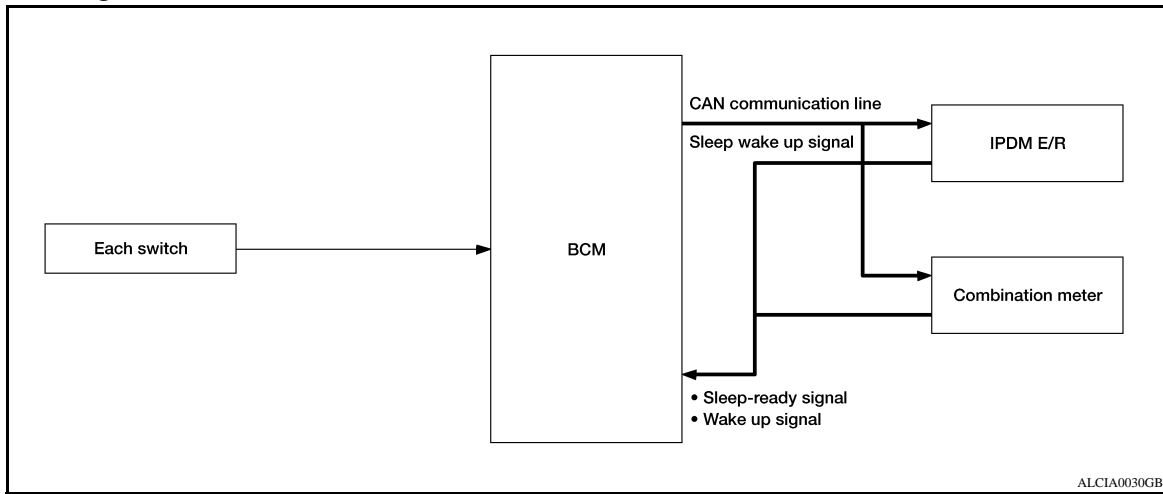

System Description

INFOID:000000004056808

OUTLINE

- IPDM E/R incorporates a power consumption control function that reduces the power consumption according to the vehicle status.
- IPDM E/R changes its status (control mode) with the sleep wake up signal received from BCM via CAN communication.

Normal mode (wake-up)

- CAN communication is normally performed with other control units.
- Individual unit control by IPDM E/R is normally performed.

Low power consumption mode (sleep)

- Low power consumption control is active.
- CAN transmission is stopped.

SLEEP MODE ACTIVATION

- IPDM E/R judges that the sleep-ready conditions are fulfilled when the ignition switch is OFF and none of the conditions below are present. Then it transmits a sleep-ready signal (ready) to BCM via CAN communication.
 - Front wiper fail-safe operation
 - Outputting signals to actuators
 - Switches or relays operating
 - Auto active test is starting
 - Emergency OFF
 - Output requests are being received from control units via CAN communication.
- IPDM E/R stops CAN communication and enters the low power consumption mode when it receives a sleep wake up signal (sleep) from BCM and the sleep-ready conditions are fulfilled.

WAKE-UP OPERATION

- IPDM E/R changes from the low power consumption mode to the normal mode when it receives a sleep wake-up signal (wake up) from BCM or any of the following conditions is fulfilled. In addition, it transmits a sleep-ready signal (not-ready) to BCM via CAN communication to report the CAN communication start.
 - Ignition switch ON
 - An output request is received from a control unit via CAN communication.

A
B
C
D
E
F
G
H
I
J
K
L
N
O
P

PCS

POWER CONSUMPTION CONTROL SYSTEM

< FUNCTION DIAGNOSIS >

[IPDM E/R]

Component Parts Location

INFOID:000000004056809

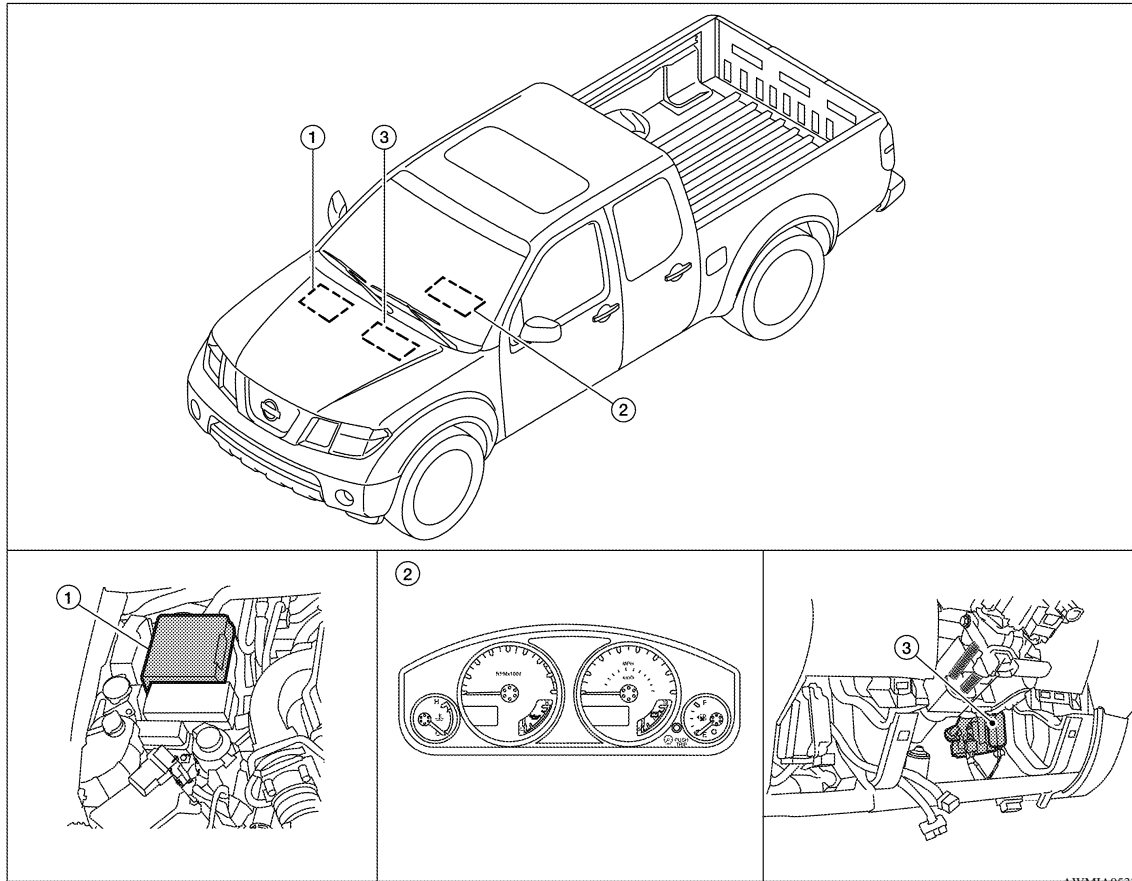

AWMIA0533ZZ

1. IPDM E/R E118, E119, E120, E121, E122, E123, E124
2. Combination meter M24
3. BCM (view with lower instrument panel LH removed) M18, M19, M20

DIAGNOSIS SYSTEM (IPDM E/R)

Diagnosis Description

INFOID:000000004056810

AUTO ACTIVE TEST

Description

In auto active test mode, the IPDM E/R sends a drive signal to the following systems to check their operation.

- Oil pressure low warning indicator
- Oil pressure gauge (if equipped)
- Rear window defogger
- Front wipers
- Tail, license and parking lamps
- Front fog lamps (if equipped)
- Headlamps (Hi, Lo)
- A/C compressor (magnetic clutch) (if equipped)
- Cooling fan

Operation Procedure

1. Close the hood and front door RH, and lift the wiper arms from the windshield (to prevent windshield damage due to wiper operation).
NOTE:
 When auto active test is performed with hood opened, sprinkle water on windshield before hand.
2. Turn ignition switch OFF.
3. Turn the ignition switch ON and, within 20 seconds, press the front door switch LH 10 times. Then turn the ignition switch OFF.
4. Turn the ignition switch ON within 10 seconds. After that the horn sounds once and the auto active test starts.
5. After a series of the following operations is repeated 3 times, auto active test is completed.

NOTE:

When auto active test mode has to be cancelled halfway through test, turn ignition switch OFF.

CAUTION:

- If auto active test mode cannot be actuated, check door switch system. Refer to [DLK-27, "KING CAB : Description"](#) or [DLK-29, "CREW CAB : Description"](#).
- Do not start the engine.

Inspection in Auto Active Test Mode

When auto active test mode is actuated, the following 7 steps are repeated 3 times.

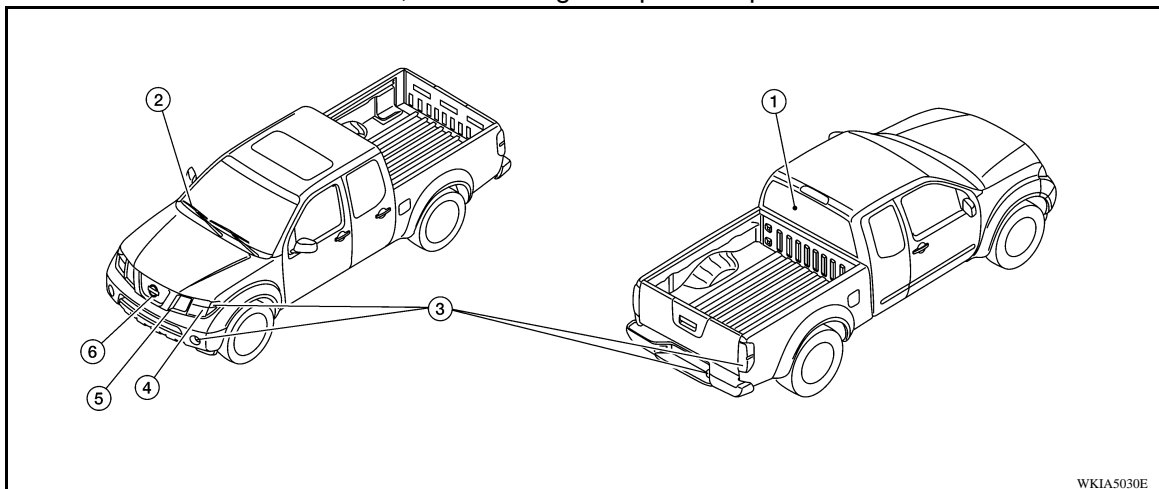

Item Number	Test Item	Operation Time/Frequency
1	Rear window defogger (Crew cab only)	10 seconds
2	Front wipers	LOW 5 seconds then HIGH 5 seconds
3	Tail, license plate, front fog and parking lamps	10 seconds

A
B
C
D
E
F
G
H
I
J
K
L

PCS

N
O
P

DIAGNOSIS SYSTEM (IPDM E/R)

< FUNCTION DIAGNOSIS >

[IPDM E/R]

Item Number	Test Item	Operation Time/Frequency
4	Headlamps	Low ON for 10 seconds, then High ON-OFF five times.
5	A/C compressor (magnet clutch) (if equipped)	ON-OFF 5 times
6	Cooling fan	LOW 5 seconds then HIGH 5 seconds

Concept of auto active test

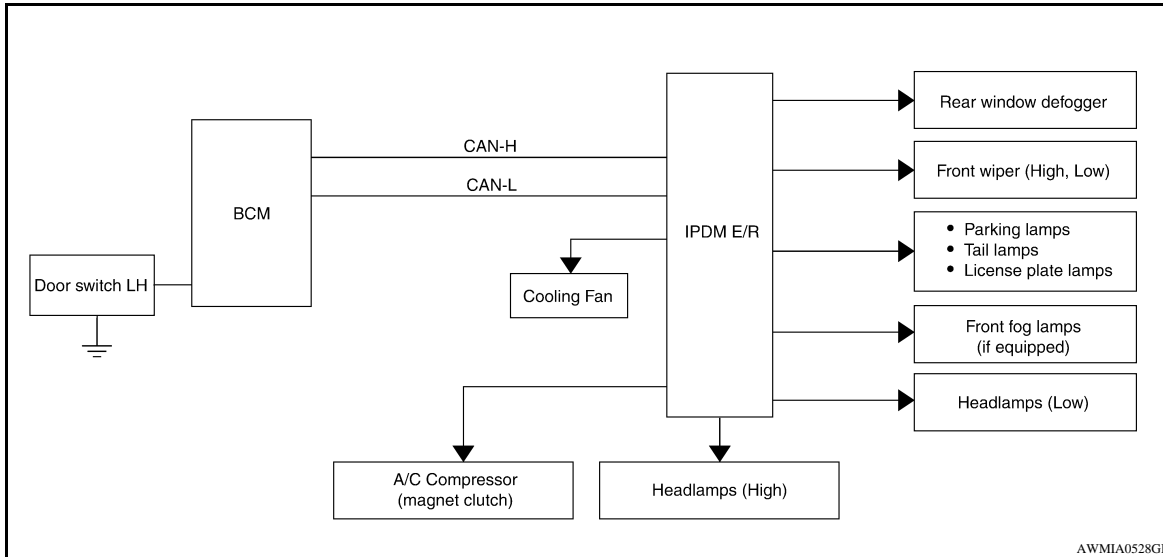

- IPDM E/R starts the auto active test with the door switch signals transmitted by BCM via CAN communication. Therefore, the CAN communication line between IPDM E/R and BCM is considered normal if the auto active test starts successfully.
- The auto active test facilitates troubleshooting if any systems controlled by IPDM E/R cannot be operated.

Diagnosis chart in auto active test mode

Symptom	Inspection contents		Possible cause
Oil pressure low warning indicator does not operate	Perform auto active test. Does the oil pressure low warning indicator operate?	YES	<ul style="list-style-type: none"> • IPDM E/R signal input circuit • ECM signal input circuit • CAN communication signal between ECM and combination meter
		NO	<ul style="list-style-type: none"> • CAN communication signal between IPDM E/R, BCM and combination meter
Oil pressure gauge does not operate	Perform auto active test. Does the oil pressure gauge operate?	YES	IPDM E/R signal input circuit
		NO	<ul style="list-style-type: none"> • CAN communication signal between IPDM E/R, BCM and combination meter
Rear window defogger does not operate	Perform auto active test. Does the rear window defogger operate?	YES	BCM signal input circuit
		NO	<ul style="list-style-type: none"> • Harness or connector between A/C and AV switch assembly and AV control unit • CAN communication signal between BCM and IPDM E/R

DIAGNOSIS SYSTEM (IPDM E/R)

< FUNCTION DIAGNOSIS >

[IPDM E/R]

Symptom	Inspection contents		Possible cause
Any of the following components do not operate <ul style="list-style-type: none"> • Front wipers • Tail lamps • License plate lamps • Parking lamps • Front fog lamps (if equipped) • Headlamps (Hi, Lo) 	Perform auto active test. Does the applicable system operate?	YES	BCM signal input system
		NO	<ul style="list-style-type: none"> • Lamp or front wiper motor malfunction • Lamp or front wiper motor ground circuit • Harness or connector between IPDM E/R and applicable system • IPDM E/R (integrated relay malfunction)
A/C compressor does not operate	Perform auto active test. Does the A/C compressor operate?	YES	<ul style="list-style-type: none"> • BCM signal input circuit • CAN communication signal between BCM and ECM • CAN communication signal between ECM and IPDM E/R
		NO	<ul style="list-style-type: none"> • Magnetic clutch malfunction • Harness or connector between IPDM E/R and magnetic clutch • IPDM E/R (integrated relay malfunction)
Cooling fan does not operate	Perform auto active test. Does the cooling fan operate?	YES	<ul style="list-style-type: none"> • ECM signal input circuit • CAN communication signal between ECM and IPDM E/R
		NO	<ul style="list-style-type: none"> • Cooling fan motor malfunction • Harness or connector between IPDM E/R and cooling fan • IPDM E/R (integrated relay malfunction)

CONSULT - III Function (IPDM E/R)

INFOID:000000004056811

APPLICATION ITEM

CONSULT-III performs the following functions via CAN communication with IPDM E/R.

Diagnosis mode	Description
ECU Identification	Allows confirmation of IPDM E/R part number.
Self Diagnostic Result	Displays the diagnosis results judged by IPDM E/R.
Data Monitor	Displays the real-time input/output data from IPDM E/R input/output data.
Active Test	IPDM E/R can provide a drive signal to electronic components to check their operations.
CAN Diag Support Monitor	The results of transmit/receive diagnosis of CAN communication can be read.

SELF DIAGNOSTIC

Refer to [PCS-32, "DTC Index"](#).

DATA MONITOR

Monitor item

DIAGNOSIS SYSTEM (IPDM E/R)

< FUNCTION DIAGNOSIS >

[IPDM E/R]

Monitor Item [Unit]	MAIN SIG- NALS	Description
MOTOR FAN REQ [1/2/3/4]	×	Displays the status of the cooling fan speed request signal received from ECM via CAN communication.
A/C COMP REQ [OFF/ON]	×	Displays the status of the A/C request signal received from BCM via CAN communication.
TAIL&CLR REQ [OFF/ON]	×	Displays the status of the position light request signal received from BCM via CAN communication.
HL LO REQ [OFF/ON]	×	Displays the status of the low beam request signal received from BCM via CAN communication.
HL HI REQ [OFF/ON]	×	Displays the status of the high beam request signal received from BCM via CAN communication.
FR FOG REQ [OFF/ON]	×	Displays the status of the front fog lamp request signal received from BCM via CAN communication.
HL WASHER REQ [OFF/ON]		NOTE: This item is displayed, but cannot be monitored.
FR WIP REQ [STOP/1LOW/LOW/HI]	×	Displays the status of the front wiper request signal received from BCM via CAN communication.
WIP AUTO STOP [STOP P/ACT P]	×	Displays the status of the front wiper auto stop signal judged by IPDM E/R.
WIP PROT [OFF/Block]	×	Displays the status of the front wiper fail-safe operation judged by IPDM E/R.
ST RLY REQ [OFF/ON]		Displays the status of the starter request signal received from ECM via CAN communication.
IGN RLY [OFF/ON]	×	Displays the status of the ignition relay judged by IPDM E/R.
RR DEF REQ [OFF/ON]	×	Displays the status of the rear defogger request signal received from AV control unit via CAN communication.
OIL P SW [OPEN/CLOSE]		Displays the status of the oil pressure switch judged by IPDM E/R.
DTRL REQ [OFF]		NOTE: This item is displayed, but cannot be monitored.
HOOD SW [OPEN/CLOSE]		NOTE: This item is displayed, but cannot be monitored.
THFT HRN REQ [OFF/ON]		Displays the status of the theft warning horn request signal received from BCM via CAN communication.
HORN CHIRP [OFF/ON]		Displays the status of the horn reminder signal received from BCM via CAN communication.

ACTIVE TEST

Test item

Test item	Operation	Description
REAR DEFOGGER	OFF	OFF
	ON	Operates rear window defogger relay.
FRONT WIPER	OFF	OFF
	LO	Operates the front wiper relay.
	HI	Operates the front wiper relay and front wiper high relay.
HEAD LAMP WASHER	ON	—

DIAGNOSIS SYSTEM (IPDM E/R)

< FUNCTION DIAGNOSIS >

[IPDM E/R]

Test item	Operation	Description
MOTOR FAN	1	OFF
	2	OFF
	3	Operates the cooling fan relay.
	4	Operates the cooling fan relay.
EXTERNAL LAMPS	OFF	OFF
	TAIL	Operates the tail lamp relay.
	LO	Operates the headlamp low relay.
	HI	Operates the headlamp low relay and the headlamp (LH/RH) high relays alternately at 1 second intervals.
	FOG	Operates the front fog lamp relay
HORN	ON	Operates horn relay for 20 ms.

A
B
C
D
E
F
G
H
I
J
K
L

PCS

N
O
P

U1000 CAN COMM CIRCUIT

< COMPONENT DIAGNOSIS >

[IPDM E/R]

COMPONENT DIAGNOSIS

U1000 CAN COMM CIRCUIT

Description

INFOID:000000004056812

Refer to [LAN-4, "System Description"](#).

DTC Logic

INFOID:000000004056813

DTC DETECTION LOGIC

DTC	CONSULT-III display description	DTC Detection Condition	Possible cause
U1000	CAN COMM CIRCUIT	When IPDM E/R cannot communicate CAN communication signal continuously for 2 seconds or more	In CAN communication system, any item (or items) of the following listed below is malfunctioning. <ul style="list-style-type: none">• Receiving (TCM)• Receiving (ECM)• Receiving (BCM)• Receiving (Combination meter)

DTC CONFIRMATION PROCEDURE

Diagnosis Procedure

INFOID:000000004056814

1. PERFORM SELF DIAGNOSTIC

1. Turn ignition switch ON and wait for 2 seconds or more.
2. Check "SELF-DIAG RESULTS" of IPDM E/R.

Is "CAN COMM CIRCUIT" displayed?

- YES >> Refer to [LAN-5, "CAN Communication Control Circuit"](#).
NO >> Refer to [GI-49, "Intermittent Incident"](#).

POWER SUPPLY AND GROUND CIRCUIT

< COMPONENT DIAGNOSIS >

[IPDM E/R]

POWER SUPPLY AND GROUND CIRCUIT

Diagnosis Procedure

INFOID:000000004056815

1. CHECK FUSIBLE LINKS

Check that the following IPDM E/R fusible links are not blown.

Terminal No.	Signal name	Fusible link No.
1	Battery	A, D
2		C
22		I

Is the fusible link blown?

- YES >> Replace the blown fusible link after repairing the affected circuit.
 NO >> GO TO 2

2. CHECK BATTERY POWER SUPPLY CIRCUIT

- Turn ignition switch OFF.
- Disconnect IPDM E/R.
- Check voltage between IPDM E/R harness connectors and ground.

Terminals		Ignition switch position	Voltage (V) (Approx.)	
(+)	(-)			
E118 (A)	1	Ground	OFF	Battery voltage
	2			
E120 (B)	22			

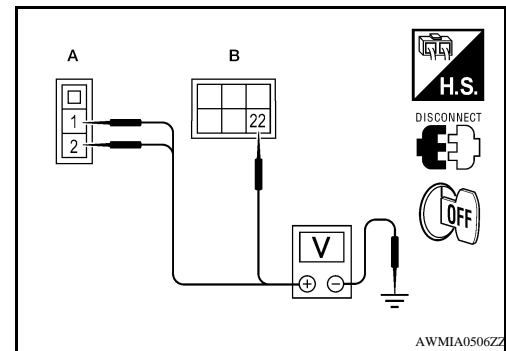

Is there voltage on all pins?

- YES >> GO TO 3
 NO >> Repair or replace harness.

3. CHECK GROUND CIRCUIT

- Turn ignition switch OFF.
- Check continuity between IPDM E/R harness connectors and ground.

IPDM E/R		Ground	Continuity
Connector	Terminal		
E122 (A)	38	Ground	Yes
E124 (B)	59		

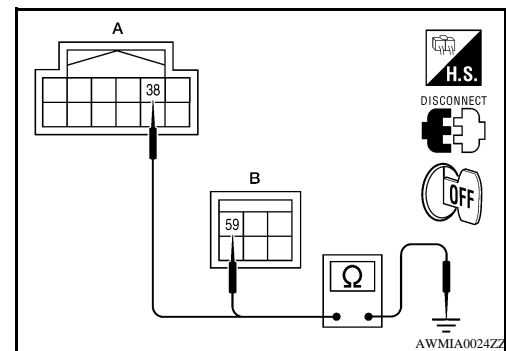

Does continuity exist?

- YES >> Inspection End.
 NO >> Repair or replace harness.

IPDM E/R (INTELLIGENT POWER DISTRIBUTION MODULE ENGINE ROOM)

< ECU DIAGNOSIS >

[IPDM E/R]

ECU DIAGNOSIS

IPDM E/R (INTELLIGENT POWER DISTRIBUTION MODULE ENGINE ROOM)

Reference Value

INFOID:000000004056816

VALUES ON THE DIAGNOSIS TOOL

Monitor Item	Condition		Value/Status
MOTOR FAN REQ	Engine idle speed	Changes depending on engine coolant temperature, air conditioner operation status, vehicle speed, etc.	0 - 100 %
A/C COMP REQ	A/C switch OFF		OFF
	A/C switch ON		ON
TAIL&CLR REQ	Lighting switch OFF		OFF
	Lighting switch 1ST, 2ND, HI or AUTO (Light is illuminated)		ON
HL LO REQ	Lighting switch OFF		OFF
	Lighting switch 2ND HI or AUTO (Light is illuminated)		ON
HL HI REQ	Lighting switch OFF		OFF
	Lighting switch HI		ON
FR FOG REQ	Lighting switch 2ND	Front fog lamp switch OFF	OFF
		Front fog lamp switch ON	ON
H L WASHER REQ	NOTE: This item is displayed, but cannot be monitored.		OFF
FR WIP REQ	Ignition switch ON	Front wiper switch OFF	STOP
		Front wiper switch INT	1LOW
		Front wiper switch LO	LOW
		Front wiper switch HI	HI
WIP AUTO STOP	Ignition switch ON	Front wiper stop position	STOP P
		Any position other than front wiper stop position	ACT P
WIP PROT	Ignition switch ON	Front wiper operates normally	OFF
		Front wiper stops at fail-safe operation	BLOCK
ST RLY REQ	Ignition switch OFF or ACC		OFF
	Ignition switch START		ON
IGN RLY	Ignition switch OFF or ACC		OFF
	Ignition switch ON		ON
RR DEF REQ	Rear defogger switch OFF		OFF
	Rear defogger switch ON		ON
OIL P SW	Ignition switch OFF, ACC or engine running		OPEN
	Ignition switch ON		CLOSE
DTRL REQ	NOTE: This item is displayed, but cannot be monitored.		OFF
HOOD SW	NOTE: This item is displayed, but cannot be monitored.		OFF

IPDM E/R (INTELLIGENT POWER DISTRIBUTION MODULE ENGINE ROOM)

< ECU DIAGNOSIS >

[IPDM E/R]

Monitor Item	Condition	Value/Status
THFT HRN REQ	Not operated	OFF
	<ul style="list-style-type: none"> • Panic alarm is activated • Horn is activated with VEHICLE SECURITY (THEFT WARNING) SYSTEM 	ON
HORN CHIRP	Not operated	OFF
	Door locking with keyfob (horn chirp mode)	ON

A

B

C

D

E

F

G

H

I

J

K

L

PCS

N

O

P

IPDM E/R (INTELLIGENT POWER DISTRIBUTION MODULE ENGINE ROOM)

< ECU DIAGNOSIS >

[IPDM E/R]

Terminal Layout

INFOID:000000004056817

TERMINAL LAYOUT

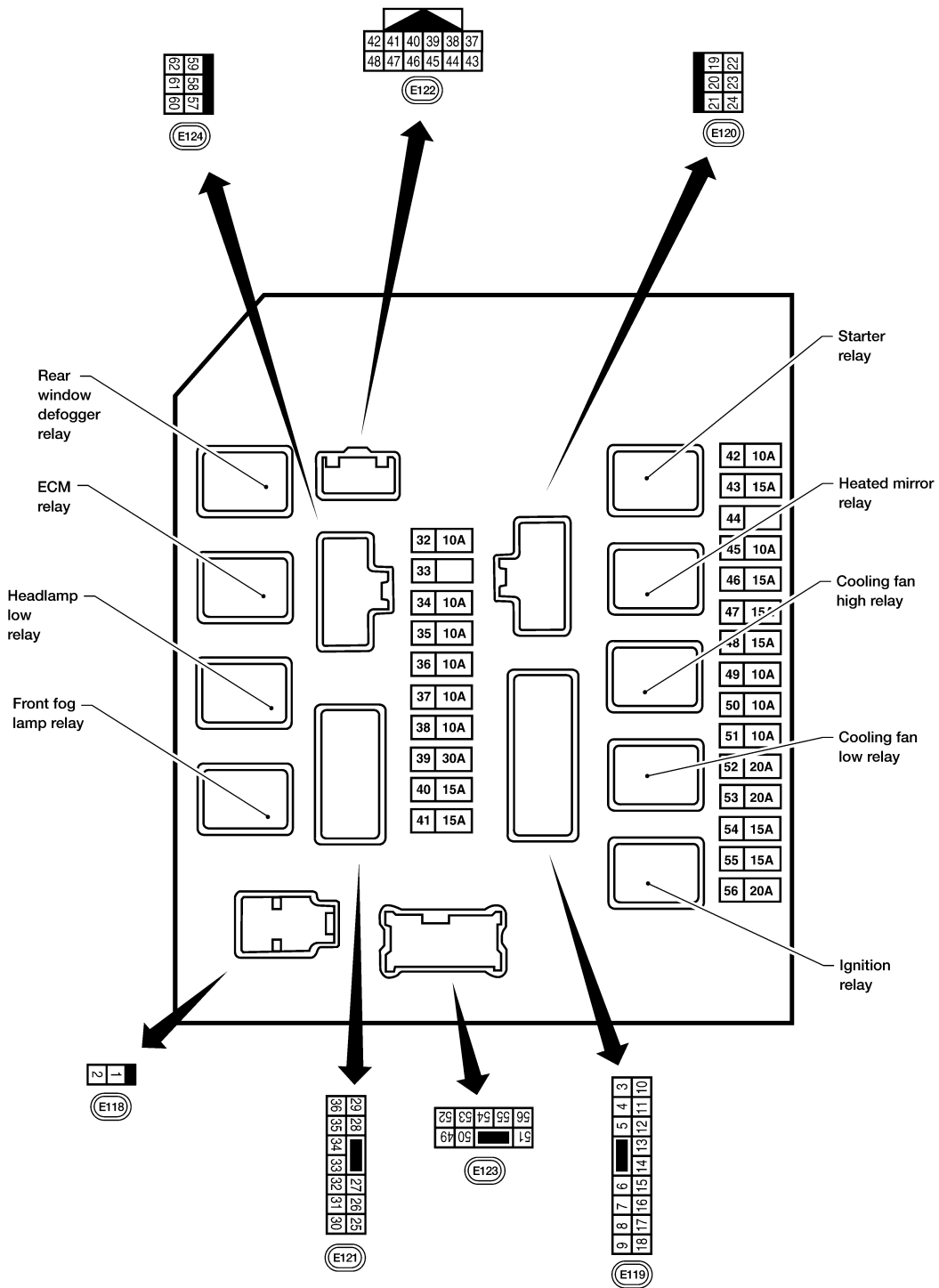

Physical Values

PHYSICAL VALUES

WKIA5883E

INFOID:000000004056818

IPDM E/R (INTELLIGENT POWER DISTRIBUTION MODULE ENGINE ROOM)

< ECU DIAGNOSIS >

[IPDM E/R]

Terminal	Wire color	Signal name	Signal input/output	Measuring condition		Reference value (Approx.)
				Ignition switch	Operation or condition	
1	W	Battery power supply	Input	OFF	—	Battery voltage
2	R	Battery power supply	Input	OFF	—	Battery voltage
3	G	ECM relay	Output	—	Ignition switch ON or START	Battery voltage
					Ignition switch OFF or ACC	0V
4	P	ECM relay	Output	—	Ignition switch ON or START	Battery voltage
					Ignition switch OFF or ACC	0V
6	V	Throttle control motor relay	Output	—	Ignition switch ON or START	Battery voltage
					Ignition switch OFF or ACC	0V
7	BR	ECM relay control	Input	—	Ignition switch ON or START	0V
					Ignition switch OFF or ACC	Battery voltage
8	W/R	Fuse 54	Output	—	Ignition switch ON or START	Battery voltage
					Ignition switch OFF or ACC	0V
10	R/B	Fuse 45	Output	ON	Daytime light system active	0V
					Daytime light system inactive	Battery voltage
11	Y	A/C compressor	Output	ON or START	A/C switch ON or defrost A/C switch	Battery voltage
					A/C switch OFF or defrost A/C switch	0V
12	W/G	Ignition switch supplied power	Input	—	OFF or ACC	0V
					ON or START	Battery voltage
13	R	Fuel pump relay	Output	—	Ignition switch ON or START	Battery voltage
					Ignition switch OFF or ACC	0V
14	W/G	Fuse 49	Output	—	Ignition switch ON or START	Battery voltage
					Ignition switch OFF or ACC	0V
15	W/R	Fuse 50 (ABS)	Output	—	Ignition switch ON or START	Battery voltage
					Ignition switch OFF or ACC	0V
16	W/G	Fuse 51	Output	—	Ignition switch ON or START	Battery voltage
					Ignition switch OFF or ACC	0V
17	W/G	Fuse 55	Output	—	Ignition switch ON or START	Battery voltage
					Ignition switch OFF or ACC	0V
19	W	Starter motor	Output	START	—	Battery voltage
20	BR	Cooling fan motor (low)	Output	ON or START	—	Battery voltage
21	GR	Ignition switch supplied power	Input	—	OFF or ACC	0V
					START	Battery voltage
22	G	Battery power supply	Output	OFF	—	Battery voltage
23	LG	Door mirror defogger output signal	Output	—	When rear defogger switch is ON	Battery voltage
					When raker defogger switch is OFF	0V

A
B
C
D
E
F
G
H
I
J
K
L
N
O
P

PCS

IPDM E/R (INTELLIGENT POWER DISTRIBUTION MODULE ENGINE ROOM)

< ECU DIAGNOSIS >

[IPDM E/R]

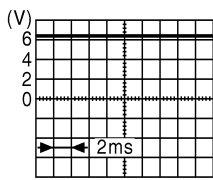
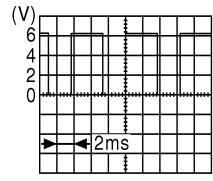
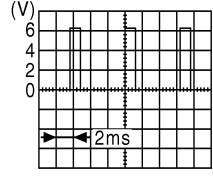
Terminal	Wire color	Signal name	Signal input/output	Measuring condition		Reference value (Approx.)
				Ignition switch	Operation or condition	
24	P	Cooling fan motor (high)	Output	—	Conditions correct for cooling fan operation	Battery voltage
					Conditions not correct for cooling fan operation	0V
27	W	Fuse 38	Output	—	Ignition switch ON or START	Battery voltage
					Ignition switch OFF or ACC	0V
28	R	LH front parking and front side marker lamp	Output	OFF	Lighting switch 1st position OFF	0V
					Lighting switch 1st position ON	Battery voltage
29	G	Trailer tow relay	Output	ON	Lighting switch 1st position OFF	0V
					Lighting switch 1st position ON	Battery voltage
30	R/B	Fuse 53	Output	—	Ignition switch ON or START	Battery voltage
					Ignition switch OFF or ACC	0V
32	GR	Wiper low speed signal	Output	ON or START	Wiper switch OFF	Battery voltage
					Wiper switch LO or INT	0V
35	L	Wiper high speed signal	Output	ON or START	Wiper switch OFF, LO, INT	Battery voltage
					Wiper switch HI	0V
37	Y	Power generation command signal	Output	—	Ignition switch ON	 <p style="text-align: right;">6.3 V</p>
					40% is set on "Active test," "ALTERNATOR DUTY" of "ENGINE"	 <p style="text-align: right;">3.8 V</p>
					40% is set on "Active test," "ALTERNATOR DUTY" of "ENGINE"	 <p style="text-align: right;">1.4 V</p>
38	B	Ground	Input	—	—	0V
39	L	CAN-H	—	ON	—	—
40	P	CAN-L	—	ON	—	—
42	GR	Oil pressure switch	Input	—	Engine running	Battery voltage
					Engine stopped	0V

IPDM E/R (INTELLIGENT POWER DISTRIBUTION MODULE ENGINE ROOM)

< ECU DIAGNOSIS >

[IPDM E/R]

Terminal	Wire color	Signal name	Signal input/output	Measuring condition		Reference value (Approx.)
				Ignition switch	Operation or condition	
43	G	Wiper auto stop signal	Input	ON or START	Wiper switch OFF, LO, INT	Battery voltage
44	R	Daytime light relay control (Canada only)	Input	ON	Daytime light system active	0V
					Daytime light system inactive	Battery voltage
45	LG	Horn relay control	Input	ON	When door locks are operated using keyfob (OFF → ON)*	Battery voltage → 0V
46	V	Fuel pump relay control	Input	—	Ignition switch ON or START	0V
					Ignition switch OFF or ACC	Battery voltage
47	O	Throttle control motor relay control	Input	—	Ignition switch ON or START	0V
					Ignition switch OFF or ACC	Battery voltage
48	R	Starter relay (inhibit switch)	Input	ON or START	Selector lever in "P" or "N"	0V
					Selector lever any other position	Battery voltage
49	GR	Front RH parking and front side marker lamp	Output	OFF	Lighting switch 1st position OFF	0V
					Lighting switch 1st position ON	Battery voltage
50	W	Front fog lamp (LH)	Output	ON or START	Lighting switch must be in the 2nd position (LOW beam is ON) and the front fog lamp switch OFF	0V
					Lighting switch must be in the 2nd position (LOW beam is ON) and the front fog lamp switch ON	Battery voltage
51	V	Front fog lamp (RH)	Output	ON or START	Lighting switch must be in the 2nd position (LOW beam is ON) and the front fog lamp switch OFF	0V
					Lighting switch must be in the 2nd position (LOW beam is ON) and the front fog lamp switch ON	Battery voltage
52	P	LH low beam head-lamp	Output	—	Lighting switch in 2nd position	Battery voltage
54	R	RH low beam head-lamp	Output	—	Lighting switch in 2nd position	Battery voltage
55	G	LH high beam head-lamp	Output	—	Lighting switch in 2nd position and placed in HIGH or PASS position	Battery voltage
56	L	RH high beam head-lamp	Output	—	Lighting switch in 2nd position and placed in HIGH or PASS position	Battery voltage
57	GR	Parking, license, and tail lamp	Output	ON	Lighting switch 1st position OFF	0V
					Lighting switch 1st position ON	Battery voltage
59	B	Ground	Input	—	—	0V
60	GR	Rear window defogger relay	Output	ON or START	Rear defogger switch ON	Battery voltage
					Rear defogger switch OFF	0V
61	R/B	Fuse 32	Output	OFF	—	Battery voltage

*: When horn reminder is ON

IPDM E/R (INTELLIGENT POWER DISTRIBUTION MODULE ENGINE ROOM)

< ECU DIAGNOSIS >

[IPDM E/R]

Wiring Diagram

INFOID:000000004056819

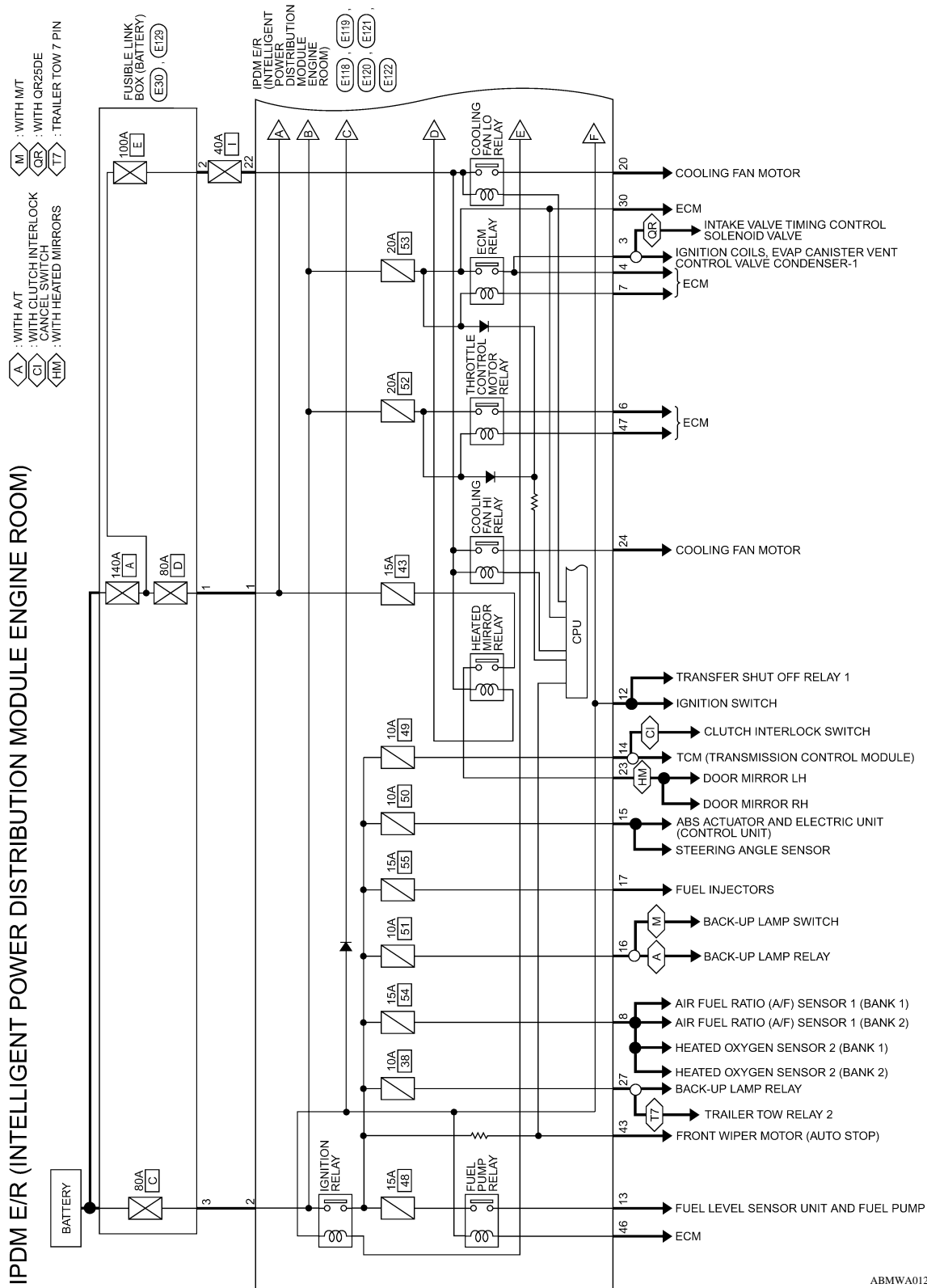

ABMWA0126GI

IPDM E/R (INTELLIGENT POWER DISTRIBUTION MODULE ENGINE ROOM) CONNECTORS

Connector No.	E30
Connector Name	FUSIBLE LINK BOX (BATTERY)
Connector Color	-



Terminal No.	Color of Wire	Signal Name
3	R	-

Connector No.	E118
Connector Name	IPDM E/R (INTELLIGENT POWER DISTRIBUTION MODULE ENGINE ROOM)
Connector Color	BLACK



Terminal No.	Color of Wire	Signal Name
1	W	F/L USM
2	R	F/L MAIN

Connector No.	E119
Connector Name	IPDM E/R (INTELLIGENT POWER DISTRIBUTION MODULE ENGINE ROOM)
Connector Color	WHITE



Terminal No.	Color of Wire	Signal Name
3	G	IGN COIL
4	P	ECM
5	-	-
6	V	ETC

Terminal No.	Color of Wire	Signal Name
7	BR	ECM RLY CONT
8	W/R	O2 SENSOR
9	-	-
10	R/B	DTRL RLY SUPPLY
11	Y	A/C COMPRESSOR
12	W/G	IGN SW (IG1)
13	R	FUEL PUMP
14	W/G	A/T ECU IGN SUPPLY
15	W/R	ABS IGN SUPPLY
16	W/G	REVERSE LAMP
17	W/G	INJECTOR
18	-	-

Connector No.	E120
Connector Name	IPDM E/R (INTELLIGENT POWER DISTRIBUTION MODULE ENGINE ROOM)
Connector Color	WHITE

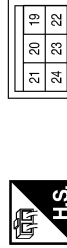

Terminal No.	Color of Wire	Signal Name
19	W	STARTER MTR
20	BR	MOTOR FAN 1
21	GR	IGN SW (ST)
22	G	F/L M/FAN
23	LG	HEATED MIRROR
24	P	MOTOR FAN 2

IPDM E/R (INTELLIGENT POWER DISTRIBUTION MODULE ENGINE ROOM)

< ECU DIAGNOSIS >

[IPDM E/R]

Connector No.	E123
Connector Name	IPDM E/R (INTELLIGENT POWER DISTRIBUTION MODULE ENGINE ROOM)
Connector Color	BROWN

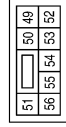

Terminal No.	Color of Wire	Signal Name
49	GR	ILLUMINATION
50	W	FR FOG LAMP LH
51	V	FR FOG LAMP RH
52	P	H/LAMP LO LH
53	-	-
54	R	H/LAMP LO RH
55	G	H/LAMP HI LH
56	L	H/LAMP HI RH

Connector No.	E122
Connector Name	IPDM E/R (INTELLIGENT POWER DISTRIBUTION MODULE ENGINE ROOM)
Connector Color	WHITE

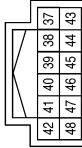

Terminal No.	Color of Wire	Signal Name
37	Y	ALT-C CONT
38	B	GND (SIGNAL)
39	L	CAN-H
40	P	CAN-L
41	-	-
42	GR	OIL PRESSURE SW
43	G	AUTO STOP SW
44	R	DTRL RLY CONT
45	LG	ANT THEFT HORN
46	V	FUEL PUMP RLY CONT
47	O	ETC RLY CONT
48	R	INHIBIT SW

Connector No.	E121
Connector Name	IPDM E/R (INTELLIGENT POWER DISTRIBUTION MODULE ENGINE ROOM)
Connector Color	BROWN

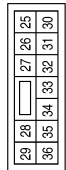



Terminal No.	Color of Wire	Signal Name
25	-	-
26	-	-
27	W	T TOW REV LAMP
28	R	ILLUMINATION
29	G	TRAILER RLY CONT
30	R/B	ECM BATT
31	-	-
32	GR	FR WIPER LO
33	-	-
34	-	-
35	L	FR WIPER HI
36	-	-

A
B
C
D
E
F
G
H
I
J
K
L
N
O
P

PCS



ABMLA0340GB

Connector No.	E129
Connector Name	FUSIBLE LINK BOX (BATTERY)
Connector Color	BROWN

Terminal No.	Color of Wire	Signal Name
1	W	-
2	R	-

Connector No.	E124
Connector Name	IPDM E/R (INTELLIGENT POWER DISTRIBUTION MODULE ENGINE ROOM)
Connector Color	BLACK

Terminal No.	Color of Wire	Signal Name
57	GR	TAIL LAMP
58	-	-
59	B	GND (POWER)
60	GR	RR DEF
61	R/B	TRAIL_RLY SUPPLY
62	-	-

ABMIA0341GB

INFOID:000000004056820

Fail Safe

CAN COMMUNICATION CONTROL

When CAN communication with ECM and BCM is impossible, IPDM E/R performs fail-safe control. After CAN communication recovers normally, it also returns to normal control.

If No CAN Communication Is Available With ECM

IPDM E/R (INTELLIGENT POWER DISTRIBUTION MODULE ENGINE ROOM)

< ECU DIAGNOSIS >

[IPDM E/R]

Control part	Fail-safe in operation
Cooling fan	<ul style="list-style-type: none"> • Turns ON the cooling fan relay when the ignition switch is turned ON • Turns OFF the cooling fan relay when the ignition switch is turned OFF

A

If No CAN Communication Is Available With BCM

B

Control part	Fail-safe in operation
Headlamp	<ul style="list-style-type: none"> • Turns ON the headlamp low relay when the ignition switch is turned ON • Turns OFF the headlamp low relay when the ignition switch is turned OFF • Headlamp (LH/RH) high relays OFF
<ul style="list-style-type: none"> • Parking lamps • License plate lamps • Tail lamps 	<ul style="list-style-type: none"> • Turns ON the tail lamp relay when the ignition switch is turned ON • Turns OFF the tail lamp relay when the ignition switch is turned OFF
Front wiper	<ul style="list-style-type: none"> • The status just before activation of fail-safe control is maintained until the ignition switch is turned OFF while the front wiper is operating at LO or HI speed. • The wiper is operated at LO speed until the ignition switch is turned OFF if the fail-safe control is activated while the front wiper is set in the INT mode and the front wiper motor is operating.
Rear window defogger	Rear window defogger relay OFF
A/C compressor (if equipped)	A/C relay OFF
Front fog lamps (if equipped)	Front fog lamp relay OFF

C

D

E

F

G

IGNITION RELAY MALFUNCTION DETECTION FUNCTION

- IPDM E/R monitors the voltage at the contact circuit and excitation coil circuit of the ignition relay inside it.
- IPDM E/R judges the ignition relay error if the voltage differs between the contact circuit and the excitation coil circuit.
- If the ignition relay cannot turn OFF due to contact seizure, it activates the tail lamp relay for 10 minutes to alert the user to the ignition relay malfunction when the ignition switch is turned OFF.

H

I

Ignition switch	Ignition relay	Tail lamp relay
ON	ON	—
OFF	OFF	—

J

NOTE:

The tail lamp turns OFF when the ignition switch is turned ON.

K

FRONT WIPER CONTROL

IPDM E/R detects front wiper stop position by a front wiper auto stop signal.

When a front wiper auto stop signal is in the conditions listed below, IPDM E/R stops power supply to wiper after repeating a front wiper 10 second activation and 20 second stop five times.

L

PCS

Ignition switch	Front wiper switch	Auto stop signal
ON	OFF	Front wiper stop position signal cannot be input 10 seconds.
	ON	The signal does not change for 10 seconds.

N

NOTE:

This operation status can be confirmed on the IPDM E/R “DATA MONITOR” that displays “Block” for the item “WIP PROT” while the wiper is stopped.

O

STARTER MOTOR PROTECTION FUNCTION

IPDM E/R turns OFF the starter control relay to protect the starter motor when the starter control relay remains active for 90 seconds.

P

IPDM E/R (INTELLIGENT POWER DISTRIBUTION MODULE ENGINE ROOM)

< ECU DIAGNOSIS >

[IPDM E/R]

DTC Index

INFOID:000000004056821

CONSULT-III display	Fail-safe	TIME ^{NOTE}		Refer to
No DTC is detected. further testing may be required.	—	—	—	—
U1000: CAN COMM CIRCUIT	×	CRNT	1 – 39	PCS-18

NOTE:

The details of TIME display are as follows.

- CRNT: The malfunctions that are detected now
- 1 - 39: The number is indicated when it is normal at present and a malfunction was detected in the past. It increases like 0 → 1 → 2 ... 38 → 39 after returning to the normal condition whenever IGN OFF → ON. It is fixed to 39 until the self-diagnosis results are erased if it is over 39. It returns to 0 when a malfunction is detected again in the process.

PRECAUTION

PRECAUTIONS

Precaution for Supplemental Restraint System (SRS) "AIR BAG" and "SEAT BELT PRE-TENSIONER"

INFOID:000000004056822

The Supplemental Restraint System such as "AIR BAG" and "SEAT BELT PRE-TENSIONER", used along with a front seat belt, helps to reduce the risk or severity of injury to the driver and front passenger for certain types of collision. This system includes seat belt switch inputs and dual stage front air bag modules. The SRS system uses the seat belt switches to determine the front air bag deployment, and may only deploy one front air bag, depending on the severity of a collision and whether the front occupants are belted or unbelted. Information necessary to service the system safely is included in the SR and SB section of this Service Manual.

WARNING:

- To avoid rendering the SRS inoperative, which could increase the risk of personal injury or death in the event of a collision which would result in air bag inflation, all maintenance must be performed by an authorized NISSAN/INFINITI dealer.
- Improper maintenance, including incorrect removal and installation of the SRS, can lead to personal injury caused by unintentional activation of the system. For removal of Spiral Cable and Air Bag Module, see the SR section.
- Do not use electrical test equipment on any circuit related to the SRS unless instructed to in this Service Manual. SRS wiring harnesses can be identified by yellow and/or orange harnesses or harness connectors.

A
B
C
D
E
F
G
H
I
J
K
L

PCS

N
O
P

ON-VEHICLE REPAIR

IPDM E/R (INTELLIGENT POWER DISTRIBUTION MODULE ENGINE ROOM)

Removal and Installation of IPDM E/R

INFOID:000000004056824

REMOVAL

1. Disconnect negative battery terminal.
2. Remove IPDM E/R upper cover.

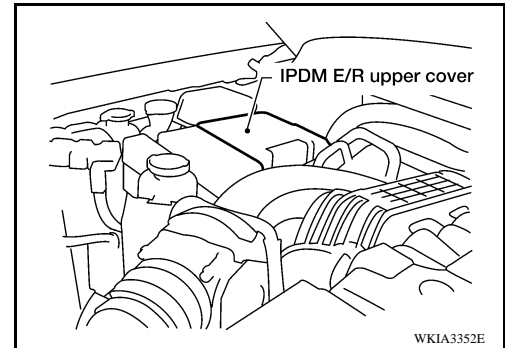

3. Release 2 clips and pull IPDM E/R up from case.
4. Disconnect IPDM E/R connectors and remove the IPDM E/R.

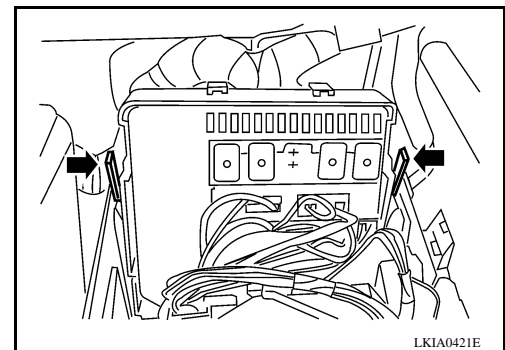

INSTALLATION

Installation is in the reverse order of removal.