

# SECTION **AV**

## AUDIO, VISUAL & NAVIGATION SYSTEM

A  
B  
C  
D  
E  
F  
G  
H  
I  
J  
K  
L  
M  
O  
P

### CONTENTS

<b>BASE AUDIO</b>	<b>U1200 AV CONTROL UNIT .....26</b>
<b>BASIC INSPECTION ..... 9</b>	Description .....26
<b>DIAGNOSIS AND REPAIR WORKFLOW ..... 9</b>	DTC Logic .....26
Work Flow .....9	<b>U1216 AV CONTROL UNIT .....27</b>
<b>FUNCTION DIAGNOSIS .....11</b>	Description .....27
<b>AUDIO SYSTEM .....11</b>	DTC Logic .....27
System Diagram ..... 11	<b>U1240 SWITCH CONN .....28</b>
System Description ..... 11	Description .....28
Component Parts Location ..... 12	<b>U1243 DISPLAY UNIT .....29</b>
Component Description ..... 13	Description .....29
<b>DVD PLAYER .....14</b>	DTC Logic .....29
System Diagram ..... 14	Diagnosis Procedure .....29
System Description ..... 14	<b>U1248 DVD DECK CONN .....31</b>
Component Parts Location ..... 15	Description .....31
Component Description ..... 15	DTC Logic .....31
<b>DIAGNOSIS SYSTEM (AV CONTROL UNIT)....16</b>	Diagnosis Procedure .....31
<b>AV CONTROL UNIT ..... 16</b>	<b>U1255 SATELLITE RADIO TUNER .....32</b>
AV CONTROL UNIT : Diagnosis Description ..... 16	Description .....32
AV CONTROL UNIT : CONSULT-III Function .....22	DTC Logic .....32
<b>A/C AND AV SWITCH ASSEMBLY .....22</b>	Diagnosis Procedure .....32
A/C AND AV SWITCH ASSEMBLY : Component	<b>U1300 AV COMM CIRCUIT .....33</b>
Function Check ..... 22	Description .....33
<b>COMPONENT DIAGNOSIS .....24</b>	<b>U1310 AV CONTROL UNIT .....34</b>
<b>U1000 CAN COMM CIRCUIT .....24</b>	Description .....34
Description ..... 24	DTC Logic .....34
DTC Logic ..... 24	<b>POWER SUPPLY AND GROUND CIRCUIT ....35</b>
Diagnosis Procedure ..... 24	<b>AV CONTROL UNIT .....35</b>
<b>U1010 CONTROL UNIT (CAN) .....25</b>	AV CONTROL UNIT : Diagnosis Procedure .....35
Description ..... 25	<b>DISPLAY UNIT .....36</b>
DTC Logic ..... 25	DISPLAY UNIT : Diagnosis Procedure .....36
Diagnosis Procedure ..... 25	<b>A/C AND AV SWITCH ASSEMBLY .....37</b>

AV

A/C AND AV SWITCH ASSEMBLY : Diagnosis Procedure .....	37	<b>COMMUNICATION SIGNAL CIRCUIT</b> .....	58
<b>SATELLITE RADIO TUNER</b> .....	38	<b>SATELLITE RADIO TUNER</b> .....	58
SATELLITE RADIO TUNER : Diagnosis Procedure .....	38	SATELLITE RADIO TUNER : Description .....	58
<b>DVD PLAYER</b> .....	39	SATELLITE RADIO TUNER : Diagnosis Procedure .....	58
DVD PLAYER : Diagnosis Procedure .....	39	<b>SOUND SIGNAL CIRCUIT</b> .....	61
<b>VIDEO MONITOR</b> .....	39	<b>SATELLITE RADIO TUNER</b> .....	61
VIDEO MONITOR : Diagnosis Procedure .....	39	SATELLITE RADIO TUNER : Description .....	61
<b>RGB (R: RED) SIGNAL CIRCUIT</b> .....	41	SATELLITE RADIO TUNER : Diagnosis Procedure .....	61
Description .....	41	<b>ECU DIAGNOSIS</b> .....	63
Diagnosis Procedure .....	41	<b>AV CONTROL UNIT</b> .....	63
<b>RGB (G: GREEN) SIGNAL CIRCUIT</b> .....	42	Reference Value .....	63
Description .....	42	Wiring Diagram .....	71
Diagnosis Procedure .....	42	DTC Index .....	93
<b>RGB (B: BLUE) SIGNAL CIRCUIT</b> .....	43	<b>DISPLAY UNIT</b> .....	95
Description .....	43	Reference Value .....	95
Diagnosis Procedure .....	43	<b>DVD PLAYER</b> .....	98
<b>RGB SYNCHRONIZING SIGNAL CIRCUIT</b> .....	44	Reference Value .....	98
Description .....	44	<b>SYMPTOM DIAGNOSIS</b> .....	100
Diagnosis Procedure .....	44	<b>AUDIO SYSTEM</b> .....	100
<b>RGB AREA (YS) SIGNAL CIRCUIT</b> .....	45	Symptom Table .....	100
Description .....	45	<b>NORMAL OPERATING CONDITION</b> .....	101
Diagnosis Procedure .....	45	Description .....	101
<b>HORIZONTAL SYNCHRONIZING (HP) SIGNAL CIRCUIT</b> .....	46	<b>PRECAUTION</b> .....	102
Description .....	46	<b>PRECAUTIONS</b> .....	102
Diagnosis Procedure .....	46	Supplemental Restraint System (SRS) "AIR BAG" and "SEAT BELT PRE-TENSIONER" .....	102
<b>VERTICAL SYNCHRONIZING (VP) SIGNAL CIRCUIT</b> .....	47	<b>PREPARATION</b> .....	103
Description .....	47	<b>PREPARATION</b> .....	103
Diagnosis Procedure .....	47	Commercial Service Tools .....	103
<b>FRONT DOOR SPEAKER</b> .....	48	<b>ON-VEHICLE REPAIR</b> .....	104
Description .....	48	<b>AV CONTROL UNIT</b> .....	104
Diagnosis Procedure .....	48	Removal and Installation .....	104
<b>FRONT TWEETER</b> .....	50	<b>DISPLAY UNIT</b> .....	106
Description .....	50	Removal and Installation .....	106
Diagnosis Procedure .....	50	<b>FRONT TWEETER</b> .....	107
<b>REAR DOOR SPEAKER</b> .....	52	Removal and Installation .....	107
Description .....	52	<b>FRONT DOOR SPEAKER</b> .....	108
Diagnosis Procedure .....	52	Removal and Installation .....	108
<b>REAR TWEETER</b> .....	54	<b>REAR DOOR SPEAKER</b> .....	109
Description .....	54	Removal and Installation .....	109
Diagnosis Procedure .....	54	<b>STEERING SWITCH</b> .....	110
<b>STEERING SWITCH</b> .....	56		
Description .....	56		
Diagnosis Procedure .....	56		

Removal and Installation .....	110	<b>DIAGNOSIS SYSTEM (AV CONTROL UNIT) .</b>	<b>133</b>
<b>REAR AUDIO REMOTE CONTROL UNIT .....</b>	<b>111</b>	<b>AV CONTROL UNIT .....</b>	<b>133</b>
Removal and Installation .....	111	AV CONTROL UNIT : Diagnosis Description .....	133
<b>DVD PLAYER .....</b>	<b>112</b>	AV CONTROL UNIT : CONSULT-III Function .....	139
Removal and Installation .....	112	<b>A/C AND AV SWITCH ASSEMBLY .....</b>	<b>140</b>
<b>DVD ENTERTAINMENT SYSTEM .....</b>	<b>113</b>	A/C AND AV SWITCH ASSEMBLY : Component	
Removal and Installation .....	113	Function Check .....	140
<b>AUDIO ANTENNA .....</b>	<b>114</b>	<b>DIAGNOSIS SYSTEM (BLUETOOTH CON-</b>	
Location of Antennas .....	114	<b>TROL UNIT) .....</b>	<b>141</b>
Window Antenna Repair .....	114	Diagnosis Description .....	141
<b>SATELLITE RADIO ANTENNA .....</b>	<b>116</b>	Work Flow .....	141
Removal and Installation .....	116	<b>COMPONENT DIAGNOSIS .....</b>	<b>142</b>
<b>SATELLITE RADIO TUNER .....</b>	<b>117</b>	<b>U1000 CAN COMM CIRCUIT .....</b>	<b>142</b>
Removal and Installation .....	117	Description .....	142
<b>BOSE AUDIO WITHOUT NAVIGATION</b>		DTC Logic .....	142
		Diagnosis Procedure .....	142
<b>BASIC INSPECTION .....</b>	<b>118</b>	<b>U1010 CONTROL UNIT (CAN) .....</b>	<b>143</b>
<b>DIAGNOSIS AND REPAIR WORKFLOW .....</b>	<b>118</b>	Description .....	143
Work Flow .....	118	DTC Logic .....	143
<b>INSPECTION AND ADJUSTMENT .....</b>	<b>120</b>	Diagnosis Procedure .....	143
<b>REAR VIEW MONITOR GUIDING LINE ADJUST-</b>		<b>U1200 AV CONTROL UNIT .....</b>	<b>144</b>
<b>MENT .....</b>	<b>120</b>	Description .....	144
REAR VIEW MONITOR GUIDING LINE ADJUST-		DTC Logic .....	144
MENT : Description .....	120	<b>U1216 AV CONTROL UNIT .....</b>	<b>145</b>
REAR VIEW MONITOR GUIDING LINE ADJUST-		Description .....	145
MENT : Special Repair Requirement .....	120	DTC Logic .....	145
<b>FUNCTION DIAGNOSIS .....</b>	<b>122</b>	<b>U1240 SWITCH CONN .....</b>	<b>146</b>
<b>AUDIO SYSTEM .....</b>	<b>122</b>	Description .....	146
System Diagram .....	122	<b>U1243 DISPLAY UNIT .....</b>	<b>147</b>
System Description .....	122	Description .....	147
Component Parts Location .....	124	DTC Logic .....	147
Component Description .....	125	Diagnosis Procedure .....	147
<b>REAR VIEW MONITOR SYSTEM .....</b>	<b>127</b>	<b>U1248 DVD DECK CONN .....</b>	<b>149</b>
System Diagram .....	127	Description .....	149
System Description .....	127	DTC Logic .....	149
Component Parts Location .....	127	Diagnosis Procedure .....	149
Component Description .....	127	<b>U1255 SATELLITE RADIO TUNER .....</b>	<b>150</b>
<b>DVD PLAYER .....</b>	<b>128</b>	Description .....	150
System Diagram .....	128	DTC Logic .....	150
System Description .....	128	Diagnosis Procedure .....	150
Component Parts Location .....	129	<b>U1256 HAND FREE CONN .....</b>	<b>151</b>
Component Description .....	129	Description .....	151
<b>HANDS-FREE PHONE SYSTEM .....</b>	<b>131</b>	<b>U1300 AV COMM CIRCUIT .....</b>	<b>152</b>
System Diagram .....	131	Description .....	152
System Description .....	131	<b>U1310 AV CONTROL UNIT .....</b>	<b>153</b>
Component Parts Location .....	131	Description .....	153
Component Description .....	132	DTC Logic .....	153

A  
B  
C  
D  
E  
F  
G  
H  
I  
J  
K  
L  
M  
O  
P

AV

<b>POWER SUPPLY AND GROUND CIRCUIT ..</b>	<b>154</b>	Description .....	171
		Diagnosis Procedure .....	171
<b>AV CONTROL UNIT .....</b>	<b>154</b>		
AV CONTROL UNIT : Diagnosis Procedure .....	154		
<b>DISPLAY UNIT .....</b>	<b>155</b>		
DISPLAY UNIT : Diagnosis Procedure .....	155		
<b>A/C AND AV SWITCH ASSEMBLY .....</b>	<b>156</b>		
A/C AND AV SWITCH ASSEMBLY : Diagnosis Procedure .....	156		
<b>BOSE SPEAKER AMP .....</b>	<b>157</b>		
BOSE SPEAKER AMP : Diagnosis Procedure .....	157		
<b>WOOFER .....</b>	<b>158</b>		
WOOFER : Diagnosis Procedure .....	158		
<b>SATELLITE RADIO TUNER .....</b>	<b>158</b>		
SATELLITE RADIO TUNER : Diagnosis Procedure .....	158		
<b>REAR VIEW CAMERA CONTROL UNIT .....</b>	<b>159</b>		
REAR VIEW CAMERA CONTROL UNIT : Diagnosis Procedure .....	159		
<b>REAR VIEW CAMERA .....</b>	<b>160</b>		
REAR VIEW CAMERA : Diagnosis Procedure .....	160		
<b>DVD PLAYER .....</b>	<b>161</b>		
DVD PLAYER : Diagnosis Procedure .....	161		
<b>VIDEO MONITOR .....</b>	<b>162</b>		
VIDEO MONITOR : Diagnosis Procedure .....	162		
<b>BLUETOOTH CONTROL UNIT .....</b>	<b>163</b>		
BLUETOOTH CONTROL UNIT : Diagnosis Procedure .....	163		
<b>MICROPHONE .....</b>	<b>164</b>		
MICROPHONE : Diagnosis Procedure .....	164		
<b>RGB (R: RED) SIGNAL CIRCUIT .....</b>	<b>166</b>		
Description .....	166		
Diagnosis Procedure .....	166		
<b>RGB (G: GREEN) SIGNAL CIRCUIT .....</b>	<b>167</b>		
Description .....	167		
Diagnosis Procedure .....	167		
<b>RGB (B: BLUE) SIGNAL CIRCUIT .....</b>	<b>168</b>		
Description .....	168		
Diagnosis Procedure .....	168		
<b>RGB SYNCHRONIZING SIGNAL CIRCUIT ...</b>	<b>169</b>		
Description .....	169		
Diagnosis Procedure .....	169		
<b>RGB AREA (YS) SIGNAL CIRCUIT .....</b>	<b>170</b>		
Description .....	170		
Diagnosis Procedure .....	170		
<b>HORIZONTAL SYNCHRONIZING (HP) SIGNAL CIRCUIT .....</b>	<b>171</b>		
		Description .....	171
		Diagnosis Procedure .....	171
<b>VERTICAL SYNCHRONIZING (VP) SIGNAL CIRCUIT .....</b>	<b>172</b>		
Description .....	172		
Diagnosis Procedure .....	172		
<b>FRONT DOOR SPEAKER .....</b>	<b>173</b>		
Description .....	173		
Diagnosis Procedure .....	173		
<b>FRONT TWEETER .....</b>	<b>176</b>		
Description .....	176		
Diagnosis Procedure .....	176		
<b>CENTER SPEAKER .....</b>	<b>179</b>		
Description .....	179		
Diagnosis Procedure .....	179		
<b>REAR DOOR SPEAKER .....</b>	<b>181</b>		
Description .....	181		
Diagnosis Procedure .....	181		
<b>REAR TWEETER .....</b>	<b>184</b>		
Description .....	184		
Diagnosis Procedure .....	184		
<b>BACK DOOR SPEAKER .....</b>	<b>187</b>		
Description .....	187		
Diagnosis Procedure .....	187		
<b>WOOFER .....</b>	<b>190</b>		
Description .....	190		
Diagnosis Procedure .....	190		
<b>AMP ON SIGNAL CIRCUIT .....</b>	<b>193</b>		
Description .....	193		
Diagnosis Procedure .....	193		
<b>STEERING SWITCH .....</b>	<b>194</b>		
Description .....	194		
Diagnosis Procedure .....	194		
<b>COMMUNICATION SIGNAL CIRCUIT .....</b>	<b>196</b>		
<b>SATELLITE RADIO TUNER .....</b>	<b>196</b>		
SATELLITE RADIO TUNER : Description .....	196		
SATELLITE RADIO TUNER : Diagnosis Procedure .....	196		
<b>SOUND SIGNAL CIRCUIT .....</b>	<b>199</b>		
<b>SATELLITE RADIO TUNER .....</b>	<b>199</b>		
SATELLITE RADIO TUNER : Description .....	199		
SATELLITE RADIO TUNER : Diagnosis Procedure .....	199		
<b>MICROPHONE SIGNAL CIRCUIT .....</b>	<b>201</b>		
Description .....	201		
Diagnosis Procedure .....	201		
<b>ECU DIAGNOSIS .....</b>	<b>203</b>		

<b>AV CONTROL UNIT</b> .....	<b>203</b>	<b>WOOFER</b> .....	<b>266</b>	
Reference Value .....	203	Removal and Installation .....	266	A
Wiring Diagram .....	211	<b>STEERING SWITCH</b> .....	<b>267</b>	
DTC Index .....	238	Removal and Installation .....	267	B
<b>DISPLAY UNIT</b> .....	<b>240</b>	<b>REAR AUDIO REMOTE CONTROL UNIT</b> .....	<b>268</b>	
Reference Value .....	240	Removal and Installation .....	268	C
<b>BOSE SPEAKER AMP</b> .....	<b>243</b>	<b>DVD PLAYER</b> .....	<b>269</b>	
Reference Value .....	243	Removal and Installation .....	269	D
<b>SATELLITE RADIO TUNER</b> .....	<b>246</b>	<b>DVD ENTERTAINMENT SYSTEM</b> .....	<b>270</b>	
Reference Value .....	246	Removal and Installation .....	270	E
<b>BLUETOOTH CONTROL UNIT</b> .....	<b>248</b>	<b>BOSE AMP.</b> .....	<b>271</b>	
Reference Value .....	248	Removal and Installation .....	271	F
<b>REAR VIEW CAMERA CONTROL UNIT</b> .....	<b>250</b>	<b>AUDIO ANTENNA</b> .....	<b>272</b>	
Reference Value .....	250	Location of Antenna .....	272	G
<b>DVD PLAYER</b> .....	<b>252</b>	Window Antenna Repair .....	272	H
Reference Value .....	252	<b>SATELLITE RADIO ANTENNA</b> .....	<b>273</b>	
<b>SYMPTOM DIAGNOSIS</b> .....	<b>254</b>	Removal and Installation .....	273	I
<b>AUDIO SYSTEM</b> .....	<b>254</b>	<b>SATELLITE RADIO TUNER</b> .....	<b>274</b>	
Symptom Table .....	254	Removal and Installation .....	274	J
<b>NORMAL OPERATING CONDITION</b> .....	<b>256</b>	<b>MICROPHONE</b> .....	<b>275</b>	
Description .....	256	Removal and Installation .....	275	K
<b>PRECAUTION</b> .....	<b>257</b>	<b>TEL ANTENNA</b> .....	<b>276</b>	
<b>PRECAUTIONS</b> .....	<b>257</b>	Removal and Installation .....	276	L
Supplemental Restraint System (SRS) "AIR BAG" and "SEAT BELT PRE-TENSIONER" .....	257	<b>BLUETOOTH CONTROL UNIT</b> .....	<b>277</b>	
<b>PREPARATION</b> .....	<b>258</b>	Removal and Installation .....	277	M
<b>PREPARATION</b> .....	<b>258</b>	<b>REAR VIEW CAMERA</b> .....	<b>278</b>	
Commercial Service Tools .....	258	Removal and Installation .....	278	
<b>ON-VEHICLE REPAIR</b> .....	<b>259</b>	Adjustment .....	278	
<b>AV CONTROL UNIT</b> .....	<b>259</b>	<b>REAR VIEW CAMERA CONTROL UNIT</b> .....	<b>279</b>	
Removal and Installation .....	259	Removal and Installation .....	279	
<b>DISPLAY UNIT</b> .....	<b>260</b>	<b>BOSE AUDIO WITH NAVIGATION</b>		
Removal and Installation .....	260	<b>BASIC INSPECTION</b> .....	<b>280</b>	
<b>FRONT TWEETER</b> .....	<b>261</b>	<b>DIAGNOSIS AND REPAIR WORKFLOW</b> .....	<b>280</b>	
Removal and Installation .....	261	Work Flow .....	280	AV
<b>CENTER SPEAKER</b> .....	<b>262</b>	<b>INSPECTION AND ADJUSTMENT</b> .....	<b>282</b>	
Removal and Installation .....	262	<b>REAR VIEW MONITOR GUIDING LINE ADJUST- MENT</b> .....	<b>282</b>	
<b>FRONT DOOR SPEAKER</b> .....	<b>263</b>	REAR VIEW MONITOR GUIDING LINE ADJUST- MENT : Description .....	282	O
Removal and Installation .....	263	REAR VIEW MONITOR GUIDING LINE ADJUST- MENT : Special Repair Requirement .....	282	P
<b>REAR DOOR SPEAKER</b> .....	<b>264</b>	<b>FUNCTION DIAGNOSIS</b> .....	<b>284</b>	
Removal and Installation .....	264	<b>AUDIO SYSTEM</b> .....	<b>284</b>	
<b>BACK DOOR SPEAKER</b> .....	<b>265</b>	System Diagram .....	284	
Removal and Installation .....	265			

System Description .....	284	<b>U1205 GPS ROM .....</b>	<b>316</b>
Component Parts Location .....	286	Description .....	316
Component Description .....	287	DTC Logic .....	316
<b>NAVIGATION SYSTEM .....</b>	<b>288</b>	<b>U1206 GPS RAM .....</b>	<b>317</b>
System Diagram .....	288	Description .....	317
System Description .....	288	DTC Logic .....	317
Component Parts Location .....	290	<b>U1207 GPS RTC .....</b>	<b>318</b>
Component Description .....	290	Description .....	318
<b>REAR VIEW MONITOR SYSTEM .....</b>	<b>291</b>	DTC Logic .....	318
System Diagram .....	291	<b>U1216 AV CONTROL UNIT .....</b>	<b>319</b>
System Description .....	291	Description .....	319
Component Parts Location .....	291	DTC Logic .....	319
Component Description .....	291	<b>U1217 AV CONTROL UNIT .....</b>	<b>320</b>
<b>DVD PLAYER .....</b>	<b>292</b>	Description .....	320
System Diagram .....	292	DTC Logic .....	320
System Description .....	292	<b>U1218 AV CONTROL UNIT .....</b>	<b>321</b>
Component Parts Location .....	293	Description .....	321
Component Description .....	293	DTC Logic .....	321
<b>HANDS-FREE PHONE SYSTEM .....</b>	<b>295</b>	<b>U1219 AV CONTROL UNIT .....</b>	<b>322</b>
System Diagram .....	295	Description .....	322
System Description .....	295	DTC Logic .....	322
Component Parts Location .....	295	<b>U121A AV CONTROL UNIT .....</b>	<b>323</b>
Component Description .....	295	Description .....	323
<b>DIAGNOSIS SYSTEM (AV CONTROL UNIT) .</b>	<b>297</b>	DTC Logic .....	323
<b>AV CONTROL UNIT .....</b>	<b>297</b>	<b>U121B AV CONTROL UNIT .....</b>	<b>324</b>
AV CONTROL UNIT : Diagnosis Description .....	297	Description .....	324
AV CONTROL UNIT : CONSULT-III Function .....	308	DTC Logic .....	324
<b>A/C AND AV SWITCH ASSEMBLY .....</b>	<b>310</b>	<b>U121C AV CONTROL UNIT .....</b>	<b>325</b>
A/C AND AV SWITCH ASSEMBLY : Component		Description .....	325
Function Check .....	310	DTC Logic .....	325
<b>COMPONENT DIAGNOSIS .....</b>	<b>311</b>	<b>U121D AV CONTROL UNIT .....</b>	<b>326</b>
<b>U1000 CAN COMM CIRCUIT .....</b>	<b>311</b>	Description .....	326
Description .....	311	DTC Logic .....	326
DTC Logic .....	311	<b>U121E AV CONTROL UNIT .....</b>	<b>327</b>
Diagnosis Procedure .....	311	Description .....	327
<b>U1010 CONTROL UNIT (CAN) .....</b>	<b>312</b>	DTC Logic .....	327
Description .....	312	<b>U121F AV CONTROL UNIT .....</b>	<b>328</b>
DTC Logic .....	312	Description .....	328
Diagnosis Procedure .....	312	DTC Logic .....	328
<b>U1200 AV CONTROL UNIT .....</b>	<b>313</b>	Diagnosis Procedure .....	328
Description .....	313	<b>U1220 AV CONTROL UNIT .....</b>	<b>329</b>
DTC Logic .....	313	Description .....	329
<b>U1201 AV CONTROL UNIT .....</b>	<b>314</b>	DTC Logic .....	329
Description .....	314	<b>U1243 DISPLAY UNIT .....</b>	<b>330</b>
DTC Logic .....	314	Description .....	330
<b>U1204 GPS COMM .....</b>	<b>315</b>	DTC Logic .....	330
Description .....	315	Diagnosis Procedure .....	330
DTC Logic .....	315		

<b>U1244 GPS ANTENNA</b> .....	<b>332</b>	<b>RGB (B: BLUE) SIGNAL CIRCUIT</b> .....	<b>350</b>	
Description .....	332	Description .....	350	A
DTC Logic .....	332	Diagnosis Procedure .....	350	
Diagnosis Procedure .....	332			
<b>U1250 CAMERA CONTROL UNIT</b> .....	<b>333</b>	<b>RGB SYNCHRONIZING SIGNAL CIRCUIT</b> ...	<b>351</b>	B
Description .....	333	Description .....	351	
DTC Logic .....	333	Diagnosis Procedure .....	351	
Diagnosis Procedure .....	333			
<b>U1258 SATELLITE RADIO ANTENNA</b> .....	<b>335</b>	<b>RGB AREA (YS) SIGNAL CIRCUIT</b> .....	<b>352</b>	C
Description .....	335	Description .....	352	
DTC Logic .....	335	Diagnosis Procedure .....	352	
Diagnosis Procedure .....	335			
<b>U1300 AV COMM CIRCUIT</b> .....	<b>336</b>	<b>HORIZONTAL SYNCHRONIZING (HP) SIG-</b>		D
Description .....	336	<b>NAL CIRCUIT</b> .....	<b>353</b>	
		Description .....	353	E
		Diagnosis Procedure .....	353	
<b>U1310 AV CONTROL UNIT</b> .....	<b>337</b>	<b>VERTICAL SYNCHRONIZING (VP) SIGNAL</b>		F
Description .....	337	<b>CIRCUIT</b> .....	<b>354</b>	
DTC Logic .....	337	Description .....	354	
		Diagnosis Procedure .....	354	
<b>POWER SUPPLY AND GROUND CIRCUIT</b> ...	<b>338</b>	<b>FRONT DOOR SPEAKER</b> .....	<b>355</b>	G
<b>AV CONTROL UNIT</b> .....	<b>338</b>	Description .....	355	
AV CONTROL UNIT : Diagnosis Procedure .....	338	Diagnosis Procedure .....	355	
<b>DISPLAY UNIT</b> .....	<b>339</b>	<b>FRONT TWEETER</b> .....	<b>358</b>	H
DISPLAY UNIT : Diagnosis Procedure .....	339	Description .....	358	
		Diagnosis Procedure .....	358	
<b>A/C AND AV SWITCH ASSEMBLY</b> .....	<b>340</b>	<b>CENTER SPEAKER</b> .....	<b>361</b>	I
A/C AND AV SWITCH ASSEMBLY : Diagnosis		Description .....	361	
Procedure .....	340	Diagnosis Procedure .....	361	J
<b>BOSE SPEAKER AMP</b> .....	<b>341</b>	<b>REAR DOOR SPEAKER</b> .....	<b>363</b>	K
BOSE SPEAKER AMP : Diagnosis Procedure ...	341	Description .....	363	
		Diagnosis Procedure .....	363	
<b>WOOFER</b> .....	<b>341</b>	<b>REAR TWEETER</b> .....	<b>366</b>	L
WOOFER : Diagnosis Procedure .....	341	Description .....	366	
		Diagnosis Procedure .....	366	
<b>REAR VIEW CAMERA CONTROL UNIT</b> .....	<b>342</b>	<b>BACK DOOR SPEAKER</b> .....	<b>369</b>	M
REAR VIEW CAMERA CONTROL UNIT : Diagno-		Description .....	369	
sis Procedure .....	342	Diagnosis Procedure .....	369	
<b>REAR VIEW CAMERA</b> .....	<b>343</b>	<b>WOOFER</b> .....	<b>372</b>	AV
REAR VIEW CAMERA : Diagnosis Procedure ...	343	Description .....	372	
		Diagnosis Procedure .....	372	
<b>DVD PLAYER</b> .....	<b>344</b>	<b>AMP ON SIGNAL CIRCUIT</b> .....	<b>375</b>	O
DVD PLAYER : Diagnosis Procedure .....	344	Description .....	375	
		Diagnosis Procedure .....	375	
<b>VIDEO MONITOR</b> .....	<b>345</b>	<b>STEERING SWITCH</b> .....	<b>376</b>	P
VIDEO MONITOR : Diagnosis Procedure .....	345	Description .....	376	
		Diagnosis Procedure .....	376	
<b>MICROPHONE</b> .....	<b>346</b>	<b>MICROPHONE SIGNAL CIRCUIT</b> .....	<b>378</b>	
MICROPHONE : Diagnosis Procedure .....	346	Description .....	378	
		Diagnosis Procedure .....	378	
<b>RGB (R: RED) SIGNAL CIRCUIT</b> .....	<b>348</b>			
Description .....	348			
Diagnosis Procedure .....	348			
<b>RGB (G: GREEN) SIGNAL CIRCUIT</b> .....	<b>349</b>			
Description .....	349			
Diagnosis Procedure .....	349			

<b>ECU DIAGNOSIS</b> .....	<b>380</b>	<b>CENTER SPEAKER</b> .....	<b>441</b>
		Removal and Installation .....	441
<b>AV CONTROL UNIT</b> .....	<b>380</b>	<b>FRONT DOOR SPEAKER</b> .....	<b>442</b>
Reference Value .....	380	Removal and Installation .....	442
Wiring Diagram .....	386	<b>REAR DOOR SPEAKER</b> .....	<b>443</b>
DTC Index .....	414	Removal and Installation .....	443
<b>DISPLAY UNIT</b> .....	<b>416</b>	<b>BACK DOOR SPEAKER</b> .....	<b>444</b>
Reference Value .....	416	Removal and Installation .....	444
<b>BOSE SPEAKER AMP</b> .....	<b>419</b>	<b>WOOFER</b> .....	<b>445</b>
Reference Value .....	419	Removal and Installation .....	445
<b>REAR VIEW CAMERA CONTROL UNIT</b> .....	<b>422</b>	<b>DVD PLAYER</b> .....	<b>446</b>
Reference Value .....	422	Removal and Installation .....	446
<b>DVD PLAYER</b> .....	<b>424</b>	<b>STEERING SWITCH</b> .....	<b>447</b>
Reference Value .....	424	Removal and Installation .....	447
<b>SYMPTOM DIAGNOSIS</b> .....	<b>426</b>	<b>REAR AUDIO REMOTE CONTROL UNIT</b> .....	<b>448</b>
		Removal and Installation .....	448
<b>MULTI AV SYSTEM</b> .....	<b>426</b>	<b>DVD ENTERTAINMENT SYSTEM</b> .....	<b>449</b>
Symptom Table .....	426	Removal and Installation .....	449
<b>NORMAL OPERATING CONDITION</b> .....	<b>428</b>	<b>BOSE AMP.</b> .....	<b>450</b>
Description .....	428	Removal and Installation .....	450
<b>PRECAUTION</b> .....	<b>436</b>	<b>AUDIO ANTENNA</b> .....	<b>451</b>
<b>PRECAUTIONS</b> .....	<b>436</b>	Location of Antenna .....	451
Supplemental Restraint System (SRS) "AIR BAG" and "SEAT BELT PRE-TENSIONER" .....	436	Window Antenna Repair .....	451
Precaution for Trouble Diagnosis .....	436	<b>SATELLITE RADIO ANTENNA</b> .....	<b>452</b>
Precaution for Harness Repair .....	436	Removal and Installation .....	452
<b>PREPARATION</b> .....	<b>437</b>	<b>GPS ANTENNA</b> .....	<b>453</b>
<b>PREPARATION</b> .....	<b>437</b>	Removal and Installation .....	453
Commercial Service Tools .....	437	<b>MICROPHONE</b> .....	<b>454</b>
<b>ON-VEHICLE REPAIR</b> .....	<b>438</b>	Removal and Installation .....	454
<b>AV CONTROL UNIT</b> .....	<b>438</b>	<b>REAR VIEW CAMERA</b> .....	<b>455</b>
Removal and Installation .....	438	Removal and Installation .....	455
<b>DISPLAY UNIT</b> .....	<b>439</b>	Adjustment .....	455
Removal and Installation .....	439	<b>REAR VIEW CAMERA CONTROL UNIT</b> .....	<b>456</b>
<b>FRONT TWEETER</b> .....	<b>440</b>	Removal and Installation .....	456
Removal and Installation .....	440		



## BASIC INSPECTION

### DIAGNOSIS AND REPAIR WORKFLOW

#### Work Flow

INFOID:000000001297312

#### OVERALL SEQUENCE

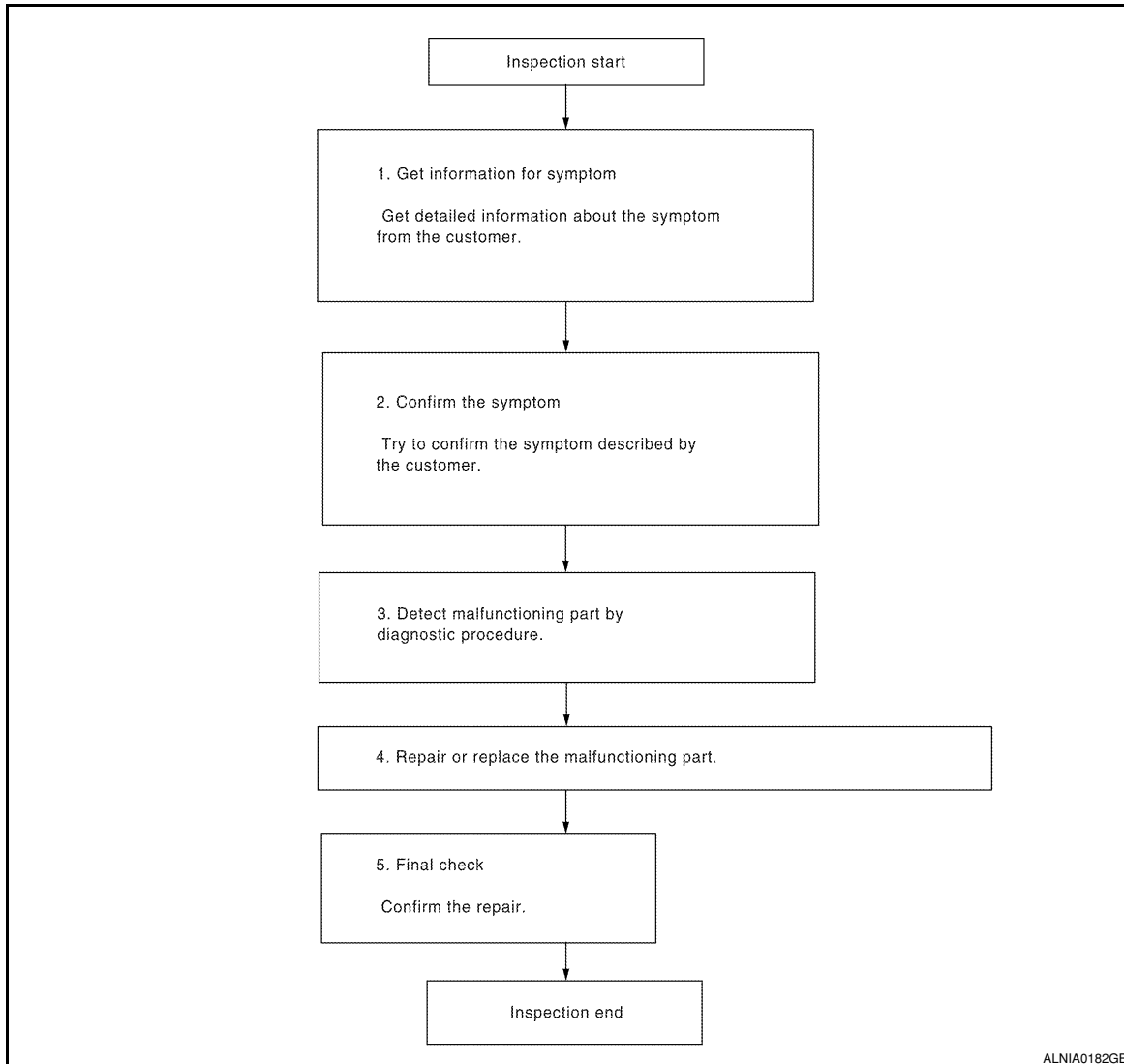

#### DETAILED FLOW

##### 1.GET INFORMATION FOR SYMPTOM

Get detailed information from the customer about the symptom (the condition and the environment when the incident/malfunction occurred).

>> GO TO 2

##### 2.CONFIRM THE SYMPTOM

Try to confirm the symptom described by the customer. Verify relation between the symptom and the condition when the symptom is detected.

>> GO TO 3

##### 3.DETECT MALFUNCTIONING PART BY DIAGNOSTIC PROCEDURE

Inspect according to Diagnostic Procedure of the system.

A  
B  
C  
D  
E  
F  
G  
H  
I  
J  
K  
L  
M

AV

O

P

# DIAGNOSIS AND REPAIR WORKFLOW

< BASIC INSPECTION >

[BASE AUDIO]

---

Is malfunctioning part detected?

YES >> GO TO 4

NO >> GO TO 2

## 4.REPAIR OR REPLACE THE MALFUNCTIONING PART

---

1. Repair or replace the malfunctioning part.
2. Reconnect parts or connectors disconnected during Diagnostic Procedure.

>> GO TO 5

## 5.FINAL CHECK

---

Refer to confirmed symptom in step 2, and make sure that the symptom is not detected.

Has the symptom been repaired?

YES >> Inspection End.

NO >> GO TO 2

FUNCTION DIAGNOSIS

AUDIO SYSTEM

System Diagram

INFOID:000000001297313

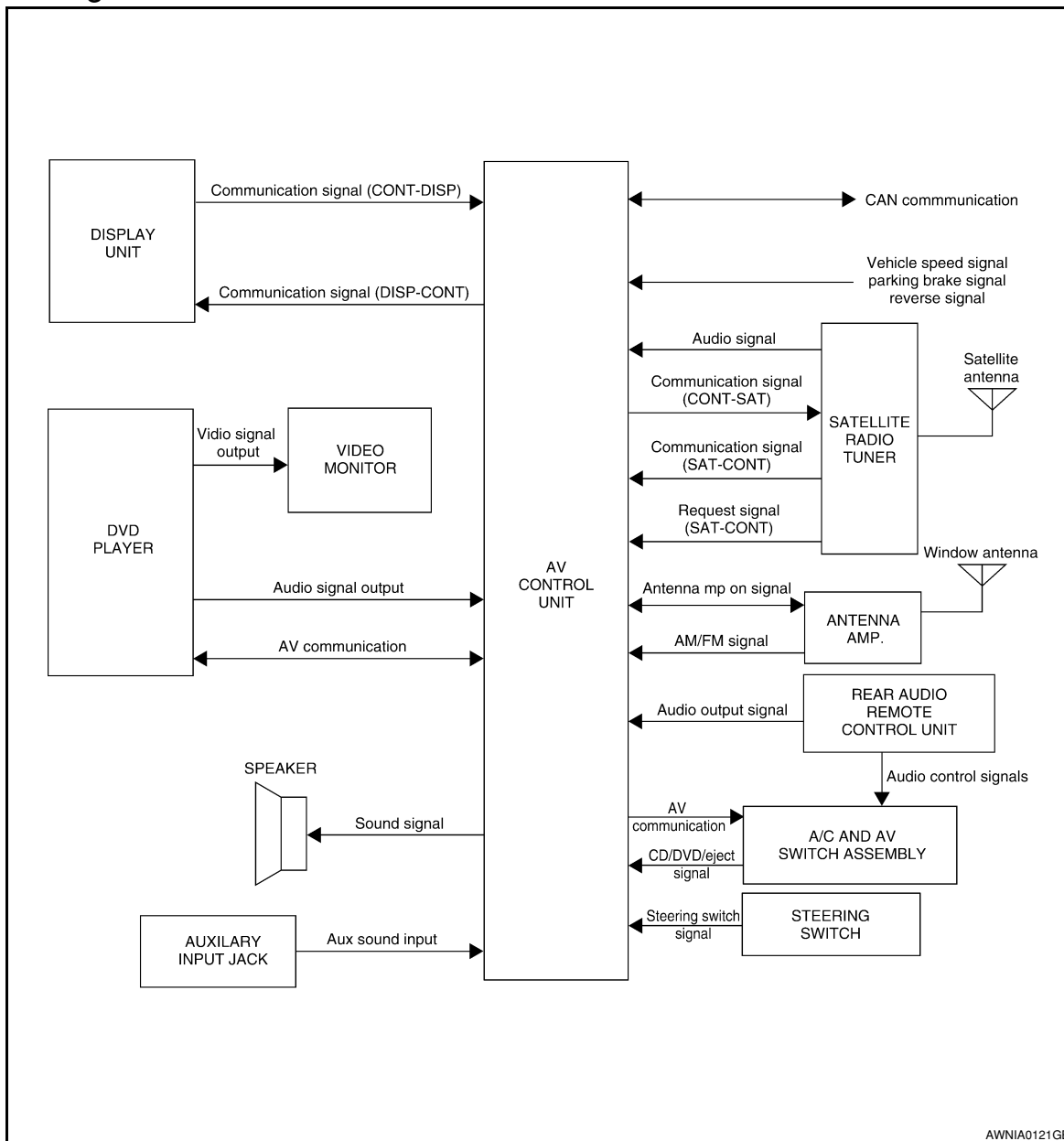

AWNIA0121GE

A  
B  
C  
D  
E  
F  
G  
H  
I  
J  
K  
L  
M

AV

System Description

INFOID:000000001297314

AUDIO SYSTEM

The audio system consists of the following components

- AV control unit
- Display unit
- Window antenna
- Steering switches
- A/C and AV switch assembly
- Rear audio remote control unit
- Front door speakers
- Front tweeters
- Rear door speakers

O  
P

# AUDIO SYSTEM

< FUNCTION DIAGNOSIS >

[BASE AUDIO]

- Rear door tweeters

When the audio system is on, radio signals are received by the window antenna. The AV control unit then sends audio signals to the front door speakers, front tweeters, rear door speakers and rear door tweeters. Refer to Owner's Manual for audio system operating instructions.

## SATELLITE RADIO SYSTEM

The satellite radio system consists of the following components

- Satellite antenna
- Satellite radio tuner

When the satellite radio system is on, radio signals are supplied to the satellite radio tuner from the satellite antenna. The satellite radio tuner then sends audio signals to the AV control unit.

Refer to Owner's Manual for satellite radio system operating instructions.

## SPEED SENSITIVE VOLUME SYSTEM

The volume level of this system goes up and down automatically in proportion to vehicle speed. The control level can be set by the customer. Revert to the Owner's Manual for operating instructions.

## Component Parts Location

INFOID:000000001297315

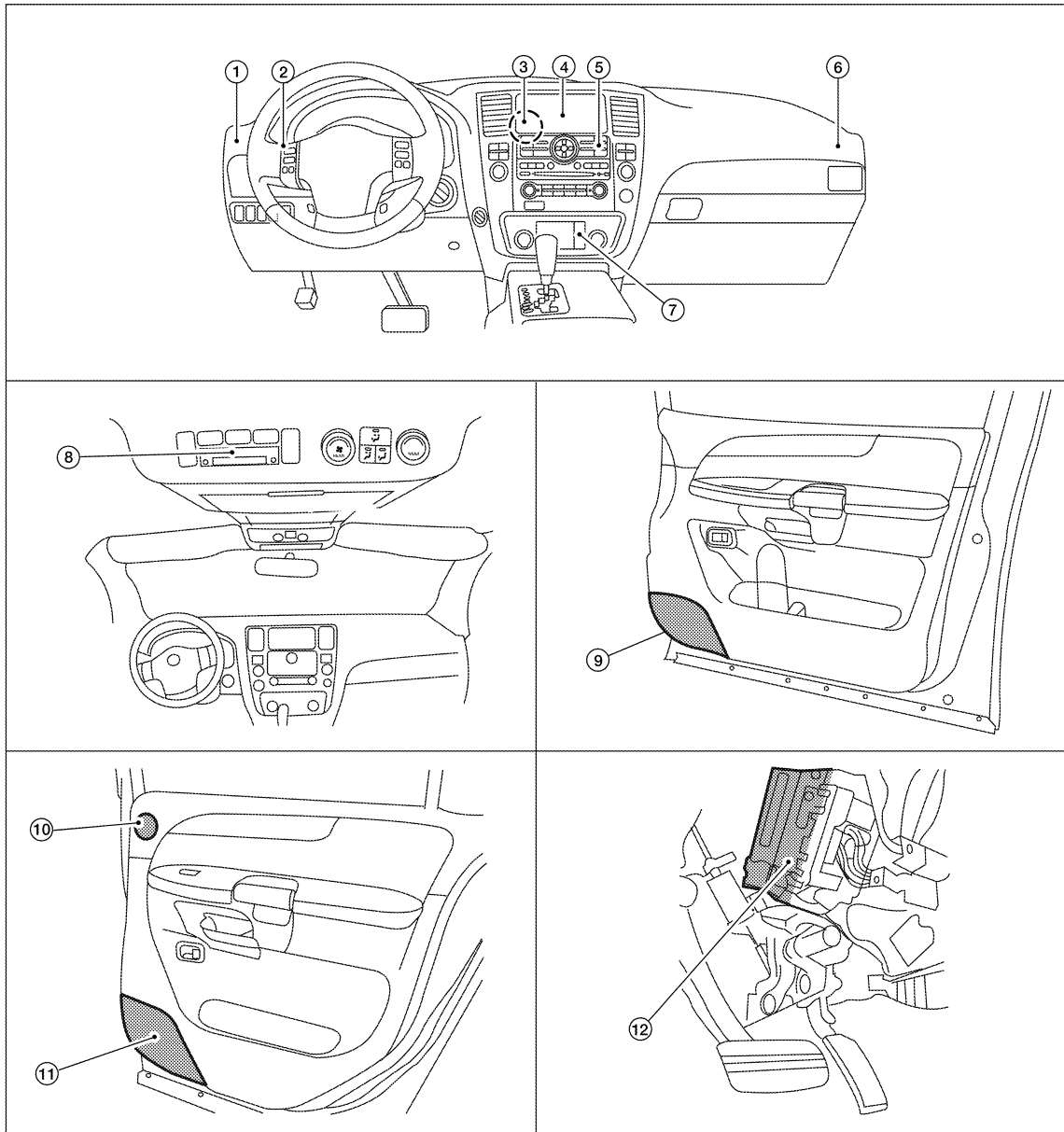

AWNIA0141GB

# AUDIO SYSTEM

< FUNCTION DIAGNOSIS >

[BASE AUDIO]

- |   |   |  |   |
|---|---|--|---|
| 1. Front tweeter LH M109                    | 2. Steering wheel audio control switches    | 3. AV control unit M42, M43, M44, M45, M46, M124 | A |
| 4. Display unit M93                         | 5. A/C and AV switch assembly M98           | 6. Front weeter RH D308                          |   |
| 7. Aux. jack M104                           | 8. Rear audio remote control unit R204      | 9. Front door speaker<br>LH D12<br>RH D112       | B |
| 10. Rear door tweeter<br>LH D208<br>RH D308 | 11. Rear door speaker<br>LH D207<br>RH D307 | 12. Satellite radio tuner M41, M129              | C |

## Component Description

INFOID:000000001297316

Part name	Description
AV control unit	Controls audio system and satellite radio system functions
Display unit	Displays audio and climate control related information
A/C and AV switch assembly	<ul style="list-style-type: none"> <li>All audio and A/C operations can be operated</li> <li>switch signal is output to the AV control unit and A/C auto amp</li> </ul>
Rear audio remote control unit	<ul style="list-style-type: none"> <li>Audio operation can be operated</li> <li>switch signal is output to the AV control unit</li> </ul>
Steering wheel audio control switches	<ul style="list-style-type: none"> <li>Audio operation can be operated</li> <li>Steering switch signal (operation signal) is output to AV control unit</li> </ul>
Front door speakers	<ul style="list-style-type: none"> <li>Outputs audio signal from AV control unit</li> <li>Outputs high, mid and low range sounds</li> </ul>
Front tweeters	<ul style="list-style-type: none"> <li>Outputs audio signal from AV control unit</li> <li>Outputs high range sounds</li> </ul>
Rear door tweeters	<ul style="list-style-type: none"> <li>Outputs audio signal from AV control unit</li> <li>Outputs high range sounds</li> </ul>
Rear door speakers	<ul style="list-style-type: none"> <li>Outputs audio signal from AV control unit</li> <li>Outputs high, mid and low range sounds</li> </ul>
Antenna amp.	<ul style="list-style-type: none"> <li>Radio signal received by window antenna is amplified and sent to AV control unit</li> <li>Power (antenna amp. ON signal) is supplied from AV control unit</li> </ul>
Satellite radio tuner	<ul style="list-style-type: none"> <li>Receives radio signals from satellite antenna</li> <li>Sends audio signals to AV control unit</li> </ul>
Satellite antenna	Audio signal (satellite radio) is received and output to AV control unit.

AV

O

P

## DVD PLAYER

### System Diagram

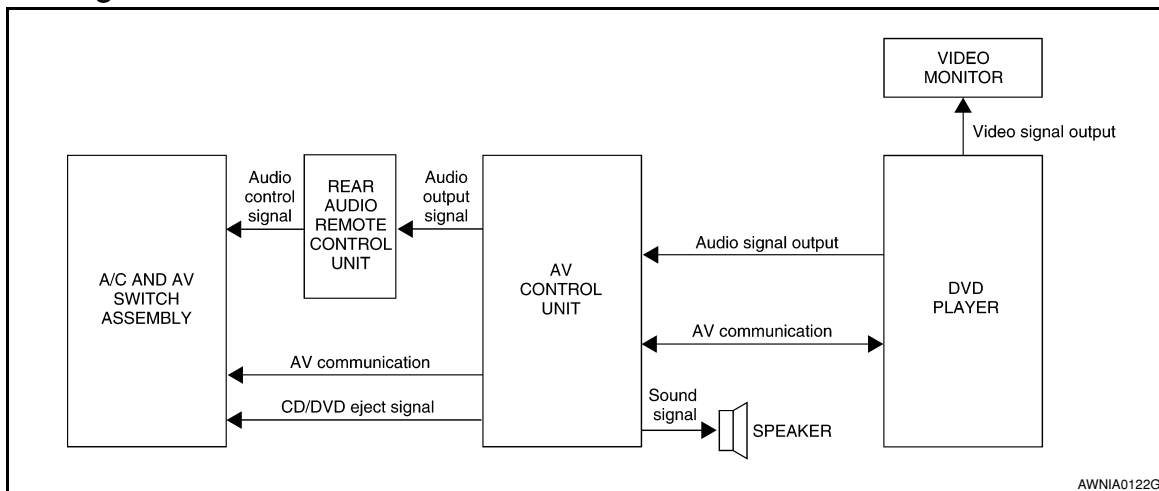

### System Description

INFOID:000000001308783

The DVD entertainment system consists of the following components

- AV control unit
- DVD player
- Video monitor
- A/C and AV switch assembly
- Steering wheel audio control switches
- Rear audio remote control unit
- Front tweeters
- Front door speakers
- Rear door tweeters
- Rear door speakers

When the DVD entertainment system is on, video signals are sent from the DVD player to the video monitor. Audio signals are sent to the AV control unit. Audio signals can be directed through the vehicle speakers or through wireless infrared headphones. Refer to the Owner's Manual for complete DVD entertainment system operating instructions.

# DVD PLAYER

< FUNCTION DIAGNOSIS >

[BASE AUDIO]

## Component Parts Location

INFOID:000000001308784

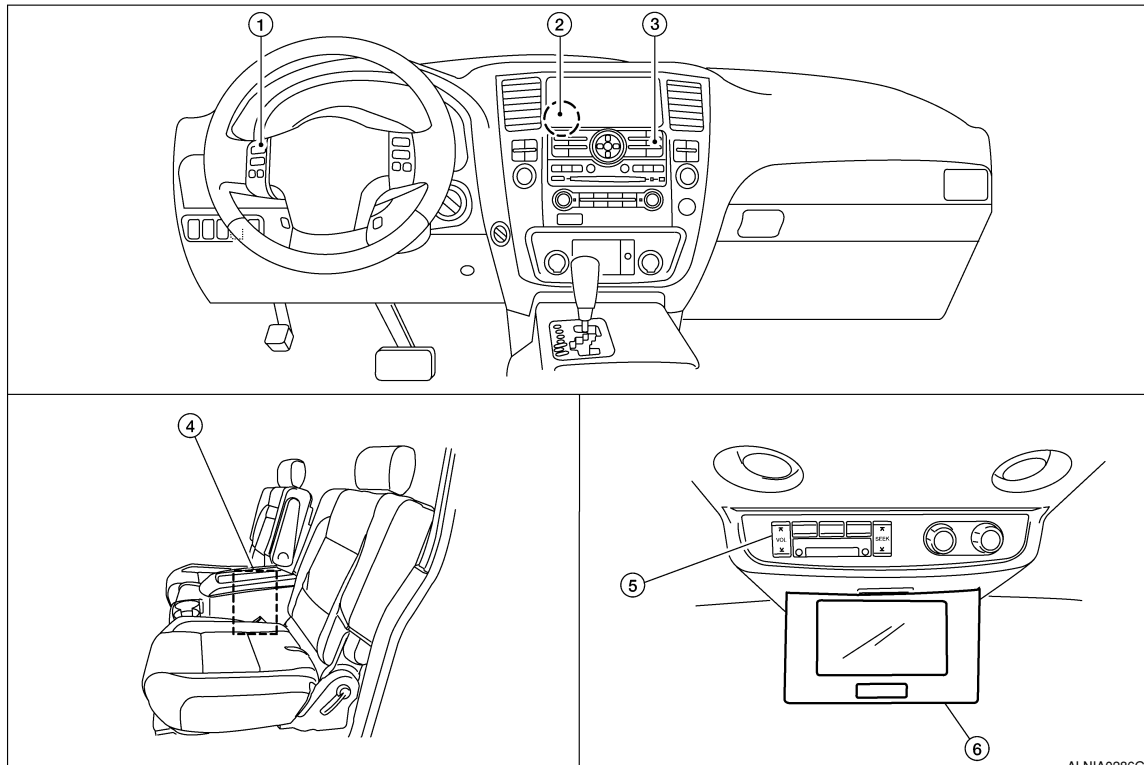

- |  |  |                                   |
|--|--|-----------------------------------|
| 1. Steering wheel audio control switches       | 2. AV control unit M42, M43, M44, M45, M46, M124 | 3. A/C and AV switch assembly M98 |
| 4. DVD player M205 (located in center console) | 5. Rear audio remote control unit R204           | 6. Video monitor R202             |

## Component Description

INFOID:000000001308785

Part name	Description
DVD player	<ul style="list-style-type: none"> <li>Outputs DVD video to video monitor</li> <li>Outputs DVD audio to the AV control unit</li> </ul>
Video monitor	<ul style="list-style-type: none"> <li>Receives and displays the DVD video signal</li> </ul>
AV control unit	<ul style="list-style-type: none"> <li>Controls audio system and DVD entertainment system functions</li> </ul>
A/C and AV switch assembly	<ul style="list-style-type: none"> <li>All audio and A/C operations can be operated</li> <li>Switch signal is output to the AV control unit and A/C auto amp</li> </ul>
Rear audio remote control unit	<ul style="list-style-type: none"> <li>Audio and DVD functions can be operated</li> <li>Switch signal is output to the AV control unit</li> <li>Receives audio signal from AV control unit for headphones</li> </ul>
Steering wheel audio control switches	<ul style="list-style-type: none"> <li>Audio operation can be operated</li> <li>Steering switch signal (operation signal) is output to AV control unit</li> </ul>
Front door speakers	<ul style="list-style-type: none"> <li>Outputs audio signal from AV control unit</li> <li>Outputs high, mid and low range sounds</li> </ul>
Front and rear tweeters	<ul style="list-style-type: none"> <li>Outputs audio signal from AV control unit</li> <li>Outputs high range sounds</li> </ul>
Rear door speakers	<ul style="list-style-type: none"> <li>Outputs audio signal from AV control unit</li> <li>Outputs high, mid and low range sounds</li> </ul>

# DIAGNOSIS SYSTEM (AV CONTROL UNIT)

< FUNCTION DIAGNOSIS >

[BASE AUDIO]

## DIAGNOSIS SYSTEM (AV CONTROL UNIT)

### AV CONTROL UNIT

#### AV CONTROL UNIT : Diagnosis Description

INFOID:000000001301251

#### DESCRIPTION

- Diagnosis function consists of the “Self-Diagnosis” mode performed automatically and the “Confirmation/Adjustment” mode operated manually.
- “Self-Diagnosis” mode checks for connections between the units constituting this system, analyzes each individual unit at the same time, and displays the results on the LCD screen.
- “Confirmation/Adjustment” mode is used to perform trouble diagnosis that requires operation and judgment by an operator (trouble that cannot be automatically judged by the system), to check/change the set value, and to display the error history of the AV control unit.

#### DIAGNOSIS ITEM

Mode		Description	
Self-diagnosis		<ul style="list-style-type: none"> <li>• AV control unit diagnosis</li> <li>• Analyzes connection between the AV control unit, front display, Bluetooth, DVD deck, satellite tuner, switches and rear view camera control unit.</li> </ul>	
CONFIRMATION/ ADJUSTMENT	Display diagnosis	Color spectrum bar	Color tone of the screen can be checked by the display of a color bar.
		Gradation bar	Shading of the screen can be checked by the display of a gray scale.
	Vehicle signals		The following vehicle signals are analyzed: Vehicle speed signal, parking brake signal, light signal, ignition switch signal, and reverse signal.
	Speaker test		Connection can be checked by sending a test tone to each speaker.
	Climate control		Start auto air conditioner self-diagnosis
	Error history		Diagnosis results previously stored in the memory are displayed in this mode.
	Vehicle CAN diagnosis		The transmitting/receiving of CAN communication can be monitored.
	AV COMM diagnosis		The transmitting/receiving of AV communication can be monitored.
	Delete unit connection log		Erase the error history and connection history of the unit.
	Initialize settings		All audio settings are reset to default levels.

#### OPERATION PROCEDURE

1. Start the engine.
2. Turn the audio system off.
3. While pressing the “SETTING” button, turn the volume control dial counterclockwise 30 clicks or more.

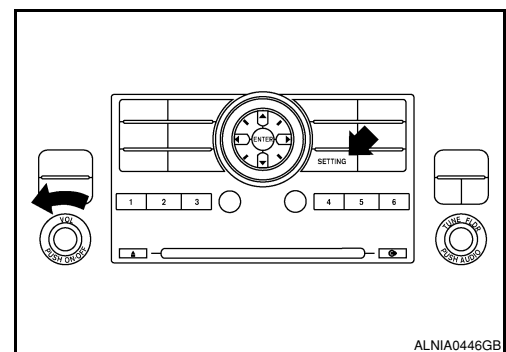

ALNIA0446GB



# DIAGNOSIS SYSTEM (AV CONTROL UNIT)

< FUNCTION DIAGNOSIS >

[BASE AUDIO]

- The initial trouble diagnosis screen will be displayed, and items “Self-Diagnosis” and “Confirmation/Adjustment” can be selected.

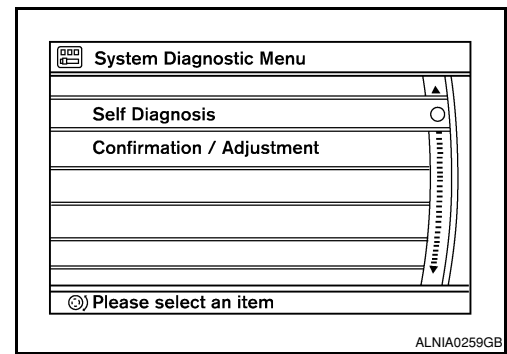

## SELF-DIAGNOSIS

- Perform self-diagnosis by selecting “Self-Diagnosis”.
  - Self-diagnosis subdivision screen is displayed, and the self-diagnosis mode starts.
  - A bar graph visible on the center of the self-diagnosis subdivision screen indicates progress of the trouble diagnosis.

**NOTE:**

Self-diagnosis requires approximately 10 seconds to complete.

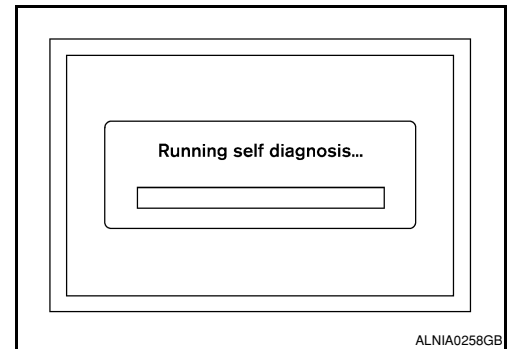

- Diagnosis results are displayed after the self-diagnosis is completed. The unit names and the connection lines are color-coded according to the diagnostic results.

Diagnosis results	Unit	Connection line
Normal	Green	Green
Connection malfunction	Gray	Yellow
Unit malfunction <small>Note</small>	Red	Green

Note:

- Only the AV control unit is displayed in red.
- If multiple malfunctions occur at the same time for a single unit, the screen switch colors are determined according to the following order of priority: red > yellow > gray.

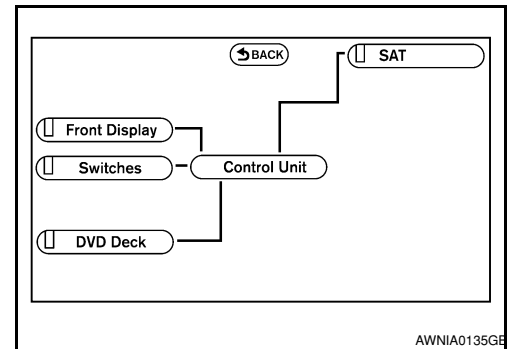

- Select a component on the “Self Diagnosis” screen and comments for the diagnosis results will be shown.

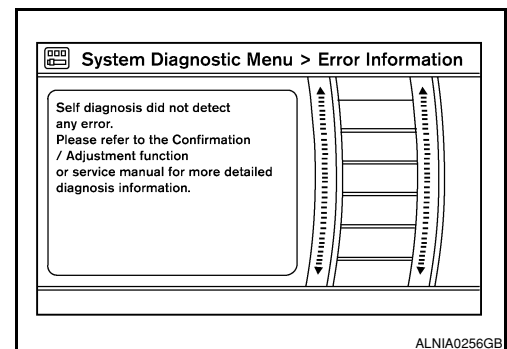

Self-Diagnosis Results

A  
B  
C  
D  
E  
F  
G  
H  
I  
J  
K  
L  
M  
AV  
O  
P

# DIAGNOSIS SYSTEM (AV CONTROL UNIT)

< FUNCTION DIAGNOSIS >

[BASE AUDIO]

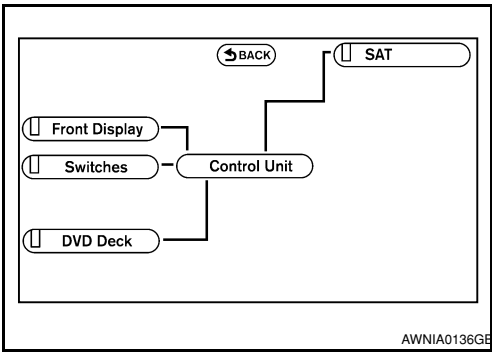
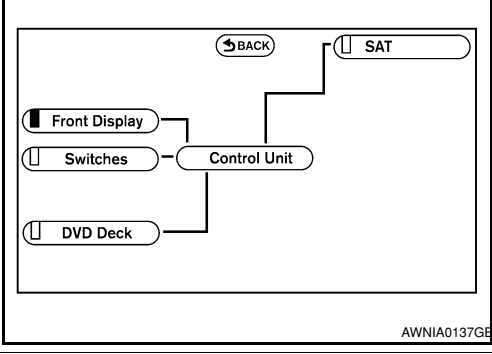
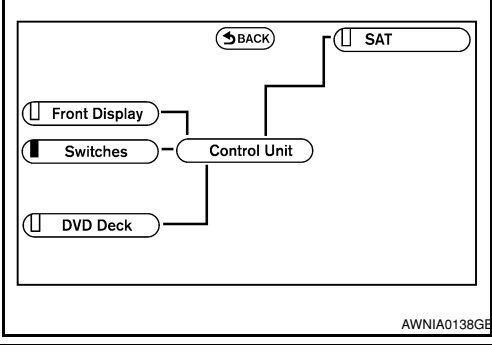
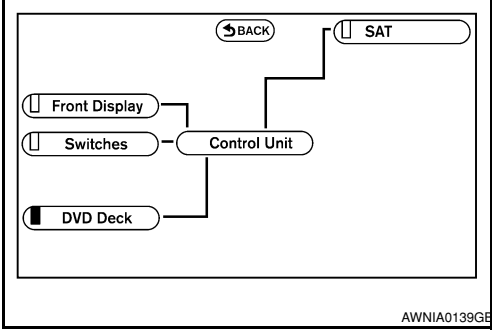
Area with yellow connection lines	Description	Possible malfunction location / Action to take
 <p style="text-align: right; font-size: small;">AWNIA0136GE</p>	<p>AV control unit malfunction is detected</p>	<p>Replace the AV control unit. Refer to <a href="#">AV-104. "Removal and Installation"</a>.</p>
 <p style="text-align: right; font-size: small;">AWNIA0137GE</p>	<p>Poor connection is detected for the display unit</p>	<ul style="list-style-type: none"> <li>• Harness or connector</li> <li>• AV control unit</li> <li>• Display unit</li> </ul>
 <p style="text-align: right; font-size: small;">AWNIA0138GE</p>	<p>Switch malfunction is detected</p>	<p>Perform A/C and AV switch assembly diagnostics. Refer to <a href="#">AV-22. "A/C AND AV SWITCH ASSEMBLY : Component Function Check"</a></p>
 <p style="text-align: right; font-size: small;">AWNIA0139GE</p>	<p>Poor connection is detected for the DVD player.</p>	<ul style="list-style-type: none"> <li>• Harness or connector</li> <li>• AV control unit</li> <li>• DVD player</li> </ul>

# DIAGNOSIS SYSTEM (AV CONTROL UNIT)

< FUNCTION DIAGNOSIS >

[BASE AUDIO]

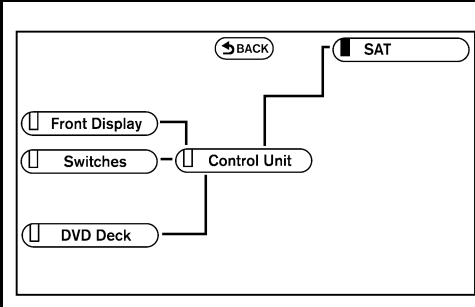
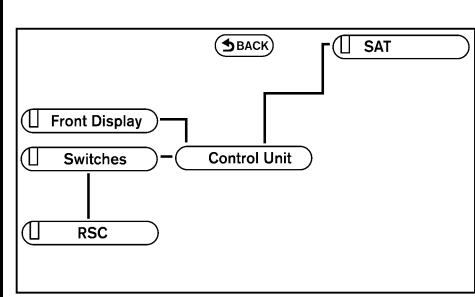
Area with yellow connection lines	Description	Possible malfunction location / Action to take
 <p style="text-align: right; font-size: small;">AWNIA0140GE</p>	<p>Poor connection is detected for the satellite radio tuner.</p>	<ul style="list-style-type: none"> <li>• Harness or connector</li> <li>• AV control unit</li> <li>• Satellite radio tuner</li> </ul>
 <p style="text-align: right; font-size: small;">ALNIA0655GB</p>	<p>Poor connection is detected for the rear audio remote control unit.</p>	<ul style="list-style-type: none"> <li>• Harness or connector</li> <li>• AV control unit</li> <li>• Rear audio remote control unit</li> </ul>

## CONFIRMATION/ADJUSTMENT MODE

1. Start the diagnosis function and select “Confirmation/Adjustment”. The confirmation/adjustment mode indicates where each item can be checked or adjusted.
2. Select each item on the “Confirmation/Adjustment” mode screen to display the relevant trouble diagnosis screen. Press the “BACK” button or touch “BACK” on the touch screen to return to the initial Confirmation/Adjustment Mode screen.

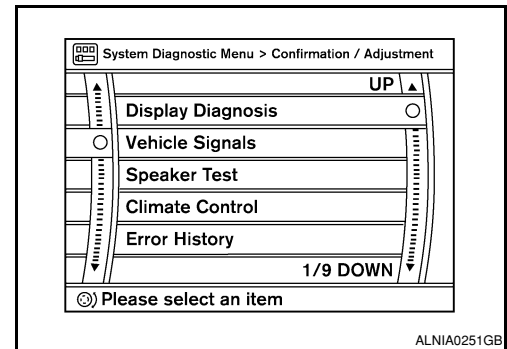

## Display Diagnosis

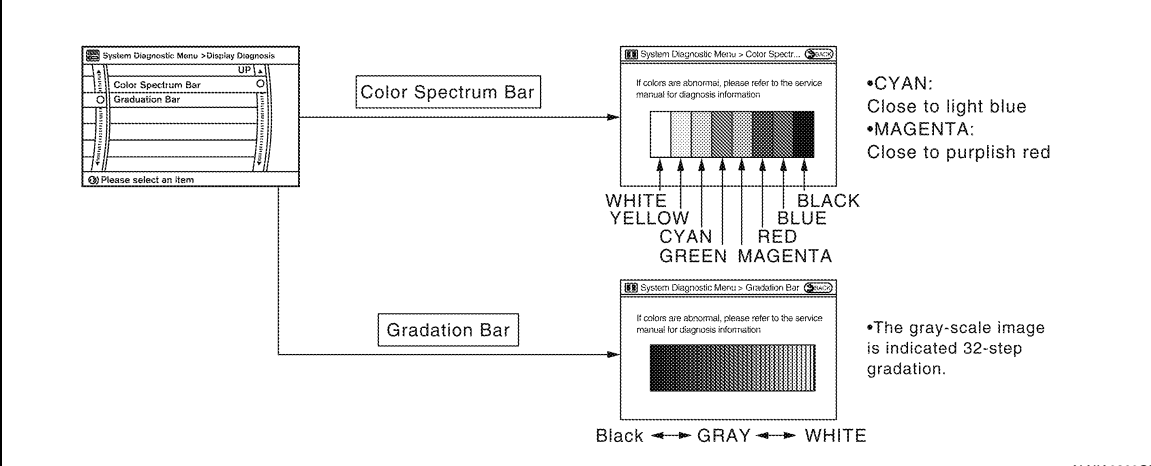

**Color Spectrum Bar**

If colors are abnormal, please refer to the service manual for diagnosis information.

- CYAN: Close to light blue
- MAGENTA: Close to purplish red

**Gradation Bar**

If colors are abnormal, please refer to the service manual for diagnosis information.

- The gray-scale image is indicated 32-step gradation.

Black ← GRAY → WHITE

ALNIA0260GB

## Vehicle Signals

A  
B  
C  
D  
E  
F  
G  
H  
I  
J  
K  
L  
M  
O  
P

AV

# DIAGNOSIS SYSTEM (AV CONTROL UNIT)

## < FUNCTION DIAGNOSIS >

[BASE AUDIO]

A comparison check can be made of each actual vehicle signal and the signals recognized by the system.

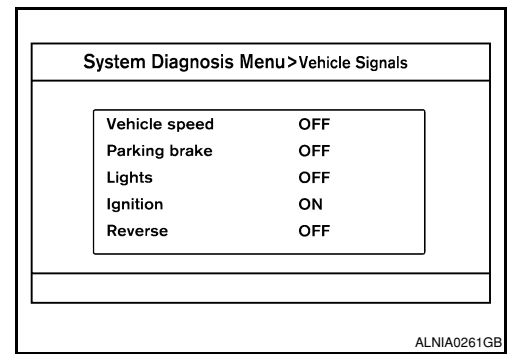

Diagnosis item	Display	Vehicle status	Remarks
Vehicle speed	ON	Vehicle speed > 0 km/h	Changes in indication may be delayed by approximately 1.5 seconds. This is normal.
	OFF	Vehicle speed = 0 km/h	
	-	Ignition switch in ACC position	
Parking brake	ON	Parking brake is applied.	
	OFF	Parking brake is released.	
Lights	ON	Light switch ON	
	OFF	Light switch OFF	
Ignition	ON	Ignition switch ON	-
	OFF	Ignition switch in ACC position	
Reverse	ON	Selector lever in R position	Changes in indication may be delayed by approximately 1.5 seconds. This is normal.
	OFF	Selector lever in any position other than R	
	-	Ignition switch in ACC position	

### Speaker Test

Select "Speaker Test" to display the speaker diagnosis screen. Press "Start" to generate a test tone in speakers. Touch "End" to stop the test tones.

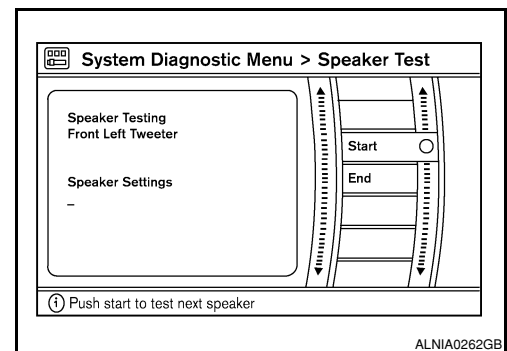

### Error History

The self-diagnosis results are judged depending on whether any error occurs from when "Self-diagnosis" is selected until the self-diagnosis results are displayed.

However, the diagnosis results are judged normal if an error has occurred before the ignition SW is turned ON and then no error has occurred until the self-diagnosis start. Check the "Error History" to detect any error that may have occurred before the self-diagnosis start because of this situation.

#### Count up method A

- The counter resets to 0 if an error occurs when IGN switch is turned ON. The counter increases by 1 if the condition is normal at a next IGN ON cycle.

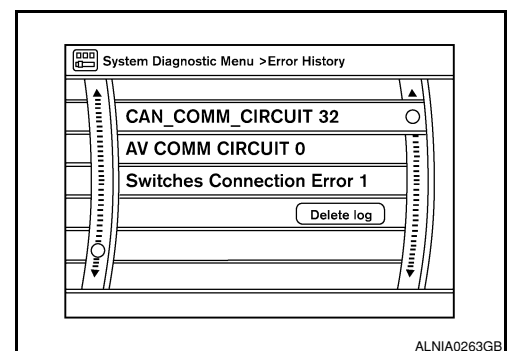

# DIAGNOSIS SYSTEM (AV CONTROL UNIT)

## < FUNCTION DIAGNOSIS >

[BASE AUDIO]

- The counter upper limit is 39. Any counts exceeding 39 are ignored. The counter can be reset (no error-record display) with the "Delete log" switch or CONSULT-III.
- Count up method B
- The counter increases by 1 if an error occurs when IGN switch is ON. The counter will not decrease even if the condition is normal at the next IGN ON cycle.
- The counter upper limit is 50. Any counts exceeding 50 are ignored. The counter can be reset (no error-record display) with the "Delete log" switch or CONSULT-III.

Display method of occurrence frequency	Error history display item
Count up method A	CAN communication line, control unit (CAN), AV communication line, control unit (AV communication)
Count up method B	Other than above

### Vehicle CAN Diagnosis

- CAN communication status and error counter is displayed.
- The error counter displays "OK" if any malfunction was not detected in the past and displays "0" if a malfunction is detected. It increases by 1 if the condition is normal at the next ignition switch ON cycle. The upper limit of the counter is 39.
- The error counter is erased if reset.

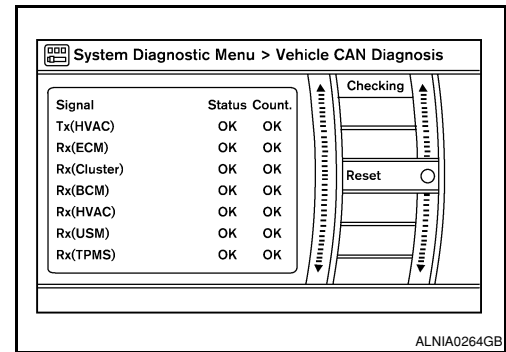

### AV COMM Diagnosis

- AV communication status and error counter is displayed.
- The error counter displays "OK" if any malfunction was not detected in the past and displays "0" if a malfunction is detected. It increases by 1 if the condition is normal at the next ignition switch ON cycle. The upper limit of the counter is 39.
- The error counter is erased if reset.

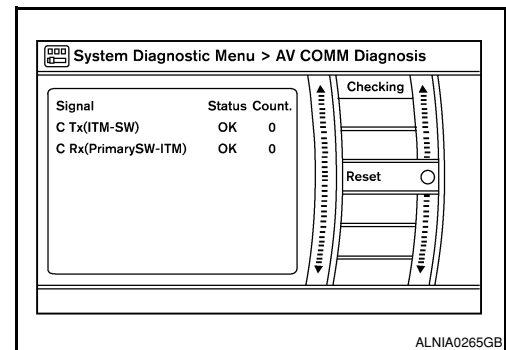

### Delete Unit Connection Log

Deletes any unit connection records and error records from the AV control unit memory. (Clear the records of the unit that has been removed)

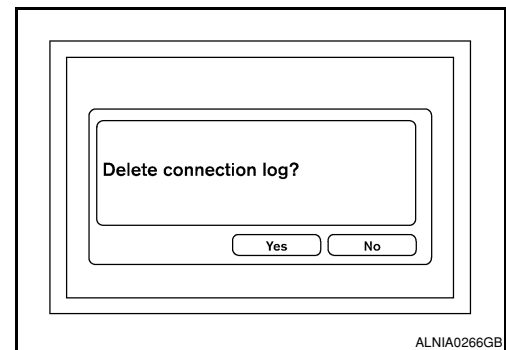

### Initialize Settings

# DIAGNOSIS SYSTEM (AV CONTROL UNIT)

< FUNCTION DIAGNOSIS >

[BASE AUDIO]

Initializes the AV control unit memory.

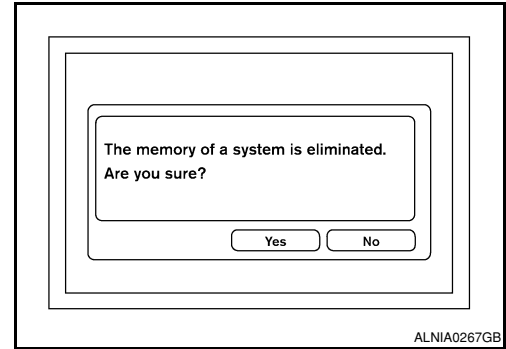

## AV CONTROL UNIT : CONSULT-III Function

INFOID:000000001301252

CONSULT-III can display each diagnostic item using the diagnostic test modes shown following.

MULTI AV diagnosis mode	Description
SELF-DIAG RESULTS	Displays AV control unit self-diagnosis results.
DATA MONITOR	Displays AV control unit input/output data in real time.
CAN DIAG SUPPORT MNTR	The result of transmit/receive diagnosis of CAN communication can be read.
AV COMM MONITOR	Allows the technician to monitor the status of the Multi AV system communication signals.
ECU PART NUMBER	The part number of AV control unit can be checked.

### SELF-DIAG RESULTS

Display Item List

Refer to [AV-93. "DTC Index"](#).

### DATA MONITOR

Display Item List

Display item [unit]	ALL SIGNALS	SELECTION FROM MENU	Description
VHCL SPD SIG [ON/OFF]	X	X	Displays "ON" when vehicle speed > 0 km/h. Displays "OFF" when vehicle speed = 0 km/h.
PKB SIG [ON/OFF]	X	X	Displays [ON/OFF] condition of parking brake switch.
ILLUM SIG [ON/OFF]	X	X	Displays [ON/OFF] condition of lighting switch.
IGN SIG [ON/OFF]	X	X	Displays [ON/OFF] condition of ignition switch.
REV SIG [ON/OFF]	X	X	Displays [ON/OFF] condition of back-up lamp switch.

### A/C AND AV SWITCH ASSEMBLY

#### A/C AND AV SWITCH ASSEMBLY : Component Function Check

INFOID:000000001317775

A/C and AV switch assembly self-diagnosis function

Description

The ON/OFF operation (continuity) of each switch in the A/C and AV switch assembly can be checked.

Self-diagnosis mode

# DIAGNOSIS SYSTEM (AV CONTROL UNIT)

## < FUNCTION DIAGNOSIS >

[BASE AUDIO]

- Press the “BACK” button and the “UP” button within 10 seconds after turning the ignition switch from OFF to ACC and hold them for 3 seconds or more. When the self-diagnosis mode starts, a beep will sound and all LED indicators of the switch will illuminate.
- The continuity of each switch and control dial of the A/C and AV switch assembly can be checked. If the switch is operating normally, the system will beep and the LED’s will illuminate when each switch is operated.

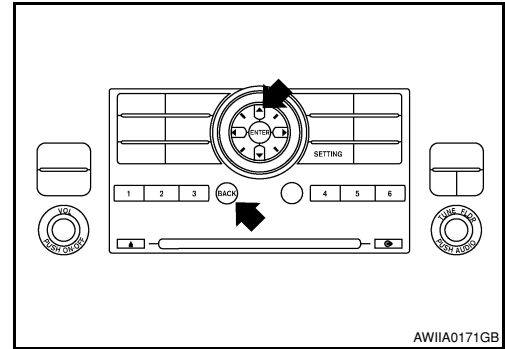

Finishing self-diagnosis mode

Self-diagnosis mode is canceled when the ignition switch is turned OFF.

A  
B  
C  
D  
E  
F  
G  
H  
I  
J  
K  
L  
M  
N  
O  
P

AV

## COMPONENT DIAGNOSIS

### U1000 CAN COMM CIRCUIT

#### Description

INFOID:000000001315105

CAN (Controller Area Network) is a serial communication line for real time application. It is an on-vehicle multiplex communication line with high data communication speed and excellent error detection ability. Many electronic control units are equipped onto a vehicle and each control unit shares information and links with other control units during operation (not independent). In CAN communication, control units are connected with 2 communication lines (CAN-H, CAN-L) allowing a high rate of information transmission with less wiring. Each control unit transmits/receives data but selectively reads required data only.

CAN Communication Signal Chart. Refer to [LAN-46, "CAN Communication Signal Chart"](#).

#### DTC Logic

INFOID:000000001315106

#### DTC DETECTION LOGIC

DTC	Display contents of CONSULT-III	Diagnostic item is detected when ...	Probable malfunction location
U1000	CAN COMM CIRCUIT	When AV control unit is not transmitting or receiving CAN communication signal for 2 seconds or more.	CAN communication system

#### Diagnosis Procedure

INFOID:000000001315107

#### 1. PERFORM SELF DIAGNOSTIC

1. Turn ignition switch ON and wait for 2 seconds or more.
2. Check "Self Diagnostic Result" of "AV Control Unit".

#### Is "CAN COMM CIRCUIT" displayed?

- YES >> Refer to "LAN system". Refer to [LAN-14, "Trouble Diagnosis Flow Chart"](#).
- NO >> Refer to GI section. Refer to [GI-39, "Intermittent Incident"](#).



# U1010 CONTROL UNIT (CAN)

< COMPONENT DIAGNOSIS >

[BASE AUDIO]

## U1010 CONTROL UNIT (CAN)

### Description

INFOID:000000001315108

Initial diagnosis of AV control unit.

### DTC Logic

INFOID:000000001315109

### DTC DETECTION LOGIC

DTC	Display contents of CONSULT-III	Diagnostic item is detected when ...	Probable malfunction location
U1010	CONTROL UNIT (CAN)	CAN initial diagnosis malfunction is detected	AV control unit

### Diagnosis Procedure

INFOID:000000001315110

#### 1. REPLACE AV CONTROL UNIT

When DTC U1010 is detected, replace AV control unit. Refer to [AV-104. "Removal and Installation"](#)

>> INSPECTION END

A  
B  
C  
D  
E  
F  
G  
H  
I  
J  
K  
L  
M  
O  
P

AV

# U1200 AV CONTROL UNIT

< COMPONENT DIAGNOSIS >

[BASE AUDIO]

## U1200 AV CONTROL UNIT

### Description

INFOID:000000001315113

Replace the AV control unit if this DTC is displayed. Refer to [AV-104. "Removal and Installation"](#).

Part name	Description
AV CONTROL UNIT	<ul style="list-style-type: none"><li>• It is the master unit of the MULTI AV system and it is connected to each control unit by means of communication. It operates each system according to communication signals from the AV control unit.</li><li>• AV control unit includes audio function and vehicle information function.</li><li>• It is connected to ECM and combination meter via CAN communication to obtain necessary information for the vehicle information function.</li><li>• It inputs the automatic brightness ON/OFF signals that are required for the display dimming control.</li><li>• It inputs the signals for driving status recognition (vehicle speed, reverse and parking brake).</li></ul>

### DTC Logic

INFOID:000000001315114

DTC	Display contents of CONSULT-III	DTC Detection Condition	Action to take
U1200	Control Unit FLASH- ROM [U1200]	An internal malfunction is detected in AV control unit (FLASH-ROM).	Replace AV control unit. Refer to <a href="#">AV-104. "Removal and Installation"</a>

# U1216 AV CONTROL UNIT

< COMPONENT DIAGNOSIS >

[BASE AUDIO]

## U1216 AV CONTROL UNIT

### Description

INFOID:000000001315115

Replace the AV control unit if this DTC is displayed. Refer to [AV-104, "Removal and Installation"](#).

Part name	Description
AV CONTROL UNIT	<ul style="list-style-type: none"><li>• It is the master unit of the MULTI AV system and it is connected to each control unit by means of communication. It operates each system according to communication signals from the AV control unit.</li><li>• AV control unit includes audio function and vehicle information function.</li><li>• It is connected to ECM and combination meter via CAN communication to obtain necessary information for the vehicle information function.</li><li>• It inputs the automatic brightness ON/OFF signals that are required for the display dimming control.</li><li>• It inputs the signals for driving status recognition (vehicle speed, reverse and parking brake).</li></ul>

### DTC Logic

INFOID:000000001315116

DTC	Display contents of CONSULT-III	DTC Detection Condition	Action to take
U1216	CAN CONT [U1216]	Internal malfunction of AV control unit (CAN controller) is detected.	Replace AV control unit. Refer to <a href="#">AV-104, "Removal and Installation"</a>

A  
B  
C  
D  
E  
F  
G  
H  
I  
J  
K  
L  
M  
O  
P

AV

## U1240 SWITCH CONN

### Description

INFOID:000000001609780

U1240 is indicated when malfunction occurs in communication signal of multi AV system. Indicated simultaneously, without fail, with the malfunction of control units connected to AV control unit with communication line. Determine the possible malfunction cause from the table below.

### Self-diagnosis results display item

DTC	Display contents of CONSULT-III	DTC Detection Condition	Possible causes
U1240	<ul style="list-style-type: none"> <li>• SWITCH CONN [U1240]</li> </ul>	<ul style="list-style-type: none"> <li>• A/C and AV switch assembly power supply and ground circuit malfunction is detected</li> <li>• A malfunction is detected in communication circuit between AV control unit and A/C and AV switch assembly</li> <li>• A malfunction is detected in communication signal between AV control unit and A/C and AV switch assembly</li> </ul>	<ul style="list-style-type: none"> <li>• A/C and AV switch assembly power supply and ground circuits</li> <li>• Communication circuit between AV control unit and A/C and AV switch assembly</li> </ul>

# U1243 DISPLAY UNIT

< COMPONENT DIAGNOSIS >

[BASE AUDIO]

## U1243 DISPLAY UNIT

### Description

INFOID:000000001315117

Part name	Description
DISPLAY UNIT	<ul style="list-style-type: none"> <li>• Display image is controlled by the serial communication from AV control unit.</li> <li>• Inputs the RGB image signal (RGB, RGB area and RGB synchronizing) from AV control unit and the auxiliary image signal from the auxiliary input jacks.</li> <li>• Outputs the synchronizing signals (HP and VP) to the AV control unit.</li> </ul>

### DTC Logic

INFOID:000000001315118

DTC	Display contents of CONSULT-III	DTC Detection Condition	Possible causes
U1243	FRONT DISP CONN [U1243]	<ul style="list-style-type: none"> <li>• Display unit power supply and ground circuit malfunction is detected</li> <li>• Malfunction is detected on communication circuit between display unit and AV control unit</li> <li>• Malfunction is detected on communication signal between display unit and AV control unit</li> </ul>	<ul style="list-style-type: none"> <li>• Display unit power supply and ground circuit</li> <li>• Communication circuit between display unit and AV control unit</li> </ul>

### Diagnosis Procedure

INFOID:000000001315119

#### 1. CHECK DISPLAY UNIT POWER SUPPLY AND GROUND CIRCUIT

Check display unit power supply and ground circuit. Refer to [AV-36. "DISPLAY UNIT : Diagnosis Procedure"](#).

Is inspection result OK?

YES >> GO TO 2.

NO >> Repair malfunctioning parts.

#### 2. CHECK CONTINUITY OF COMMUNICATION CIRCUIT

1. Turn ignition switch OFF.
2. Disconnect display unit connector and AV control unit connector.
3. Check continuity between display unit harness connector M93 (A) terminals 11, 22 and AV control unit harness connector M44 (B) terminals 56, 44.

A		B		Continuity
Connector	Terminal	Connector	Terminal	
M93	11	M44	56	Yes
	22		44	

4. Check continuity between display unit harness connector M93 (A) terminals 11, 22 and ground.

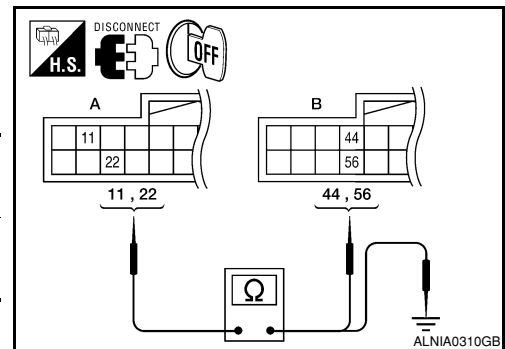

A		—	Continuity
Connector	Terminal		
M93	11	Ground	No
	22		

Are continuity results as specified?

YES >> GO TO 3.

NO >> Repair harness or connector.

#### 3. CHECK COMMUNICATION SIGNAL

1. Connect display unit connector and AV control unit connector.
2. Turn ignition switch ON.

# U1243 DISPLAY UNIT

[BASE AUDIO]

< COMPONENT DIAGNOSIS >

3. Check signal between display unit harness connector M93 terminal 11 and ground with an oscilloscope or CONSULT-III.

(+)		(-)	Reference signal
Connector	Terminal		
M93	11	Ground	

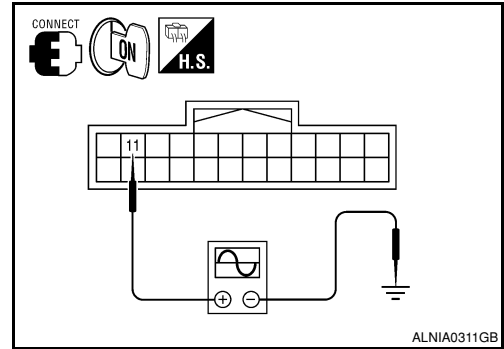

Are voltage readings as specified?

YES >> GO TO 4.

NO >> Replace AV control unit. Refer to [AV-104. "Removal and Installation"](#)

## 4. CHECK COMMUNICATION SIGNAL

Check signal between display unit harness connector M93 terminal 22 and ground with an oscilloscope or CONSULT-III.

(+)		(-)	Reference signal
Connector	Terminal		
M93	22	Ground	

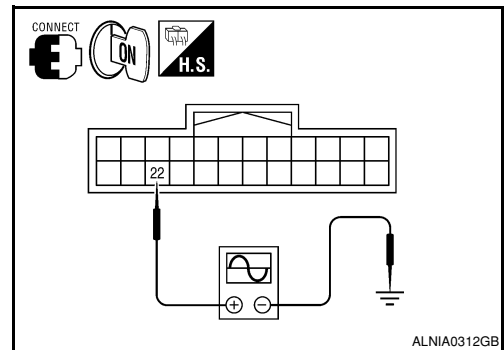

Are voltage readings as specified?

YES >> INSPECTION END

NO >> Replace display unit. Refer to [AV-106. "Removal and Installation"](#)

U1248 DVD DECK CONN

Description

INFOID:000000001609631

U1248 is indicated when a malfunction occurs in the communication signal of the DVD player. Indicated simultaneously, without fail, with the malfunction of control units connected to AV control unit with communication line. Determine the possible malfunction cause from the table below.

DTC Logic

INFOID:000000001609632

DTC	Display contents of CONSULT-III	DTC Detection Condition	Possible causes
U1248	DVD DECK CONN [U1248]	<ul style="list-style-type: none"> <li>DVD player power supply and ground circuit malfunction is detected</li> <li>Malfunction is detected on communication circuit between DVD player and AV control unit</li> <li>Malfunction is detected on communication signal between DVD player and AV control unit</li> </ul>	<ul style="list-style-type: none"> <li>DVD player power supply and ground circuit</li> <li>Communication circuit between DVD player and AV control unit</li> </ul>

Diagnosis Procedure

INFOID:000000001609633

1. CHECK DVD PLAYER POWER SUPPLY AND GROUND CIRCUIT

Check DVD player power supply and ground circuit. Refer to [AV-39. "DVD PLAYER : Diagnosis Procedure"](#)  
Is inspection result OK?

- YES >> INSPECTION END.
- NO >> Repair malfunctioning parts.



# U1255 SATELLITE RADIO TUNER

< COMPONENT DIAGNOSIS >

[BASE AUDIO]

## U1255 SATELLITE RADIO TUNER

### Description

INFOID:000000001315120

Part name	Description
SATELLITE RADIO TUNER	<ul style="list-style-type: none"><li>• Inputs the satellite radio signal from satellite radio antenna and outputs it to the AV control unit.</li><li>• It is controlled with the communication (communication signal, request signal) from AV control unit.</li></ul>

### DTC Logic

INFOID:000000001315121

DTC	Display contents of CONSULT-III	DTC Detection Condition	Possible causes
U1255	SAT CONN [U1255]	The satellite radio tuner power supply and ground circuit malfunction is detected	Satellite radio tuner power supply and ground circuit

### Diagnosis Procedure

INFOID:000000001315122

#### 1. CHECK SATELLITE RADIO TUNER POWER SUPPLY AND GROUND CIRCUIT

Check satellite radio tuner power supply and ground circuit. Refer to [AV-38. "SATELLITE RADIO TUNER : Diagnosis Procedure"](#).

Is inspection result OK?

- YES >> INSPECTION END
- NO >> Repair malfunctioning parts.



# U1300 AV COMM CIRCUIT

< COMPONENT DIAGNOSIS >

[BASE AUDIO]

## U1300 AV COMM CIRCUIT

### Description

INFOID:000000001315123

U1300 is indicated when malfunction occurs in communication signal of multi AV system. Indicated simultaneously, without fail, with the malfunction of control units connected to AV control unit with communication line. Determine the possible malfunction cause from the table below.

### Self-diagnosis results display item

DTC	Display contents of CONSULT-III	DTC Detection Condition	Possible causes
U1300	• AV COMM CIRCUIT [U1300]	When AV control unit is not transmitting or receiving AV communication signal for 2 seconds or more.	AV communication system

A  
B  
C  
D  
E  
F  
G  
H  
I  
J  
K  
L  
M  
O  
P

AV

# U1310 AV CONTROL UNIT

< COMPONENT DIAGNOSIS >

[BASE AUDIO]

## U1310 AV CONTROL UNIT

### Description

INFOID:000000001315111

Replace the AV control unit if this DTC is displayed. Refer to [AV-104, "Removal and Installation"](#).

Part name	Description
AV CONTROL UNIT	<ul style="list-style-type: none"><li>• It is the master unit of the MULTI AV system and it is connected to each control unit by means of communication. It operates each system according to communication signals from the AV control unit.</li><li>• AV control unit includes audio function and vehicle information function.</li><li>• It is connected to ECM and combination meter via CAN communication to obtain necessary information for the vehicle information function.</li><li>• It inputs the automatic brightness ON/OFF signals that are required for the display dimming control.</li><li>• It inputs the signals for driving status recognition (vehicle speed, reverse and parking brake).</li></ul>

### DTC Logic

INFOID:000000001315112

DTC	Display contents of CONSULT-III	DTC Detection Condition	Action to take
U1310	CONTROL UNIT (AV) [U1310]	An initial diagnosis error is detected in AV communication circuit.	Replace AV control unit. Refer to <a href="#">AV-104, "Removal and Installation"</a>

# POWER SUPPLY AND GROUND CIRCUIT

< COMPONENT DIAGNOSIS >

[BASE AUDIO]

## POWER SUPPLY AND GROUND CIRCUIT

### AV CONTROL UNIT

#### AV CONTROL UNIT : Diagnosis Procedure

INFOID:000000001297318

### 1. CHECK FUSES

Check that the following fuses of the AV control unit are not are not blown.

Unit	Terminals	Signal name	Fuse No.
AV control unit	19	Battery power	31
	7	Ignition switch ACC or ON	4
	104	Ignition switch ON or START	12

Are the fuses OK?

YES >> GO TO 2

NO >> If fuse is blown, be sure to eliminate cause of malfunction before installing new fuse.

### 2. POWER SUPPLY CIRCUIT CHECK

1. Disconnect AV control unit connectors M42 and M46.
2. Check voltage between the AV control unit connectors M42 and M46 and ground.

Connector	(+) Terminal		(-)	OFF	ACC	ON	START
M42	7	Ground	0V	Battery voltage	Battery voltage	Battery voltage	0V
	19	Ground	Battery voltage	Battery voltage	Battery voltage	Battery voltage	Battery voltage
M46	104	Ground	0V	0V	Battery voltage	Battery voltage	Battery voltage

Are the voltage results as specified?

YES >> GO TO 3

- NO >>
- Check connector housings for disconnected or loose terminals.
  - Repair harness or connector.

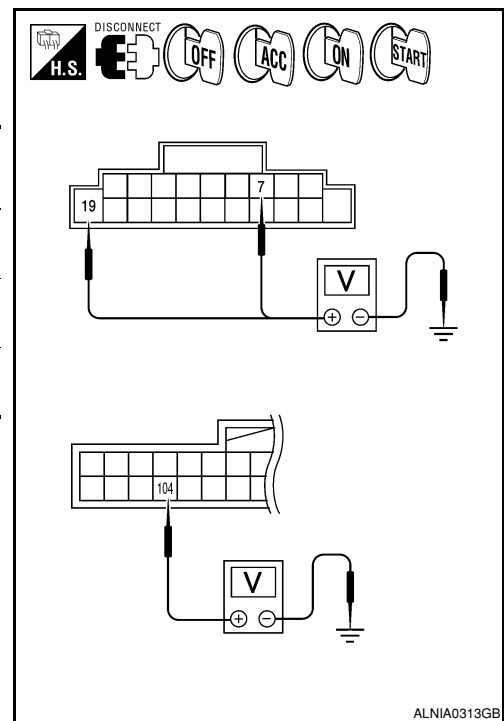

### 3. GROUND CIRCUIT CHECK

A  
B  
C  
D  
E  
F  
G  
H  
I  
J  
K  
L  
M  
O  
P

AV

# POWER SUPPLY AND GROUND CIRCUIT

[BASE AUDIO]

## < COMPONENT DIAGNOSIS >

1. Turn ignition switch OFF.
2. Check continuity between AV control unit harness connectors M42, M44 and M46 and ground.

(+)		(-)	Continuity
Connector	Terminal		
M42	20	Ground	Yes
M44	54		
M46	85		

Are the continuity results as specified?

- YES >> Inspection End.  
 NO >> Repair AV control unit ground.

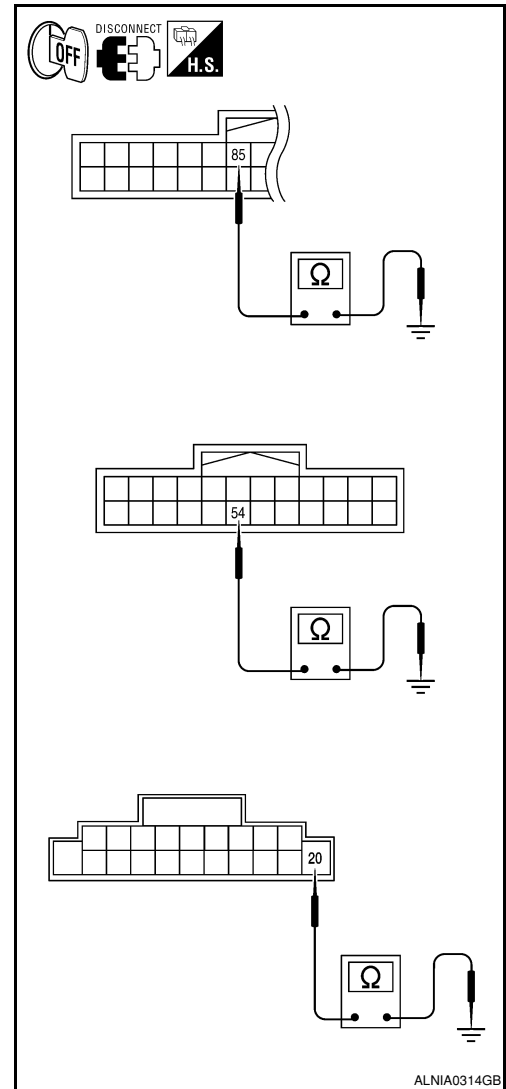

## DISPLAY UNIT

### DISPLAY UNIT : Diagnosis Procedure

INFOID:000000001316548

#### 1. CHECK POWER SUPPLY CIRCUIT

1. Turn ignition switch to ACC.
2. Check voltage between display unit harness connector M93 and ground.

Signal name	Connector No.	Terminal No.	Ignition switch position	Value (Approx.)
Inverter VCC	M93	2	ACC	9V
Signal VCC		3		

Does specified voltage exist?

- YES >> GO TO 3.  
 NO >> GO TO 2.

#### 2. CHECK POWER SUPPLY CIRCUIT

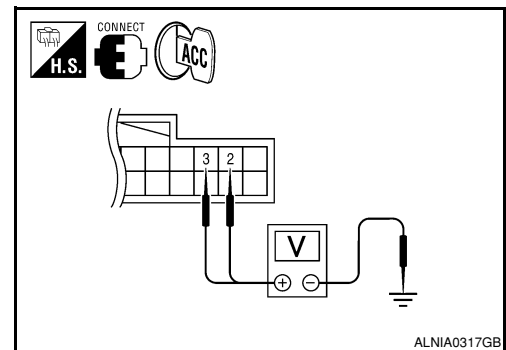

# POWER SUPPLY AND GROUND CIRCUIT

## < COMPONENT DIAGNOSIS >

[BASE AUDIO]

1. Turn ignition switch OFF.
2. Disconnect the display unit connector M93 and the AV control unit connector M44.
3. Check continuity between the display unit harness connector M93 (A) and the AV control unit connector M44 (B).

A		B		Continuity
Connector	Terminal	Connector	Terminal	
M93	2	M44	59	Yes
	3		47	

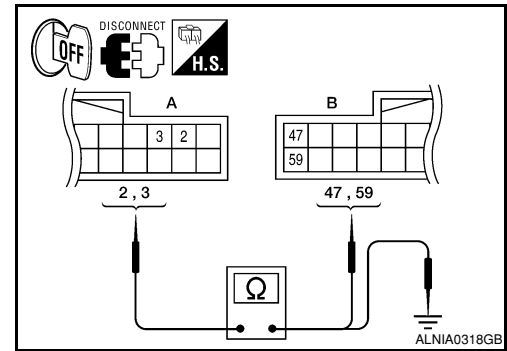

4. Check continuity between the display unit harness connector M93 (A) and ground.

A		—	Continuity
Connector	Terminal		
M93	2	Ground	No
	3		

### Are continuity results as specified?

YES >> Check AV control unit power and ground supply. Refer to [AV-35. "AV CONTROL UNIT : Diagnosis Procedure"](#)

NO >> Repair harness or connector.

## 3.CHECK GROUND CIRCUIT

1. Turn ignition switch OFF.
2. Disconnect display unit connector.
3. Check continuity between display unit harness connector and ground.

Connector	Terminal	—	Continuity
M93	1	Ground	Yes

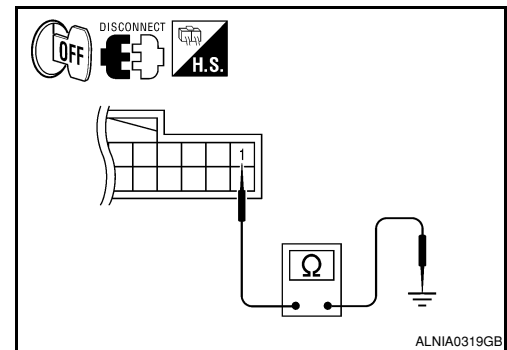

### Does continuity exist?

YES >> INSPECTION END

NO >> Repair harness or connector.

## A/C AND AV SWITCH ASSEMBLY

### A/C AND AV SWITCH ASSEMBLY : Diagnosis Procedure

INFOID:000000001315187

## 1.CHECK FUSE

Check that the fuse of the AC and AV switch assembly is not blown.

Unit	Terminal	Signal name	Fuse No.
A/C and AV switch assembly	2	Ignition switch ACC or ON	4

### Is the fuse OK?

YES >> GO TO 2

NO >> If fuse is blown, be sure to eliminate cause of malfunction before installing new fuse.

## 2.POWER SUPPLY CIRCUIT CHECK

# POWER SUPPLY AND GROUND CIRCUIT

[BASE AUDIO]

## < COMPONENT DIAGNOSIS >

1. Disconnect A/C and AV switch assembly connector M98.
2. Check voltage between the A/C and AV switch assembly connector M98 and ground.

(+)		(-)	OFF	ACC	ON
Connector	Terminal				
M98	2	Ground	0V	Battery voltage	Battery voltage

Are the voltage results as specified?

- YES >> GO TO 3  
 NO >> • Check connector housings for disconnected or loose terminals.  
 • Repair harness or connector.

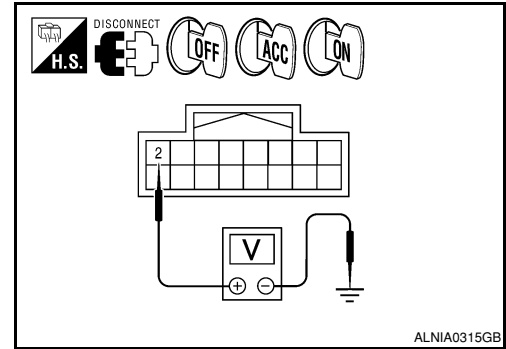

ALNIA0316GB

## 3. GROUND CIRCUIT CHECK

1. Turn ignition switch OFF.
2. Check continuity between A/C and AV switch assembly harness connector M98 and ground.

Connector	Terminal	—	Continuity
M98	1	Ground	Yes

Are the continuity results as specified?

- YES >> Inspection End.  
 NO >> Repair harness or ground.

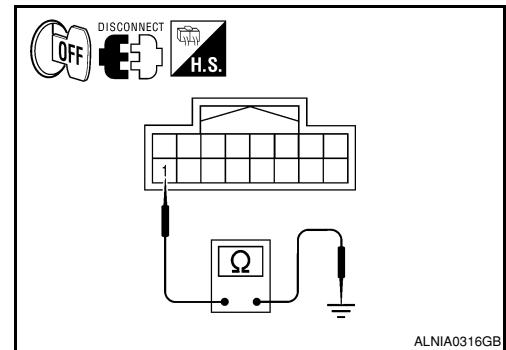

ALNIA0316GB

## SATELLITE RADIO TUNER

### SATELLITE RADIO TUNER : Diagnosis Procedure

INFOID:000000001297319

## 1. CHECK FUSES

Check that the following fuses of the satellite radio tuner (factory installed) are not blown.

Unit	Terminals	Signal name	Fuse No.
Satellite radio tuner (factory installed)	32	Battery power	31
	36	Ignition switch ACC or ON	4

Are the fuses OK?

- YES >> GO TO 2  
 NO >> If fuse is blown, be sure to eliminate cause of malfunction before installing new fuse.

## 2. POWER SUPPLY CIRCUIT CHECK

1. Turn ignition switch OFF.
2. Disconnect satellite radio tuner (factory installed) connector M41.
3. Check voltage between the satellite radio tuner (factory installed) and ground.

(+)		(-)	OFF	ACC	ON
Connector	Terminal				
M41	32	Ground	Battery voltage	Battery voltage	Battery voltage
	36		0V	Battery voltage	Battery voltage

Are the voltage readings as specified?

- YES >> GO TO 3  
 NO >> • Check connector housings for disconnected or loose terminals.

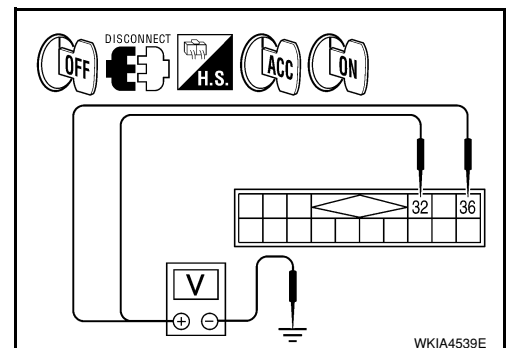

WKIA4539E

# POWER SUPPLY AND GROUND CIRCUIT

< COMPONENT DIAGNOSIS >

[BASE AUDIO]

- Repair harness or connector.

## 3. GROUND CIRCUIT CHECK

Inspect satellite radio tuner (factory installed) case ground.

Does case ground pass inspection?

- YES >> Inspection End.  
 NO >> Repair satellite radio tuner (factory installed) case ground.

## DVD PLAYER

### DVD PLAYER : Diagnosis Procedure

INFOID:000000001316462

#### 1. CHECK FUSE

Check that the following fuses of the DVD player are not blown.

Unit	Terminal	Signal name	Fuse No.
DVD player	21	Battery power	31
	24	Ignition switch ACC or ON	4

Is the fuse OK?

- YES >> GO TO 2  
 NO >> If fuse is blown, be sure to eliminate cause of malfunction before installing new fuse.

#### 2. POWER SUPPLY CIRCUIT CHECK

1. Disconnect DVD player connector M205.
2. Check voltage between the DVD player connector M205 and ground.

(+)		(-)	OFF	ACC	ON
Connector	Terminal				
M205	21	Ground	Battery voltage	Battery voltage	Battery voltage
	24		0V	Battery voltage	Battery voltage

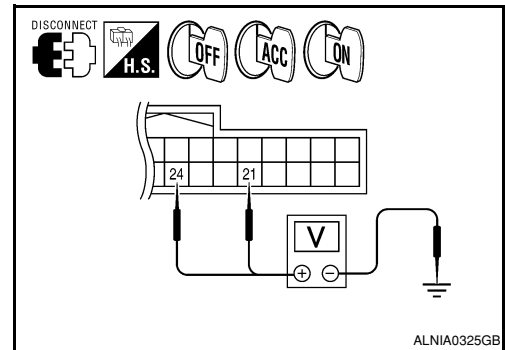

Are the voltage results as specified?

- YES >> GO TO 3  
 NO >> • Check connector housings for disconnected or loose terminals.  
 • Repair harness or connector.

#### 3. GROUND CIRCUIT CHECK

1. Turn ignition switch OFF.
2. Check continuity between DVD player harness connector M205 terminal 5 and ground.

Connector	Terminal	—	Continuity
M205	5	Ground	Yes

Are the continuity results as specified?

- YES >> Inspection End.  
 NO >> Repair DVD player ground.

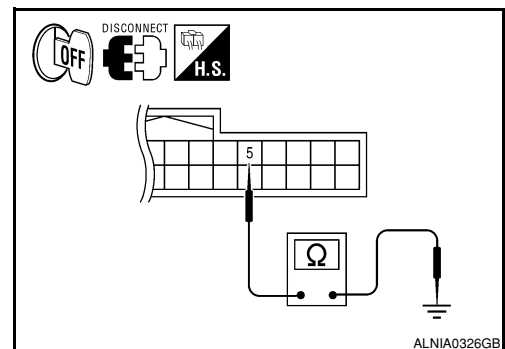

## VIDEO MONITOR

### VIDEO MONITOR : Diagnosis Procedure

INFOID:000000001316561

#### 1. CHECK POWER SUPPLY CIRCUIT

1. Turn ignition switch to ACC.

# POWER SUPPLY AND GROUND CIRCUIT

[BASE AUDIO]

## < COMPONENT DIAGNOSIS >

- Check voltage between video monitor harness connector R202 and ground.

Signal name	Connector No.	Terminal No.	Ignition switch position	Value (Approx.)
Display B+	R202	11	ACC	12V
		12		

Does specified voltage exist?

- YES >> GO TO 3.  
NO >> GO TO 2.

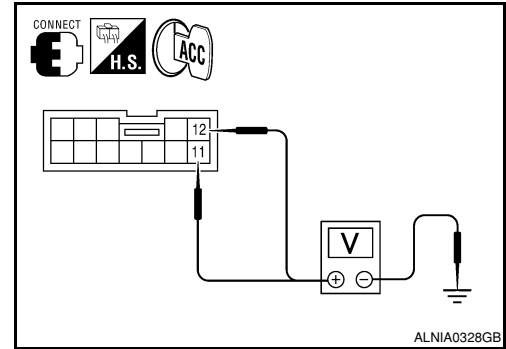

## 2.CHECK POWER SUPPLY CIRCUIT

- Turn ignition switch OFF.
- Disconnect the video monitor connector R202 and the DVD player connector M205.
- Check continuity between the video monitor harness connector R202 (A) and the DVD player connector M205 (B).

A		B		Continuity
Connector	Terminal	Connector	Terminal	
R202	11	M205	9	Yes
	12		25	

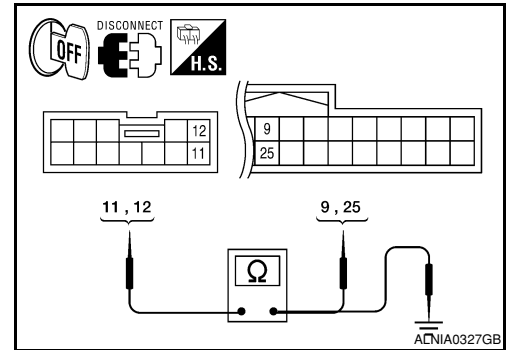

- Check continuity between video monitor harness connector R202 (A) and ground.

A		—	Continuity
Connector	Terminal		
R202	11	Ground	No
	12		

Are continuity test results as specified?

- YES >> Check DVD player power and ground supply. Refer to [AV-35, "AV CONTROL UNIT : Diagnosis Procedure"](#)  
NO >> Repair harness or connector.

## 3.CHECK GROUND CIRCUIT

- Turn ignition switch OFF.
- Disconnect video monitor connector.
- Check continuity between video monitor harness connector R202 and ground.

Connector No.	Terminal No.	—	Continuity
R202	1	Ground	Yes
	2		

Does continuity exist?

- YES >> INSPECTION END  
NO >> Repair harness or connector.

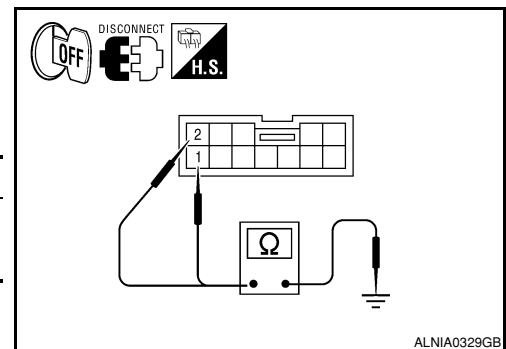



# RGB (R: RED) SIGNAL CIRCUIT

< COMPONENT DIAGNOSIS >

[BASE AUDIO]

## RGB (R: RED) SIGNAL CIRCUIT

### Description

INFOID:000000001322709

Transmit the image displayed with AV control unit with RGB signal to the display unit.

### Diagnosis Procedure

INFOID:000000001322710

#### 1. CHECK CONTINUITY RGB (R: RED) SIGNAL CIRCUIT

1. Turn ignition switch OFF.
2. Disconnect display unit connector M93 and AV control unit connector M44.
3. Check continuity between display unit harness connector M93 (A) terminal 17 and AV control unit harness connector M44 (B) terminal 40.

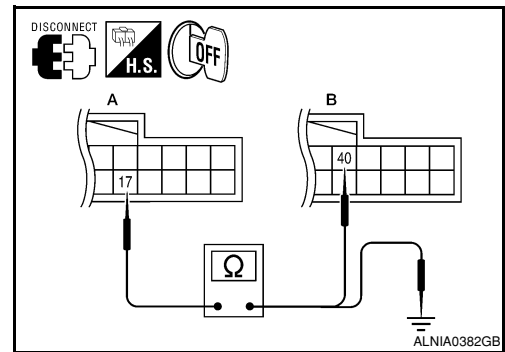

A		B		Continuity
Connector	Terminal	Connector	Terminal	
M93	17	M44	40	Yes

4. Check continuity between display unit harness connector M93 (A) terminal 17 and ground.

A		—	Continuity
Connector	Terminal		
M93	17	Ground	No

Are the continuity results as specified?

YES >> GO TO 2.

NO >> Repair harness or connector.

#### 2. CHECK RGB (R: RED) SIGNAL

1. Connect display unit connector M93 and AV control unit connector M44.
2. Turn ignition switch ON.
3. Check signal between display unit harness connector M93 terminal 17 and ground.

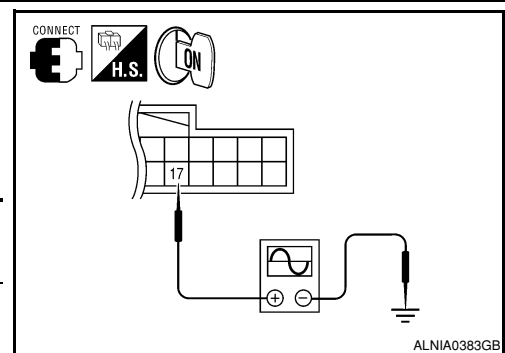

(+) Connector		(-)	Condition	Reference signal
Connector	Terminal			
M93	17	Ground	Receive audio signal	<p>SKIB2238J</p>

Are the voltage readings as specified?

YES >> Replace display unit. Refer to [AV-106, "Removal and Installation"](#)

NO >> Replace AV control unit. Refer to [AV-104, "Removal and Installation"](#)

A  
B  
C  
D  
E  
F  
G  
H  
I  
J  
K  
L  
M  
AV  
O  
P

# RGB (G: GREEN) SIGNAL CIRCUIT

< COMPONENT DIAGNOSIS >

[BASE AUDIO]

## RGB (G: GREEN) SIGNAL CIRCUIT

### Description

INFOID:000000001322711

Transmit the image displayed with AV control unit with RGB signal to the display unit.

### Diagnosis Procedure

INFOID:000000001322712

#### 1. CHECK CONTINUITY RGB (G: GREEN) SIGNAL CIRCUIT

1. Turn ignition switch OFF.
2. Disconnect display unit connector M93 and AV control unit connector M44.
3. Check continuity between display unit harness connector M93 (A) terminal 6 and AV control unit harness connector M44 (B) terminal 39.

A		B		Continuity
Connector	Terminal	Connector	Terminal	
M93	6	M44	39	Yes

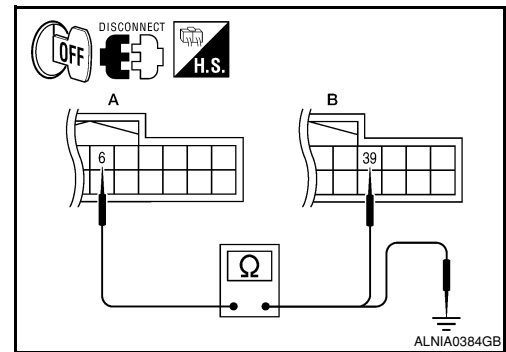

4. Check continuity between display unit harness connector M93 (A) terminal 6 and ground.

A		—	Continuity
Connector	Terminal		
M93	6	Ground	No

Are the continuity results as specified?

YES >> GO TO 2.

NO >> Repair harness or connector.

#### 2. CHECK RGB (G: GREEN) SIGNAL

1. Connect display unit connector M93 and AV control unit connector M44.
2. Turn ignition switch ON.
3. Check signal between display unit harness connector M93 terminal 6 and ground.

(+) Connector		(-)	Condition	Reference signal
Connector	Terminal			
M93	6	Ground	Receive audio signal	

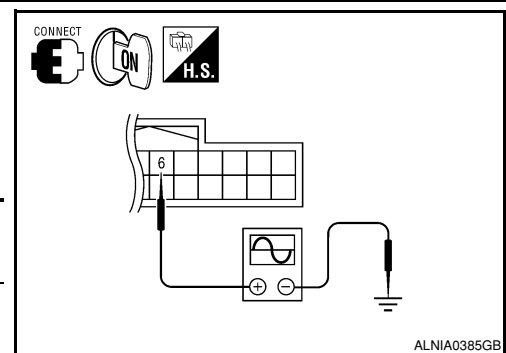

Are voltage readings as specified?

YES >> Replace display unit. Refer to [AV-106, "Removal and Installation"](#)

NO >> Replace AV control unit. Refer to [AV-104, "Removal and Installation"](#)

# RGB (B: BLUE) SIGNAL CIRCUIT

< COMPONENT DIAGNOSIS >

[BASE AUDIO]

## RGB (B: BLUE) SIGNAL CIRCUIT

### Description

INFOID:000000001322713

Transmit the image displayed with AV control unit with RGB signal to the display unit.

### Diagnosis Procedure

INFOID:000000001322714

#### 1. CHECK CONTINUITY RGB (B: BLUE) SIGNAL CIRCUIT

1. Turn ignition switch OFF.
2. Disconnect display unit connector M93 and AV control unit connector M44.
3. Check continuity between display unit harness connector M93 (A) terminal 18 and AV control unit harness connector M44 (B) terminal 38.

A		B		Continuity
Connector	Terminal	Connector	Terminal	
M93	18	M44	38	Yes

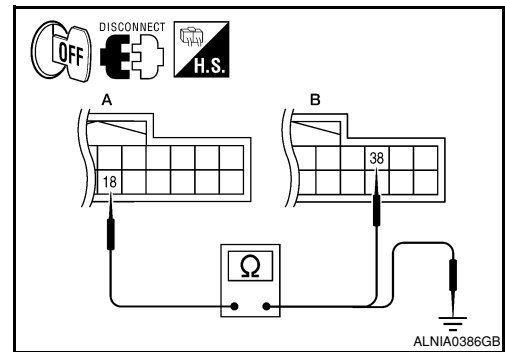

4. Check continuity between display unit harness connector M93 (A) terminal 18 and ground.

A		—	Continuity
Connector	Terminal		
M93	18	Ground	No

Are continuity results as specified?

YES >> GO TO 2.

NO >> Repair harness or connector.

#### 2. CHECK RGB (B: BLUE) SIGNAL

1. Connect display unit connector M93 and AV control unit connector M44.
2. Turn ignition switch ON.
3. Check signal between display unit harness connector M93 terminal 18 and ground.

(+)		(-)	Condition	Reference signal
Connector	Terminal			
M93	18	Ground	Receive audio signal	<p>The graph shows a square wave signal oscillating between approximately 0.4V and -0.4V. The vertical axis is labeled '(V)' with values 0.4, 0, and -0.4. The horizontal axis is labeled '40µs'. The signal is identified as 'Receive audio signal'.</p>

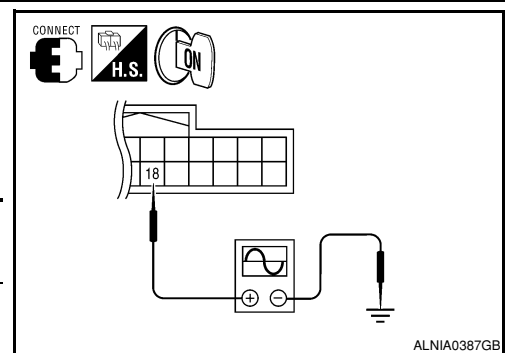

Are voltage readings as specified?

YES >> Replace display unit. Refer to [AV-106, "Removal and Installation"](#)

NO >> Replace AV control unit. Refer to [AV-104, "Removal and Installation"](#)

# RGB SYNCHRONIZING SIGNAL CIRCUIT

< COMPONENT DIAGNOSIS >

[BASE AUDIO]

## RGB SYNCHRONIZING SIGNAL CIRCUIT

### Description

INFOID:000000001322715

Transmit the RGB synchronizing signal to the display unit so as to synchronize the RGB image displayed with AV control unit.

### Diagnosis Procedure

INFOID:000000001322716

#### 1. CHECK CONTINUITY RGB SYNCHRONIZING SIGNAL CIRCUIT

1. Turn ignition switch OFF.
2. Disconnect display unit connector M93 and AV control unit connector M44.
3. Check continuity between display unit harness connector M93 (A) terminal 19 and AV control unit harness connector M44 (B) terminal 41.

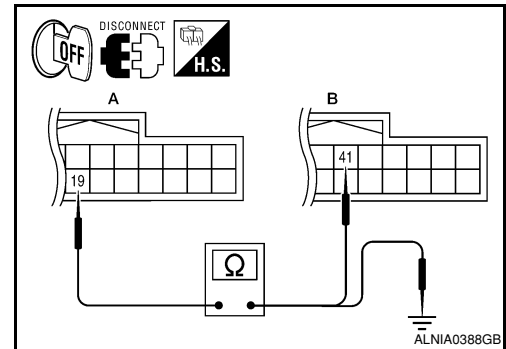

A		B		Continuity
Connector	Terminal	Connector	Terminal	
M93	19	M44	41	Yes

4. Check continuity between display unit harness connector M93 (A) terminal 19 and ground.

A		—	Continuity
Connector	Terminal		
M93	19	Ground	No

Are continuity results as specified?

YES >> GO TO 2.

NO >> Repair harness or connector.

#### 2. CHECK RGB SYNCHRONIZING SIGNAL

1. Connect display unit connector M93 and AV control unit connector M44.
2. Turn ignition switch ON.
3. Check signal between display unit harness connector M93 terminal 19 and ground.

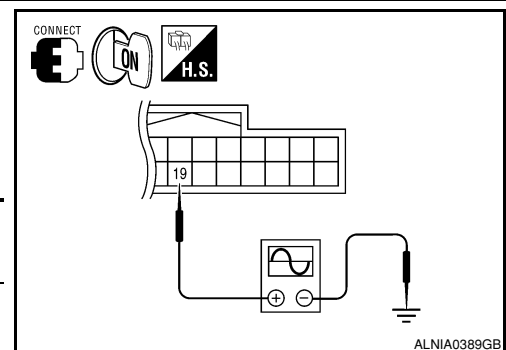

(+) Connector		(-)	Condition	Reference signal
Connector	Terminal			
M93	19	Ground	Receive audio signal	

Are voltage readings as specified?

YES >> Replace display unit. Refer to [AV-106, "Removal and Installation"](#)

NO >> Replace AV control unit. Refer to [AV-104, "Removal and Installation"](#)

# RGB AREA (YS) SIGNAL CIRCUIT

< COMPONENT DIAGNOSIS >

[BASE AUDIO]

## RGB AREA (YS) SIGNAL CIRCUIT

### Description

INFOID:000000001322717

Transmits the display area of RGB image displayed by AV control unit with RGB area (YS) signal to display unit.

### Diagnosis Procedure

INFOID:000000001322718

#### 1. CHECK CONTINUITY RGB AREA (YS) SIGNAL CIRCUIT

1. Turn ignition switch OFF.
2. Disconnect display unit connector M93 and AV control unit connector M44.
3. Check continuity between display unit harness connector M93 (A) terminal 9 and AV control unit harness connector M44 (B) terminal 43.

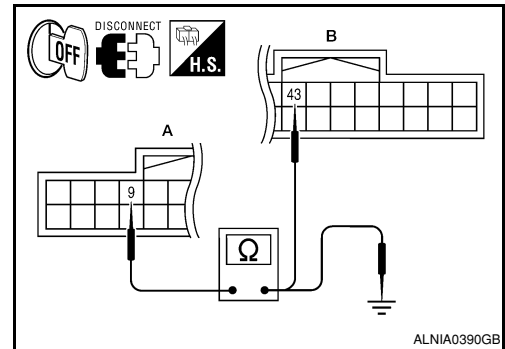

A		B		Continuity
Connector	Terminal	Connector	Terminal	
M93	9	M44	43	Yes

4. Check continuity between display unit harness connector M93 (A) terminal 9 and ground.

A		—	Continuity
Connector	Terminal		
M93	9	Ground	No

Are continuity results as specified?

YES >> GO TO 2.

NO >> Repair harness or connector.

#### 2. CHECK RGB SYNCHRONIZING SIGNAL

1. Connect display unit connector M93 and AV control unit connector M44.
2. Turn ignition switch ON.
3. Check signal between display unit harness connector M93 terminal 9 and ground.

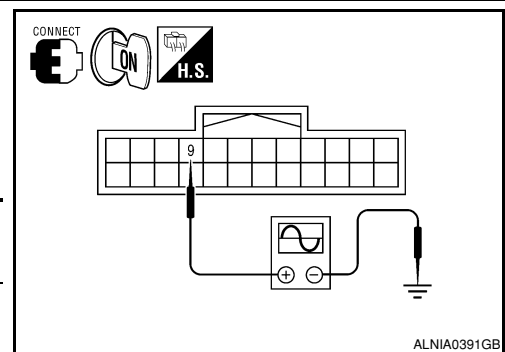

(+) Connector		(-)	Condition	Reference signal
Connector	Terminal			
M93	9	Ground	Receive audio signal	<p>PKIB4948J</p>

Are voltage readings as specified?

YES >> Replace display unit. Refer to [AV-106, "Removal and Installation"](#)

NO >> Replace AV control unit. Refer to [AV-104, "Removal and Installation"](#)

# HORIZONTAL SYNCHRONIZING (HP) SIGNAL CIRCUIT

< COMPONENT DIAGNOSIS >

[BASE AUDIO]

## HORIZONTAL SYNCHRONIZING (HP) SIGNAL CIRCUIT

### Description

INFOID:000000001322719

In composite image (AUX image, camera image), transmit the vertical synchronizing (VP) signal and horizontal synchronizing (HP) signal from display unit to AV control unit so as to synchronize the RGB images displayed with AV control unit such as the image quality adjusting menu, etc.

### Diagnosis Procedure

INFOID:000000001322720

#### 1. CHECK CONTINUITY HORIZONTAL SYNCHRONIZING (HP) SIGNAL CIRCUIT

1. Turn ignition switch OFF.
2. Disconnect display unit connector M93 and AV control unit connector M44.
3. Check continuity between display unit harness connector M93 (A) terminal 8 and AV control unit harness connector M44 (B) terminal 45.

A		B		Continuity
Connector	Terminal	Connector	Terminal	
M93	8	M44	45	Yes

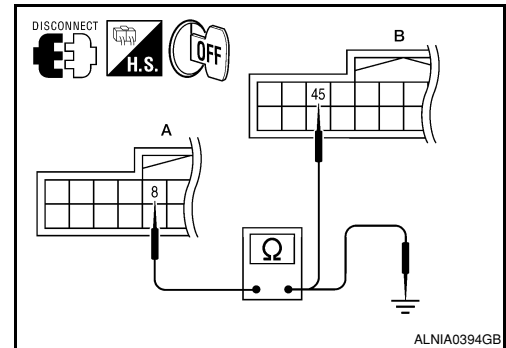

4. Check continuity between display unit harness connector M93 (A) terminal 8 and ground.

A		—	Continuity
Connector	Terminal		
M93	8	Ground	No

Are continuity results as specified?

YES >> GO TO 2.

NO >> Repair harness or connector.

#### 2. CHECK HORIZONTAL SYNCHRONIZING (HP) SIGNAL

1. Connect display unit connector M93 and AV control unit connector M44.
2. Turn ignition switch ON.
3. Check signal between display unit harness connector M93 terminal 8 and ground.

(+) Connector		(-)	Condition	Reference signal
Connector	Terminal			
M93	8	Ground	Receive audio signal	<p>SKIB3601E</p>

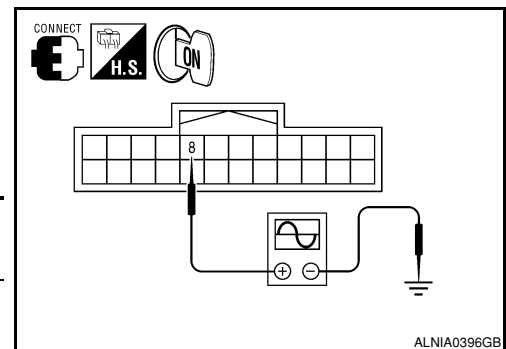

Are voltage readings as specified?

YES >> Replace AV control unit. Refer to [AV-104. "Removal and Installation"](#)

NO >> Replace display unit. Refer to [AV-106. "Removal and Installation"](#)

# VERTICAL SYNCHRONIZING (VP) SIGNAL CIRCUIT

< COMPONENT DIAGNOSIS >

[BASE AUDIO]

## VERTICAL SYNCHRONIZING (VP) SIGNAL CIRCUIT

### Description

INFOID:000000001322721

In composite image (AUX image, camera image), transmit the vertical synchronizing (VP) signal and horizontal synchronizing (HP) signal from display unit to AV control unit so as to synchronize the RGB images displayed with AV control unit such as the image quality adjusting menu, etc.

### Diagnosis Procedure

INFOID:000000001322722

#### 1. CHECK CONTINUITY VERTICAL SYNCHRONIZING (VP) SIGNAL CIRCUIT

1. Turn ignition switch OFF.
2. Disconnect display unit connector M93 and AV control unit connector M44.
3. Check continuity between display unit harness connector M93 (A) terminal 20 and AV control unit harness connector M44 (B) terminal 57.

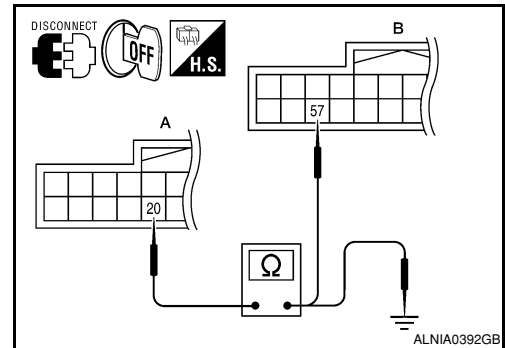

A		B		Continuity
Connector	Terminal	Connector	Terminal	
M93	20	M44	57	Yes

4. Check continuity between display unit harness connector M93 (A) terminal 20 and ground.

A		—	Continuity
Connector	Terminal		
M93	20	Ground	No

Are continuity results as specified?

YES >> GO TO 2.

NO >> Repair harness or connector.

#### 2. CHECK VERTICAL SYNCHRONIZING (VP) SIGNAL

1. Connect display unit connector M93 and AV control unit connector M44.
2. Turn ignition switch ON.
3. Check signal between display unit harness connector M93 terminal 20 and ground.

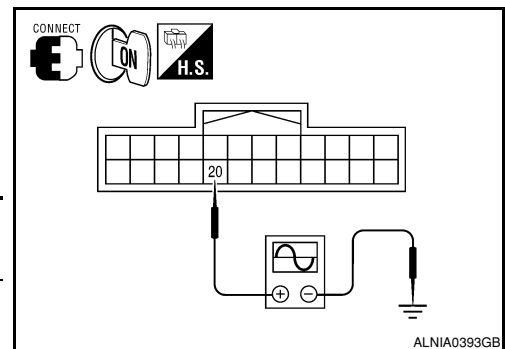

(+)		(-)	Condition	Reference signal
Connector	Terminal			
M93	20	Ground	Receive audio signal	

Are voltage readings as specified?

YES >> Replace AV control unit. Refer to [AV-104, "Removal and Installation"](#)

NO >> Replace display unit. Refer to [AV-106, "Removal and Installation"](#)

# FRONT DOOR SPEAKER

< COMPONENT DIAGNOSIS >

[BASE AUDIO]

## FRONT DOOR SPEAKER

### Description

INFOID:000000001297320

The AV control unit sends audio signals to the front door speakers using the front door speaker circuits.

### Diagnosis Procedure

INFOID:000000001297321

#### 1. HARNESS CHECK

1. Disconnect AV control unit connector M42 and suspect speaker connector.
2. Check continuity between AV control unit harness connector M42 (A) terminal and suspect speaker harness connector (B) terminal.

A		B		Continuity
Connector	Terminal	Connector	Terminal	
M42	2	D12	1	Yes
	3		2	
	11	D112	1	
	12		2	

3. Check continuity between AV control unit harness connector M42 (A) terminal and ground.

A		—	Continuity
Connector	Terminal		
M42	2	Ground	No
	3		
	11		
	12		

Are continuity results as specified?

YES >> GO TO 2

- NO >> • Check connector housings for disconnected or loose terminals.  
• Repair harness or connector.

#### 2. FRONT SPEAKER SIGNAL CHECK

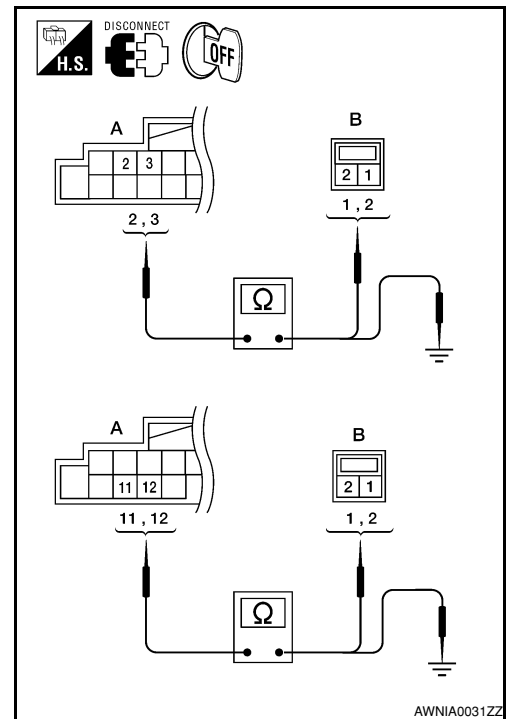

AWNIA0031ZZ



# FRONT DOOR SPEAKER

[BASE AUDIO]

## < COMPONENT DIAGNOSIS >

1. Connect AV control unit connector M42 and front speaker connector.
2. Turn ignition switch to ACC.
3. Push "POWER" switch.
4. Check the signal between AV control unit harness connector M42 terminals with CONSULT-III or oscilloscope.

(+)		(-)		Condi- tion	Reference signal
Con- nec- tor	Termi- nal	Con- nec- tor	Termi- nal		
M42	2	M42	3	Receive audio signal	
	11		12		

Is the audio signal voltage as specified?

- YES >> Replace speaker. Refer to [AV-108, "Removal and Installation"](#).
- NO >> Replace AV control unit. Refer to [AV-104, "Removal and Installation"](#).

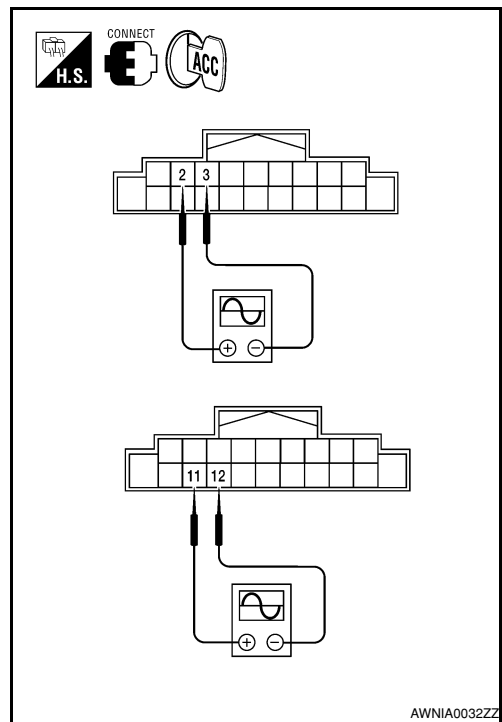

A  
B  
C  
D  
E  
F  
G  
H  
I  
J  
K  
L  
M  
O  
P

AV

# FRONT TWEETER

< COMPONENT DIAGNOSIS >

[BASE AUDIO]

## FRONT TWEETER

### Description

INFOID:000000001308825

The AV control unit sends audio signals to the front tweeters using the front tweeter circuits.

### Diagnosis Procedure

INFOID:000000001308826

#### 1. HARNESS CHECK

1. Disconnect AV control unit connector M42 and suspect front tweeter connector.
2. Check continuity between AV control unit harness connector M42 (A) and suspect front tweeter harness connector (B).

A		B		Continuity
Connector	Terminal	Connector	Terminal	
M42	2	M109	1	Yes
	3		2	
	11	M111	1	
	12		2	

3. Check continuity between AV control unit harness connector M42 (A) and ground.

A		—	Continuity
Connector	Terminal		
M42	2	Ground	No
	3		
	11		
	12		

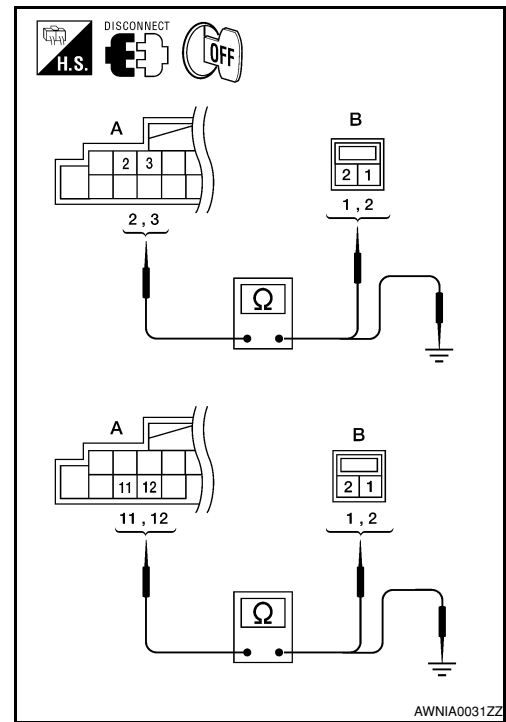

AWNIA0031ZZ

Are the continuity results as specified?

YES >> GO TO 2

- NO >> • Check connector housings for disconnected or loose terminals.  
• Repair harness or connector.

#### 2. FRONT TWEETER SIGNAL CHECK

# FRONT TWEETER

[BASE AUDIO]

## < COMPONENT DIAGNOSIS >

1. Connect AV control unit connector M42 and front tweeter connector.
2. Turn ignition switch to ACC.
3. Push "POWER" switch.
4. Check the signal between AV control unit harness connector M42 terminals with CONSULT-III or oscilloscope.

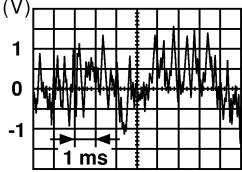
(+)		(-)		Condi- tion	Reference signal
Con- nec- tor	Termi- nal	Con- nec- tor	Termi- nal		
M42	2	M42	3	Receive audio signal	 <small>SKIA0177E</small>
	11		12		

Is the audio signal voltage as specified?

- YES >> Replace the suspect front tweeter. Refer to [AV-108, "Removal and Installation"](#).
- NO >> Replace AV control unit. Refer to [AV-104, "Removal and Installation"](#).

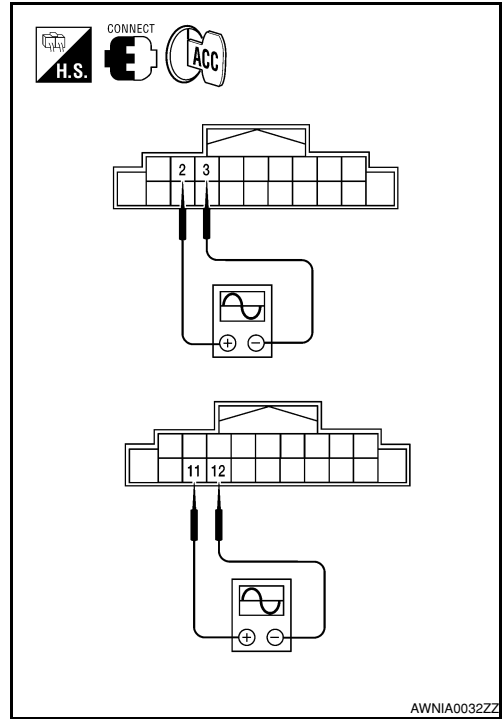

A  
B  
C  
D  
E  
F  
G  
H  
I  
J  
K  
L  
M  
O  
P

AV

# REAR DOOR SPEAKER

< COMPONENT DIAGNOSIS >

[BASE AUDIO]

## REAR DOOR SPEAKER

### Description

INFOID:000000001297324

The AV control unit sends audio signals to the rear speakers using the rear speaker circuits.

### Diagnosis Procedure

INFOID:000000001297325

#### 1. HARNESS CHECK

1. Disconnect AV control unit connector M42 and suspect rear speaker connector.
2. Check continuity between AV control unit harness connector M42 (A) and suspect rear speaker harness connector (B).

A		B		Continuity
Connector	Terminal	Connector	Terminal	
M42	4	D207	1	Yes
	5		2	
	13	D307	1	
	14		2	

3. Check continuity between AV control unit harness connector M42 (A) and ground.

A		—	Continuity
Connector	Terminal		
M42	4	Ground	No
	5		
	13		
	14		

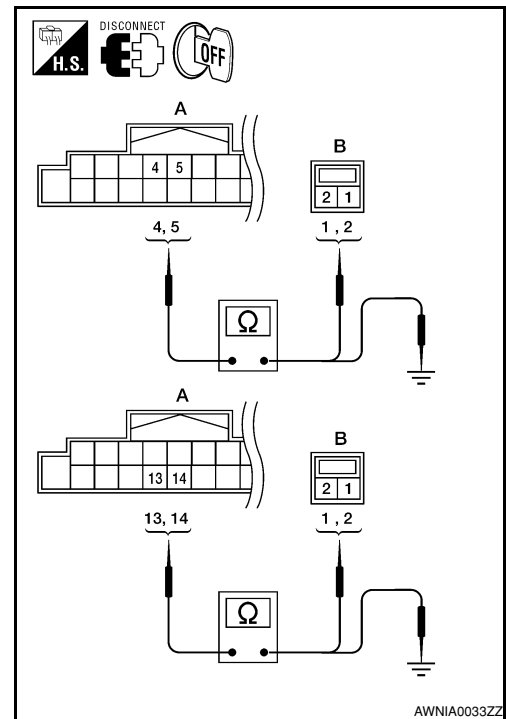

AWNIA0033ZZ

Are the continuity results as specified?

YES >> GO TO 2

- NO >> • Check connector housings for disconnected or loose terminals.  
• Repair harness or connector.

#### 2. REAR SPEAKER SIGNAL CHECK

# REAR DOOR SPEAKER

[BASE AUDIO]

## < COMPONENT DIAGNOSIS >

1. Connect AV control unit connector and rear speaker connector.
2. Turn ignition switch to ACC.
3. Push "POWER" switch.
4. Check the signal between AV control unit harness connector M42 terminals with CONSULT-III or oscilloscope.

Terminals				Condi- tion	Reference signal
(+)		(-)			
Con- nector	Termi- nal	Con- nector	Terminal		
M42	4	M42	5	Receive audio signal	
	13		14		

SKIA0177E

Is the audio signal voltage as specified?

- YES >> Replace the suspect rear door speaker. Refer to [AV-109, "Removal and Installation"](#).
- NO >> Replace AV control unit. Refer to [AV-104, "Removal and Installation"](#).

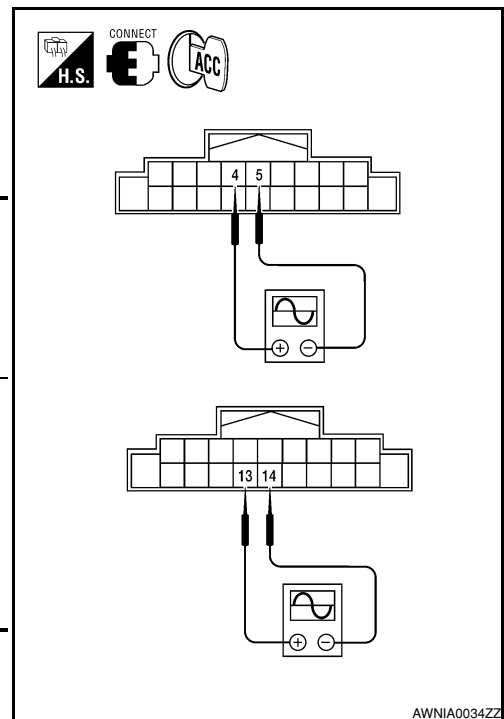

A  
B  
C  
D  
E  
F  
G  
H  
I  
J  
K  
L  
M  
N  
O  
P

AV

# REAR TWEETER

< COMPONENT DIAGNOSIS >

[BASE AUDIO]

## REAR TWEETER

### Description

INFOID:000000001297322

The AV control unit sends audio signals to the rear tweeters using the rear tweeter circuits.

### Diagnosis Procedure

INFOID:000000001297323

#### 1. HARNESS CHECK

1. Disconnect AV control unit connector M42 and suspect rear tweeter connector.
2. Check continuity between AV control unit harness connector M42 (A) and suspect rear tweeter harness connector (B).

A		B		Continuity
Connector	Terminal	Connector	Terminal	
M42	4	D208	1	Yes
	5		2	
	13	D308	1	
	14		2	

3. Check continuity between AV control unit harness connector M42 (A) and ground.

A		—	Continuity
Connector	Terminal		
M42	4	Ground	No
	5		
	13		
	14		

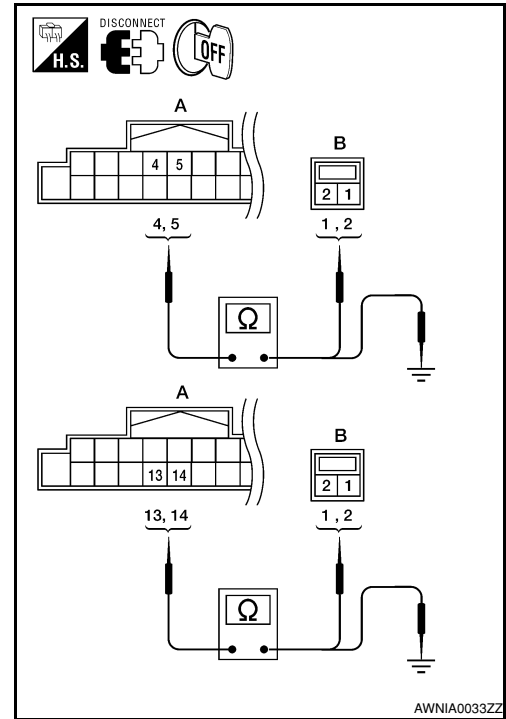

AWNIA0033ZZ

Are the continuity results as specified?

YES >> GO TO 2

- NO >> • Check connector housings for disconnected or loose terminals.  
• Repair harness or connector.

#### 2. REAR TWEETER SIGNAL CHECK

# REAR TWEETER

[BASE AUDIO]

## < COMPONENT DIAGNOSIS >

1. Connect AV control unit connector and rear tweeter connector.
2. Turn ignition switch to ACC.
3. Push "POWER" switch.
4. Check the signal between AV control unit harness connector M42 terminals with CONSULT-III or oscilloscope.

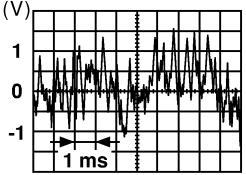
(+)		(-)		Condi- tion	Reference signal
Con- nec- tor	Termi- nal	Con- nec- tor	Termi- nal		
M42	4	M42	5	Receive audio signal	 <small>SKIA0177E</small>
	13		14		

Is the audio signal voltage as specified?

- YES >> Replace suspect rear tweeter. Refer to [AV-108, "Removal and Installation"](#).
- NO >> Replace AV control unit. Refer to [AV-104, "Removal and Installation"](#).

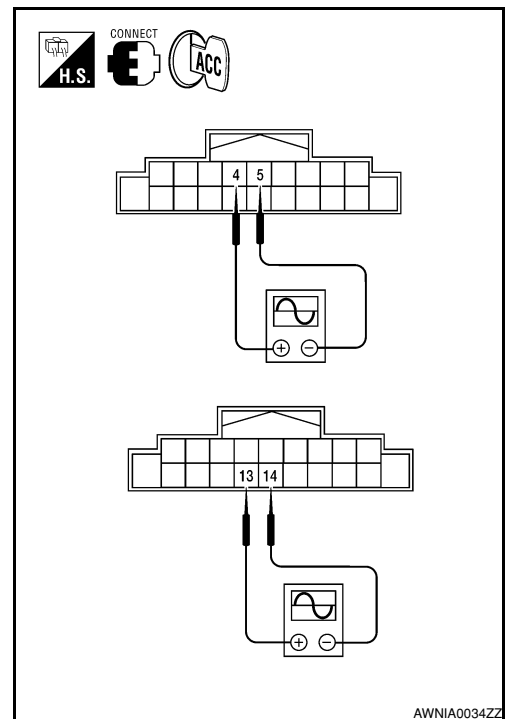

A  
B  
C  
D  
E  
F  
G  
H  
I  
J  
K  
L  
M  
AV  
O  
P

## STEERING SWITCH

### Description

INFOID:000000001297326

When one of the steering wheel AV control switches is pushed, the resistance in the steering wheel AV control switch circuit changes depending on which button is pushed.

### Diagnosis Procedure

INFOID:000000001297327

#### 1. CHECK STEERING WHEEL AUDIO CONTROL SWITCH RESISTANCE

1. Disconnect steering wheel audio control switch connector M102.
2. Check resistance between steering switch connector terminals.

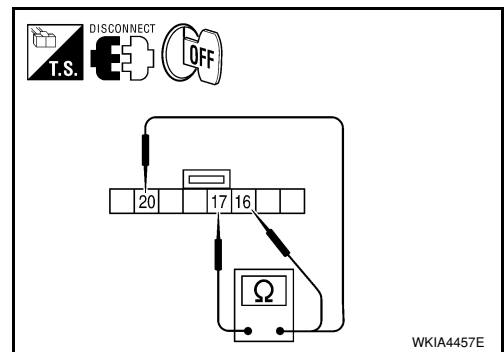

Terminal	Signal name	Condition	Resistance (Ω) (Approx.)	
16	17	Seek (down)	Depress ▽ switch.	165
		Volume (down)	Depress VOL down switch.	487
		Power	Depress PWR switch.	0
20	17	Seek (up)	Depress △ switch.	165
		Volume (up)	Depress VOL up switch.	487
		Mode	Depress MODE switch.	0

Do the steering wheel audio control switches check OK?

YES >> GO TO 2

NO >> Replace steering wheel audio control switch. Refer to [AV-110, "Removal and Installation"](#).

#### 2. CHECK HARNESS

1. Turn ignition switch OFF.
2. Disconnect AV control unit connector M42 and spiral cable connector M30.
3. Check continuity between AV control unit harness connector M42 (A) and spiral cable harness connector M30 (B).

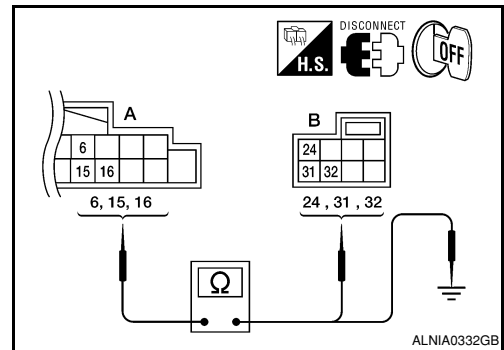

A		B		Continuity
Connector	Terminal	Connector	Terminal	
M42	6	M30	24	Yes
	15		31	
	16		32	

4. Check continuity between AV control unit connector M42 (A) and ground.

A		—	Continuity
Connector	Terminal		
M42	6	Ground	No
	15		
	16		

Are the continuity results as specified?

YES >> GO TO 3

NO >> Repair harness.

#### 3. SPIRAL CABLE CHECK



# STEERING SWITCH

[BASE AUDIO]

## < COMPONENT DIAGNOSIS >

1. Disconnect spiral cable connector M102.
2. Check continuity between spiral cable harness connector M30 (A) and M102 (B).

Spiral cable				Continuity
Connector	Terminal	Connector	Terminal	
M30	24	M102	20	Yes
	31		17	
	32		16	

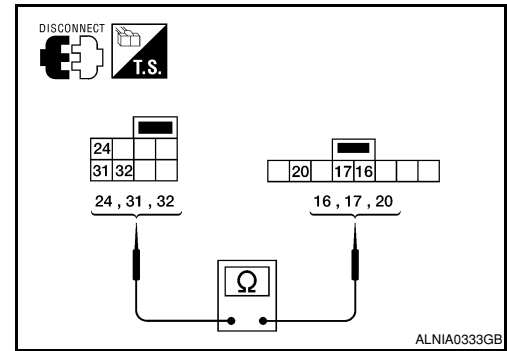

Does the spiral cable check OK?

- YES >> Inspection End.  
 NO >> Replace spiral cable. Refer to [SR-6. "Removal and Installation"](#).

A  
B  
C  
D  
E  
F  
G  
H  
I  
J  
K  
L  
M

AV

O  
P

# COMMUNICATION SIGNAL CIRCUIT

< COMPONENT DIAGNOSIS >

[BASE AUDIO]

## COMMUNICATION SIGNAL CIRCUIT SATELLITE RADIO TUNER

### SATELLITE RADIO TUNER : Description

INFOID:000000001297328

Communication signals are exchanged between the AV control unit and satellite radio tuner using the communication circuits.

### SATELLITE RADIO TUNER : Diagnosis Procedure

INFOID:000000001297329

#### 1. CHECK HARNESS - 1

1. Turn ignition switch OFF.
2. Disconnect satellite radio tuner (factory installed) connector M41 and AV control unit connector M43.
3. Check continuity between satellite radio tuner (factory installed) harness connector M41 (A) terminal 28 and AV control unit harness connector M43 (B) terminal 28.

A		B		Continuity
Connector	Terminal	Connector	Terminal	
M41	28	M43	28	Yes

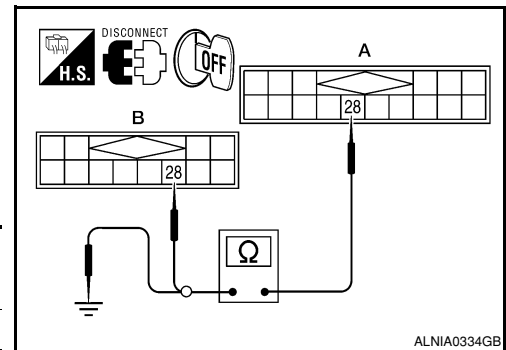

4. Check continuity between satellite radio tuner (factory installed) harness connector M41 (A) terminal 28 and ground.

A		—	Continuity
Connector	Terminal		
M41	28	Ground	No

Are continuity results as specified?

- YES >> GO TO 2  
NO >> Repair harness or connector.

#### 2. CHECK HARNESS - 2

1. Check continuity between satellite radio tuner (factory installed) harness connector M41 (A) terminal 29 and AV control unit harness connector M43 (B) terminal 29.

A		B		Continuity
Connector	Terminal	Connector	Terminal	
M41	29	M43	29	Yes

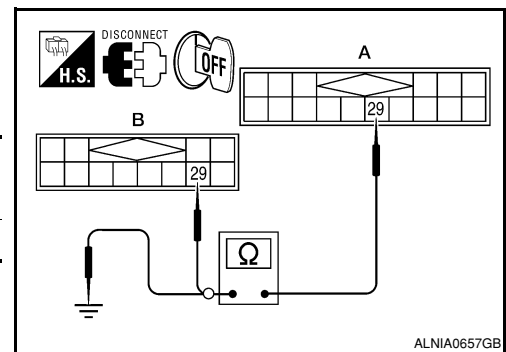

2. Check continuity between satellite radio tuner (factory installed) harness connector M41 (A) terminal 29 and ground.

A		—	Continuity
Connector	Terminal		
M41	29	Ground	No

Are continuity results as specified?

- YES >> GO TO 3  
NO >> Repair harness or connector.

#### 3. CHECK HARNESS - 3

# COMMUNICATION SIGNAL CIRCUIT

## < COMPONENT DIAGNOSIS >

[BASE AUDIO]

1. Check continuity between satellite radio tuner (factory installed) harness connector M41 (A) terminal 30 and AV control unit harness connector M43 (B) terminal 30.

A		B		Continuity
Connector	Terminal	Connector	Terminal	
M41	30	M43	30	Yes

2. Check continuity between satellite radio tuner (factory installed) harness connector M41 (A) terminal 30 and ground.

A		—	Continuity
Connector	Terminal		
M41	30	Ground	No

Are continuity results as specified?

YES >> GO TO 4

NO >> Repair harness or connector.

### 4. CHECK REQ1 SIGNAL

1. Connect satellite radio tuner (factory installed) connector and AV control unit connector.
2. Turn ignition switch to ACC
3. Check signal between satellite radio tuner (factory installed) harness connector M41 terminal 28 and ground with CONSULT-III or oscilloscope.

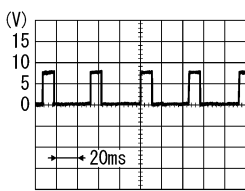
(+)		(-)	Reference signal
Connector	Terminal		
M41	28	Ground	 <p>SKIB3825E</p>

Are voltage readings as specified?

YES >> GO TO 5

NO >> Replace AV control unit. Refer to [AV-104, "Removal and Installation"](#).

### 5. CHECK TXD SIGNAL

Check signal between satellite radio tuner (factory installed) harness connector M41 terminal 29 and ground with CONSULT-III or oscilloscope.

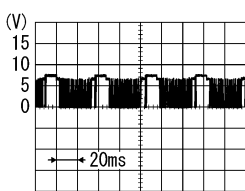
(+)		(-)	Reference signal
Connector	Terminal		
M41	29	Ground	 <p>SKIB3824E</p>

Are the voltage readings as specified?

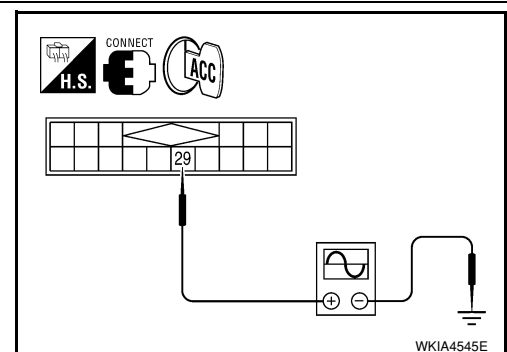
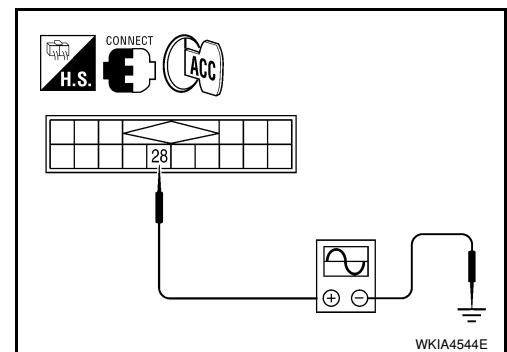
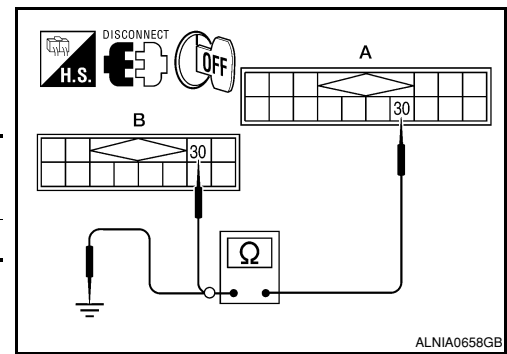

A  
B  
C  
D  
E  
F  
G  
H  
I  
J  
K  
L  
M  
O  
P

AV

# COMMUNICATION SIGNAL CIRCUIT

[BASE AUDIO]

## < COMPONENT DIAGNOSIS >

- YES >> GO TO 6
- NO >> Replace satellite radio tuner.

### 6. CHECK RXD SIGNAL

Check signal between satellite radio tuner (factory installed) harness connector M41 terminal 30 and ground with CONSULT-III or oscilloscope.

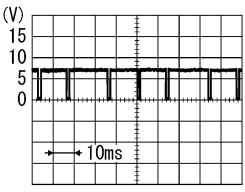
(+)		(-)	Reference signal
Connector	Terminal		
M41	30	Ground	 <p style="text-align: right; font-size: small;">SKIB3826E</p>

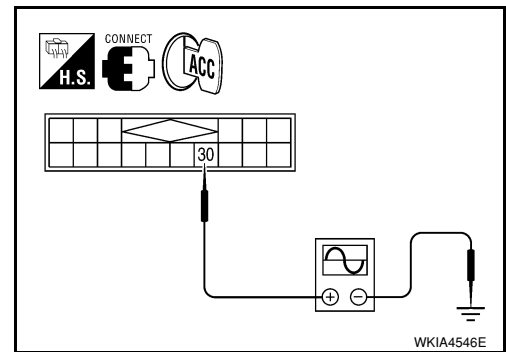

Are the voltage readings as specified?

- YES >> Replace satellite radio tuner.
- NO >> Replace AV control unit. Refer to [AV-104. "Removal and Installation"](#).

# SOUND SIGNAL CIRCUIT

< COMPONENT DIAGNOSIS >

[BASE AUDIO]

## SOUND SIGNAL CIRCUIT SATELLITE RADIO TUNER

### SATELLITE RADIO TUNER : Description

INFOID:000000001297330

Left and right channel audio signals are supplied from the satellite radio tuner to the AV control unit through the sound signal circuits.

### SATELLITE RADIO TUNER : Diagnosis Procedure

INFOID:000000001297331

#### LEFT CHANNEL

#### 1.CHECK HARNESS

1. Turn ignition switch OFF.
2. Disconnect satellite radio tuner (factory installed) connector M41 and AV control unit connector M43.
3. Check continuity between satellite radio tuner (factory installed) connector M41 (A) and AV control unit connector M43 (B).

A		B		Continuity
Connector	Terminal	Connector	Terminal	
M41	21	M43	21	Yes
	22		22	

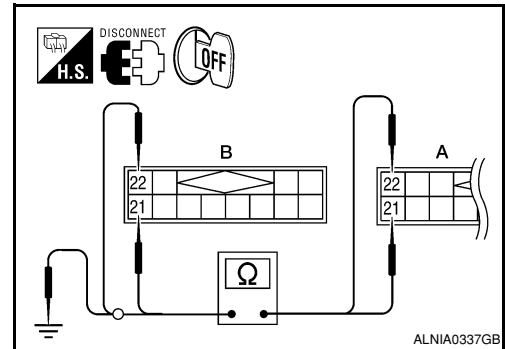

4. Check continuity between satellite radio tuner (factory installed) connector M41 (A) and ground.

A		—	Continuity
Connector	Terminal		
M41	21	Ground	No
	22		

Are continuity results as specified?

- YES >> GO TO 2  
NO >> Repair harness or connector.

#### 2.CHECK LEFT CHANNEL AUDIO SIGNAL

1. Connect satellite radio tuner (factory installed) and AV control unit.
2. Turn ignition switch ON.
3. Check signal between satellite radio tuner (factory installed) connector M41 terminals 21 and 22 with CONSULT-III or oscilloscope.

(+) Terminal		(-)	Reference signal
Connector	Terminal		
M41	21	Ground	<p>The oscilloscope shows a complex waveform between terminals 21 and 22 of connector M41. The vertical axis is labeled (V) with markings at 1, 0, and -1. The horizontal axis is labeled with a 2ms scale bar. The waveform oscillates between approximately 1V and -1V.</p>
	22		

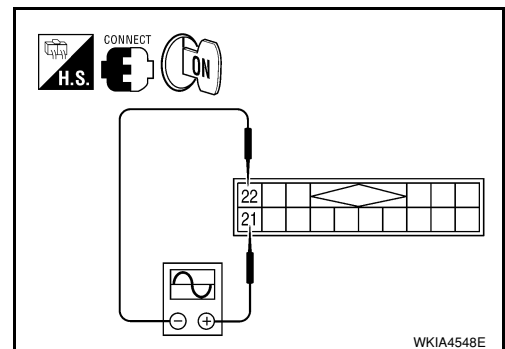

Are voltage readings as specified?

- YES >> Replace AV control unit. Refer to [AV-104. "Removal and Installation"](#).  
NO >> Replace satellite radio tuner. Refer to [AV-117. "Removal and Installation"](#).

#### RIGHT CHANNEL

# SOUND SIGNAL CIRCUIT

< COMPONENT DIAGNOSIS >

[BASE AUDIO]

## 1. CHECK HARNESS

1. Turn ignition switch OFF.
2. Disconnect satellite radio tuner (factory installed) connector M41 and AV control unit connector M43.
3. Check continuity between satellite radio tuner (factory installed) M41 (A) and AV control unit M43 (B).

A		B		Continuity
Connector	Terminal	Connector	Terminal	
M41	23	M43	23	Yes
	24		24	

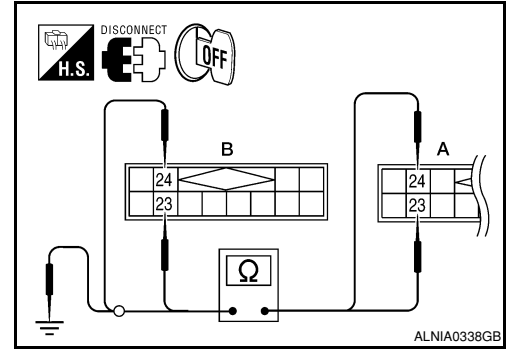

4. Check continuity between satellite radio tuner (factory installed) connector M41 (A) and ground.

A		—	Continuity
Connector	Terminal		
M41	23	Ground	No
	24		

Are continuity results as specified?

YES >> GO TO 2

NO >> Repair harness or connector.

## 2. CHECK RIGHT CHANNEL AUDIO SIGNAL

1. Connect satellite radio tuner (factory installed) and AV control unit.
2. Turn ignition switch ON.
3. Check signal between satellite radio tuner (factory installed) connector M41 terminals 23 and 24 with CONSULT-III or oscilloscope.

(+) Connector		Terminal	(-)	Reference signal
M41	23			

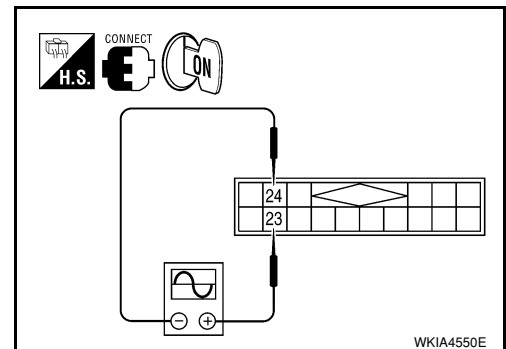

Are voltage readings as specified?

YES >> Replace AV control unit. Refer to [AV-104. "Removal and Installation"](#).

NO >> Replace satellite radio tuner. Refer to [AV-117. "Removal and Installation"](#).

# AV CONTROL UNIT

< ECU DIAGNOSIS >

[BASE AUDIO]

## ECU DIAGNOSIS

### AV CONTROL UNIT

#### Reference Value

INFOID:000000001316562

#### VALUES ON THE DIAGNOSIS TOOL

CONSULT-III data monitor item

Display Item	Display	Vehicle status	Remarks
VHCL SPD SIG	ON	Vehicle speed >0 km/h (0 MPH)	Changes in indication may be delayed. This is normal.
	OFF	Vehicle speed =0 km/h (0 MPH)	
PKB SIG	ON	Parking brake is applied.	Changes in indication may be delayed. This is normal.
	OFF	Parking brake is released.	
ILLUM SIG	ON	Block the light beam from the auto light optical sensor when the light SW is ON .	—
	OFF	Expose the auto light optical sensor to light when the light SW is OFF or ON.	
IGN SIG	ON	Ignition switch ON	—
	OFF	Ignition switch in ACC position	
REV SIG	ON	Selector lever in R position	Changes in indication may be delayed. This is normal.
	OFF	Selector lever in any position other than R	

#### TERMINAL LAYOUT

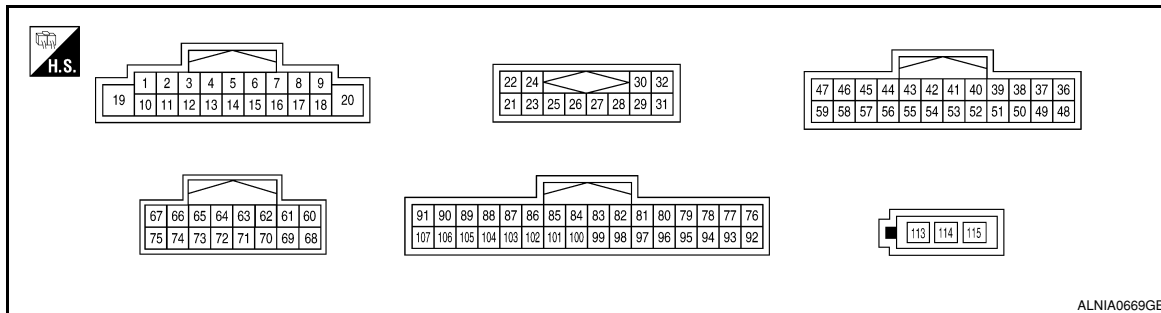

#### PHYSICAL VALUES

A  
B  
C  
D  
E  
F  
G  
H  
I  
J  
K  
L  
M  
O  
P

AV

# AV CONTROL UNIT

< ECU DIAGNOSIS >

[BASE AUDIO]

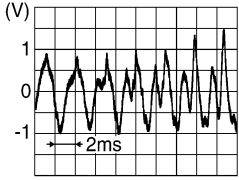
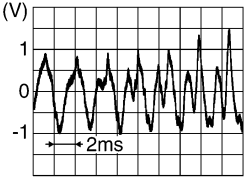
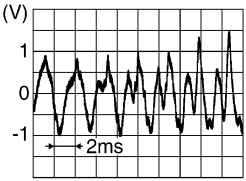
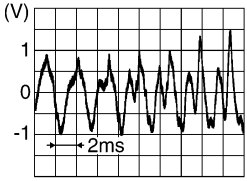
Terminal (Wire color)		Description		Condition		Reference value (Approx.)
+	-	Signal name	Input/ Output			
2 (L/W)	3 (L/R)	Sound signal front door speaker and front tweeter LH	Output	Ignition switch ON	Audio output	 <p style="text-align: right; font-size: small;">SKIB3609E</p>
4 (SB)	5 (B/Y)	Sound signal rear door speaker and rear tweeter LH	Output	Ignition switch ON	Audio output	 <p style="text-align: right; font-size: small;">SKIB3609E</p>
6 (Y)	15	Steering switch signal A	Input	Ignition switch ON	Press and hold MODE switch.	0V
					Press and hold Δ switch.	0.75V
					Press and hold VOL up switch	2V
					Except for above.	5V
7 (V)	Ground	ACC power supply	Input	Ignition switch ACC	—	Battery voltage
9 (R/L)	Ground	Illumination signal	Input	OFF	Lighting switch is OFF.	0V
					Lighting switch is ON.	12V
11 (W/B)	12 (L/B)	Sound signal front door speaker and front tweeter RH	Output	Ignition switch ON	Voice output	 <p style="text-align: right; font-size: small;">SKIB3609E</p>
13 (O/L)	14 (R/L)	Sound signal rear door speaker and rear tweeter RH	Output	Ignition switch ON	Voice output	 <p style="text-align: right; font-size: small;">SKIB3609E</p>
15	Ground	Steering switch signal GND	—	Ignition switch ON	—	0V



# AV CONTROL UNIT

< ECU DIAGNOSIS >

[BASE AUDIO]

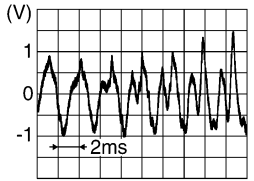
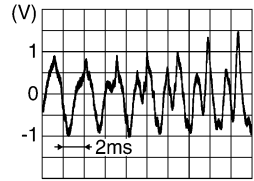
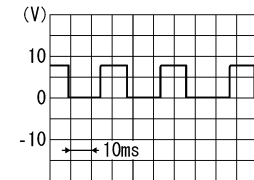
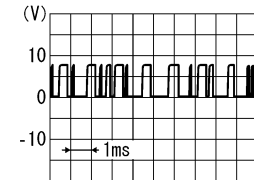
Terminal (Wire color)		Description		Condition		Reference value (Approx.)
+	-	Signal name	Input/ Output			
16 (G)	15	Steering switch signal B	Input	Ignition switch ON	Press and hold POWER switch	0V
					Press and hold ∇ switch	0.75V
					Press and hold VOL down switch	2V
					Except for above	5V
19 (Y)	Ground	Battery power supply	Input	Ignition switch OFF	—	Battery voltage
20 (B)	Ground	Ground	—	Ignition switch ON	—	0V
22 (W)	21 (B)	Satellite radio sound signal LH	Input	Ignition switch ON	When satellite radio mode is selected	 <p style="text-align: right; font-size: small;">SKIB3609E</p>
24 (Y)	23 (BR)	Satellite radio sound signal RH	Input	Ignition switch ON	When satellite radio mode is selected	 <p style="text-align: right; font-size: small;">SKIB3609E</p>
25	—	Shield	—	—	—	—
26	Ground	Data ground	—	Ignition switch ON	When satellite radio mode is selected	0V
28 (W)	Ground	Request signal (SAT→CONT)	Input	Ignition switch ON	When satellite radio mode is selected	 <p style="text-align: right; font-size: small;">SKIA9299J</p>
29 (R)	Ground	Communication signal (SAT→CONT)	Input	Ignition switch ON	When satellite radio mode is selected	 <p style="text-align: right; font-size: small;">SKIA9300J</p>

A  
B  
C  
D  
E  
F  
G  
H  
I  
J  
K  
L  
M  
O  
P

AV

# AV CONTROL UNIT

< ECU DIAGNOSIS >

[BASE AUDIO]

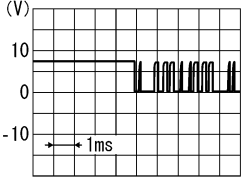
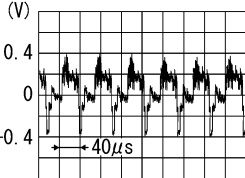
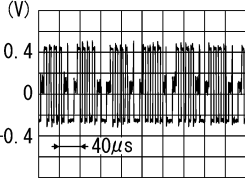
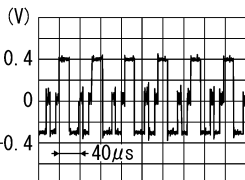
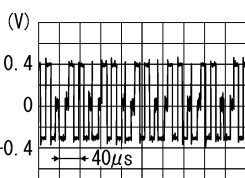
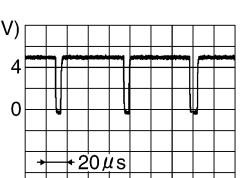
Terminal (Wire color)		Description		Condition		Reference value (Approx.)
+	-	Signal name	Input/ Output			
30 (B)	Ground	Communication signal (CONT→SAT)	Output	Ignition switch ON	When satellite radio mode is selected	 <p style="text-align: right; font-size: small;">SKIA9301J</p>
36 (W)	Ground	AUX image signal	Output	Ignition switch ON	When AUX mode is select- ed	 <p style="text-align: right; font-size: small;">SKIB2251J</p>
37 (B)	Ground	AUX image ground	—	Ignition switch ON	—	0V
38 (R)	Ground	RGB signal (B: blue)	Output	Ignition switch ON	Start confirmation/adjust- ment mode, and then dis- play color bar by selecting “Color Spectrum Bar” on DISPLAY DIAGNOSIS screen.	 <p style="text-align: right; font-size: small;">SKIB2237J</p>
39 (B)	Ground	RGB signal (G: green)	Output	Ignition switch ON	Start confirmation/adjust- ment mode, and then dis- play color bar by selecting “Color Spectrum Bar” on DISPLAY DIAGNOSIS screen.	 <p style="text-align: right; font-size: small;">SKIB2236J</p>
40 (W)	Ground	RGB signal (R: red)	Output	Ignition switch ON	Start confirmation/adjust- ment mode, and then dis- play color bar by selecting “Color Spectrum Bar” on DISPLAY DIAGNOSIS screen.	 <p style="text-align: right; font-size: small;">SKIB2238J</p>
41 (W)	Ground	RGB synchronizing signal	Output	Ignition switch ON	—	 <p style="text-align: right; font-size: small;">SKIB3603E</p>
42	—	RGB synchronizing ground	—	Ignition switch ON	—	0V

# AV CONTROL UNIT

< ECU DIAGNOSIS >

[BASE AUDIO]

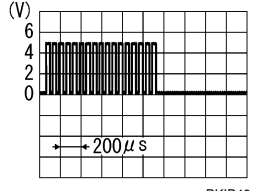
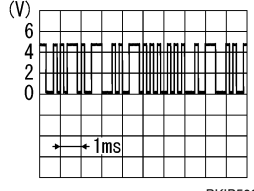
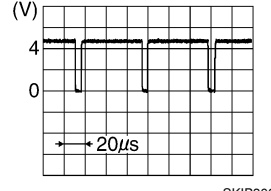
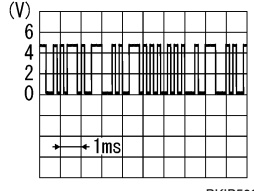
Terminal (Wire color)		Description		Condition	Reference value (Approx.)	
+	-	Signal name	Input/ Output			
43 (O)	Ground	RGB area (YS) signal	Output	Ignition switch ON	5V	
				Ignition switch ON	 <p style="text-align: right; font-size: small;">PKIB4948J</p>	
44 (LG)	Ground	Communication signal (DISP→CONT)	Input	Ignition switch ON	When adjusting display-brightness	 <p style="text-align: right; font-size: small;">PKIB5039J</p>
45 (W/L)	Ground	Horizontal synchronizing (HP) signal	Input	Ignition switch ON	—	 <p style="text-align: right; font-size: small;">SKIB3601E</p>
46 (G/O)	Ground	Signal ground	—	Ignition switch	—	0V
47 (B/O)	Ground	Signal VCC	Output	Ignition switch ACC	—	9V
48 (R)	Ground	Composite out synchronizing signal GND	—	Ignition switch ON	—	0V
49	—	Shield	—	—	—	—
50	Ground	RGB ground	—	Ignition switch ON	—	0V
54 (B)	Ground	Ground	—	Ignition switch ON	—	0V
55	—	Shield	—	—	—	—
56 (V)	Ground	Communication signal (CONT→DISP)	Output	Ignition switch ON	When adjusting display-brightness	 <p style="text-align: right; font-size: small;">PKIB5039J</p>

A  
B  
C  
D  
E  
F  
G  
H  
I  
J  
K  
L  
M  
O  
P

AV

# AV CONTROL UNIT

< ECU DIAGNOSIS >

[BASE AUDIO]

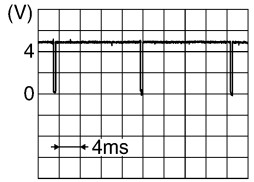
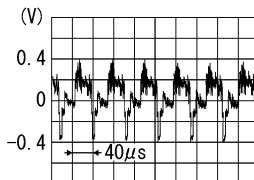
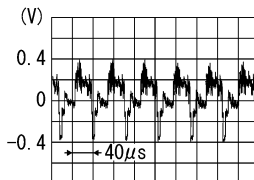
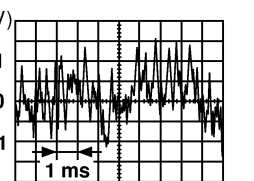
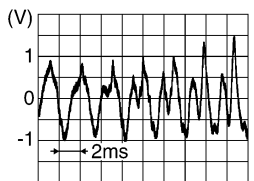
Terminal (Wire color)		Description		Condition		Reference value (Approx.)
+	-	Signal name	Input/ Output			
57 (O/L)	Ground	Vertical synchronizing (VP) signal	Input	Ignition switch ON	—	 <p style="text-align: right; font-size: small;">SKIB3598E</p>
58 (B)	Ground	Inverter ground	—	Ignition switch ON	—	0V
59 (BR/Y)	Ground	Inverter VCC	Output	Ignition switch ACC	—	9V
64 (BR)	Ground	Rear view camera video signal ground	—	Ignition switch ON	—	0V
65 (W)	Ground	Rear view camera video in (+)	Input	Ignition switch ON	With rear view camera ON	 <p style="text-align: right; font-size: small;">SKIB2251J</p>
66 (B/W)	Ground	DVD player video signal (+)	Input	Ignition switch ON	With DVD player operating	 <p style="text-align: right; font-size: small;">SKIB2251J</p>
72	—	Shield	—	—	—	—
74 (L)	Ground	DVD player video ground	—	Ignition switch ON	—	0V
77 (W/L)	76 (O)	Headphone RH audio signal	Output	Ignition switch ON	With DVD player operating	 <p style="text-align: right; font-size: small;">SKIA0177E</p>
83 (R)	82 (G)	DVD player audio signal RH	Input	Ignition switch ON	With DVD player operating	 <p style="text-align: right; font-size: small;">SKIB3609E</p>

# AV CONTROL UNIT

< ECU DIAGNOSIS >

[BASE AUDIO]

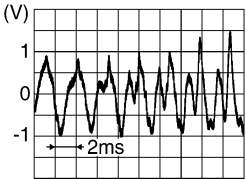
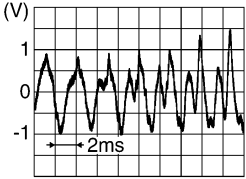
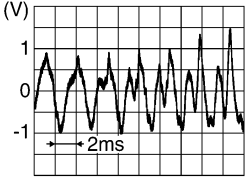
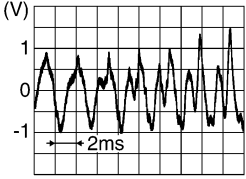
Terminal (Wire color)		Description		Condition		Reference value (Approx.)
+	-	Signal name	Input/ Output			
85 (B)	Ground	Ground	—	Ignition switch ON	—	0V
86 (L)	—	CAN-H	Input/ Output	—	—	—
87 (P)	—	CAN-L	Input/ Output	—	—	—
88 (W/L)	—	AV communication signal 1 (H)	Input/ Output	—	—	—
89 (P/B)	—	AV communication signal 1 (L)	Input/ Output	—	—	—
90 (W/L)	—	AV communication signal 2 (H)	Input/ Output	—	—	—
91 (P/B)	—	AV communication signal 2 (L)	Input/ Output	—	—	—
93 (O/L)	92 (W)	Headphone LH audio sig- nal	Output	Ignition switch ON	With DVD player operating	 <small>SKIB3609E</small>
94	—	Shield	—	—	—	—
95 (B)	97 (R)	AUX audio signal RH	Input	Ignition switch ON	When AUX mode is select- ed	 <small>SKIB3609E</small>
96 (W)	97 (R)	AUX audio signal LH	Input	Ignition switch ON	When AUX mode is select- ed	 <small>SKIB3609E</small>
98 (B)	99 (W)	DVD player audio signal LH	Input	Ignition switch ON	With DVD player operating	 <small>SKIB3609E</small>
101 (BR)	Ground	A/C and AV switch assem- bly ground	—	Ignition switch ON	—	0V
103 (SB)	Ground	CD eject signal	Input	—	Pressing the eject switch	0V
					Except for above	3.3V

A  
B  
C  
D  
E  
F  
G  
H  
I  
J  
K  
L  
M  
O  
P

AV

# AV CONTROL UNIT

< ECU DIAGNOSIS >

[BASE AUDIO]

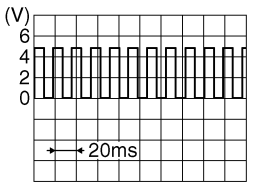
Terminal (Wire color)		Description		Condition		Reference value (Approx.)
+	-	Signal name	Input/ Output			
104 (G/R)	Ground	Ignition signal	Input	Ignition switch ON	—	Battery voltage
106 (GR/R)	Ground	Parking brake signal	Input	Ignition switch ON	Parking brake ON	0V
					Parking brake OFF	12V
107 (R)	Ground	Vehicle speed signal (8-pulse)	Input	Ignition switch ON	When vehicle speed is ap- prox. 40 km/h (25MPH)	 <p style="text-align: right; font-size: small;">SKIA6649J</p>

Wiring Diagram

INFOID:000000001316563

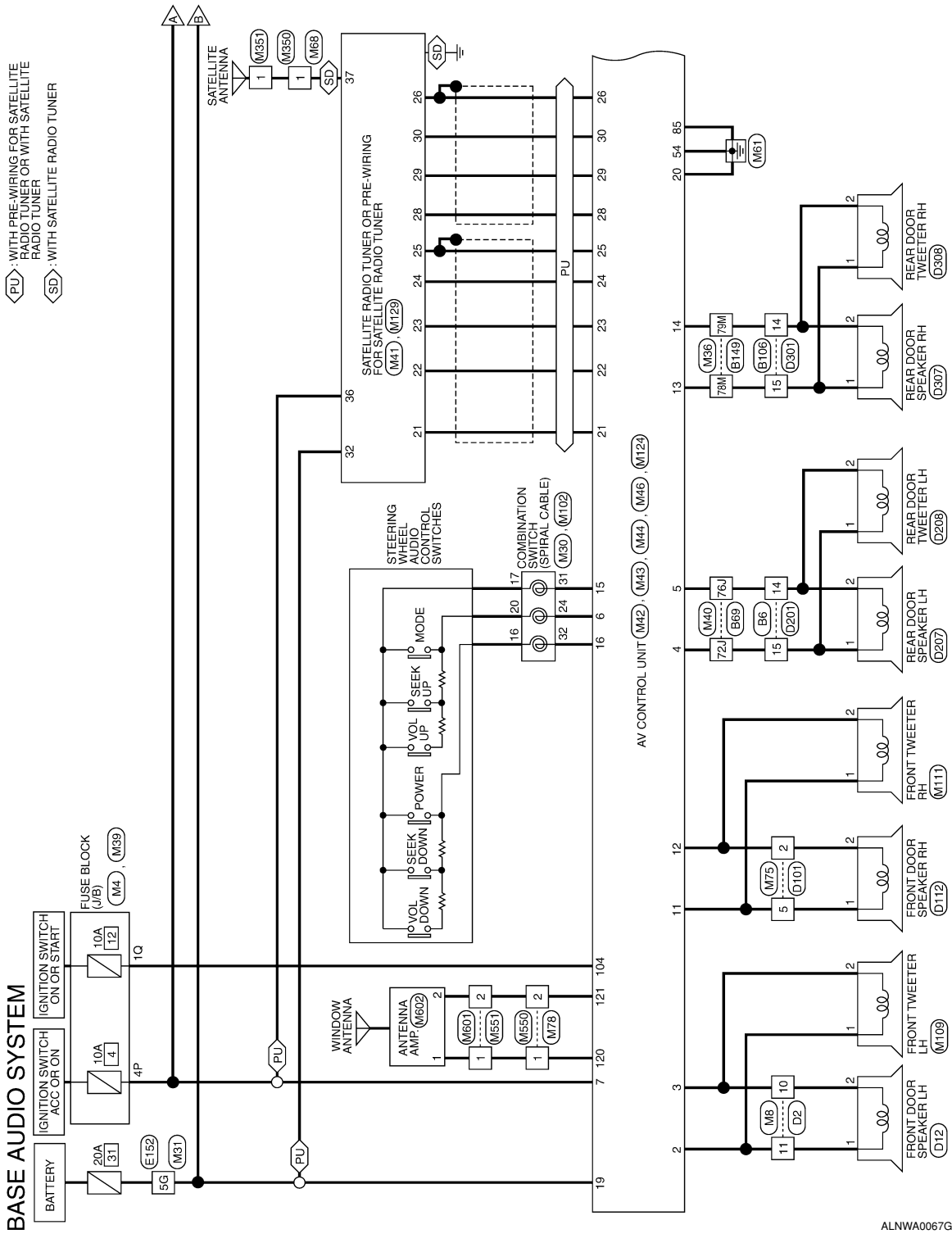

ALNWA0067GE

A  
B  
C  
D  
E  
F  
G  
H  
I  
J  
K  
L  
M  
N  
O  
P

AV

# AV CONTROL UNIT

< ECU DIAGNOSIS >

[BASE AUDIO]

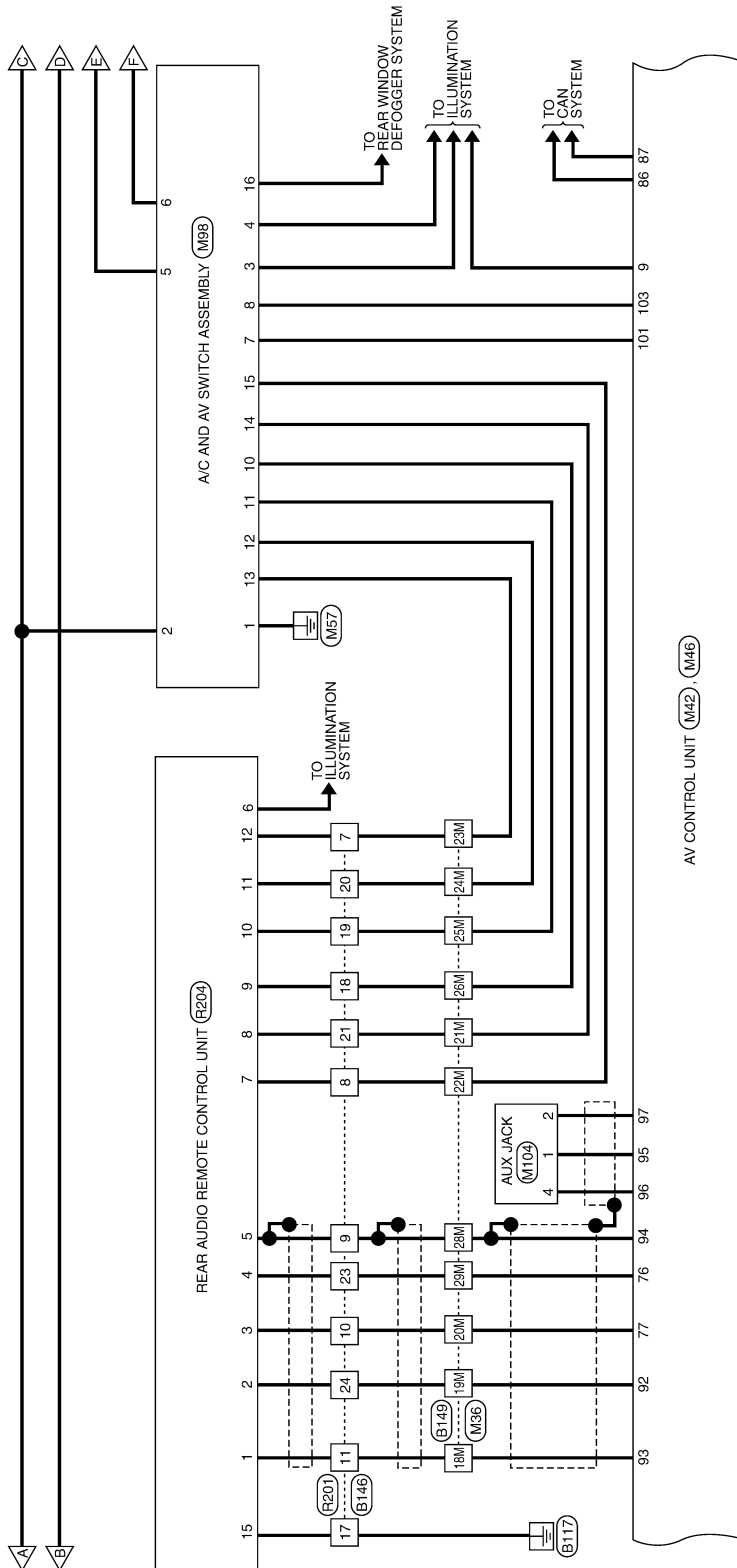

ALNWA0068GE



# AV CONTROL UNIT

< ECU DIAGNOSIS >

[BASE AUDIO]

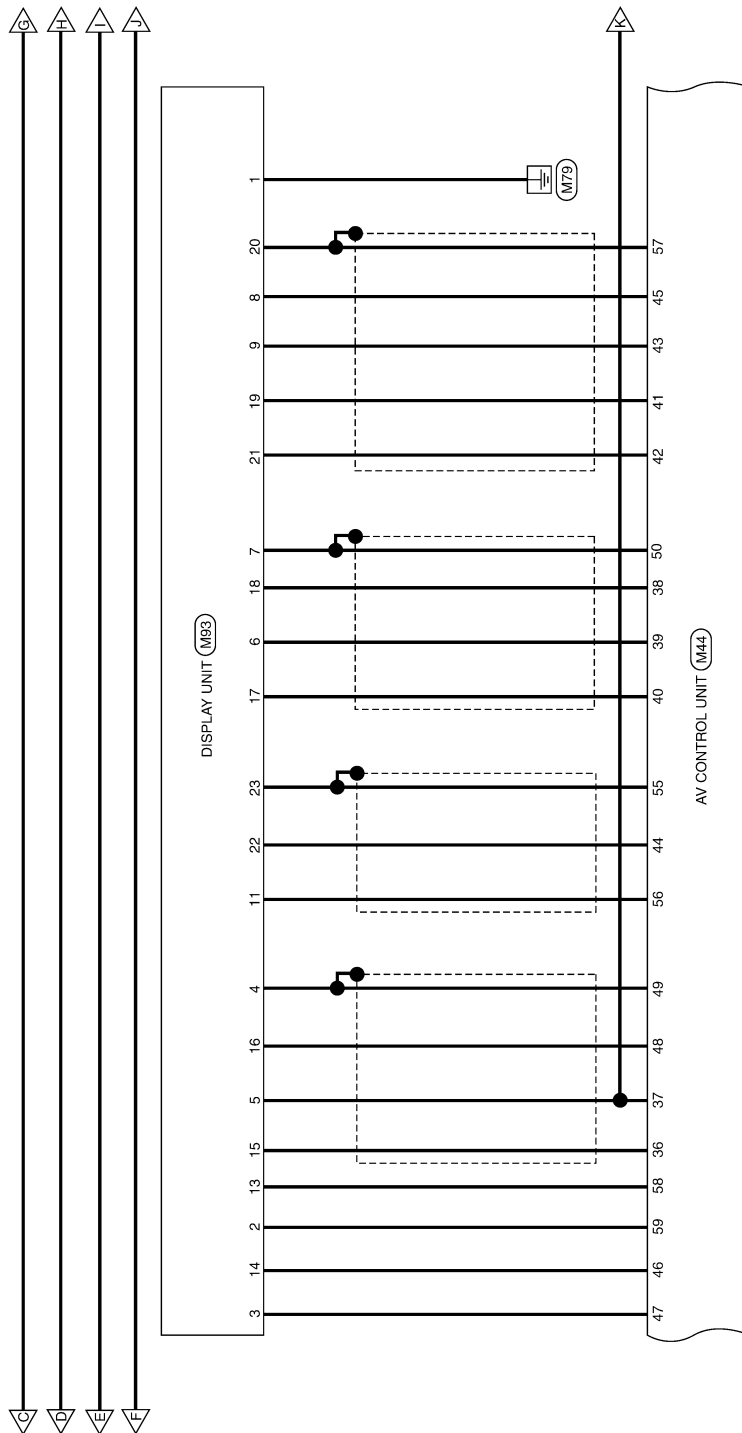

A  
B  
C  
D  
E  
F  
G  
H  
I  
J  
K  
L  
M  
O  
P

AV

ALNWA0069GE

# AV CONTROL UNIT

< ECU DIAGNOSIS >

[BASE AUDIO]

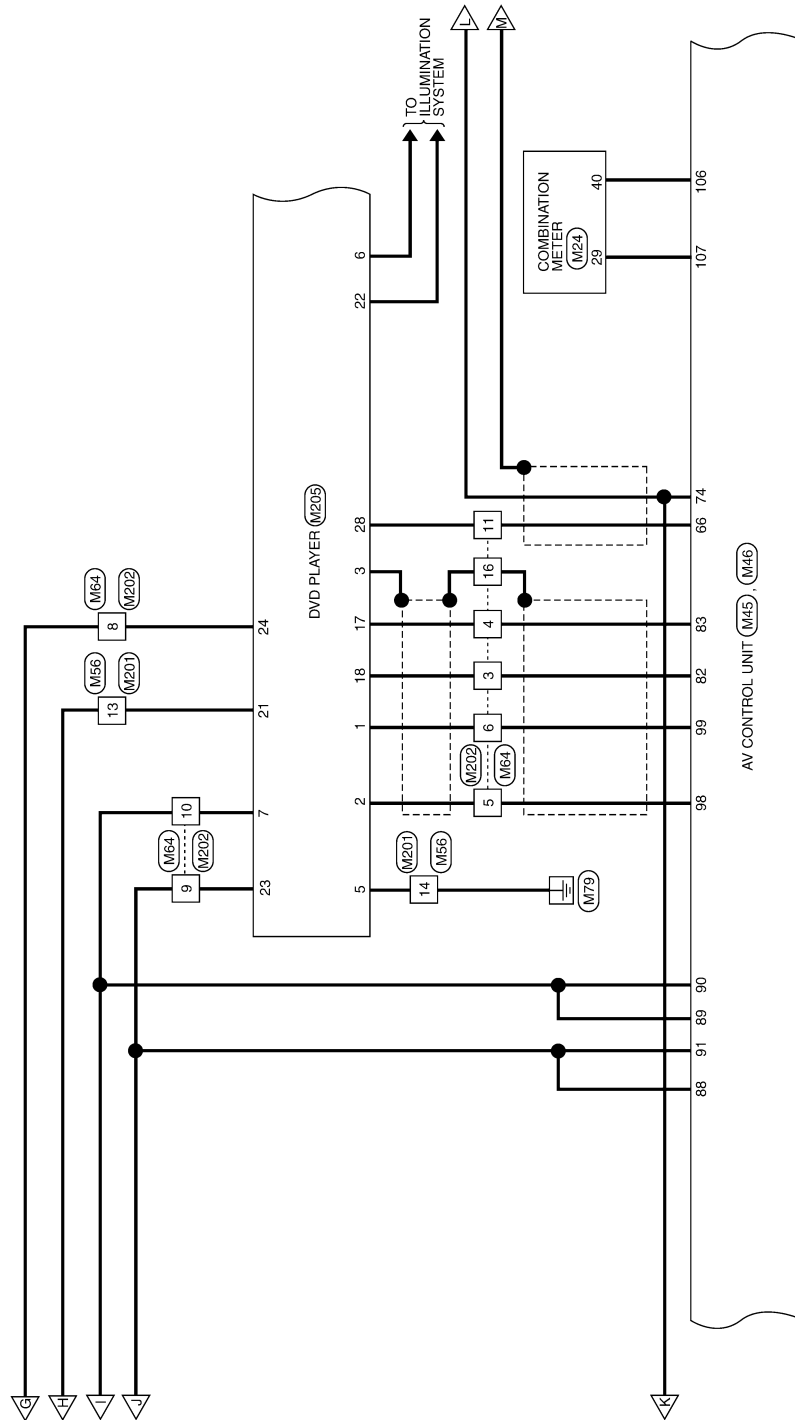

ALNWA0071GE

# AV CONTROL UNIT

< ECU DIAGNOSIS >

[BASE AUDIO]

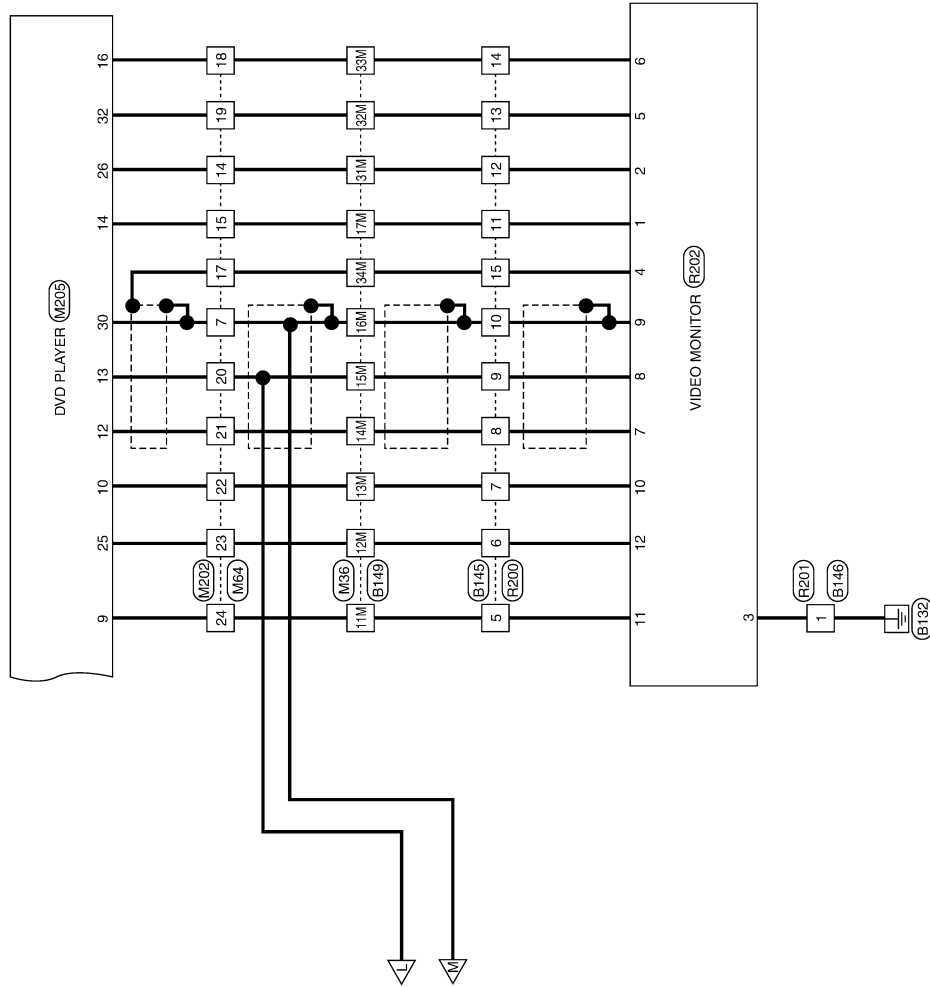

A  
B  
C  
D  
E  
F  
G  
H  
I  
J  
K  
L  
M  
N  
O  
P

AV

ALNWA0072GE

## BASE AUDIO SYSTEM CONNECTORS

Connector No.	M4
Connector Name	FUSE BLOCK (J/B)
Connector Color	WHITE



Terminal No.	Color of Wire	Signal Name
4P	V	-

Connector No.	M8
Connector Name	WIRE TO WIRE
Connector Color	WHITE

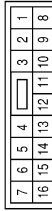

Terminal No.	Color of Wire	Signal Name
10	L/R	-
11	L/W	-

Connector No.	M24
Connector Name	COMBINATION METER
Connector Color	WHITE

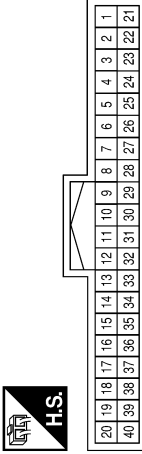

Terminal No.	Color of Wire	Signal Name
29	W/R	SPEED_8P
40	GR/R	-

Connector No.	M30
Connector Name	COMBINATION SWITCH (SPIRAL CABLE)
Connector Color	GRAY

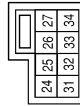

Terminal No.	Color of Wire	Signal Name
24	Y	STRG_SW_A
31	SHIELD	STRG_SW_C
32	BR	STRG_SW_B

Connector No.	M31
Connector Name	WIRE TO WIRE
Connector Color	WHITE

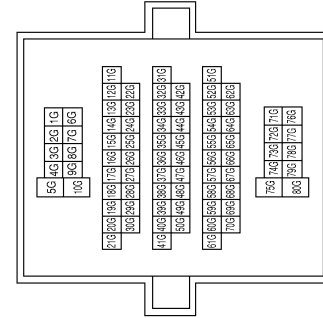

Terminal No.	Color of Wire	Signal Name
5G	Y	-

# AV CONTROL UNIT

< ECU DIAGNOSIS >

[BASE AUDIO]

Terminal No.	Color of Wire	Signal Name
25M	LG	-
26M	GR	-
28M	SHIELD	-
29M	O	-
31M	B/Y	-
32M	BR	-
33M	Y	-
34M	SHIELD	-
78M	O/L	-
79M	R/L	-

Terminal No.	Color of Wire	Signal Name
11M	SB	-
12M	BR	-
13M	G/Y	-
14M	B/W	-
15M	L	-
16M	SHIELD	-
17M	B/W	-
18M	O/L	-
19M	W	-
20M	W/L	-
21M	R	-
22M	Y	-
23M	G	-
24M	BR	-

Connector No.	M36
Connector Name	WIRE TO WIRE
Connector Color	WHITE

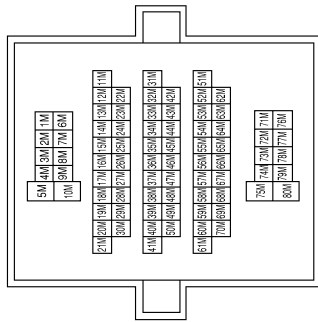

Terminal No.	Color of Wire	Signal Name
72J	SB	-
76J	B/Y	-

Connector No.	M40
Connector Name	WIRE TO WIRE
Connector Color	WHITE

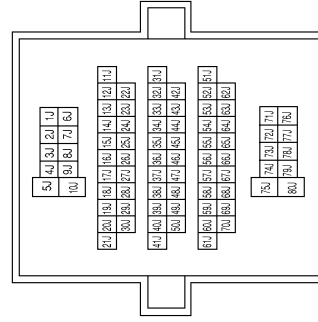

Connector No.	M39
Connector Name	FUSE BLOCK (J/B)
Connector Color	WHITE

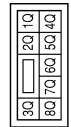

Terminal No.	Color of Wire	Signal Name
1Q	G/R	-

A  
B  
C  
D  
E  
F  
G  
H  
I  
J  
K  
L  
M  
N  
O  
P

AV

ALNIA0456GB

# AV CONTROL UNIT

< ECU DIAGNOSIS >

[BASE AUDIO]

Connector No.	M41
Connector Name	SATELLITE RADIO TUNER
Connector Color	WHITE

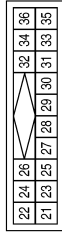

Terminal No.	Color of Wire	Signal Name
21	B	SAT_LH_OUT
22	W	SAT_LH+_OUT
23	BR	SAT_RH_OUT
24	Y	SAT_RH+_OUT
25	SHIELD	SIG_SHIELD
26	SHIELD	DATA_GND

Terminal No.	Color of Wire	Signal Name
27	—	—
28	W	REQ1_(SAT_HU)
29	R	TXD_(SAT_HU)
30	B	FXD_(H-SAT)
31	—	—
32	Y	BATT
33	—	—
34	—	—
35	—	—
36	V	ACC

Connector No.	M42
Connector Name	AV CONTROL UNIT
Connector Color	WHITE

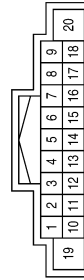

Terminal No.	Color of Wire	Signal Name
1	—	—
2	L/W	FR_DR_LH_SP+
3	L/R	FR_DR_LH_SP-
4	SB	RR_DR_LH_SP+
5	B/Y	RR_DR_LH_SP-
6	Y	STRG_SW_A

Terminal No.	Color of Wire	Signal Name
7	V	ACC
8	—	—
9	R/L	ILL
10	—	—
11	W/B	FR_RH_SP+
12	L/B	FR_RH_SP-
13	O/L	RR_RH_SP+
14	R/L	RR_RH_SP-
15	SHIELD	STRG_SW_GND
16	BR	STRG_SW_B
17	—	—
18	—	—
19	Y	B+
20	B	GND

ALNIA0457GB

# AV CONTROL UNIT

< ECU DIAGNOSIS >

[BASE AUDIO]

Connector No.	M43
Connector Name	AV CONTROL UNIT
Connector Color	WHITE



Terminal No.	Color of Wire	Signal Name
30	B	TX_(FROM_HU)
31	—	—
32	—	—

Terminal No.	Color of Wire	Signal Name
21	B	N_BUS_LH-
22	W	N_BUS_LH+
23	BR	N_BUS_RH-
24	Y	N_BUS_RH+
25	SHIELD	N_BUS_SHIELD
26	SHIELD	DATA_GND
27	—	—
28	W	REQ1_(TO_HU)
29	R	RX_(TO_HU)

Connector No.	M44
Connector Name	AV CONTROL UNIT
Connector Color	WHITE

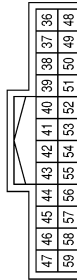

Terminal No.	Color of Wire	Signal Name
36	W	COMP OUT+
37	B	COMP OUT-
38	R	B

Terminal No.	Color of Wire	Signal Name
39	B	G
40	W	R
41	W	RGB_SYNC
42	SHIELD	RGB_SYNC_GND
43	O	YS
44	LG	DISP_IT
45	W/L	HP
46	G/O	SIG_GND
47	B/O	SIG_VCC
48	R	COMP_OUT_SYNC
49	SHIELD	COMP_OUT_SHIELD
50	SHIELD	RBG_GND

Terminal No.	Color of Wire	Signal Name
51	—	—
52	—	—
53	—	—
54	B	GND
55	SHIELD	SHIELD
56	V	IT_DISP
57	O/L	VP
58	B	INV_GND
59	BR/Y	INV_VCC

ALNIA0458GB

A  
B  
C  
D  
E  
F  
G  
H  
I  
J  
K  
L  
M  
N  
O  
P

AV

# AV CONTROL UNIT

< ECU DIAGNOSIS >

[BASE AUDIO]

Connector No.	M45
Connector Name	AV CONTROL UNIT
Connector Color	WHITE

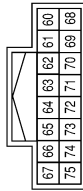

Terminal No.	Color of Wire	Signal Name
60	—	—
61	—	—
62	—	—
63	—	—
64	—	—

Terminal No.	Color of Wire	Signal Name
65	—	—
66	B/W	COMP1_1N+
67	—	—
68	—	—
69	—	—
70	—	—
71	—	—
72	—	—
73	—	—
74	L	COMP1_1N-
75	—	—

Connector No.	M46
Connector Name	AV CONTROL UNIT
Connector Color	WHITE

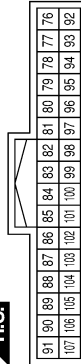

Terminal No.	Color of Wire	Signal Name
76	O	HP_RH-
77	—	—
78	—	—
79	—	—
80	—	—
81	—	—
82	G	AUDIO_BUS_RH-
83	R	AUDIO_BUS_RH+

Terminal No.	Color of Wire	Signal Name
84	—	—
85	B	GND
86	L	CAN-H
87	P	CAN-L
88	W/L	M-CAN1-H
89	P/B	M-CAN1-L
90	L/W	M-CAN2-H
91	B/P	M-CAN2-L
92	W	HP_LH -
93	O/L	HP_LH +
94	SHIELD	HP_SHIELD
95	B	AUX_AUDIO_RH+
96	W	AUX_AUDIO_LH+
97	R	AUX_GND
98	B	AUDIO_BUS_LH-
99	W	AUDIO_BUS_LH+

Terminal No.	Color of Wire	Signal Name
100	—	—
101	B	SW_GND
102	SB	CD_EJECT
103	—	—
104	G/R	IGN
105	—	—
106	G	PKB_SIG
107	W/R	SPEED_8P

ALNIA0459GB



# AV CONTROL UNIT

< ECU DIAGNOSIS >

[BASE AUDIO]

Connector No.	M56
Connector Name	WIRE TO WIRE
Connector Color	WHITE

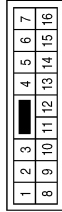

Terminal No.	Color of Wire	Signal Name
13	Y	-
14	B	-

Connector No.	M64
Connector Name	WIRE TO WIRE
Connector Color	BROWN

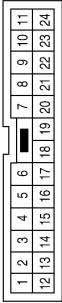

Terminal No.	Color of Wire	Signal Name
3	G	-
4	R	-
5	B	-
6	W	-
7	SHIELD	-
8	V	-
9	P/B	-
10	W/L	-

Terminal No.	Color of Wire	Signal Name
11	BW	-
14	B/Y	-
15	BW	-
16	SHIELD	-
17	SHIELD	-
18	Y	-
19	BR	-
20	L	-
21	BW	-
22	G/Y	-
23	BR	-
24	SB	-

Connector No.	M68
Connector Name	WIRE TO WIRE
Connector Color	BROWN



Terminal No.	Color of Wire	Signal Name
1	V	-

Connector No.	M75
Connector Name	WIRE TO WIRE
Connector Color	BROWN

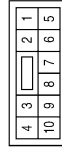

Terminal No.	Color of Wire	Signal Name
2	L/B	-
5	W/B	-

Connector No.	M78
Connector Name	WIRE TO WIRE
Connector Color	BROWN



Terminal No.	Color of Wire	Signal Name
1	B	-
2	B	-

ALNIA0460GB

A  
B  
C  
D  
E  
F  
G  
H  
I  
J  
K  
L  
M  
AV  
O  
P

Connector No.	M93
Connector Name	DISPLAY UNIT
Connector Color	WHITE

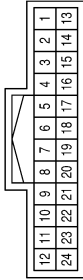

Terminal No.	Color of Wire	Signal Name
1	B	GND
2	BR/Y	INV_VCC
3	B/O	SIG_VCC
4	SHIELD	COMP_IN_SHIELD
5	L	COMP_IN-
6	B	G

Terminal No.	Color of Wire	Signal Name
7	SHIELD	RGB_GND
8	W/L	HP
9	O	YS
11	V	IT_DISP
13	B	INV_GND
14	G/O	SIG_GND
15	Y	COMP_IN+
16	G	COMP_IN_SYNC
17	W	R
18	R	B
19	W	RGB_SYNC
20	O/L	VP
21	SHIELD	RGB_SYNC_GND
22	LG	DISP-IT
23	SHIELD	SHIELD

Connector No.	M98
Connector Name	A/C AND AV SWITCH ASSEMBLY
Connector Color	WHITE

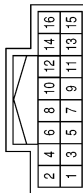

Terminal No.	Color of Wire	Signal Name
1	B	GND
2	V	ACC
3	R/L	ILL
4	BR	ILL CONT GND
5	W/L	M-CAN1-H

Terminal No.	Color of Wire	Signal Name
6	P/B	M-CAN1-L
7	B	SW GND
8	SB	CD DVD EJECT
10	GR	REMOTE A
11	LG	REMOTE B
12	BR	REMOTE C
13	G	REMOTE D
14	R	ENABLE
15	Y	REMOTE GND
16	GR/R	RR DEFOG

Connector No.	M102
Connector Name	COMBINATION SWITCH (SPIRAL CABLE)
Connector Color	GRAY



Terminal No.	Color of Wire	Signal Name
16	R	-
17	BR	-
20	W	-

# AV CONTROL UNIT

< ECU DIAGNOSIS >

[BASE AUDIO]

Connector No.	M111
Connector Name	FRONT TWEETER RH
Connector Color	BROWN



Terminal No.	Color of Wire	Signal Name
1	W/B	-
2	L/B	-

Connector No.	M109
Connector Name	FRONT TWEETER LH
Connector Color	BROWN



Terminal No.	Color of Wire	Signal Name
1	L/W	-
2	L/R	-

Connector No.	M104
Connector Name	AUX JACK
Connector Color	WHITE

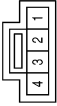

Terminal No.	Color of Wire	Signal Name
1	B	AUX_AUDIO_RH +
2	R	AUX_GND
4	W	AUX_AUDIO_LH +

Connector No.	M201
Connector Name	WIRE TO WIRE
Connector Color	WHITE



Terminal No.	Color of Wire	Signal Name
13	Y	-
14	B	-

Connector No.	M129
Connector Name	SATELLITE RADIO TUNER
Connector Color	VIOLET



Terminal No.	Color of Wire	Signal Name
37	B	-

Connector No.	M124
Connector Name	AV CONTROL UNIT
Connector Color	GRAY

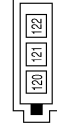

Terminal No.	Color of Wire	Signal Name
120	B	-
121	B	-
122	B	-

A  
B  
C  
D  
E  
F  
G  
H  
I  
J  
K  
L  
M  
N  
O  
P

AV

ALNIA0462GB

# AV CONTROL UNIT

< ECU DIAGNOSIS >

[BASE AUDIO]

Connector No.	M202
Connector Name	WIRE TO WIRE
Connector Color	BROWN

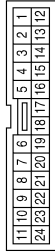

Terminal No.	Color of Wire	Signal Name
3	G	-
4	R	-
5	B	-
6	W	-
7	SHIELD	-
8	V	-
9	P/B	-

Connector No.	M205
Connector Name	DVD PLAYER
Connector Color	WHITE

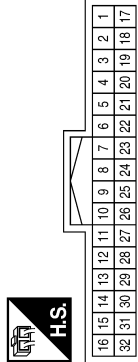

Terminal No.	Color of Wire	Signal Name
1	W	FES_L+_OUTPUT
2	B	FES_L-_OUTPUT
3	SHIELD	AUDIO_SHIELD
5	B	GND
6	BR	ILL+
7	W/L	M_CAN2-H

Terminal No.	Color of Wire	Signal Name
10	W/L	-
11	B/W	-
14	B/Y	-
15	B/W	-
16	SHIELD	-
17	SHIELD	-
18	Y	-
19	BR	-
20	L	-
21	B/W	-
22	G/Y	-
23	BR	-
24	SB	-

Terminal No.	Color of Wire	Signal Name
9	SB	DISPLAY_+ B
10	G/Y	SW_POWER+ 5V
12	B/W	VTR+
13	L	VTR-
14	B/W	DISPLAY_GND
16	Y	DATA_RX
17	R	FES_R+_OUTPUT
18	G	FES_R-_OUTPUT
21	Y	+B
22	R/L	LIGHTING SW
23	P/B	M_CAN2-L
24	V	ACC
25	BR	DISPLAY_+B
26	B/Y	DISPLAY_GND
28	B/W	VIDEO_OUT
30	SHIELD	VTR_SHIELD
32	BR	DATA_TX

Connector No.	M350
Connector Name	WIRE TO WIRE
Connector Color	BROWN



Terminal No.	Color of Wire	Signal Name
1	B	-

ALNIA0463GB

# AV CONTROL UNIT

< ECU DIAGNOSIS >

[BASE AUDIO]

Connector No.	M351
Connector Name	SATELLITE ANTENNA
Connector Color	BROWN



Terminal No.	Color of Wire	Signal Name
1	B	-

Connector No.	M550
Connector Name	WIRE TO WIRE
Connector Color	BROWN



Terminal No.	Color of Wire	Signal Name
1	B	-
2	B	-

Connector No.	M551
Connector Name	WIRE TO WIRE
Connector Color	BROWN



Terminal No.	Color of Wire	Signal Name
1	B	-
2	B	-

Connector No.	M601
Connector Name	WIRE TO WIRE
Connector Color	GRAY

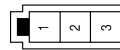

Terminal No.	Color of Wire	Signal Name
1	B	-
2	B	-

Connector No.	M602
Connector Name	ANTENNA AMP.
Connector Color	WHITE



Terminal No.	Color of Wire	Signal Name
1	B	-
2	B	-

Connector No.	E152
Connector Name	WIRE TO WIRE
Connector Color	WHITE

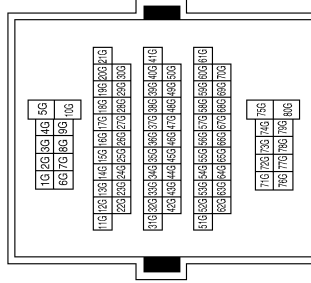

Terminal No.	Color of Wire	Signal Name
5G	Y	-

A  
B  
C  
D  
E  
F  
G  
H  
I  
J  
K  
L  
M  
N  
O  
P

AV

ALNIA0464GB

Terminal No.	Color of Wire	Signal Name
72J	SB	-
76J	B/Y	-

Connector No.	B69
Connector Name	WIRE TO WIRE
Connector Color	WHITE

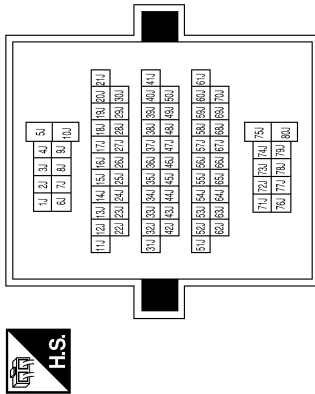

Connector No.	B6
Connector Name	WIRE TO WIRE
Connector Color	WHITE

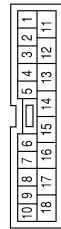

Terminal No.	Color of Wire	Signal Name
14	B/Y	-
15	SB	-

Terminal No.	Color of Wire	Signal Name
5	SB	-
6	BR	-
7	G/Y	-
8	W	-
9	L	-
10	SHIELD	-
11	B/W	-
12	B/Y	-
13	G	-
14	L	-
15	SHIELD	-

Connector No.	B145
Connector Name	WIRE TO WIRE
Connector Color	WHITE

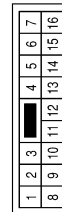

Connector No.	B106
Connector Name	WIRE TO WIRE
Connector Color	WHITE

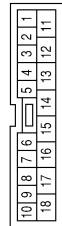

Terminal No.	Color of Wire	Signal Name
14	R/L	-
15	O/L	-

# AV CONTROL UNIT

< ECU DIAGNOSIS >

[BASE AUDIO]

Connector No.	B146
Connector Name	WIRE TO WIRE
Connector Color	BROWN

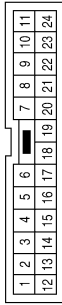

Terminal No.	Color of Wire	Signal Name
1	B	-
7	G	-
8	Y	-
9	SHIELD	-

Terminal No.	Color of Wire	Signal Name
10	W/L	-
11	O/L	-
17	B	-
18	GR	-
19	LG	-
20	BR	-
21	R/L	-
23	O	-
24	W	-

Connector No.	B149
Connector Name	WIRE TO WIRE
Connector Color	WHITE

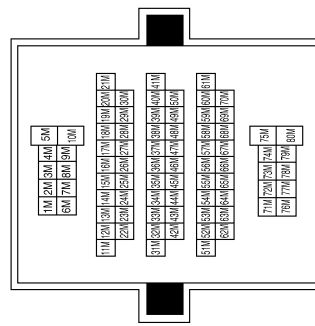

Terminal No.	Color of Wire	Signal Name
11M	SB	-
12M	BR	-
13M	G/Y	-
14M	B/W	-
15M	L	-
16M	SHIELD	-
17M	B/W	-
18M	O/L	-
19M	W	-
20M	W/L	-
21M	R	-
22M	Y	-
23M	G	-
24M	BR	-
25M	LG	-

Terminal No.	Color of Wire	Signal Name
26M	GR	-
28M	SHIELD	-
29M	O	-
31M	B/Y	-
32M	BR	-
33M	Y	-
34M	SHIELD	-
78M	O/L	-
79M	R/L	-

ALNIA0466GB

A  
B  
C  
D  
E  
F  
G  
H  
I  
J  
K  
L  
M  
N  
O  
P

AV

Connector No.	R200
Connector Name	WIRE TO WIRE
Connector Color	WHITE

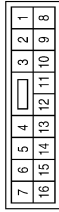

Terminal No.	Color of Wire	Signal Name
5	SB	-
6	BR	-

Terminal No.	Color of Wire	Signal Name
7	G/Y	-
8	W	-
9	L	-
10	SHIELD	-
11	B/W	-
12	B/Y	-
13	G	-
14	L	-
15	SHIELD	-

Connector No.	R201
Connector Name	WIRE TO WIRE
Connector Color	BROWN

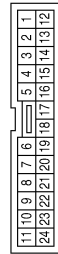

Terminal No.	Color of Wire	Signal Name
1	B	-
7	G	-
8	Y	-
9	SHIELD	-
10	W/L	-
11	O/L	-

Terminal No.	Color of Wire	Signal Name
17	B	-
18	GR	-
19	LG	-
20	BR	-
21	R/L	-
23	O	-
24	W	-

Connector No.	R202
Connector Name	VIDEO MONITOR
Connector Color	WHITE

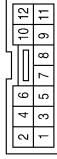

Terminal No.	Color of Wire	Signal Name
1	B/W	GND
2	B/Y	GND
3	B	1D
4	SHIELD	O/A_SHIELD
5	G	DATA_RX
6	L	DATA_TX
7	W	VIDEO_IN+
8	L	VIDEO_IN-
9	SHIELD	VIDEO_SHIELD
10	G/Y	SW_POWER_+5V
11	SB	FILTERED_BATT
12	BR	FILTERED_BATT



# AV CONTROL UNIT

< ECU DIAGNOSIS >

[BASE AUDIO]

Connector No.	R204
Connector Name	REAR AUDIO REMOTE CONTROL UNIT
Connector Color	WHITE

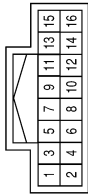

Terminal No.	Color of Wire	Signal Name
1	O/L	L_CH_INPUT
2	W	L_CH_INPUT
3	W/L	R_CH_INPUT
4	O	R_CH_INPUT
5	SHIELD	SHIELD
6	R/L	ILL+
7	Y	REMOTE

Terminal No.	Color of Wire	Signal Name
8	R	ENABLE
9	GR	REMOTE_A
10	LG	REMOTE_B
11	BR	REMOTE_C
12	G	REMOTE_D
15	B	GND

Connector No.	D2
Connector Name	WIRE TO WIRE
Connector Color	WHITE

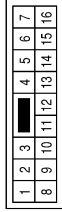

Terminal No.	Color of Wire	Signal Name
10	L/R	-
11	L/W	-

Connector No.	D12
Connector Name	FRONT DOOR SPEAKER LH
Connector Color	WHITE



Terminal No.	Color of Wire	Signal Name
1	L/W	-
2	L/R	-

Connector No.	D101
Connector Name	WIRE TO WIRE
Connector Color	WHITE

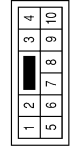

Terminal No.	Color of Wire	Signal Name
2	L/B	-
5	W/B	-

Connector No.	D112
Connector Name	FRONT DOOR SPEAKER RH
Connector Color	WHITE



Terminal No.	Color of Wire	Signal Name
1	W/B	-
2	L/B	-

ALNIA0468GB

A  
B  
C  
D  
E  
F  
G  
H  
I  
J  
K  
L  
M  
O  
P

AV

# AV CONTROL UNIT

< ECU DIAGNOSIS >

[BASE AUDIO]

Connector No.	D201
Connector Name	WIRE TO WIRE
Connector Color	WHITE

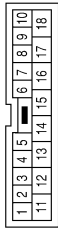

Terminal No.	Color of Wire	Signal Name
14	B/Y	-
15	SB	-

Connector No.	D207
Connector Name	REAR DOOR SPEAKER LH
Connector Color	WHITE



Terminal No.	Color of Wire	Signal Name
1	SB	-
2	B/Y	-

Connector No.	D208
Connector Name	REAR DOOR TWEETER LH
Connector Color	BROWN



Terminal No.	Color of Wire	Signal Name
1	SB	-
2	B/Y	-

Connector No.	D301
Connector Name	WIRE TO WIRE
Connector Color	WHITE

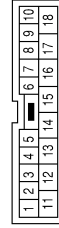

Terminal No.	Color of Wire	Signal Name
14	R/L	-
15	O/L	-

Connector No.	D307
Connector Name	REAR DOOR SPEAKER RH
Connector Color	WHITE



Terminal No.	Color of Wire	Signal Name
1	O/L	-
2	R/L	-

Connector No.	D308
Connector Name	REAR DOOR TWEETER RH
Connector Color	BROWN



Terminal No.	Color of Wire	Signal Name
1	O/L	-
2	R/L	-

ALNIA0469GB

## BOSE AUDIO SYSTEM (WITHOUT NAVI) CONNECTORS

Connector No.	M2
Connector Name	WIRE TO WIRE
Connector Color	WHITE

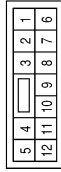

Terminal No.	Color of Wire	Signal Name
1	R/W	-
5	R/L	-
6	SHIELD	-
12	B	-

Connector No.	M4
Connector Name	FUSE BLOCK (J/B)
Connector Color	WHITE



Terminal No.	Color of Wire	Signal Name
4P	V	-
10P	GR	-

Connector No.	M8
Connector Name	WIRE TO WIRE
Connector Color	WHITE



Terminal No.	Color of Wire	Signal Name
10	L/R	-
11	L/W	-

Connector No.	M22
Connector Name	DATA LINK CONNECTOR
Connector Color	WHITE

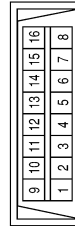

Terminal No.	Color of Wire	Signal Name
7	G/W	K-LINE

Connector No.	M24
Connector Name	COMBINATION METER
Connector Color	WHITE

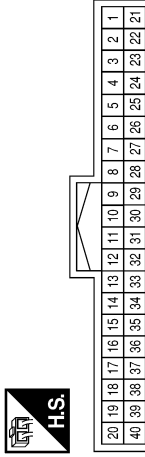

Terminal No.	Color of Wire	Signal Name
29	W/R	SPEED_8P
40	GR/R	-

Connector No.	M30
Connector Name	COMBINATION SWITCH (SPIRAL CABLE)
Connector Color	GRAY

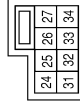

Terminal No.	Color of Wire	Signal Name
24	Y	STRG_SW_A
31	SHIELD	STRG_SW_C
32	BR	STRG_SW_B

ALNIA0470GB

## BOSE AUDIO SYSTEM (WITHOUT NAVI) CONNECTORS

Connector No.	M2
Connector Name	WIRE TO WIRE
Connector Color	WHITE

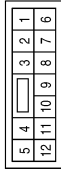

Terminal No.	Color of Wire	Signal Name
1	R/W	-
5	R/L	-
6	SHIELD	-
12	B	-

Connector No.	M4
Connector Name	FUSE BLOCK (J/B)
Connector Color	WHITE



Terminal No.	Color of Wire	Signal Name
4P	V	-
10P	GR	-

Connector No.	M8
Connector Name	WIRE TO WIRE
Connector Color	WHITE



Terminal No.	Color of Wire	Signal Name
10	L/R	-
11	L/W	-

Connector No.	M22
Connector Name	DATA LINK CONNECTOR
Connector Color	WHITE

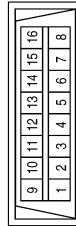

Terminal No.	Color of Wire	Signal Name
7	G/W	K-LINE

Connector No.	M24
Connector Name	COMBINATION METER
Connector Color	WHITE

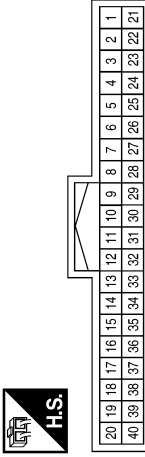

Terminal No.	Color of Wire	Signal Name
29	W/R	SPEED_8P
40	GR/R	-

Connector No.	M30
Connector Name	COMBINATION SWITCH (SPIRAL CABLE)
Connector Color	GRAY

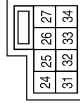

Terminal No.	Color of Wire	Signal Name
24	Y	STRG_SW_A
31	SHIELD	STRG_SW_C
32	BR	STRG_SW_B

Connector No.	M31
Connector Name	WIRE TO WIRE
Connector Color	WHITE

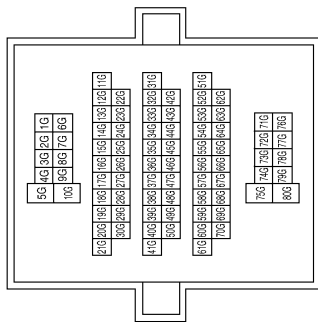

Terminal No.	Color of Wire	Signal Name
1G	G	-
2G	G/W	-
5G	Y	-
14G	R	-

Connector No.	M36
Connector Name	WIRE TO WIRE
Connector Color	WHITE

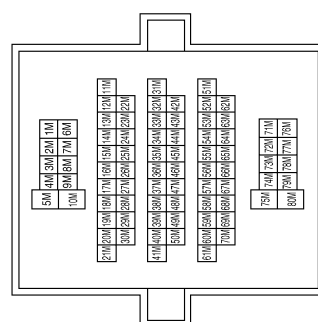

Terminal No.	Color of Wire	Signal Name
11M	SB	-
12M	BR	-
13M	G/Y	-
14M	B/W	-
15M	L	-
16M	SHIELD	-
17M	B/W	-
18M	O/L	-
19M	W	-
20M	W/L	-
21M	R	-
22M	Y	-
23M	G	-
24M	BR	-

Terminal No.	Color of Wire	Signal Name
25M	LG	-
26M	GR	-
27M	W/R	-
28M	SHIELD	-
29M	O	-
31M	B/Y	-
32M	BR	-
33M	Y	-
34M	SHIELD	-
35M	L	-
78M	O/L	-
79M	R/L	-

DTC Index

Self-diagnosis results display item

ALNIA0472GB

INFOID:000000001316564

A  
B  
C  
D  
E  
F  
G  
H  
I  
J  
K  
L  
M  
N  
O  
P

AV

# AV CONTROL UNIT

< ECU DIAGNOSIS >

[BASE AUDIO]

Error item	Refer to
CAN COMM CIRCUIT [U1000]	<a href="#">AV-24. "Description"</a>
CONTROL UNIT (CAN) [U1010]	<a href="#">AV-25. "Description"</a>
Control Unit FLASH-ROM [U1200]	<a href="#">AV-26. "Description"</a>
CAN CONT [U1216]	<a href="#">AV-27. "Description"</a>
SWITCH CONN [U1240]	<a href="#">AV-28. "Description"</a>
FRONT DISP CONN [U1243]	<a href="#">AV-29. "Description"</a>
DVD DECK CONN [U1248]	<a href="#">AV-31. "Description"</a>
SAT CONN [U1255]	<a href="#">AV-32. "Description"</a>
AV COMM CIRCUIT [U1300]	<a href="#">AV-33. "Description"</a>
CONTROL UNIT (AV) [U1310]	<a href="#">AV-34. "Description"</a>

# DISPLAY UNIT

< ECU DIAGNOSIS >

[BASE AUDIO]

## DISPLAY UNIT

Reference Value

INFOID:000000001316565

TERMINAL LAYOUT

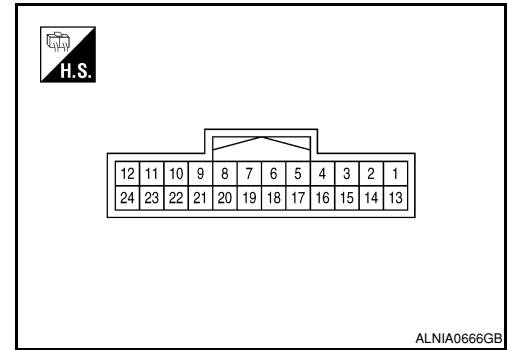

## PHYSICAL VALUES

Terminal (Wire color)		Description		Condition		Reference value (Approx.)
+	-	Signal name	Input/ Output			
1 (B)	Ground	Ground	—	Ignition switch ON	—	0V
2 (BR/Y)	Ground	Inverter VCC	Input	Ignition switch ACC	—	9V
3 (B/O)	Ground	Signal VCC	Input	Ignition switch ACC	—	9V
4	—	Shield	—	—	—	—
5 (L)	Ground	AUX image ground	—	Ignition switch ON	—	0V
6 (B)	Ground	RGB signal (G: green)	Input	Ignition switch ON	Start confirmation/adjust- ment mode, and then dis- play color bar by selecting "Color Spectrum Bar" on DISPLAY DIAGNO- SIS screen.	<p style="text-align: right;">SKIB2236J</p>
7	—	Shield	—	—	—	—
8 (W/L)	Ground	Horizontal synchronizing (HP) signal	Output	Ignition switch ON	—	<p style="text-align: right;">SKIB3601E</p>

A  
B  
C  
D  
E  
F  
G  
H  
I  
J  
K  
L  
M  
AV  
O  
P

# DISPLAY UNIT

< ECU DIAGNOSIS >

[BASE AUDIO]

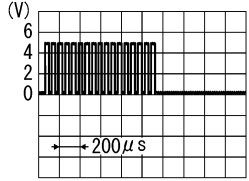
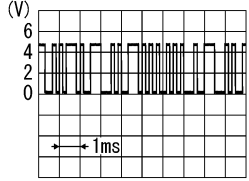
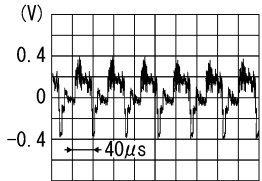
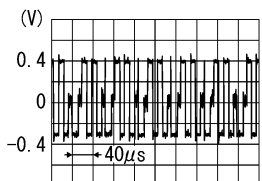
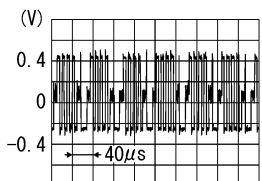
Terminal (Wire color)		Description		Condition	Reference value (Approx.)	
+	-	Signal name	Input/ Output			
9 (O)	Ground	RGB area (YS) signal	Input	Ignition switch ON	At RGB image displayed	5V
				Ignition switch ON	At rear view camera image displayed	 <p>PKIB4948J</p>
11 (V)	Ground	Communication signal (CONT→DISP)	Input	Ignition switch ON	When adjusting display-brightness	 <p>PKIB5039J</p>
13 (B)	Ground	Inverter ground	—	Ignition switch ON	—	0V
14 (G/O)	Ground	Signal ground	—	Ignition switch ON	—	0V
15 (Y)	Ground	AUX image signal	Input	Ignition switch ON	When AUX mode is selected	 <p>SKIB2251J</p>
16 (G)	—	AUX image synchronizing signal	Input	—	—	—
17 (W)	Ground	RGB signal (R: red)	Input	Ignition switch ON	Start confirmation/adjustment mode, and then display color bar by selecting "Color Spectrum Bar" on DISPLAY DIAGNOSIS screen.	 <p>SKIB2238J</p>
18 (R)	Ground	RGB signal (B: blue)	Input	Ignition switch ON	Start confirmation/adjustment mode, and then display color bar by selecting "Color Spectrum Bar" on DISPLAY DIAGNOSIS screen.	 <p>SKIB2237J</p>



# DISPLAY UNIT

< ECU DIAGNOSIS >

[BASE AUDIO]

Terminal (Wire color)		Description		Condition		Reference value (Approx.)
+	-	Signal name	Input/ Output			
19 (W)	Ground	RGB synchronizing signal	Input	Ignition switch ON	—	
20 (O/L)	Ground	Vertical synchronizing (VP) signal	Output	Ignition switch On	—	
21	—	Shield	—	—	—	—
22 (LG)	Ground	Communication signal (DISP→CONT)	Output	Ignition switch ON	When adjusting display- brightness	
23	—	Shield	—	—	—	—

A

B

C

D

E

F

G

H

I

J

K

L

M

AV

O

P

# DVD PLAYER

< ECU DIAGNOSIS >

[BASE AUDIO]

## DVD PLAYER

### Reference Value

INFOID:000000001316573

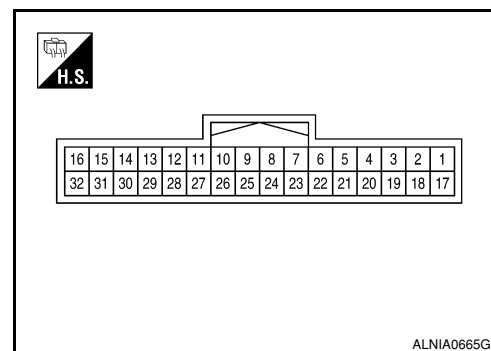

### PHYSICAL VALUES

Terminal (Wire color)		Description		Condition		Reference value (Approx.)
+	-	Signal name	Input/ Output			
1 (W)	2 (B)	DVD audio signal LH	Output	Ignition switch ON	With operation of the DVD player	<p>SKIB3609E</p>
3	—	Shield	—	—	—	—
5 (B)	Ground	Ground	—	Ignition switch ON	—	0V
6 (BR)	Ground	Illumination control (pulse width modulated)	—	—	With lighting switch ON	—
7 (W/L)	Ground	Can communication	Input/ Output	Ignition switch ON	—	—
9 (SB)	Ground	Video monitor power sup- ply	Output	Ignition switch ON	With DVD player operation	12V
10 (G/Y)	Ground	Switch power	Output	Ignition switch ON	With DVD player operation	5V
12 (B/W)	Ground	VTR (+)	Output	Ignition switch ON	With DVD player operation	—
13 (L)	Ground	VTR (-)	Output	Ignition switch ON	With DVD player operation	—
14 (B/W)	Ground	Display ground	—	Ignition switch ON	With DVD player operation	0V
16 (Y)	—	Data receive	Input	—	—	—

# DVD PLAYER

< ECU DIAGNOSIS >

[BASE AUDIO]

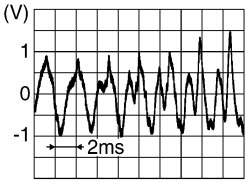
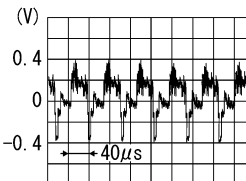
Terminal (Wire color)		Description		Condition		Reference value (Approx.)
+	-	Signal name	Input/ Output			
17 (R)	18 (G)	DVD audio signal RH	Output	Ignition switch ON	With DVD player operation	
21 (Y)	Ground	Battery power	Input	—	—	12V
22 (R/L)	Ground	Illumination power	Input	—	With instrument illumination ON	12V
23 (P/B)	Ground	CAN communication	Input/ Output	Ignition switch ON	—	0V
24 (V)	Ground	ACC power	Input	Ignition switch ACC or ON	—	12V
25 (BR)	Ground	Video monitor power	Output	Ignition switch ON	With DVD player operation	12V
26 (B/Y)	Ground	Video monitor ground	Input	Ignition switch ON	With instrument illumination ON	0V
28 (B/W)	Ground	Video out	Input	Ignition switch ACC or ON	—	
30	—	Shield	—	—	—	—
32 (BR)	—	Data transmit	Output	—	—	—

A  
B  
C  
D  
E  
F  
G  
H  
I  
J  
K  
L  
M

AV

# AUDIO SYSTEM

< SYMPTOM DIAGNOSIS >

[BASE AUDIO]

## SYMPTOM DIAGNOSIS

### AUDIO SYSTEM

#### Symptom Table

INFOID:000000001297336

#### AUDIO SYSTEM

Symptom	Possible cause	Reference page
Inoperative	<ul style="list-style-type: none"><li>• AV control unit power circuit</li><li>• AV control unit</li></ul>	<ul style="list-style-type: none"><li>• <a href="#">AV-35</a></li></ul>
Steering switch does not operate	<ul style="list-style-type: none"><li>• Steering switch</li><li>• AV control unit</li></ul>	<ul style="list-style-type: none"><li>• <a href="#">AV-56</a></li><li>• <a href="#">AV-35</a></li></ul>
All speakers do not sound	<ul style="list-style-type: none"><li>• AV control unit</li><li>• AV control unit power circuit</li></ul>	<ul style="list-style-type: none"><li>• <a href="#">AV-35</a></li></ul>
One or several speakers do not sound	<ul style="list-style-type: none"><li>• Front door speaker</li><li>• Front tweeter</li><li>• Rear door tweeter</li><li>• Rear door speaker</li></ul>	<ul style="list-style-type: none"><li>• <a href="#">AV-48</a></li><li>• <a href="#">AV-50</a></li><li>• <a href="#">AV-54</a></li><li>• <a href="#">AV-52</a></li></ul>

#### CD

Symptom	Possible cause	Reference page
CD cannot be inserted.	AV control unit	<a href="#">AV-35</a>
CD cannot be ejected.		
The CD cannot be played.		
The sound skips, stops suddenly, or is distorted.		

#### SATELLITE RADIO

Symptom	Possible cause	Reference page
Inoperative	<ul style="list-style-type: none"><li>• Satellite radio tuner power or ground circuit</li><li>• Satellite radio tuner communication circuit</li><li>• Satellite radio tuner</li></ul>	<ul style="list-style-type: none"><li>• <a href="#">AV-38</a></li><li>• <a href="#">AV-58</a></li></ul>
Right or left channel does not sound	<ul style="list-style-type: none"><li>• Satellite radio tuner right channel audio signal circuit</li><li>• Satellite radio tuner left channel audio signal circuit</li><li>• Satellite radio tuner</li></ul>	<ul style="list-style-type: none"><li>• <a href="#">AV-61</a></li><li>• <a href="#">AV-61</a></li></ul>

#### DVD PLAYER

Symptom	Possible cause	Reference page
DVD player inoperative	<ul style="list-style-type: none"><li>• Power supply and ground circuits</li><li>• DVD player</li></ul>	<ul style="list-style-type: none"><li>• <a href="#">AV-39</a></li><li>• <a href="#">AV-112</a></li></ul>
No sound when playing a DVD	<ul style="list-style-type: none"><li>• Audio signal circuits</li><li>• AV control unit</li><li>• DVD player</li></ul>	<ul style="list-style-type: none"><li>• <a href="#">AV-98</a></li><li>• <a href="#">AV-98</a></li><li>• <a href="#">AV-112</a></li></ul>
Video monitor is inoperative/does not display properly	<ul style="list-style-type: none"><li>• Power supply and ground circuits</li><li>• Video out circuit</li><li>• DVD player</li><li>• Display monitor</li></ul>	<ul style="list-style-type: none"><li>• <a href="#">AV-98</a></li><li>• <a href="#">AV-98</a></li><li>• <a href="#">AV-112</a></li><li>• <a href="#">AV-113</a></li></ul>
DVD remote control is inoperative/does not operate properly	<ul style="list-style-type: none"><li>• DVD player</li><li>• Video monitor</li></ul>	<ul style="list-style-type: none"><li>• <a href="#">AV-39</a></li><li>• <a href="#">AV-39</a></li></ul>
Headphones inoperative	<ul style="list-style-type: none"><li>• Headphone batteries</li><li>• Headphone audio signal circuits from AV control unit</li><li>• AV control unit</li><li>• Rear audio remote control unit</li></ul>	<ul style="list-style-type: none"><li>• <a href="#">AV-63</a></li><li>• <a href="#">AV-104</a></li><li>• <a href="#">AV-111</a></li></ul>

# NORMAL OPERATING CONDITION

< SYMPTOM DIAGNOSIS >

[BASE AUDIO]

## NORMAL OPERATING CONDITION

### Description

INFOID:000000001297339

The majority of the audio concerns are the result of outside causes (bad CD, electromagnetic interference, etc.).

### NOISE

The following noise results from variations in field strength, such as fading noise and multi-path noise, or external noise from trains and other sources. It is not a malfunction.

- Fading noise: This noise occurs because of variations in the field strength in a narrow range due to mountains or buildings blocking the signal.
- Multi-path noise: This noise results from the waves sent directly from the broadcast station arriving at the antenna at a different time from the waves which reflect off mountains or buildings.

The vehicle itself can be a source of noise if noise prevention parts or electrical equipment is malfunctioning. Check if noise is caused and/or changed by engine speed, ignition switch turned to each position, and operation of each piece of electrical equipment, and determine the cause.

### NOTE:

The source of the noise can be found easily by listening to the noise while removing the fuses of electrical components, one by one.

### Type of Noise and Possible Cause

Occurrence condition		Possible cause
Occurs only when engine is ON.	A continuous growling noise occurs. The speed of the noise varies with changes in the engine speed.	• Ignition components
The occurrence of the noise is linked with the operation of the fuel pump.		• Fuel pump condenser
Noise only occurs when various electrical components are operating.	A cracking or snapping sound occurs with the operation of various switches.	• Relay malfunction, audio unit malfunction
	The noise occurs when various motors are operating.	• Motor case ground • Motor
The noise occurs constantly, not just under certain conditions.		• Rear defogger coil malfunction • Open circuit in printed heater • Poor ground of antenna feeder line
A cracking or snapping sound occurs while the vehicle is being driven, especially when it is vibrating excessively.		• Ground wire of body parts • Ground due to improper part installation • Wiring connections or a short circuit

A  
B  
C  
D  
E  
F  
G  
H  
I  
J  
K  
L  
M  
O  
P

AV

## PRECAUTION

### PRECAUTIONS

#### Supplemental Restraint System (SRS) "AIR BAG" and "SEAT BELT PRE-TENSIONER"

INFOID:000000001297340

The Supplemental Restraint System such as "AIR BAG" and "SEAT BELT PRE-TENSIONER", used along with a front seat belt, helps to reduce the risk or severity of injury to the driver and front passenger for certain types of collision. This system includes seat belt switch inputs and dual stage front air bag modules. The SRS system uses the seat belt switches to determine the front air bag deployment, and may only deploy one front air bag, depending on the severity of a collision and whether the front occupants are belted or unbelted. Information necessary to service the system safely is included in the SRS and SB section of this Service Manual.

**WARNING:**

- **To avoid rendering the SRS inoperative, which could increase the risk of personal injury or death in the event of a collision which would result in air bag inflation, all maintenance must be performed by an authorized NISSAN/INFINITI dealer.**
- **Improper maintenance, including incorrect removal and installation of the SRS, can lead to personal injury caused by unintentional activation of the system. For removal of Spiral Cable and Air Bag Module, see the SRS section.**
- **Do not use electrical test equipment on any circuit related to the SRS unless instructed to in this Service Manual. SRS wiring harnesses can be identified by yellow and/or orange harnesses or harness connectors.**

PREPARATION

PREPARATION

Commercial Service Tools

INFOID:000000001297341

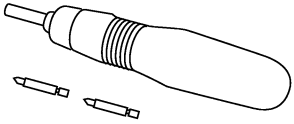
Tool name	Description
<p>Power tool</p>  <p>PBIC0191E</p>	<p>Loosening bolts and nuts</p>

A  
B  
C  
D  
E  
F  
G  
H  
I  
J  
K  
L  
M  
O  
P

AV

## ON-VEHICLE REPAIR

### AV CONTROL UNIT

#### Removal and Installation

INFOID:000000001297342

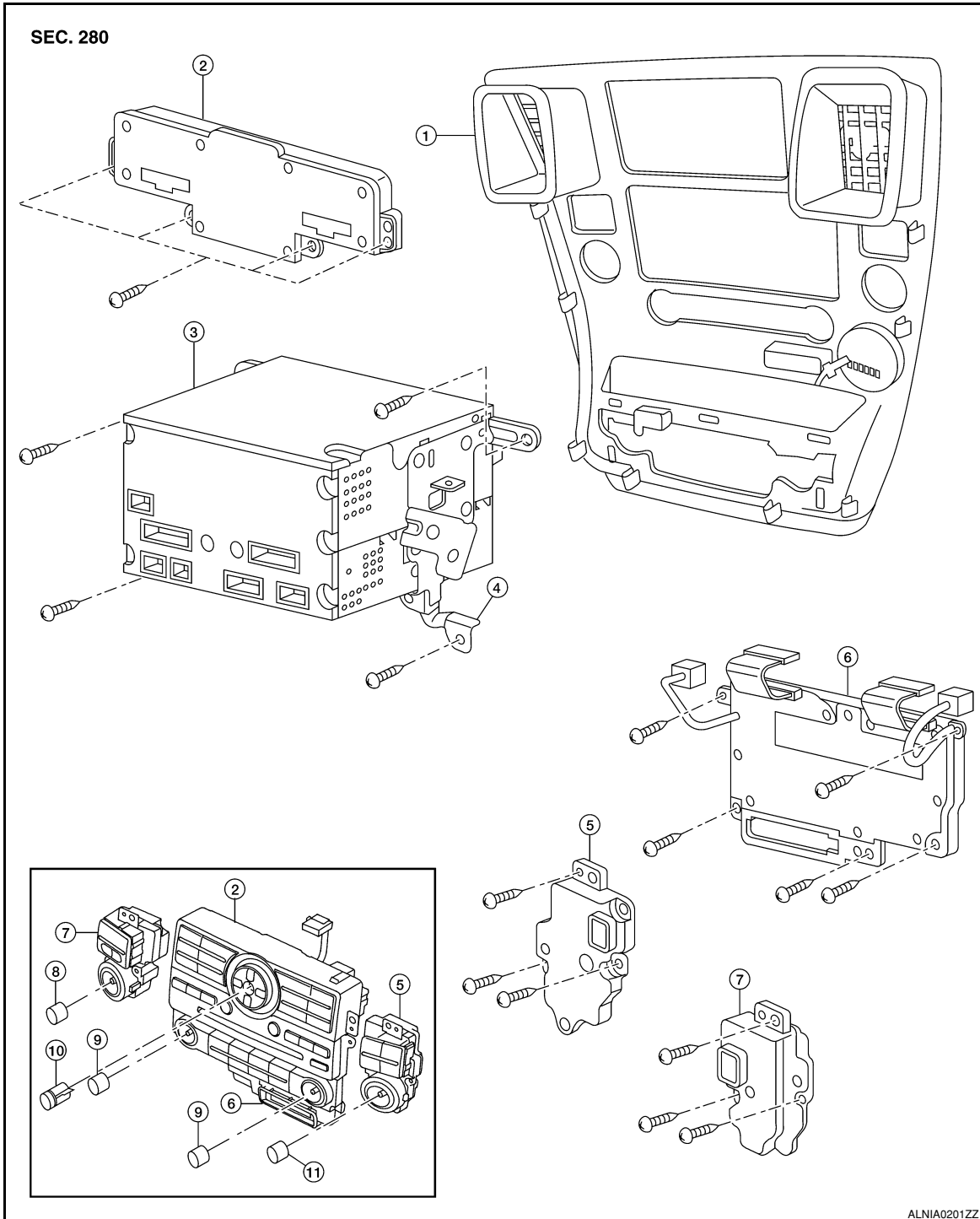

ALNIA0201ZZ

- |                             |                       |                         |
|-----------------------------|-----------------------|-------------------------|
| 1. Cluster lid C            | 2. AV switch assembly | 3. AV control unit      |
| 4. AV control unit brackets | 5. Tuner knob switch  | 6. AC switch assembly   |
| 7. Volume knob switch       | 8. Volume knob        | 9. Temp knobs RH and LH |
| 10. Enter button            | 11. Tuner knob        |                         |

**CAUTION:**



# AV CONTROL UNIT

< ON-VEHICLE REPAIR >

[BASE AUDIO]

**Only remove and replace the A/C or AV switch assembly knobs if damaged or missing. The knobs must not be removed from switches when removing and installing the A/C or AV switch assembly to prevent damage to the switch assembly.**

## REMOVAL

1. Disconnect the battery negative terminal.
2. Remove the cluster lid C. Refer to [IP-14, "Removal and Installation"](#).
3. Remove the AV control unit screws, using a power tool.
4. Remove the AV control unit.
5. Remove the A/C and AV switch assembly screws, then remove the A/C and AV switch assemblies as necessary.

## INSTALLATION

Installation is in the reverse order of removal.

A  
B  
C  
D  
E  
F  
G  
H  
I  
J  
K  
L  
M  
O  
P

AV

# DISPLAY UNIT

< ON-VEHICLE REPAIR >

[BASE AUDIO]

## DISPLAY UNIT

### Removal and Installation

INFOID:000000001306772

#### REMOVAL

1. Remove cluster lid C. Refer to [IP-14. "Removal and Installation"](#).
2. Remove the display unit screws (A), pull out the display unit (1) from instrument panel, to disconnect the display unit connectors.

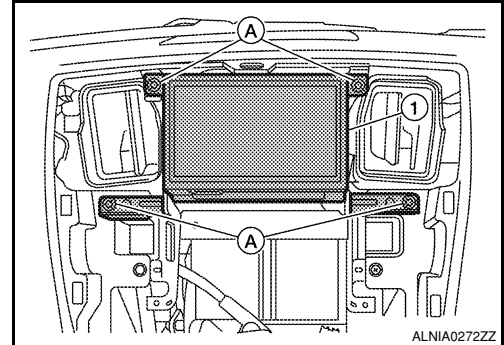

3. Remove the A/C auto amp. screws (A) and the A/C auto amp. (1).
  - Display unit (2)
4. Remove the display unit bracket screws and the display unit brackets.

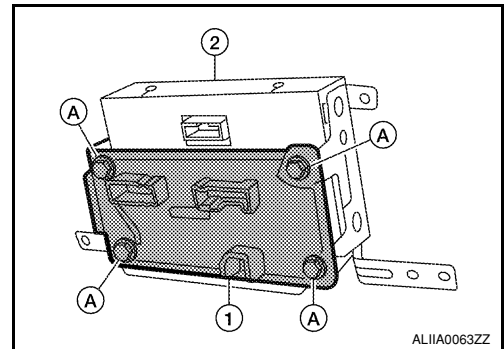

#### INSTALLATION

Installation is in the reverse order of removal.

## FRONT TWEETER

## Removal and Installation

INFOID:000000001297936

## REMOVAL

**CAUTION:****Use a suitable tool to prevent damage to the tweeter speaker grille trim and the instrument panel.**

1. Remove front tweeter speaker grille.
2. Remove the front tweeter clips (C103) (A).
3. Disconnect the front tweeter connector.
4. Remove the front tweeter (1).

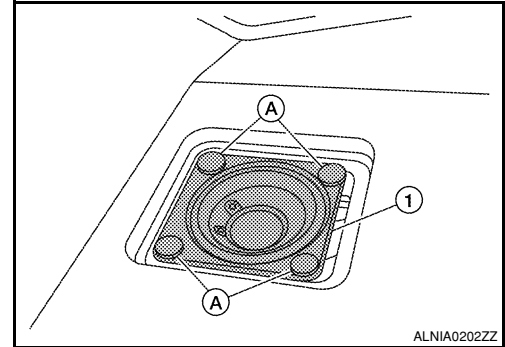

## INSTALLATION

Installation is in the reverse order of removal.

A  
B  
C  
D  
E  
F  
G  
H  
I  
J  
K  
L  
M  
O  
P

AV

# FRONT DOOR SPEAKER

< ON-VEHICLE REPAIR >

[BASE AUDIO]

## FRONT DOOR SPEAKER

### Removal and Installation

INFOID:000000001297344

#### REMOVAL

1. Remove the front door finisher. Refer to [INT-10, "Removal and Installation"](#).
2. Remove the front door speaker screws.
3. Disconnect the front door speaker connector.
4. Remove the front door speaker.

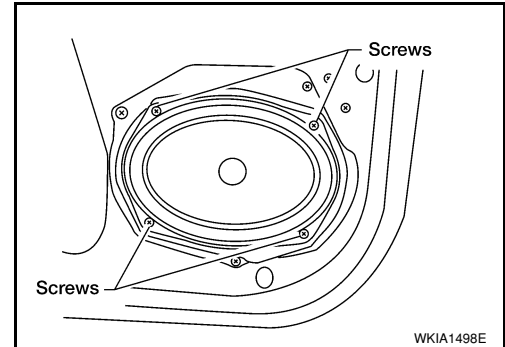

#### INSTALLATION

Installation is in the reverse order of removal.

## REAR DOOR SPEAKER

### Removal and Installation

INFOID:000000001303714

### REAR DOOR SPEAKER

#### Removal

1. Remove the rear door finisher. Refer to [INT-10, "Removal and Installation"](#).
2. Remove the rear door speaker screws.
3. Disconnect the rear door speaker connector.
4. Remove the rear door speaker.

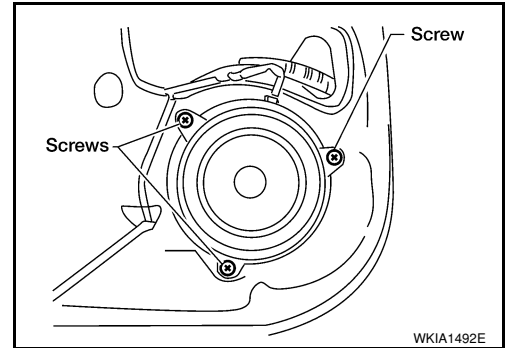

#### Installation

Installation is in the reverse order of removal.

### REAR DOOR TWEETER

#### Removal

1. Remove the rear door finisher. Refer to [INT-10, "Removal and Installation"](#).
2. Remove the rear door tweeter screws (A).
3. Remove the rear door tweeter (1).

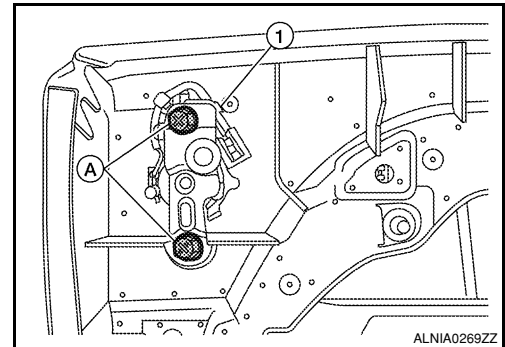

#### Installation

Installation is in the reverse order of removal.

A  
B  
C  
D  
E  
F  
G  
H  
I  
J  
K  
L  
M  
O  
P

AV

## STEERING SWITCH

### Removal and Installation

INFOID:000000001297349

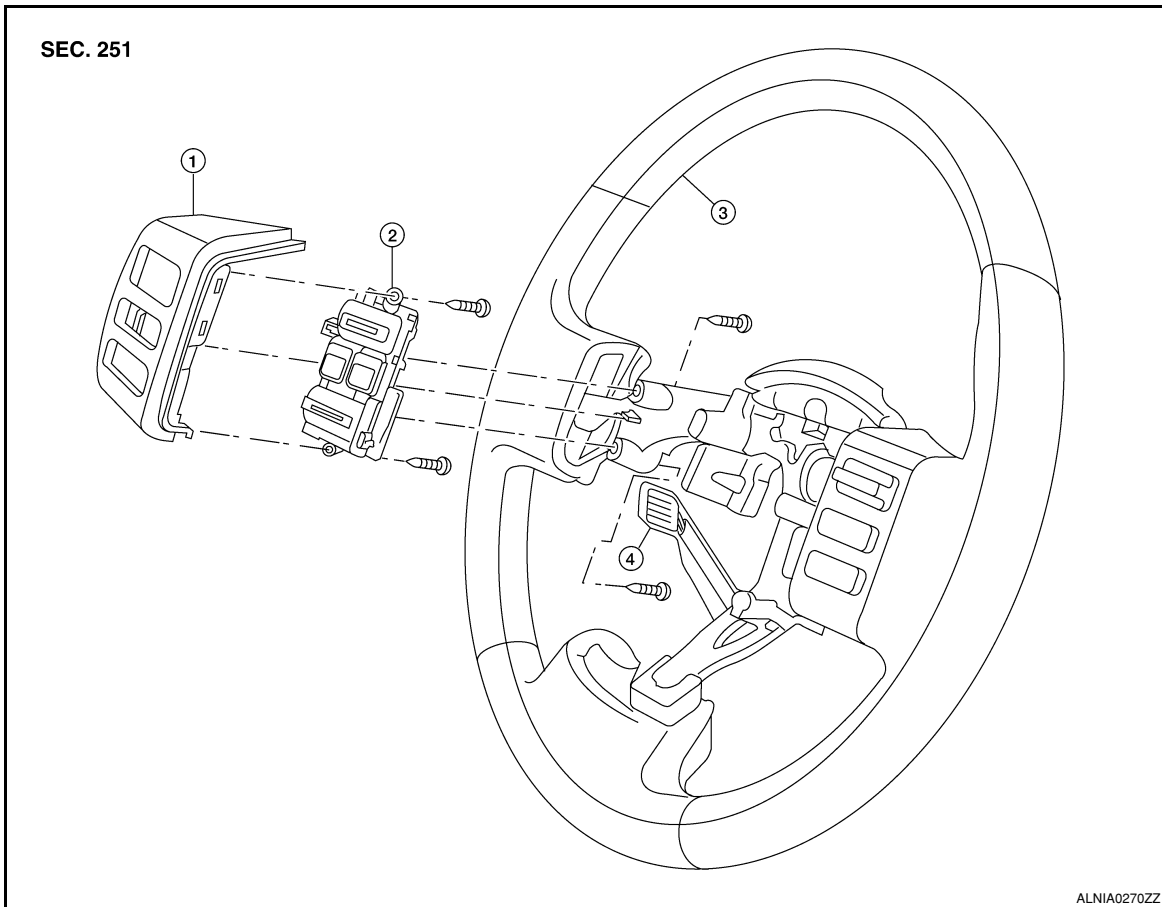

1. Steering wheel audio control switch finisher
2. Steering wheel audio control switch
3. Steering wheel finisher
4. Steering wheel audio control switch connector

#### REMOVAL

1. Remove the steering wheel. Refer to [ST-26. "Removal and Installation"](#).
2. Remove the steering wheel rear cover.
3. Pull the steering wheel audio control out of the steering wheel, disconnect the steering wheel audio control switch connector.
4. Remove the steering wheel audio control switch finisher screws and remove the steering wheel audio control switch finisher.

#### INSTALLATION

Installation is in the reverse order of removal.

# REAR AUDIO REMOTE CONTROL UNIT

< ON-VEHICLE REPAIR >

[BASE AUDIO]

## REAR AUDIO REMOTE CONTROL UNIT

### Removal and Installation

INFOID:000000001306774

#### REMOVAL

**CAUTION:**

**Wrap removal tool with clean shop cloth to prevent damage to the headliner.**

1. Carefully remove the rear audio remote control unit from the rear roof console assembly (1).
2. Disconnect connectors and remove the rear audio remote control unit.

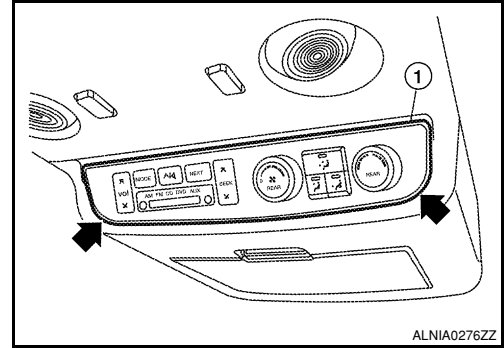

#### INSTALLATION

Installation is in the reverse order of removal.

A  
B  
C  
D  
E  
F  
G  
H  
I  
J  
K  
L  
M

AV

O  
P

## DVD PLAYER

### Removal and Installation

INFOID:000000001303715

#### REMOVAL

1. Disconnect the battery negative terminal.
2. Remove the center console bin. Refer to [IP-19, "Removal and Installation"](#).
3. Remove the DVD player screws (A) and remove the DVD player (1).

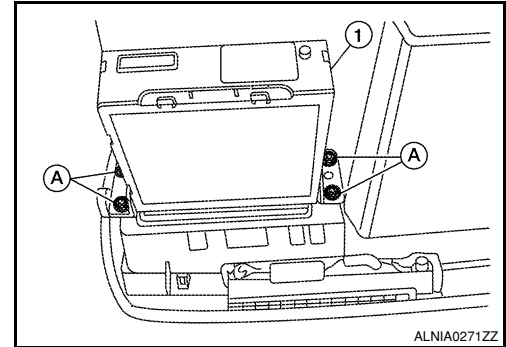

#### INSTALLATION

Installation is in the reverse order of removal.



## DVD ENTERTAINMENT SYSTEM

### Removal and Installation

INFOID:000000001346486

#### REMOVAL

1. Remove rear roof console. Refer to [INT-16. "Removal and Installation"](#).
2. Disconnect video monitor connector.
3. Remove video monitor housing.

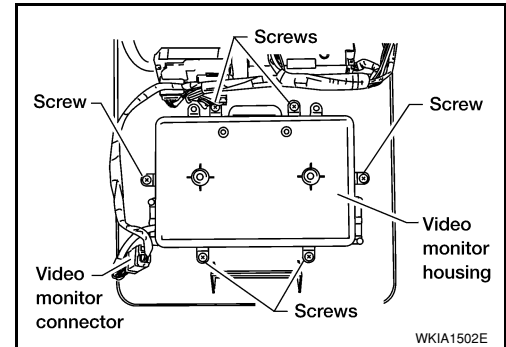

4. Remove video monitor hinge screws.
5. Remove video monitor.

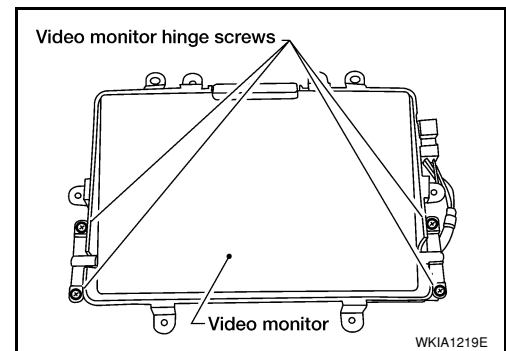

#### INSTALLATION

Installation is in reverse order of removal.

A  
B  
C  
D  
E  
F  
G  
H  
I  
J  
K  
L  
M  
N  
O  
P

AV

# AUDIO ANTENNA

< ON-VEHICLE REPAIR >

[BASE AUDIO]

## AUDIO ANTENNA

### Location of Antennas

INFOID:000000001297346

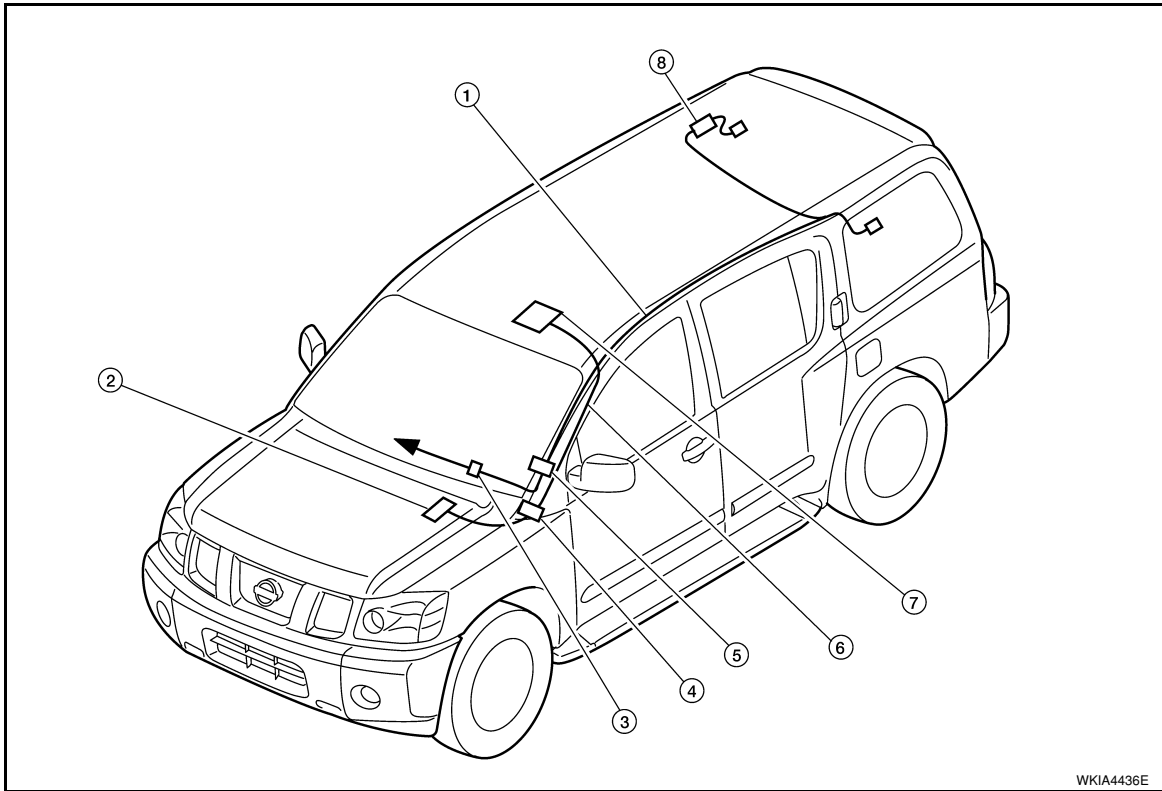

WKIA4436E

- |  |                          |                             |
|--|--------------------------|-----------------------------|
| 1. Antenna Feeder  | 2. Satellite radio tuner | 3. M48, M501                |
| 4. M68, M350   | 5. M502, M604            | 6. Satellite antenna feeder |
| 7. Satellite antenna (if equipped, factory installed) M351 | 8. Antenna amp           |                             |
- ← To audio unit

### Window Antenna Repair

INFOID:000000001297348

#### ELEMENT CHECK

1. Attach probe circuit tester (ohm setting) to antenna terminal on each side.

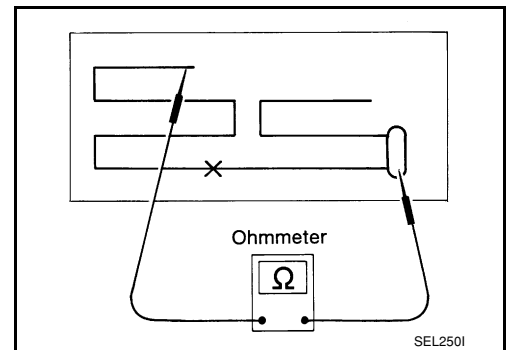

# AUDIO ANTENNA

< ON-VEHICLE REPAIR >

[BASE AUDIO]

- When measuring continuity, wrap tin foil around the top of probe. Then, press the foil against the wire with your finger.

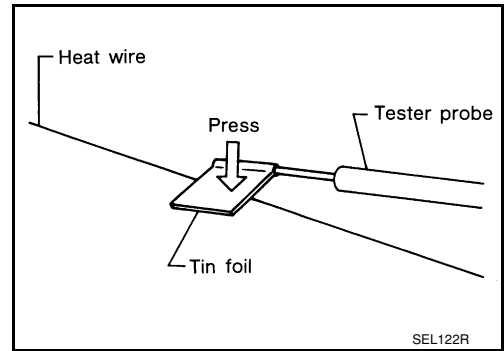

2. If an element is broken, no continuity will exist.

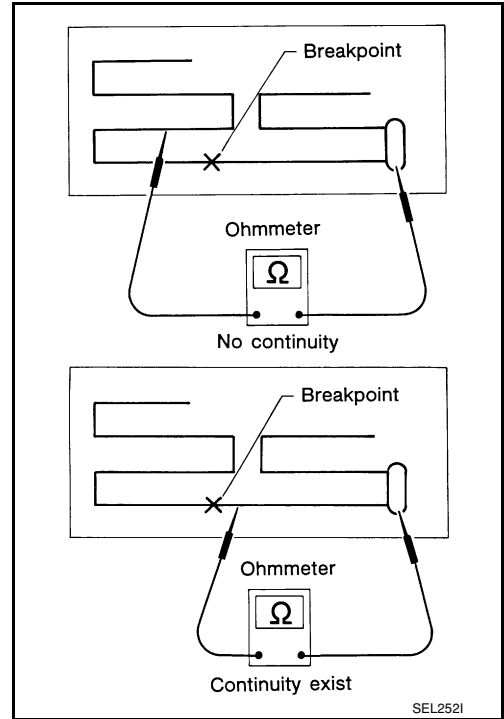

3. To locate a break, move probe along element. Tester indication will change abruptly when probe passes the broken point.

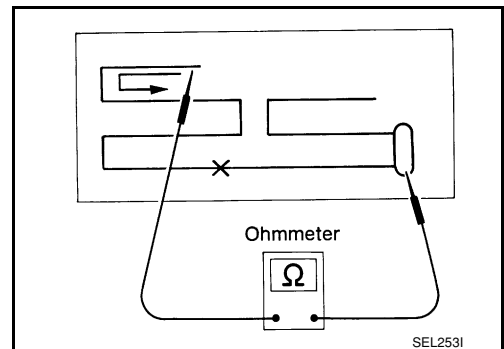

## ELEMENT REPAIR

Refer to [DEF-38. "Inspection and Repair"](#).

A  
B  
C  
D  
E  
F  
G  
H  
I  
J  
K  
L  
M  
AV  
O  
P

## SATELLITE RADIO ANTENNA

### Removal and Installation

INFOID:000000001341850

#### REMOVAL

1. Lower the headliner. Refer to [INT-16. "Removal and Installation"](#).
2. Disconnect the satellite radio antenna connector.
3. Remove the satellite radio antenna nut.
4. Remove the satellite radio antenna.

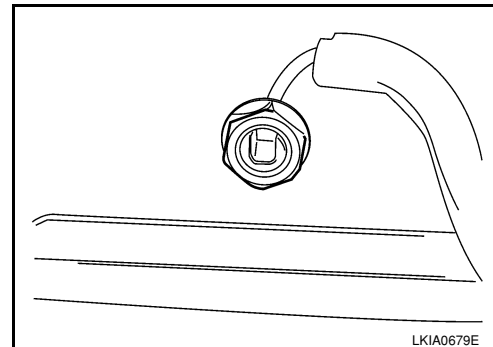

LKIA0679E

#### INSTALLATION

Installation is in the reverse order of removal.

# SATELLITE RADIO TUNER

< ON-VEHICLE REPAIR >

[BASE AUDIO]

## SATELLITE RADIO TUNER

### Removal and Installation

INFOID:000000001341849

#### REMOVAL

1. Remove the accelerator pedal. Refer to [ACC-3, "Removal and Installation"](#).
2. Remove the BCM. Refer to [BCS-54, "Removal and Installation"](#).
3. Disconnect the satellite radio tuner connectors.
4. Remove the satellite radio tuner bracket screws and slide the satellite radio tuner bracket down.

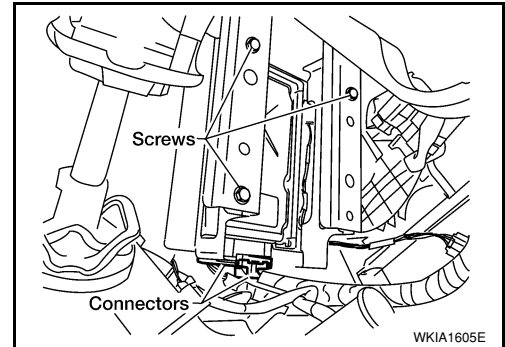

5. Remove the satellite radio tuner screws (A).
6. Remove the satellite radio tuner from satellite radio tuner bracket (1).

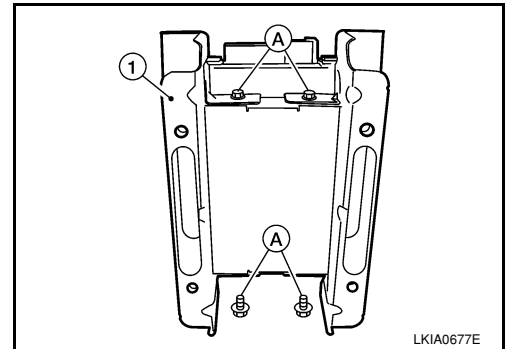

#### INSTALLATION

Installation is in the reverse order of removal.

A  
B  
C  
D  
E  
F  
G  
H  
I  
J  
K  
L  
M  
AV  
O  
P

## BASIC INSPECTION

### DIAGNOSIS AND REPAIR WORKFLOW

#### Work Flow

INFOID:000000001278729

#### OVERALL SEQUENCE

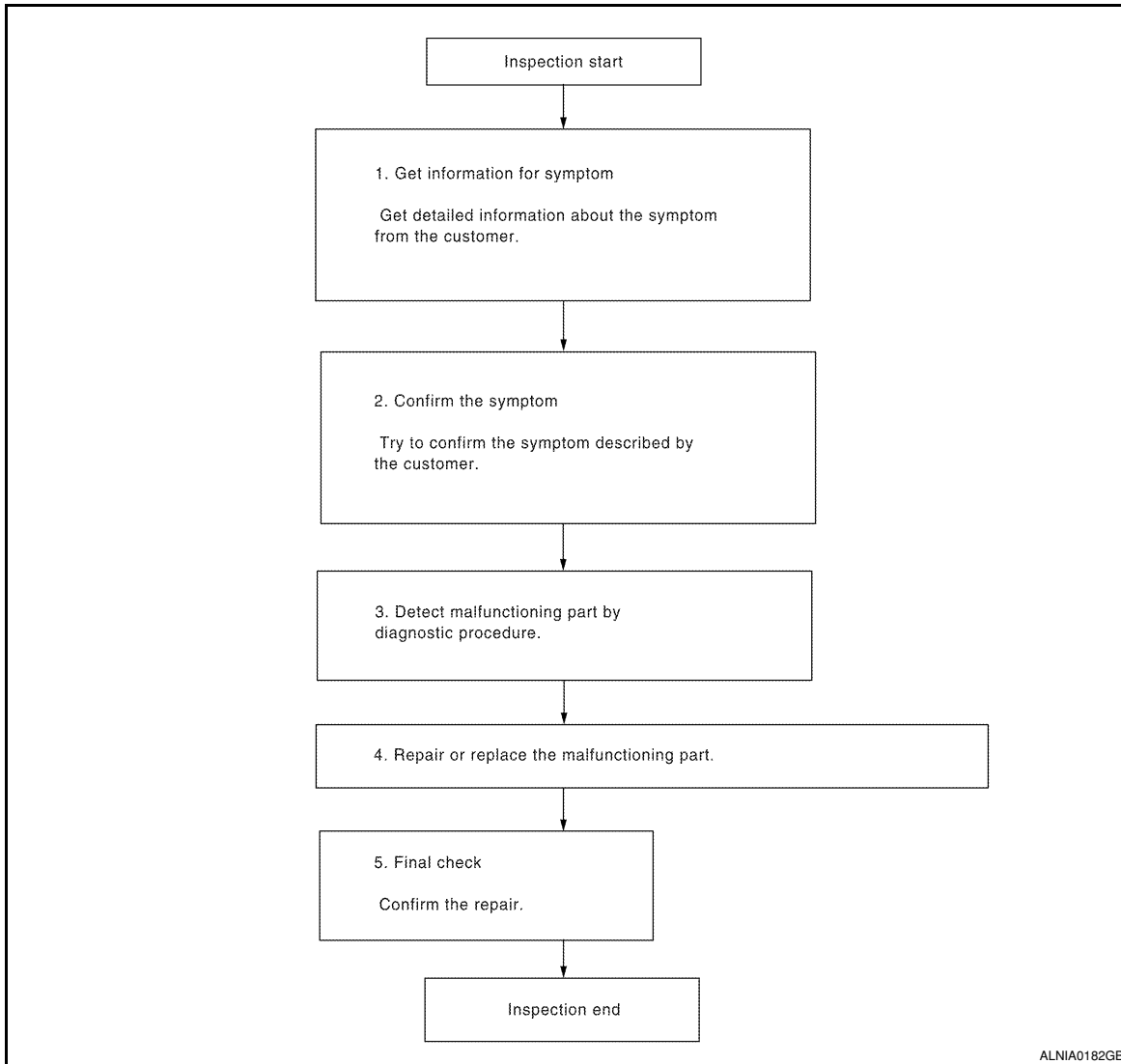

#### DETAILED FLOW

### 1.GET INFORMATION FOR SYMPTOM

Get detailed information from the customer about the symptom (the condition and the environment when the incident/malfunction occurred).

>> GO TO 2

### 2.CONFIRM THE SYMPTOM

Try to confirm the symptom described by the customer. Verify relation between the symptom and the condition when the symptom is detected.

>> GO TO 3

### 3.DETECT MALFUNCTIONING PART BY DIAGNOSTIC PROCEDURE

Inspect according to Diagnostic Procedure of the system.

# DIAGNOSIS AND REPAIR WORKFLOW

[BOSE AUDIO WITHOUT NAVIGATION]

< BASIC INSPECTION >

Is malfunctioning part detected?

YES >> GO TO 4

NO >> GO TO 2

## 4.REPAIR OR REPLACE THE MALFUNCTIONING PART

1. Repair or replace the malfunctioning part.
2. Reconnect parts or connectors disconnected during Diagnostic Procedure.

>> GO TO 5

## 5.FINAL CHECK

Refer to confirmed symptom in step 2, and make sure that the symptom is not detected.

Was the repair confirmed?

YES >> Inspection End.

NO >> GO TO 2

A

B

C

D

E

F

G

H

I

J

K

L

M

AV

O

P

## INSPECTION AND ADJUSTMENT

### REAR VIEW MONITOR GUIDING LINE ADJUSTMENT

#### REAR VIEW MONITOR GUIDING LINE ADJUSTMENT : Description

INFOID:000000001677654

This mode is used to modify the side distance guidelines if they are dislocated from the rear view monitor image, because of variations of body/camera mounting conditions.

#### REAR VIEW MONITOR GUIDING LINE ADJUSTMENT : Special Repair Requirement

INFOID:000000001677655

1. Create a correction line to modify the screen.  
 Draw lines on the rearward of the vehicle passing through the following points: 200 mm (7.87 inch) from both sides of the vehicle, and
  - \*1: 0.5 m (1.5 feet)
  - \*2: 1 m (3 feet)
  - \*3: 2 m (7 feet)
  - \*4: 3 m (10 feet)
 and from the rear end of the bumper
2. With the ignition switch OFF, connect CONSULT-III, then turn ignition switch ON. Select "REARVIEW CAMERA".

**CAUTION:**

**Stop engine for safety when correcting side distance guideline.**

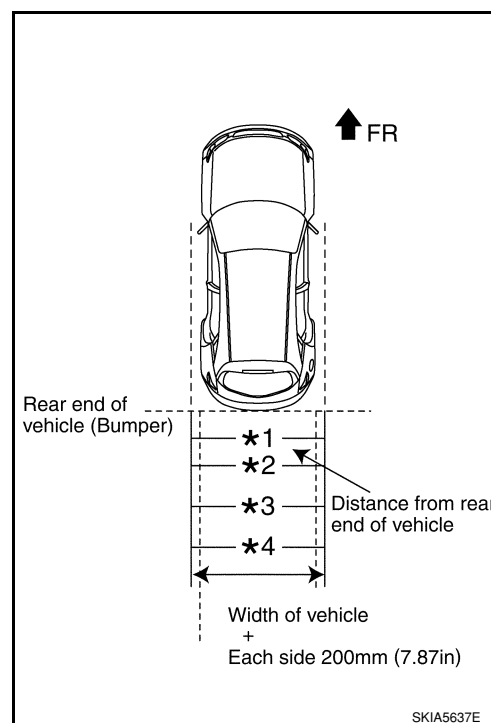

3. Shift the A/T selector lever to R position.

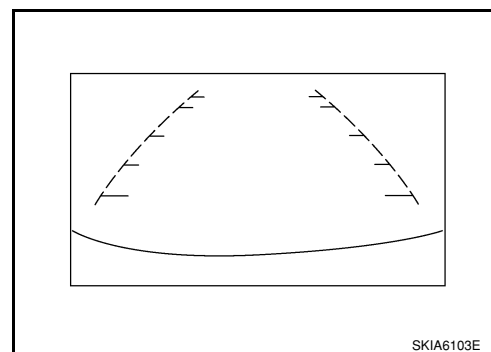

4. Touch "SELCT GUIDELINE PATTERN" under "WORK SUPPORT" menu.
5. Touch "UP" or "DOWN", and select the guide line, "PATTERN NO. 0" or "PATTERN NO. 1", which is the closest to the corrected line.
6. Touch "SAVE", and confirm the guide line.
7. Touch "END".
8. Touch "ADJ GUIDELINE POSITION" under the "WORK SUPPORT" menu.
9. Adjust the guide line touching "X UP", "X DOWN", "Y UP" or "Y DOWN" so that the corrected line can fit the guide line.
10. Touch "SAVE", and confirm the guide line.



# INSPECTION AND ADJUSTMENT

< BASIC INSPECTION >

[BOSE AUDIO WITHOUT NAVIGATION]

---

11. Touch "END" to finish correcting.

A

B

C

D

E

F

G

H

I

J

K

L

M

**AV**

O

P

FUNCTION DIAGNOSIS

AUDIO SYSTEM

System Diagram

INFOID:000000001278730

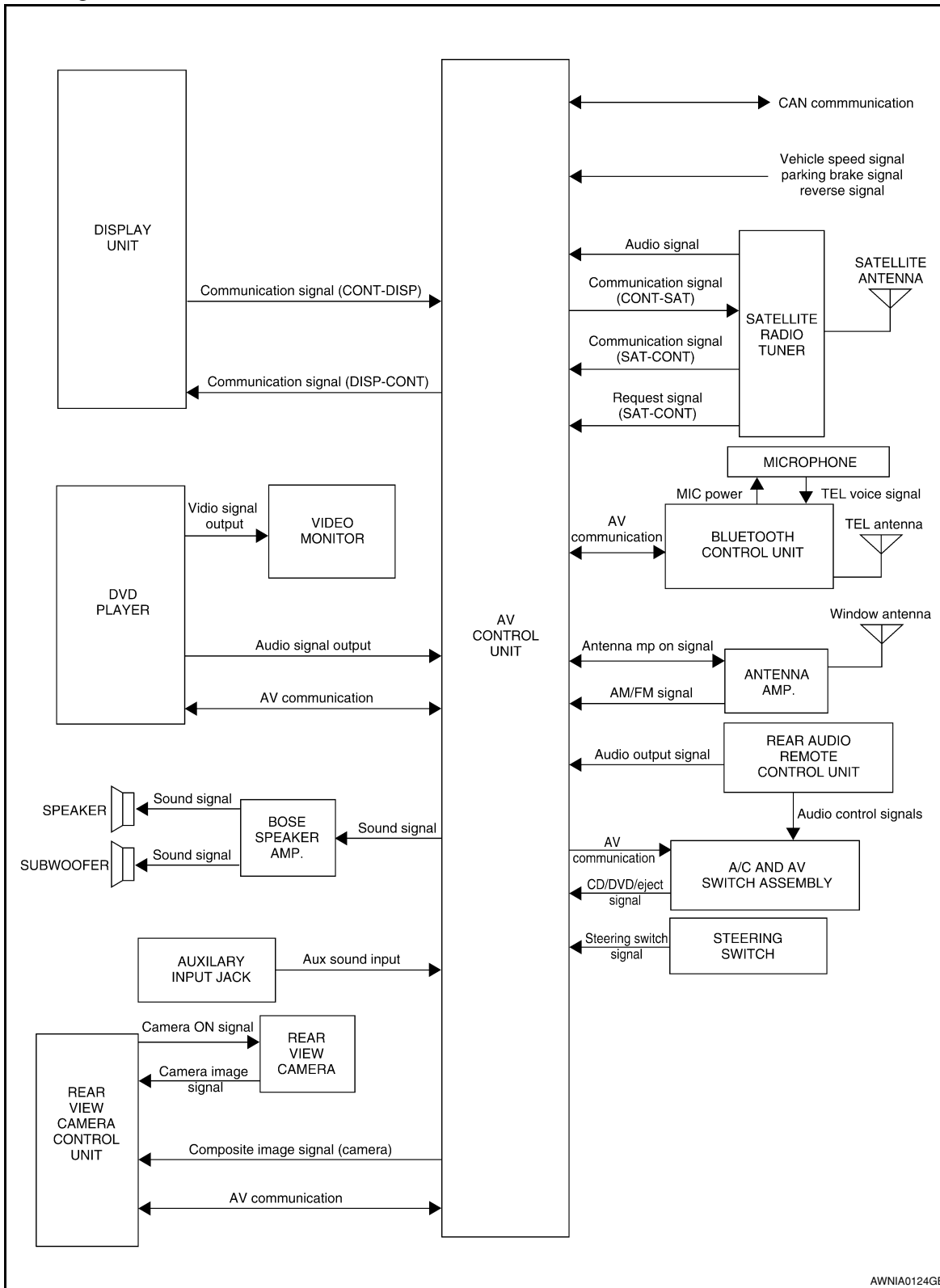

AWNIA0124GE

System Description

INFOID:000000001278731

AUDIO SYSTEM

# AUDIO SYSTEM

< FUNCTION DIAGNOSIS >

[BOSE AUDIO WITHOUT NAVIGATION]

The audio system consists of the following components

- AV control unit
- Display unit
- BOSE speaker amp.
- Window antenna
- Steering switches
- A/C and AV switch assembly
- Rear audio and remote control unit
- Front door speakers
- Front tweeters
- Center speaker
- Rear door speakers
- Rear door tweeters
- Back door speakers
- Subwoofer

When the audio system is on, radio signals are received by the window antenna. The AV control unit then sends audio signals to the BOSE speaker amp. The BOSE speaker amp. amplifies the audio signals before sending them to the front door speakers, front tweeters, center speaker, rear door speakers, rear door tweeters, back door speakers and the subwoofer.

Refer to Owner's Manual for audio system operating instructions.

## SATELLITE RADIO SYSTEM

The satellite radio system consists of the following components

- Satellite antenna
- Satellite radio tuner

When the satellite radio system is on, radio signals are supplied to the satellite radio tuner from the satellite antenna. The satellite radio tuner then sends audio signals to the AV control unit.

Refer to Owner's Manual for satellite radio system operating instructions.

## SPEED SENSITIVE VOLUME SYSTEM

Volume level of this system goes up and down automatically in proportion to the vehicle speed. The control level can be selected by the customer. Refer to Owner's Manual for operating instructions.

A

B

C

D

E

F

G

H

I

J

K

L

M

AV

O

P

# AUDIO SYSTEM

< FUNCTION DIAGNOSIS >

[BOSE AUDIO WITHOUT NAVIGATION]

## Component Parts Location

INFOID:000000001278732

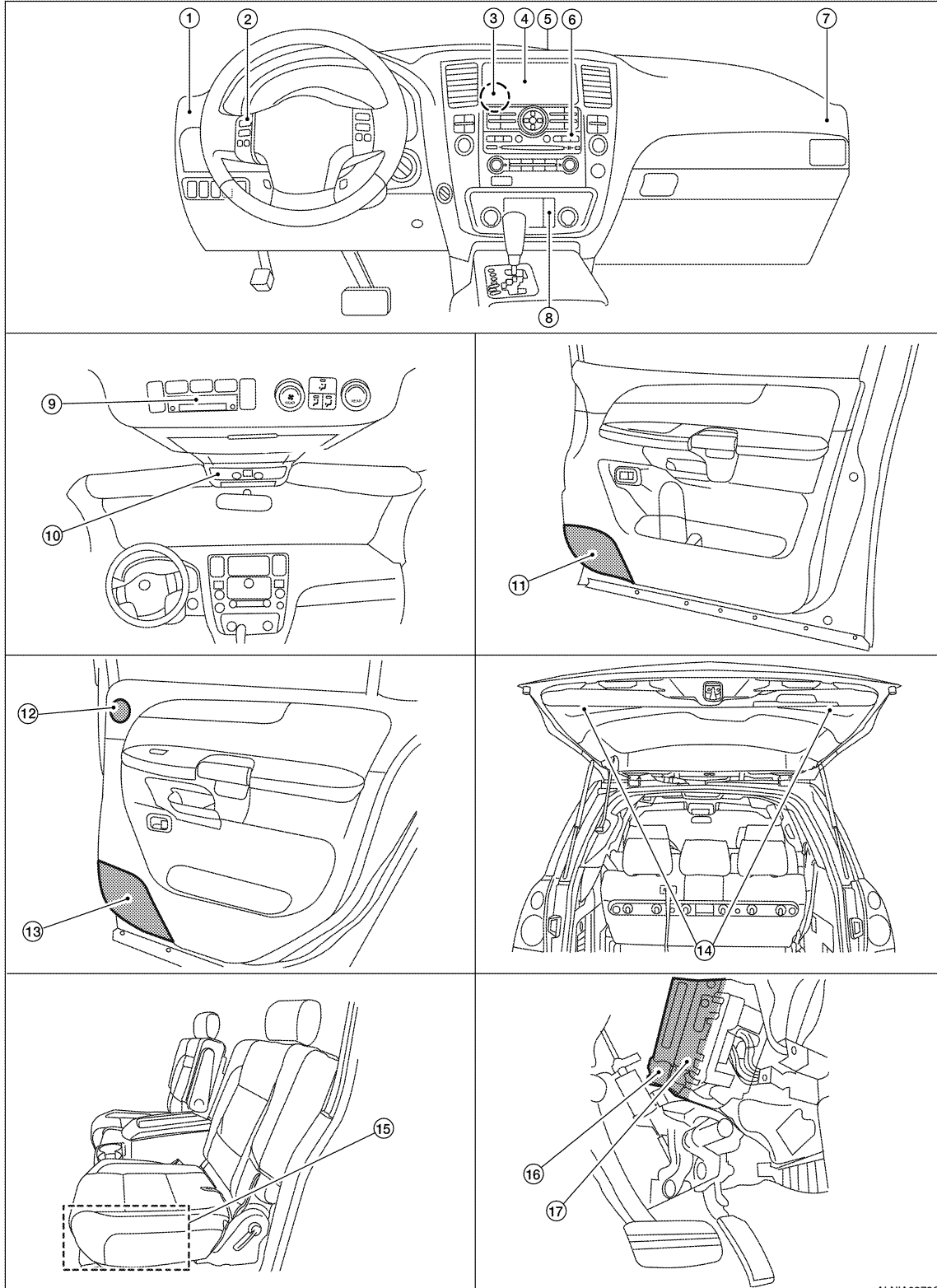

ALNIA0373GB

# AUDIO SYSTEM

< FUNCTION DIAGNOSIS >

[BOSE AUDIO WITHOUT NAVIGATION]

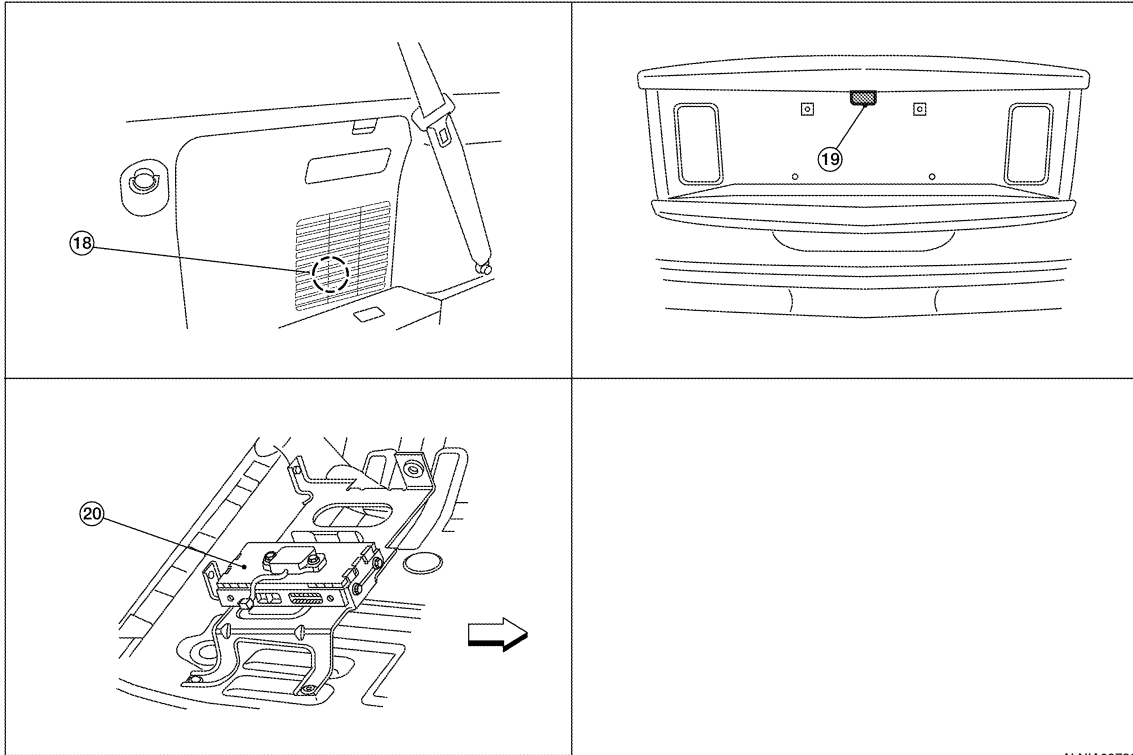

ALNIA0372GB

← :FRONT

- |  |   |  |
|--|---|--|
| 1. Front tweeter LH M109   | 2. Steering wheel audio control switches  | 3. AV control unit M42, M43, M44, M45, M46, M72, M101                      |
| 4. Display unit M93  | 5. Center speaker M110  | 6. A/C and AV switch assembly M98  |
| 7. Front tweeter RH M111   | 8. Aux jack M104  | 9. Rear audio and remote control unit R204                                 |
| 10. Microphone R108 (with Bluetooth)   | 11. Front door speaker LH D12<br>RH D112  | 12. Rear door tweeter LH D208<br>RH D308                                   |
| 13. Rear door speaker LH D207<br>RH D307   | 14. Back door speaker LH D518<br>RH D716  | 15. Subwoofer B72 (under driver's seat)                                    |
| 16. BOSE speaker amp M112, M113 (view behind instrument panel above accelerator pedal) | 17. Satellite radio tuner M41, M129   | 18. Rear camera control unit B73 (located behind luggage side finisher LH) |
| 19. Rear view camera   | 20. Bluetooth control unit B141, B142 (with Bluetooth) (view with passenger front seat removed) |  |

## Component Description

INFOID:000000001278733

AV

Part name	Description
AV control unit	Controls audio system and satellite radio system functions
Display unit	Displays all audio and climate control related information
BOSE speaker amp.	Receives power (amp ON) and audio signals from audio unit and outputs audio signals to each speaker.
Steering switches	<ul style="list-style-type: none"> <li>Audio operation can be operated</li> <li>Steering switch signal is output to audio unit</li> </ul>
Front door speakers	<ul style="list-style-type: none"> <li>Outputs audio signal from BOSE speaker amp.</li> <li>Outputs high, mid and low range sounds</li> </ul>

## AUDIO SYSTEM

< FUNCTION DIAGNOSIS >

[BOSE AUDIO WITHOUT NAVIGATION]

Part name	Description
Front tweeters	<ul style="list-style-type: none"><li>• Outputs audio signal from BOSE speaker amp.</li><li>• Outputs high range sounds</li></ul>
Center speaker	<ul style="list-style-type: none"><li>• Outputs audio signal from BOSE speaker amp.</li><li>• Outputs high range sounds</li></ul>
Rear door speakers	<ul style="list-style-type: none"><li>• Outputs audio signal from BOSE speaker amp.</li><li>• Outputs high, mid and low range sounds</li></ul>
Rear door tweeters	<ul style="list-style-type: none"><li>• Outputs audio signal from BOSE speaker amp.</li><li>• Outputs high range sounds</li></ul>
Back door speakers	<ul style="list-style-type: none"><li>• Outputs audio signal from BOSE speaker amp.</li><li>• Outputs high, mid and low range sounds</li></ul>
Subwoofer	<ul style="list-style-type: none"><li>• Outputs audio signal from BOSE speaker amp.</li><li>• Outputs low range sounds</li></ul>
Satellite radio tuner	<ul style="list-style-type: none"><li>• Receives radio signals from satellite antenna</li><li>• Sends audio signals to AV control unit</li></ul>
Satellite antenna	Audio signal (satellite radio) is received and output to AV control unit.

# REAR VIEW MONITOR SYSTEM

< FUNCTION DIAGNOSIS >

[BOSE AUDIO WITHOUT NAVIGATION]

## REAR VIEW MONITOR SYSTEM

### System Diagram

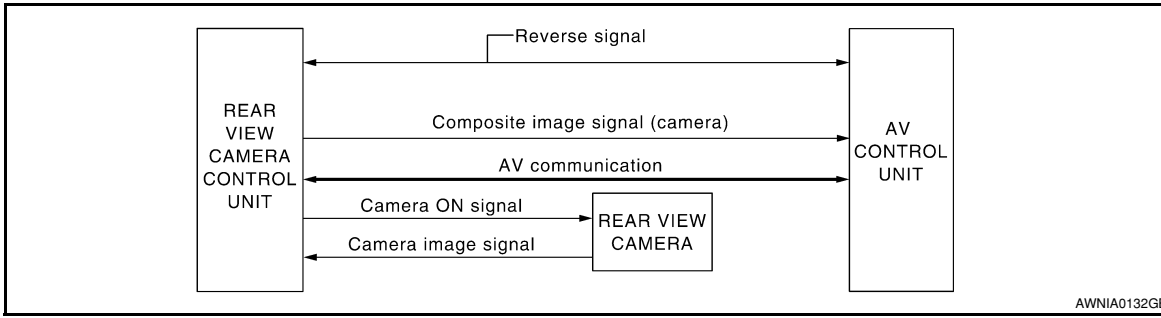

### System Description

INFOID:000000001346477

When the selector is in the R position, the display shows a view to the rear of the vehicle. Lines which indicate the vehicle clearance and distances are also displayed.

#### AV COMMUNICATION LINE

The rear view camera control unit is connected to the AV control unit using an AV communication line. This line is used to transmit and receive data.

### Component Parts Location

INFOID:000000001346478

Refer to [AV-124, "Component Parts Location"](#).

### Component Description

INFOID:000000001346479

Part name	Description
AV control unit	Camera image signal is sent from rear view camera control unit
Rear view camera control unit	<ul style="list-style-type: none"> <li>• Receives reverse signal from back-up lamp relay</li> <li>• Receives rear view camera image signal</li> <li>• Sends camera ON signal to rear view camera</li> <li>• Sends image signal to AV control unit</li> </ul>
Rear view camera	<ul style="list-style-type: none"> <li>• Receives camera ON signal from rear view camera control unit</li> <li>• Sends image signal to rear view camera control unit</li> </ul>

A  
B  
C  
D  
E  
F  
G  
H  
I  
J  
K  
L  
M  
O  
P

AV

# DVD PLAYER

< FUNCTION DIAGNOSIS >

[BOSE AUDIO WITHOUT NAVIGATION]

## DVD PLAYER

### System Diagram

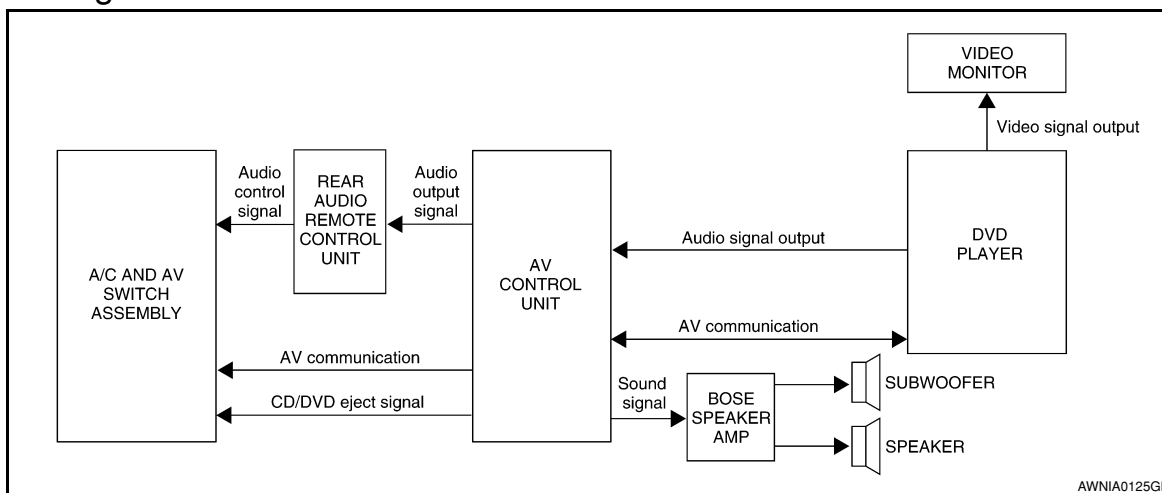

### System Description

INFOID:000000001316577

The DVD entertainment system consists of the following components

- AV control unit
- DVD player
- Video monitor
- A/C and AV switch assembly
- Steering wheel audio control switches
- Rear audio remote control unit
- BOSE speaker amp.
- Front tweeters
- Front door speakers
- Center speaker
- Rear door tweeters
- Rear door speakers
- Back door speakers
- Subwoofer

When the DVD entertainment system is on, video signals are sent from the DVD player to the video monitor. Audio signals are sent to the AV control unit. Audio signals can be directed through wired or wireless infrared headphones or through the BOSE speaker amp. to the vehicle speakers. Refer to the Owner's Manual for complete DVD entertainment system operating instructions.



# DVD PLAYER

< FUNCTION DIAGNOSIS >

[BOSE AUDIO WITHOUT NAVIGATION]

## Component Parts Location

INFOID:000000001316578

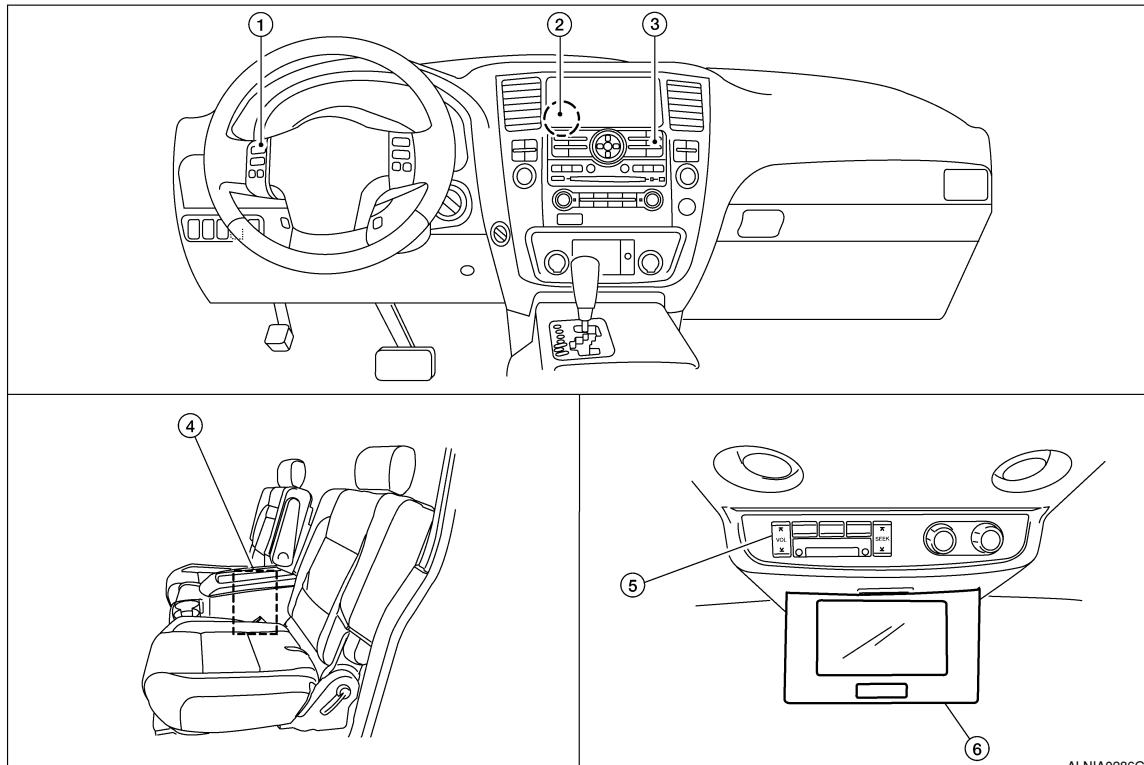

- |  |   |                                   |
|--|---|-----------------------------------|
| 1. Steering wheel audio control switches       | 2. AV control unit M42, M43, M44, M45, M46, M72, M101 | 3. A/C and AV switch assembly M98 |
| 4. DVD player M205 (located in center console) | 5. Rear audio remote control unit R204                | 6. Video monitor R202             |

## Component Description

INFOID:000000001316579

Part name	Description
DVD player	<ul style="list-style-type: none"> <li>Outputs DVD video to video monitor</li> <li>Outputs DVD audio to the AV control unit</li> </ul>
Video monitor	<ul style="list-style-type: none"> <li>Receives and displays the DVD video signal</li> </ul>
AV control unit	<ul style="list-style-type: none"> <li>Controls audio system and DVD entertainment system functions</li> </ul>
BOSE speaker amp.	<ul style="list-style-type: none"> <li>Receives audio signals from the AV control unit</li> <li>Outputs amplified audio signals to the speakers</li> </ul>
A/C and AV switch assembly	<ul style="list-style-type: none"> <li>All audio and A/C operations can be operated</li> <li>Switch signal is output to the AV control unit and A/C auto amp</li> </ul>
Rear audio remote control unit	<ul style="list-style-type: none"> <li>Audio and DVD functions can be operated</li> <li>Switch signal is output to the AV control unit</li> <li>Receives audio signal from AV control unit for headphones</li> </ul>
Steering wheel audio control switches	<ul style="list-style-type: none"> <li>Audio operation can be operated</li> <li>Steering switch signal (operation signal) is output to AV control unit</li> </ul>
Front door speakers	<ul style="list-style-type: none"> <li>Outputs audio signal from BOSE speaker amp.</li> <li>Outputs high, mid and low range sounds</li> </ul>
Front tweeters	<ul style="list-style-type: none"> <li>Outputs audio signal from BOSE speaker amp.</li> <li>Outputs high range sounds</li> </ul>
Center speaker	<ul style="list-style-type: none"> <li>Outputs audio signal from BOSE speaker amp.</li> <li>Outputs high, mid and low range sounds</li> </ul>

## DVD PLAYER

< FUNCTION DIAGNOSIS >

[BOSE AUDIO WITHOUT NAVIGATION]

Part name	Description
Rear door tweeters	<ul style="list-style-type: none"><li>• Outputs audio signal from BOSE speaker amp.</li><li>• Outputs high range sounds</li></ul>
Rear door speakers	<ul style="list-style-type: none"><li>• Outputs audio signal from BOSE speaker amp.</li><li>• Outputs high, mid and low range sounds</li></ul>
Back door speakers	<ul style="list-style-type: none"><li>• Outputs audio signal from BOSE speaker amp.</li><li>• Outputs high, mid and low range sounds</li></ul>
Subwoofer	<ul style="list-style-type: none"><li>• Outputs audio signal from BOSE speaker amp.</li><li>• Outputs low range sounds</li></ul>

# HANDS-FREE PHONE SYSTEM

< FUNCTION DIAGNOSIS >

[BOSE AUDIO WITHOUT NAVIGATION]

## HANDS-FREE PHONE SYSTEM

### System Diagram

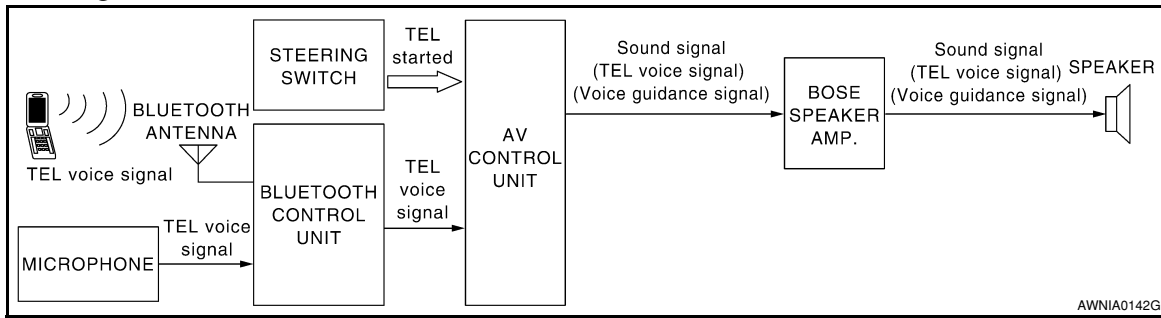

### System Description

Refer to the Owner's Manual for Bluetooth telephone system operating instructions.

#### NOTE:

Cellular telephones must have their wireless connection set up (paired) before using the Bluetooth telephone system.

Bluetooth telephone system allows users who have a Bluetooth equipped cellular telephone to make a wireless connection between their cellular telephone and the Bluetooth control unit. Hands-free cellular telephone calls can be sent and received. Personal memos can be created using the Nissan Voice Recognition system. Some Bluetooth cellular telephones may not be recognized by the Bluetooth control unit. When a cellular telephone or the Bluetooth control unit is replaced, the telephone must be paired with the Bluetooth control unit. Different cellular telephones may have different pairing procedures. Refer to the cellular telephone operating manual.

#### BLUETOOTH CONTROL UNIT

When the ignition switch is turned to ACC or ON, the Bluetooth control unit will power up. During power up, the Bluetooth control unit is initialized and performs various self checks. Initialization may take up to 10 seconds. If a phone is present in the vehicle and paired with the Bluetooth control unit, Nissan Voice Recognition will then become active. Bluetooth telephone functions can be turned off using the Nissan Voice Recognition system.

#### STEERING WHEEL AUDIO CONTROL SWITCHES

When buttons on the steering wheel audio control switch are pushed, the resistance in steering wheel audio control switch circuit changes depending on which button is pushed. The Bluetooth control unit uses this signal to perform various functions while navigating through the voice recognition system.

The following functions can be performed using the steering wheel audio control switch:

- Initiate Self Diagnosis of the Bluetooth telephone system
- Start a voice recognition session
- Answer and end telephone calls
- Adjust the volume of calls
- Record memos

#### MICROPHONE

The microphone is located in the roof console assembly. The microphone sends a signal to the Bluetooth control unit. The microphone can be actively tested during self-diagnosis.

#### AV CONTROL UNIT

The AV control unit receives signals from the Bluetooth control unit and sends audio signals to the BOSE speaker amp. then on to the speakers.

### Component Parts Location

Refer to [AV-124. "Component Parts Location"](#).

A  
B  
C  
D  
E  
F  
G  
H  
I  
J  
K  
L  
M  
O  
P

AV

# HANDS-FREE PHONE SYSTEM

[BOSE AUDIO WITHOUT NAVIGATION]

< FUNCTION DIAGNOSIS >

## Component Description

INFOID:000000001316583

Part name	Description
AV control unit	<ul style="list-style-type: none"><li>• Receives telephone voice signal from Bluetooth control unit</li><li>• Sends telephone voice and voice guidance signals to the speakers</li></ul>
BOSE speaker amp.	<ul style="list-style-type: none"><li>• Receives audio signals from the AV control unit</li><li>• Outputs amplified audio signals to the speakers.</li></ul>
Front door speaker	Receives telephone voice and voice guidance signals from the audio unit
Front tweeter	
Center speaker	
Steering switches	<ul style="list-style-type: none"><li>• Start a voice recognition session</li><li>• Answer and end telephone calls</li><li>• Adjust the volume level</li></ul>
Microphone	Sends voice signals to Bluetooth control unit
Bluetooth control unit	Controls hands-free phone functions
Bluetooth antenna	Sends telephone voice signal to Bluetooth control unit

# DIAGNOSIS SYSTEM (AV CONTROL UNIT)

< FUNCTION DIAGNOSIS >

[BOSE AUDIO WITHOUT NAVIGATION]

## DIAGNOSIS SYSTEM (AV CONTROL UNIT)

### AV CONTROL UNIT

#### AV CONTROL UNIT : Diagnosis Description

INFOID:000000001316584

#### DESCRIPTION

- Diagnosis function consists of the “Self-Diagnosis” mode performed automatically and the “Confirmation/Adjustment” mode operated manually.
- “Self-Diagnosis” mode checks for connections between the units constituting this system, analyzes each individual unit at the same time, and displays the results on the LCD screen.
- “Confirmation/Adjustment” mode is used to perform trouble diagnosis that requires operation and judgment by an operator (trouble that cannot be automatically judged by the system), to check/change the set value, and to display the error history of the AV control unit.

#### DIAGNOSIS ITEM

Mode		Description	
Self-diagnosis		<ul style="list-style-type: none"> <li>• AV control unit diagnosis</li> <li>• Analyzes connection between the AV control unit, front display, Bluetooth, DVD deck, Satellite tuner, switches and rear view camera control unit.</li> </ul>	
CONFIRMATION/ ADJUSTMENT	Display diagnosis	Color spectrum bar	Color tone of the screen can be checked by the display of a color bar.
		Gradation bar	Shading of the screen can be checked by the display of a gray scale.
	Vehicle signals		The following vehicle signals are analyzed: Vehicle speed signal, parking brake signal, light signal, ignition switch signal, and reverse signal.
	Speaker test		Connection can be checked by sending a test tone to each speaker.
	Climate control		Start automatic air conditioner self test.
	Error history		Diagnosis results previously stored in the memory are displayed in this mode.
	Vehicle CAN diagnosis		The transmitting/receiving of CAN communication can be monitored.
	AV COMM diagnosis		The transmitting/receiving of AV communication can be monitored.
	Delete unit connection log		Erase the error history and connection history of the unit.
	Initialize settings		All audio settings are reset to default levels.

#### OPERATION PROCEDURE

1. Start the engine.
2. Turn the audio system off.
3. While pressing the “SETTING” button, turn the volume control dial counterclockwise 30 clicks or more. (When the self-diagnosis mode is started, a short beep will be heard.)

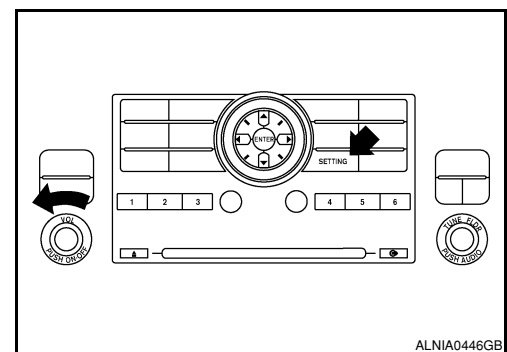

A  
B  
C  
D  
E  
F  
G  
H  
I  
J  
K  
L  
M  
AV  
O  
P

# DIAGNOSIS SYSTEM (AV CONTROL UNIT)

[BOSE AUDIO WITHOUT NAVIGATION]

< FUNCTION DIAGNOSIS >

- The initial trouble diagnosis screen will be displayed, and items “Self-Diagnosis” and “Confirmation/Adjustment” can be selected.

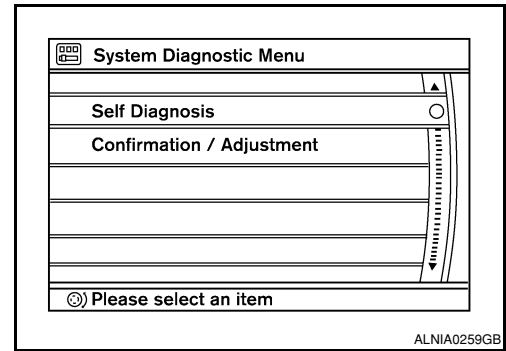

## SELF-DIAGNOSIS

- Perform self-diagnosis by selecting “Self-Diagnosis”.
  - Self-diagnosis subdivision screen is displayed, and the self-diagnosis mode starts.
  - A bar graph visible on the center of the self-diagnosis subdivision screen indicates progress of the trouble diagnosis.

**NOTE:**

Self-diagnosis requires approximately 10 seconds to complete.

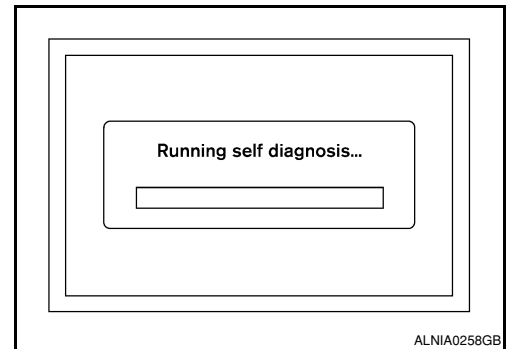

- Diagnosis results are displayed after the self-diagnosis is completed. The unit names and the connection lines are color-coded according to the diagnostic results.

Diagnosis results	Unit	Connection line
Normal	Green	Green
Connection malfunction	Gray	Yellow
Unit malfunction <sup>Note</sup>	Red	Green

Note:

- Only the AV control unit is displayed in red.
- If multiple malfunctions occur at the same time for a single unit, the screen switch colors are determined according to the following order of priority: red > yellow > gray.

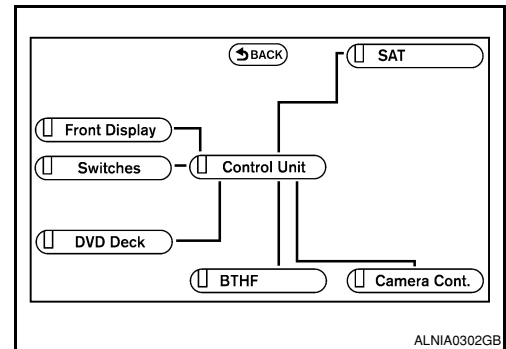

- Select a component on the “Self-Diagnosis” screen and comments for the diagnosis results will be shown.

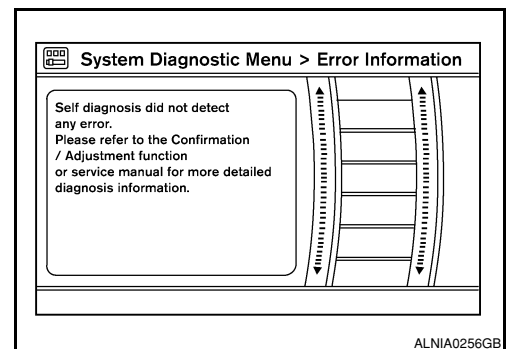

Self-Diagnosis Results

# DIAGNOSIS SYSTEM (AV CONTROL UNIT)

< FUNCTION DIAGNOSIS >

[BOSE AUDIO WITHOUT NAVIGATION]

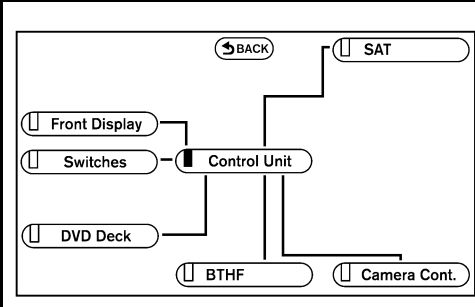
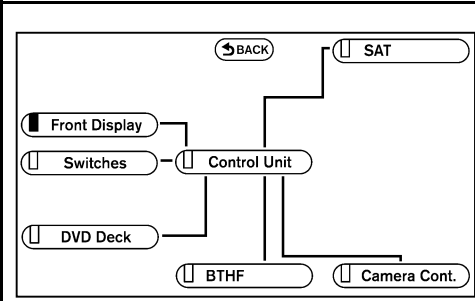
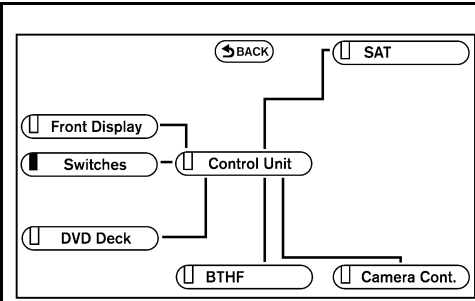
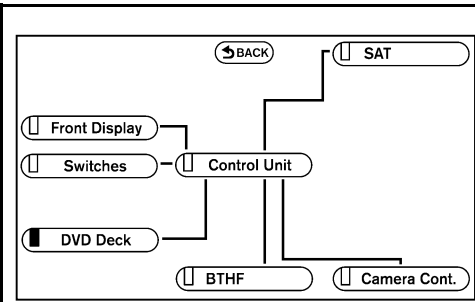
Area with yellow connection lines	Description	Possible malfunction location / Action to take
 <p>ALNIA0303GB</p>	<p>AV control unit malfunction is detected</p>	<p>Replace the AV control unit. Refer to <a href="#">AV-259. "Removal and Installation"</a>.</p>
 <p>ALNIA0304GB</p>	<p>Poor connection is detected for the display unit</p>	<ul style="list-style-type: none"> <li>• Harness or connector</li> <li>• AV control unit</li> <li>• Display unit</li> </ul>
 <p>ALNIA0305GB</p>	<p>Switch malfunction is detected</p>	<p>Perform A/C and AV switch assembly diagnostics. Refer to <a href="#">AV-140. "A/C AND AV SWITCH ASSEMBLY : Component Function Check"</a></p>
 <p>ALNIA0306GB</p>	<p>Poor connection is detected for the DVD player.</p>	<ul style="list-style-type: none"> <li>• Harness or connector</li> <li>• AV control unit</li> <li>• DVD player</li> </ul>

A  
B  
C  
D  
E  
F  
G  
H  
I  
J  
K  
L  
M  
O  
P

AV

# DIAGNOSIS SYSTEM (AV CONTROL UNIT)

< FUNCTION DIAGNOSIS >

[BOSE AUDIO WITHOUT NAVIGATION]

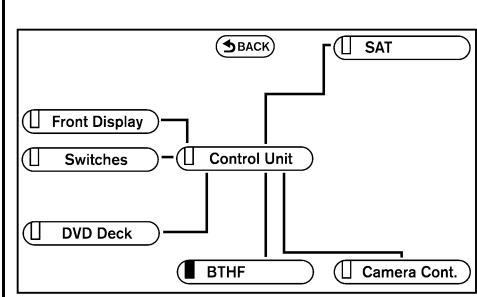
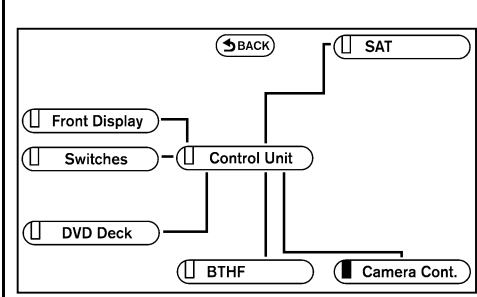
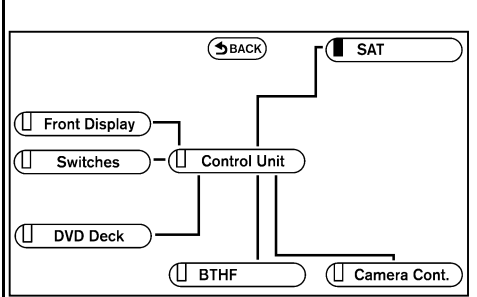
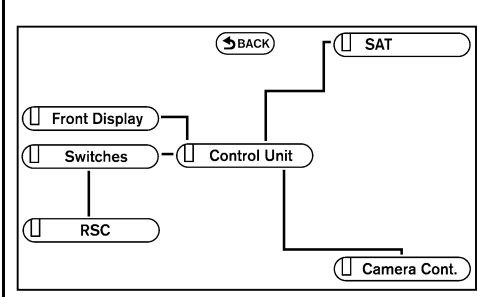
Area with yellow connection lines	Description	Possible malfunction location / Action to take
 <p style="text-align: right; font-size: small;">ALNIA0307GB</p>	<p>Poor connection is detected for the Bluetooth control unit</p>	<ul style="list-style-type: none"> <li>• Harness or connector</li> <li>• AV control unit</li> <li>• Bluetooth control unit</li> </ul>
 <p style="text-align: right; font-size: small;">ALNIA0308GB</p>	<p>Poor connection is detected for the rear camera control unit.</p>	<ul style="list-style-type: none"> <li>• Harness or connector</li> <li>• AV control unit</li> <li>• Rear camera control unit</li> </ul>
 <p style="text-align: right; font-size: small;">ALNIA0309GB</p>	<p>Poor connection is detected for the satellite radio tuner.</p>	<ul style="list-style-type: none"> <li>• Harness or connector</li> <li>• AV control unit</li> <li>• Satellite radio tuner</li> </ul>
 <p style="text-align: right; font-size: small;">ALNIA0656GB</p>	<p>Poor connection is detected for the rear audio remote control unit.</p>	<ul style="list-style-type: none"> <li>• Harness or connector</li> <li>• AV control unit</li> <li>• Rear audio remote control unit</li> </ul>

## CONFIRMATION/ADJUSTMENT MODE

1. Start the diagnosis function and select "Confirmation/Adjustment". The confirmation/adjustment mode indicates where each item can be checked or adjusted.



# DIAGNOSIS SYSTEM (AV CONTROL UNIT)

[BOSE AUDIO WITHOUT NAVIGATION]

< FUNCTION DIAGNOSIS >

2. Select each item on the “Confirmation/Adjustment” mode screen to display the relevant trouble diagnosis screen. Touch “BACK” on the display unit or press the “BACK” switch to return to the initial Confirmation/Adjustment Mode screen.

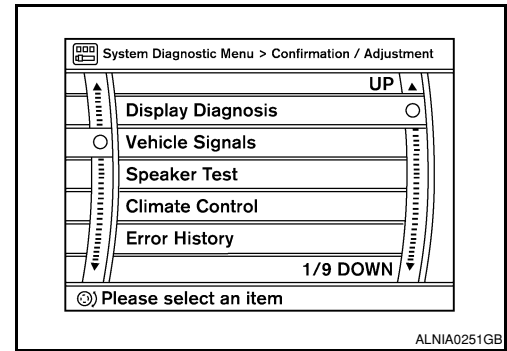

## Display Diagnosis

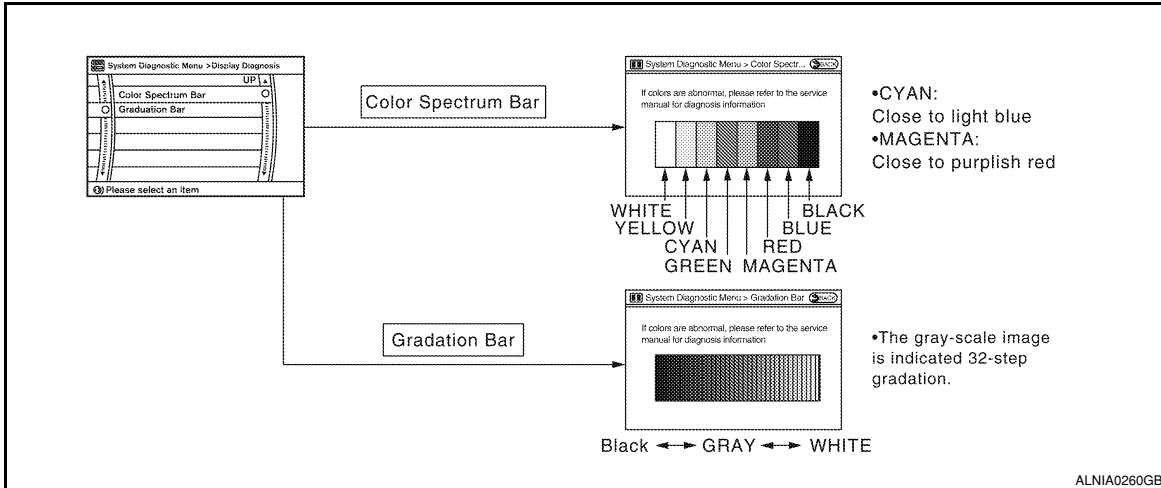

## Vehicle Signals

A comparison check can be made of each actual vehicle signal and the signals recognized by the system.

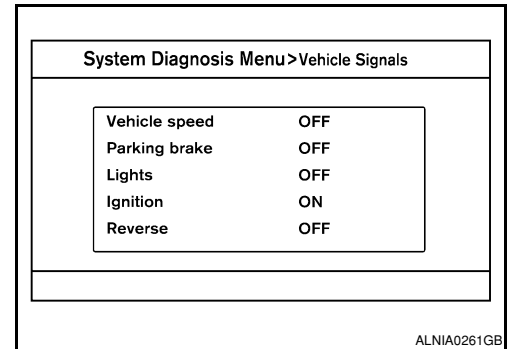

Diagnosis item	Display	Vehicle status	Remarks
Vehicle speed	ON	Vehicle speed > 0 km/h	Changes in indication may be delayed by approximately 1.5 seconds. This is normal.
	OFF	Vehicle speed = 0 km/h	
	—	Ignition switch in ACC position	
Parking brake	ON	Parking brake is applied.	
	OFF	Parking brake is released.	
Lights	ON	Light switch ON	Block the light beam from the auto light optical sensor.
	OFF	Light switch OFF	
Ignition	ON	Ignition switch ON	—
	OFF	Ignition switch in ACC position	

A  
B  
C  
D  
E  
F  
G  
H  
I  
J  
K  
L  
M

AV

O

P

# DIAGNOSIS SYSTEM (AV CONTROL UNIT)

< FUNCTION DIAGNOSIS >

[BOSE AUDIO WITHOUT NAVIGATION]

Diagnosis item	Display	Vehicle status	Remarks
Reverse	ON	Selector lever in R position	Changes in indication may be delayed by approximately 1.5 seconds. This is normal.
	OFF	Selector lever in any position other than R	
	-	Ignition switch in ACC position	

## Speaker Test

Select "Speaker Test" to display the speaker diagnosis screen. Press "Start" to generate a test tone in speakers. Press "End" to stop the test tones.

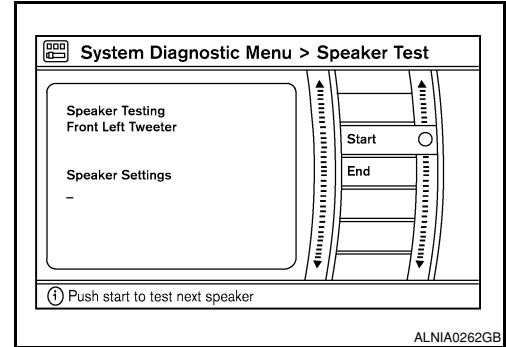

## Error History

The self-diagnosis results are judged depending on whether any error occurs from when "Self-diagnosis" is selected until the self-diagnosis results are displayed.

However, the diagnosis results are judged normal if an error has occurred before the ignition SW is turned ON and then no error has occurred until the self-diagnosis start. Check the "Error History" to detect any error that may have occurred before the self-diagnosis start because of this situation.

### Count up method A

- The counter resets to 0 if an error occurs when IGN switch is turned ON. The counter increases by 1 if the condition is normal at a next IGN ON cycle.
- The counter upper limit is 39. Any counts exceeding 39 are ignored. The counter can be reset (no error-record display) with the "Delete log" switch or CONSULT-III.

### Count up method B

- The counter increases by 1 if an error occurs when IGN switch is ON. The counter will not decrease even if the condition is normal at the next IGN ON cycle.
- The counter upper limit is 50. Any counts exceeding 50 are ignored. The counter can be reset (no error-record display) with the "Delete log" switch or CONSULT-III.

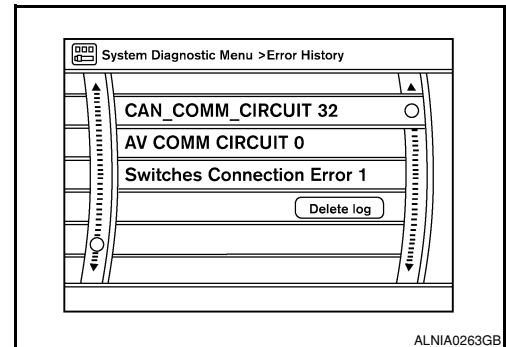

Display method of occurrence frequency	Error history display item
Count up method A	CAN communication line, control unit (CAN), AV communication line, control unit (AV communication)
Count up method B	Other than above

## Vehicle CAN Diagnosis

- CAN communication status and error counter is displayed.
- The error counter displays "OK" if any malfunction was not detected in the past and displays "0" if a malfunction is detected. It increases by 1 if the condition is normal at the next ignition switch ON cycle. The upper limit of the counter is 39.
- The error counter is erased if reset.

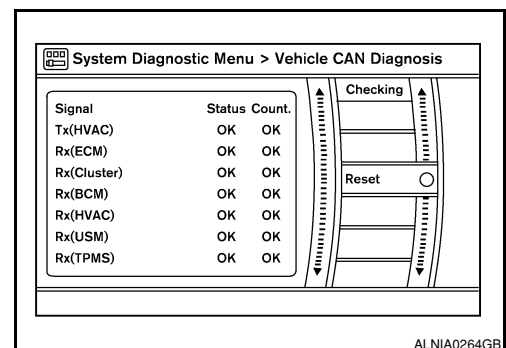

# DIAGNOSIS SYSTEM (AV CONTROL UNIT)

[BOSE AUDIO WITHOUT NAVIGATION]

< FUNCTION DIAGNOSIS >

## AV COMM Diagnosis

- AV communication status and error counter is displayed.
- The error counter displays “OK” if any malfunction was not detected in the past and displays “0” if a malfunction is detected. It increases by 1 if the condition is normal at the next ignition switch ON cycle. The upper limit of the counter is 39.
- The error counter is erased if reset.

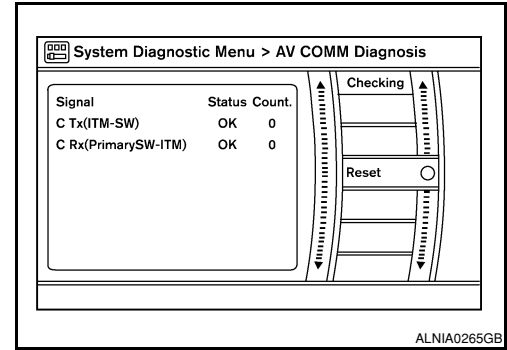

## Delete Unit Connection Log

Deletes any unit connection records and error records from the AV control unit memory. (Clear the records of the unit that has been removed)

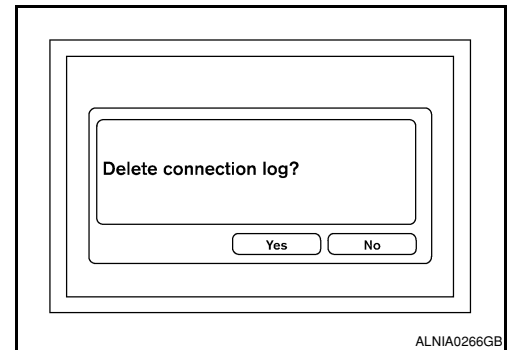

## Initialize Settings

Initializes the AV control unit memory.

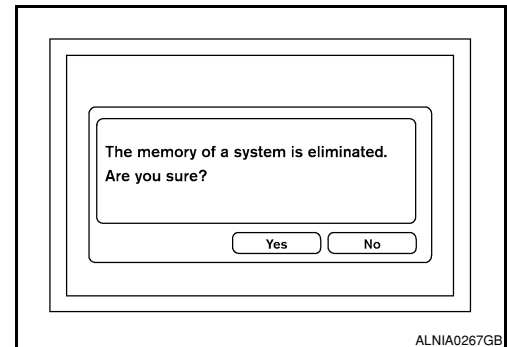

## AV CONTROL UNIT : CONSULT-III Function

INFOID:000000001316585

CONSULT-III can display each diagnostic item using the diagnostic test modes shown following.

MULTI AV diagnosis mode	Description
SELF-DIAG RESULTS	Displays AV control unit self-diagnosis results.
DATA MONITOR	Displays AV control unit input/output data in real time.
CAN DIAG SUPPORT MNTR	The result of transmit/receive diagnosis of CAN communication can be read.
AV COMM MONITOR	Allows the technician to monitor the status of the Multi AV system communication signals.
ECU PART NUMBER	The part number of AV control unit can be checked.

## SELF-DIAG RESULTS

Display Item List

Refer to [AV-238. "DTC Index"](#).

## DATA MONITOR

Display Item List

# DIAGNOSIS SYSTEM (AV CONTROL UNIT)

< FUNCTION DIAGNOSIS >

[BOSE AUDIO WITHOUT NAVIGATION]

Display item [unit]	ALL SIGNALS	SELECTION FROM MENU	Description
VHCL SPD SIG [ON/OFF]	X	X	Displays "ON" when vehicle speed > 0 km/h. Displays "OFF" when vehicle speed = 0 km/h.
PKB SIG [ON/OFF]	X	X	Displays [ON/OFF] condition of parking brake switch.
ILLUM SIG [ON/OFF]	X	X	Displays [ON/OFF] condition of lighting switch.
IGN SIG [ON/OFF]	X	X	Displays [ON/OFF] condition of ignition switch.
REV SIG [ON/OFF]	X	X	Displays [ON/OFF] condition of back-up lamp switch.

## A/C AND AV SWITCH ASSEMBLY

### A/C AND AV SWITCH ASSEMBLY : Component Function Check

INFOID:000000001317776

#### A/C and AV switch assembly self-diagnosis function

##### Description

The ON/OFF operation (continuity) of each switch in the A/C and AV switch assembly can be checked.

##### Self-diagnosis mode

- Press the "BACK" button and the "UP" button within 10 seconds after turning the ignition switch from OFF to ACC and hold them for 3 seconds or more. When the self-diagnosis mode starts, a beep will sound and all LED indicators of the switch will illuminate.
- The continuity of each switch and control dial of the A/C and AV switch assembly can be checked. If the switch is operating normally, the system will beep and the LED's will illuminate when each switch is operated.

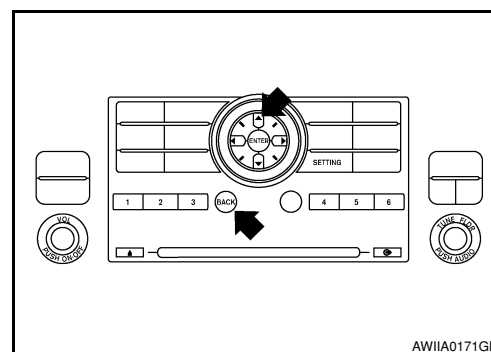

##### Finishing self-diagnosis mode

Self-diagnosis mode is canceled when the ignition switch is turned OFF.

# DIAGNOSIS SYSTEM (BLUETOOTH CONTROL UNIT)

< FUNCTION DIAGNOSIS >

[BOSE AUDIO WITHOUT NAVIGATION]

## DIAGNOSIS SYSTEM (BLUETOOTH CONTROL UNIT)

### Diagnosis Description

INFOID:000000001278739

The Bluetooth control unit has two diagnostic checks. The first diagnostic check is performed automatically every ignition cycle during control unit initialization. The second diagnostic check is performed by the technician using the steering wheel audio control switches prior to trouble diagnosis.

### BLUETOOTH CONTROL UNIT INITIALIZATION CHECKS

- Internal control unit failure
- Bluetooth antenna connection open or shorted
- Steering wheel audio control switches (SEND/END) stuck closed
- Vehicle speed pulse count
- Microphone connection test (with playback to operator)
- Bluetooth inquiry check

### OPERATION PROCEDURE

1. Turn ignition switch to ACC or ON.
2. Wait for the Bluetooth system to complete initialization. This may take up to 10 seconds.
3. Press and hold the steering wheel audio control switch  button for at least 5 seconds. The Bluetooth system will begin to play a verbal prompt.

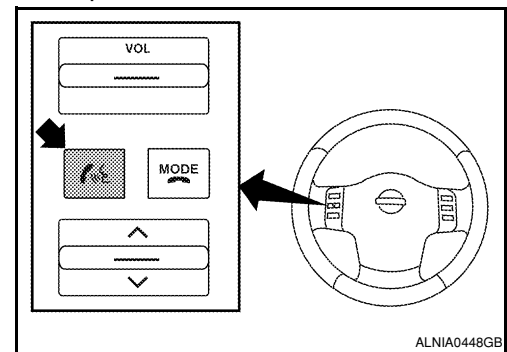

4. While the prompt is playing, press and hold the steering wheel audio control switch  button until you hear the "Diagnostics mode" prompt. The Bluetooth system will sound a 5 second beep.
5. While the beep is sounding, press and hold the steering wheel audio control switch END button again until you hear prompts.
6. The Bluetooth system has now entered into the diagnostic mode. Results of the diagnostic checks will be verbalized to the technician. Refer to [AV-141. "Work Flow"](#).
7. After the failure records are reported, an interactive microphone test will be performed. Follow the voice prompt. If the microphone test fails refer to [AV-141. "Work Flow"](#).
8. Self-diagnosis mode is complete when the voice prompt says "All diagnostic functions completed".

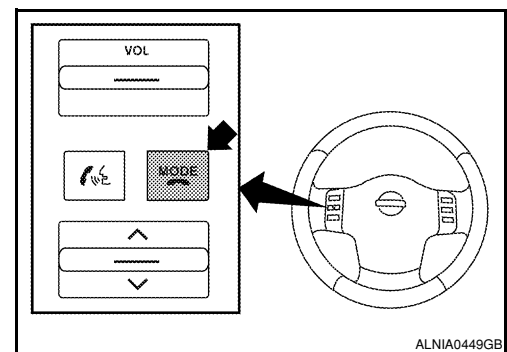

### Work Flow

INFOID:000000001278740

Failure Message	Action
"Internal failure"	Replace Bluetooth control unit. Refer to <a href="#">AV-277. "Removal and Installation"</a> .
"Bluetooth antenna open"	1. Inspect harness connection. 2. Replace Bluetooth antenna. Refer to <a href="#">AV-276. "Removal and Installation"</a> .
"Bluetooth antenna shorted"	
"Phone/Send for Hands Free System is stuck"	Check steering wheel audio control switches. Refer to <a href="#">AV-194. "Description"</a> .
"Phone/End for the Hands Free System is stuck"	
"Microphone test" (failed interactive test)	1. Inspect harness between Bluetooth control unit and microphone. 2. Replace microphone. Refer to <a href="#">AV-275. "Removal and Installation"</a> .

## COMPONENT DIAGNOSIS

### U1000 CAN COMM CIRCUIT

#### Description

INFOID:000000001348231

CAN (Controller Area Network) is a serial communication line for real time application. It is an on-vehicle multiplex communication line with high data communication speed and excellent error detection ability. Many electronic control units are equipped onto a vehicle and each control unit shares information and links with other control units during operation (not independent). In CAN communication, control units are connected with 2 communication lines (CAN-H, CAN-L) allowing a high rate of information transmission with less wiring. Each control unit transmits/receives data but selectively reads required data only.

CAN Communication Signal Chart. Refer to [LAN-46, "CAN Communication Signal Chart"](#).

#### DTC Logic

INFOID:000000001348232

#### DTC DETECTION LOGIC

DTC	Display contents of CONSULT-III	Diagnostic item is detected when ...	Probable malfunction location
U1000	CAN COMM CIRCUIT	When AV control unit is not transmitting or receiving CAN communication signal for 2 seconds or more.	CAN communication system

#### Diagnosis Procedure

INFOID:000000001348233

#### 1. PERFORM SELF DIAGNOSTIC

1. Turn ignition switch ON and wait for 2 seconds or more.
2. Check "Self Diagnostic Result" of "AV Control Unit".

#### Is "CAN COMM CIRCUIT" displayed?

- YES >> Refer to "LAN system". Refer to [LAN-14, "Trouble Diagnosis Flow Chart"](#).
- NO >> Refer to GI section. Refer to [GI-39, "Intermittent Incident"](#).

# U1010 CONTROL UNIT (CAN)

[BOSE AUDIO WITHOUT NAVIGATION]

< COMPONENT DIAGNOSIS >

## U1010 CONTROL UNIT (CAN)

### Description

INFOID:000000001348234

Initial diagnosis of AV control unit.

### DTC Logic

INFOID:000000001348235

### DTC DETECTION LOGIC

DTC	Display contents of CONSULT-III	Diagnostic item is detected when ...	Probable malfunction location
U1010	CONTROL UNIT (CAN)	CAN initial diagnosis malfunction is detected	AV control unit

### Diagnosis Procedure

INFOID:000000001348236

#### 1. REPLACE AV CONTROL UNIT

When DTC U1010 is detected, replace AV control unit. Refer to [AV-104. "Removal and Installation"](#)

>> INSPECTION END

A  
B  
C  
D  
E  
F  
G  
H  
I  
J  
K  
L  
M  
O  
P

AV

# U1200 AV CONTROL UNIT

< COMPONENT DIAGNOSIS >

[BOSE AUDIO WITHOUT NAVIGATION]

## U1200 AV CONTROL UNIT

### Description

INFOID:000000001348239

Replace the AV control unit if this DTC is displayed. Refer to [AV-259. "Removal and Installation"](#).

Part name	Description
AV CONTROL UNIT	<ul style="list-style-type: none"><li>• It is the master unit of the MULTI AV system and it is connected to each control unit by means of communication. It operates each system according to communication signals from the AV control unit.</li><li>• AV control unit includes audio function and vehicle information function.</li><li>• It is connected to ECM and combination meter via CAN communication to obtain necessary information for the vehicle information function.</li><li>• It inputs the automatic brightness ON/OFF signals that are required for the display dimming control.</li><li>• It inputs the signals for driving status recognition (vehicle speed, reverse and parking brake).</li></ul>

### DTC Logic

INFOID:000000001348240

DTC	Display contents of CONSULT-III	DTC Detection Condition	Action to take
U1200	Control Unit FLASH- ROM [U1200]	An internal malfunction is detected in AV control unit (FLASH-ROM).	Replace AV control unit. Refer to <a href="#">AV-104. "Removal and Installation"</a>



# U1216 AV CONTROL UNIT

< COMPONENT DIAGNOSIS >

[BOSE AUDIO WITHOUT NAVIGATION]

## U1216 AV CONTROL UNIT

### Description

INFOID:000000001348241

Replace the AV control unit if this DTC is displayed. Refer to [AV-259, "Removal and Installation"](#).

Part name	Description
AV CONTROL UNIT	<ul style="list-style-type: none"><li>• It is the master unit of the MULTI AV system and it is connected to each control unit by means of communication. It operates each system according to communication signals from the AV control unit.</li><li>• AV control unit includes audio function and vehicle information function.</li><li>• It is connected to ECM and combination meter via CAN communication to obtain necessary information for the vehicle information function.</li><li>• It inputs the automatic brightness ON/OFF signals that are required for the display dimming control.</li><li>• It inputs the signals for driving status recognition (vehicle speed, reverse and parking brake).</li></ul>

### DTC Logic

INFOID:000000001348242

DTC	Display contents of CONSULT-III	DTC Detection Condition	Action to take
U1216	CAN CONT [U1216]	Internal malfunction of AV control unit (CAN controller) is detected.	Replace AV control unit. Refer to <a href="#">AV-104, "Removal and Installation"</a>

A  
B  
C  
D  
E  
F  
G  
H  
I  
J  
K  
L  
M  
O  
P

AV

# U1240 SWITCH CONN

< COMPONENT DIAGNOSIS >

[BOSE AUDIO WITHOUT NAVIGATION]

## U1240 SWITCH CONN

### Description

INFOID:000000001611770

U1240 is indicated when malfunction occurs in communication signal of multi AV system. Indicated simultaneously, without fail, with the malfunction of control units connected to AV control unit with communication line. Determine the possible malfunction cause from the table below.

### Self-diagnosis results display item

DTC	Display contents of CONSULT-III	DTC Detection Condition	Possible causes
U1240	<ul style="list-style-type: none"><li>SWITCH CONN [U1240]</li></ul>	<ul style="list-style-type: none"><li>A/C and AV switch assembly power supply and ground circuit malfunction is detected</li><li>A malfunction is detected in communication circuit between AV control unit and A/C and AV switch assembly</li><li>A malfunction is detected in communication signal between AV control unit and A/C and AV switch assembly</li></ul>	<ul style="list-style-type: none"><li>A/C and AV switch assembly power supply and ground circuits</li><li>Communication circuit between AV control unit and A/C and AV switch assembly</li></ul>

# U1243 DISPLAY UNIT

< COMPONENT DIAGNOSIS >

[BOSE AUDIO WITHOUT NAVIGATION]

## U1243 DISPLAY UNIT

### Description

INFOID:000000001348243

Part name	Description
DISPLAY UNIT	<ul style="list-style-type: none"> <li>• Display image is controlled by the serial communication from AV control unit.</li> <li>• Inputs the RGB image signal (RGB, RGB area and RGB synchronizing) from AV control unit and the auxiliary image signal from the auxiliary input jacks.</li> <li>• Outputs the synchronizing signals (HP and VP) to the AV control unit.</li> </ul>

### DTC Logic

INFOID:000000001348244

DTC	Display contents of CONSULT-III	DTC Detection Condition	Possible causes
U1243	FRONT DISP CONN [U1243]	<ul style="list-style-type: none"> <li>• Display unit power supply and ground circuit malfunction is detected</li> <li>• Malfunction is detected on communication circuit between display unit and AV control unit</li> <li>• Malfunction is detected on communication signal between display unit and AV control unit</li> </ul>	<ul style="list-style-type: none"> <li>• Display unit power supply and ground circuit</li> <li>• Communication circuit between display unit and AV control unit</li> </ul>

### Diagnosis Procedure

INFOID:000000001348245

#### 1. CHECK DISPLAY UNIT POWER SUPPLY AND GROUND CIRCUIT

Check display unit power supply and ground circuit. Refer to [AV-155, "DISPLAY UNIT : Diagnosis Procedure"](#).

Is inspection result OK?

YES >> GO TO 2.

NO >> Repair malfunctioning parts.

#### 2. CHECK CONTINUITY OF COMMUNICATION CIRCUIT

1. Turn ignition switch OFF.
2. Disconnect display unit connector and AV control unit connector.
3. Check continuity between display unit harness connector M93 (A) terminals 11, 22 and AV control unit harness connector M44 (B) terminals 56, 44.

A		B		Continuity
Connector	Terminal	Connector	Terminal	
M93	11	M44	56	Yes
	22		44	

4. Check continuity between display unit harness connector M93 (A) terminals 11, 22 and ground.

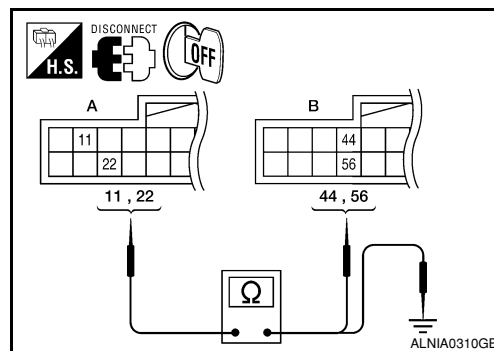

A		—	Continuity
Connector	Terminal		
M93	11	Ground	No
	22		

Are continuity results as specified?

YES >> GO TO 3.

NO >> Repair harness or connector.

#### 3. CHECK COMMUNICATION SIGNAL

1. Connect display unit connector and AV control unit connector.
2. Turn ignition switch ON.

# U1243 DISPLAY UNIT

[BOSE AUDIO WITHOUT NAVIGATION]

< COMPONENT DIAGNOSIS >

3. Check signal between display unit harness connector M93 terminal 11 and ground with an oscilloscope or CONSULT-III.

(+)		(-)	Reference signal
Connector	Terminal		
M93	11	Ground	

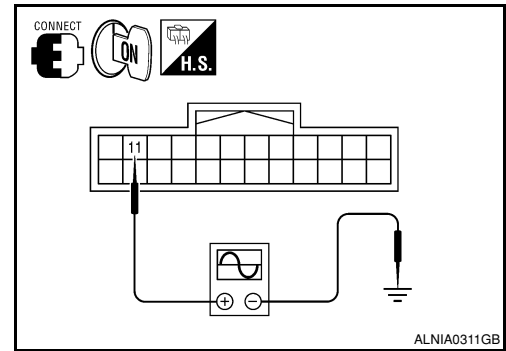

Are voltage readings as specified?

YES >> GO TO 4.

NO >> Replace AV control unit. Refer to [AV-104. "Removal and Installation"](#)

## 4. CHECK COMMUNICATION SIGNAL

Check signal between display unit harness connector M93 terminal 22 and ground with an oscilloscope or CONSULT-III.

(+)		(-)	Reference signal
Connector	Terminal		
M93	22	Ground	

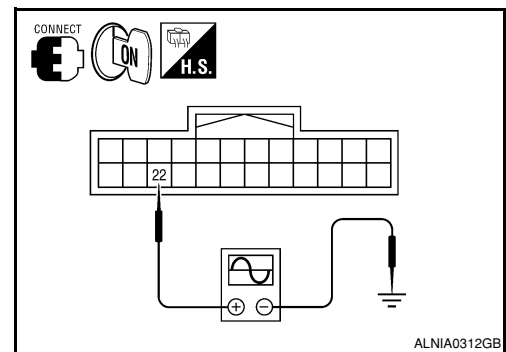

Are voltage readings as specified?

YES >> INSPECTION END

NO >> Replace display unit. Refer to [AV-106. "Removal and Installation"](#)

# U1248 DVD DECK CONN

< COMPONENT DIAGNOSIS >

[BOSE AUDIO WITHOUT NAVIGATION]

## U1248 DVD DECK CONN

### Description

INFOID:000000001609792

U1248 is indicated when a malfunction occurs in the communication signal of the DVD player. Indicated simultaneously, without fail, with the malfunction of control units connected to AV control unit with communication line. Determine the possible malfunction cause from the table below.

### DTC Logic

INFOID:000000001609793

DTC	Display contents of CONSULT-III	DTC Detection Condition	Possible causes
U1248	DVD DECK CONN [U1248]	<ul style="list-style-type: none"><li>DVD player power supply and ground circuit malfunction is detected</li><li>Malfunction is detected on communication circuit between DVD player and AV control unit</li><li>Malfunction is detected on communication signal between DVD player and AV control unit</li></ul>	<ul style="list-style-type: none"><li>DVD player power supply and ground circuit</li><li>Communication circuit between DVD player and AV control unit</li></ul>

### Diagnosis Procedure

INFOID:000000001609794

#### 1. CHECK DVD PLAYER POWER SUPPLY AND GROUND CIRCUIT

Check DVD player power supply and ground circuit. Refer to [AV-39. "DVD PLAYER : Diagnosis Procedure"](#)  
Is inspection result OK?

- YES >> INSPECTION END.
- NO >> Repair malfunctioning parts.

A  
B  
C  
D  
E  
F  
G  
H  
I  
J  
K  
L  
M  
O  
P

AV

# U1255 SATELLITE RADIO TUNER

< COMPONENT DIAGNOSIS >

[BOSE AUDIO WITHOUT NAVIGATION]

## U1255 SATELLITE RADIO TUNER

### Description

INFOID:000000001348246

Part name	Description
SATELLITE RADIO TUNER	<ul style="list-style-type: none"><li>Inputs the satellite radio signal from satellite radio antenna and outputs it to the AV control unit.</li><li>It is controlled with the communication (communication signal, request signal) from AV control unit.</li></ul>

### DTC Logic

INFOID:000000001348247

DTC	Display contents of CONSULT-III	DTC Detection Condition	Possible causes
U1255	SAT CONN [U1255]	The satellite radio tuner power supply and ground circuit malfunction is detected	Satellite radio tuner power supply and ground circuit

### Diagnosis Procedure

INFOID:000000001348248

#### 1. CHECK SATELLITE RADIO TUNER POWER SUPPLY AND GROUND CIRCUIT

Check satellite radio tuner power supply and ground circuit. Refer to [AV-158. "SATELLITE RADIO TUNER : Diagnosis Procedure"](#).

Is inspection result OK?

- YES >> INSPECTION END
- NO >> Repair malfunctioning parts.

# U1256 HAND FREE CONN

< COMPONENT DIAGNOSIS >

[BOSE AUDIO WITHOUT NAVIGATION]

## U1256 HAND FREE CONN

### Description

INFOID:000000001611772

U1256 is indicated when malfunction occurs in communication signal of multi AV system. Indicated simultaneously, without fail, with the malfunction of control units connected to AV control unit with communication line. Determine the possible malfunction cause from the table below.

### Self-diagnosis results display item

DTC	Display contents of CONSULT-III	DTC Detection Condition	Possible causes
U1256	<ul style="list-style-type: none"><li>HAND FREE CONN [U1256]</li></ul>	<ul style="list-style-type: none"><li>Bluetooth control unit power supply and ground circuit malfunction is detected</li><li>A malfunction is detected in communication circuit between AV control unit and Bluetooth control unit</li><li>A malfunction is detected in communication signal between AV control unit and Bluetooth control unit</li></ul>	<ul style="list-style-type: none"><li>Bluetooth control unit power supply and ground circuits</li><li>Communication circuit between AV control unit and Bluetooth control unit</li></ul>

A  
B  
C  
D  
E  
F  
G  
H  
I  
J  
K  
L  
M

AV

O  
P

# U1300 AV COMM CIRCUIT

< COMPONENT DIAGNOSIS >

[BOSE AUDIO WITHOUT NAVIGATION]

## U1300 AV COMM CIRCUIT

### Description

INFOID:000000001611771

U1300 is indicated when malfunction occurs in communication signal of multi AV system. Indicated simultaneously, without fail, with the malfunction of control units connected to AV control unit with communication line. Determine the possible malfunction cause from the table below.

### Self-diagnosis results display item

DTC	Display contents of CONSULT-III	DTC Detection Condition	Possible causes
U1300	• AV COMM CIRCUIT [U1300]	When AV control unit is not transmitting or receiving AV communication signal for 2 seconds or more.	AV communication system



# U1310 AV CONTROL UNIT

< COMPONENT DIAGNOSIS >

[BOSE AUDIO WITHOUT NAVIGATION]

## U1310 AV CONTROL UNIT

### Description

INFOID:000000001348237

Replace the AV control unit if this DTC is displayed. Refer to [AV-259, "Removal and Installation"](#).

Part name	Description
AV CONTROL UNIT	<ul style="list-style-type: none"><li>• It is the master unit of the MULTI AV system and it is connected to each control unit by means of communication. It operates each system according to communication signals from the AV control unit.</li><li>• AV control unit includes audio function and vehicle information function.</li><li>• It is connected to ECM and combination meter via CAN communication to obtain necessary information for the vehicle information function.</li><li>• It inputs the automatic brightness ON/OFF signals that are required for the display dimming control.</li><li>• It inputs the signals for driving status recognition (vehicle speed, reverse and parking brake).</li></ul>

### DTC Logic

INFOID:000000001348238

DTC	Display contents of CONSULT-III	DTC Detection Condition	Action to take
U1310	CONTROL UNIT (AV) [U1310]	An initial diagnosis error is detected in AV communication circuit.	Replace AV control unit. Refer to <a href="#">AV-104, "Removal and Installation"</a>

A  
B  
C  
D  
E  
F  
G  
H  
I  
J  
K  
L  
M  
O  
P

AV

# POWER SUPPLY AND GROUND CIRCUIT

< COMPONENT DIAGNOSIS >

[BOSE AUDIO WITHOUT NAVIGATION]

## POWER SUPPLY AND GROUND CIRCUIT

### AV CONTROL UNIT

#### AV CONTROL UNIT : Diagnosis Procedure

INFOID:000000001348250

### 1. CHECK FUSES

Check that the following fuses of the AV control unit are not are not blown.

Unit	Terminals	Signal name	Fuse No.
AV control unit	19	Battery power	31
	7	Ignition switch ACC or ON	4
	104	Ignition switch ON or START	12

Are the fuses OK?

YES >> GO TO 2

NO >> If fuse is blown, be sure to eliminate cause of malfunction before installing new fuse.

### 2. POWER SUPPLY CIRCUIT CHECK

1. Disconnect AV control unit connectors M42 and M46.
2. Check voltage between the AV control unit connectors M42 and M46 and ground.

Connector	(+)		(-)	OFF	ACC	ON	START
	Terminal						
M42	7	Ground	0V	Battery voltage	Battery voltage	Battery voltage	0V
	19	Ground	Battery voltage	Battery voltage	Battery voltage	Battery voltage	Battery voltage
M46	104	Ground	0V	0V	Battery voltage	Battery voltage	Battery voltage

Are the voltage results as specified?

YES >> GO TO 3

NO >> • Check connector housings for disconnected or loose terminals.  
• Repair harness or connector.

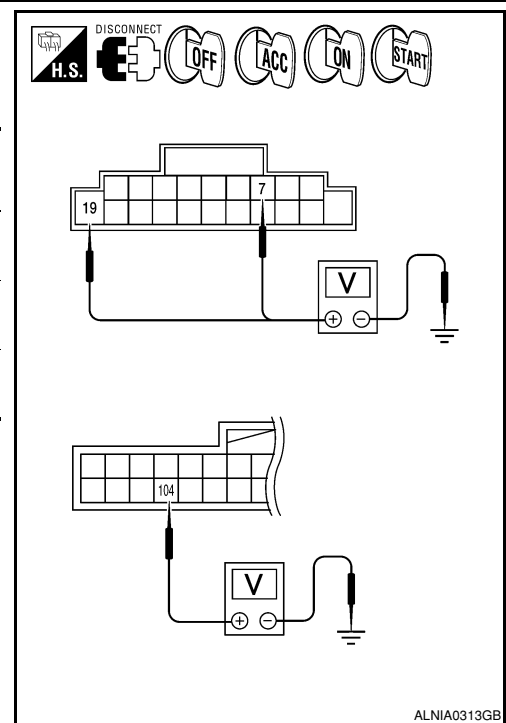

ALNIA0313GB

### 3. GROUND CIRCUIT CHECK

# POWER SUPPLY AND GROUND CIRCUIT

[BOSE AUDIO WITHOUT NAVIGATION]

## < COMPONENT DIAGNOSIS >

1. Turn ignition switch OFF.
2. Check continuity between AV control unit harness connectors M42, M44 and M46 and ground.

(+)		(-)	Continuity
Connector	Terminal		
M42	20	Ground	Yes
M44	54		
M46	85		

Are the continuity results as specified?

- YES >> Inspection End.  
 NO >> Repair AV control unit ground.

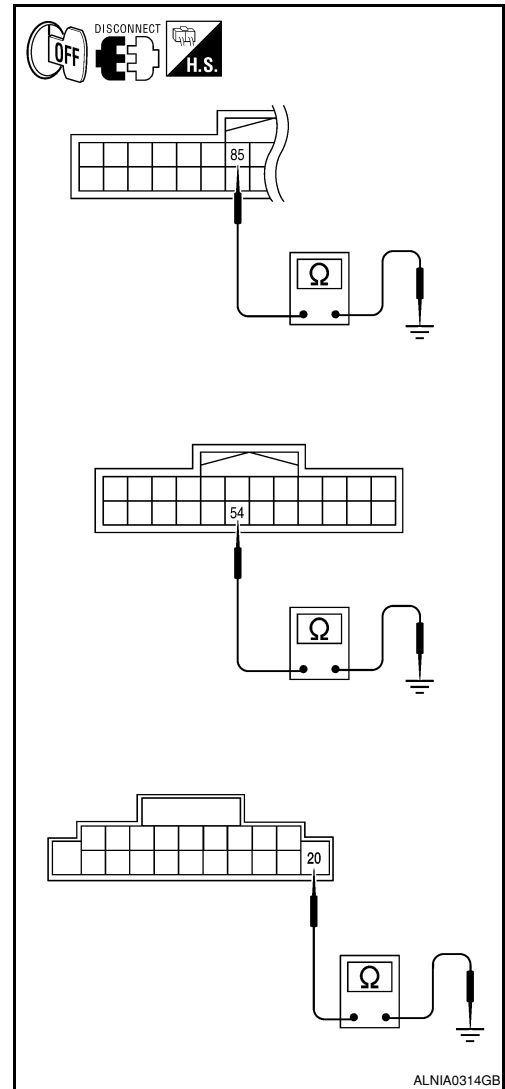

ALNIA0314GB

INFOID:000000001348251

## DISPLAY UNIT

### DISPLAY UNIT : Diagnosis Procedure

#### 1. CHECK POWER SUPPLY CIRCUIT

1. Turn ignition switch to ACC.
2. Check voltage between display unit harness connector M93 and ground.

Signal name	Connector No.	Terminal No.	Ignition switch position	Value (Approx.)
Inverter VCC	M93	2	ACC	9V
Signal VCC		3		

Does specified voltage exist?

- YES >> GO TO 3.  
 NO >> GO TO 2.

#### 2. CHECK POWER SUPPLY CIRCUIT

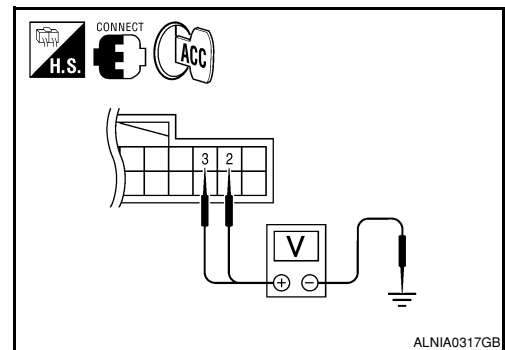

ALNIA0317GB

A  
B  
C  
D  
E  
F  
G  
H  
I  
J  
K  
L  
M  
N  
O  
P

AV

# POWER SUPPLY AND GROUND CIRCUIT

[BOSE AUDIO WITHOUT NAVIGATION]

## < COMPONENT DIAGNOSIS >

1. Turn ignition switch OFF.
2. Disconnect the display unit connector M93 and the AV control unit connector M44.
3. Check continuity between the display unit harness connector M93 (A) and the AV control unit connector M44 (B).

A		B		Continuity
Connector	Terminal	Connector	Terminal	
M93	2	M44	59	Yes
	3		47	

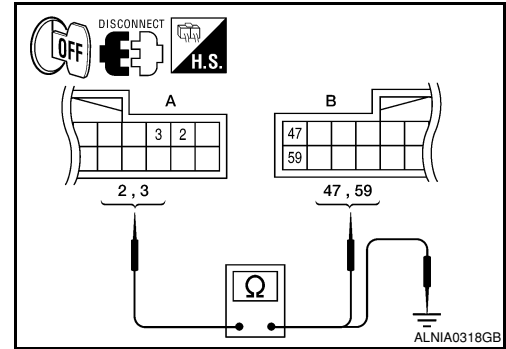

4. Check continuity between the display unit harness connector M93 (A) and ground.

A		—	Continuity
Connector	Terminal		
M93	2	Ground	No
	3		

### Are continuity results as specified?

YES >> Check AV control unit power and ground supply. Refer to [AV-154. "AV CONTROL UNIT : Diagnosis Procedure"](#)

NO >> Repair harness or connector.

## 3.CHECK GROUND CIRCUIT

1. Turn ignition switch OFF.
2. Disconnect display unit connector.
3. Check continuity between display unit harness connector and ground.

Connector	Terminal	—	Continuity
M93	1	Ground	Yes

### Does continuity exist?

YES >> INSPECTION END

NO >> Repair harness or connector.

## A/C AND AV SWITCH ASSEMBLY

### A/C AND AV SWITCH ASSEMBLY : Diagnosis Procedure

INFOID:000000001348252

## 1.CHECK FUSE

Check that the fuse of the AC and AV switch assembly is not blown.

Unit	Terminal	Signal name	Fuse No.
A/C and AV switch assembly	2	Ignition switch ACC or ON	4

### Is the fuse OK?

YES >> GO TO 2

NO >> If fuse is blown, be sure to eliminate cause of malfunction before installing new fuse.

## 2.POWER SUPPLY CIRCUIT CHECK

# POWER SUPPLY AND GROUND CIRCUIT

[BOSE AUDIO WITHOUT NAVIGATION]

## < COMPONENT DIAGNOSIS >

1. Disconnect A/C and AV switch assembly connector M98.
2. Check voltage between the A/C and AV switch assembly connector M98 and ground.

(+)		(-)	OFF	ACC	ON
Connector	Terminal				
M98	2	Ground	0V	Battery voltage	Battery voltage

Are the voltage results as specified?

- YES >> GO TO 3  
 NO >> • Check connector housings for disconnected or loose terminals.  
 • Repair harness or connector.

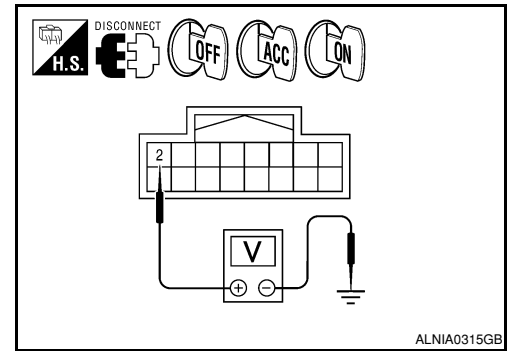

## 3. GROUND CIRCUIT CHECK

1. Turn ignition switch OFF.
2. Check continuity between A/C and AV switch assembly harness connector M98 and ground.

Connector	Terminal	—	Continuity
M98	1	Ground	Yes

Are the continuity results as specified?

- YES >> Inspection End.  
 NO >> Repair harness or ground.

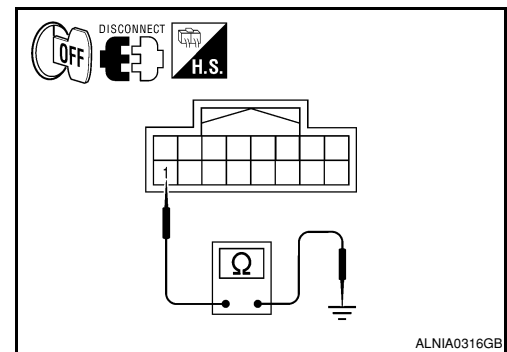

## BOSE SPEAKER AMP

### BOSE SPEAKER AMP : Diagnosis Procedure

INFOID:000000001278742

## 1. CHECK FUSE

Check that the BOSE speaker amp. fuse is not blown.

Unit	Terminal	Signal name	Fuse No.
BOSE speaker amp.	11	Battery power	31

Are the fuses OK?

- YES >> GO TO 2  
 NO >> Be sure to eliminate cause of malfunction before installing new fuse.

## 2. CHECK POWER SUPPLY CIRCUIT

1. Turn ignition switch OFF.
2. Disconnect BOSE speaker amp. connector.
3. Check voltage between BOSE speaker amp. harness connector M112 terminal 11 and ground.

(+)		(-)	Voltage (approx.)
Connector	Terminal		
M112	11	Ground	Battery voltage

Is battery voltage present?

- YES >> GO TO 3  
 NO >> Check harness between BOSE speaker amp. and fuse.

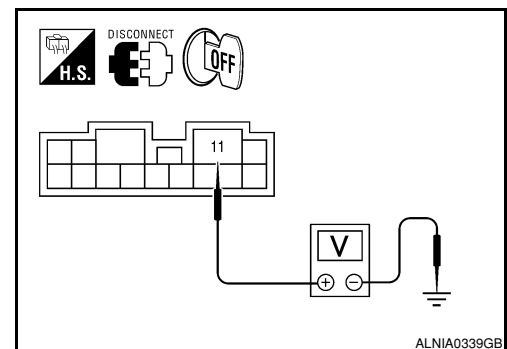

## 3. CHECK GROUND CIRCUIT

A  
B  
C  
D  
E  
F  
G  
H  
I  
J  
K  
L  
M  
O  
P

AV

# POWER SUPPLY AND GROUND CIRCUIT

[BOSE AUDIO WITHOUT NAVIGATION]

## < COMPONENT DIAGNOSIS >

1. Turn ignition switch OFF.
2. Disconnect BOSE speaker amp. connector.
3. Check continuity between BOSE speaker amp. harness connector M112 terminal 12 and ground.

(+)		(-)	Continuity
Connector	Terminal		
M112	12	Ground	Yes

Does continuity exist?

- YES >> Inspection End.  
 NO >> Repair harness or connector.

## WOOFER

### WOOFER : Diagnosis Procedure

INFOID:000000001317754

#### 1.CHECK FUSE

Check that the subwoofer fuse is not blown.

Unit	Terminal	Signal name	Fuse No.
Subwoofer	6	Battery power	17

Is the fuse OK?

- YES >> GO TO 2  
 NO >> Be sure to eliminate cause of malfunction before installing new fuse.

#### 2.CHECK POWER SUPPLY CIRCUIT

1. Turn ignition switch OFF.
2. Disconnect subwoofer connector.
3. Check voltage between subwoofer harness connector B72 terminal 6 and ground.

(+)		(-)	Voltage (approx.)
Connector	Terminal		
B72	6	Ground	Battery voltage

Is battery voltage present?

- YES >> GO TO 3  
 NO >> Check harness between subwoofer and fuse.

#### 3.CHECK GROUND CIRCUIT

1. Turn ignition switch OFF.
2. Check continuity between subwoofer harness connector B72 terminal 5 and ground.

(+)		(-)	Continuity
Connector	Terminal		
B72	5	Ground	Yes

Does continuity exist?

- YES >> Inspection End.  
 NO >> Repair harness or connector.

## SATELLITE RADIO TUNER

### SATELLITE RADIO TUNER : Diagnosis Procedure

INFOID:000000001348253

#### 1.CHECK FUSES

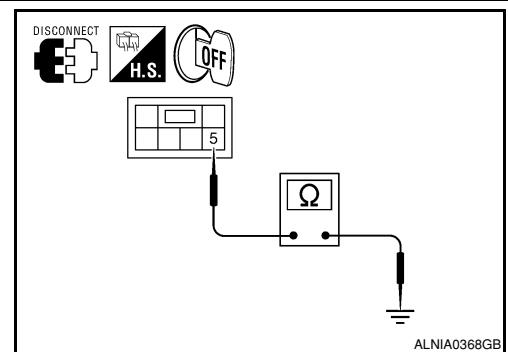
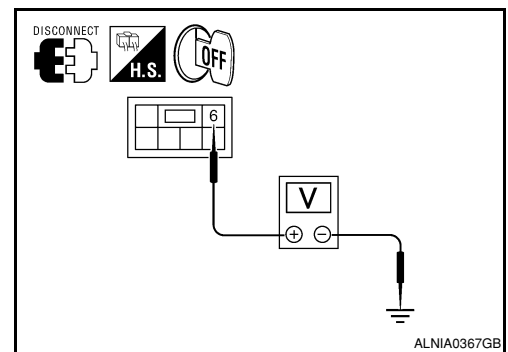
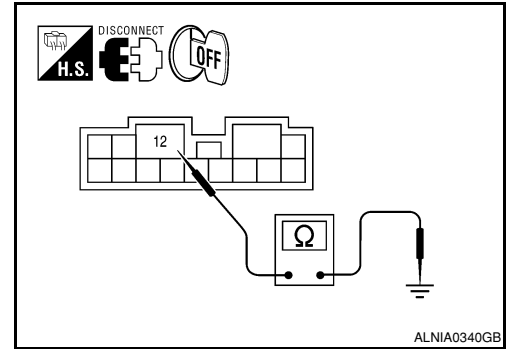

# POWER SUPPLY AND GROUND CIRCUIT

< COMPONENT DIAGNOSIS >

[BOSE AUDIO WITHOUT NAVIGATION]

Check that the following fuses of the satellite radio tuner (factory installed) are not blown.

Unit	Terminals	Signal name	Fuse No.
Satellite radio tuner (factory installed)	32	Battery power	31
	36	Ignition switch ACC or ON	4

Are the fuses OK?

YES >> GO TO 2

NO >> If fuse is blown, be sure to eliminate cause of malfunction before installing new fuse.

## 2. POWER SUPPLY CIRCUIT CHECK

1. Turn ignition switch OFF.
2. Disconnect satellite radio tuner (factory installed) connector M41.
3. Check voltage between the satellite radio tuner (factory installed) and ground.

(+) Connector		(-) Terminal	OFF	ACC	ON
M41	32	Ground	Battery voltage	Battery voltage	Battery voltage
	36		0V	Battery voltage	Battery voltage

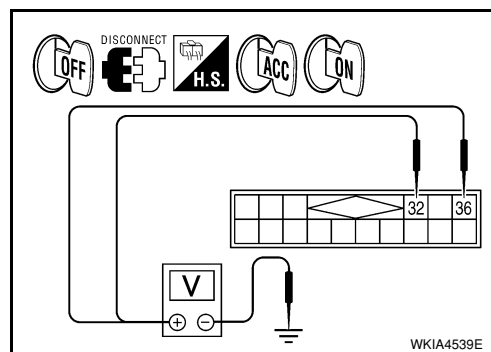

Are the voltage readings as specified?

YES >> GO TO 3

NO >> • Check connector housings for disconnected or loose terminals.  
• Repair harness or connector.

## 3. GROUND CIRCUIT CHECK

Inspect satellite radio tuner (factory installed) case ground.

Does case ground pass inspection?

YES >> Inspection End.

NO >> Repair satellite radio tuner (factory installed) case ground.

## REAR VIEW CAMERA CONTROL UNIT

### REAR VIEW CAMERA CONTROL UNIT : Diagnosis Procedure

INFOID:000000001348254

#### 1. CHECK FUSE

Check that the following fuses of the rear view camera control unit are not blown.

Unit	Terminals	Signal name	Fuse No.
Rear view camera control unit	1	Battery power	31
	2	Ignition switch ACC or ON	4

Are the fuses OK?

YES >> GO TO 2

NO >> Be sure to eliminate cause of malfunction before installing new fuse.

#### 2. CHECK POWER SUPPLY CIRCUIT

# POWER SUPPLY AND GROUND CIRCUIT

[BOSE AUDIO WITHOUT NAVIGATION]

## < COMPONENT DIAGNOSIS >

Check voltage between rear view camera control unit harness connector B73 and ground.

Signal name	Connector No.	Terminal No.	Ignition switch position	Value (Approx.)
Battery power supply	B73	1	OFF	Battery voltage
ACC power supply		2	ACC	

Are the voltage readings as specified?

YES >> GO TO 3

NO >> Repair harness or connector.

### 3.CHECK GROUND CIRCUIT

1. Turn ignition switch OFF.
2. Disconnect rear view camera control unit connector.
3. Check continuity between rear view camera control unit harness connector B73 terminal 3 and ground.

Connector	Terminal	—	Continuity
B73	3	Ground	Yes

Does continuity exist?

YES >> Inspection End.

NO >> Repair harness or connector.

## REAR VIEW CAMERA

### REAR VIEW CAMERA : Diagnosis Procedure

INFOID:000000001348255

### 1.CHECK POWER SUPPLY CIRCUIT (REAR VIEW CAMERA SIDE)

1. Turn ignition switch ON.
2. Shift transmission into reverse.
3. Check voltage between rear view camera harness connector D504 and ground.

Signal name	Connector No.	Terminal No.	Transmission position	Value (Approx.)
Camera ON signal	D504	1	Reverse	6V

Is voltage reading approximately 6 volts?

YES >> GO TO 4

NO >> GO TO 2

### 2.CHECK POWER SUPPLY CIRCUIT (CONTINUITY)

1. Turn ignition switch OFF.
2. Disconnect rear view camera and rear view camera control unit connectors.
3. Check continuity between rear view camera harness connector D504 (A) terminal 1 and rear view camera control unit harness connector B73 (B) terminal 8.

A		B		Continuity
Connector	Terminal	Connector	Terminal	
D504	1	B73	8	Yes

4. Check continuity between rear view camera harness connector D504 (A) terminal 1 and ground.

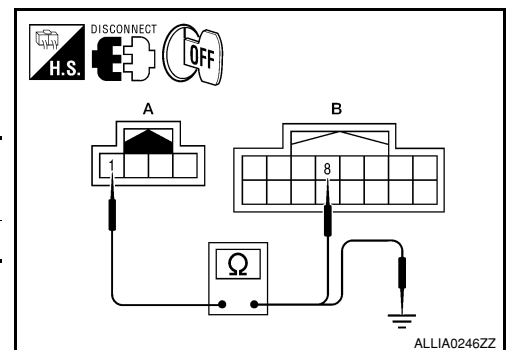
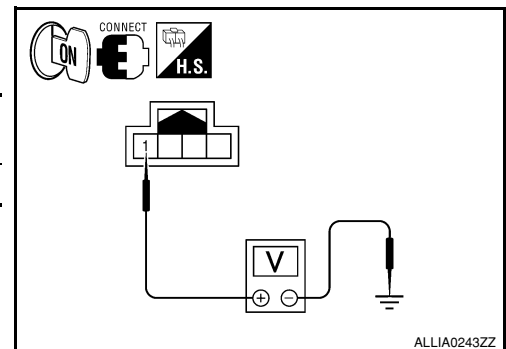
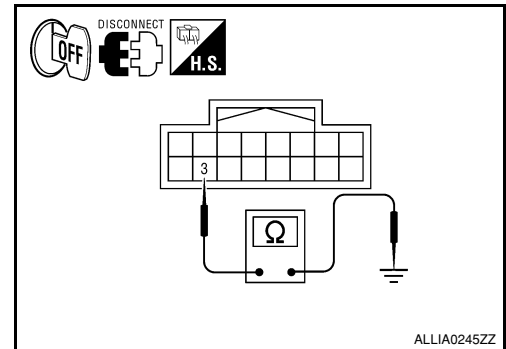
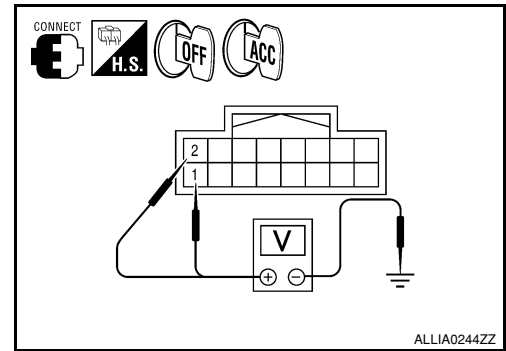



# POWER SUPPLY AND GROUND CIRCUIT

[BOSE AUDIO WITHOUT NAVIGATION]

< COMPONENT DIAGNOSIS >

A		—	Continuity
Connector	Terminal		
D504	1	Ground	No

Are continuity test results as specified?

YES >> GO TO 3

NO >> Repair harness or connector.

## 3.CHECK POWER SUPPLY CIRCUIT (REAR VIEW CAMERA CONTROL UNIT SIDE)

1. Connect rear view camera control unit harness connector.
2. Turn ignition switch ON.
3. Check voltage between rear view camera control unit harness connector B73 and ground.

Signal name	Connector No.	Terminal No.	Transmission position	Value (Approx.)
Camera ON signal	B73	8	Reverse	6V

Is voltage reading approximately 6 volts?

YES >> Inspection End.

NO >> Replace rear view camera control unit. Refer to [AV-279](#), "[Removal and Installation](#)".

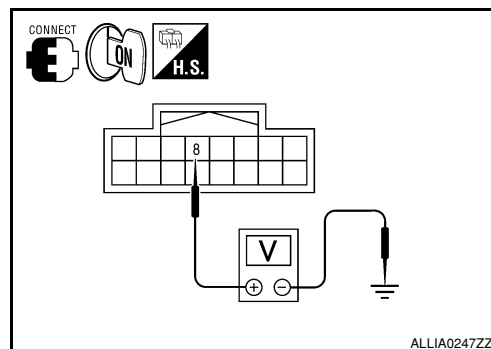

## 4.CHECK GROUND CIRCUIT

1. Turn ignition switch OFF.
2. Disconnect rear view camera harness connector.
3. Check continuity between rear view camera harness connector D504 terminal 2 and ground.

Connector	Terminal	—	Continuity
D504	2	Ground	Yes

Does continuity exist?

YES >> Inspection End.

NO >> Repair harness or connector.

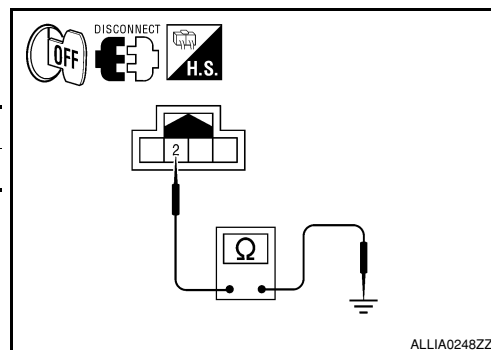

## DVD PLAYER

### DVD PLAYER : Diagnosis Procedure

INFOID:000000001348256

## 1.CHECK FUSE

Check that the following fuses of the DVD player are not blown.

Unit	Terminal	Signal name	Fuse No.
DVD player	21	Battery power	31
	24	Ignition switch ACC or ON	4

Is the fuse OK?

YES >> GO TO 2

NO >> If fuse is blown, be sure to eliminate cause of malfunction before installing new fuse.

## 2.POWER SUPPLY CIRCUIT CHECK

# POWER SUPPLY AND GROUND CIRCUIT

[BOSE AUDIO WITHOUT NAVIGATION]

## < COMPONENT DIAGNOSIS >

1. Disconnect DVD player connector M205.
2. Check voltage between the DVD player connector M205 and ground.

(+)		(-)	OFF	ACC	ON
Connector	Terminal				
M205	21	Ground	Battery voltage	Battery voltage	Battery voltage
	24		0V	Battery voltage	Battery voltage

Are the voltage results as specified?

YES >> GO TO 3

NO >> • Check connector housings for disconnected or loose terminals.  
• Repair harness or connector.

### 3. GROUND CIRCUIT CHECK

1. Turn ignition switch OFF.
2. Check continuity between DVD player harness connector M205 terminal 5 and ground.

Connector	Terminal	—	Continuity
M205	5	Ground	Yes

Are the continuity results as specified?

YES >> Inspection End.

NO >> Repair DVD player ground.

## VIDEO MONITOR

### VIDEO MONITOR : Diagnosis Procedure

INFOID:000000001348257

#### 1. CHECK POWER SUPPLY CIRCUIT

1. Turn ignition switch to ACC.
2. Check voltage between video monitor harness connector R202 and ground.

Signal name	Connector No.	Terminal No.	Ignition switch position	Value (Approx.)
Display B+	R202	11	ACC	12V
		12		

Does specified voltage exist?

YES >> GO TO 3.

NO >> GO TO 2.

#### 2. CHECK POWER SUPPLY CIRCUIT

1. Turn ignition switch OFF.
2. Disconnect the video monitor connector R202 and the DVD player connector M205.
3. Check continuity between the video monitor harness connector R202 (A) and the DVD player connector M205 (B).

A		B		Continuity
Connector	Terminal	Connector	Terminal	
R202	11	M205	9	Yes
	12		25	

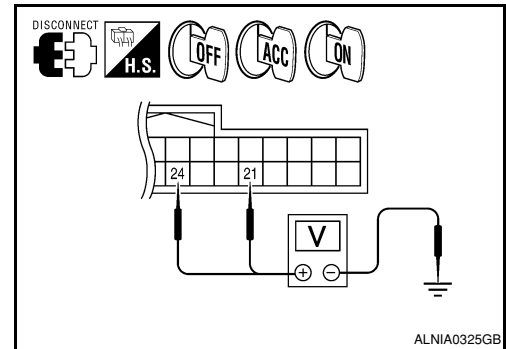

ALNIA0325GB

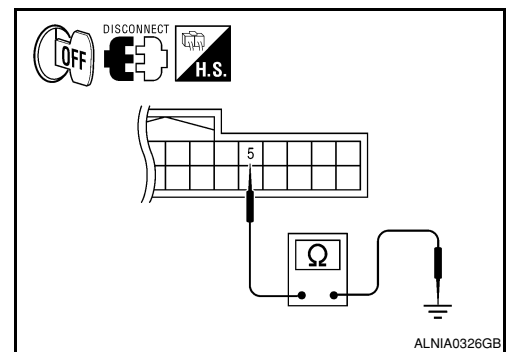

ALNIA0326GB

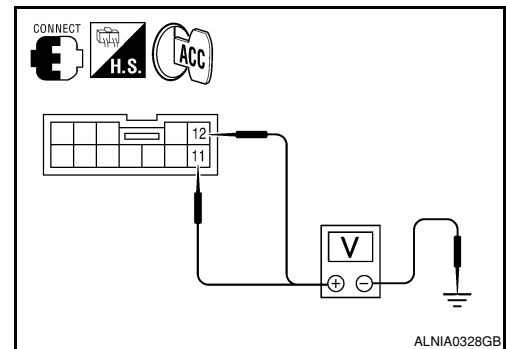

ALNIA0328GB

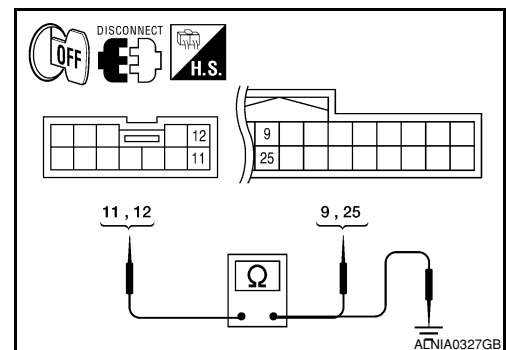

ALNIA0327GB

# POWER SUPPLY AND GROUND CIRCUIT

[BOSE AUDIO WITHOUT NAVIGATION]

< COMPONENT DIAGNOSIS >

4. Check continuity between video monitor harness connector R202 (A) and ground.

A		—	Continuity
Connector	Terminal		
R202	11	Ground	No
	12		

Are continuity test results as specified?

YES >> Check DVD player power and ground supply. Refer to [AV-154, "AV CONTROL UNIT : Diagnosis Procedure"](#)

NO >> Repair harness or connector.

## 3.CHECK GROUND CIRCUIT

1. Turn ignition switch OFF.
2. Disconnect video monitor connector.
3. Check continuity between video monitor harness connector R202 and ground.

Connector No.	Terminal No.	—	Continuity
R202	1	Ground	Yes
	2		

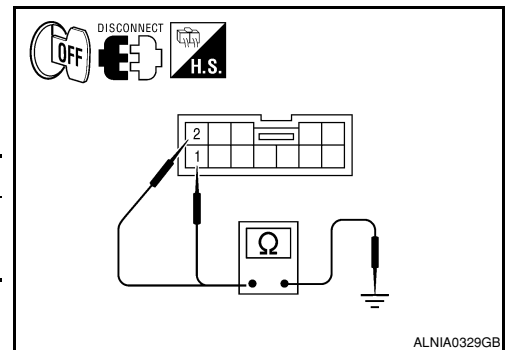

Does continuity exist?

YES >> INSPECTION END

NO >> Repair harness or connector.

## BLUETOOTH CONTROL UNIT

### BLUETOOTH CONTROL UNIT : Diagnosis Procedure

INFOID:000000001348258

## 1.CHECK FUSE

Check that the following fuses of the Bluetooth control unit are not blown.

Power source	Fuse No.
Battery	31
Ignition switch ACC or ON	4
Ignition switch ON or START	12

Is inspection result OK?

YES >> GO TO 2.

NO >> Be sure to eliminate cause of malfunction before installing new fuse.

## 2.CHECK POWER SUPPLY CIRCUIT

Check voltage between Bluetooth control unit harness connector B142 and ground.

Connector No.	Terminal No.	Ignition switch position	Value (Approx.)
B142	1	OFF	Battery voltage
	2	ACC	
	3	ON	

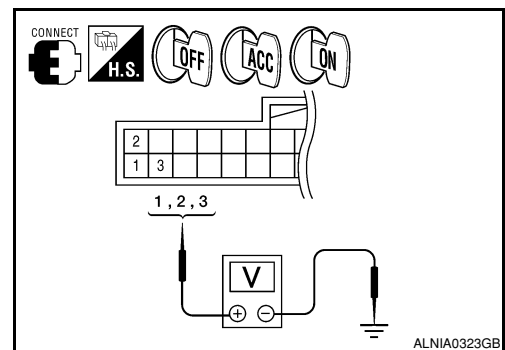

Is battery voltage present as specified?

YES >> GO TO 3.

NO >> Check harness between Bluetooth control unit and fuse.

## 3.CHECK GROUND CIRCUIT

# POWER SUPPLY AND GROUND CIRCUIT

[BOSE AUDIO WITHOUT NAVIGATION]

## < COMPONENT DIAGNOSIS >

1. Turn ignition switch OFF.
2. Disconnect Bluetooth control unit connector.
3. Check continuity between Bluetooth control unit harness connector B142 and ground.

Connector No.	Terminal No.	Ignition switch position	Continuity
B142	4, 21, 22, 23	OFF	Yes

Are continuity results as specified?

YES >> INSPECTION END

NO >> Repair harness or connector.

## MICROPHONE

### MICROPHONE : Diagnosis Procedure

INFOID:000000001348259

#### 1. CHECK POWER SUPPLY CIRCUIT (MICROPHONE SIDE)

1. Turn ignition switch ON.

Check voltage between microphone harness connector R109 terminal 4 and ground.

Signal name	Connector No.	Terminal No.	Ignition switch position	Value (Approx.)
MIC power	R109	4	ON	5V

Is approximately 5V present?

YES >> GO TO 4

NO >> GO TO 2

#### 2. CHECK POWER SUPPLY CIRCUIT (CONTINUITY)

1. Turn ignition switch OFF.
2. Disconnect microphone and Bluetooth control unit harness connectors.
3. Check continuity between microphone harness connector R109 (A) terminal 4 and Bluetooth control unit harness connector B142 (B) terminal 29.

A		B		Continuity
Connector	Terminal	Connector	Terminal	
R109	4	B142	29	Yes

4. Check continuity between microphone harness connector R109 (A) terminal 4 and ground.

A		—	Continuity
Connector	Terminal		
R109	4	Ground	No

Are the continuity test results as specified?

YES >> GO TO 3

NO >> Repair harness or connector.

#### 3. CHECK POWER SUPPLY CIRCUIT (BLUETOOTH CONTROL UNIT SIDE)

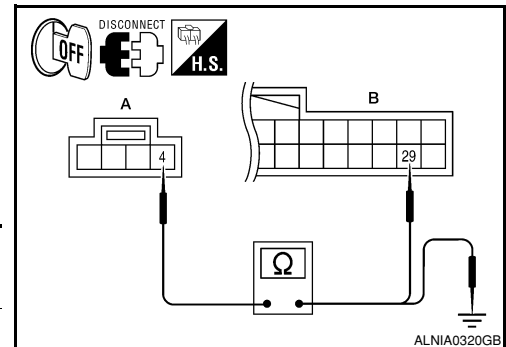
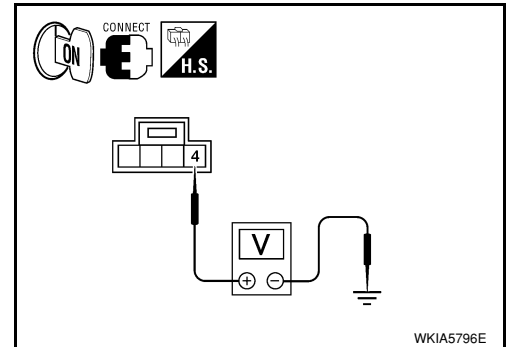
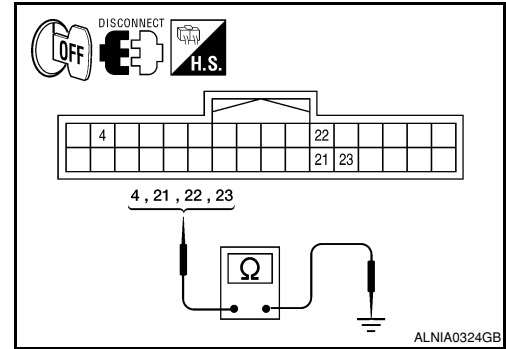

# POWER SUPPLY AND GROUND CIRCUIT

[BOSE AUDIO WITHOUT NAVIGATION]

## < COMPONENT DIAGNOSIS >

1. Connect Bluetooth control unit harness connector.
2. Turn ignition switch to ACC.
3. Check voltage between Bluetooth control unit harness connector B142 terminal 29 and ground.

Signal name	Connector No.	Terminal No.	Ignition switch position	Value (Approx.)
MIC power	B142	29	ACC	5V

Is approximately 5V present?

- YES >> Inspection End.  
 NO >> Replace Bluetooth control unit. Refer to [AV-277](#).  
"Removal and Installation"

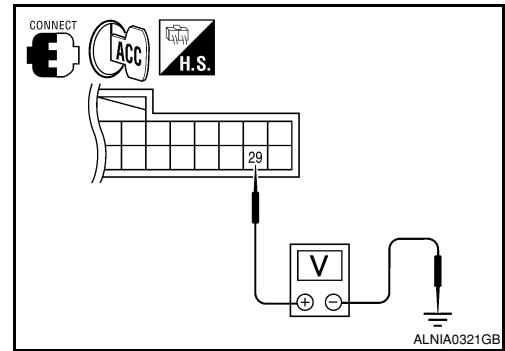

## 4.CHECK GROUND CIRCUIT

1. Turn ignition switch OFF.
2. Disconnect microphone harness connector R109 and Bluetooth control unit harness connector B142.
3. Check continuity between microphone harness connector R109 (A) terminal 2 and Bluetooth control unit harness connector B142 (B) terminal 8.

A		B		Continuity
Connector	Terminal	Connector	Terminal	
R109	2	B142	8	Yes

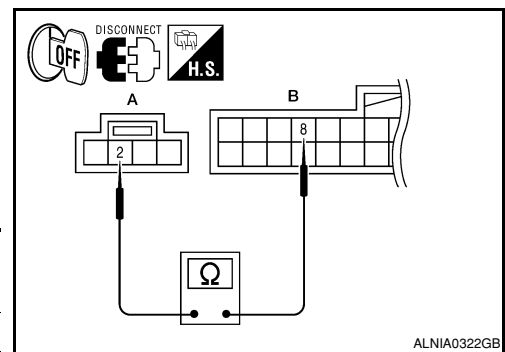

Does continuity exist?

- YES >> Inspection End.  
 NO >> Repair harness or connector.

A  
B  
C  
D  
E  
F  
G  
H  
I  
J  
K  
L  
M

AV

# RGB (R: RED) SIGNAL CIRCUIT

< COMPONENT DIAGNOSIS >

[BOSE AUDIO WITHOUT NAVIGATION]

## RGB (R: RED) SIGNAL CIRCUIT

### Description

INFOID:000000001348260

Transmit the image displayed with AV control unit with RGB signal to the display unit.

### Diagnosis Procedure

INFOID:000000001348261

#### 1. CHECK CONTINUITY RGB (R: RED) SIGNAL CIRCUIT

1. Turn ignition switch OFF.
2. Disconnect display unit connector M93 and AV control unit connector M44.
3. Check continuity between display unit harness connector M93 (A) terminal 17 and AV control unit harness connector M44 (B) terminal 40.

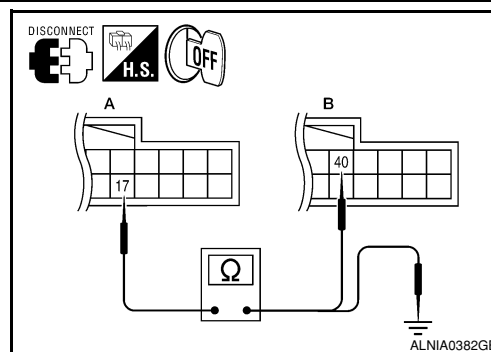

A		B		Continuity
Connector	Terminal	Connector	Terminal	
M93	17	M44	40	Yes

4. Check continuity between display unit harness connector M93 (A) terminal 17 and ground.

A		—	Continuity
Connector	Terminal		
M93	17	Ground	No

Are the continuity results as specified?

YES >> GO TO 2.

NO >> Repair harness or connector.

#### 2. CHECK RGB (R: RED) SIGNAL

1. Connect display unit connector M93 and AV control unit connector M44.
2. Turn ignition switch ON.
3. Check signal between display unit harness connector M93 terminal 17 and ground.

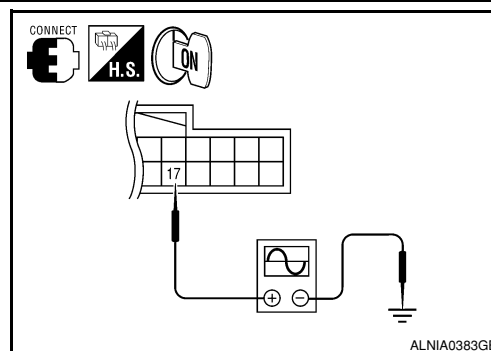

(+)		(-)	Condition	Reference signal
Connector	Terminal			
M93	17	Ground	Receive audio signal	<p>(V)</p> <p>0.4</p> <p>0</p> <p>-0.4</p> <p>40µs</p> <p>SKIB2238J</p>

Are the voltage readings as specified?

YES >> Replace display unit. Refer to [AV-106, "Removal and Installation"](#)

NO >> Replace AV control unit. Refer to [AV-104, "Removal and Installation"](#)

# RGB (G: GREEN) SIGNAL CIRCUIT

< COMPONENT DIAGNOSIS >

[BOSE AUDIO WITHOUT NAVIGATION]

## RGB (G: GREEN) SIGNAL CIRCUIT

### Description

INFOID:000000001348262

Transmit the image displayed with AV control unit with RGB signal to the display unit.

### Diagnosis Procedure

INFOID:000000001348263

#### 1. CHECK CONTINUITY RGB (G: GREEN) SIGNAL CIRCUIT

1. Turn ignition switch OFF.
2. Disconnect display unit connector M93 and AV control unit connector M44.
3. Check continuity between display unit harness connector M93 (A) terminal 6 and AV control unit harness connector M44 (B) terminal 39.

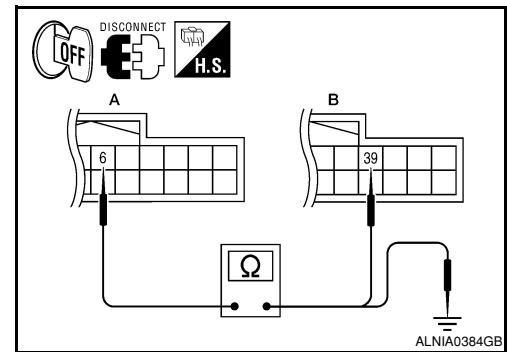

A		B		Continuity
Connector	Terminal	Connector	Terminal	
M93	6	M44	39	Yes

4. Check continuity between display unit harness connector M93 (A) terminal 6 and ground.

A		—	Continuity
Connector	Terminal		
M93	6	Ground	No

Are the continuity results as specified?

YES >> GO TO 2.

NO >> Repair harness or connector.

#### 2. CHECK RGB (G: GREEN) SIGNAL

1. Connect display unit connector M93 and AV control unit connector M44.
2. Turn ignition switch ON.
3. Check signal between display unit harness connector M93 terminal 6 and ground.

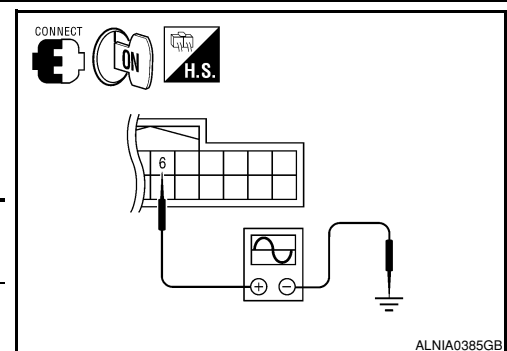

(+) Connector		(-)	Condition	Reference signal
Connector	Terminal			
M93	6	Ground	Receive audio signal	<p>SKIB2236J</p>

Are voltage readings as specified?

YES >> Replace display unit. Refer to [AV-106, "Removal and Installation"](#)

NO >> Replace AV control unit. Refer to [AV-104, "Removal and Installation"](#)

A  
B  
C  
D  
E  
F  
G  
H  
I  
J  
K  
L  
M  
AV  
O  
P

# RGB (B: BLUE) SIGNAL CIRCUIT

< COMPONENT DIAGNOSIS >

[BOSE AUDIO WITHOUT NAVIGATION]

## RGB (B: BLUE) SIGNAL CIRCUIT

### Description

INFOID:000000001348264

Transmit the image displayed with AV control unit with RGB signal to the display unit.

### Diagnosis Procedure

INFOID:000000001348265

#### 1. CHECK CONTINUITY RGB (B: BLUE) SIGNAL CIRCUIT

1. Turn ignition switch OFF.
2. Disconnect display unit connector M93 and AV control unit connector M44.
3. Check continuity between display unit harness connector M93 (A) terminal 18 and AV control unit harness connector M44 (B) terminal 38.

A		B		Continuity
Connector	Terminal	Connector	Terminal	
M93	18	M44	38	Yes

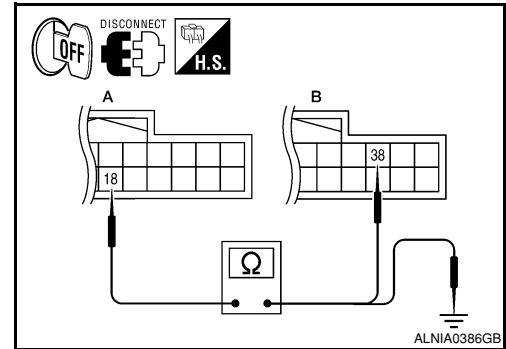

4. Check continuity between display unit harness connector M93 (A) terminal 18 and ground.

A		—	Continuity
Connector	Terminal		
M93	18	Ground	No

Are continuity results as specified?

- YES >> GO TO 2.  
 NO >> Repair harness or connector.

#### 2. CHECK RGB (B: BLUE) SIGNAL

1. Connect display unit connector M93 and AV control unit connector M44.
2. Turn ignition switch ON.
3. Check signal between display unit harness connector M93 terminal 18 and ground.

(+) Connector		(-)	Condition	Reference signal
Connector	Terminal			
M93	18	Ground	Receive audio signal	<p>SKIB2237J</p>

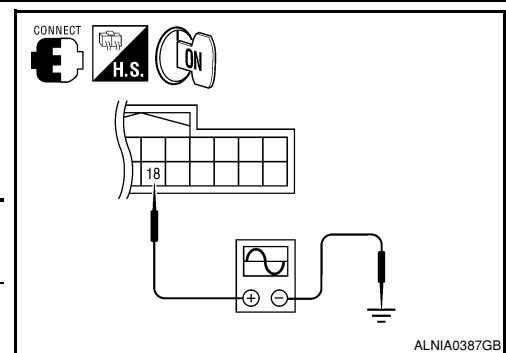

Are voltage readings as specified?

- YES >> Replace display unit. Refer to [AV-106, "Removal and Installation"](#)  
 NO >> Replace AV control unit. Refer to [AV-104, "Removal and Installation"](#)



# RGB SYNCHRONIZING SIGNAL CIRCUIT

< COMPONENT DIAGNOSIS >

[BOSE AUDIO WITHOUT NAVIGATION]

## RGB SYNCHRONIZING SIGNAL CIRCUIT

### Description

INFOID:000000001348266

Transmit the RGB synchronizing signal to the display unit so as to synchronize the RGB image displayed with AV control unit.

### Diagnosis Procedure

INFOID:000000001348267

#### 1. CHECK CONTINUITY RGB SYNCHRONIZING SIGNAL CIRCUIT

1. Turn ignition switch OFF.
2. Disconnect display unit connector M93 and AV control unit connector M44.
3. Check continuity between display unit harness connector M93 (A) terminal 19 and AV control unit harness connector M44 (B) terminal 41.

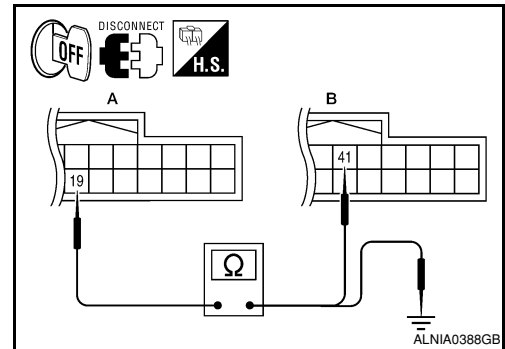

A		B		Continuity
Connector	Terminal	Connector	Terminal	
M93	19	M44	41	Yes

4. Check continuity between display unit harness connector M93 (A) terminal 19 and ground.

A		—	Continuity
Connector	Terminal		
M93	19	Ground	No

Are continuity results as specified?

YES >> GO TO 2.

NO >> Repair harness or connector.

#### 2. CHECK RGB SYNCHRONIZING SIGNAL

1. Connect display unit connector M93 and AV control unit connector M44.
2. Turn ignition switch ON.
3. Check signal between display unit harness connector M93 terminal 19 and ground.

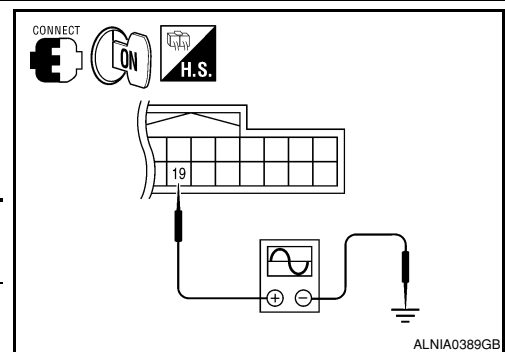

(+) Connector		(-)	Condition	Reference signal
Connector	Terminal			
M93	19	Ground	Receive audio signal	<p>SKIB3603E</p>

Are voltage readings as specified?

YES >> Replace display unit. Refer to [AV-106, "Removal and Installation"](#)

NO >> Replace AV control unit. Refer to [AV-104, "Removal and Installation"](#)

# RGB AREA (YS) SIGNAL CIRCUIT

< COMPONENT DIAGNOSIS >

[BOSE AUDIO WITHOUT NAVIGATION]

## RGB AREA (YS) SIGNAL CIRCUIT

### Description

INFOID:000000001348268

Transmits the display area of RGB image displayed by AV control unit with RGB area (YS) signal to display unit.

### Diagnosis Procedure

INFOID:000000001348269

#### 1. CHECK CONTINUITY RGB AREA (YS) SIGNAL CIRCUIT

1. Turn ignition switch OFF.
2. Disconnect display unit connector M93 and AV control unit connector M44.
3. Check continuity between display unit harness connector M93 (A) terminal 9 and AV control unit harness connector M44 (B) terminal 43.

A		B		Continuity
Connector	Terminal	Connector	Terminal	
M93	9	M44	43	Yes

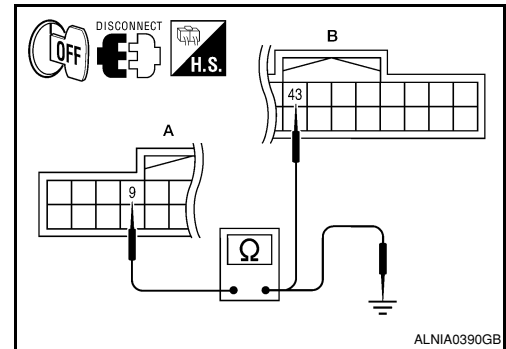

4. Check continuity between display unit harness connector M93 (A) terminal 9 and ground.

A		—	Continuity
Connector	Terminal		
M93	9	Ground	No

Are continuity results as specified?

YES >> GO TO 2.

NO >> Repair harness or connector.

#### 2. CHECK RGB SYNCHRONIZING SIGNAL

1. Connect display unit connector M93 and AV control unit connector M44.
2. Turn ignition switch ON.
3. Check signal between display unit harness connector M93 terminal 9 and ground.

(+) Connector		(-)	Condition	Reference signal
Terminal	Terminal			
M93	9	Ground	Receive audio signal	<p>PKIB4948J</p>

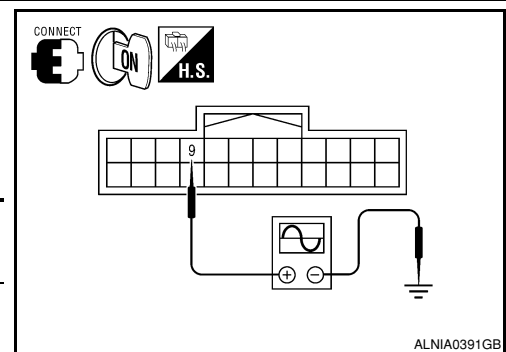

Are voltage readings as specified?

YES >> Replace display unit. Refer to [AV-106, "Removal and Installation"](#)

NO >> Replace AV control unit. Refer to [AV-104, "Removal and Installation"](#)

# HORIZONTAL SYNCHRONIZING (HP) SIGNAL CIRCUIT

< COMPONENT DIAGNOSIS >

[BOSE AUDIO WITHOUT NAVIGATION]

## HORIZONTAL SYNCHRONIZING (HP) SIGNAL CIRCUIT

### Description

INFOID:000000001348270

In composite image (AUX image, camera image), transmit the vertical synchronizing (VP) signal and horizontal synchronizing (HP) signal from display unit to AV control unit so as to synchronize the RGB images displayed with AV control unit such as the image quality adjusting menu, etc.

### Diagnosis Procedure

INFOID:000000001348271

#### 1. CHECK CONTINUITY HORIZONTAL SYNCHRONIZING (HP) SIGNAL CIRCUIT

1. Turn ignition switch OFF.
2. Disconnect display unit connector M93 and AV control unit connector M44.
3. Check continuity between display unit harness connector M93 (A) terminal 8 and AV control unit harness connector M44 (B) terminal 45.

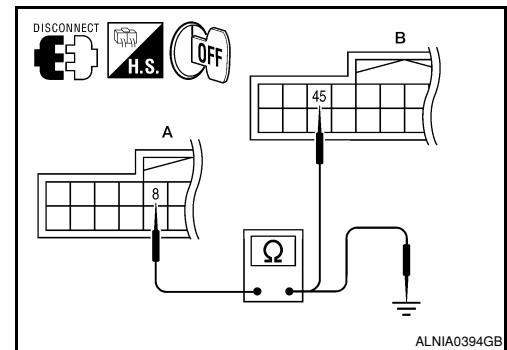

A		B		Continuity
Connector	Terminal	Connector	Terminal	
M93	8	M44	45	Yes

4. Check continuity between display unit harness connector M93 (A) terminal 8 and ground.

A		—	Continuity
Connector	Terminal		
M93	8	Ground	No

Are continuity results as specified?

YES >> GO TO 2.

NO >> Repair harness or connector.

#### 2. CHECK HORIZONTAL SYNCHRONIZING (HP) SIGNAL

1. Connect display unit connector M93 and AV control unit connector M44.
2. Turn ignition switch ON.
3. Check signal between display unit harness connector M93 terminal 8 and ground.

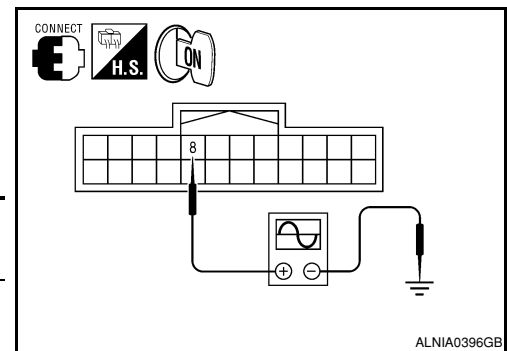

(+) Connector		(-)	Condition	Reference signal
Connector	Terminal			
M93	8	Ground	Receive audio signal	<p>SKIB3601E</p>

Are voltage readings as specified?

YES >> Replace AV control unit. Refer to [AV-104, "Removal and Installation"](#)

NO >> Replace display unit. Refer to [AV-106, "Removal and Installation"](#)

# VERTICAL SYNCHRONIZING (VP) SIGNAL CIRCUIT

< COMPONENT DIAGNOSIS >

[BOSE AUDIO WITHOUT NAVIGATION]

## VERTICAL SYNCHRONIZING (VP) SIGNAL CIRCUIT

### Description

INFOID:000000001348272

In composite image (AUX image, camera image), transmit the vertical synchronizing (VP) signal and horizontal synchronizing (HP) signal from display unit to AV control unit so as to synchronize the RGB images displayed with AV control unit such as the image quality adjusting menu, etc.

### Diagnosis Procedure

INFOID:000000001348273

#### 1. CHECK CONTINUITY VERTICAL SYNCHRONIZING (VP) SIGNAL CIRCUIT

1. Turn ignition switch OFF.
2. Disconnect display unit connector M93 and AV control unit connector M44.
3. Check continuity between display unit harness connector M93 (A) terminal 20 and AV control unit harness connector M44 (B) terminal 57.

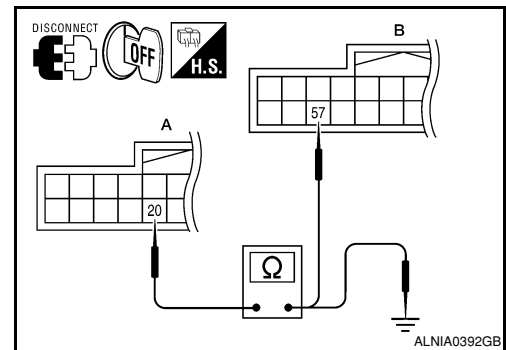

A		B		Continuity
Connector	Terminal	Connector	Terminal	
M93	20	M44	57	Yes

4. Check continuity between display unit harness connector M93 (A) terminal 20 and ground.

A		—	Continuity
Connector	Terminal		
M93	20	Ground	No

Are continuity results as specified?

YES >> GO TO 2.

NO >> Repair harness or connector.

#### 2. CHECK VERTICAL SYNCHRONIZING (VP) SIGNAL

1. Connect display unit connector M93 and AV control unit connector M44.
2. Turn ignition switch ON.
3. Check signal between display unit harness connector M93 terminal 20 and ground.

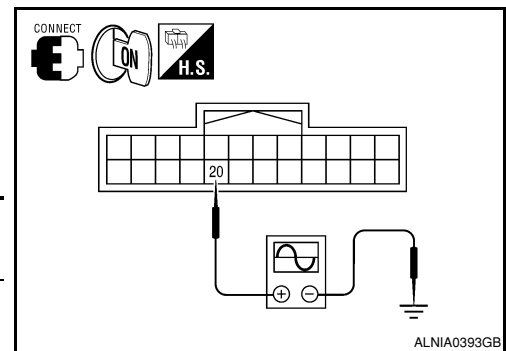

(+)		(-)	Condition	Reference signal
Connector	Terminal			
M93	20	Ground	Receive audio signal	<p>(V)</p> <p>4</p> <p>0</p> <p>4ms</p> <p>SKIB3598E</p>

Are voltage readings as specified?

YES >> Replace AV control unit. Refer to [AV-104. "Removal and Installation"](#)

NO >> Replace display unit. Refer to [AV-106. "Removal and Installation"](#)

# FRONT DOOR SPEAKER

[BOSE AUDIO WITHOUT NAVIGATION]

< COMPONENT DIAGNOSIS >

## FRONT DOOR SPEAKER

### Description

INFOID:000000001278746

The AV control unit sends audio signals to the BOSE speaker amp. The BOSE speaker amp. amplifies the audio signals before sending them to the front door speakers using the audio signal circuits.

### Diagnosis Procedure

INFOID:000000001278747

#### 1. HARNESS CHECK

1. Disconnect BOSE speaker amp. connector M112 and suspect speaker connector.
2. Check continuity between BOSE speaker amp. harness connector M112 (A) and suspect speaker harness connector (B).

A		B		Continuity
Connector	Terminal	Connector	Terminal	
M112	4	D12	1	Yes
	5		2	
	8	D112	1	
	13		2	

3. Check continuity between BOSE speaker amp. harness connector M112 (A) and ground.

A		—	Continuity
Connector	Terminal		
M112	4	Ground	No
	5		
	8		
	13		

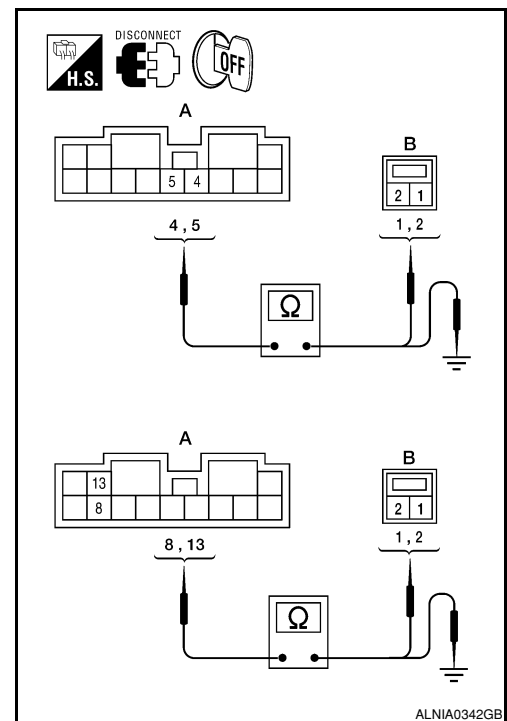

Are continuity test results as specified?

YES >> GO TO 2

- NO >> • Check connector housings for disconnected or loose terminals.  
• Repair harness or connector.

#### 2. FRONT SPEAKER SIGNAL CHECK

A  
B  
C  
D  
E  
F  
G  
H  
I  
J  
K  
L  
M  
O  
P

AV

# FRONT DOOR SPEAKER

[BOSE AUDIO WITHOUT NAVIGATION]

## < COMPONENT DIAGNOSIS >

1. Connect BOSE speaker amp. connector M112 and suspect speaker connector.
2. Turn ignition switch to ACC.
3. Push "POWER" switch.
4. Check the signal between BOSE speaker amp. harness connector M112 terminals with CONSULT-III or oscilloscope.

Connector	Terminal		Condition	Reference signal
	(+)	(-)		
M112	4	5	Receive audio signal	
	8	13		

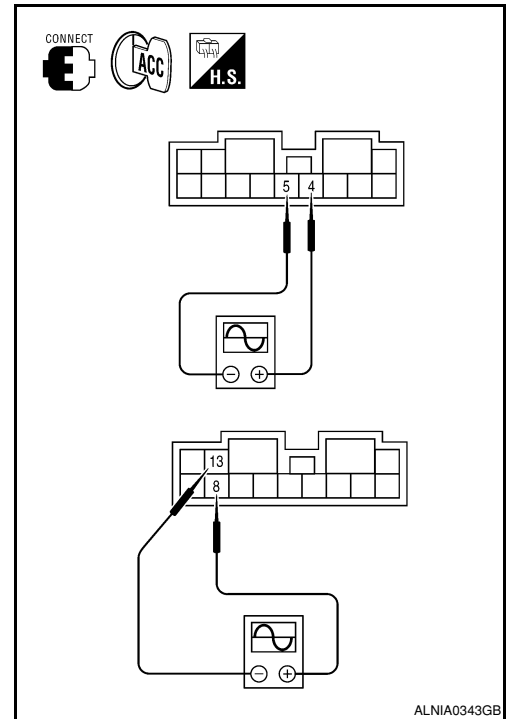

Is audio signal voltage as specified?

YES >> Replace suspect speaker. Refer to [AV-263. "Removal and Installation"](#).

NO >> GO TO 3

### 3. HARNESS CHECK

1. Disconnect AV control unit connector M72 and BOSE speaker amp. connector M113.
2. Check continuity between AV control unit harness connector M72 (A) and BOSE speaker amp. harness connector M113 (B).

A		B		Continuity
Connector	Terminal	Connector	Terminal	
M72	113	M113	18	Yes
	119		32	
	109		19	
	115		20	

3. Check continuity between AV control unit harness connector M72 (A) and ground.

A		—	Continuity
Connector	Terminal		
M72	113	Ground	No
	119		
	109		
	115		

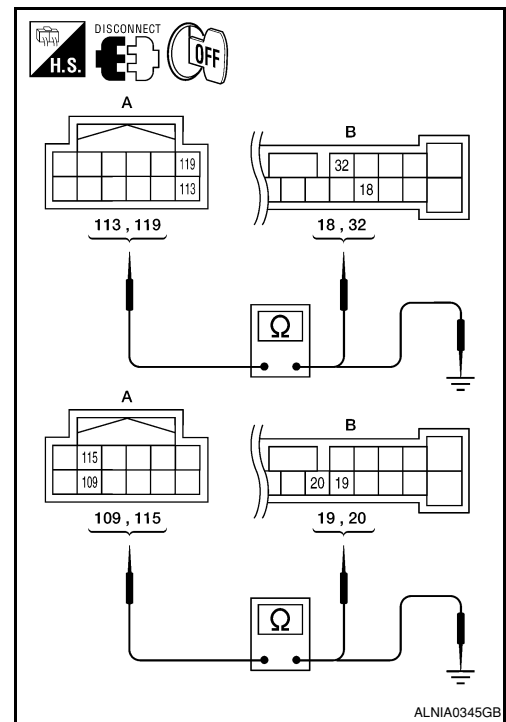

Are continuity test results as specified?

YES >> GO TO 4

NO >> • Check connector housings for disconnected or loose terminals.  
• Repair harness or connector.

### 4. FRONT SPEAKER SIGNAL CHECK

# FRONT DOOR SPEAKER

[BOSE AUDIO WITHOUT NAVIGATION]

## < COMPONENT DIAGNOSIS >

1. Connect AV control unit connector and BOSE speaker amp. connector.
2. Turn ignition switch ACC.
3. Push "POWER" switch.
4. Check the signal between AV control unit harness connector M72 terminals with CONSULT-III or oscilloscope.

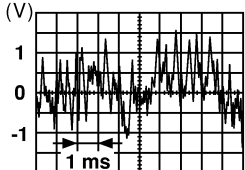
Connector	Terminals		Condition	Reference signal
	(+)	(-)		
M72	113	119	Receive audio signal	
	109	115		

SKIA0177E

Are the audio signal voltage readings as specified?

- YES >> Replace BOSE speaker amp. Refer to [AV-271, "Removal and Installation"](#).
- NO >> Replace AV control unit. Refer to [AV-259, "Removal and Installation"](#).

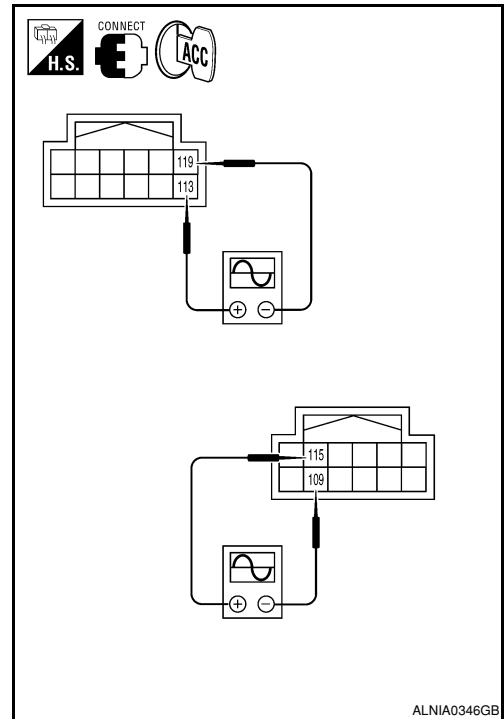

A  
B  
C  
D  
E  
F  
G  
H  
I  
J  
K  
L  
M  
O  
P

AV

# FRONT TWEETER

< COMPONENT DIAGNOSIS >

[BOSE AUDIO WITHOUT NAVIGATION]

## FRONT TWEETER

### Description

INFOID:000000001278748

The AV control unit sends audio signals to the BOSE speaker amp. The BOSE speaker amp. amplifies the audio signals before sending them to the tweeters using the audio signal circuits.

### Diagnosis Procedure

INFOID:000000001316627

#### 1. HARNESS CHECK

1. Disconnect BOSE speaker amp. connector M112 and suspect tweeter connector.
2. Check continuity between BOSE speaker amp. harness connector M112 (A) and suspect tweeter harness connector (B).

A		B		Continuity
Connector	Terminal	Connector	Terminal	
M112	4	M109	1	Yes
	5		2	
	8	M111	1	
	13		2	

3. Check continuity between BOSE speaker amp. harness connector M112 (A) and ground.

A		—	Continuity
Connector	Terminal		
M112	4	Ground	No
	5		
	8		
	13		

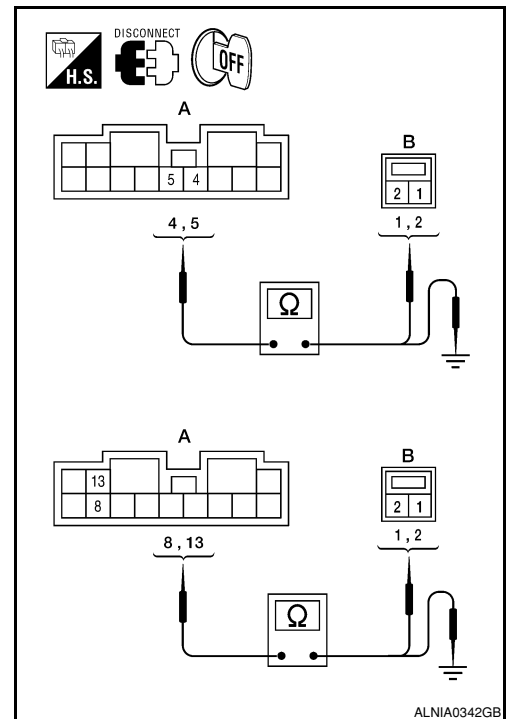

ALNIA0342GB

Are continuity test results as specified?

YES >> GO TO 2

- NO >> • Check connector housings for disconnected or loose terminals.  
• Repair harness or connector.

#### 2. FRONT TWEETER SIGNAL CHECK



# FRONT TWEETER

[BOSE AUDIO WITHOUT NAVIGATION]

## < COMPONENT DIAGNOSIS >

1. Connect BOSE speaker amp. connector M112 and suspect tweeter connector.
2. Turn ignition switch to ACC.
3. Push "POWER" switch.
4. Check the signal between BOSE speaker amp. harness connector M112 terminals with CONSULT-III or oscilloscope.

Connector	Terminal		Condition	Reference signal
	(+)	(-)		
M112	4	5	Receive audio signal	
	8	13		

Is audio signal voltage as specified?

YES >> Replace suspect tweeter. Refer to [AV-261. "Removal and Installation"](#).

NO >> GO TO 3

### 3. HARNESS CHECK

1. Disconnect AV control unit connector M72 and BOSE speaker amp. connector M113.
2. Check continuity between AV control unit harness connector M72 (A) and BOSE speaker amp. harness connector M113 (B).

A		B		Continuity
Connector	Terminal	Connector	Terminal	
M72	113	M113	18	Yes
	119		32	
	109		19	
	115		20	

3. Check continuity between AV control unit harness connector M72 (A) and ground.

A		—	Continuity
Connector	Terminal		
M72	113	Ground	No
	119		
	109		
	115		

Are continuity test results as specified?

YES >> GO TO 4

NO >> • Check connector housings for disconnected or loose terminals.  
• Repair harness or connector.

### 4. FRONT TWEETER SIGNAL CHECK

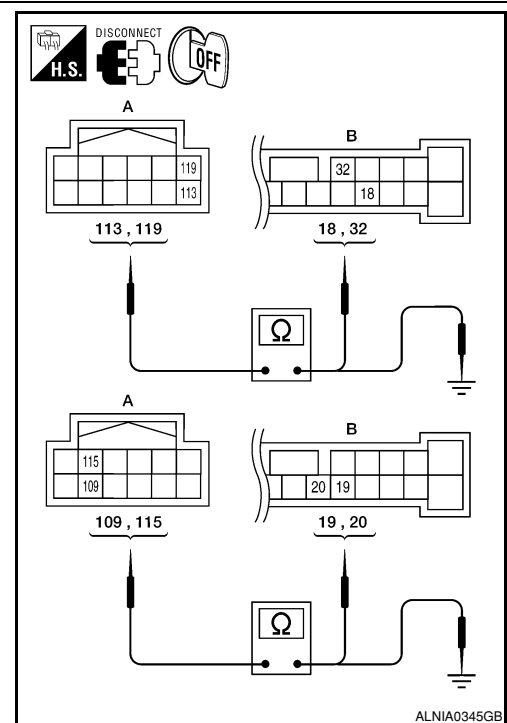
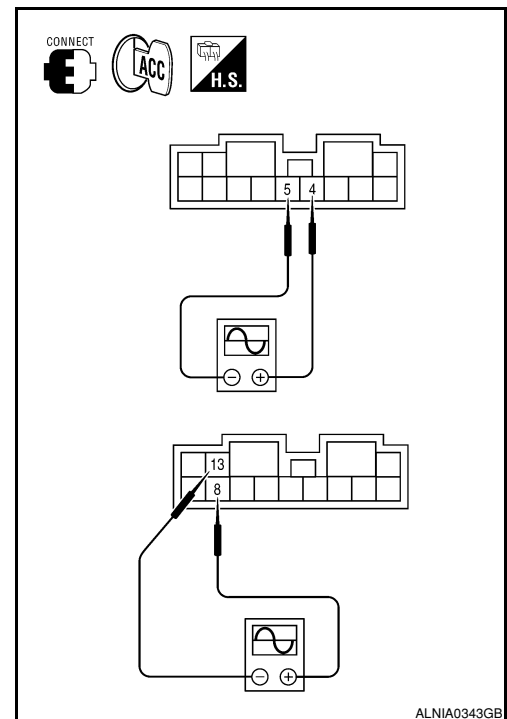

A  
B  
C  
D  
E  
F  
G  
H  
I  
J  
K  
L  
M  
O  
P

AV

# FRONT TWEETER

[BOSE AUDIO WITHOUT NAVIGATION]

< COMPONENT DIAGNOSIS >

1. Connect AV control unit connector and BOSE speaker amp. connector.
2. Turn ignition switch ACC.
3. Push "POWER" switch.
4. Check the signal between AV control unit harness connector M72 terminals with CONSULT-III or oscilloscope.

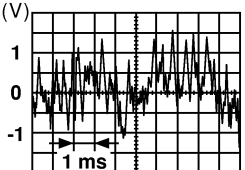
Connector	Terminals		Condition	Reference signal
	(+)	(-)		
M72	113	119	Receive audio signal	
	109	115		

SKIA0177E

Are the audio signal voltage readings as specified?

- YES >> Replace BOSE speaker amp. Refer to [AV-271, "Removal and Installation"](#).
- NO >> Replace AV control unit. Refer to [AV-259, "Removal and Installation"](#).

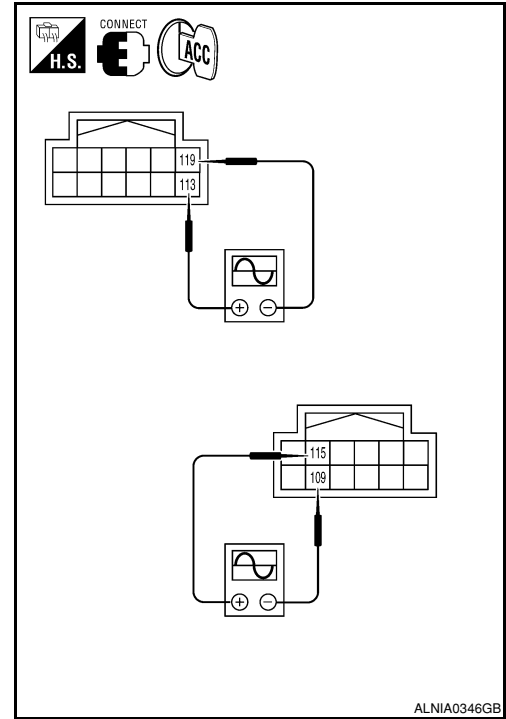

ALNIA0346GB

# CENTER SPEAKER

< COMPONENT DIAGNOSIS >

[BOSE AUDIO WITHOUT NAVIGATION]

## CENTER SPEAKER

### Description

INFOID:000000001278750

The AV control unit sends audio signals to the BOSE speaker amp. The BOSE speaker amp. amplifies the audio signals before sending them to the center speaker using the audio signal circuits.

### Diagnosis Procedure

INFOID:000000001278751

#### 1. HARNESS CHECK

1. Disconnect BOSE speaker amp. connector M113 and center speaker connector M110.
2. Check continuity between BOSE speaker amp. harness connector M113 (A) and center speaker harness connector M110 (B).

A		B		Continuity
Connector	Terminal	Connector	Terminal	
M113	15	M110	1	Yes
	28		2	

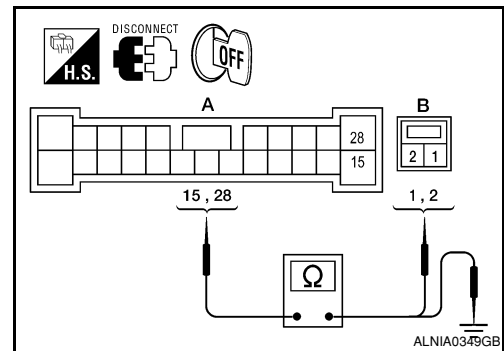

3. Check continuity between BOSE speaker amp. harness connector M113 (A) and ground.

A		—	Continuity
Connector	Terminal		
M113	15	Ground	No
	28		

Are continuity test results as specified?

YES >> GO TO 2

NO >> • Check connector housings for disconnected or loose terminals.  
• Repair harness or connector.

#### 2. CENTER SPEAKER SIGNAL CHECK

1. Connect BOSE speaker amp. connector M113 and center speaker connector M110.
2. Turn ignition switch to ACC.
3. Push "POWER" switch.
4. Check the signal between BOSE speaker amp. harness connector M113 terminals with CONSULT-III or oscilloscope.

Connector	Terminals		Condition	Reference signal
	(+)	(-)		
M113	15	28	Receive audio signal	<p>SKIA0177E</p>

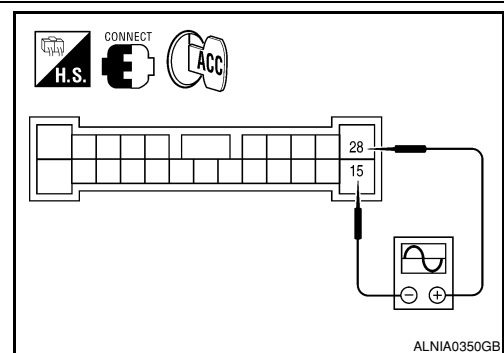

Is the audio signal voltage reading as specified?

YES >> Replace center speaker. Refer to [AV-262. "Removal and Installation"](#).

NO >> GO TO 3

#### 3. HARNESS CHECK

# CENTER SPEAKER

[BOSE AUDIO WITHOUT NAVIGATION]

## < COMPONENT DIAGNOSIS >

1. Disconnect AV control unit connector M72 and BOSE speaker amp. connector M113.
2. Check continuity between AV control unit harness connector M72 (A) and BOSE speaker amp. harness connector M113 (B).

A		B		Continuity
Connector	Terminal	Connector	Terminal	
M72	113	M113	18	Yes
	119		32	
	109		19	
	115		20	

3. Check continuity between AV control unit harness connector M72 (A) and ground.

A		—	Continuity
Connector	Terminal		
M72	113	Ground	No
	119		
	109		
	115		

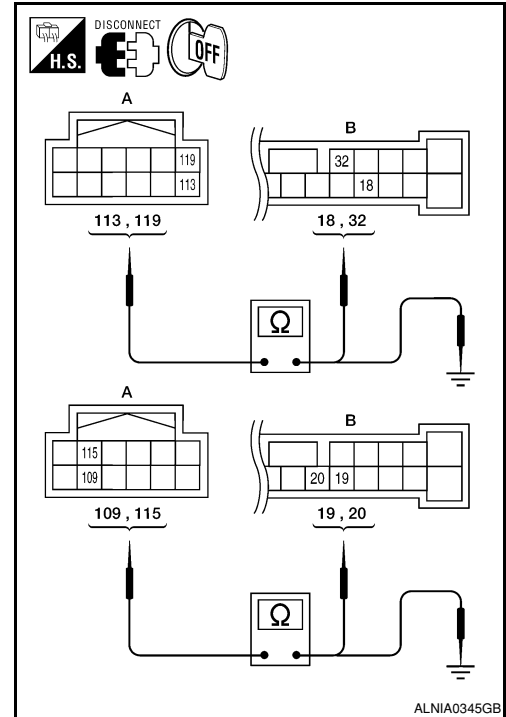

Are continuity test results as specified?

YES >> GO TO 4

NO >> • Check connector housings for disconnected or loose terminals.  
• Repair harness or connector.

## 4. CENTER SPEAKER SIGNAL CHECK

1. Connect AV control unit connector and BOSE speaker amp. connector.
2. Turn ignition switch ACC.
3. Push "POWER" switch.
4. Check the signal between AV control unit harness connector M72 terminals with CONSULT-III or oscilloscope.

Connector	Terminals		Condition	Reference signal
	(+)	(-)		
M72	113	119	Receive audio signal	
	109	115		

SKIA0177E

Are the audio signal voltage readings as specified?

YES >> Replace BOSE speaker amp. Refer to [AV-271, "Removal and Installation"](#).

NO >> Replace AV control unit. Refer to [AV-259, "Removal and Installation"](#).

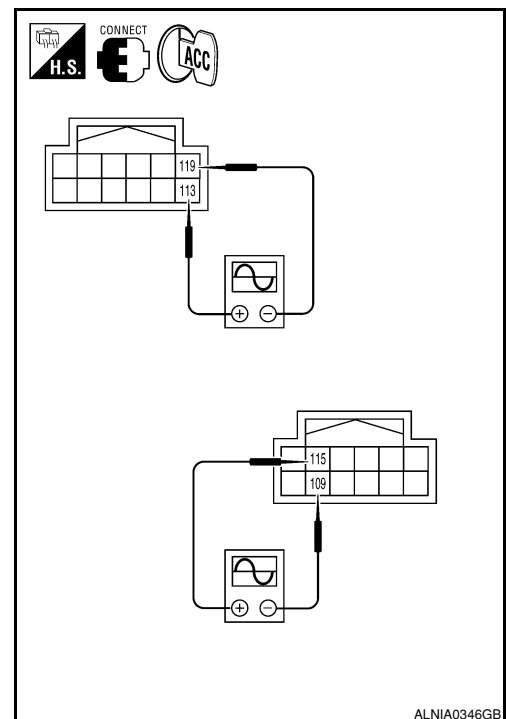

# REAR DOOR SPEAKER

[BOSE AUDIO WITHOUT NAVIGATION]

< COMPONENT DIAGNOSIS >

## REAR DOOR SPEAKER

### Description

INFOID:000000001278752

The AV control unit sends audio signals to the BOSE speaker amp. The BOSE speaker amp. amplifies the audio signals before sending them to the rear door speakers using the audio signal circuits.

### Diagnosis Procedure

INFOID:000000001278753

#### 1. HARNESS CHECK

1. Disconnect BOSE speaker amp. connectors M112 and suspect speaker connector.
2. Check continuity between BOSE speaker amp. harness connectors M112 (A) and suspect speaker harness connector (B).

A		B		Continuity
Connector	Terminal	Connector	Terminal	
M112	1	D207	1	Yes
	10		2	
	2	D307	1	
	3		2	

3. Check continuity between BOSE speaker amp. harness connectors M112 (A) and ground.

Connector	Terminal	-	Continuity
M112	1	Ground	No
	10		
	2		
	3		

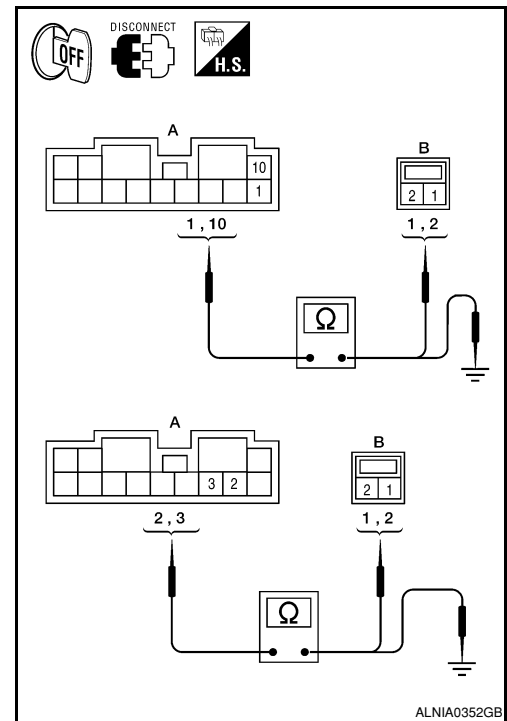

ALNIA0352GB

Are the continuity test results as specified?

YES >> GO TO 2

NO >> • Check connector housings for disconnected or loose terminals.  
• Repair harness or connector.

#### 2. REAR DOOR SPEAKER SIGNAL CHECK

A  
B  
C  
D  
E  
F  
G  
H  
I  
J  
K  
L  
M  
O  
P

AV

# REAR DOOR SPEAKER

[BOSE AUDIO WITHOUT NAVIGATION]

## < COMPONENT DIAGNOSIS >

1. Connect BOSE speaker amp. connectors and suspect speaker connector.
2. Turn ignition switch to ACC.
3. Push "POWER" switch.
4. Check the signal between BOSE speaker amp. harness connectors M112 terminals with CONSULT-III or oscilloscope.

Connector	Terminals		Condition	Reference signal
	(+)	(-)		
M112	1	10	Receive audio signal	
	2	3		

SKIA0177E

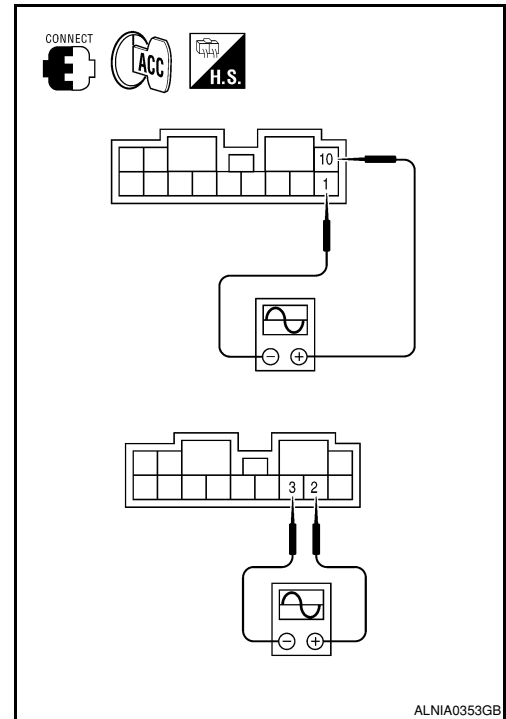

Are audio signal voltage readings as specified?

YES >> Replace suspect speaker. Refer to [AV-264, "Removal and Installation"](#).

NO >> GO TO 3

## 3. HARNESS CHECK

1. Disconnect AV control unit connector M72 and BOSE speaker amp. connector M113.
2. Check continuity between AV control unit harness connector M72 (A) and BOSE speaker amp. harness connector M113 (B).

A		B		Continuity
Connector	Terminal	Connector	Terminal	
M72	112	M113	21	Yes
	118		22	
	108		23	
	114		33	

3. Check continuity between AV control unit harness connector M72 (A) and ground.

A		—	Continuity
Connector	Terminal		
M72	112	Ground	No
	118		
	108		
	114		

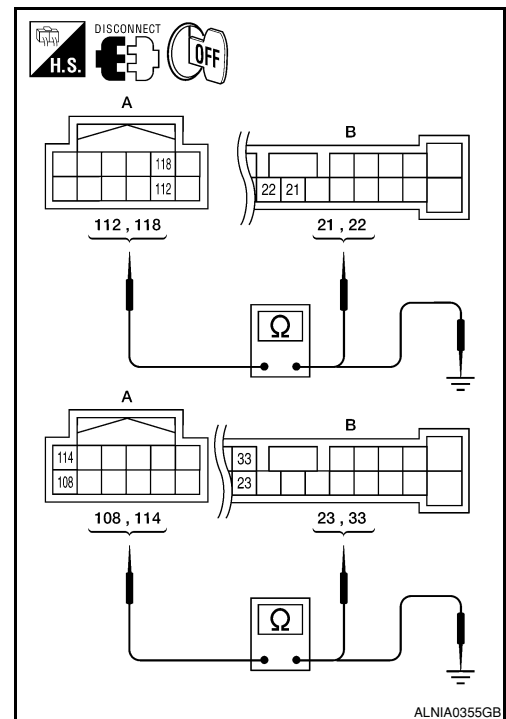

Are the continuity test results as specified?

YES >> GO TO 4

NO >> • Check connector housings for disconnected or loose terminals.  
• Repair harness or connector.

## 4. REAR DOOR SPEAKER SIGNAL CHECK

# REAR DOOR SPEAKER

[BOSE AUDIO WITHOUT NAVIGATION]

< COMPONENT DIAGNOSIS >

1. Connect AV control unit connector M72 and BOSE speaker amp. connector M113.
2. Turn ignition switch to ACC.
3. Push "POWER" switch.
4. Check the signal between AV control unit harness connector M72 terminals with CONSULT-III or oscilloscope.

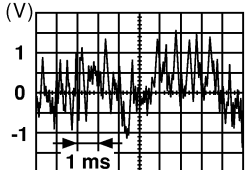
Connector	Terminals		Condition	Reference signal
	(+)	(-)		
M72	112	118	Receive audio signal	 <p style="text-align: right; font-size: small;">SKIA0177E</p>
	108	114		

Is the audio signal voltage reading as specified?

- YES >> Replace BOSE speaker amp. Refer to [AV-271, "Removal and Installation"](#).
- NO >> Replace AV control unit. Refer to [AV-259, "Removal and Installation"](#).

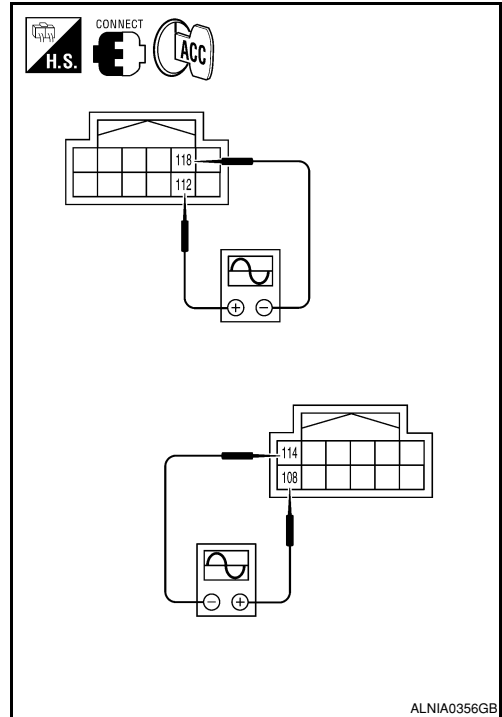

A  
B  
C  
D  
E  
F  
G  
H  
I  
J  
K  
L  
M  
O  
P

AV

# REAR TWEETER

[BOSE AUDIO WITHOUT NAVIGATION]

< COMPONENT DIAGNOSIS >

## REAR TWEETER

### Description

INFOID:000000001316628

The AV control unit sends audio signals to the BOSE speaker amp. The BOSE speaker amp. amplifies the audio signals before sending them to the rear tweeters using the audio signal circuits.

### Diagnosis Procedure

INFOID:000000001316629

#### 1. HARNESS CHECK

1. Disconnect BOSE speaker amp. connectors M112 and suspect tweeter connector.
2. Check continuity between BOSE speaker amp. harness connectors M112 (A) and suspect tweeter harness connector (B).

A		B		Continuity
Connector	Terminal	Connector	Terminal	
M112	1	D208	1	Yes
	10		2	
	2	D308	1	
	3		2	

3. Check continuity between BOSE speaker amp. harness connectors M112 (A) and ground.

Connector	Terminal	-	Continuity
M112	1	Ground	No
	10		
	2		
	3		

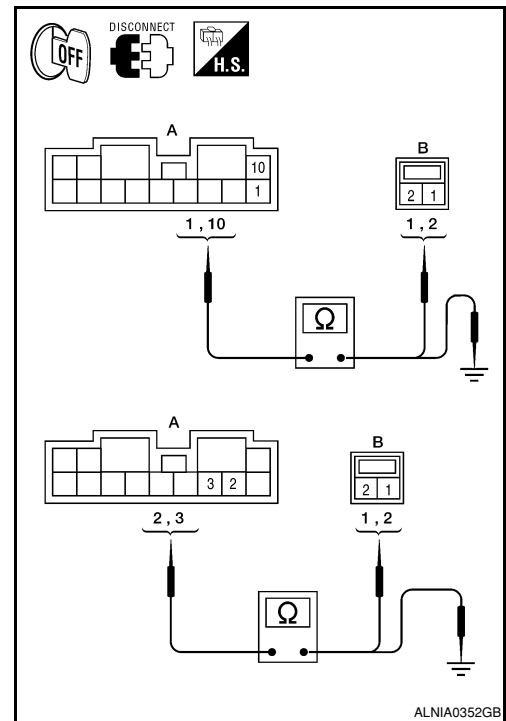

Are the continuity test results as specified?

YES >> GO TO 2

NO >> • Check connector housings for disconnected or loose terminals.  
• Repair harness or connector.

#### 2. REAR TWEETER SIGNAL CHECK



# REAR TWEETER

[BOSE AUDIO WITHOUT NAVIGATION]

## < COMPONENT DIAGNOSIS >

1. Connect BOSE speaker amp. connectors and suspect tweeter connector.
2. Turn ignition switch to ACC.
3. Push "POWER" switch.
4. Check the signal between BOSE speaker amp. harness connectors M112 terminals with CONSULT-III or oscilloscope.

Connector	Terminals		Condition	Reference signal
	(+)	(-)		
M112	1	10	Receive audio signal	
	2	3		

SKIA0177E

Are audio signal voltage readings as specified?

YES >> Replace suspect tweeter. Refer to [AV-264, "Removal and Installation"](#).

NO >> GO TO 3

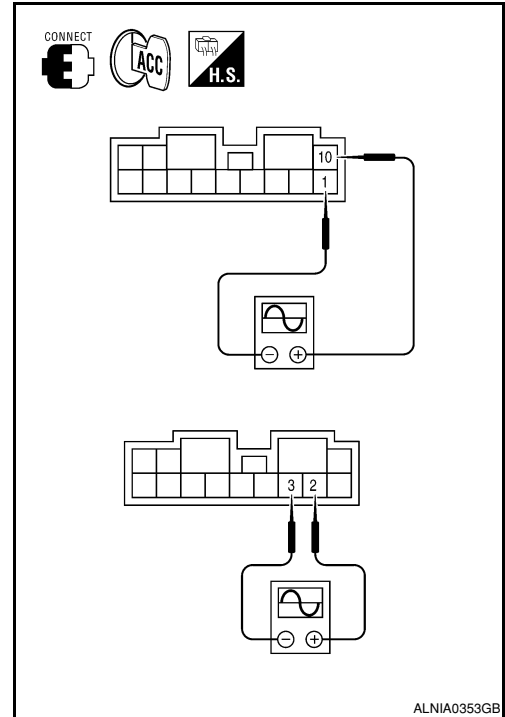

## 3. HARNESS CHECK

1. Disconnect AV control unit connector M72 and BOSE speaker amp. connector M113.
2. Check continuity between AV control unit harness connector M72 (A) and BOSE speaker amp. harness connector M113 (B).

A		B		Continuity
Connector	Terminal	Connector	Terminal	
M72	112	M113	21	Yes
	118		22	
	108		23	
	114		33	

3. Check continuity between AV control unit harness connector M72 (A) and ground.

A		—	Continuity
Connector	Terminal		
M72	112	Ground	No
	118		
	108		
	114		

Are the continuity test results as specified?

YES >> GO TO 4

NO >> • Check connector housings for disconnected or loose terminals.  
• Repair harness or connector.

## 4. REAR TWEETER SIGNAL CHECK

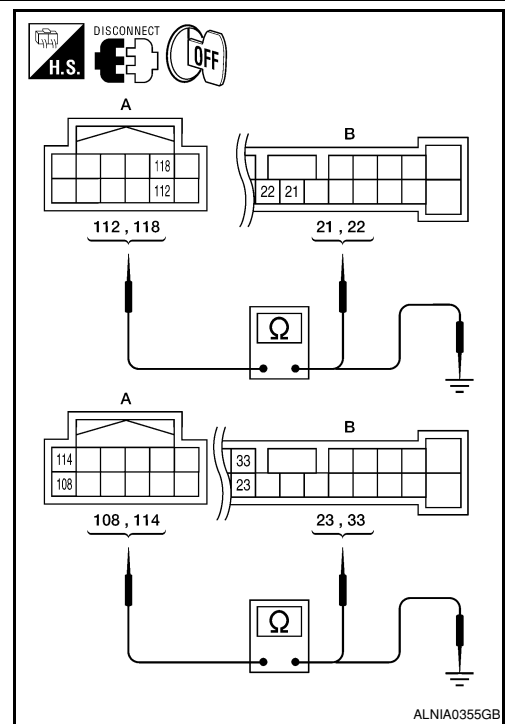

A  
B  
C  
D  
E  
F  
G  
H  
I  
J  
K  
L  
M  
O  
P

AV

# REAR TWEETER

[BOSE AUDIO WITHOUT NAVIGATION]

## < COMPONENT DIAGNOSIS >

1. Connect AV control unit connector M72 and BOSE speaker amp. connector M113.
2. Turn ignition switch to ACC.
3. Push "POWER" switch.
4. Check the signal between AV control unit harness connector M72 terminals with CONSULT-III or oscilloscope.

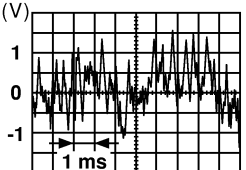
Connector	Terminals		Condition	Reference signal
	(+)	(-)		
M72	112	118	Receive audio signal	 <p style="text-align: right; font-size: small;">SKIA0177E</p>
	108	114		

Is the audio signal voltage reading as specified?

- YES >> Replace BOSE speaker amp. Refer to [AV-271, "Removal and Installation"](#).
- NO >> Replace AV control unit. Refer to [AV-259, "Removal and Installation"](#).

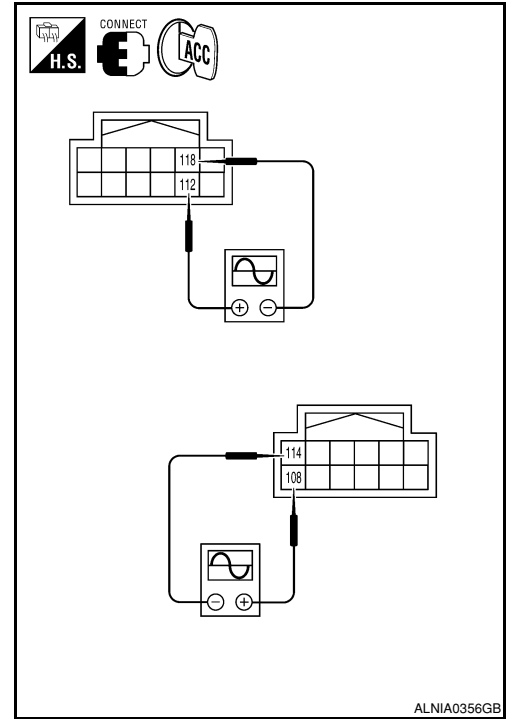

# BACK DOOR SPEAKER

[BOSE AUDIO WITHOUT NAVIGATION]

< COMPONENT DIAGNOSIS >

## BACK DOOR SPEAKER

### Description

INFOID:000000001316630

The AV control unit sends audio signals to the BOSE speaker amp. The BOSE speaker amp. amplifies the audio signals before sending them to the back door speakers using the audio signal circuits.

### Diagnosis Procedure

INFOID:000000001316631

#### 1. HARNESS CHECK

1. Disconnect BOSE speaker amp. connectors and suspect speaker connector.
2. Check continuity between BOSE speaker amp. harness connectors M112 and M113 (A) and suspect speaker harness connector (B).

A		B		Continuity
Connector	Terminal	Connector	Terminal	
M112	6	IH: D518	1	Yes
	7		2	
M113	37	RH: D716	1	
	27		2	

3. Check continuity between BOSE speaker amp. harness connectors M112 and M113 (A) and ground.

Connector	Terminal	-	Continuity
M112	6	Ground	No
	7		
M113	37		
	27		

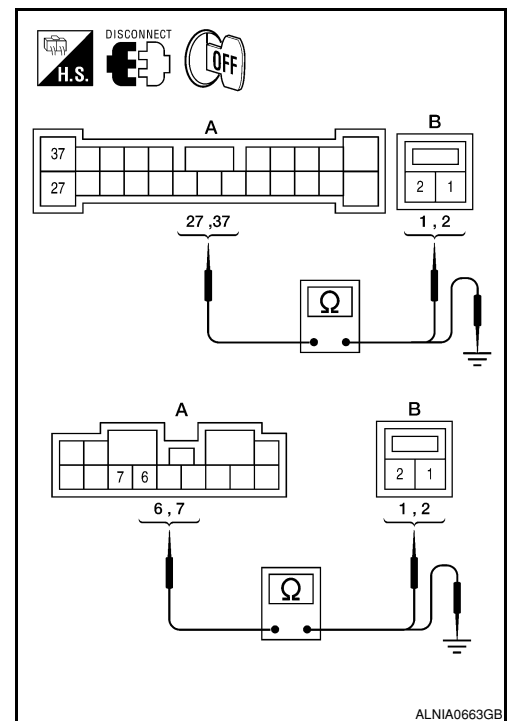

ALNIA0663GB

Are the continuity test results as specified?

YES >> GO TO 2

NO >> • Check connector housings for disconnected or loose terminals.  
• Repair harness or connector.

#### 2. BACK DOOR SPEAKER SIGNAL CHECK

A  
B  
C  
D  
E  
F  
G  
H  
I  
J  
K  
L  
M  
O  
P

AV

# BACK DOOR SPEAKER

[BOSE AUDIO WITHOUT NAVIGATION]

## < COMPONENT DIAGNOSIS >

1. Connect BOSE speaker amp. connectors and suspect speaker connector.
2. Turn ignition switch to ACC.
3. Push "POWER" switch.
4. Check the signal between BOSE speaker amp. harness connectors M113 terminals with CONSULT-III or oscilloscope.

Connector	Terminals		Condition	Reference signal
	(+)	(-)		
M112	6	7	Receive audio signal	
M113	37	27		

SKIA0177E

Are audio signal voltage readings as specified?

YES >> Replace suspect speaker. Refer to [AV-265. "Removal and Installation"](#).

NO >> GO TO 3

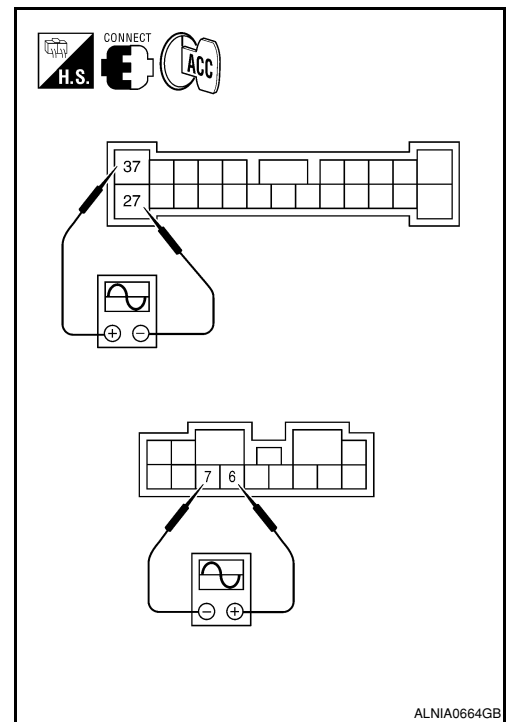

## 3. HARNESS CHECK

1. Turn ignition switch OFF
2. Disconnect AV control unit connector M72 and BOSE speaker amp. connector M113.
3. Check continuity between AV control unit harness connector M72 (A) and BOSE speaker amp. harness connector M113 (B).

A		B		Continuity
Connector	Terminal	Connector	Terminal	
M72	112	M113	21	Yes
	118		22	
	108		23	
	114		33	

4. Check continuity between AV control unit harness connector M72 (A) and ground.

A		—	Continuity
Connector	Terminal		
M72	112	Ground	No
	118		
	108		
	114		

Are the continuity test results as specified?

YES >> GO TO 4

NO >> • Check connector housings for disconnected or loose terminals.  
• Repair harness or connector.

## 4. BACK DOOR SPEAKER SIGNAL CHECK

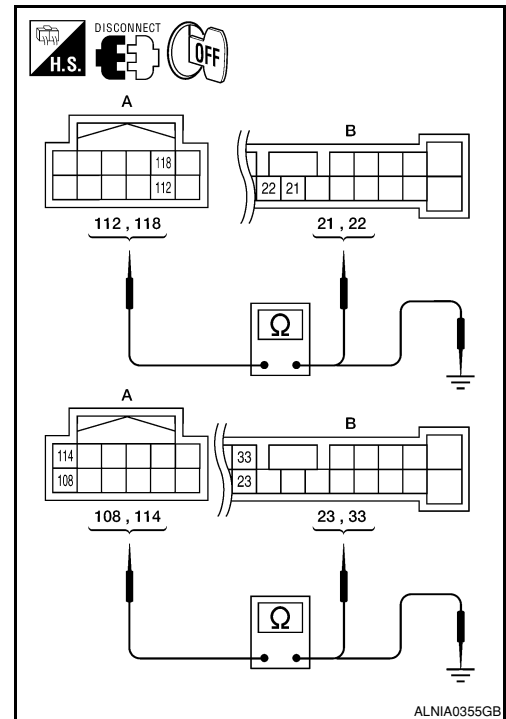

# BACK DOOR SPEAKER

[BOSE AUDIO WITHOUT NAVIGATION]

## < COMPONENT DIAGNOSIS >

1. Connect AV control unit connector M72 and BOSE speaker amp. connector M113.
2. Turn ignition switch to ACC.
3. Push "POWER" switch.
4. Check the signal between AV control unit harness connector M72 terminals with CONSULT-III or oscilloscope.

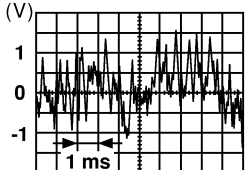
Connector	Terminals		Condition	Reference signal
	(+)	(-)		
M72	112	118	Receive audio signal	 <p style="text-align: right; font-size: small;">SKIA0177E</p>
	108	114		

Is the audio signal voltage reading as specified?

- YES >> Replace BOSE speaker amp. Refer to [AV-271, "Removal and Installation"](#).
- NO >> Replace AV control unit. Refer to [AV-259, "Removal and Installation"](#).

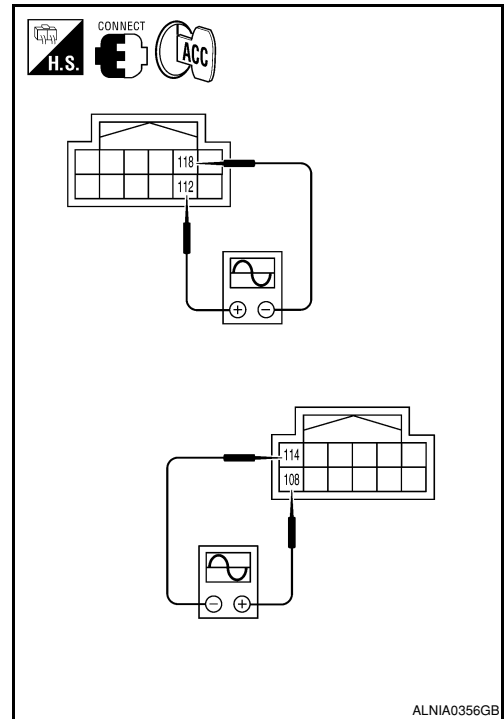

A  
B  
C  
D  
E  
F  
G  
H  
I  
J  
K  
L  
M  
O  
P

AV

## WOOFER

### Description

INFOID:000000001278754

The AV control unit sends audio signals to the BOSE speaker amp. The BOSE speaker amp. amplifies the audio signals before sending them to the subwoofer using the audio signal circuits.

### Diagnosis Procedure

INFOID:000000001278755

#### 1. VERIFY SUBWOOFER POWER AND GROUND SUPPLY

Check power and ground supply to the subwoofer. Refer to [AV-158. "WOOFER : Diagnosis Procedure"](#)

Did the power and ground supply check OK?

YES >> GO TO 2

NO >> • Check connector housings for disconnected or loose terminals.  
• Repair harness or connector.

#### 2. HARNESS CHECK

1. Disconnect BOSE speaker amp. connector M112 and subwoofer connector.
2. Check continuity between BOSE speaker amp. harness connector M112 (A) and M113 (B) and subwoofer harness connector B72 (C).

Connector	Terminal	Connector	Terminal	Continuity
A: M112	9	C: B72	2	Yes
	14		1	
B: M113	25		4	

3. Check continuity between BOSE speaker amp. harness connector M112 (A) and M113 (B) and ground.

Connector	Terminal	-	Continuity
A: M112	9	Ground	No
	14		
B: M113	25		

Are the continuity test results as specified?

YES >> GO TO 3

NO >> • Check connector housings for disconnected or loose terminals.  
• Repair harness or connector.

#### 3. SUBWOOFER AMP ON SIGNAL CHECK

1. Connect BOSE speaker amp. connector M112.
2. Turn ignition switch to ACC.
3. Push "POWER" switch.
4. Check voltage between subwoofer connector B72 terminal 4 and ground.

(+)		(-)	Voltage
Connector	Terminal		
B72	4	Ground	Battery voltage

Are the voltage readings as specified?

YES >> GO TO 4

NO >> Replace BOSE speaker amp. Refer to [AV-271. "Removal and Installation"](#)

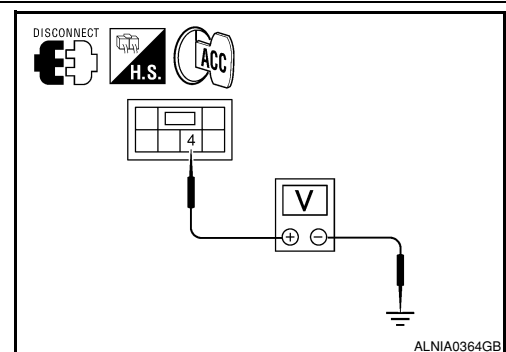
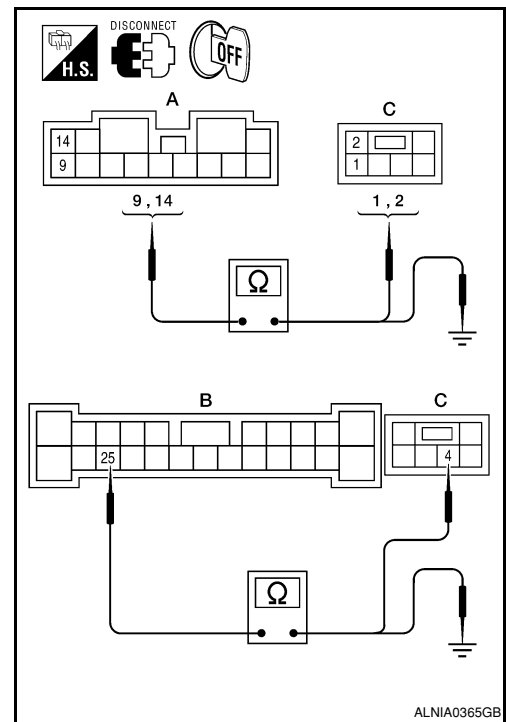

# WOOFER

< COMPONENT DIAGNOSIS >

[BOSE AUDIO WITHOUT NAVIGATION]

## 4. SUBWOOFER AUDIO SIGNAL CHECK

1. Connect BOSE speaker amp. connector M112 and subwoofer connector B72.
2. Turn ignition switch to ACC.
3. Push "POWER" switch.
4. Check the signal between BOSE speaker amp. harness connector M112 terminals with CONSULT-III or oscilloscope.

Connector	Terminals		Condition	Reference signal
	(+)	(-)		
M112	9	14	Receive audio signal	

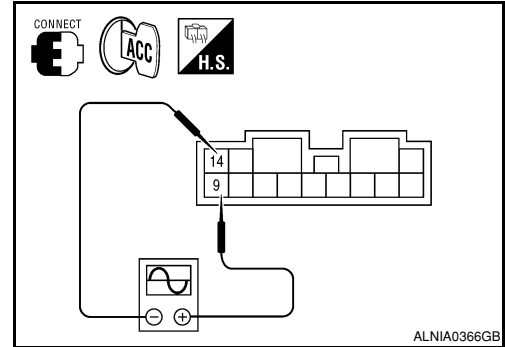

Is the audio signal voltage as specified?

YES >> Replace subwoofer. Refer to [AV-266. "Removal and Installation"](#).

NO >> GO TO 5

## 5. HARNESS CHECK

1. Turn ignition switch OFF.
2. Disconnect AV control unit connector M72 and BOSE speaker amp. connector M113.
3. Check continuity between AV control unit harness connector M72 (A) and BOSE speaker amp. harness connector M113 (B).

A		B		Continuity
Connector	Terminal	Connector	Terminal	
M72	112	M113	21	Yes
	118		22	
	108		23	
	114		33	

4. Check continuity between AV control unit harness connector M72 (A) and ground.

A		—	Continuity
Connector	Terminal		
M72	112	Ground	No
	118		
	108		
	114		

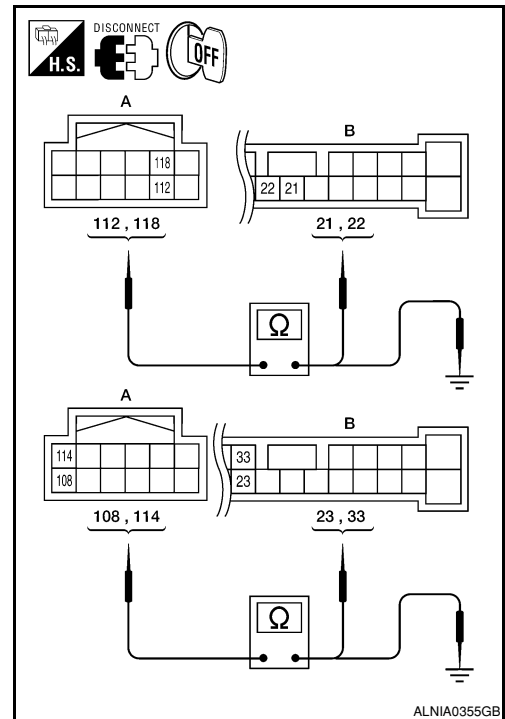

Are the continuity test results as specified?

YES >> GO TO 6

NO >> • Check connector housings for disconnected or loose terminals.  
• Repair harness or connector.

## 6. BACK DOOR SPEAKER SIGNAL CHECK

# WOOFER

[BOSE AUDIO WITHOUT NAVIGATION]

## < COMPONENT DIAGNOSIS >

1. Connect AV control unit connector M72 and BOSE speaker amp. connector M113.
2. Turn ignition switch to ACC.
3. Push "POWER" switch.
4. Check the signal between AV control unit harness connector M72 terminals with CONSULT-III or oscilloscope.

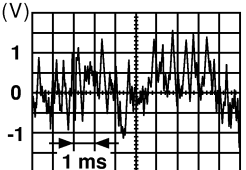
Connector	Terminals		Condition	Reference signal
	(+)	(-)		
M72	112	118	Receive audio signal	 <p style="text-align: right; font-size: small;">SKIA0177E</p>
	108	114		

Is the audio signal voltage reading as specified?

- YES >> Replace BOSE speaker amp. Refer to [AV-271, "Removal and Installation"](#).
- NO >> Replace AV control unit. Refer to [AV-259, "Removal and Installation"](#).

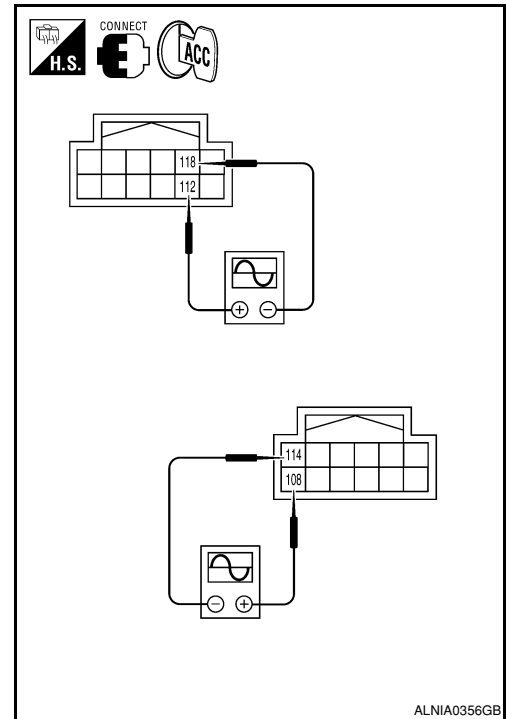



# AMP ON SIGNAL CIRCUIT

< COMPONENT DIAGNOSIS >

[BOSE AUDIO WITHOUT NAVIGATION]

## AMP ON SIGNAL CIRCUIT

### Description

INFOID:000000001278756

When the audio system is turned on, a voltage signal is supplied from the AV control unit to the BOSE speaker amp. When this signal is received, the BOSE speaker amp. will turn on.

### Diagnosis Procedure

INFOID:000000001278757

#### 1. CHECK AMP ON SIGNAL (BOSE SPEAKER AMP)

1. Turn audio system ON.
2. Check voltage between BOSE speaker amp. harness connector M113 terminal 31 and ground.

**31 - Ground : Battery voltage**

Is battery voltage present?

- YES >> Inspection End.  
NO >> GO TO 2

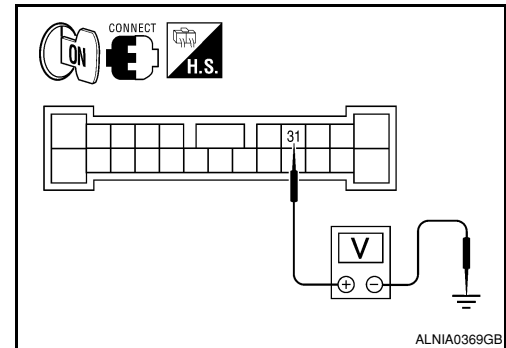

#### 2. CHECK AMP ON SIGNAL (AV CONTROL UNIT)

Check voltage between AV control unit harness connector M72 terminal 110 and ground.

**110 - Ground : Battery voltage**

Is battery voltage present?

- YES >> Repair harness or connector.  
NO >> Replace AV control unit. Refer to [AV-259. "Removal and Installation"](#).

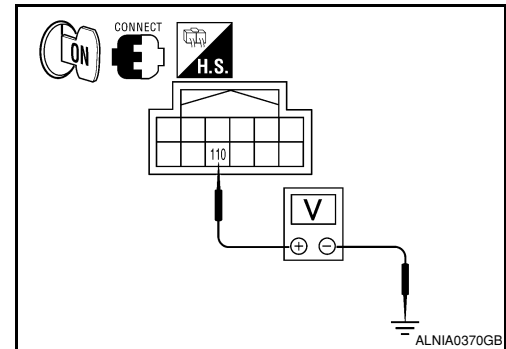

A  
B  
C  
D  
E  
F  
G  
H  
I  
J  
K  
L  
M  
N  
O  
P

AV

# STEERING SWITCH

< COMPONENT DIAGNOSIS >

[BOSE AUDIO WITHOUT NAVIGATION]

## STEERING SWITCH

### Description

INFOID:000000001348274

When one of the steering wheel AV control switches is pushed, the resistance in the steering wheel AV control switch circuit changes depending on which button is pushed.

### Diagnosis Procedure

INFOID:000000001348275

#### 1. CHECK STEERING WHEEL AUDIO CONTROL SWITCH RESISTANCE

1. Turn ignition switch OFF.
2. Disconnect steering wheel audio control switch connector M102.
3. Check resistance between steering switch connector terminals.

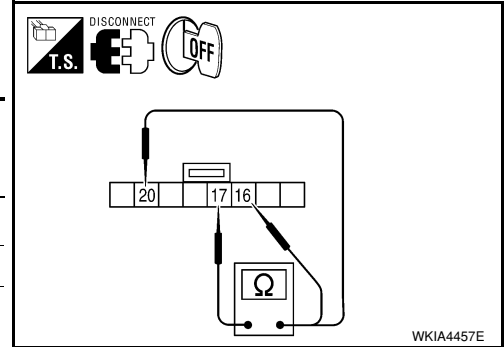

Terminal	Signal name	Condition	Resistance (Ω) (Approx.)	
16	17	Seek (down)	Depress ▽ switch.	165
		Volume (down)	Depress VOL down switch.	487
		Mode (without Bluetooth)	Depress MODE switch.	0
		Phone/Send (with Bluetooth)	Depress MODE switch.	
20	17	Seek (up)	Depress △ switch.	165
		Volume (up)	Depress VOL up switch.	487
		Power (without Bluetooth)	Depress PWR switch.	0
		Mode/End (with Bluetooth)	Depress MODE switch.	

Do the steering wheel audio control switches check OK?

YES >> GO TO 2

NO >> Replace steering wheel audio control switch. Refer to [AV-267, "Removal and Installation"](#).

#### 2. CHECK HARNESS

1. Disconnect AV control unit connector M42 and spiral cable connector M30.
2. Check continuity between AV control unit harness connector M42 (A) and spiral cable harness connector M30 (B).

A		B		Continuity
Connector	Terminal	Connector	Terminal	
M42	6	M30	24	Yes
	15		31	
	16		32	

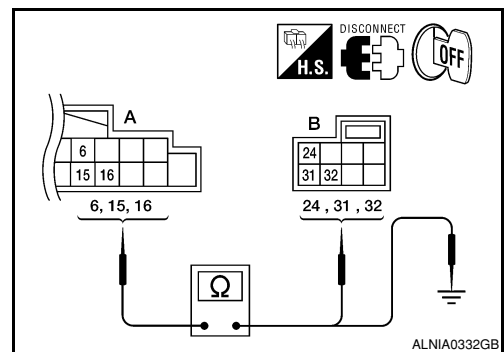

3. Check continuity between AV control unit connector M42 (A) and ground.

A		—	Continuity
Connector	Terminal		
M42	6	Ground	No
	15		
	16		

Are the continuity results as specified?

YES >> GO TO 3

# STEERING SWITCH

[BOSE AUDIO WITHOUT NAVIGATION]

< COMPONENT DIAGNOSIS >

NO >> Repair harness.

## 3. SPIRAL CABLE CHECK

1. Disconnect spiral cable connector M102.
2. Check continuity between spiral cable harness connector M30 (A) and M102 (B).

Spiral cable				Continuity
Connector	Terminal	Connector	Terminal	
M30	24	M102	20	Yes
	31		17	
	32		16	

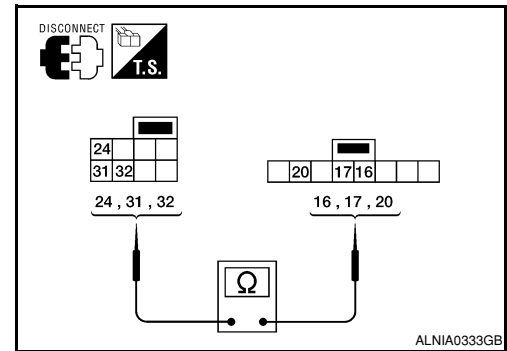

Does the spiral cable check OK?

YES >> Inspection End.

NO >> Replace spiral cable. Refer to [SR-6, "Removal and Installation"](#).

A  
B  
C  
D  
E  
F  
G  
H  
I  
J  
K  
L  
M

AV

O  
P

# COMMUNICATION SIGNAL CIRCUIT

[BOSE AUDIO WITHOUT NAVIGATION]

< COMPONENT DIAGNOSIS >

## COMMUNICATION SIGNAL CIRCUIT SATELLITE RADIO TUNER

### SATELLITE RADIO TUNER : Description

INFOID:000000001348276

Communication signals are exchanged between the AV control unit and satellite radio tuner using the communication circuits.

### SATELLITE RADIO TUNER : Diagnosis Procedure

INFOID:000000001348277

#### 1. CHECK HARNESS - 1

1. Turn ignition switch OFF.
2. Disconnect satellite radio tuner (factory installed) connector M41 and AV control unit connector M43.
3. Check continuity between satellite radio tuner (factory installed) harness connector M41 (A) terminal 28 and AV control unit harness connector M43 (B) terminal 28.

A		B		Continuity
Connector	Terminal	Connector	Terminal	
M41	28	M43	28	Yes

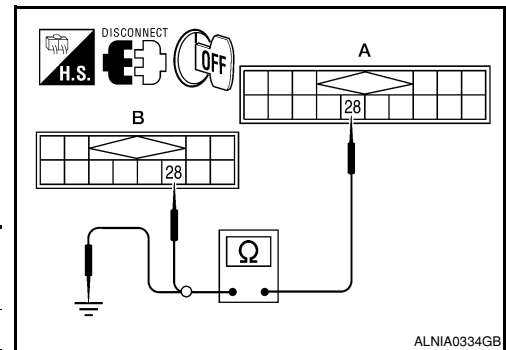

ALNIA0334GB

4. Check continuity between satellite radio tuner (factory installed) harness connector M41 (A) terminal 28 and ground.

A		—	Continuity
Connector	Terminal		
M41	28	Ground	No

Are continuity results as specified?

- YES >> GO TO 2  
NO >> Repair harness or connector.

#### 2. CHECK HARNESS - 2

1. Check continuity between satellite radio tuner (factory installed) harness connector M41 (A) terminal 29 and AV control unit harness connector M43 (B) terminal 29.

A		B		Continuity
Connector	Terminal	Connector	Terminal	
M41	29	M43	29	Yes

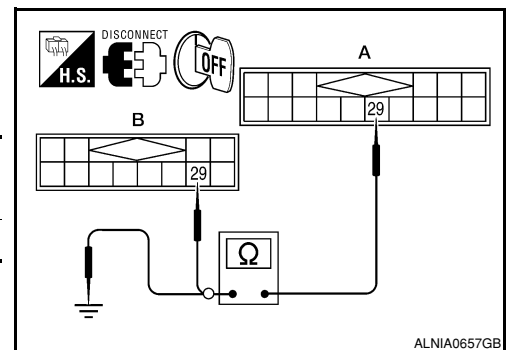

ALNIA0657GB

2. Check continuity between satellite radio tuner (factory installed) harness connector M41 (A) terminal 29 and ground.

A		—	Continuity
Connector	Terminal		
M41	29	Ground	No

Are continuity results as specified?

- YES >> GO TO 3  
NO >> Repair harness or connector.

#### 3. CHECK HARNESS - 3

# COMMUNICATION SIGNAL CIRCUIT

[BOSE AUDIO WITHOUT NAVIGATION]

## < COMPONENT DIAGNOSIS >

1. Check continuity between satellite radio tuner (factory installed) harness connector M41 (A) terminal 30 and AV control unit harness connector M43 (B) terminal 30.

A		B		Continuity
Connector	Terminal	Connector	Terminal	
M41	30	M43	30	Yes

2. Check continuity between satellite radio tuner (factory installed) harness connector M41 (A) terminal 30 and ground.

A		—	Continuity
Connector	Terminal		
M41	30	Ground	No

Are continuity results as specified?

YES >> GO TO 4

NO >> Repair harness or connector.

## 4. CHECK REQ1 SIGNAL

1. Connect satellite radio tuner (factory installed) connector and AV control unit connector.
2. Turn ignition switch to ACC
3. Check signal between satellite radio tuner (factory installed) harness connector M41 terminal 28 and ground with CONSULT-III or oscilloscope.

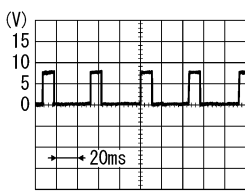
(+)		(-)	Reference signal
Connector	Terminal		
M41	28	Ground	 <p>SKIB3825E</p>

Are voltage readings as specified?

YES >> GO TO 5

NO >> Replace AV control unit. Refer to [AV-104, "Removal and Installation"](#).

## 5. CHECK TXD SIGNAL

Check signal between satellite radio tuner (factory installed) harness connector M41 terminal 29 and ground with CONSULT-III or oscilloscope.

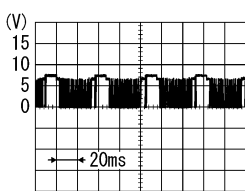
(+)		(-)	Reference signal
Connector	Terminal		
M41	29	Ground	 <p>SKIB3824E</p>

Are the voltage readings as specified?

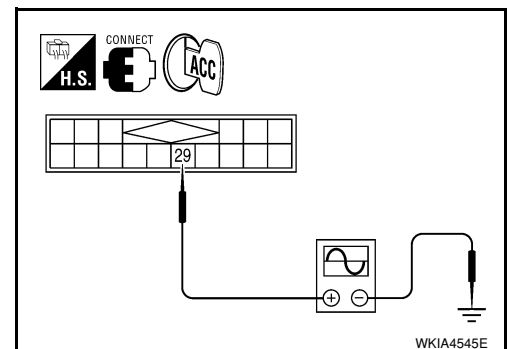
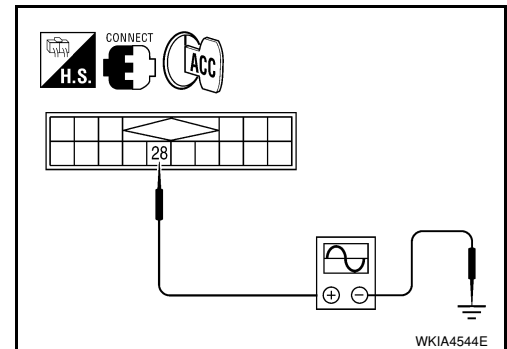
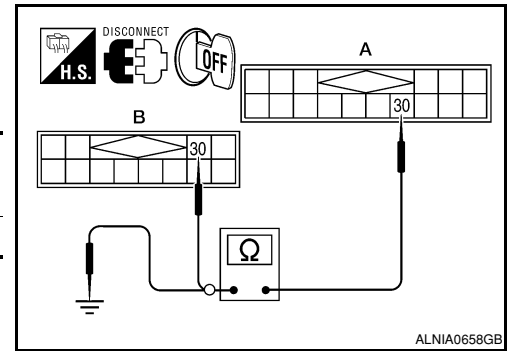

A  
B  
C  
D  
E  
F  
G  
H  
I  
J  
K  
L  
M  
O  
P

AV

# COMMUNICATION SIGNAL CIRCUIT

[BOSE AUDIO WITHOUT NAVIGATION]

## < COMPONENT DIAGNOSIS >

- YES >> GO TO 6
- NO >> Replace satellite radio tuner.

### 6. CHECK RXD SIGNAL

Check signal between satellite radio tuner (factory installed) harness connector M41 terminal 30 and ground with CONSULT-III or oscilloscope.

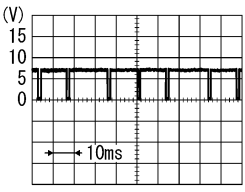
(+)		(-)	Reference signal
Connector	Terminal		
M41	30	Ground	 <p style="text-align: right; font-size: small;">SKIB3826E</p>

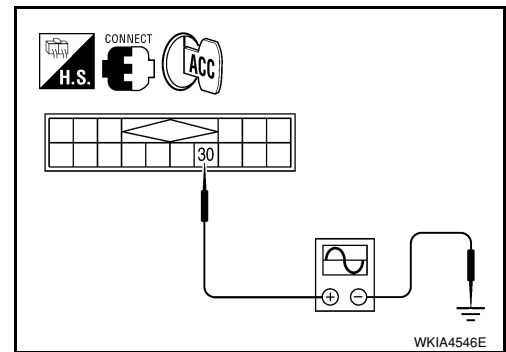

Are the voltage readings as specified?

- YES >> Replace satellite radio tuner.
- NO >> Replace AV control unit. Refer to [AV-104. "Removal and Installation"](#).

# SOUND SIGNAL CIRCUIT

[BOSE AUDIO WITHOUT NAVIGATION]

< COMPONENT DIAGNOSIS >

## SOUND SIGNAL CIRCUIT SATELLITE RADIO TUNER

### SATELLITE RADIO TUNER : Description

INFOID:000000001348278

Left and right channel audio signals are supplied from the satellite radio tuner to the AV control unit through the sound signal circuits.

### SATELLITE RADIO TUNER : Diagnosis Procedure

INFOID:000000001348279

#### LEFT CHANNEL

#### 1.CHECK HARNESS

1. Turn ignition switch OFF.
2. Disconnect satellite radio tuner (factory installed) connector M41 and AV control unit connector M43.
3. Check continuity between satellite radio tuner (factory installed) connector M41 (A) and AV control unit connector M43 (B).

A		B		Continuity
Connector	Terminal	Connector	Terminal	
M41	21	M43	21	Yes
	22		22	

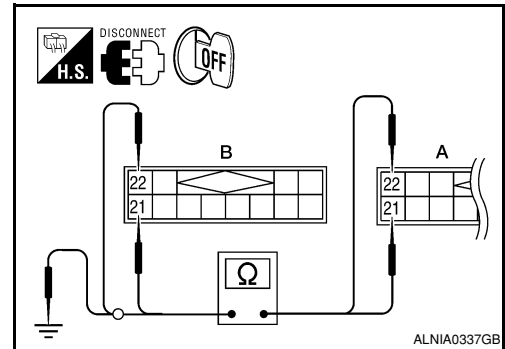

4. Check continuity between satellite radio tuner (factory installed) connector M41 (A) and ground.

A		—	Continuity
Connector	Terminal		
M41	21	Ground	No
	22		

Are continuity results as specified?

- YES >> GO TO 2  
NO >> Repair harness or connector.

#### 2.CHECK LEFT CHANNEL AUDIO SIGNAL

1. Connect satellite radio tuner (factory installed) and AV control unit.
2. Turn ignition switch ON.
3. Check signal between satellite radio tuner (factory installed) connector M41 terminals 21 and 22 with CONSULT-III or oscilloscope.

(+) Terminal		(-)	Reference signal
Connector	Terminal		
M41	21	Ground	<p>The oscilloscope shows a complex waveform between 0V and -1V. A 2ms scale bar is provided. The source is identified as SKIB3609E.</p>
	22		

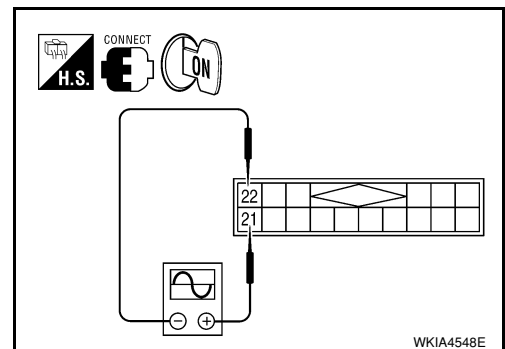

Are voltage readings as specified?

- YES >> Replace AV control unit. Refer to [AV-104. "Removal and Installation"](#).  
NO >> Replace satellite radio tuner. Refer to [AV-274. "Removal and Installation"](#).

#### RIGHT CHANNEL

A  
B  
C  
D  
E  
F  
G  
H  
I  
J  
K  
L  
M  
AV  
O  
P

# SOUND SIGNAL CIRCUIT

[BOSE AUDIO WITHOUT NAVIGATION]

< COMPONENT DIAGNOSIS >

## 1. CHECK HARNESS

1. Turn ignition switch OFF.
2. Disconnect satellite radio tuner (factory installed) connector M41 and AV control unit connector M43.
3. Check continuity between satellite radio tuner (factory installed) M41 (A) and AV control unit M43 (B).

A		B		Continuity
Connector	Terminal	Connector	Terminal	
M41	23	M43	23	Yes
	24		24	

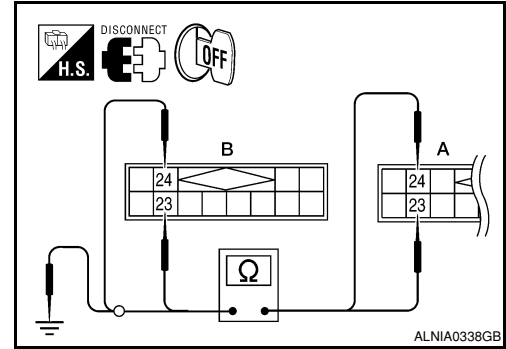

4. Check continuity between satellite radio tuner (factory installed) connector M41 (A) and ground.

A		—	Continuity
Connector	Terminal		
M41	23	Ground	No
	24		

Are continuity results as specified?

- YES >> GO TO 2  
 NO >> Repair harness or connector.

## 2. CHECK RIGHT CHANNEL AUDIO SIGNAL

1. Connect satellite radio tuner (factory installed) and AV control unit.
2. Turn ignition switch ON.
3. Check signal between satellite radio tuner (factory installed) connector M41 terminals 23 and 24 with CONSULT-III or oscilloscope.

(+) Connector		Terminal	(-)	Reference signal
M41	23			

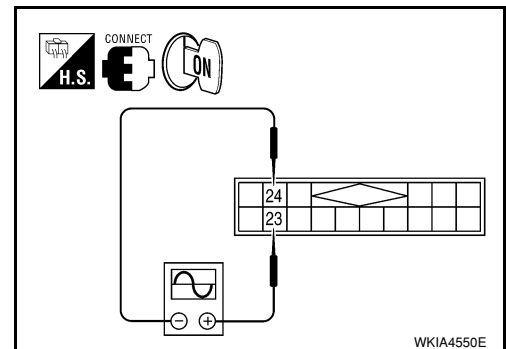

Are voltage readings as specified?

- YES >> Replace AV control unit. Refer to [AV-104, "Removal and Installation"](#).  
 NO >> Replace satellite radio tuner. Refer to [AV-274, "Removal and Installation"](#).



# MICROPHONE SIGNAL CIRCUIT

< COMPONENT DIAGNOSIS >

[BOSE AUDIO WITHOUT NAVIGATION]

## MICROPHONE SIGNAL CIRCUIT

### Description

INFOID:000000001348280

Voice signals are transmitted from the microphone to the Bluetooth control unit using the microphone signal circuits.

### Diagnosis Procedure

INFOID:000000001348281

#### 1. CHECK HARNESS BETWEEN BLUETOOTH CONTROL UNIT AND MICROPHONE

1. Turn ignition switch OFF.
2. Disconnect Bluetooth control unit connector and microphone connector.
3. Check continuity between Bluetooth control unit harness connector B142 (A) and microphone harness connector R109 (B).

A		B		Continuity
Connector	Terminal	Connector	Terminal	
B142	7	R109	1	Yes
	8		2	
	29		4	

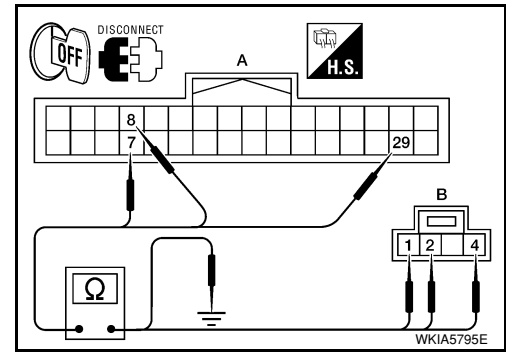

4. Check continuity between Bluetooth control unit harness connector B142 (A) and ground.

A		—	Continuity
Connector	Terminal		
B142	7	Ground	No
	8		
	29		

Are the continuity test results as specified?

- YES >> GO TO 2  
 NO >> Repair harness or connector.

#### 2. CHECK MICROPHONE POWER SUPPLY

1. Connect Bluetooth control unit connector and microphone connector.
2. Turn ignition switch ON.
3. Check voltage between microphone harness connector R109 terminal 4 and ground.

**4 - Ground : Approx. 5V**

Is voltage reading approx. 5 volts?

- YES >> GO TO 3  
 NO >> Replace Bluetooth control unit. Refer to [AV-277](#), "[Removal and Installation](#)".

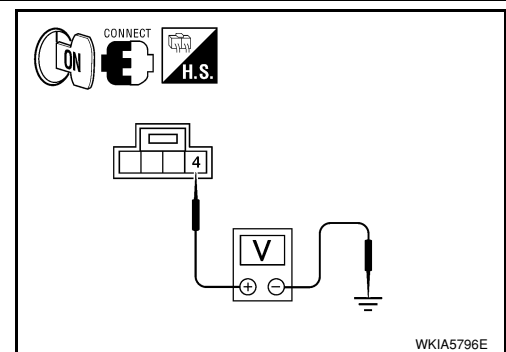

#### 3. CHECK MICROPHONE SIGNAL

# MICROPHONE SIGNAL CIRCUIT

[BOSE AUDIO WITHOUT NAVIGATION]

## < COMPONENT DIAGNOSIS >

Check signal between Bluetooth control unit harness connector B142 terminals 7 and 8 with CONSULT-III or and oscilloscope.

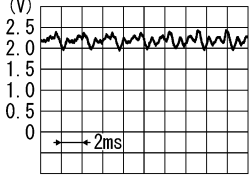
Connector	(+)	(-)	Reference signal
	Terminal	Terminal	
B142	7	8	<p>While speaking into MIC</p>  <p style="text-align: right;">PKIB5037J</p>

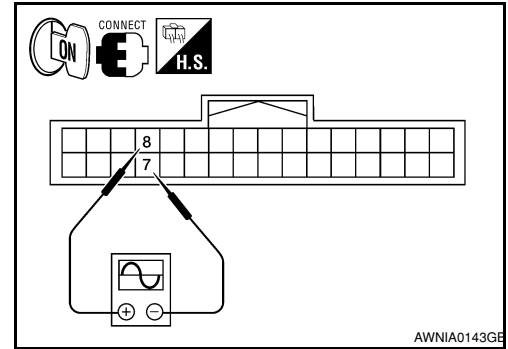

Are voltage readings as specified?

- YES >> Replace Bluetooth control unit. Refer to [AV-277. "Removal and Installation"](#).
- NO >> Replace microphone. Refer to [AV-275. "Removal and Installation"](#).

# AV CONTROL UNIT

< ECU DIAGNOSIS >

[BOSE AUDIO WITHOUT NAVIGATION]

## ECU DIAGNOSIS

### AV CONTROL UNIT

#### Reference Value

INFOID:000000001381369

#### VALUES ON THE DIAGNOSIS TOOL

CONSULT-III data monitor item

Display Item	Display	Vehicle status	Remarks
VHCL SPD SIG	ON	Vehicle speed >0 km/h (0 MPH)	Changes in indication may be delayed. This is normal.
	OFF	Vehicle speed =0 km/h (0 MPH)	
PKB SIG	ON	Parking brake is applied.	Changes in indication may be delayed. This is normal.
	OFF	Parking brake is released.	
ILLUM SIG	ON	Block the light beam from the auto light optical sensor when the light SW is ON .	—
	OFF	Expose the auto light optical sensor to light when the light SW is OFF or ON.	
IGN SIG	ON	Ignition switch ON	—
	OFF	Ignition switch in ACC position	
REV SIG	ON	Selector lever in R position	Changes in indication may be delayed. This is normal.
	OFF	Selector lever in any position other than R	

#### TERMINAL LAYOUT

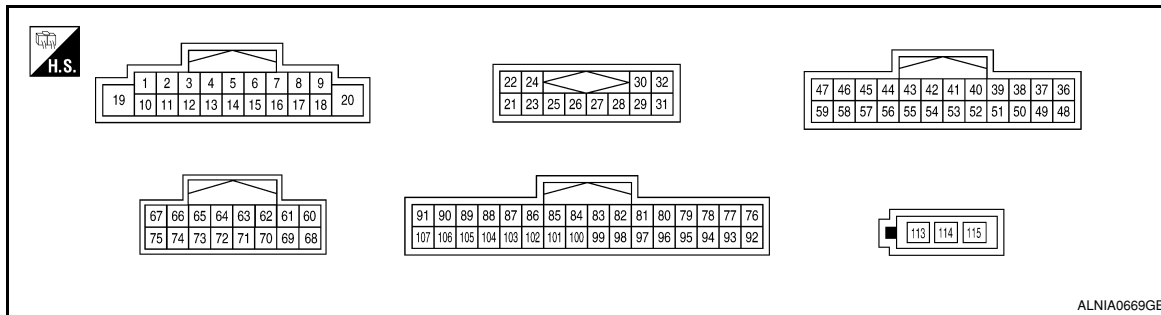

#### PHYSICAL VALUES

Terminal (Wire color)		Description		Condition	Reference value (Approx.)	
+	-	Signal name	Input/ Output			
6 (Y)	15	Steering switch signal A	Input	Press and hold the PWR switch (without Bluetooth)	0V	
				Press and hold  switch (with Bluetooth).		
				Press and hold $\Delta$ switch.		0.75V
				Press and hold VOL up switch		2V
				Except for above.		5V

# AV CONTROL UNIT

[BOSE AUDIO WITHOUT NAVIGATION]

< ECU DIAGNOSIS >

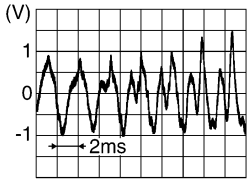
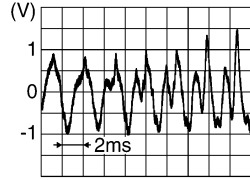
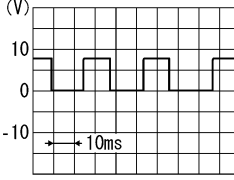
Terminal (Wire color)		Description		Condition		Reference value (Approx.)
+	-	Signal name	Input/ Output			
7 (V)	Ground	ACC power supply	Input	Ignition switch ACC	—	Battery voltage
9 (R/L)	Ground	Illumination signal	Input	OFF	Lighting switch is OFF.	0V
					Lighting switch is ON.	12V
15	Ground	Steering switch signal GND	—	Ignition switch ON	—	0V
16 (G)	15	Steering switch signal B	Input	Ignition switch ON	Press and hold MODE switch (without Bluetooth).	0V
					Press and hold <sup>MODE</sup> switch (with Bluetooth).	
					Press and hold ▽ switch.	0.75V
					Press and hold VOL down switch.	2V
					Except for above.	5V
19 (Y)	Ground	Battery power supply	Input	Ignition switch OFF	—	Battery voltage
20 (B)	Ground	Ground	—	Ignition switch ON	—	0V
22 (W)	21 (B)	Satellite radio sound signal LH	Input	Ignition switch ON	When satellite radio mode is selected	 <p style="text-align: right; font-size: small;">SKIB3609E</p>
24 (Y)	23 (BR)	Satellite radio sound signal RH	Input	Ignition switch ON	When satellite radio mode is selected	 <p style="text-align: right; font-size: small;">SKIB3609E</p>
25	—	Shield	—	—	—	—
26	Ground	Data ground	—	Ignition switch ON	When satellite radio mode is selected	0V
28 (W)	Ground	Request signal (SAT→CONT)	Input	Ignition switch ON	When satellite radio mode is selected	 <p style="text-align: right; font-size: small;">SKIA9299J</p>

# AV CONTROL UNIT

**[BOSE AUDIO WITHOUT NAVIGATION]**

< ECU DIAGNOSIS >

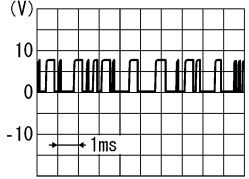
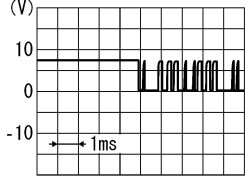
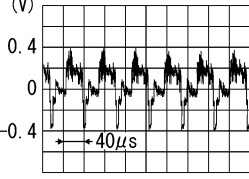
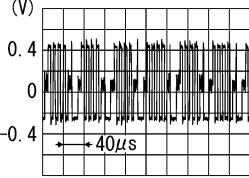
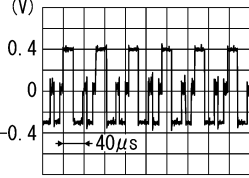
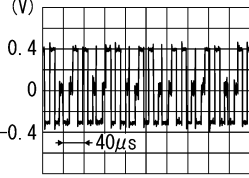
Terminal (Wire color)		Description		Condition		Reference value (Approx.)
+	-	Signal name	Input/ Output			
29 (R)	Ground	Communication signal (SAT→CONT)	Input	Ignition switch ON	When satellite radio mode is selected	 <p style="text-align: right; font-size: small;">SKIA9300J</p>
30 (B)	Ground	Communication signal (CONT→SAT)	Output	Ignition switch ON	When satellite radio mode is selected	 <p style="text-align: right; font-size: small;">SKIA9301J</p>
36 (W)	Ground	AUX image signal	Output	Ignition switch ON	When AUX mode is select- ed	 <p style="text-align: right; font-size: small;">SKIB2251J</p>
37 (B)	Ground	AUX image ground	—	Ignition switch ON	—	0V
38 (R)	Ground	RGB signal (B: blue)	Output	Ignition switch ON	Start confirmation/adjust- ment mode, and then dis- play color bar by selecting "Color Spectrum Bar" on DISPLAY DIAGNOSIS screen.	 <p style="text-align: right; font-size: small;">SKIB2237J</p>
39 (B)	Ground	RGB signal (G: green)	Output	Ignition switch ON	Start confirmation/adjust- ment mode, and then dis- play color bar by selecting "Color Spectrum Bar" on DISPLAY DIAGNOSIS screen.	 <p style="text-align: right; font-size: small;">SKIB2236J</p>
40 (W)	Ground	RGB signal (R: red)	Output	Ignition switch ON	Start confirmation/adjust- ment mode, and then dis- play color bar by selecting "Color Spectrum Bar" on DISPLAY DIAGNOSIS screen.	 <p style="text-align: right; font-size: small;">SKIB2238J</p>

A  
B  
C  
D  
E  
F  
G  
H  
I  
J  
K  
L  
M  
O  
P

AV

# AV CONTROL UNIT

**[BOSE AUDIO WITHOUT NAVIGATION]**

< ECU DIAGNOSIS >

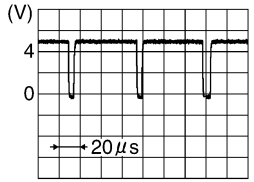
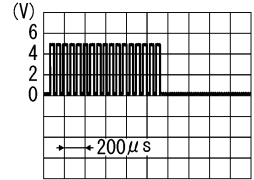
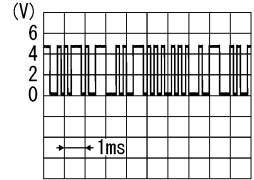
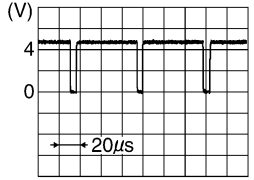
Terminal (Wire color)		Description		Condition		Reference value (Approx.)
+	-	Signal name	Input/ Output			
41 (W)	Ground	RGB synchronizing signal	Output	Ignition switch ON	—	 <p style="text-align: right; font-size: small;">SKIB3603E</p>
42	—	RGB synchronizing ground	—	Ignition switch ON	—	0V
43 (O)	Ground	RGB area (YS) signal	Output	Ignition switch ON	RGB image	5V
					AUX image	 <p style="text-align: right; font-size: small;">PKIB4948J</p>
44 (LG)	Ground	Communication signal (DISP→CONT)	Input	Ignition switch ON	When adjusting display- brightness	 <p style="text-align: right; font-size: small;">PKIB5039J</p>
45 (W/L)	Ground	Horizontal synchronizing (HP) signal	Input	Ignition switch ON	—	 <p style="text-align: right; font-size: small;">SKIB3601E</p>
46 (G/O)	Ground	Signal ground	—	Ignition switch	—	0V
47 (B/O)	Ground	Signal VCC	Output	Ignition switch ACC	—	9V
48 (R)	Ground	Composite out synchroniz- ing signal GND	—	Ignition switch ON	—	0V
49	—	Shield	—	—	—	—
50	Ground	RGB ground	—	Ignition switch ON	—	0V
54 (B)	Ground	Ground	—	Ignition switch ON	—	0V
55	—	Shield	—	—	—	—

# AV CONTROL UNIT

**[BOSE AUDIO WITHOUT NAVIGATION]**

< ECU DIAGNOSIS >

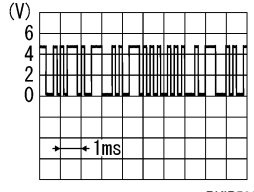
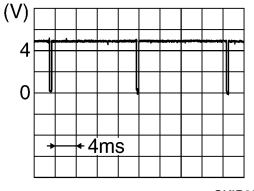
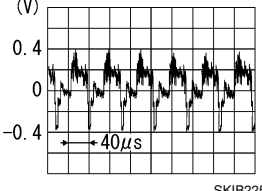
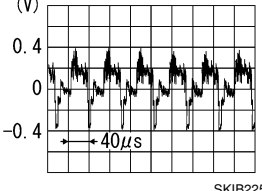
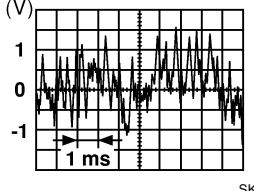
Terminal (Wire color)		Description		Condition		Reference value (Approx.)
+	-	Signal name	Input/ Output			
56 (V)	Ground	Communication signal (CONT→DISP)	Output	Ignition switch ON	When adjusting display- brightness	 <p style="text-align: right; font-size: small;">PKIB5039J</p>
57 (O/L)	Ground	Vertical synchronizing (VP) signal	Input	Ignition switch On	—	 <p style="text-align: right; font-size: small;">SKIB3598E</p>
58 (B)	Ground	Inverter ground	—	Ignition switch ON	—	0V
59 (BR/Y)	Ground	Inverter VCC	Output	Ignition switch ACC	—	9V
64 (BR)	Ground	Rear view camera video signal ground	—	Ignition switch ON	—	0V
65 (W)	Ground	Rear view camera video in (+)	Input	Ignition switch ON	With rear view camera ON	 <p style="text-align: right; font-size: small;">SKIB2251J</p>
66 (B/W)	Ground	DVD player video signal (+)	Input	Ignition switch ON	With DVD player operating	 <p style="text-align: right; font-size: small;">SKIB2251J</p>
72	—	Shield	—	—	—	—
74 (L)	Ground	DVD player video ground	—	Ignition switch ON	—	0V
77 (W/L)	76 (O)	Headphone RH audio sig- nal	Output	Ignition switch ON	With DVD player operating	 <p style="text-align: right; font-size: small;">SKIA0177E</p>

A  
B  
C  
D  
E  
F  
G  
H  
I  
J  
K  
L  
M  
AV  
O  
P

AV

# AV CONTROL UNIT

**[BOSE AUDIO WITHOUT NAVIGATION]**

< ECU DIAGNOSIS >

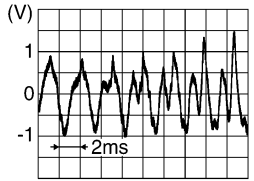
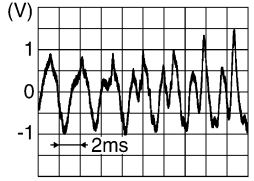
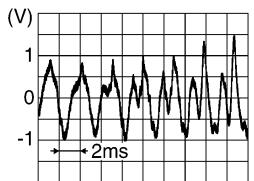
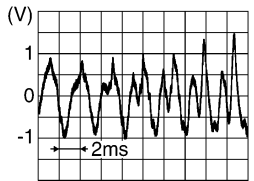
Terminal (Wire color)		Description		Condition		Reference value (Approx.)
+	-	Signal name	Input/ Output			
80 (L)	79 (P)	TEL voice audio signal	Input	Ignition switch ON	Start confirmation/adjustment mode, and then Voice Microphone Test by selecting "Voice Microphone Test" on Handsfree Microphone screen.	 <p style="text-align: right; font-size: small;">SKIB3609E</p>
81	—	Shield	—	—	—	—
83 (R)	82 (G)	DVD player audio signal RH	Input	Ignition switch ON	With DVD player operating	 <p style="text-align: right; font-size: small;">SKIB3609E</p>
85 (B)	Ground	Ground	—	Ignition switch ON	—	0V
86 (L)	—	CAN-H	Input/ Output	—	—	—
87 (P)	—	CAN-L	Input/ Output	—	—	—
88 (W/L)	—	AV communication signal 1 (H)	Input/ Output	—	—	—
89 (P/B)	—	AV communication signal 1 (L)	Input/ Output	—	—	—
90 (W/L)	—	AV communication signal 2 (H)	Input/ Output	—	—	—
91 (P/B)	—	AV communication signal 2 (L)	Input/ Output	—	—	—
93 (O/L)	92 (W)	Headphone LH audio signal	Output	Ignition switch ON	With DVD player operating	 <p style="text-align: right; font-size: small;">SKIB3609E</p>
94	—	Shield	—	—	—	—
95 (B)	97 (R)	AUX audio signal RH	Input	Ignition switch ON	When AUX mode is selected	 <p style="text-align: right; font-size: small;">SKIB3609E</p>



# AV CONTROL UNIT

< ECU DIAGNOSIS >

[BOSE AUDIO WITHOUT NAVIGATION]

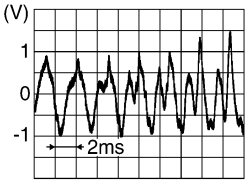
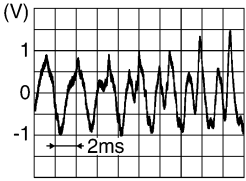
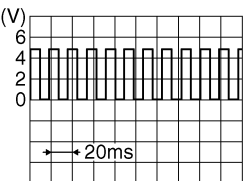
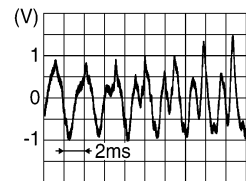
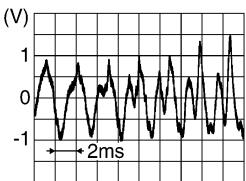
Terminal (Wire color)		Description		Condition		Reference value (Approx.)
+	-	Signal name	Input/ Output			
96 (W)	97 (R)	AUX audio signal LH	Input	Ignition switch ON	When AUX mode is select- ed	 <small>SKIB3609E</small>
98 (B)	99 (W)	DVD player audio signal LH	Input	Ignition switch ON	With DVD player operating	 <small>SKIB3609E</small>
101 (BR)	Ground	A/C and AV switch assem- bly ground	—	Ignition switch ON	—	0V
103 (SB)	Ground	CD eject signal	Input	—	Pressing the eject switch	0V
					Except for above	3.3V
104 (G/R)	Ground	Ignition signal	Input	Ignition switch ON	—	Battery voltage
105 (G/W)	Ground	Reverse signal	Input	Ignition switch ON	R position	12V
					Other than R position	0V
106 (GR/R)	Ground	Parking brake signal	Input	Ignition switch ON	Parking brake ON	0V
					Parking brake OFF	12V
107 (R)	Ground	Vehicle speed signal (8-pulse)	Input	Ignition switch ON	When vehicle speed is ap- prox. 40 km/h (25MPH)	 <small>SKIA6649J</small>
108 (W)	114 (B)	Rear RH pre-amp. sound signal	Output	Ignition switch ON	Audio output	 <small>SKIB3609E</small>
109 (BR)	115 (B/R)	Front RH pre-amp. sound signal	Output	Ignition switch ON	Audio output	 <small>SKIB3609E</small>

A  
B  
C  
D  
E  
F  
G  
H  
I  
J  
K  
L  
M

AV

O  
P

# AV CONTROL UNIT

**[BOSE AUDIO WITHOUT NAVIGATION]**

< ECU DIAGNOSIS >

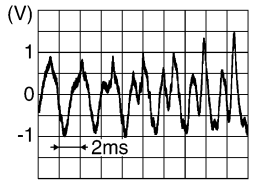
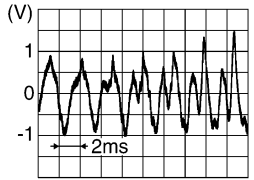
Terminal (Wire color)		Description		Condition		Reference value (Approx.)
+	-	Signal name	Input/ Output			
110 (GR/L)	Ground	Amp. ON signal	Output	Ignition switch ON		12V
111	—	Shield	—	—	—	—
112 (L)	118 (B/W)	Rear LH pre-amp. sound signal	Output	Ignition switch ON	Audio output	 <p style="text-align: right; font-size: small;">SKIB3609E</p>
113 (LG)	119 (V)	Front LH pre-amp. sound signal	Output	Ignition switch ON	Audio output	 <p style="text-align: right; font-size: small;">SKIB3609E</p>

# AV CONTROL UNIT

[BOSE AUDIO WITHOUT NAVIGATION]

< ECU DIAGNOSIS >

## Wiring Diagram

INFOID:000000001278768

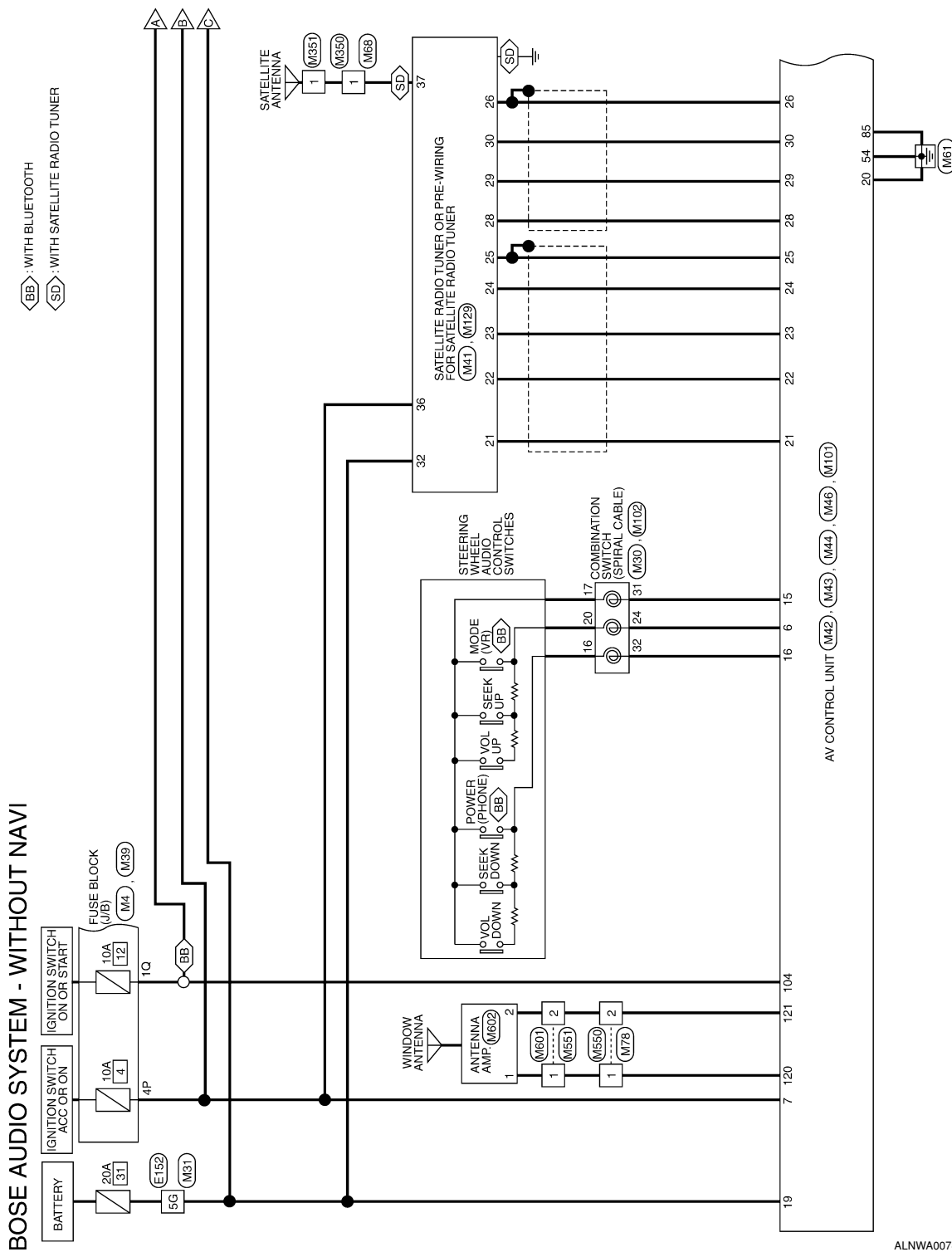

ALNWA0074GE

A  
B  
C  
D  
E  
F  
G  
H  
I  
J  
K  
L  
M  
O  
P

AV

# AV CONTROL UNIT

[BOSE AUDIO WITHOUT NAVIGATION]

< ECU DIAGNOSIS >

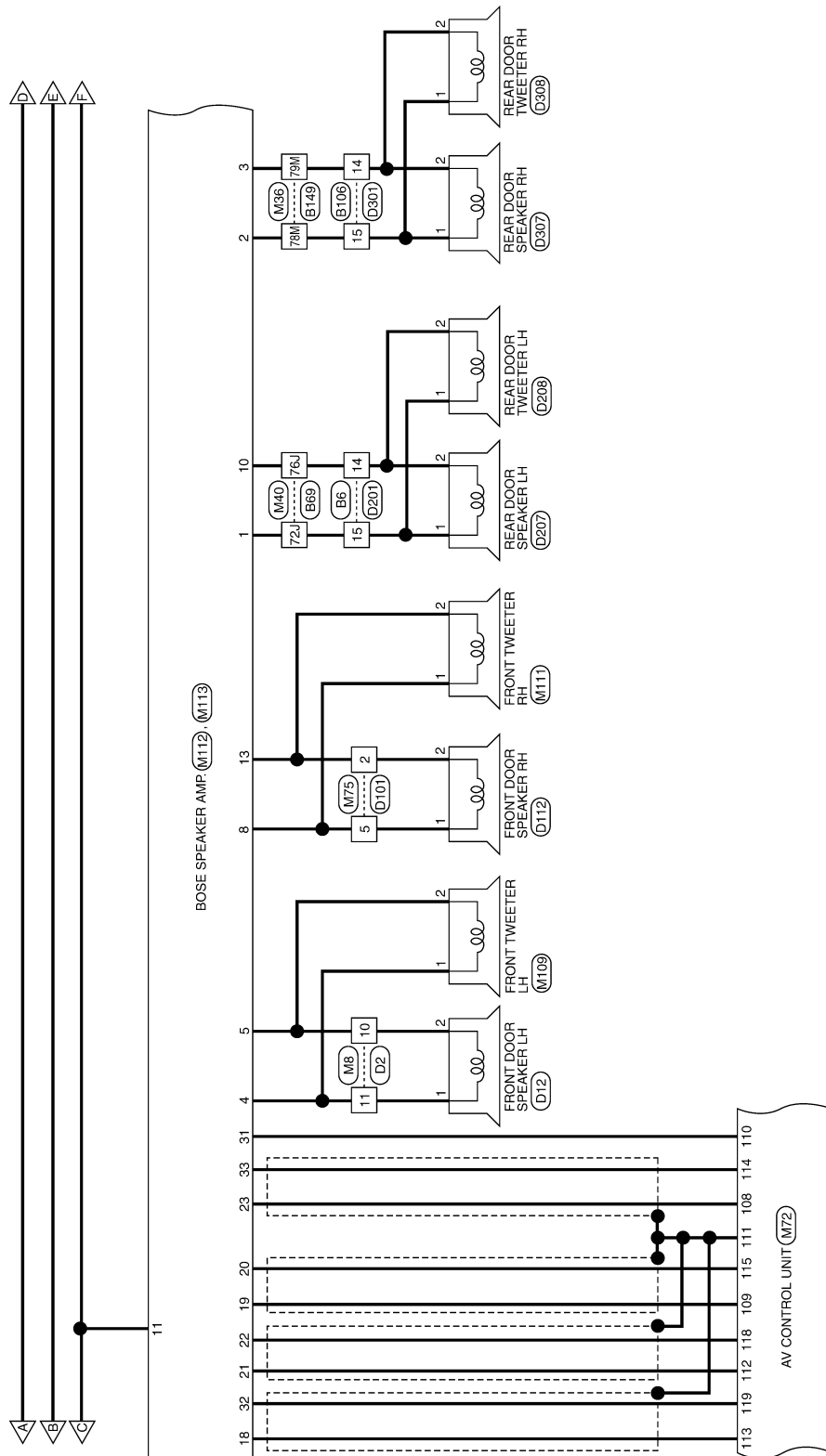

ALNWA0075GE



# AV CONTROL UNIT

[BOSE AUDIO WITHOUT NAVIGATION]

< ECU DIAGNOSIS >

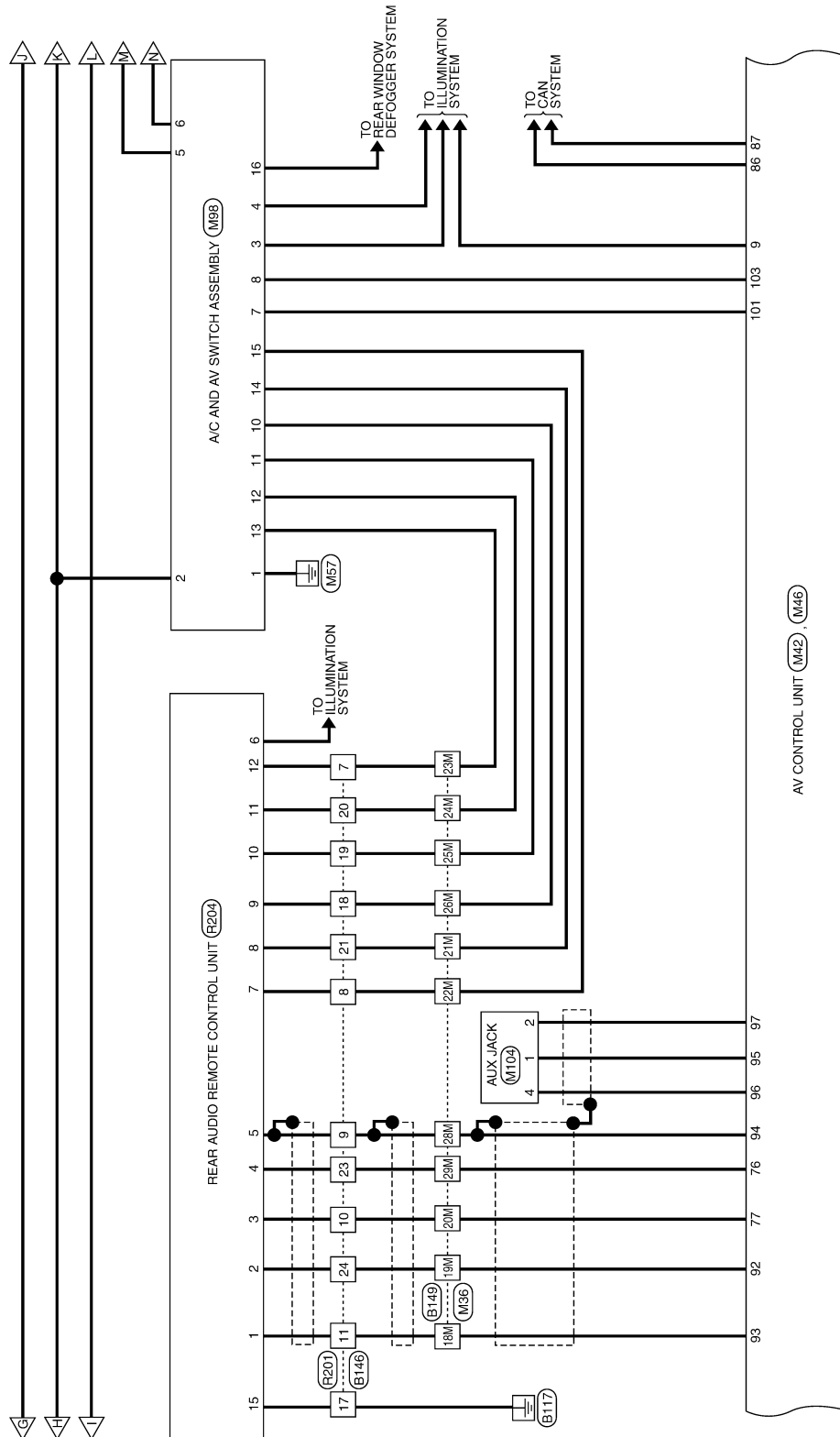

ALNWA0077GE

# AV CONTROL UNIT

< ECU DIAGNOSIS >

[BOSE AUDIO WITHOUT NAVIGATION]

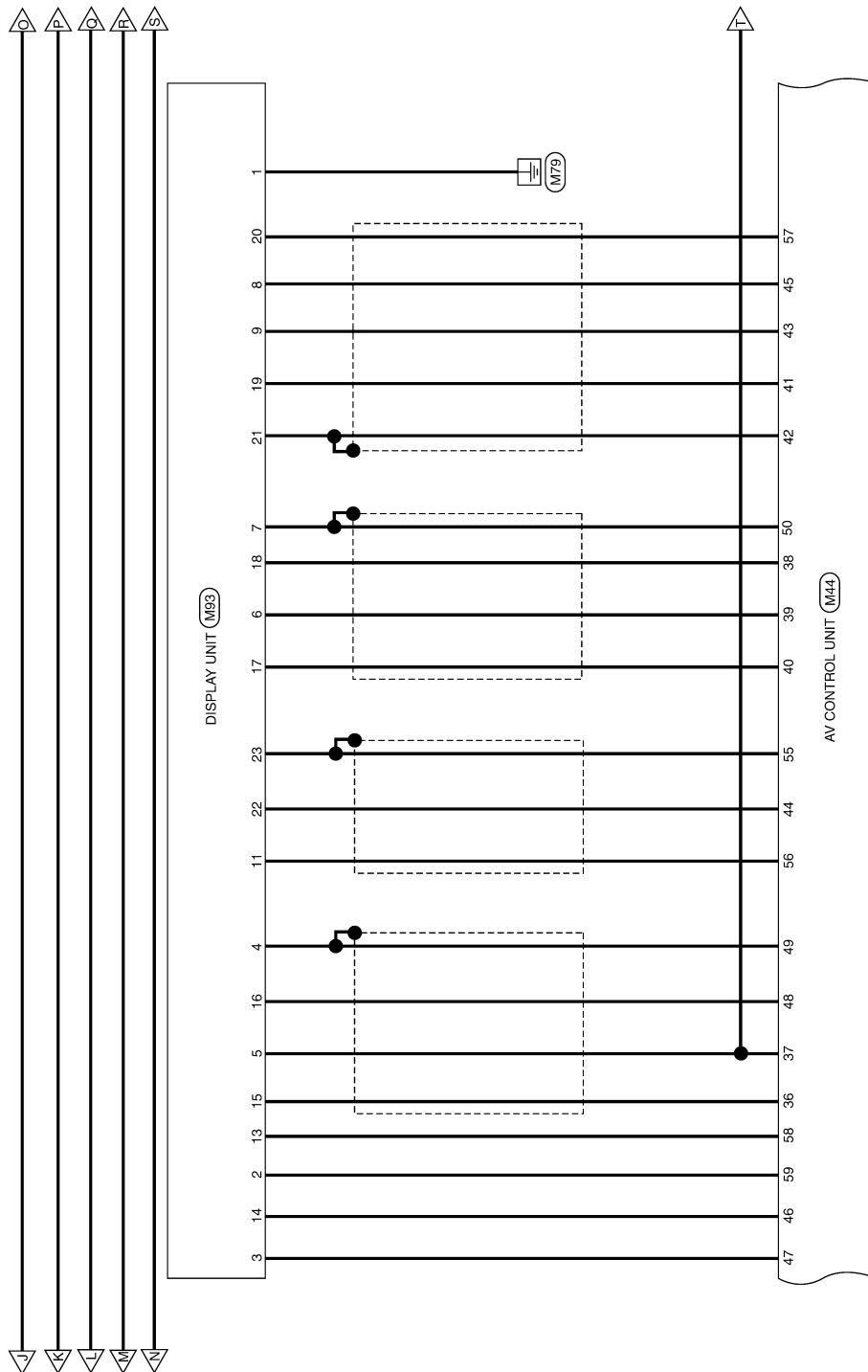

A  
B  
C  
D  
E  
F  
G  
H  
I  
J  
K  
L  
M  
O  
P

AV

ALNWA0078GE

# AV CONTROL UNIT

[BOSE AUDIO WITHOUT NAVIGATION]

< ECU DIAGNOSIS >

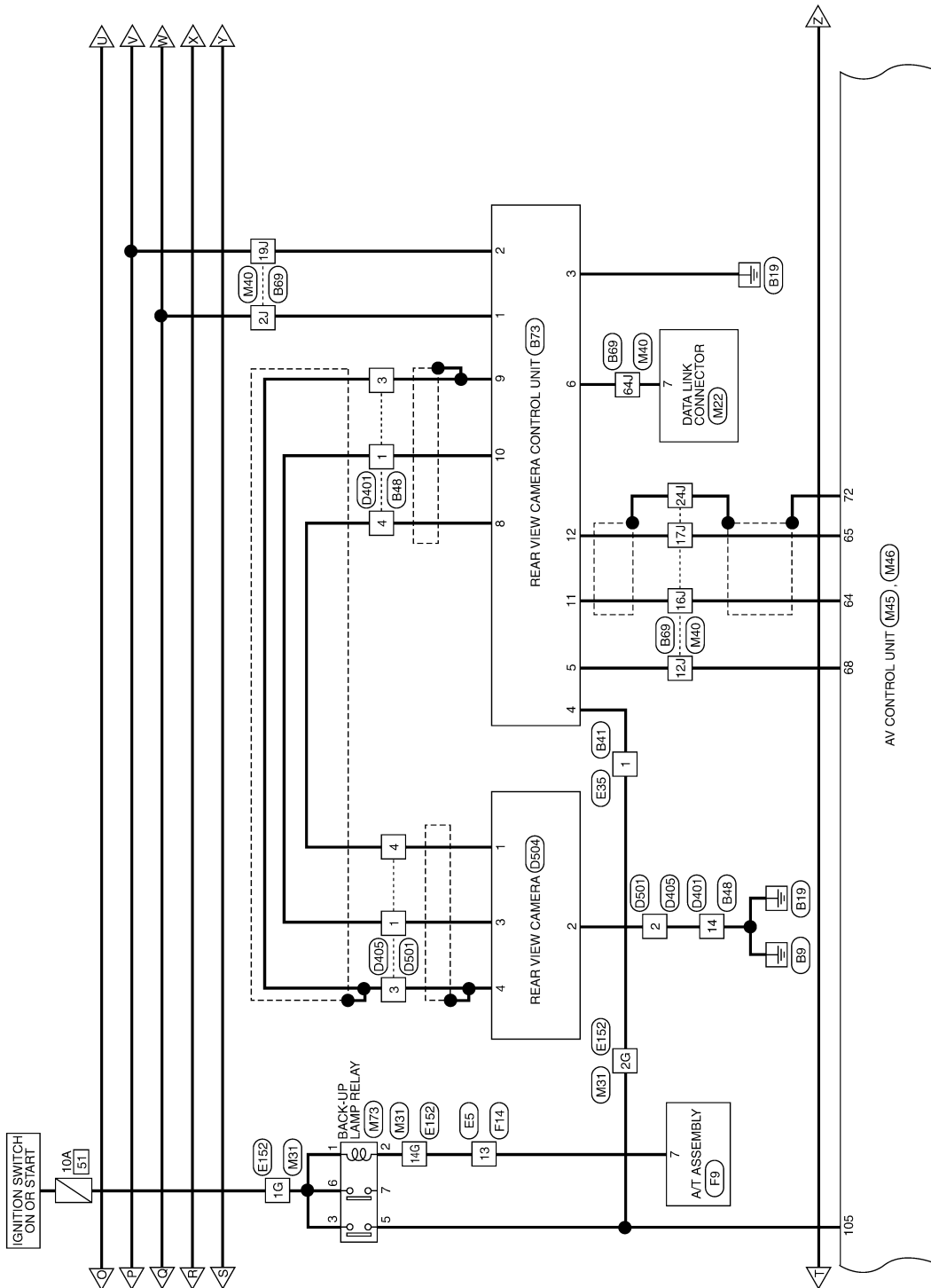

ALNWA0079GE



# AV CONTROL UNIT

[BOSE AUDIO WITHOUT NAVIGATION]

< ECU DIAGNOSIS >

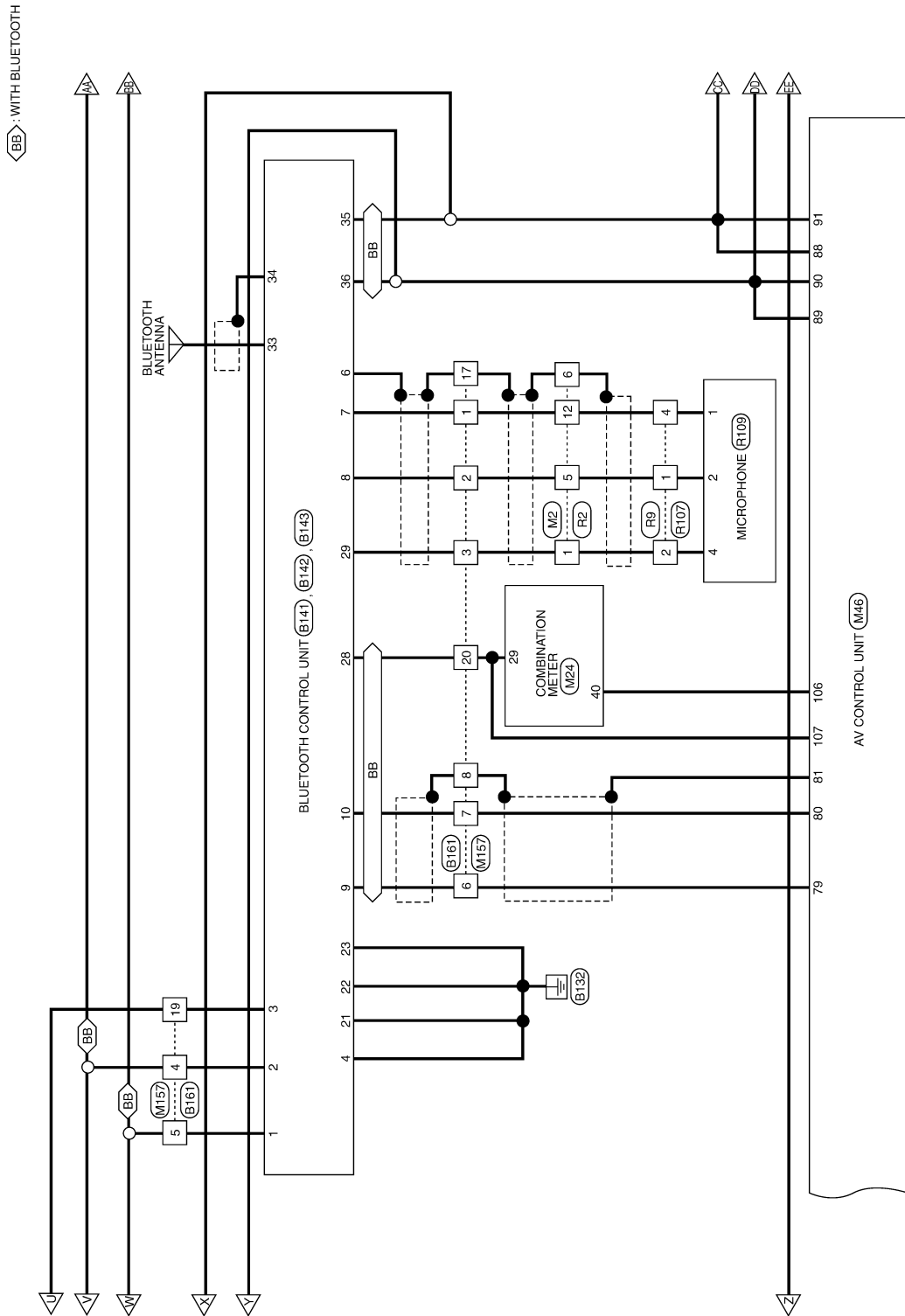

A  
B  
C  
D  
E  
F  
G  
H  
I  
J  
K  
L  
M  
N  
O  
P

AV

ALNWA0082GE

# AV CONTROL UNIT

[BOSE AUDIO WITHOUT NAVIGATION]

< ECU DIAGNOSIS >

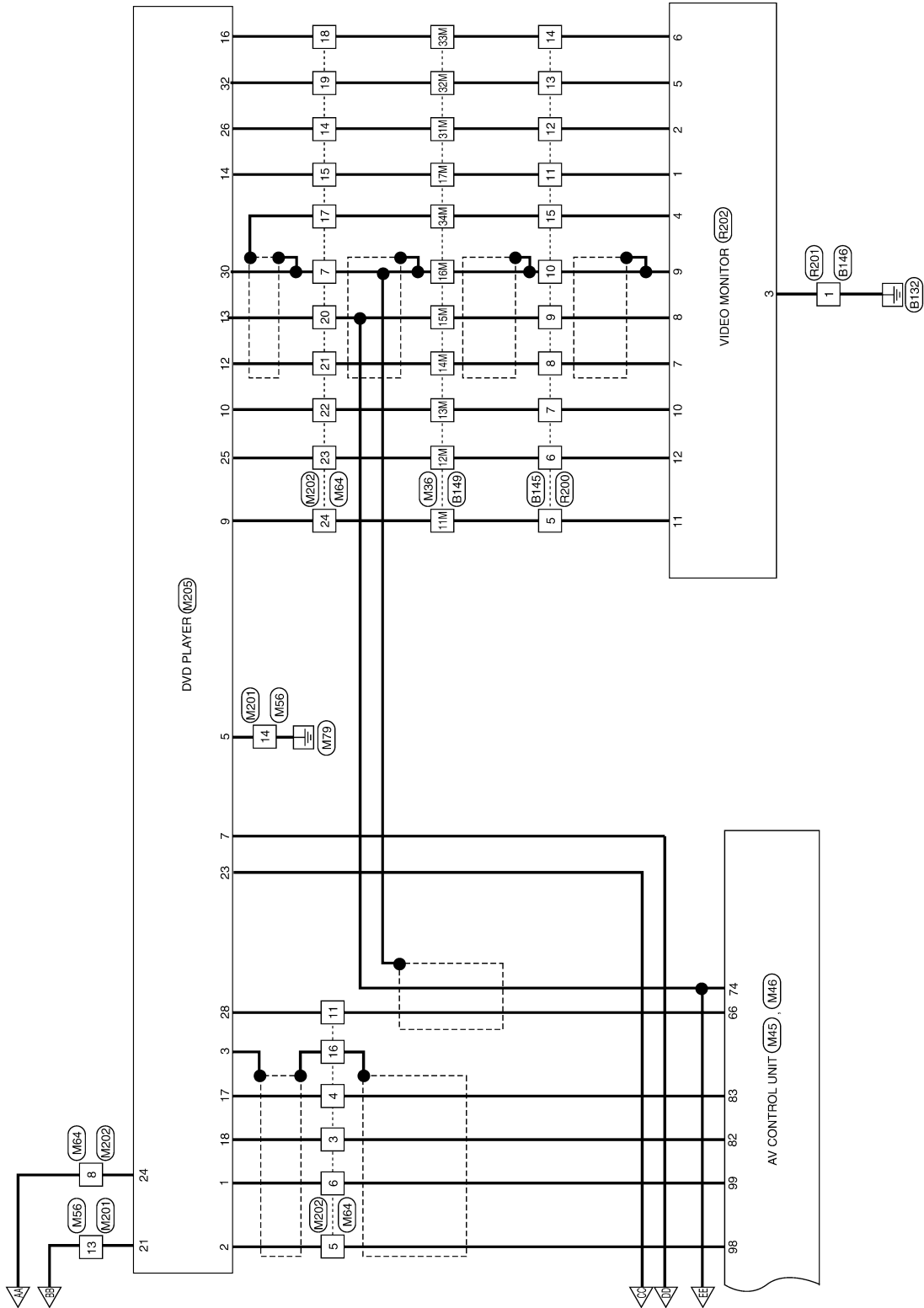

ALNWA0080GE

# AV CONTROL UNIT

[BOSE AUDIO WITHOUT NAVIGATION]

< ECU DIAGNOSIS >

Connector No.	M39
Connector Name	FUSE BLOCK (J/B)
Connector Color	WHITE

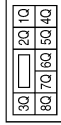

Terminal No.	Color of Wire	Signal Name
1Q	G/R	-

Connector No.	M40
Connector Name	WIRE TO WIRE
Connector Color	WHITE

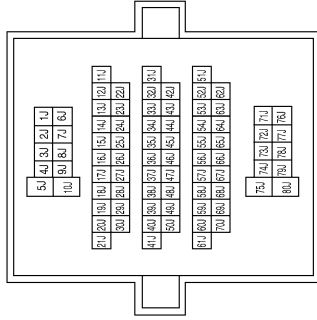

Terminal No.	Color of Wire	Signal Name
2J	Y	-
10J	R	-
12J	BR	-
16J	B	-
17J	W	-
19J	V	-
24J	SHIELD	-
27J	G	-
28J	R	-
29J	W/G	-
54J	W	-
55J	B	-
64J	G/W	-
72J	SB	-
76J	B/Y	-

Connector No.	M41
Connector Name	SATELLITE RADIO TUNER
Connector Color	WHITE



Terminal No.	Color of Wire	Signal Name
21	B	SAT_LH_OUT
22	W	SAT_LH+_OUT
23	BR	SAT_RH_OUT
24	Y	SAT_RH+_OUT
25	SHIELD	SIG_SHIELD
26	SHIELD	DATA_GND
27	-	-
28	W	REQ1_(SAT-HU)
29	B	TXD_(SAT-HU)

Terminal No.	Color of Wire	Signal Name
30	B	RXD_(HU-SAT)
31	-	-
32	Y	BATT
33	-	-
34	-	-
35	-	-
36	V	ACC

ALNIA0475GB

A B C D E F G H I J K L M N O P

AV

# AV CONTROL UNIT

[BOSE AUDIO WITHOUT NAVIGATION]

< ECU DIAGNOSIS >

Connector No.	M42
Connector Name	AV CONTROL UNIT
Connector Color	WHITE

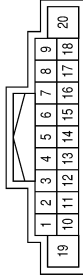

Terminal No.	Color of Wire	Signal Name
1	-	-
2	LW	FR_DR_LH_SP+
3	L/R	FR_DR_LH_SP-
4	SB	RR_DR_LH_SP+
5	B/Y	RR_DR_LH_SP-
6	Y	STRG_SW_A

Terminal No.	Color of Wire	Signal Name
7	V	ACC
8	-	-
9	R/L	ILL
10	-	-
11	W/B	FR_RH_SP+
12	L/B	FR_RH_SP-
13	O/L	RR_RH_SP+
14	R/L	RR_RH_SP-
15	SHIELD	STRG_SW_GND
16	BR	STRG_SW_B
17	-	-
18	-	-
19	Y	B+
20	B	GND

Connector No.	M43
Connector Name	AV CONTROL UNIT
Connector Color	WHITE

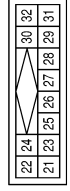

Terminal No.	Color of Wire	Signal Name
21	B	N_BUS_LH-
22	W	N_BUS_LH+
23	BR	N_BUS_RH-
24	Y	N_BUS_RH+
25	SHIELD	N_BUS_SHIELD
26	SHIELD	DATA_GND
27	-	-
28	W	REQ1_(TO HU)
29	R	RX_(TO HU)
30	B	TX_(FROM HU)
31	-	-
32	-	-

Connector No.	M44
Connector Name	AV CONTROL UNIT (BOSE)
Connector Color	WHITE

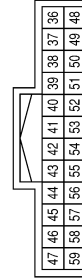

Terminal No.	Color of Wire	Signal Name
36	Y	COMP_OUT+
37	L	COMP_OUT-
38	R	B

Terminal No.	Color of Wire	Signal Name
39	B	G
40	W	R
41	W	RGB_SYNC
42	SHIELD	RGB_SYNC_GND
43	O	YS
44	LG	DISP_IT
45	W/L	HP
46	G/O	SIG_GND
47	B/O	SIG_VCC
48	G	COMP_OUT_SYNC
49	SHIELD	COMP_OUT_SHIELD
50	SHIELD	RBG_GND

Terminal No.	Color of Wire	Signal Name
51	-	-
52	-	-
53	-	-
54	B	GND
55	SHIELD	SHIELD
56	V	IT DISP
57	O/L	VP
58	B	INV GND
59	BR/Y	INV VCC

ALNIA0476GB

# AV CONTROL UNIT

[BOSE AUDIO WITHOUT NAVIGATION]

< ECU DIAGNOSIS >

Connector No.	M45
Connector Name	AUDIO CONTROL UNIT
Connector Color	WHITE



67	66	65	64	63	62	61	60
75	74	73	72	71	70	69	68

Terminal No.	Color of Wire	Signal Name
60	-	-
61	-	-
62	-	-
63	-	-
64	L	COMP1_IN-

Connector No.	M46
Connector Name	AUDIO CONTROL UNIT
Connector Color	WHITE



91	90	89	88	87	86	85	84	83	82	81	80	79	78	77	76
107	106	105	104	103	102	101	100	99	98	97	96	95	94	93	92

Terminal No.	Color of Wire	Signal Name
76	O	HP_RH-
77	W/L	HP_RH+
78	P	TEL_VOICE (TO_IT)-
79	-	-
80	L	TEL_VOICE (TO_IT)+
81	SHIELD	VOICE_SHIELD
82	G	AUDIO_BUS_RH-
83	R	AUDIO_BUS_RH+
84	-	-
85	B	GND
86	L	CAN-H
87	P	CAN-L

Terminal No.	Color of Wire	Signal Name
65	W	COMP2_IN+
66	B/W	COMP1_IN+
67	-	-
68	-	-
69	-	-
70	-	-
71	-	-
72	SHIELD	COMP_IN_SHIELD
73	-	-
74	L	COMP1_IN-

Terminal No.	Color of Wire	Signal Name
88	W/L	M_CAN1_H
89	P/B	M_CAN1_L
90	L/W	M_CAN2_H
91	B/P	M_CAN2_L
92	W	HP_LH -
93	O/L	HP_LH +
94	SHIELD	HP_SHIELD
95	B	AUX_AUDIO_RH+
96	W	AUX_AUDIO_LH+
97	R	AUX_GND
98	B	AUDIO_BUS_LH-
99	W	AUDIO_BUS_LH+
100	-	-
101	B	SW_GND
102	-	-
103	SB	CD_EJECT
104	G/R	IGN
105	G/W	REVERSE_SIG
106	G	PKB_SIG
107	W/R	SPEED_8P

Connector No.	M56
Connector Name	WIRE TO WIRE
Connector Color	WHITE



1	2	3	4	5	6	7
8	9	10	11	12	13	14
15	16					

Terminal No.	Color of Wire	Signal Name
13	Y	-
14	B	-

ALNIA0477GB

A  
B  
C  
D  
E  
F  
G  
H  
I  
J  
K  
L  
M  
N  
O  
P

AV

# AV CONTROL UNIT

< ECU DIAGNOSIS >

[BOSE AUDIO WITHOUT NAVIGATION]

Connector No.	M68
Connector Name	WIRE TO WIRE
Connector Color	BROWN



Terminal No.	Color of Wire	Signal Name
1	V	-

Terminal No.	Color of Wire	Signal Name
11	B/W	-
14	B/Y	-
15	B/W	-
16	SHIELD	-
17	SHIELD	-
18	Y	-
19	BR	-
20	L	-
21	B/W	-
22	G/Y	-
23	BR	-
24	SB	-

Connector No.	M64
Connector Name	WIRE TO WIRE
Connector Color	BROWN

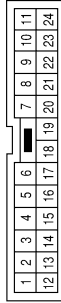

Terminal No.	Color of Wire	Signal Name
3	G	-
4	R	-
5	B	-
6	W	-
7	SHIELD	-
8	V	-

Connector No.	M75
Connector Name	WIRE TO WIRE
Connector Color	WHITE



Connector No.	M73
Connector Name	BACK-UP LAMP RELAY
Connector Color	BROWN



Terminal No.	Color of Wire	Signal Name
2	L/B	-
5	W/B	-

Terminal No.	Color of Wire	Signal Name
1	R	-
2	G	-
3	Y/R	-
5	W/B	-

Connector No.	M72
Connector Name	AV CONTROL UNIT
Connector Color	WHITE

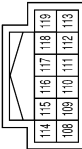

Terminal No.	Color of Wire	Signal Name
108	W	RR_RH_PRE+
109	BR	FR_RH_PRE+
110	GR/L	AMP_ON
111	SHIELD	SHIELD
112	L	RR_LH_PRE+
113	LG	FR_LH_PRE+
114	B	RR_RH_PRE-
115	B/R	FR_RH_PRE-
116	-	-
117	-	-
118	B/W	RR_LH_PRE-
119	V	FR_LH_PRE-

ALNIA0478GB

# AV CONTROL UNIT

[BOSE AUDIO WITHOUT NAVIGATION]

< ECU DIAGNOSIS >

Connector No.	M78
Connector Name	WIRE TO WIRE
Connector Color	BROWN



Terminal No.	Color of Wire	Signal Name
1	B	-
2	B	-

Connector No.	M93
Connector Name	DISPLAY UNIT
Connector Color	WHITE

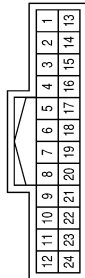

Terminal No.	Color of Wire	Signal Name
1	B	GND
2	BR/Y	INV_VCC
3	B/O	SIG_VCC
4	SHIELD	COMP_IN_SHIELD
5	L	COMP_IN -
6	B	G

Terminal No.	Color of Wire	Signal Name
7	SHIELD	RGB_GND
8	W/L	HP
9	O	YS
11	V	IT_DISP
13	B	INV_GND
14	G/O	SIG_GND
15	Y	COMP_IN+
16	G	COMP_IN SYNC
17	W	R
18	R	B
19	W	RGB_SYNC
20	O/L	VP
21	SHIELD	RGB_SYNC_GND
22	LG	DISP-IT
23	SHIELD	SHIELD

Connector No.	M98
Connector Name	A/C AND AV SWITCH ASSEMBLY
Connector Color	WHITE

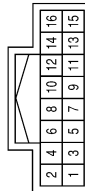

Terminal No.	Color of Wire	Signal Name
1	B	GND
2	V	ACC
3	R/L	ILL
4	BR	ILL_CONT_GND
5	W/L	M-CANI_H

Terminal No.	Color of Wire	Signal Name
6	P/B	M-CANI_L
7	B	SW_GND
8	SB	CD_DVD_EJECT
10	GR	REMOTE_A
11	LG	REMOTE_B
12	BR	REMOTE_C
13	G	REMOTE_D
14	R	ENABLE
15	Y	REMOTE_GND
16	GR/R	RR_DEFOG

Connector No.	M102
Connector Name	COMBINATION SWITCH (SPIRAL CABLE)
Connector Color	GRAY



Terminal No.	Color of Wire	Signal Name
16	R	-
17	BR	-
20	W	-

ALNIA0480GB

A  
B  
C  
D  
E  
F  
G  
H  
I  
J  
K  
L  
M  
N  
O  
P

AV

# AV CONTROL UNIT

[BOSE AUDIO WITHOUT NAVIGATION]

< ECU DIAGNOSIS >

Connector No.	M104
Connector Name	AUX JACK
Connector Color	WHITE



Terminal No.	Color of Wire	Signal Name
1	B	AUX_AUDIO_RH +
2	R	AUX_GND
4	W	AUX_AUDIO_LH +

Connector No.	M109
Connector Name	FRONT TWEETER LH
Connector Color	BROWN



Terminal No.	Color of Wire	Signal Name
1	L/W	-
2	L/R	-

Connector No.	M110
Connector Name	CENTER SPEAKER
Connector Color	BROWN



Terminal No.	Color of Wire	Signal Name
1	V	-
2	R	-

Connector No.	M111
Connector Name	FRONT TWEETER RH
Connector Color	BROWN



Terminal No.	Color of Wire	Signal Name
1	W/B	-
2	L/B	-

Connector No.	M112
Connector Name	BOSE SPEAKER AMP.
Connector Color	BROWN



Terminal No.	Color of Wire	Signal Name
1	SB	RR_DR_LH+_OUT
2	O/L	RR_DR_RH+_OUT
3	R/L	RR_DR_RH+_OUT
4	L/W	FR_DR_LH+_OUT

Terminal No.	Color of Wire	Signal Name
5	L/R	FR_DR_LH+_OUT
6	G	PWR_BK_DR_LH-
7	R	PWR_BK_DR_LH+
8	W/B	FR_DR_RH+_OUT
9	W	WOOFER+_OUT
10	B/Y	RR_DR_LH+_OUT
11	Y	BATT
12	B	GND
13	L/B	FR DR RH_ _OUT
14	B	WOOFER_ _OUT

ALNIA0481GB



# AV CONTROL UNIT

[BOSE AUDIO WITHOUT NAVIGATION]

< ECU DIAGNOSIS >

Connector No.	M113
Connector Name	BOSE SPEAKER AMP.
Connector Color	BROWN

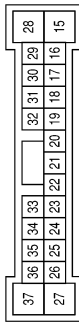

Terminal No.	Color of Wire	Signal Name
15	V	CENTER+
18	LG	FR_LH+ (IN)
19	BR	FR_RH+ (IN)
20	B/R	FR_RH- (IN)

Connector No.	M129
Connector Name	SATELLITE RADIO TUNER
Connector Color	VIOLET



Terminal No.	Color of Wire	Signal Name
37	B	-

Terminal No.	Color of Wire	Signal Name
21	L	RR_LH+ (IN)
22	B/W	RR_LH- (IN)
23	W	RR_RH+ (IN)
25	W/G	AMP_CTRL
27	L	PWR_BK_DR_RH-
28	R	CENTER-
31	GR/L	AMP_ON
32	V	FR_LH- (IN)
33	B	RR_RH+ (IN)
37	W/R	PWR_BK_DR_RH+

Connector No.	M157
Connector Name	WIRE TO WIRE
Connector Color	WHITE

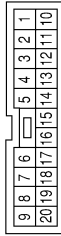

Terminal No.	Color of Wire	Signal Name
1	B	-
2	R/L	-
3	R/W	-
4	V	-
5	Y	-
6	G	-
7	R	-
8	SHIELD	-
17	SHIELD	-
19	G/R	-
20	W/R	-

Connector No.	M124
Connector Name	AV CONTROL UNIT
Connector Color	GRAY



Terminal No.	Color of Wire	Signal Name
120	B	-
121	B	-
122	B	-

Connector No.	M201
Connector Name	WIRE TO WIRE
Connector Color	WHITE

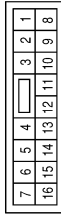

Terminal No.	Color of Wire	Signal Name
13	Y	-
14	B	-

ALNIA0482GB

A  
B  
C  
D  
E  
F  
G  
H  
I  
J  
K  
L  
M  
N  
O  
P

AV

# AV CONTROL UNIT

[BOSE AUDIO WITHOUT NAVIGATION]

< ECU DIAGNOSIS >

Connector No.	M202
Connector Name	WIRE TO WIRE
Connector Color	BROWN

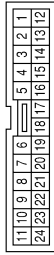

Terminal No.	Color of Wire	Signal Name
3	G	-
4	R	-
5	B	-
6	W	-
7	SHIELD	-

Connector No.	M205
Connector Name	DVD PLAYER
Connector Color	WHITE

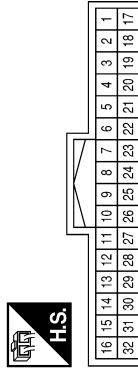

Terminal No.	Color of Wire	Signal Name
1	W	FES_L+_OUTPUT
2	B	FES_L-_OUTPUT
3	SHIELD	AUDIO_SHIELD
5	B	GND
6	BR	ILL+
7	W/L	M_CAN2-H

Terminal No.	Color of Wire	Signal Name
8	V	-
11	B/W	-
14	B/Y	-
15	B/W	-
16	SHIELD	-
17	SHIELD	-
18	Y	-
19	BR	-
20	L	-
21	B/W	-
22	G/Y	-
23	BR	-
24	SB	-

Terminal No.	Color of Wire	Signal Name
9	SB	DISPLAY_+ B
10	G/Y	SW_POWER+ 5V
12	B/W	VTR+
13	L	VTR-
14	B/W	DISPLAY_GND
16	Y	DATA RX
17	R	FES_R+_OUTPUT
18	G	FES_R-_OUTPUT
21	Y	+B
22	R/L	LIGHTING SW
23	P/B	M_CAN2-L
24	V	ACC
25	BR	DISPLAY_+B
26	B/Y	DISPLAY_GND
28	B/W	VIDEO_OUT
30	SHIELD	VTR_SHIELD
32	BR	DATA_TX

Connector No.	M350
Connector Name	WIRE TO WIRE
Connector Color	BROWN



Terminal No.	Color of Wire	Signal Name
1	B	-

ALNIA0483GB

# AV CONTROL UNIT

[BOSE AUDIO WITHOUT NAVIGATION]

< ECU DIAGNOSIS >

Connector No.	M551
Connector Name	WIRE TO WIRE
Connector Color	BROWN



Terminal No.	Color of Wire	Signal Name
1	B	-
2	B	-

Connector No.	M550
Connector Name	WIRE TO WIRE
Connector Color	BROWN



Terminal No.	Color of Wire	Signal Name
1	B	-
2	B	-

Connector No.	M351
Connector Name	SATELLITE ANTENNA
Connector Color	BROWN



Terminal No.	Color of Wire	Signal Name
1	B	-

Connector No.	E5
Connector Name	WIRE TO WIRE
Connector Color	WHITE

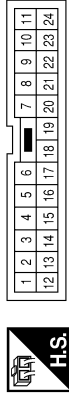

Terminal No.	Color of Wire	Signal Name
13	R	-

Connector No.	M602
Connector Name	ANTENNA AMP.
Connector Color	WHITE



Terminal No.	Color of Wire	Signal Name
1	B	-
2	B	-

Connector No.	M601
Connector Name	WIRE TO WIRE
Connector Color	GRAY



Terminal No.	Color of Wire	Signal Name
1	B	-
2	B	-

ALNIA0484GB

A  
B  
C  
D  
E  
F  
G  
H  
I  
J  
K  
L  
M  
O  
P

AV

# AV CONTROL UNIT

[BOSE AUDIO WITHOUT NAVIGATION]

< ECU DIAGNOSIS >

Connector No.	E35
Connector Name	WIRE TO WIRE
Connector Color	WHITE

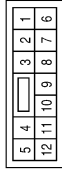

Terminal No.	Color of Wire	Signal Name
1	G/W	-

Connector No.	E152
Connector Name	WIRE TO WIRE
Connector Color	WHITE

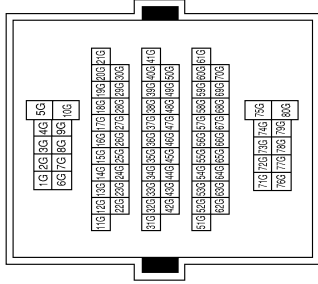

Terminal No.	Color of Wire	Signal Name
1G	G	-
2G	G/W	-
5G	Y	-
14G	R	-

Connector No.	F9
Connector Name	AT ASSEMBLY
Connector Color	GREEN

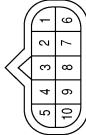

Terminal No.	Color of Wire	Signal Name
7	R	-

Connector No.	F14
Connector Name	WIRE TO WIRE
Connector Color	WHITE

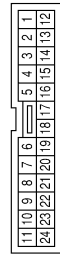

Terminal No.	Color of Wire	Signal Name
13	R	-

Connector No.	B6
Connector Name	WIRE TO WIRE
Connector Color	WHITE

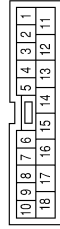

Terminal No.	Color of Wire	Signal Name
14	B/Y	-
15	SB	-

ALNIA0485GB

# AV CONTROL UNIT

[BOSE AUDIO WITHOUT NAVIGATION]

< ECU DIAGNOSIS >

Connector No.	B41
Connector Name	WIRE TO WIRE
Connector Color	WHITE

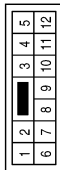

Terminal No.	Color of Wire	Signal Name
1	G/W	-

Connector No.	B48
Connector Name	WIRE TO WIRE
Connector Color	WHITE

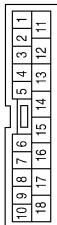

Terminal No.	Color of Wire	Signal Name
1	G	-
3	SHIELD	-
4	Y	-
11	R	-
12	G	-
14	B	-

Connector No.	B69
Connector Name	WIRE TO WIRE
Connector Color	WHITE

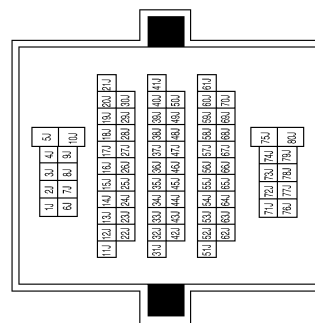

Terminal No.	Color of Wire	Signal Name
2J	V	-
10J	R	-
12J	BR	-
16J	B	-
17J	W	-
19J	Y	-
24J	SHIELD	-
27J	G	-
28J	R	-
29J	W/G	-
54J	W	-
55J	B	-
64J	G/W	-
72J	SB	-
76J	B/Y	-

A  
B  
C  
D  
E  
F  
G  
H  
I  
J  
K  
L  
M  
O  
P

AV

ALNIA0486GB

# AV CONTROL UNIT

[BOSE AUDIO WITHOUT NAVIGATION]

< ECU DIAGNOSIS >

Connector No.	B72
Connector Name	SUBWOOFER
Connector Color	BROWN



Terminal No.	Color of Wire	Signal Name
1	B	WOOFER-
2	W	WOOFER+
4	W/G	AMP_ON
5	B	GND
6	R	BATT

Connector No.	B73
Connector Name	REAR VIEW CAMERA CONTROL UNIT
Connector Color	WHITE

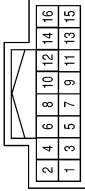

Terminal No.	Color of Wire	Signal Name
1	Y	BAT+
2	V	ACC

Terminal No.	Color of Wire	Signal Name
3	B	GND
4	G/W	REVERSE
5	BR	AV_CONT
6	G/W	DDL
8	Y	CAMERA_6V
9	SHIELD	CAMERA_-
10	G	CAMERA_+
11	B	VIDEO_GND
12	W	VIDEO_+

Connector No.	B106
Connector Name	WIRE TO WIRE
Connector Color	WHITE

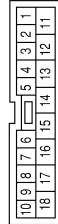

Terminal No.	Color of Wire	Signal Name
14	R/L	-
15	O/L	-

Connector No.	B139
Connector Name	WIRE TO WIRE
Connector Color	WHITE

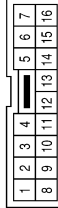

Terminal No.	Color of Wire	Signal Name
2	P	-
3	L	-

Connector No.	B141
Connector Name	BLUETOOTH CONTROL UNIT
Connector Color	WHITE

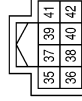

Terminal No.	Color of Wire	Signal Name
35	W/L	M_CAN_H
36	P/B	M_CAN_L

ALNIA0487GB

# AV CONTROL UNIT

[BOSE AUDIO WITHOUT NAVIGATION]

< ECU DIAGNOSIS >

Connector No.	B142
Connector Name	BLUETOOTH CONTROL UNIT
Connector Color	WHITE



2	4	6	8	10	12	14	16	18	20	22	24	26	28	30	32
1	3	5	7	9	11	13	15	17	19	21	23	25	27	29	31

Terminal No.	Color of Wire	Signal Name
1	Y	BATT
2	V	ACC

Terminal No.	Color of Wire	Signal Name
3	G/R	IGN
4	B/W	GND
6	SHIELD	MIC_SHIELD
7	B	MIC_IN+
8	R/L	MIC_IN-
9	G	AUDIO_OUT+
10	R	AUDIO_OUT-
21	B	CONT_2
22	B	CONT_3
23	B	CONT_4
28	W/R	SPEED_SIGNAL
29	R/W	MIC_POWER

Connector No.	B143
Connector Name	BLUETOOTH ANTENNA
Connector Color	BLACK



33	34
----	----

Terminal No.	Color of Wire	Signal Name
33	B	-
34	B	-

Connector No.	B145
Connector Name	WIRE TO WIRE
Connector Color	WHITE



1	2	3	4	5	6	7		
8	9	10	11	12	13	14	15	16

Terminal No.	Color of Wire	Signal Name
5	SB	-
6	BR	-
7	G/Y	-
8	W	-
9	L	-
10	SHIELD	-
11	B/W	-
12	B/Y	-
13	G	-
14	L	-
15	SHIELD	-

Connector No.	B146
Connector Name	WIRE TO WIRE
Connector Color	BROWN



1	2	3	4	5	6	7	8	9	10	11		
12	13	14	15	16	17	18	19	20	21	22	23	24

Terminal No.	Color of Wire	Signal Name
1	B	-
7	G	-
8	Y	-
9	SHIELD	-

Terminal No.	Color of Wire	Signal Name
10	W/L	-
11	O/L	-
17	B	-
18	GR	-
19	LG	-
20	BR	-
21	R	-
23	O	-
24	W	-

ALNIA0488GB

A B C D E F G H I J K L M N O P

AV

# AV CONTROL UNIT

[BOSE AUDIO WITHOUT NAVIGATION]

< ECU DIAGNOSIS >

Connector No.	B149
Connector Name	WIRE TO WIRE
Connector Color	WHITE

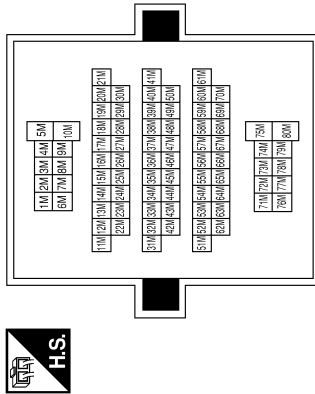

Terminal No.	Color of Wire	Signal Name
11M	SB	-
12M	BR	-
13M	G/Y	-
14M	B/W	-
15M	L	-
16M	SHIELD	-
17M	B/W	-
18M	O/L	-
19M	W	-
20M	W/L	-
21M	R	-
22M	Y	-
23M	G	-
24M	BR	-
25M	LG	-

Terminal No.	Color of Wire	Signal Name
26M	GR	-
27M	W/R	-
28M	SHIELD	-
29M	O	-
31M	B/Y	-
32M	BR	-
33M	Y	-
34M	SHIELD	-
35M	L	-
78M	O/L	-
79M	R/L	-

Connector No.	B161
Connector Name	WIRE TO WIRE
Connector Color	WHITE

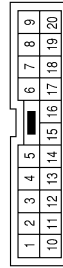

Terminal No.	Color of Wire	Signal Name
6	G	-
7	R	-
8	SHIELD	-
17	SHIELD	-
19	G/R	-
20	W/R	-

Connector No.	R2
Connector Name	WIRE TO WIRE
Connector Color	WHITE



Terminal No.	Color of Wire	Signal Name
1	B	-
2	R/L	-
3	R/W	-
4	V	-
5	Y	-

Terminal No.	Color of Wire	Signal Name
1	R/W	-
5	R/L	-
6	SHIELD	-
12	B	-

ALNIA0489GB



# AV CONTROL UNIT

[BOSE AUDIO WITHOUT NAVIGATION]

< ECU DIAGNOSIS >

Connector No.	R109
Connector Name	MICROPHONE
Connector Color	WHITE

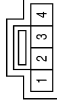

Terminal No.	Color of Wire	Signal Name
1	B	-
2	R/L	-
4	R/W	-

Connector No.	R107
Connector Name	WIRE TO WIRE
Connector Color	WHITE

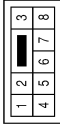

Terminal No.	Color of Wire	Signal Name
1	R/L	-
2	R/W	-
4	B	-

Connector No.	R9
Connector Name	WIRE TO WIRE
Connector Color	WHITE

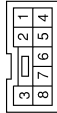

Terminal No.	Color of Wire	Signal Name
1	R/L	-
2	R/W	-
4	B	-

Terminal No.	Color of Wire	Signal Name
10	SHIELD	-
11	B/W	-
12	B/Y	-
13	G	-
14	L	-
15	SHIELD	-

Connector No.	R200
Connector Name	WIRE TO WIRE
Connector Color	WHITE

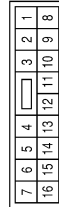

Terminal No.	Color of Wire	Signal Name
5	SB	-
6	BR	-
7	G/Y	-
8	W	-
9	L	-

ALNIA0490GB

A  
B  
C  
D  
E  
F  
G  
H  
I  
J  
K  
L  
M  
N  
O  
P

AV

# AV CONTROL UNIT

< ECU DIAGNOSIS >

[BOSE AUDIO WITHOUT NAVIGATION]

Terminal No.	Color of Wire	Signal Name
17	B	-
18	GR	-
19	LG	-
20	BR	-
21	R	-
23	O	-
24	W	-

Connector No.	R201
Connector Name	WIRE TO WIRE
Connector Color	BROWN

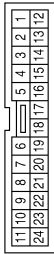

Terminal No.	Color of Wire	Signal Name
1	B	-
7	G	-
8	Y	-
9	SHIELD	-
10	W/L	-
11	O/L	-

Terminal No.	Color of Wire	Signal Name
8	L	VIDEO IN-
9	SHIELD	VIDEO_SHIELD
10	G/Y	SW_POWER_+5V
11	SB	FILTERED_BAT
12	BR	FILTERED_BAT

Connector No.	R202
Connector Name	VIDEO MONITOR
Connector Color	WHITE

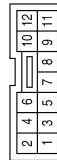

Terminal No.	Color of Wire	Signal Name
1	B/W	GND
2	B/Y	GND
3	B	1D
4	SHIELD	O/A_SHIELD
5	G	DATA_RX
6	L	DATA_TX
7	W	VIDEO IN+

ALNIA0491GB

# AV CONTROL UNIT

[BOSE AUDIO WITHOUT NAVIGATION]

< ECU DIAGNOSIS >

Connector No.	R204
Connector Name	REAR AUDIO REMOTE CONTROL UNIT
Connector Color	WHITE

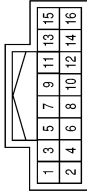

Terminal No.	Color of Wire	Signal Name
1	O/L	L_CH_INPUT
2	W	L_CH_INPUT
3	W/L	R_CH_INPUT
4	O	R_CH_INPUT
5	SHIELD	SHIELD
6	R/L	ILL+
7	Y	REMOTE

Terminal No.	Color of Wire	Signal Name
8	R	ENABLE
9	GR	REMOTE_A
10	LG	REMOTE_B
11	BR	REMOTE_C
12	G	REMOTE_D
15	B	GND

Connector No.	D2
Connector Name	WIRE TO WIRE
Connector Color	WHITE

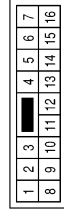

Terminal No.	Color of Wire	Signal Name
10	L/R	-
11	L/W	-

Connector No.	D12
Connector Name	FRONT DOOR SPEAKER LH
Connector Color	WHITE



Terminal No.	Color of Wire	Signal Name
1	L/W	-
2	L/R	-

Connector No.	D101
Connector Name	WIRE TO WIRE
Connector Color	WHITE

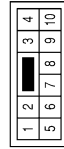

Terminal No.	Color of Wire	Signal Name
2	L/B	-
5	W/B	-

Connector No.	D112
Connector Name	FRONT DOOR SPEAKER RH
Connector Color	WHITE



Terminal No.	Color of Wire	Signal Name
1	W/B	-
2	L/B	-

ALNIA0492GB

A  
B  
C  
D  
E  
F  
G  
H  
I  
J  
K  
L  
M  
N  
O  
P

AV

# AV CONTROL UNIT

[BOSE AUDIO WITHOUT NAVIGATION]

< ECU DIAGNOSIS >

Connector No.	D201
Connector Name	WIRE TO WIRE
Connector Color	WHITE

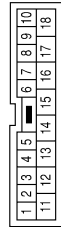

Terminal No.	Color of Wire	Signal Name
14	B/Y	-
15	SB	-

Connector No.	D207
Connector Name	REAR DOOR SPEAKER LH
Connector Color	WHITE



Terminal No.	Color of Wire	Signal Name
1	SB	-
2	B/Y	-

Connector No.	D208
Connector Name	REAR DOOR TWEETER LH
Connector Color	BROWN



Terminal No.	Color of Wire	Signal Name
1	SB	-
2	B/Y	-

Connector No.	D301
Connector Name	WIRE TO WIRE
Connector Color	WHITE

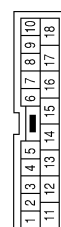

Terminal No.	Color of Wire	Signal Name
14	R/L	-
15	O/L	-

Connector No.	D307
Connector Name	REAR DOOR SPEAKER RH
Connector Color	WHITE



Terminal No.	Color of Wire	Signal Name
1	O/L	-
2	R/L	-

Connector No.	D308
Connector Name	REAR DOOR TWEETER RH
Connector Color	BROWN



Terminal No.	Color of Wire	Signal Name
1	O/L	-
2	R/L	-

ALNIA0493GB

# AV CONTROL UNIT

[BOSE AUDIO WITHOUT NAVIGATION]

< ECU DIAGNOSIS >

Connector No.	D501
Connector Name	WIRE TO WIRE
Connector Color	WHITE

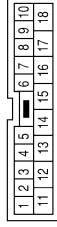

Terminal No.	Color of Wire	Signal Name
1	G	-
2	B	-
3	SHIELD	-
4	Y	-
11	R	-
12	G	-

Connector No.	D405
Connector Name	WIRE TO WIRE
Connector Color	WHITE

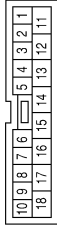

Terminal No.	Color of Wire	Signal Name
1	G	-
2	B	-
3	SHIELD	-
4	Y	-
11	R	-
12	G	-

Connector No.	D401
Connector Name	WIRE TO WIRE
Connector Color	WHITE

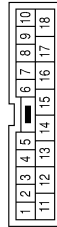

Terminal No.	Color of Wire	Signal Name
1	G	-
3	SHIELD	-
4	Y	-
11	R	-
12	G	-
14	B	-

Connector No.	D602
Connector Name	WIRE TO WIRE
Connector Color	WHITE

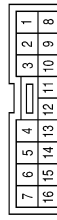

Terminal No.	Color of Wire	Signal Name
2	P	-
3	L	-

Connector No.	D518
Connector Name	BACK DOOR SPEAKER LH
Connector Color	BROWN



Terminal No.	Color of Wire	Signal Name
1	G	-
2	R	-

Connector No.	D504
Connector Name	REAR VIEW CAMERA
Connector Color	WHITE





Terminal No.	Color of Wire	Signal Name
1	Y	CAMERA 6V
2	B	GND
3	G	CAMERA +
4	SHIELD	CAMERA -

ALNIA0494GB

A  
B  
C  
D  
E  
F  
G  
H  
I  
J  
K  
L  
M  
N  
O  
P

AV

Connector No.	D716
Connector Name	BACK DOOR SPEAKER RH
Connector Color	BROWN

Terminal No.	Color of Wire	Signal Name
1	P	-
2	L	-

Connector No.	D701
Connector Name	WIRE TO WIRE
Connector Color	WHITE

Terminal No.	Color of Wire	Signal Name
2	L	-
3	P	-

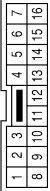
Connector No.	D606
Connector Name	WIRE TO WIRE
Connector Color	WHITE

Terminal No.	Color of Wire	Signal Name
2	P	-
3	L	-

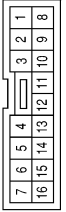
### DTC Index

#### Self-diagnosis results display item

Error item	Refer to
CAN COMM CIRCUIT [U1000]	<a href="#">AV-142, "Description"</a>
CONTROL UNIT (CAN) [U1010]	<a href="#">AV-143, "Description"</a>

ALNIA0495GB

INFOID:000000001317767

# AV CONTROL UNIT

[BOSE AUDIO WITHOUT NAVIGATION]

< ECU DIAGNOSIS >

Error item	Refer to
Control Unit FLASH-ROM [U1200]	<a href="#">AV-144. "Description"</a>
CAN CONT [U1216]	<a href="#">AV-145. "Description"</a>
SWITCH CONN [U1240]	<a href="#">AV-146. "Description"</a>
FRONT DISP CONN [U1243]	<a href="#">AV-147. "Description"</a>
DVD DECK CONN [U1248]	<a href="#">AV-149. "Description"</a>
SAT CONN [U1255]	<a href="#">AV-150. "Description"</a>
HAND FREE CONN [U1256]	<a href="#">AV-151. "Description"</a>
AV COMM CIRCUIT [U1300]	<a href="#">AV-152. "Description"</a>
CONTROL UNIT (AV) [U1310]	<a href="#">AV-153. "Description"</a>

A

B

C

D

E

F

G

H

I

J

K

L

M

AV

O

P

# DISPLAY UNIT

[BOSE AUDIO WITHOUT NAVIGATION]

< ECU DIAGNOSIS >

## DISPLAY UNIT

Reference Value

INFOID:000000001381368

### TERMINAL LAYOUT

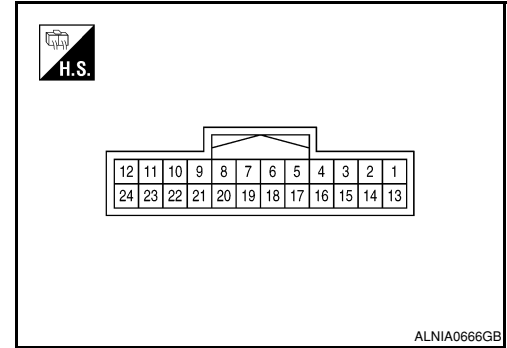

### PHYSICAL VALUES

Terminal (Wire color)		Description		Condition		Reference value (Approx.)
+	-	Signal name	Input/ Output			
1 (B)	Ground	Ground	—	Ignition switch ON	—	0V
2 (BR/Y)	Ground	Inverter VCC	Input	Ignition switch ACC	—	9V
3 (B/O)	Ground	Signal VCC	Input	Ignition switch ACC	—	9V
4	—	Shield	—	—	—	—
5 (L)	Ground	AUX image ground	—	Ignition switch ON	—	0V
6 (B)	Ground	RGB signal (G: green)	Input	Ignition switch ON	Start confirmation/adjust- ment mode, and then dis- play color bar by selecting "Color Spectrum Bar" on DISPLAY DIAGNO- SIS screen.	 SKIB2236J
7	—	Shield	—	—	—	—
8 (W/L)	Ground	Horizontal synchronizing (HP) signal	Output	Ignition switch ON	—	 SKIB3601E



# DISPLAY UNIT

[BOSE AUDIO WITHOUT NAVIGATION]

< ECU DIAGNOSIS >

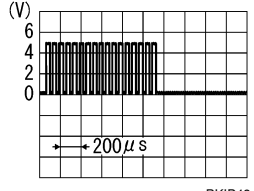
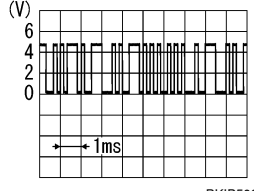
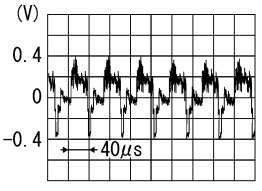
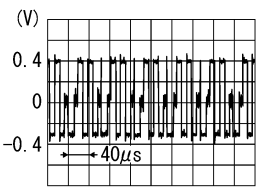
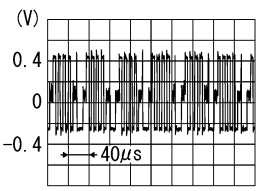
Terminal (Wire color)		Description		Condition	Reference value (Approx.)
+	-	Signal name	Input/ Output		
9 (O)	Ground	RGB area (YS) signal	Input	Ignition switch ON	At RGB image displayed 5V
				Ignition switch ON	At rear view camera image displayed 
11 (V)	Ground	Communication signal (CONT→DISP)	Input	Ignition switch ON	When adjusting display-brightness 
13 (B)	Ground	Inverter ground	—	Ignition switch ON	— 0V
14 (G/O)	Ground	Signal ground	—	Ignition switch ON	— 0V
15 (Y)	Ground	AUX image signal	Input	Ignition switch ON	When AUX mode is selected 
16 (G)	—	AUX image synchronizing signal	Input	—	—
17 (W)	Ground	RGB signal (R: red)	Input	Ignition switch ON	Start confirmation/adjustment mode, and then display color bar by selecting "Color Spectrum Bar" on DISPLAY DIAGNOSIS screen. 
18 (R)	Ground	RGB signal (B: blue)	Input	Ignition switch ON	Start confirmation/adjustment mode, and then display color bar by selecting "Color Spectrum Bar" on DISPLAY DIAGNOSIS screen. 

A  
B  
C  
D  
E  
F  
G  
H  
I  
J  
K  
L  
M  
AV  
O  
P

# DISPLAY UNIT

[BOSE AUDIO WITHOUT NAVIGATION]

< ECU DIAGNOSIS >

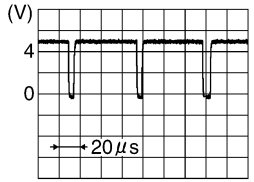
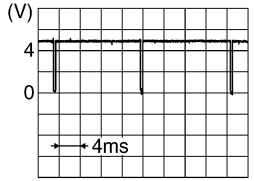
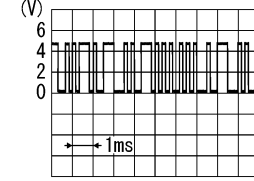
Terminal (Wire color)		Description		Condition		Reference value (Approx.)
+	-	Signal name	Input/ Output			
19 (W)	Ground	RGB synchronizing signal	Input	Ignition switch ON	—	 <p>SKIB3603E</p>
20 (O/L)	Ground	Vertical synchronizing (VP) signal	Output	Ignition switch On	—	 <p>SKIB3598E</p>
21	—	Shield	—	—	—	—
22 (LG)	Ground	Communication signal (DISP→CONT)	Output	Ignition switch ON	When adjusting display- brightness	 <p>PKIB5039J</p>
23	—	Shield	—	—	—	—

# BOSE SPEAKER AMP

[BOSE AUDIO WITHOUT NAVIGATION]

< ECU DIAGNOSIS >

## BOSE SPEAKER AMP

Reference Value

INFOID:000000001317769

TERMINAL LAYOUT

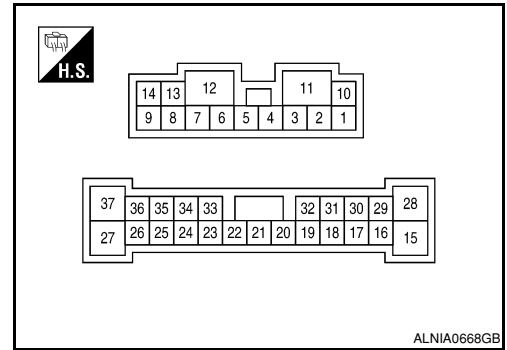

PHYSICAL VALUES

Terminal (Wire color)		Description		Condition		Reference value (Approx.)
+	-	Signal name	Input/Output			
1 (SB)	10 (B/Y)	Audio signal rear door speaker and tweeter LH	Output	Ignition switch ON	Audio output	<p>SKIB3609E</p>
2 (O/L)	3 (R/L)	Audio signal rear door speaker and tweeter RH	Output	Ignition switch ON	Audio output	<p>SKIB3609E</p>
4 (L/W)	5 (L/R)	Audio signal front door speaker and tweeter LH	Output	Ignition switch ON	Audio output	<p>SKIB3609E</p>
6 (G)	7 (R)	Audio signal back door speaker LH	Output	Ignition switch ON	Audio output	<p>SKIB3609E</p>

A  
B  
C  
D  
E  
F  
G  
H  
I  
J  
K  
L  
M  
N  
O  
P

AV

# BOSE SPEAKER AMP

[BOSE AUDIO WITHOUT NAVIGATION]

< ECU DIAGNOSIS >

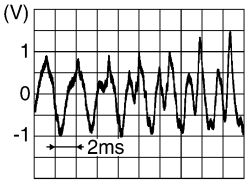
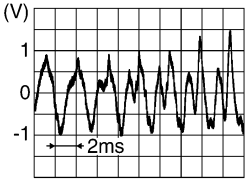
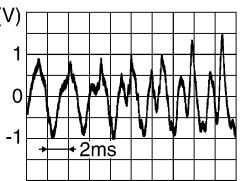
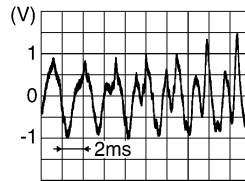
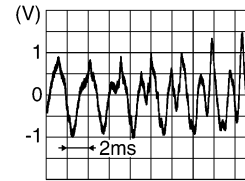
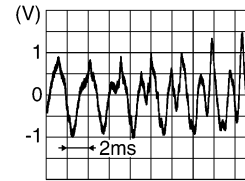
Terminal (Wire color)		Description		Condition		Reference value (Approx.)
+	-	Signal name	Input/ Output			
8 (W/B)	13 (L/B)	Audio signal front door speaker and tweeter RH	Output	Ignition switch ON	Audio output	 <p>SKIB3609E</p>
9 (W)	14 (B)	Audio signal subwoofer	Output	Ignition switch ON	Audio output	 <p>SKIB3609E</p>
11 (Y)	Ground	Battery power supply	Input	Ignition switch OFF	—	Battery voltage
12 (B)	Ground	Ground	—	Ignition switch ON	—	0V
15 (V)	28 (R)	Audio signal center speaker	Output	Ignition switch ON	Audio output	 <p>SKIB3609E</p>
18 (LG)	32 (V)	Audio signal front LH	Input	Ignition switch ON	Audio input	 <p>SKIB3609E</p>
19 (B/R)	20 (B/R)	Audio signal front RH	Input	Ignition switch ON	Audio input	 <p>SKIB3609E</p>
21 (L)	22 (B/W)	Audio signal rear LH	Input	Ignition switch ON	Audio input	 <p>SKIB3609E</p>

# BOSE SPEAKER AMP

[BOSE AUDIO WITHOUT NAVIGATION]

< ECU DIAGNOSIS >

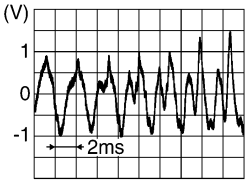
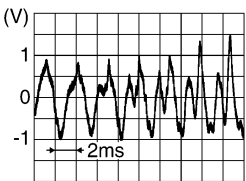
Terminal (Wire color)		Description		Condition		Reference value (Approx.)
+	-	Signal name	Input/ Output			
23 (W)	33 (B)	Audio signal rear RH	Input	Ignition switch ON	Audio input	 (V) 1 0 -1 ← 2ms SKIB3609E
25 (W/G)	Ground	Subwoofer amp. ON signal	Output	Ignition switch ACC	—	12V
31 (GR/L)	Ground	Amp. ON signal	Input	Ignition switch ACC	—	12V
37 (W/R)	27 (L)	Audio signal back door speaker RH	Input	Ignition switch ON	Audio input	 (V) 1 0 -1 ← 2ms SKIB3609E

A  
B  
C  
D  
E  
F  
G  
H  
I  
J  
K  
L  
M  
AV  
O  
P

AV

# SATELLITE RADIO TUNER

[BOSE AUDIO WITHOUT NAVIGATION]

< ECU DIAGNOSIS >

## SATELLITE RADIO TUNER

Reference Value

INFOID:000000001381367

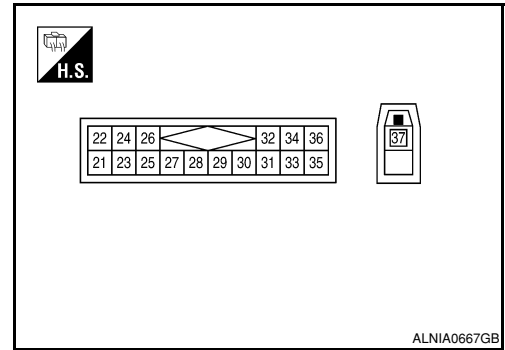

### PHYSICAL VALUES

Terminal		Description		Condition		Reference value (Approx.)
+	-	Signal name	Input/Output			
22 (W)	21 (B)	Satellite radio sound signal LH	Output	Ignition switch ON	When satellite radio mode is selected	 SKIB3609E
24 (Y)	23 (BR)	Satellite radio sound signal RH	Output	Ignition switch ON	When satellite radio mode is selected	 SKIB3609E
25	—	Shield	—	—	—	—
26	—	Shield	—	—	—	—
28 (W)	Ground	Request signal (SAT→CONT)	Output	Ignition switch ON	When satellite radio mode is selected	 SKIA9299J
29 (B)	Ground	Communication signal (SAT→CONT)	Output	Ignition switch ON	When satellite radio mode is selected	 SKIA9300J

# SATELLITE RADIO TUNER

[BOSE AUDIO WITHOUT NAVIGATION]

< ECU DIAGNOSIS >

Terminal		Description		Condition		Reference value (Approx.)
+	-	Signal name	Input/ Output			
30 (R)	Ground	Communication signal (CONT→SAT)	Input	Ignition switch ON	When satellite radio mode is selected	
32 (G)	Ground	Battery power supply	Input	Ignition switch OFF	—	Battery voltage
36 (R)	Ground	ACC power supply	Input	Ignition switch ACC	—	Battery voltage
37 (B)	—	Satellite antenna	Input	—	—	—

A  
B  
C  
D  
E  
F  
G  
H  
I  
J  
K  
L  
M

AV

O  
P

# BLUETOOTH CONTROL UNIT

< ECU DIAGNOSIS >

[BOSE AUDIO WITHOUT NAVIGATION]

## BLUETOOTH CONTROL UNIT

Reference Value

INFOID:000000001381366

### TERMINAL LAYOUT

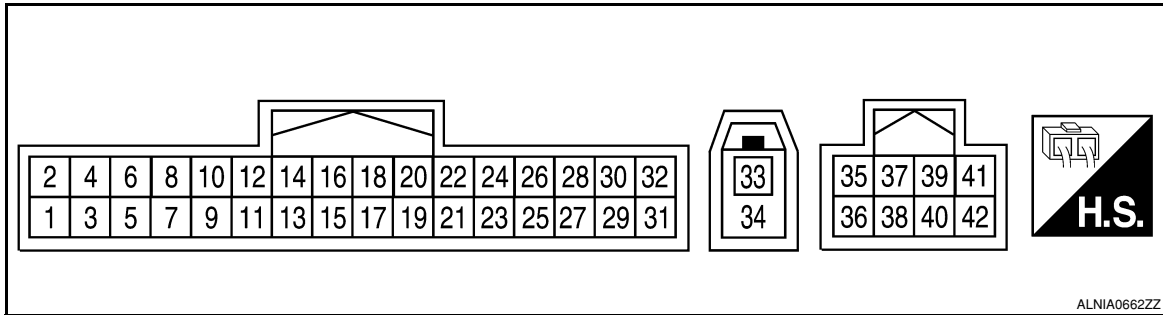

ALNIA0662ZZ

### PHYSICAL VALUES

Terminal (wire color)		Description		Condition		Reference value (Approx.)
+	-	Signal name	Input/ output			
1 (Y)	Ground	Battery power	Input	-	-	Battery voltage
2 (V)	Ground	ACC power	Input	Ignition switch ACC/ON	-	Battery voltage
3 (G/R)	Ground	IGN power	Input	Ignition switch ON/ START	-	Battery voltage
4 (B/W)	Ground	Ground	-	Ignition switch ON	-	0V
6	-	Shield	-	-	-	-
7 (B)	8 (R/L)	MIC in signal	Input	-	-	-
9 (G)	10 (R)	Audio out	Output	Ignition switch ACC/ON	Bluetooth control unit sends audio signal	<p>(V)</p> <p>1</p> <p>0</p> <p>-1</p> <p>← 2ms</p> <p>SKIB3609E</p>
21 (B)	Ground	Ground	-	-	-	0V
22 (B)	Ground	Ground	-	-	-	0V
23 (B)	Ground	Ground	-	-	-	0V



# BLUETOOTH CONTROL UNIT

[BOSE AUDIO WITHOUT NAVIGATION]

< ECU DIAGNOSIS >

Terminal (wire color)		Description		Condition		Reference value (Approx.)
+	-	Signal name	Input/ output			
24 (W/R)	Ground	Vehicle speed signal (8-pulse)	Input	Ignition switch ON	When vehicle speed is approx. 40 km/h (25 MPH)	
25 (R/W)	Ground	Microphone power	Output	Ignition switch ON	-	5V
33 (B)	-	Bluetooth antenna	-	-	-	-
34 (B)	-	Bluetooth antenna	-	-	-	-
35 (W/L)	-	M-CAN (+)	-	-	-	-
36 (P/B)	-	M-CAN (-)	-	-	-	-

A  
B  
C  
D  
E  
F  
G  
H  
I  
J  
K  
L  
M  
O  
P

AV

# REAR VIEW CAMERA CONTROL UNIT

< ECU DIAGNOSIS >

[BOSE AUDIO WITHOUT NAVIGATION]

## REAR VIEW CAMERA CONTROL UNIT

Reference Value

INFOID:000000001396313

### TERMINAL LAYOUT

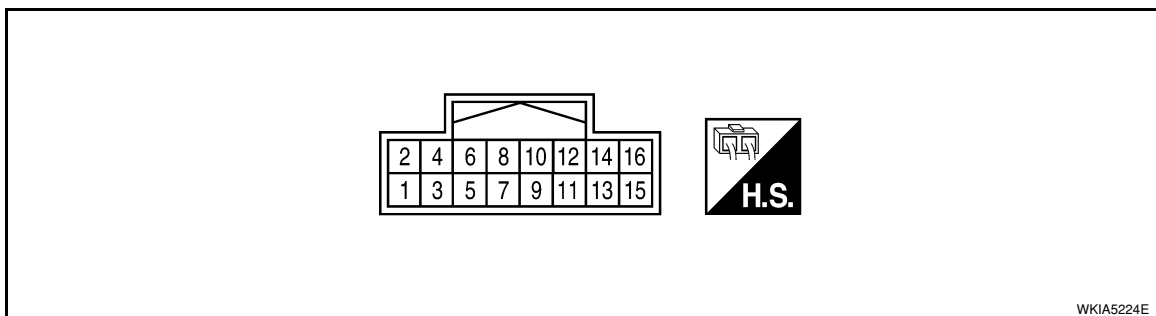

### PHYSICAL VALUES

Terminal (wire color)	-	Description		Condition		Reference value (Approx.)
		Signal name	Input/ Output			
1 (Y)	Ground	Battery power	Input	Ignition switch OFF	—	Battery voltage
2 (V)	Ground	ACC power	Input	Ignition switch ACC	—	Battery voltage
3 (B)	Ground	Ground	—	Ignition switch ON	—	0V
4 (G/W)	Ground	Reverse signal input	Input	Ignition switch ON	A/T selector lever R position	Battery voltage
					A/T selector lever in other than R position	0V
5 (BR)	Ground	AV Control	Output	Ignition switch ON	—	0V
6 (G/W)	Ground	DDL	Output	—	—	—
8 (Y)	Ground	Camera power output	Output	Ignition switch ON	A/T selector lever R position	6V
9	Ground	Camera image input (-)	Input	Ignition switch ON	—	0V
10 (G)	Ground	Camera image input (+)	Input	Ignition switch ON	A/T selector lever R position	

SKIA4894E

# REAR VIEW CAMERA CONTROL UNIT

[BOSE AUDIO WITHOUT NAVIGATION]

< ECU DIAGNOSIS >

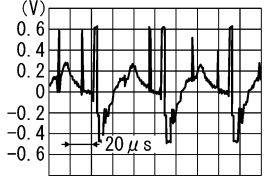
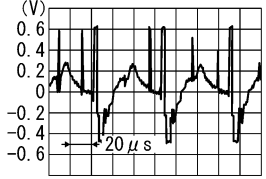
Terminal (wire color)	+	-	Description		Condition		Reference value (Approx.)
			Signal name	Input/ Output			
11 (B)		Ground	Composite image output (-)	Output	Ignition switch ON	A/T selector lever R position	 <p style="text-align: right; font-size: small;">SKIA4896E</p>
12 (W)		Ground	Composite image output (+)	Output	Ignition switch ON	A/T selector lever R position	 <p style="text-align: right; font-size: small;">SKIA4896E</p>

A  
B  
C  
D  
E  
F  
G  
H  
I  
J  
K  
L  
M  
O  
P

AV

# DVD PLAYER

< ECU DIAGNOSIS >

[BOSE AUDIO WITHOUT NAVIGATION]

## DVD PLAYER

### Reference Value

INFOID:000000001381370

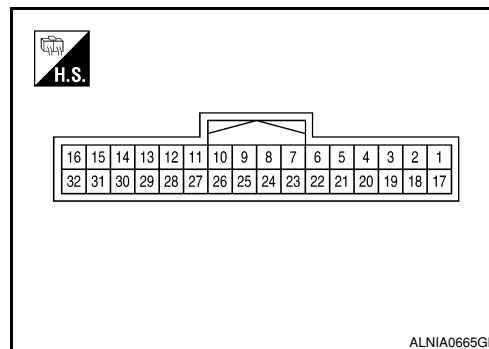

### PHYSICAL VALUES

Terminal (Wire color)		Description		Condition		Reference value (Approx.)
+	-	Signal name	Input/ Output			
1 (W)	2 (B)	DVD audio signal LH	Output	Ignition switch ON	With operation of the DVD player	<p>SKIB3609E</p>
3	—	Shield	—	—	—	—
5 (B)	Ground	Ground	—	Ignition switch ON	—	0V
6 (BR)	Ground	Illumination control (pulse width modulated)	—	—	With lighting switch ON	—
7 (W/L)	Ground	Can communication	Input/ Output	Ignition switch ON	—	—
9 (SB)	Ground	Video monitor power sup- ply	Output	Ignition switch ON	With DVD player operation	12V
10 (G/Y)	Ground	Switch power	Output	Ignition switch ON	With DVD player operation	5V
12 (B/W)	Ground	VTR (+)	Output	Ignition switch ON	With DVD player operation	—
13 (L)	Ground	VTR (-)	Output	Ignition switch ON	With DVD player operation	—
14 (B/W)	Ground	Display ground	—	Ignition switch ON	With DVD player operation	0V
16 (Y)	—	Data receive	Input	—	—	—

# DVD PLAYER

< ECU DIAGNOSIS >

[BOSE AUDIO WITHOUT NAVIGATION]

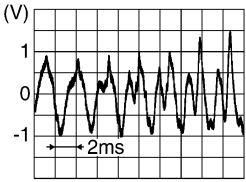
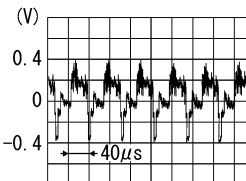
Terminal (Wire color)		Description		Condition		Reference value (Approx.)
+	-	Signal name	Input/ Output			
17 (R)	18 (G)	DVD audio signal RH	Output	Ignition switch ON	With DVD player operation	
21 (Y)	Ground	Battery power	Input	—	—	12V
22 (R/L)	Ground	Illumination power	Input	—	With instrument illumination ON	12V
23 (P/B)	Ground	CAN communication	Input/ Output	Ignition switch ON	—	0V
24 (V)	Ground	ACC power	Input	Ignition switch ACC or ON	—	12V
25 (BR)	Ground	Video monitor power	Output	Ignition switch ON	With DVD player operation	12V
26 (B/Y)	Ground	Video monitor ground	Input	Ignition switch ON	With instrument illumination ON	0V
28 (B/W)	Ground	Video out	Input	Ignition switch ACC or ON	—	
30	—	Shield	—	—	—	—
32 (BR)	—	Data transmit	Output	—	—	—

A  
B  
C  
D  
E  
F  
G  
H  
I  
J  
K  
L  
M

AV

# AUDIO SYSTEM

< SYMPTOM DIAGNOSIS >

[BOSE AUDIO WITHOUT NAVIGATION]

## SYMPTOM DIAGNOSIS

### AUDIO SYSTEM

#### Symptom Table

INFOID:000000001278772

#### AUDIO SYSTEM

Symptom	Possible cause	Reference page
Inoperative	<ul style="list-style-type: none"><li>• AV control unit power circuit</li><li>• AV control unit</li></ul>	<ul style="list-style-type: none"><li>• <a href="#">AV-154</a></li><li>• <a href="#">AV-133</a></li></ul>
Steering switch does not operate	<ul style="list-style-type: none"><li>• Steering switch</li><li>• AV control unit</li></ul>	<ul style="list-style-type: none"><li>• <a href="#">AV-194</a></li><li>• <a href="#">AV-133</a></li></ul>
All speakers do not sound	<ul style="list-style-type: none"><li>• AV control unit</li><li>• AV control unit power circuit</li><li>• BOSE speaker amp. ON signal</li><li>• BOSE speaker amp. power/ground circuit</li><li>• BOSE speaker amp.</li></ul>	<ul style="list-style-type: none"><li>• <a href="#">AV-133</a></li><li>• <a href="#">AV-154</a></li><li>• <a href="#">AV-193</a></li><li>• <a href="#">AV-157</a></li><li>• <a href="#">AV-193</a></li></ul>
One or several speakers do not sound	<ul style="list-style-type: none"><li>• Front door speaker</li><li>• Front tweeter</li><li>• Center speaker</li><li>• Rear door speaker</li><li>• Rear door tweeter</li><li>• Back door speaker</li><li>• Subwoofer</li></ul>	<ul style="list-style-type: none"><li>• <a href="#">AV-173</a></li><li>• <a href="#">AV-176</a></li><li>• <a href="#">AV-179</a></li><li>• <a href="#">AV-181</a></li><li>• <a href="#">AV-184</a></li><li>• <a href="#">AV-187</a></li><li>• <a href="#">AV-190</a></li></ul>

#### CD

Symptom	Possible cause	Reference page
CD cannot be inserted.	AV control unit	<a href="#">AV-133</a>
CD cannot be ejected.		
The CD cannot be played.		
The sound skips, stops suddenly, or is distorted.		

#### SATELLITE RADIO

Symptom	Possible cause	Reference page
Inoperative	<ul style="list-style-type: none"><li>• Satellite radio tuner power or ground circuit</li><li>• Satellite radio tuner communication circuit</li><li>• Satellite radio tuner</li></ul>	<ul style="list-style-type: none"><li>• <a href="#">AV-158</a></li><li>• <a href="#">AV-196</a></li><li>• <a href="#">AV-158</a></li></ul>
Right or left channel does not sound	<ul style="list-style-type: none"><li>• Satellite radio tuner right channel audio signal circuit</li><li>• Satellite radio tuner left channel audio signal circuit</li><li>• Satellite radio tuner</li></ul>	<ul style="list-style-type: none"><li>• <a href="#">AV-199</a></li><li>• <a href="#">AV-199</a></li><li>• <a href="#">AV-158</a></li></ul>

#### HANDS-FREE PHONE

Symptom	Possible cause	Reference page
Inoperative	<ul style="list-style-type: none"><li>• Bluetooth control unit power and ground circuit</li><li>• Bluetooth control unit</li></ul>	<ul style="list-style-type: none"><li>• <a href="#">AV-163</a></li><li>• <a href="#">AV-141</a></li></ul>
Steering switch does not operate	<ul style="list-style-type: none"><li>• Steering switch</li><li>• Bluetooth control unit</li></ul>	<ul style="list-style-type: none"><li>• <a href="#">AV-194</a></li><li>• <a href="#">AV-141</a></li></ul>
Voice activated control does not operate	<ul style="list-style-type: none"><li>• Microphone</li><li>• Steering switch</li><li>• Bluetooth control unit</li></ul>	<ul style="list-style-type: none"><li>• <a href="#">AV-201</a></li><li>• <a href="#">AV-194</a></li><li>• <a href="#">AV-141</a></li></ul>

#### DVD PLAYER

# AUDIO SYSTEM

< SYMPTOM DIAGNOSIS >

[BOSE AUDIO WITHOUT NAVIGATION]

Symptom	Possible cause	Reference page
DVD player inoperative	<ul style="list-style-type: none"><li>• Power supply and ground circuits</li><li>• DVD player</li></ul>	<ul style="list-style-type: none"><li>• <a href="#">AV-161</a></li><li>• <a href="#">AV-269</a></li></ul>
No sound when playing a DVD	<ul style="list-style-type: none"><li>• Audio signal circuits</li><li>• AV control unit</li><li>• DVD player</li></ul>	<ul style="list-style-type: none"><li>• <a href="#">AV-173</a></li><li>• <a href="#">AV-154</a></li><li>• <a href="#">AV-161</a></li></ul>
Video monitor is inoperative/does not display properly	<ul style="list-style-type: none"><li>• Power supply and ground circuits</li><li>• Video out circuit</li><li>• DVD player</li><li>• Video monitor</li></ul>	<ul style="list-style-type: none"><li>• <a href="#">AV-162</a></li><li>• <a href="#">AV-252</a></li><li>• <a href="#">AV-161</a></li><li>• <a href="#">AV-270</a></li></ul>
DVD remote control is inoperative/does not operate properly	<ul style="list-style-type: none"><li>• DVD player</li><li>• Rear audio and remote control unit</li></ul>	<ul style="list-style-type: none"><li>• <a href="#">AV-161</a></li><li>• <a href="#">AV-268</a></li></ul>
Headphones inoperative	<ul style="list-style-type: none"><li>• Headphone batteries</li><li>• Headphone audio signal circuits from AV control unit</li><li>• AV control unit</li><li>• Rear audio remote control unit</li></ul>	<ul style="list-style-type: none"><li>• <a href="#">AV-63</a></li><li>• <a href="#">AV-104</a></li><li>• <a href="#">AV-268</a></li></ul>

A

B

C

D

E

F

G

H

I

J

K

L

M

AV

O

P

# NORMAL OPERATING CONDITION

< SYMPTOM DIAGNOSIS >

[BOSE AUDIO WITHOUT NAVIGATION]

## NORMAL OPERATING CONDITION

### Description

INFOID:000000001278773

The majority of the audio concerns are the result of outside causes (bad CD, electromagnetic interference, etc.).

### NOISE

The following noise results from variations in field strength, such as fading noise and multi-path noise, or external noise from trains and other sources. It is not a malfunction.

- Fading noise: This noise occurs because of variations in the field strength in a narrow range due to mountains or buildings blocking the signal.
- Multi-path noise: This noise results from the waves sent directly from the broadcast station arriving at the antenna at a different time from the waves which reflect off mountains or buildings.

The vehicle itself can be a source of noise if noise prevention parts or electrical equipment is malfunctioning. Check if noise is caused and/or changed by engine speed, ignition switch turned to each position, and operation of each piece of electrical equipment, and determine the cause.

### NOTE:

The source of the noise can be found easily by listening to the noise while removing the fuses of electrical components, one by one.

### Type of Noise and Possible Cause

Occurrence condition		Possible cause
Occurs only when engine is ON.	A continuous growling noise occurs. The speed of the noise varies with changes in the engine speed.	• Ignition components
The occurrence of the noise is linked with the operation of the fuel pump.		• Fuel pump condenser
Noise only occurs when various electrical components are operating.	A cracking or snapping sound occurs with the operation of various switches.	• Relay malfunction, AV control unit malfunction
	The noise occurs when various motors are operating.	• Motor case ground • Motor
The noise occurs constantly, not just under certain conditions.		• Rear defogger coil malfunction • Open circuit in printed heater • Poor ground of antenna feeder line
A cracking or snapping sound occurs while the vehicle is being driven, especially when it is vibrating excessively.		• Ground wire of body parts • Ground due to improper part installation • Wiring connections or a short circuit



# PRECAUTION

## PRECAUTIONS

### Supplemental Restraint System (SRS) "AIR BAG" and "SEAT BELT PRE-TENSIONER"

INFOID:000000001278774

The Supplemental Restraint System such as "AIR BAG" and "SEAT BELT PRE-TENSIONER", used along with a front seat belt, helps to reduce the risk or severity of injury to the driver and front passenger for certain types of collision. This system includes seat belt switch inputs and dual stage front air bag modules. The SRS system uses the seat belt switches to determine the front air bag deployment, and may only deploy one front air bag, depending on the severity of a collision and whether the front occupants are belted or unbelted. Information necessary to service the system safely is included in the SRS and SB section of this Service Manual.

**WARNING:**

- To avoid rendering the SRS inoperative, which could increase the risk of personal injury or death in the event of a collision which would result in air bag inflation, all maintenance must be performed by an authorized NISSAN/INFINITI dealer.
- Improper maintenance, including incorrect removal and installation of the SRS, can lead to personal injury caused by unintentional activation of the system. For removal of Spiral Cable and Air Bag Module, see the SRS section.
- Do not use electrical test equipment on any circuit related to the SRS unless instructed to in this Service Manual. SRS wiring harnesses can be identified by yellow and/or orange harnesses or harness connectors.

A  
B  
C  
D  
E  
F  
G  
H  
I  
J  
K  
L  
M  
O  
P

AV

# PREPARATION

< PREPARATION >

[BOSE AUDIO WITHOUT NAVIGATION]

## PREPARATION

### PREPARATION

#### Commercial Service Tools

INFOID:000000001278775

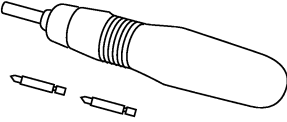
Tool name	Description
<p data-bbox="175 520 285 541">Power tool</p>  <p data-bbox="850 632 922 646">PBIC0191E</p>	<p data-bbox="1006 415 1256 436">Loosening bolts and nuts</p>

# ON-VEHICLE REPAIR

## AV CONTROL UNIT

### Removal and Installation

INFOID:000000001282593

For removal and installation, refer to [AV-104, "Removal and Installation"](#).

- A
- B
- C
- D
- E
- F
- G
- H
- I
- J
- K
- L
- M
- AV
- O
- P

**DISPLAY UNIT**

**Removal and Installation**

INFOID:000000001346464

For removal and installation, refer to [AV-106. "Removal and Installation"](#).

# FRONT TWEETER

< ON-VEHICLE REPAIR >

[BOSE AUDIO WITHOUT NAVIGATION]

## FRONT TWEETER

### Removal and Installation

INFOID:000000001282595

For removal and installation, refer to [AV-107. "Removal and Installation"](#).

A

B

C

D

E

F

G

H

I

J

K

L

M

AV

O

P

# CENTER SPEAKER

< ON-VEHICLE REPAIR >

[BOSE AUDIO WITHOUT NAVIGATION]

## CENTER SPEAKER

### Removal and Installation

INFOID:000000001282596

#### REMOVAL

**CAUTION:**

**Use a suitable tool to prevent damage to the center speaker grille and the instrument panel.**

1. Using a suitable tool, remove the center speaker grille finisher (1).
2. Disconnect the center speaker connector (A).
3. Remove the center speaker screws (B).
4. Remove the center speaker (2).

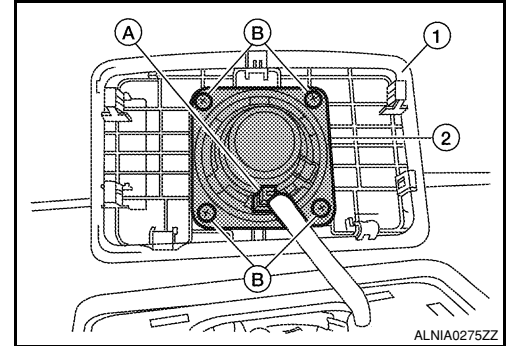

#### INSTALLATION

Installation is in the reverse order of removal.

# FRONT DOOR SPEAKER

< ON-VEHICLE REPAIR >

[BOSE AUDIO WITHOUT NAVIGATION]

## FRONT DOOR SPEAKER

### Removal and Installation

INFOID:000000001282597

For removal and installation, refer to [AV-108. "Removal and Installation"](#).

A

B

C

D

E

F

G

H

I

J

K

L

M

AV

O

P

## REAR DOOR SPEAKER

< ON-VEHICLE REPAIR >

[BOSE AUDIO WITHOUT NAVIGATION]

---

### REAR DOOR SPEAKER

#### Removal and Installation

INFOID:000000001282598

#### REAR DOOR SPEAKER

For removal and installation, refer to [AV-109, "Removal and Installation"](#).

#### REAR DOOR TWEETER

For removal and installation, refer to [AV-109, "Removal and Installation"](#).



# BACK DOOR SPEAKER

< ON-VEHICLE REPAIR >

[BOSE AUDIO WITHOUT NAVIGATION]

## BACK DOOR SPEAKER

### Removal and Installation

INFOID:000000001337871

#### REMOVAL

1. Remove the back door lower finisher. Refer to XXX.
2. Remove the back door speaker screws (A).
3. Pull out the back door speaker (1), disconnect the back door speaker connector and remove the back door speaker (1).

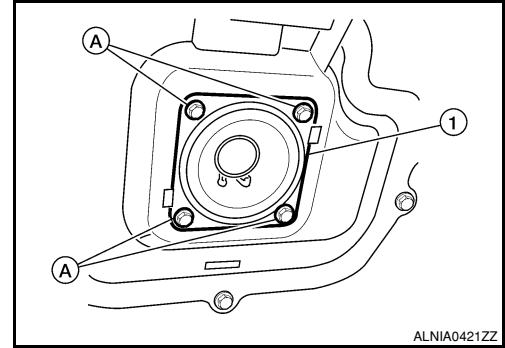

#### INSTALLATION

Installation is in the reverse order of removal.

A  
B  
C  
D  
E  
F  
G  
H  
I  
J  
K  
L  
M  
O  
P

AV

## WOOFER

### Removal and Installation

INFOID:000000001430761

### SUBWOOFER (BOSE SYSTEM)

#### Removal

1. Remove front seat LH. Refer to [SE-49. "Removal and Installation"](#).
2. Disconnect the subwoofer connector.
3. Remove the subwoofer bolts.
4. Remove the subwoofer.

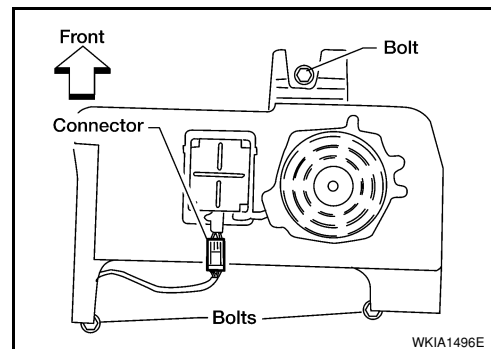

#### Installation

Installation is in the reverse order of removal.

# STEERING SWITCH

< ON-VEHICLE REPAIR >

[BOSE AUDIO WITHOUT NAVIGATION]

## STEERING SWITCH

### Removal and Installation

INFOID:000000001282603

For removal and installation of the steering wheel audio control switch, refer to [AV-110. "Removal and Installation"](#).

- A
- B
- C
- D
- E
- F
- G
- H
- I
- J
- K
- L
- M
- AV
- O
- P

## REAR AUDIO REMOTE CONTROL UNIT

< ON-VEHICLE REPAIR >

[BOSE AUDIO WITHOUT NAVIGATION]

---

### REAR AUDIO REMOTE CONTROL UNIT

#### Removal and Installation

INFOID:000000001308938

For removal and installation, refer to [AV-111. "Removal and Installation"](#)

# DVD PLAYER

< ON-VEHICLE REPAIR >

[BOSE AUDIO WITHOUT NAVIGATION]

## DVD PLAYER

### Removal and Installation

INFOID:000000001346470

For removal and installation, refer to [AV-112, "Removal and Installation"](#).

A

B

C

D

E

F

G

H

I

J

K

L

M

AV

O

P

## DVD ENTERTAINMENT SYSTEM

< ON-VEHICLE REPAIR >

[BOSE AUDIO WITHOUT NAVIGATION]

---

## DVD ENTERTAINMENT SYSTEM

### Removal and Installation

INFOID:000000001346507

For removal and installation, refer to [AV-113, "Removal and Installation"](#).

# BOSE AMP.

< ON-VEHICLE REPAIR >

[BOSE AUDIO WITHOUT NAVIGATION]

## BOSE AMP.

### Removal and Installation

INFOID:000000001282594

#### REMOVAL

1. Remove the BCM. Refer to [BCS-54, "Removal and Installation"](#).
2. Remove the accelerator pedal. Refer to [AP-19, "Removal and Installation"](#).
3. Disconnect the BOSE speaker amp. connectors.
4. Remove the BOSE speaker amp. and bracket assembly screws and slide the BOSE speaker amp. bracket assembly down.

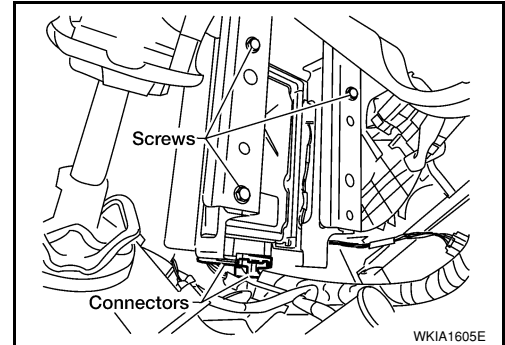

5. Remove the BOSE speaker amp.screws (A). then remove the BOSE speaker amp. (1).

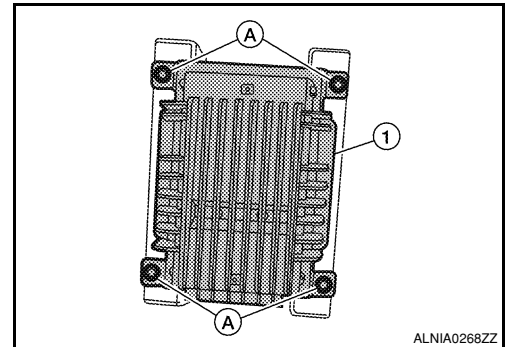

#### INSTALLATION

Installation is in the reverse order of removal.

A  
B  
C  
D  
E  
F  
G  
H  
I  
J  
K  
L  
M  
O  
P

AV

## AUDIO ANTENNA

< ON-VEHICLE REPAIR >

[BOSE AUDIO WITHOUT NAVIGATION]

---

### AUDIO ANTENNA

#### Location of Antenna

INFOID:000000001282601

For location of antenna, refer to [AV-114. "Location of Antennas"](#).

#### Window Antenna Repair

INFOID:000000001282602

For window antenna repair, refer to [AV-114. "Window Antenna Repair"](#).



**SATELLITE RADIO ANTENNA**

< ON-VEHICLE REPAIR >

**[BOSE AUDIO WITHOUT NAVIGATION]**

**SATELLITE RADIO ANTENNA**

**Removal and Installation**

INFOID:000000001303729

For removal and installation, refer to [AV-116, "Removal and Installation"](#).

- A
- B
- C
- D
- E
- F
- G
- H
- I
- J
- K
- L
- M
- AV
- O
- P

## SATELLITE RADIO TUNER

< ON-VEHICLE REPAIR >

[BOSE AUDIO WITHOUT NAVIGATION]

---

### SATELLITE RADIO TUNER

#### Removal and Installation

INFOID:000000001303730

For removal and installation, refer to [AV-117. "Removal and Installation"](#).

# MICROPHONE

< ON-VEHICLE REPAIR >

[BOSE AUDIO WITHOUT NAVIGATION]

## MICROPHONE

### Removal and Installation

INFOID:000000001430755

#### REMOVAL

1. Remove the front roof console finisher. Refer to XXXX.
2. Disconnect the Bluetooth microphone connector (A).
3. Detach the Bluetooth microphone (1) from the front roof console finisher and remove the Bluetooth microphone (1).

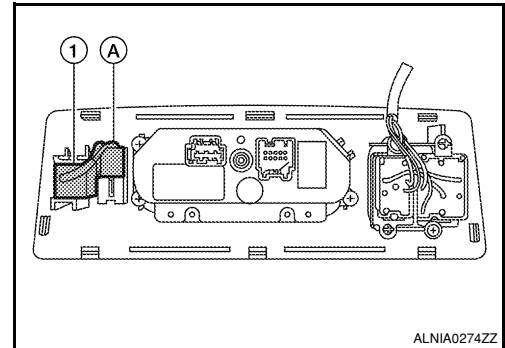

#### INSTALLATION

Installation is in the reverse order of removal.

A  
B  
C  
D  
E  
F  
G  
H  
I  
J  
K  
L  
M  
AV  
O  
P

## TEL ANTENNA

### Removal and Installation

INFOID:000000001430756

#### REMOVAL

1. Disconnect the battery negative terminal.
2. Slide the front passenger seat fully forward.
3. Remove the Bluetooth control unit kick shield screws and remove the Bluetooth control unit kick shield.
4. Remove the Bluetooth antenna screws (A), disconnect the Bluetooth antenna connector (B) and remove the Bluetooth antenna (1).
  - Bluetooth control unit screws (C)
  - Bluetooth control unit (2)
  - ←:Front of vehicle

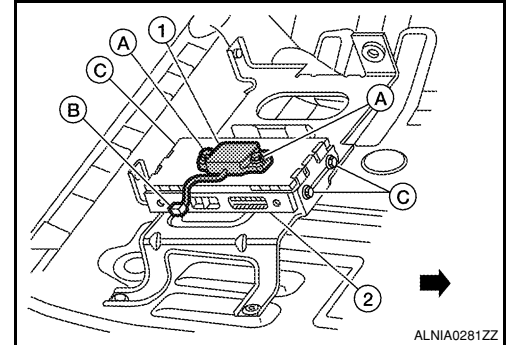

#### INSTALLATION

Installation is in the reverse order of removal.

# BLUETOOTH CONTROL UNIT

< ON-VEHICLE REPAIR >

[BOSE AUDIO WITHOUT NAVIGATION]

## BLUETOOTH CONTROL UNIT

### Removal and Installation

INFOID:000000001430757

#### REMOVAL

1. Disconnect the negative battery terminal.
2. Slide the front passenger seat fully forward.
3. Remove the Bluetooth control unit kick shield screws and remove the Bluetooth control unit kick shield.
4. Remove the Bluetooth control unit screws (C), disconnect the Bluetooth control unit connectors and remove the Bluetooth control unit (2).
  - Bluetooth antenna (1)
  - Bluetooth antenna screws (A)
  - Bluetooth antenna connector (B)
  - ←:Front of vehicle

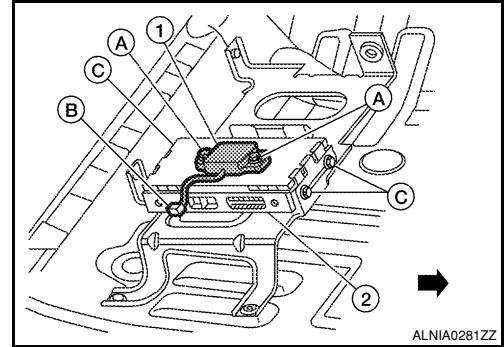

#### INSTALLATION

Installation is in the reverse order of removal.

A  
B  
C  
D  
E  
F  
G  
H  
I  
J  
K  
L  
M

AV

O  
P

# REAR VIEW CAMERA

[BOSE AUDIO WITHOUT NAVIGATION]

< ON-VEHICLE REPAIR >

## REAR VIEW CAMERA

### Removal and Installation

INFOID:000000001430758

#### REMOVAL

1. Remove the back door lower finisher. Refer to [INT-20. "Removal and Installation"](#).
2. Disconnect the rear view camera connector (A).
3. Remove the back door handle. Refer to [DLK-346. "Door Lock Assembly"](#).

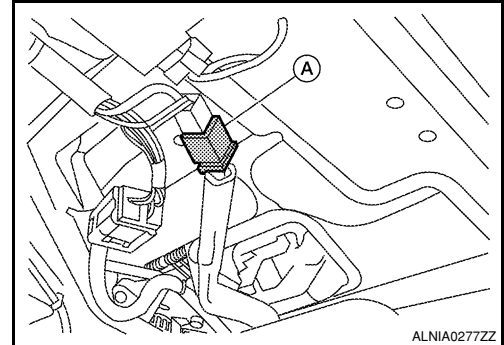

4. Remove the rear view camera screw (2), then remove the rear view camera (1).

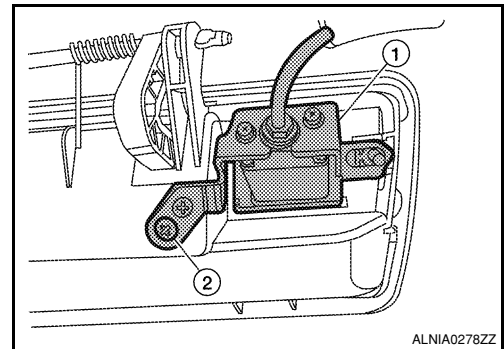

#### INSTALLATION

Installation is in the reverse order of removal.

#### Adjustment

INFOID:000000001430759

For adjustment on the rear view camera, refer to [AV-120. "REAR VIEW MONITOR GUIDING LINE ADJUSTMENT : Special Repair Requirement"](#).

# REAR VIEW CAMERA CONTROL UNIT

< ON-VEHICLE REPAIR >

[BOSE AUDIO WITHOUT NAVIGATION]

## REAR VIEW CAMERA CONTROL UNIT

### Removal and Installation

INFOID:000000001430760

#### REMOVAL

1. Remove the luggage side finisher lower LH. Refer to [INT-18. "Removal and Installation"](#).
2. Disconnect the rear view camera control unit connector (A), then remove the rear view camera control unit screws (B), and remove the rear view camera control unit (1).

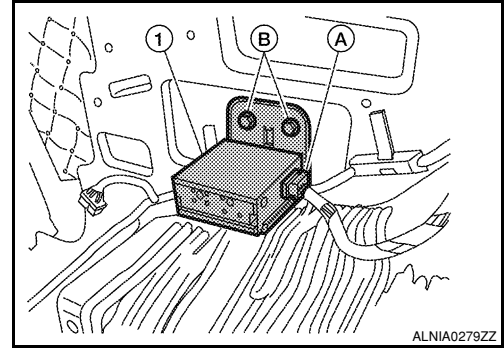

#### INSTALLATION

Installation is in the reverse order of removal.

A  
B  
C  
D  
E  
F  
G  
H  
I  
J  
K  
L  
M  
O  
P

AV

## BASIC INSPECTION

### DIAGNOSIS AND REPAIR WORKFLOW

#### Work Flow

INFOID:000000001278789

#### OVERALL SEQUENCE

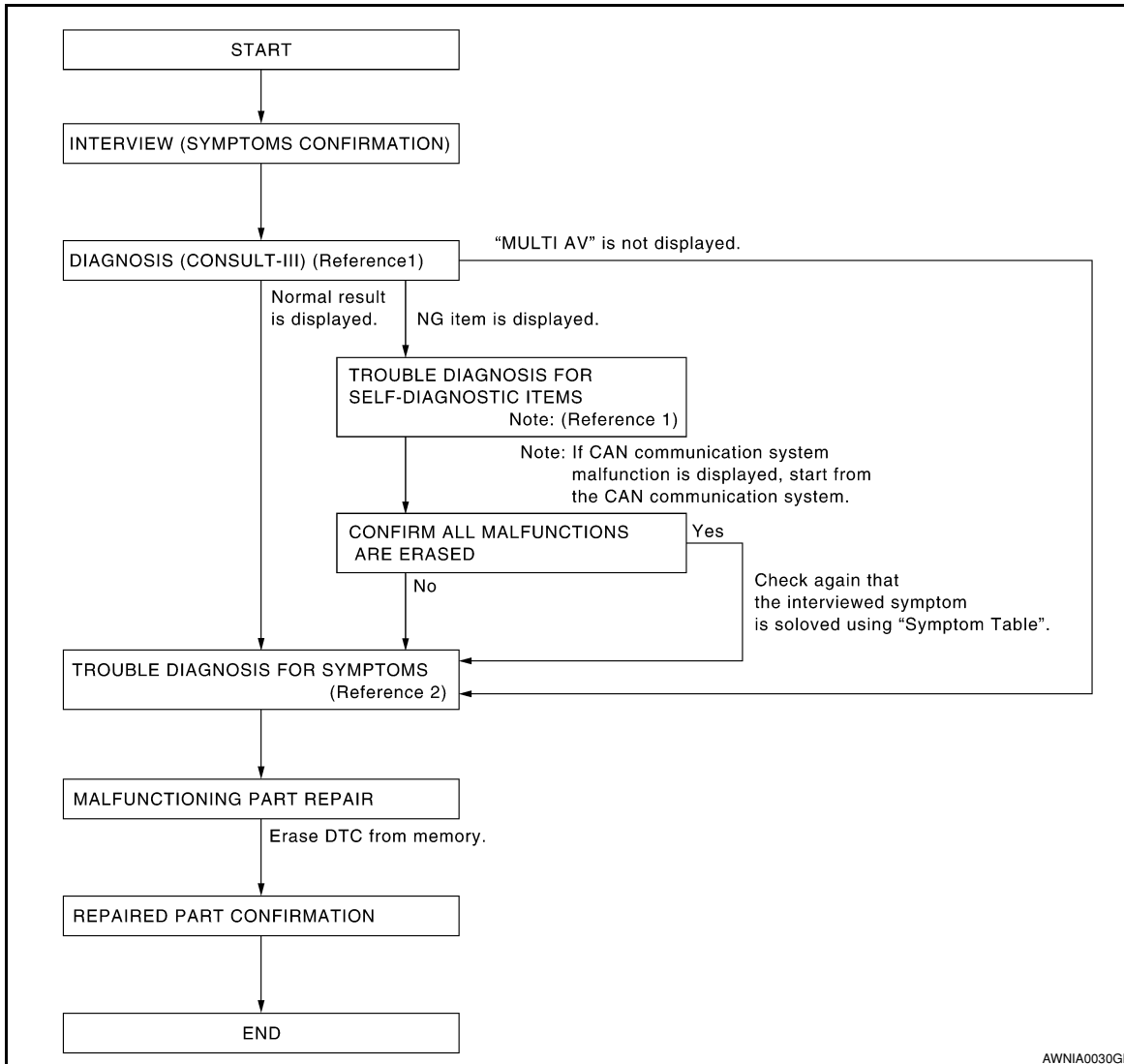

- Reference 1... Refer to [AV-308. "AV CONTROL UNIT : CONSULT-III Function"](#).
- Reference 2... Refer to [AV-426. "Symptom Table"](#).

#### DETAILED FLOW

##### 1. CHECK SYMPTOM

Check the malfunction symptoms by performing the following items.

- Interview the customer to obtain the malfunction information (conditions and environment when the malfunction occurred).
- Check the symptom.

>> GO TO 2

##### 2. SELF-DIAGNOSIS (CONSULT-III)

1. Connect CONSULT-III and perform "SELF-DIAGNOSIS" for "MULTI AV".  
**NOTE:**  
Skip to step 4 of the diagnosis procedure if "MULTI AV" is not displayed.
2. Check if any DTC No. is displayed in the self-diagnosis results.



# DIAGNOSIS AND REPAIR WORKFLOW

[BOSE AUDIO WITH NAVIGATION]

< BASIC INSPECTION >

Is any DTC No. displayed?

- YES >> GO TO 3
- NO >> GO TO 4

## 3.CHECK SELF-DIAGNOSIS RESULTS (CONSULT-III)

1. Check the DTC No. indicated in the self-diagnosis results.
2. Perform the relevant diagnosis referring to the DTC No. list. Refer to [AV-414, "DTC Index"](#).

### NOTE:

Start with the diagnosis for the CAN communication system if "CAN COMM CIRCUIT [U1000] or CONTROL UNIT (CAN) [U1010]" is displayed.

>> GO TO 5

## 4.PERFORM DIAGNOSIS BY SYMPTOM

Perform the relevant diagnosis referring to the diagnosis chart by symptom. Refer to [AV-426, "Symptom Table"](#).

>> GO TO 5

## 5.REPAIR OR REPLACE MALFUNCTIONING PARTS

Repair or replace the identified malfunctioning parts.

### NOTE:

Erase the stored self-diagnosis results after repairing or replacing the relevant components if any DTC No. has been indicated in the self-diagnosis results.

>> GO TO 6

## 6.CHECK AFTER REPAIR

1. Perform self-diagnosis for "MULTI AV" with CONSULT-III after repairing or replacing the malfunctioning parts.
2. Check if any DTC No. is displayed in the self-diagnosis results.

Is any DTC No. displayed?

- YES >> GO TO 3
- NO >> GO TO 7

## 7.FINAL CHECK

Perform the operation check to confirm that the malfunction symptom is solved or that any other symptoms are present.

Are any symptoms present?

- YES >> GO TO 4
- NO >> Inspection End.

A  
B  
C  
D  
E  
F  
G  
H  
I  
J  
K  
L  
M  
O  
P

AV

## INSPECTION AND ADJUSTMENT

### REAR VIEW MONITOR GUIDING LINE ADJUSTMENT

#### REAR VIEW MONITOR GUIDING LINE ADJUSTMENT : Description

INFOID:000000001677656

This mode is used to modify the side distance guidelines if they are dislocated from the rear view monitor image, because of variations of body/camera mounting conditions.

#### REAR VIEW MONITOR GUIDING LINE ADJUSTMENT : Special Repair Requirement

INFOID:000000001677657

1. Create a correction line to modify the screen.  
 Draw lines on the rearward of the vehicle passing through the following points: 200 mm (7.87 inch) from both sides of the vehicle, and
  - \*1: 0.5 m (1.5 feet)
  - \*2: 1 m (3 feet)
  - \*3: 2 m (7 feet)
  - \*4: 3 m (10 feet)
 and from the rear end of the bumper
2. With the ignition switch OFF, connect CONSULT-III, then turn ignition switch ON. Select "REARVIEW CAMERA".

**CAUTION:**

**Stop engine for safety when correcting side distance guideline.**

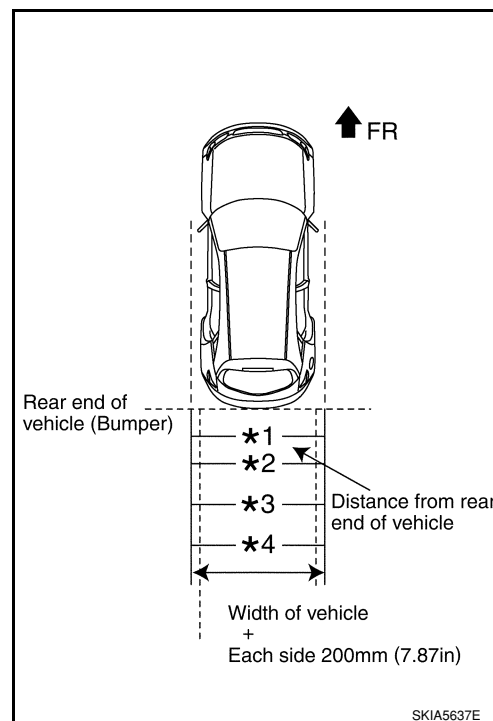

3. Shift the A/T selector lever to R position.

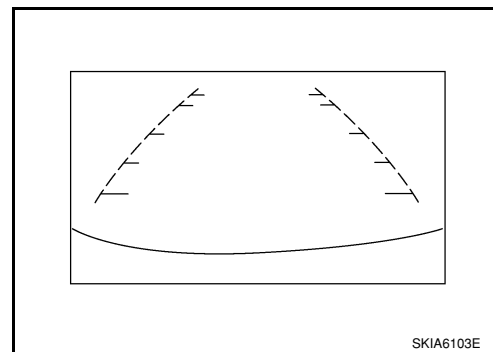

4. Touch "SELCT GUIDELINE PATTERN" under "WORK SUPPORT" menu.
5. Touch "UP" or "DOWN", and select the guide line, "PATTERN NO. 0" or "PATTERN NO. 1", which is the closest to the corrected line.
6. Touch "SAVE", and confirm the guide line.
7. Touch "END".
8. Touch "ADJ GUIDELINE POSITION" under the "WORK SUPPORT" menu.
9. Adjust the guide line touching "X UP", "X DOWN", "Y UP" or "Y DOWN" so that the corrected line can fit the guide line.
10. Touch "SAVE", and confirm the guide line.

# INSPECTION AND ADJUSTMENT

< BASIC INSPECTION >

[BOSE AUDIO WITH NAVIGATION]

---

11. Touch "END" to finish correcting.

A

B

C

D

E

F

G

H

I

J

K

L

M

**AV**

O

P

FUNCTION DIAGNOSIS

AUDIO SYSTEM

System Diagram

INFOID:000000001317782

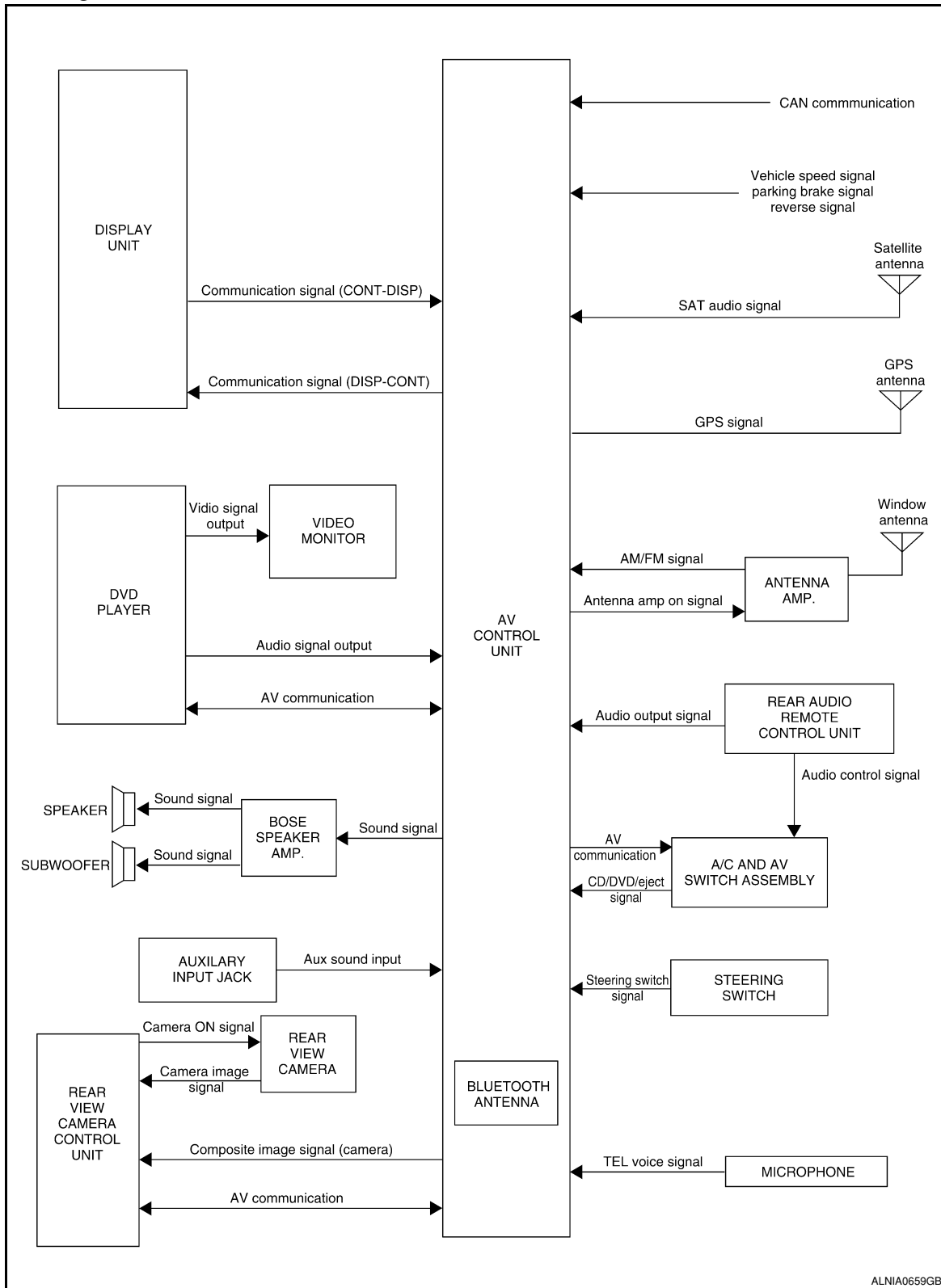

ALNIA0659GB

System Description

INFOID:000000001317783

AUDIO SYSTEM

# AUDIO SYSTEM

[BOSE AUDIO WITH NAVIGATION]

## < FUNCTION DIAGNOSIS >

The audio system consists of the following components

- AV control unit
- Display unit
- BOSE speaker amp.
- Window antenna
- Steering wheel audio control switches
- A/C and AV switch assembly
- Rear audio and remote control unit
- Front door speakers
- Front tweeters
- Center speaker
- Rear door speakers
- Rear door tweeters
- Back door speakers
- Subwoofer

When the audio system is on, radio signals are received by the window antenna. The AV control unit then sends audio signals to the BOSE speaker amp. The BOSE speaker amp. amplifies the audio signals before sending them to the front door speakers, front tweeters, center speaker, rear door speakers, rear door tweeters, back door speakers and the subwoofer.

Refer to Owner's Manual for audio system operating instructions.

### SATELLITE RADIO SYSTEM

The satellite radio system consists of the following components

- Satellite antenna
- AV control unit

When the satellite radio system is on, radio signals are supplied to the AV control unit from the satellite antenna. The AV control unit then sends audio signals to the BOSE speaker amp.

Refer to Owner's Manual for satellite radio system operating instructions.

### SPEED SENSITIVE VOLUME SYSTEM

Volume level of this system goes up and down automatically in proportion to the vehicle speed. The control level can be selected by the customer. Refer to Owner's Manual for operating instructions.

A

B

C

D

E

F

G

H

I

J

K

L

M

AV

O

P

# AUDIO SYSTEM

< FUNCTION DIAGNOSIS >

[BOSE AUDIO WITH NAVIGATION]

## Component Parts Location

INFOID:000000001317784

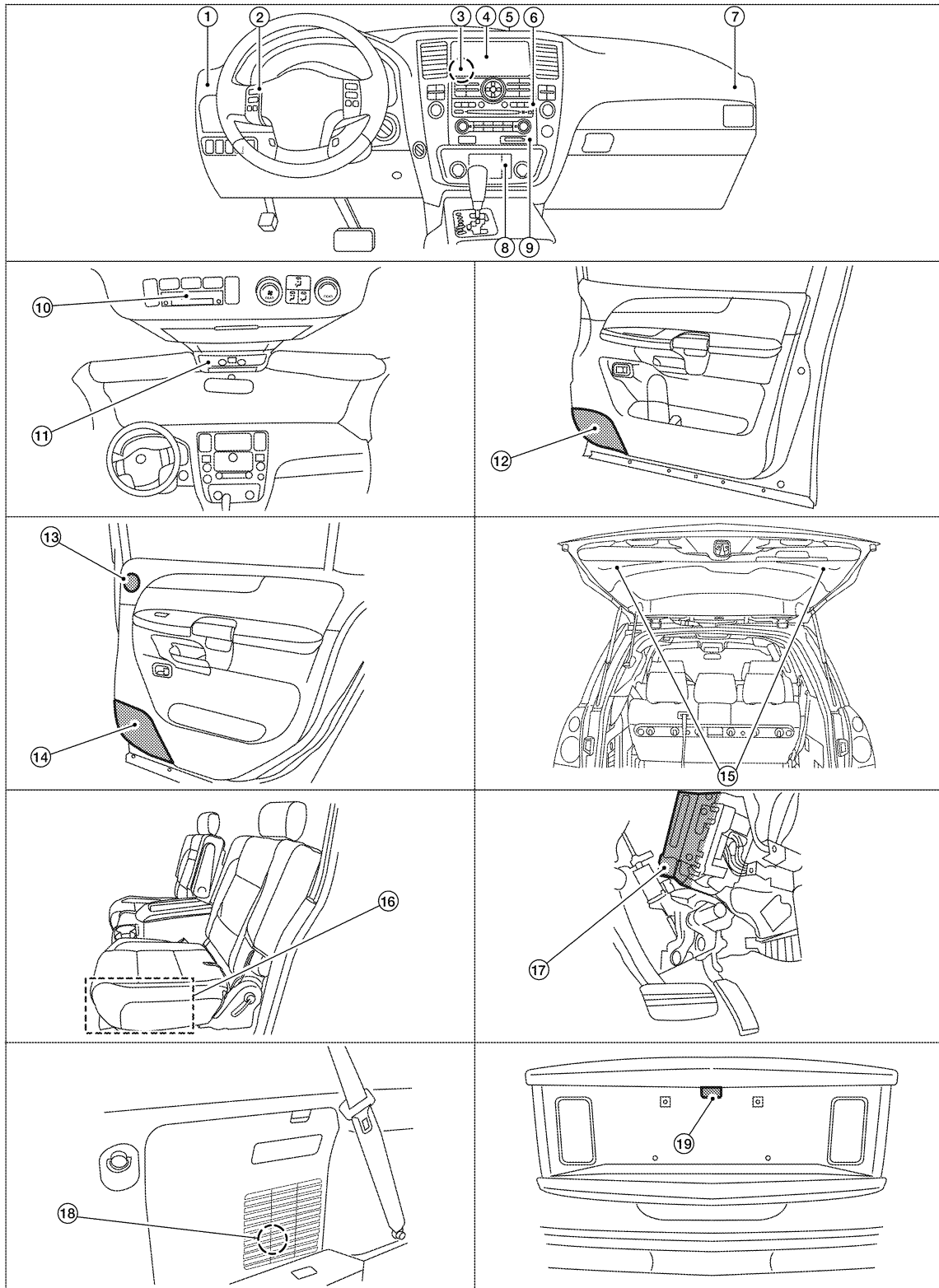

AWNIA0097GB

- |                          |  |   |
|--------------------------|--|---|
| 1. Front tweeter LH M109 | 2. Steering wheel audio control switches | 3. AV control unit M42, M43, M44, M45, M46, M97, M124, M125 |
| 4. Display unit M93      | 5. Center speaker M110                   | 6. A/C and AV switch assembly M98                           |
| 7. Front tweeter RH M111 | 8. Aux jack M104                         | 9. Compact Flash insert slot                                |

# AUDIO SYSTEM

## < FUNCTION DIAGNOSIS >

## [BOSE AUDIO WITH NAVIGATION]

- |   |   |  |   |
|---|---|--|---|
| 10. Rear audio and remote control unit R204 | 11. Microphone R109   | 12. Front door speaker<br>LH D12<br>RH D112                            | A |
| 13. Rear door tweeter<br>LH D208<br>RH D308 | 14. Rear door speaker<br>LH D207<br>RH D307   | 15. Back door speaker<br>LH D518<br>RH D716                            | B |
| 16. Subwoofer B72 (under driver's seat)     | 17. BOSE speaker amp M112, M113<br>(view behind instrument panel above accelerator pedal) | 18. Rear camera control unit B73 (located behind luggage finisher LHI) | C |
| 19. Rear view camera D504                   |   |  |   |

## Component Description

INFOID:000000001317785

Part name	Description	
AV control unit	Controls audio system, NAVI functions and satellite radio system functions	E
Display unit	<ul style="list-style-type: none"> <li>• Touch screen controls all audio and A/C operations</li> <li>• Displays all audio and climate control related information</li> </ul>	F
BOSE speaker amp.	Receives power (amp ON) and audio signals from AV control unit and outputs audio signals to each speaker.	
Steering switches	<ul style="list-style-type: none"> <li>• Audio operation can be operated</li> <li>• Steering switch signal is output to AV control unit</li> </ul>	G
Front door speakers	<ul style="list-style-type: none"> <li>• Outputs audio signal from BOSE speaker amp.</li> <li>• Outputs high, mid and low range sounds</li> </ul>	H
Front tweeters	<ul style="list-style-type: none"> <li>• Outputs audio signal from BOSE speaker amp.</li> <li>• Outputs high range sounds</li> </ul>	I
Center speaker	<ul style="list-style-type: none"> <li>• Outputs audio signal from BOSE speaker amp.</li> <li>• Outputs high range sounds</li> </ul>	J
Rear door speakers	<ul style="list-style-type: none"> <li>• Outputs audio signal from BOSE speaker amp.</li> <li>• Outputs high, mid and low range sounds</li> </ul>	K
Rear door tweeters	<ul style="list-style-type: none"> <li>• Outputs audio signal from BOSE speaker amp.</li> <li>• Outputs high range sounds</li> </ul>	L
Back door speakers	<ul style="list-style-type: none"> <li>• Outputs audio signal from BOSE speaker amp.</li> <li>• Outputs high, mid and low range sounds</li> </ul>	M
Subwoofer	<ul style="list-style-type: none"> <li>• Outputs audio signal from BOSE speaker amp.</li> <li>• Outputs low range sounds</li> </ul>	N
Satellite antenna	Audio signal (satellite radio) is received and output to AV control unit.	O

AV

O

P

## NAVIGATION SYSTEM

### System Diagram

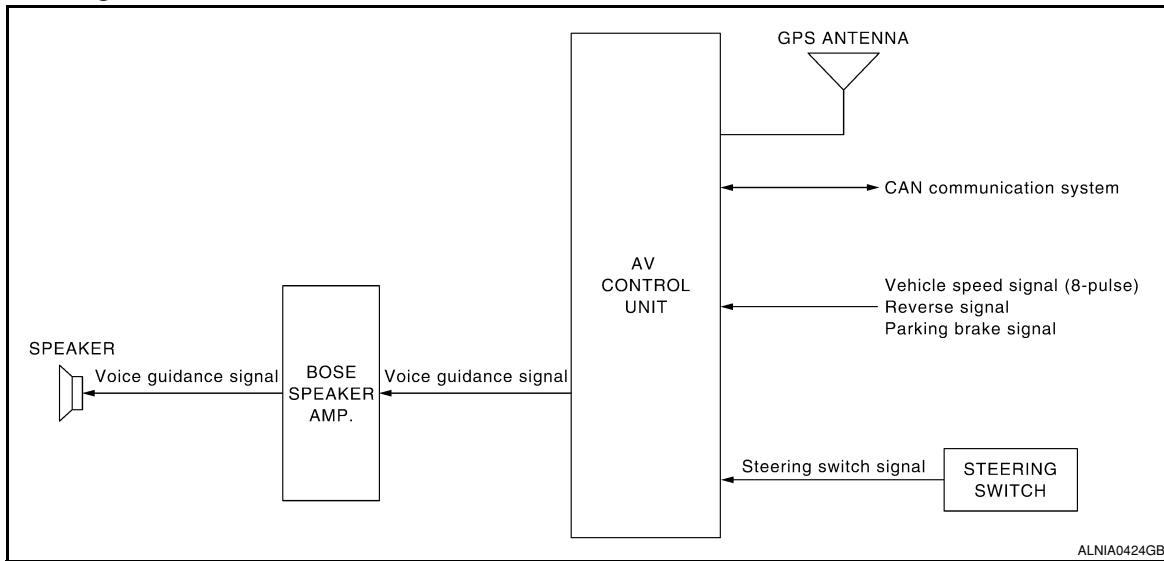

### System Description

INFOID:000000001346454

**NOTE:**

Refer to NAVI System Owner's Manual for system operation.

The navigation system periodically calculates the vehicle's current position according to the following three signals: Travel distance of the vehicle as determined by the vehicle speed sensor, turning angle of the vehicle as determined by the gyroscope (angular velocity sensor), and the direction of vehicle travel as determined by the GPS antenna (GPS information).

The current position of the vehicle is then identified by comparing the calculated vehicle position with map data read from the map data, which is stored in the hard disk drive (HDD)(map-matching), and indicated on the screen with a current-location mark.

By comparing the vehicle position detection results found by the GPS and by map-matching, more accurate vehicle position data can be used.

The current vehicle position will be calculated by detecting the distance the vehicle moved from the previous calculation point and its direction.

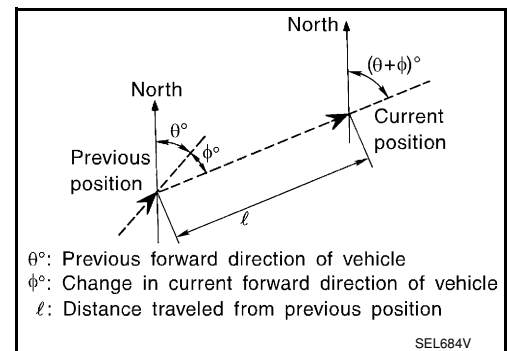

#### TRAVEL DISTANCE

Travel distance calculations are based on the vehicle speed input signal. Therefore, the calculation may become incorrect as the tires wear down. To prevent this, an automatic distance fine adjustment function has been adopted.

#### TRAVEL DIRECTION

Change in the travel direction of the vehicle is calculated by a gyroscope (angular velocity sensor) and a GPS antenna (GPS information). As the gyroscope and GPS antenna have both merit and demerit, input signals from them are prioritized in each situation. However, this order of priority may change in accordance with more detailed travel conditions so that the travel direction is detected more accurately.



Type	Advantage	Disadvantage
Gyroscope (angular velocity sensor)	<ul style="list-style-type: none"> <li>Can detect the vehicle's turning angle quite accurately.</li> </ul>	<ul style="list-style-type: none"> <li>Direction errors may accumulate when the vehicle is driven for long distances without stopping.</li> </ul>
GPS antenna (GPS information)	<ul style="list-style-type: none"> <li>Can detect the vehicle's travel direction (North/South/East/West).</li> </ul>	<ul style="list-style-type: none"> <li>Correct direction cannot be detected when the vehicle speed is low.</li> </ul>

## MAP-MATCHING

Map-matching is a function that repositions the vehicle on the road map when a new location is judged to be the most accurate. This is done by comparing the current vehicle position, calculated by the method described in the position detection principle, with the road map data around the vehicle, read from the map data stored on the HDD.

Therefore, the vehicle position may not be corrected after the vehicle is driven over a certain distance or time in which GPS information is hard to receive. In this case, the current-location mark on the display must be corrected manually.

### CAUTION:

**The road map data is based on data stored on the HDD.**

- In map-matching, alternative routes to reach the destination will be shown and prioritized, after the road on which the vehicle is currently driven has been judged and the current-location mark has been repositioned.

If there is an error in distance and/or direction, the alternative routes will be shown in different order of priority, and the wrong road can be avoided.

If two roads are running in parallel, they are of the same priority. Therefore, the current-location mark may appear on either of them alternately, depending on maneuvering of the steering wheel and configuration of the road.

- Map-matching does not function correctly when the road on which the vehicle is driving is new and not recorded on the HDD, or when the road pattern stored in the map data and the actual road pattern are different due to repair.

When driving on a road not present in the map, the map-matching function may find another road and position the current-location mark on it. Then, when the correct road is detected, the current-location mark may leap to it.

- Effective range for comparing the vehicle position and travel direction calculated by the distance and direction with the road data read from the HDD is limited. Therefore, when there is an excessive gap between the current vehicle position and the position on the map, correction by map-matching is not possible.

## GPS (GLOBAL POSITIONING SYSTEM)

GPS (Global Positioning System) has been developed and controlled by the US Department of Defense. The system utilizes GPS satellite (NAVSTAR), sending out radio waves while flying on an orbit around the earth at the height of approx. 21,000 km (13,000 miles). The GPS receiver calculates the vehicle's position in three dimensions (latitude/longitude/altitude) according to the time lag of the radio waves received from four or more GPS satellites (three-dimensional positioning). If radio waves were received only from three GPS satellites, the GPS receiver calculates the vehicle's position in two dimensions (latitude/longitude), utilizing the altitude data calculated previously by using radio waves from four or more GPS satellites (two-dimensional positioning).

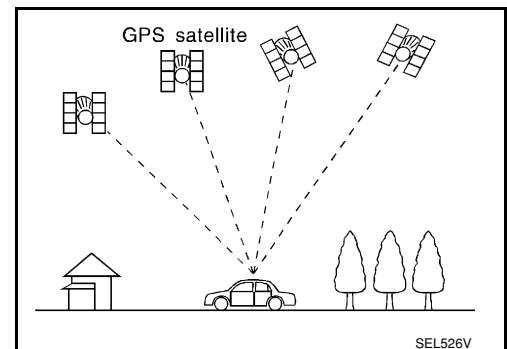
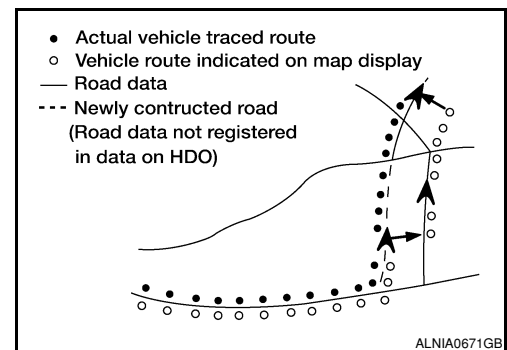
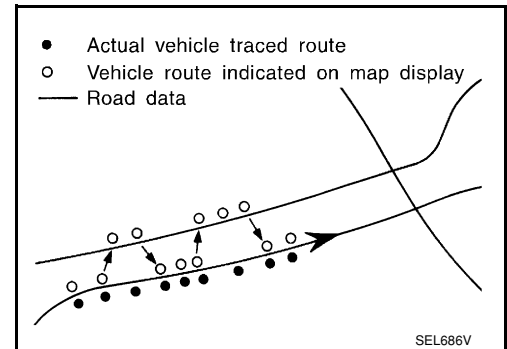
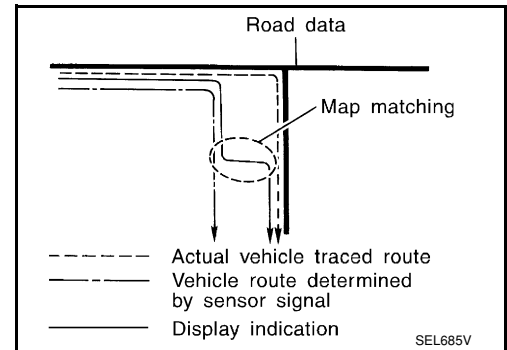

A  
B  
C  
D  
E  
F  
G  
H  
I  
J  
K  
L  
M  
O  
P

AV

# NAVIGATION SYSTEM

< FUNCTION DIAGNOSIS >

[BOSE AUDIO WITH NAVIGATION]

Accuracy of the GPS will deteriorate under the following conditions.

- In two-dimensional positioning, the GPS accuracy will deteriorate when the altitude of the vehicle position changes.
- There may be an error of approximately 10 m (30 ft.) in position detected by three-dimensional positioning, which is more accurate than two-dimensional positioning. The accuracy can be even lower depending on the arrangement of the GPS satellites utilized for the positioning.
- Position detection is not possible when the vehicle is in an area where radio waves from the GPS satellite do not reach, such as in a tunnel, parking lot in a building, and under an elevated highway. Radio waves from the GPS satellites may not be received when some object is located over the GPS antenna.
- Position correction by GPS is not available while the vehicle is stopped.

## Component Parts Location

INFOID:000000001346455

Refer to [AV-286. "Component Parts Location"](#).

## Component Description

INFOID:000000001346456

Part name	Description
AV control unit	<ul style="list-style-type: none"><li>• Controls each operation of the navigation system</li><li>• HDD is built in</li><li>• Voice guidance signal is output to BOSE speaker amp.</li></ul>
BOSE speaker amp.	Voice guidance signal is input from AV control unit, and it is output to speakers.
Tweeter	Voice guidance signal from BOSE speaker amp. is output.
Steering switches	<ul style="list-style-type: none"><li>• Each operation of navigation system can be performed</li><li>• Switch operating signal is output to AV control unit</li></ul>
Microphone	Sends voice signals to AV control unit
GPS antenna	GPS signal is received and is output to AV control unit.

# REAR VIEW MONITOR SYSTEM

< FUNCTION DIAGNOSIS >

[BOSE AUDIO WITH NAVIGATION]

## REAR VIEW MONITOR SYSTEM

### System Diagram

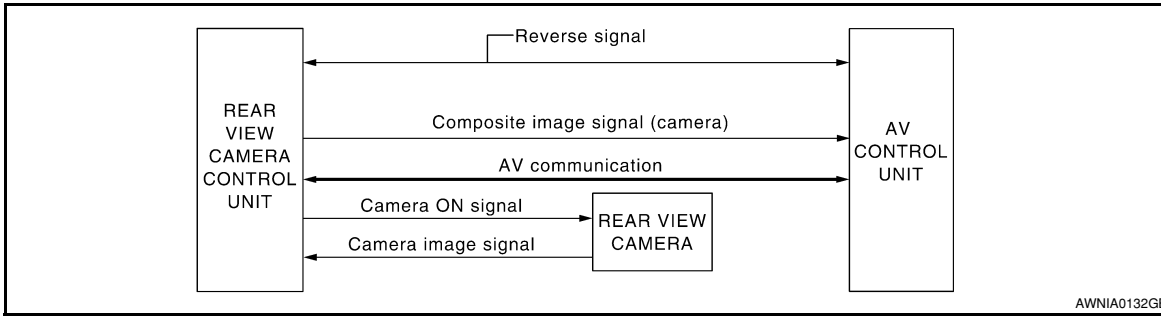

### System Description

INFOID:000000001346472

When the selector is in the R position, the display shows a view to the rear of the vehicle. Lines which indicate the vehicle clearance and distances are also displayed.

#### AV COMMUNICATION LINE

The rear view camera control unit is connected to the audio control unit using an AV communication line. This line is used to transmit and receive data.

### Component Parts Location

INFOID:000000001346473

Refer to [AV-286, "Component Parts Location"](#).

### Component Description

INFOID:000000001346474

Part name	Description
AV control unit	Camera image signal is sent from rear view camera control unit
Rear view camera control unit	<ul style="list-style-type: none"> <li>• Receives reverse signal from back-up lamp relay</li> <li>• Receives rear view camera image signal</li> <li>• Sends camera ON signal to rear view camera</li> <li>• Sends image signal to AV control unit</li> </ul>
Rear view camera	<ul style="list-style-type: none"> <li>• Receives camera ON signal from rear view camera control unit</li> <li>• Sends image signal to rear view camera control unit</li> </ul>

A  
B  
C  
D  
E  
F  
G  
H  
I  
J  
K  
L  
M  
O  
P

AV

## DVD PLAYER

### System Diagram

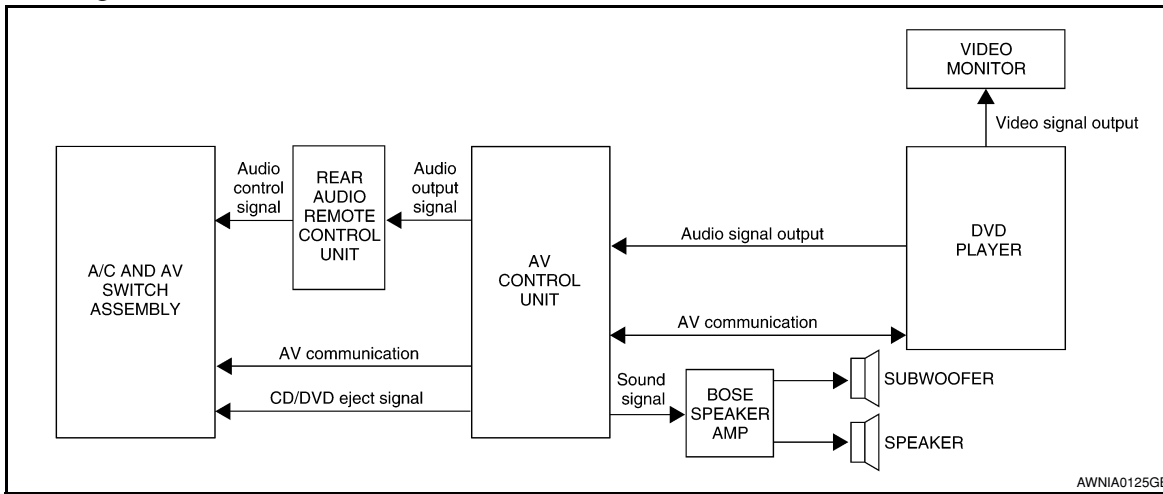

### System Description

INFOID:000000001317787

The DVD entertainment system consists of the following components

- AV control unit
- DVD player
- Video monitor
- A/C and AV switch assembly
- Steering wheel AV control switches
- Rear audio remote control unit
- BOSE speaker amp.
- Front tweeters
- Front door speakers
- Center speaker
- Rear door tweeters
- Rear door speakers
- Back door speakers
- Subwoofer

When the DVD entertainment system is on, video signals are sent from the DVD player to the video monitor. Audio signals are sent to the AV control unit. Audio signals can be directed through wireless infrared headphones or through the BOSE speaker amp. to the vehicle speakers. Refer to the Owner's Manual for complete DVD entertainment system operating instructions.

# DVD PLAYER

< FUNCTION DIAGNOSIS >

[BOSE AUDIO WITH NAVIGATION]

## Component Parts Location

INFOID:000000001317788

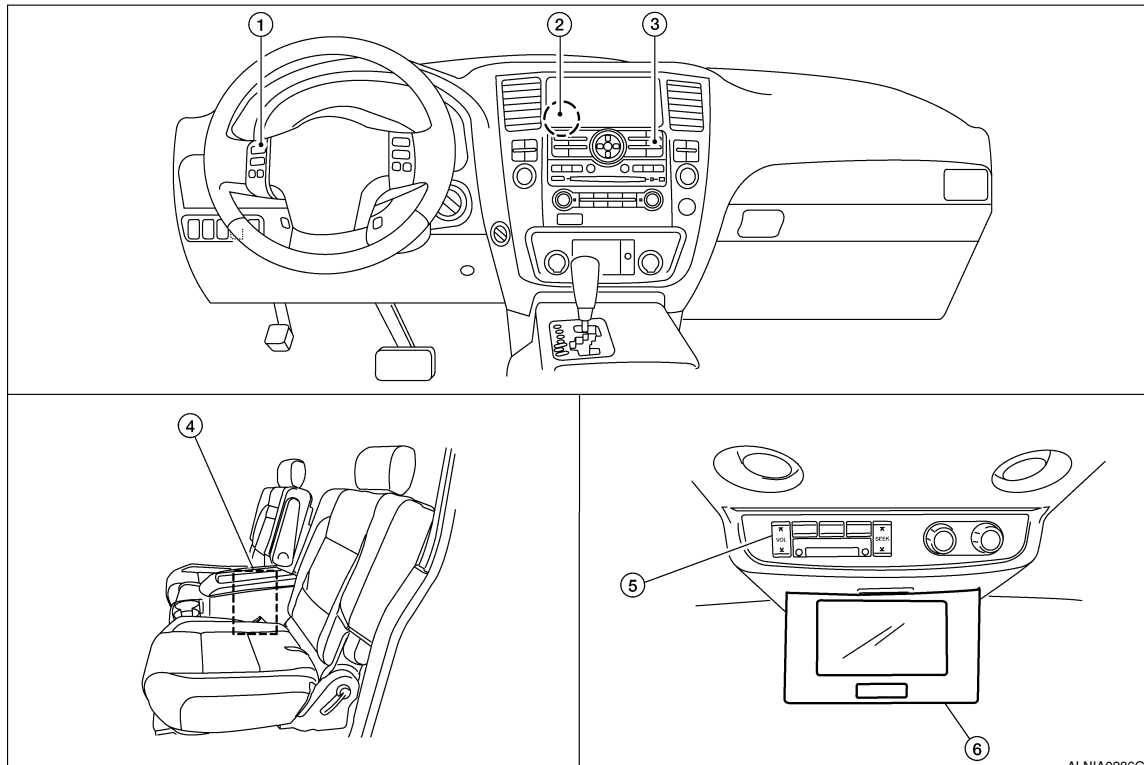

- |  |  |                                   |
|--|--|-----------------------------------|
| 1. Steering wheel audio control switches       | 2. AV control unit M42, M43, M44, M45, M97, M124, M125 | 3. A/C and AV switch assembly M98 |
| 4. DVD player M205 (located in center console) | 5. Rear audio remote control unit R204                 | 6. Video monitor R202             |

## Component Description

INFOID:000000001317789

Part name	Description
DVD player	<ul style="list-style-type: none"> <li>Outputs DVD video to video monitor</li> <li>Outputs DVD audio to the AV control unit</li> </ul>
Video monitor	<ul style="list-style-type: none"> <li>Receives and displays the DVD video signal</li> </ul>
AV control unit	<ul style="list-style-type: none"> <li>Controls audio system and DVD entertainment system functions</li> </ul>
BOSE speaker amp.	<ul style="list-style-type: none"> <li>Receives audio signals from the AV control unit</li> <li>Outputs amplified audio signals to the speakers</li> </ul>
A/C and AV switch assembly	<ul style="list-style-type: none"> <li>All audio and A/C operations can be operated</li> <li>Switch signal is output to the AV control unit and A/C auto amp</li> </ul>
Rear audio remote control unit	<ul style="list-style-type: none"> <li>Audio and DVD functions can be operated</li> <li>Switch signal is output to the AV control unit</li> <li>Receives audio signal from AV control unit for headphones</li> </ul>
Steering wheel audio control switches	<ul style="list-style-type: none"> <li>Audio operation can be operated</li> <li>Steering switch signal (operation signal) is output to AV control unit</li> </ul>
Front door speakers	<ul style="list-style-type: none"> <li>Outputs audio signal from BOSE speaker amp.</li> <li>Outputs high, mid and low range sounds</li> </ul>
Front tweeters	<ul style="list-style-type: none"> <li>Outputs audio signal from BOSE speaker amp.</li> <li>Outputs high range sounds</li> </ul>
Center speaker	<ul style="list-style-type: none"> <li>Outputs audio signal from BOSE speaker amp.</li> <li>Outputs high, mid and low range sounds</li> </ul>

## DVD PLAYER

< FUNCTION DIAGNOSIS >

[BOSE AUDIO WITH NAVIGATION]

Part name	Description
Rear door tweeters	<ul style="list-style-type: none"><li>• Outputs audio signal from BOSE speaker amp.</li><li>• Outputs high range sounds</li></ul>
Rear door speakers	<ul style="list-style-type: none"><li>• Outputs audio signal from BOSE speaker amp.</li><li>• Outputs high, mid and low range sounds</li></ul>
Back door speakers	<ul style="list-style-type: none"><li>• Outputs audio signal from BOSE speaker amp.</li><li>• Outputs high, mid and low range sounds</li></ul>
Subwoofer	<ul style="list-style-type: none"><li>• Outputs audio signal from BOSE speaker amp.</li><li>• Outputs low range sounds</li></ul>

# HANDS-FREE PHONE SYSTEM

< FUNCTION DIAGNOSIS >

[BOSE AUDIO WITH NAVIGATION]

## HANDS-FREE PHONE SYSTEM

### System Diagram

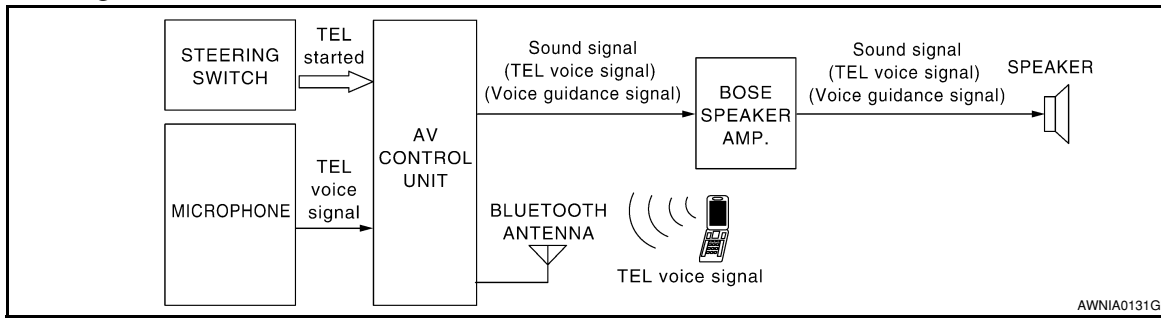

### System Description

INFOID:000000001317791

Refer to the Owner's Manual for Bluetooth telephone system operating instructions.

**NOTE:**

Cellular telephones must have their wireless connection set up (paired) before using the Bluetooth telephone system.

Bluetooth telephone system allows users who have a Bluetooth equipped cellular telephone to make a wireless connection between their cellular telephone and the AV control unit. Hands-free cellular telephone calls can be sent and received. Personal memos can be created using the Nissan Voice Recognition system. Some Bluetooth cellular telephones may not be recognized by the AV control unit. When a cellular telephone or the AV control unit is replaced, the telephone must be paired with the AV control unit. Different cellular telephones may have different pairing procedures. Refer to the cellular telephone operating manual and the vehicle Owner's Manual for more information.

#### AV CONTROL UNIT

When the ignition switch is turned to ACC or ON, the AV control unit will power up. During power up, the Bluetooth feature is initialized and performs various self checks. Initialization may take up to 10 seconds. If a phone is present in the vehicle and paired with the AV control unit, Nissan Voice Recognition will then become active. Bluetooth telephone functions can be turned off using the Nissan Voice Recognition system.

#### STEERING WHEEL AUDIO CONTROL SWITCHES

When buttons on the steering wheel audio control switch are pushed, the resistance in steering wheel audio control switch circuit changes depending on which button is pushed. The AV control unit uses this signal to perform various functions while navigating through the voice recognition system.

The following functions can be performed using the steering wheel audio control switch:

- Initiate Self Diagnosis of the Bluetooth telephone system
- Start a voice recognition session
- Answer and end telephone calls
- Adjust the volume of calls
- Record memos

#### MICROPHONE

The microphone is located in the roof console assembly. The microphone sends a signal to the AV control unit. The microphone can be actively tested during self-diagnosis.

AV

### Component Parts Location

INFOID:000000001317792

Refer to [AV-286. "Component Parts Location"](#).

### Component Description

INFOID:000000001317793

Part name	Description
AV control unit	<ul style="list-style-type: none"> <li>• Receives telephone voice signal from Antenna and Microphone</li> <li>• Sends telephone voice and voice guidance signals to the speakers</li> </ul>
BOSE speaker amp.	<ul style="list-style-type: none"> <li>• Receives audio signals from the AV control unit</li> <li>• Outputs amplified audio signals to the speakers.</li> </ul>

# HANDS-FREE PHONE SYSTEM

< FUNCTION DIAGNOSIS >

[BOSE AUDIO WITH NAVIGATION]

Part name	Description
Front door speaker	Receives telephone voice and voice guidance signals from the AV control unit through the BOSE speaker amp.
Front tweeter	
Center speaker	
Steering switches	<ul style="list-style-type: none"><li>• Start a voice recognition session</li><li>• Answer and end telephone calls</li><li>• Adjust the volume level</li></ul>
Microphone	Sends voice signals to Bluetooth control unit
Bluetooth antenna	Sends telephone voice signal to Bluetooth control unit



# DIAGNOSIS SYSTEM (AV CONTROL UNIT)

< FUNCTION DIAGNOSIS >

[BOSE AUDIO WITH NAVIGATION]

## DIAGNOSIS SYSTEM (AV CONTROL UNIT)

### AV CONTROL UNIT

#### AV CONTROL UNIT : Diagnosis Description

INFOID:000000001317794

#### DESCRIPTION

- Diagnosis function consists of the “Self-Diagnosis” mode performed automatically and the “Confirmation/Adjustment” mode operated manually.
- “Self-Diagnosis” mode checks for connections between the units constituting this system, analyzes each individual unit at the same time, and displays the results on the LCD screen.
- “Confirmation/Adjustment” mode is used to perform trouble diagnosis that requires operation and judgment by an operator (trouble that cannot be automatically judged by the system), to check/change the set value, and to display the error history of the AV control unit.

#### DIAGNOSIS ITEM

Mode	Description
Self-diagnosis	<ul style="list-style-type: none"><li>• AV control unit diagnosis</li><li>• Analyzes connection between the AV control unit, front display, switches, DVD deck, GPS antenna, rear view camera control unit and SAT antenna.</li></ul>

A  
B  
C  
D  
E  
F  
G  
H  
I  
J  
K  
L  
M

AV

O  
P

# DIAGNOSIS SYSTEM (AV CONTROL UNIT)

< FUNCTION DIAGNOSIS >

[BOSE AUDIO WITH NAVIGATION]

Mode		Description	
CONFIRMATION/ ADJUSTMENT	Display diagnosis	Color spectrum bar	Color tone of the screen can be checked by the display of a color bar.
		Gradation bar	Shading of the screen can be checked by the display of a gray scale.
		Touch panel	<ul style="list-style-type: none"> <li>• Touch panel calibration</li> <li>• Touch panel response check</li> </ul>
	Vehicle signals		The following vehicle signals are analyzed: Vehicle speed signal, parking brake signal, light signal, ignition switch signal, and reverse signal.
	Speaker test		Connection can be checked by sending a test tone to each speaker.
	Navigation	Steering angle adjustment	Confirm/adjust the steering angle when there is a difference between the displayed vehicle mark turning angle and actual.
		Speed calibration	Confirm/adjust the speed calibration when there is a difference between the displayed vehicle mark location and actual.
		XM SAT subscription status	Check the subscription status of the XM NAV Traffic subscription.
	Error history		Diagnosis results previously stored in the memory are displayed in this mode.
	Synchronize FES clock		Turns FES (Family Entertainment System) clock synchronization function ON/OFF.
	Vehicle CAN diagnosis		The transmitting/receiving of CAN communication can be monitored.
	AV COMM diagnosis		The transmitting/receiving of AV communication can be monitored.
	Handsfree phone	Handsfree volume adjustment	Adjust handsfree volume (low, medium, high).
		Voice microphone test	Test microphone operation.
		Delete handsfree memory	Erase handsfree system memory.
	Bluetooth	Confirm/Change passkey	Confirm and change the Bluetooth passkey
		Confirm/Change device name	Confirm and change a device name stored in Bluetooth.
	SAT	Change channel	Any necessary channels required to receive traffic information from the satellite radio system can be set.
		Change application ID	Any application ID's required to receive traffic information from the satellite radio system can be set.
		Diag	Not used.
Delete unit connection log		Erase the error history and connection history of the unit.	
Initialize settings		All audio settings are reset to default levels.	

## OPERATION PROCEDURE

1. Start the engine.
2. Turn the audio system off.
3. While pressing the "SETTING" button, turn the volume control dial counterclockwise 30 clicks or more.

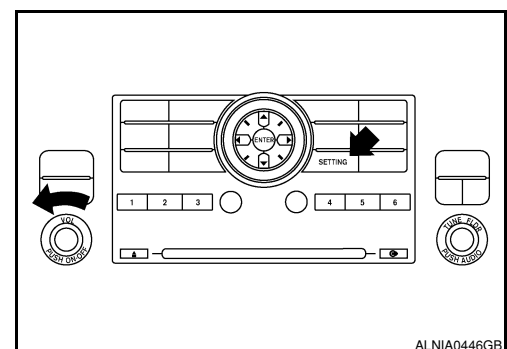

ALNIA0446GB

# DIAGNOSIS SYSTEM (AV CONTROL UNIT)

[BOSE AUDIO WITH NAVIGATION]

< FUNCTION DIAGNOSIS >

- The initial trouble diagnosis screen will be displayed, and items “Self-Diagnosis” and “Confirmation/Adjustment” can be selected.

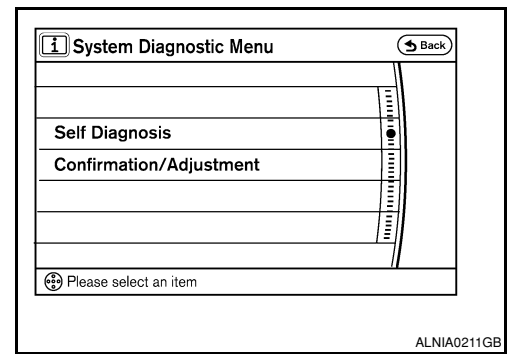

## SELF-DIAGNOSIS

- Perform self-diagnosis by selecting “Self-Diagnosis”.
  - Self-diagnosis subdivision screen is displayed, and the self-diagnosis mode starts.
  - A bar graph visible on the center of the self-diagnosis subdivision screen indicates progress of the trouble diagnosis.

**NOTE:**

Self-diagnosis requires approximately 10 seconds to complete.

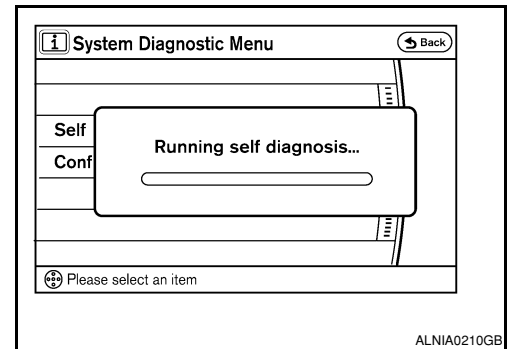

- Diagnosis results are displayed after the self-diagnosis is completed. The unit names and the connection lines are color-coded according to the diagnostic results.

Diagnosis results	Unit	Connection line
Normal	Green	Green
Connection malfunction	Gray	Yellow
Unit malfunction <small>Note</small>	Red	Green

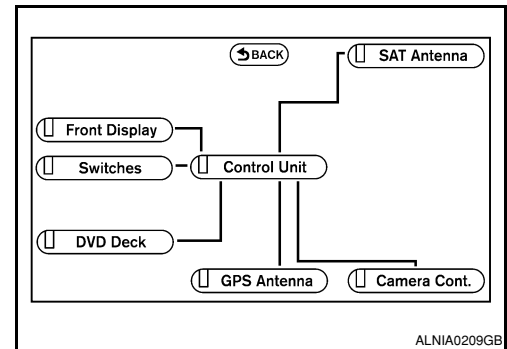

Note:

- Only the AV control unit is displayed in red.
- If multiple malfunctions occur at the same time for a single unit, the screen switch colors are determined according to the following order of priority: red > yellow > gray.

- Select a component on the “Self-Diagnosis” screen and comments for the diagnosis results will be shown.

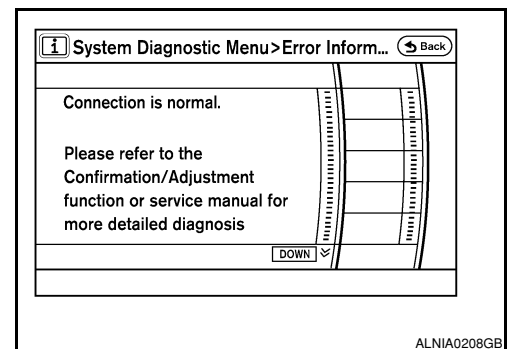

Self-Diagnosis Results

A  
B  
C  
D  
E  
F  
G  
H  
I  
J  
K  
L  
M  
O  
P

AV

# DIAGNOSIS SYSTEM (AV CONTROL UNIT)

< FUNCTION DIAGNOSIS >

[BOSE AUDIO WITH NAVIGATION]

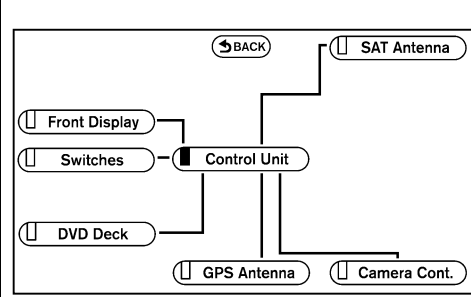
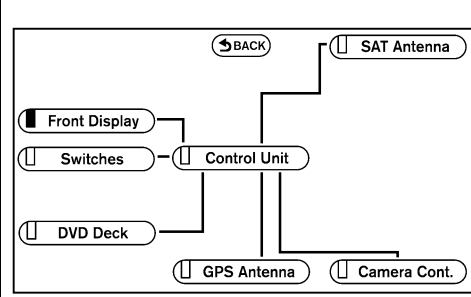
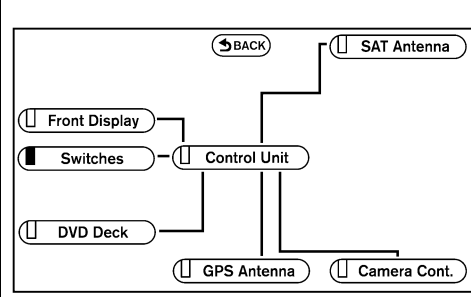
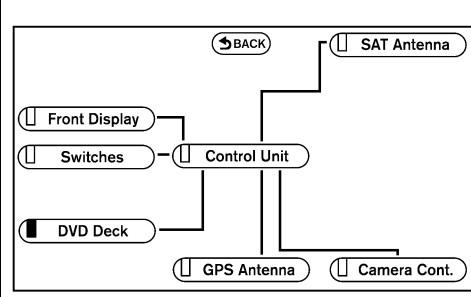
Area with yellow connection lines	Description	Possible malfunction location / Action to take
 <p>ALNIA0214GB</p>	<p>AV control unit malfunction is detected</p>	<p>Replace the AV control unit. Refer to <a href="#">AV-438, "Removal and Installation"</a>.</p>
 <p>ALNIA0207GB</p>	<p>Poor connection is detected for the display unit</p>	<ul style="list-style-type: none"> <li>• Harness or connector</li> <li>• AV control unit</li> <li>• Display unit</li> </ul>
 <p>ALNIA0212GB</p>	<p>Switch malfunction is detected</p>	<p>Perform A/C and AV switch assembly diagnostics. Refer to <a href="#">AV-140, "A/C AND AV SWITCH ASSEMBLY : Component Function Check"</a></p>
 <p>ALNIA0213GB</p>	<p>Poor connection is detected for the DVD player.</p>	<ul style="list-style-type: none"> <li>• Harness or connector</li> <li>• AV control unit</li> <li>• DVD player</li> </ul>

# DIAGNOSIS SYSTEM (AV CONTROL UNIT)

< FUNCTION DIAGNOSIS >

[BOSE AUDIO WITH NAVIGATION]

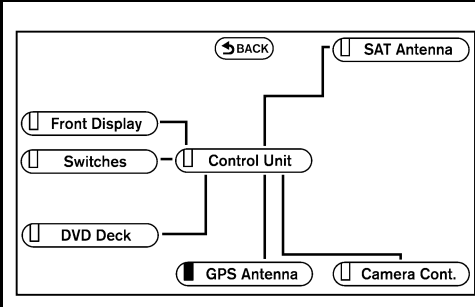
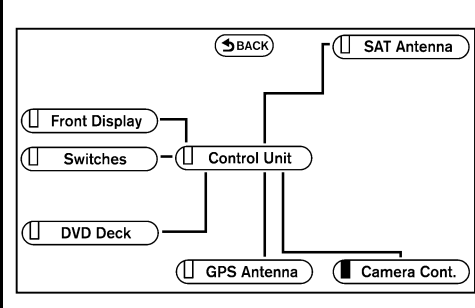
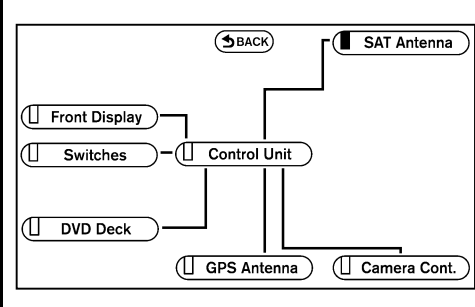
Area with yellow connection lines	Description	Possible malfunction location / Action to take
 <p style="text-align: right; font-size: small;">ALNIA0215GB</p>	<p>Poor connection is detected for the GPS antenna</p>	<ul style="list-style-type: none"> <li>• Harness or connector</li> <li>• AV control unit</li> <li>• GPS antenna</li> </ul>
 <p style="text-align: right; font-size: small;">ALNIA0217GB</p>	<p>Poor connection is detected for the rear camera control unit.</p>	<ul style="list-style-type: none"> <li>• Harness or connector</li> <li>• AV control unit</li> <li>• Rear camera control unit</li> </ul>
 <p style="text-align: right; font-size: small;">ALNIA0216GB</p>	<p>Poor connection is detected for the satellite radio tuner.</p>	<ul style="list-style-type: none"> <li>• Harness or connector</li> <li>• AV control unit</li> <li>• Satellite radio tuner</li> </ul>

## CONFIRMATION/ADJUSTMENT MODE

1. Start the diagnosis function and select "Confirmation/Adjustment". The confirmation/adjustment mode indicates where each item can be checked or adjusted.
2. Select each item on the "Confirmation/Adjustment" mode screen to display the relevant trouble diagnosis screen. Touch "BACK" on the display or press the "BACK" button to return to the initial Confirmation/Adjustment Mode screen.

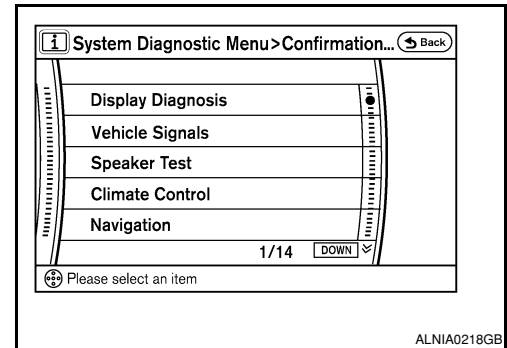

# DIAGNOSIS SYSTEM (AV CONTROL UNIT)

< FUNCTION DIAGNOSIS >

[BOSE AUDIO WITH NAVIGATION]

## Display Diagnosis

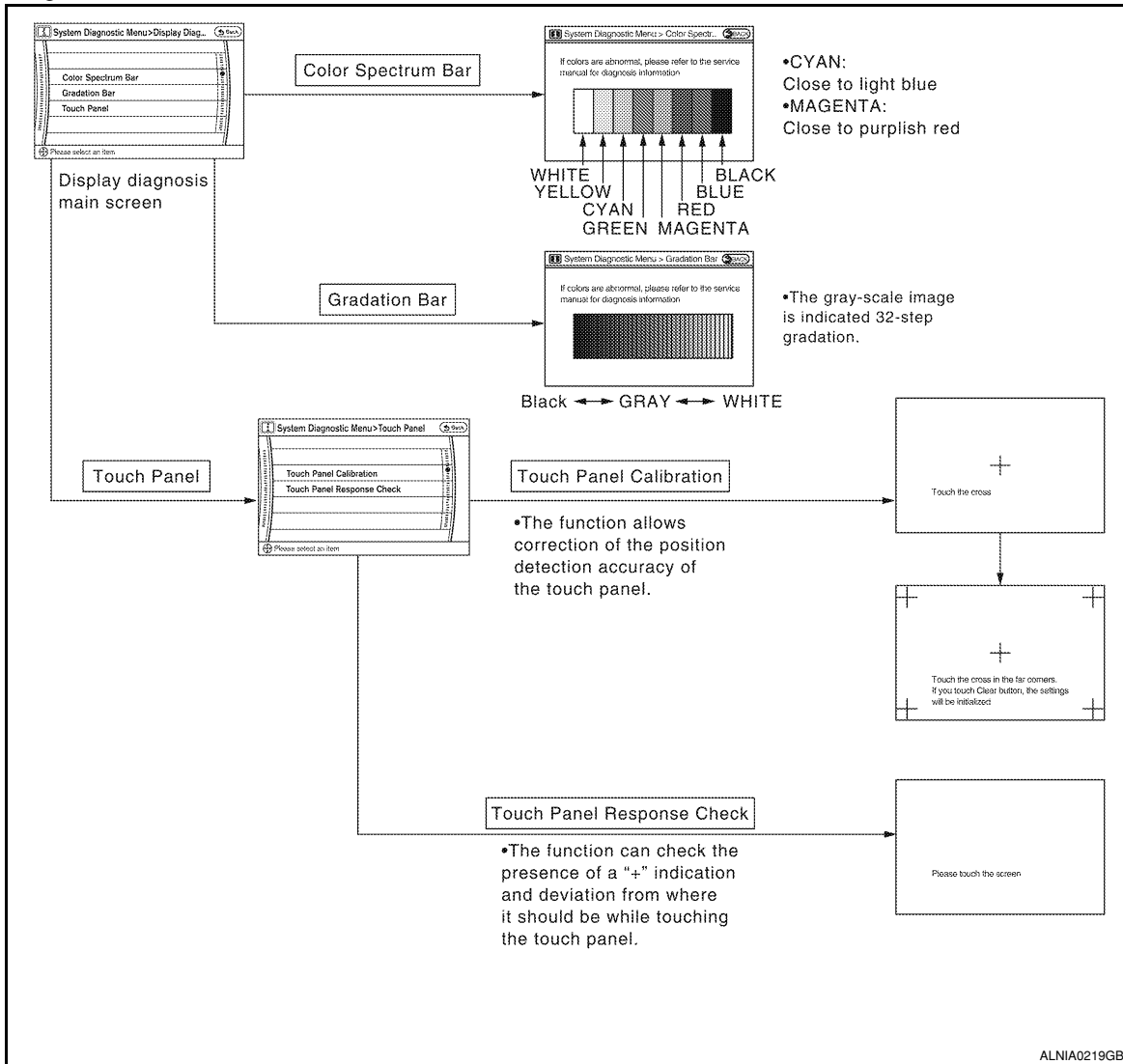

The tint of the color bar indication is as per the following list if RGB signal error is detected.

- R (red) signal error** : Light blue (Cyan) tint
- G (green) signal error** : Purple (Magenta) tint
- B (blue) signal error** : Yellow tint

### Vehicle Signals

A comparison check can be made of each actual vehicle signal and the signals recognized by the system.

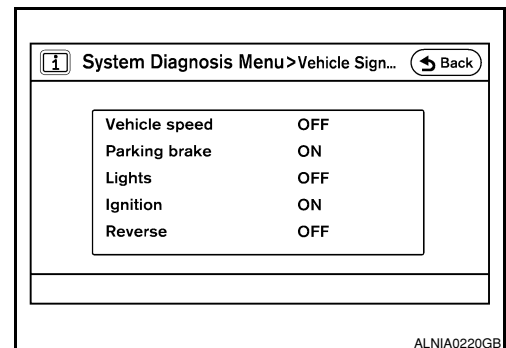

# DIAGNOSIS SYSTEM (AV CONTROL UNIT)

< FUNCTION DIAGNOSIS >

[BOSE AUDIO WITH NAVIGATION]

Diagnosis item	Display	Vehicle status	Remarks
Vehicle speed	ON	Vehicle speed > 0 km/h	Changes in indication may be delayed by approximately 1.5 seconds. This is normal.
	OFF	Vehicle speed = 0 km/h	
	—	Ignition switch in ACC position	
Parking brake	ON	Parking brake is applied.	
	OFF	Parking brake is released.	
Lights	ON	Light switch ON	Block the light beam from the auto light optical sensor.
	OFF	Light switch OFF	
Ignition	ON	Ignition switch ON	—
	OFF	Ignition switch in ACC position	
Reverse	ON	Selector lever in R position	Changes in indication may be delayed by approximately 1.5 seconds. This is normal.
	OFF	Selector lever in any position other than R	
	—	Ignition switch in ACC position	

## Speaker Test

Select “Speaker Test” to display the speaker diagnosis screen. Press “Start” to generate a test tone in speakers. Touch “End” to stop the test tones.

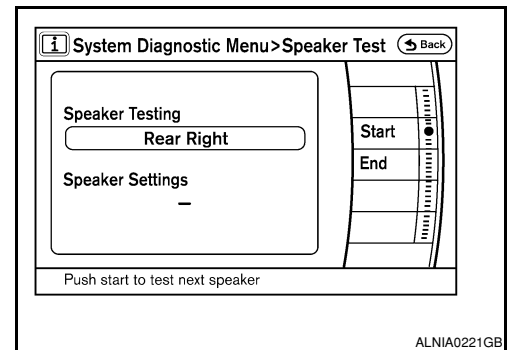

## Navigation

### STEERING ANGLE ADJUSTMENT

The steering angle output value detected with the gyroscope is adjusted.

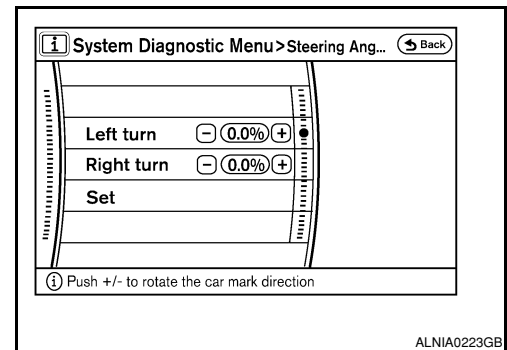

### SPEED CALIBRATION

During normal driving, distance error caused by tire wear and tire pressure change is automatically adjusted for by the automatic distance correction function. This function, on the other hand, is for immediate adjustment, in cases such as driving with tire chain fitted on tires.

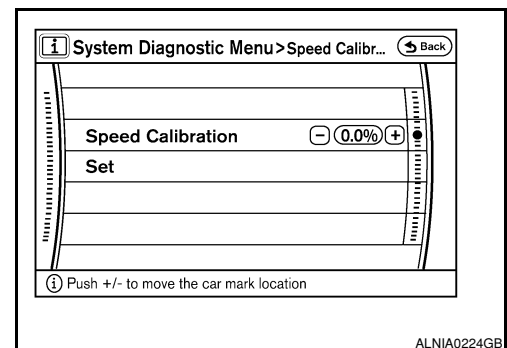

A  
B  
C  
D  
E  
F  
G  
H  
I  
J  
K  
L  
M  
AV  
O  
P

# DIAGNOSIS SYSTEM (AV CONTROL UNIT)

< FUNCTION DIAGNOSIS >

[BOSE AUDIO WITH NAVIGATION]

## XM SAT SUBSCRIPTION STATUS

The XM NavTraffic subscription status can be checked.

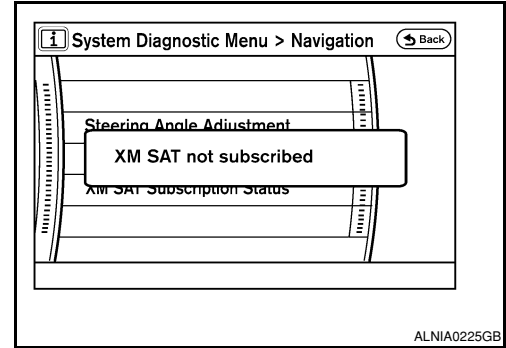

## Error History

The self-diagnosis results are judged depending on whether any error occurs from when "Self-diagnosis" is selected until the self-diagnosis results are displayed.

However, the diagnosis results are judged normal if an error has occurred before the ignition SW is turned ON and then no error has occurred until the self-diagnosis start. Check the "Error History" to detect any error that may have occurred before the self-diagnosis start because of this situation.

### Count up method A

- The counter resets to 0 if an error occurs when IGN switch is turned ON. The counter increases by 1 if the condition is normal at a next IGN ON cycle.
- The counter upper limit is 39. Any counts exceeding 39 are ignored. The counter can be reset (no error-record display) with the "Delete log" switch or CONSULT-III.

### Count up method B

- The counter increases by 1 if an error occurs when IGN switch is ON. The counter will not decrease even if the condition is normal at the next IGN ON cycle.
- The counter upper limit is 50. Any counts exceeding 50 are ignored. The counter can be reset (no error-record display) with the "Delete log" switch or CONSULT-III.

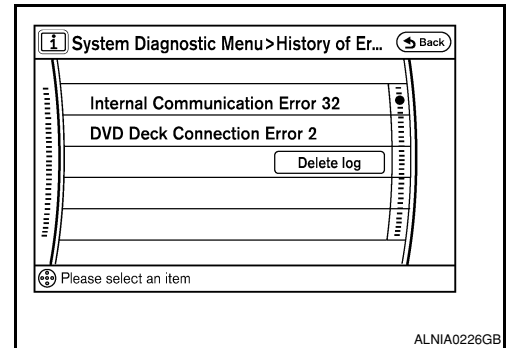

Display method of occurrence frequency	Error history display item
Count up method A	CAN communication line, control unit (CAN), AV communication line, control unit (AV communication)
Count up method B	Other than above

## Error item

Some error items may be displayed simultaneously according to the cause. If some error items are displayed simultaneously, the detection of the cause can be performed by the combination of display items

Error item	Description	Possible malfunction factor/Action to take
CAN COMM CIRCUIT	CAN communication malfunction is detected	Perform diagnosis with CONSULT-III, and then repair the malfunctioning parts according to the diagnosis results. Refer to <a href="#">AV-308. "AV CONTROL UNIT : CONSULT-III Function"</a> .



# DIAGNOSIS SYSTEM (AV CONTROL UNIT)

< FUNCTION DIAGNOSIS >

[BOSE AUDIO WITH NAVIGATION]

Error item	Description	Possible malfunction factor/Action to take
CONTROL UNIT (CAN)	CAN initial diagnosis malfunction is detected	Replace the AV control unit. Refer to <a href="#">AV-438, "Removal and Installation"</a>
CONTROL UNIT (AV)	AV communication circuit initial diagnosis malfunction is detected	
FLASH-ROM Error Of Control Unit	AV control unit malfunction is detected	
Connection Of Gyro		
XM SERIAL COMM Error		
CAN Controller Memory Error		
Bluetooth Module Connection Error		
HDD CONN Error		
HDD READ Error		
HDD WRITE Error		
HDD COMM Error		
HDD ACCESS Error		
DSP CONN Error		
DSP COMM Error		
Internal Communication Error		AV control unit power supply and ground circuit. Refer to <a href="#">AV-338, "AV CONTROL UNIT : Diagnosis Procedure"</a>
GPS Communication Error	GPS malfunction is detected	An intermittent error caused by strong radio interference may be detected unless any symptoms (GPS reception error, etc.) occur. Replace the AV control unit if the malfunction occurs constantly. Refer to <a href="#">AV-438, "Removal and Installation"</a>
GPS ROM Error		
GPS RAM Error		
GPS RTC Error		
Front Display Connection Error	<ul style="list-style-type: none"> <li>Display unit power supply and ground circuit malfunction is detected</li> <li>Malfunction is detected on communication circuit between display unit and AV control unit</li> <li>Malfunction is detected on communication signal between display unit and AV control unit</li> </ul>	<ul style="list-style-type: none"> <li>Display unit power supply and ground circuit. Refer to <a href="#">AV-339, "DISPLAY UNIT : Diagnosis Procedure"</a></li> <li>Communication circuit between display unit and AV control unit</li> </ul>
GPS Antenna Error	GPS antenna connection malfunction is detected	GPS antenna
XM Antenna Connection Error	Poor connection is detected in satellite radio antenna	Satellite radio antenna
Camera Control Unit Connection Error	A malfunction is detected in the rear view camera-connection recognition signal circuit	Rear view camera-connection recognition signal circuit
<ul style="list-style-type: none"> <li>AV COMM CIRCUIT</li> <li>Switches Connection Error</li> </ul>	<ul style="list-style-type: none"> <li>A/C and AV switch assembly power supply and ground circuit malfunction is detected</li> <li>A malfunction is detected in AV communication circuit between AV control unit and A/C and AV switch assembly</li> <li>A malfunction is detected in AV communication signal between AV control unit and A/C and AV switch assembly</li> </ul>	<ul style="list-style-type: none"> <li>A/C and AV switch assembly power supply and ground circuits. Refer to <a href="#">AV-340, "A/C AND AV SWITCH ASSEMBLY : Diagnosis Procedure"</a></li> <li>AV communication circuit between AV control unit and A/C and AV switch assembly</li> </ul>

A  
B  
C  
D  
E  
F  
G  
H  
I  
J  
K  
L  
M  
AV  
O  
P

# DIAGNOSIS SYSTEM (AV CONTROL UNIT)

< FUNCTION DIAGNOSIS >

[BOSE AUDIO WITH NAVIGATION]

Error item	Description	Possible malfunction factor/Action to take
<ul style="list-style-type: none"> <li>AV COMM CIRCUIT</li> <li>Rear View Camera Connection Error</li> </ul>	<ul style="list-style-type: none"> <li>A malfunction is detected in camera control unit power supply and ground circuits</li> <li>Malfunction is detected on AV communication signal between camera control unit and AV control unit</li> </ul>	Rear view camera control unit power supply and ground circuits. Refer to <a href="#">AV-342</a> , " <a href="#">REAR VIEW CAMERA CONTROL UNIT : Diagnosis Procedure</a> "
<ul style="list-style-type: none"> <li>AV COMM CIRCUIT</li> <li>Rear View Camera Connection Error</li> <li>Rear View Camera Control Unit Connection Error</li> </ul>	<ul style="list-style-type: none"> <li>Malfunction is detected in AV communication circuit between camera control unit and AV control unit</li> <li>Malfunction is detected on AV communication signal between camera control unit and AV control unit</li> </ul>	AV communication circuit between Camera control unit and AV control unit

## Vehicle CAN Diagnosis

- CAN communication status and error counter is displayed.
- The error counter displays "OK" if any malfunction was not detected in the past and displays "0" if a malfunction is detected. It increases by 1 if the condition is normal at the next ignition switch ON cycle. The upper limit of the counter is 39.
- The error counter is erased if reset.

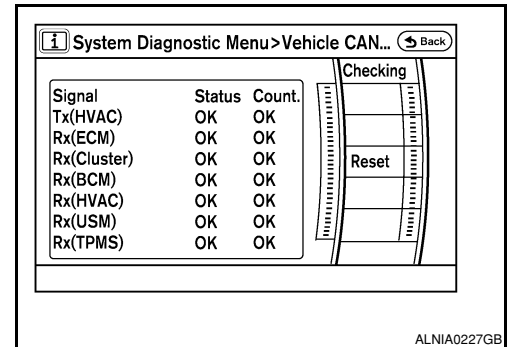

## AV COMM Diagnosis

- AV communication status and error counter is displayed.
- The error counter displays "OK" if any malfunction was not detected in the past and displays "0" if a malfunction is detected. It increases by 1 if the condition is normal at the next ignition switch ON cycle. The upper limit of the counter is 39.
- The error counter is erased if reset.

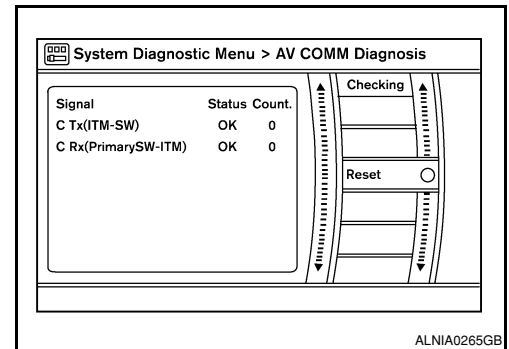

## Handsfree Phone

The hands-free phone reception volume adjustment, microphone and speaker test, and memory erase functions are also available.

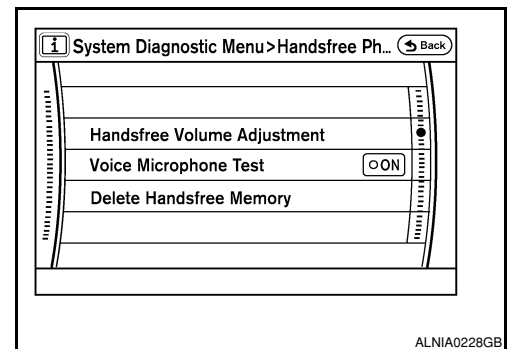

## Bluetooth

Passkey confirmation/change

# DIAGNOSIS SYSTEM (AV CONTROL UNIT)

## [BOSE AUDIO WITH NAVIGATION]

### < FUNCTION DIAGNOSIS >

- The passkey of Bluetooth can be confirmed and changed.
- The passkey can be changed by four digits within 0 to 9.

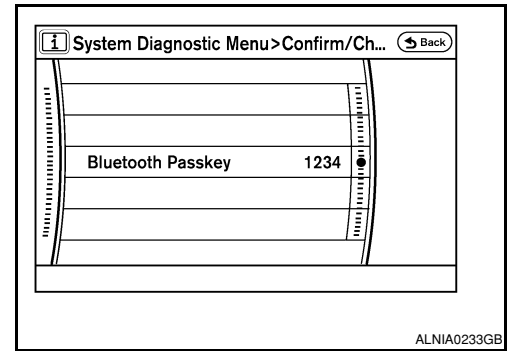

### Device name check/change

- The device name of Bluetooth can be confirmed and changed.
- The device name can be changed by sixteen digits within A to Z (small character can be used) and - (hyphen).

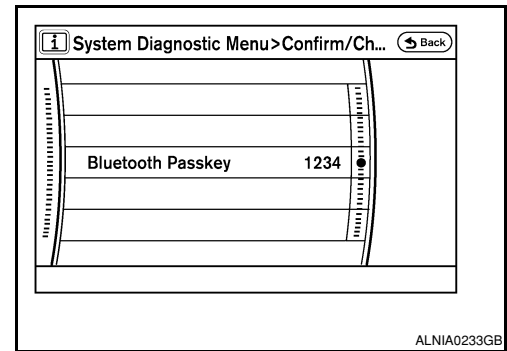

### SAT

- Change Channel
- Any necessary channels required to receive traffic information from the satellite radio system can be set.

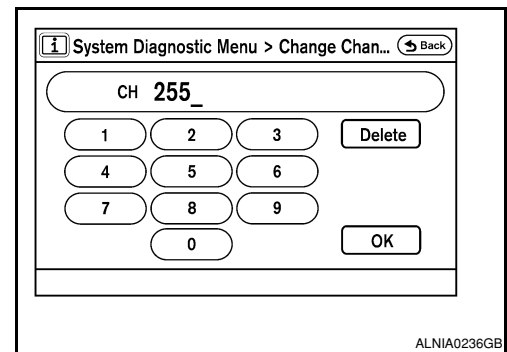

- Change Application ID
- Any application ID's required to receive traffic information from the satellite radio system can be set.

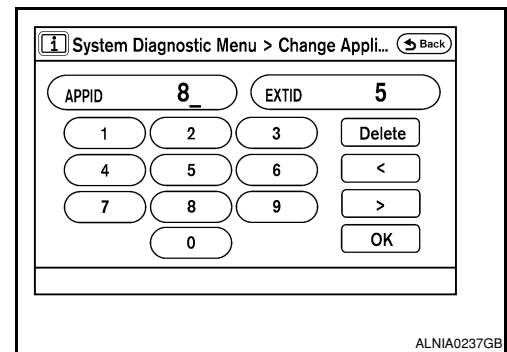

Delete Unit Connection Log

A  
B  
C  
D  
E  
F  
G  
H  
I  
J  
K  
L  
M  
AV  
O  
P

# DIAGNOSIS SYSTEM (AV CONTROL UNIT)

[BOSE AUDIO WITH NAVIGATION]

## < FUNCTION DIAGNOSIS >

Deletes any unit connection records and error records from the AV control unit memory. (Clear the records of the unit that has been removed)

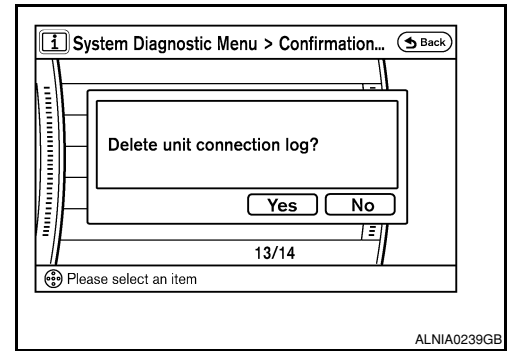

### Initialize Settings

Initializes the AV control unit memory.

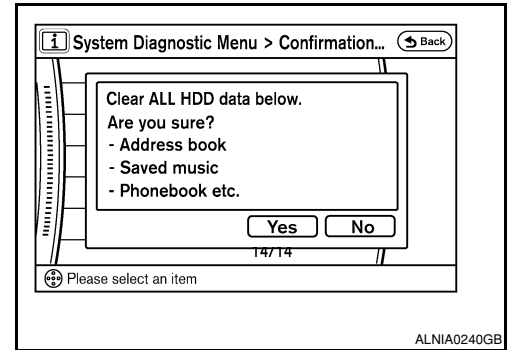

## AV CONTROL UNIT : CONSULT-III Function

INFOID:000000001317795

CONSULT-III can display each diagnostic item using the diagnostic test modes shown following.

MULTI AV diagnosis mode	Description
SELF-DIAG RESULTS	Displays AV control unit self-diagnosis results.
DATA MONITOR	Displays AV control unit input/output data in real time.
CAN DIAG SUPPORT MNTR	The result of transmit/receive diagnosis of CAN communication can be read.
AV COMM MONITOR	Allows the technician to monitor the status of the Multi AV system communication signals.
ECU PART NUMBER	The part number of AV control unit can be checked.

### Self-diagnosis results

- In CONSULT-III self-diagnosis, self-diagnosis results and error history are displayed collectively.
- The current malfunction indicates “CRNT”. The past malfunction indicates “PAST”.
- The timing is displayed as “0” if any of the error codes [U1000], [U1010], [U1300] and [U1310] is detected. The counter increases by 1 if the condition is normal at the next ignition switch ON cycle.

Self-diagnosis results display item

Error item	Description	Possible malfunction factor/Action to take
CAN COMM CIRCUIT[U1000]	CAN communication malfunction is detected	Perform diagnosis with CONSULT-III, and then repair the malfunctioning parts according to the diagnosis results. Refer to <a href="#">AV-308, "AV CONTROL UNIT : CONSULT-III Function"</a> .

# DIAGNOSIS SYSTEM (AV CONTROL UNIT)

< FUNCTION DIAGNOSIS >

[BOSE AUDIO WITH NAVIGATION]

Error item	Description	Possible malfunction factor/Action to take
CONTROL UNIT (CAN) [U1010]	CAN initial diagnosis malfunction is detected	Replace the AV control unit
CONTROL UNIT (AV) [U1310]	AV communication circuit initial diagnosis malfunction is detected	
Control Unit FLASH-ROM [U1200]	AV control unit malfunction is detected	
Gyro NO CONN [U1201]		
CAN CONT [U1216]		
BLUETOOTH CONN [U1217]		
HDD CONN [U1218]		
HDD READ [U1219]		
XM SERIAL COMM [U1220]		
HDD WRITE [U121A]		
HDD COMM [U121B]		
HDD ACCESS [U121C]		
DSP CONN [U121D]	AV control unit power supply and ground circuit	
DSP COMM [U121E]		
INTERNAL COMM [U121F]	GPS malfunction is detected	An intermittent error caused by strong radio interference may be detected unless any symptoms (GPS reception error, etc.) occur. Replace the AV control unit if the malfunction occurs constantly.
GPS COMM [U1204]		
GPS ROM [U1205]		
GPS RAM [U1206]		
GPS RTC [U1207]	<ul style="list-style-type: none"> <li>• Display unit power supply and ground circuit malfunction is detected</li> <li>• Malfunction is detected on communication circuit between display unit and AV control unit</li> <li>• Malfunction is detected on communication signal between display unit and AV control unit</li> </ul>	<ul style="list-style-type: none"> <li>• Display unit power supply and ground circuit</li> <li>• Communication circuit between display unit and AV control unit</li> </ul>
FRONT DISP CONN [U1243]		
GPS ANTENNA CONN [U1244]		
XM ANTENNA CONN [U1258]	Poor connection is detected in satellite radio antenna	Satellite radio antenna
CAMERA CONT. CONN [U1250]	A malfunction is detected in Camera-connection recognition signal circuit	Camera-connection recognition signal circuit
<ul style="list-style-type: none"> <li>• AV COMM CIRCUIT [U1300]</li> <li>• SWITCHE CONN [U1240]</li> </ul>	<ul style="list-style-type: none"> <li>• Multifunction switch power supply and ground circuit malfunction is detected</li> <li>• A malfunction is detected in AV communication circuit between AV control unit and multifunction switch</li> <li>• A malfunction is detected in AV communication signal between AV control unit and multifunction switch</li> </ul>	<ul style="list-style-type: none"> <li>• Multifunction switch power supply and ground circuits</li> <li>• AV communication circuit between AV control unit and multifunction switch</li> </ul>

A  
B  
C  
D  
E  
F  
G  
H  
I  
J  
K  
L  
M  
AV  
O  
P

# DIAGNOSIS SYSTEM (AV CONTROL UNIT)

< FUNCTION DIAGNOSIS >

[BOSE AUDIO WITH NAVIGATION]

Error item	Description	Possible malfunction factor/Action to take
<ul style="list-style-type: none"> <li>• AV COMM CIRCUIT [U1300]</li> <li>• REAR CAMERA LAN CONN [U1252]</li> </ul>	<ul style="list-style-type: none"> <li>• A malfunction is detected in camera control unit power supply and ground circuits</li> <li>• Malfunction is detected on AV communication signal between Camera control unit and AV control unit</li> </ul>	Camera control unit power supply and ground circuits
<ul style="list-style-type: none"> <li>• AV COMM CIRCUIT [U1300]</li> <li>• CAMERA CONT. CONN [U1250]</li> <li>• REAR CAMERA LAN CONN [U1252]</li> </ul>	<ul style="list-style-type: none"> <li>• Malfunction is detected on AV communication circuit between camera control unit and AV control unit</li> <li>• Malfunction is detected on AV communication signal between camera control unit and AV control unit</li> </ul>	AV communication circuit between camera control unit and AV control unit

## DATA MONITOR

Display Item List

Display item [unit]	ALL SIGNALS	SELECTION FROM MENU	Description
VHCL SPD SIG [ON/OFF]	X	X	Displays "ON" when vehicle speed > 0 km/h. Displays "OFF" when vehicle speed = 0 km/h.
PKB SIG [ON/OFF]	X	X	Displays [ON/OFF] condition of parking brake switch.
ILLUM SIG [ON/OFF]	X	X	Displays [ON/OFF] condition of lighting switch.
IGN SIG [ON/OFF]	X	X	Displays [ON/OFF] condition of ignition switch.
REV SIG [ON/OFF]	X	X	Displays [ON/OFF] condition of back-up lamp switch.

## A/C AND AV SWITCH ASSEMBLY

### A/C AND AV SWITCH ASSEMBLY : Component Function Check

INFOID:000000001317796

A/C and AV switch assembly self-diagnosis function

Description

The ON/OFF operation (continuity) of each switch in the A/C and AV switch assembly can be checked.

Self-diagnosis mode

- Press the "BACK" button and the "UP" button within 10 seconds after turning the ignition switch from OFF to ACC and hold them for 3 seconds or more. When the self-diagnosis mode starts, a beep will sound and all LED indicators of the switch will illuminate.
- The continuity of each switch and control dial of the A/C and AV switch assembly can be checked. If the switch is operating normally, the system will beep and the LED's will illuminate when each switch is operated.

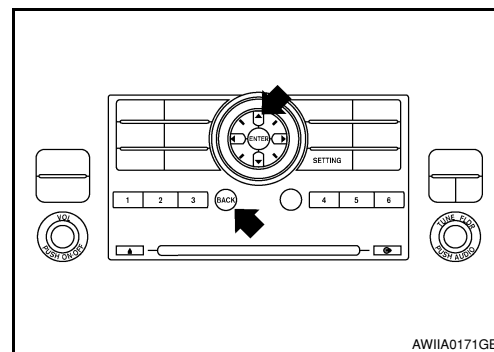

Finishing self-diagnosis mode

Self-diagnosis mode is canceled when the ignition switch is turned OFF.

COMPONENT DIAGNOSIS

U1000 CAN COMM CIRCUIT

Description

INFOID:000000001348311

CAN (Controller Area Network) is a serial communication line for real time application. It is an on-vehicle multiplex communication line with high data communication speed and excellent error detection ability. Many electronic control units are equipped onto a vehicle and each control unit shares information and links with other control units during operation (not independent). In CAN communication, control units are connected with 2 communication lines (CAN-H, CAN-L) allowing a high rate of information transmission with less wiring. Each control unit transmits/receives data but selectively reads required data only.

CAN Communication Signal Chart. Refer to [LAN-46, "CAN Communication Signal Chart"](#).

DTC Logic

INFOID:000000001348312

DTC DETECTION LOGIC

DTC	Display contents of CONSULT-III	Diagnostic item is detected when ...	Probable malfunction location
U1000	CAN COMM CIRCUIT	When AV control unit is not transmitting or receiving CAN communication signal for 2 seconds or more.	CAN communication system

Diagnosis Procedure

INFOID:000000001348313

1. PERFORM SELF DIAGNOSTIC

1. Turn ignition switch ON and wait for 2 seconds or more.
2. Check "Self Diagnostic Result" of "AV Control Unit".

Is "CAN COMM CIRCUIT" displayed?

- YES >> Refer to "LAN system". Refer to [LAN-14, "Trouble Diagnosis Flow Chart"](#).
- NO >> Refer to GI section. Refer to [GI-39, "Intermittent Incident"](#).

AV

# U1010 CONTROL UNIT (CAN)

< COMPONENT DIAGNOSIS >

[BOSE AUDIO WITH NAVIGATION]

## U1010 CONTROL UNIT (CAN)

### Description

INFOID:000000001348314

Initial diagnosis of AV control unit.

### DTC Logic

INFOID:000000001348315

### DTC DETECTION LOGIC

DTC	Display contents of CONSULT-III	Diagnostic item is detected when ...	Probable malfunction location
U1010	CONTROL UNIT (CAN)	CAN initial diagnosis malfunction is detected	AV control unit

### Diagnosis Procedure

INFOID:000000001348316

#### 1. REPLACE AV CONTROL UNIT

When DTC U1010 is detected, replace AV control unit. Refer to [AV-104. "Removal and Installation"](#)

>> INSPECTION END



# U1200 AV CONTROL UNIT

< COMPONENT DIAGNOSIS >

[BOSE AUDIO WITH NAVIGATION]

## U1200 AV CONTROL UNIT

### Description

INFOID:000000001348319

Replace the AV control unit if this DTC is displayed. Refer to [AV-438. "Removal and Installation"](#).

Part name	Description
AV CONTROL UNIT	<ul style="list-style-type: none"><li>• It is the master unit of the MULTI AV system and it is connected to each control unit by means of communication. It operates each system according to communication signals from the AV control unit.</li><li>• AV control unit includes audio function and vehicle information function.</li><li>• It is connected to ECM and combination meter via CAN communication to obtain necessary information for the vehicle information function.</li><li>• It inputs the automatic brightness ON/OFF signals that are required for the display dimming control.</li><li>• It inputs the signals for driving status recognition (vehicle speed, reverse and parking brake).</li></ul>

### DTC Logic

INFOID:000000001348320

DTC	Display contents of CONSULT-III	DTC Detection Condition	Action to take
U1200	Control Unit FLASH- ROM [U1200]	An internal malfunction is detected in AV control unit (FLASH-ROM).	Replace AV control unit. Refer to <a href="#">AV-104. "Removal and Installation"</a>

A  
B  
C  
D  
E  
F  
G  
H  
I  
J  
K  
L  
M  
O  
P

AV

# U1201 AV CONTROL UNIT

< COMPONENT DIAGNOSIS >

[BOSE AUDIO WITH NAVIGATION]

## U1201 AV CONTROL UNIT

### Description

INFOID:000000001278822

Refer to [AV-284. "System Description"](#).

### DTC Logic

INFOID:000000001278823

### DTC DETECTION LOGIC

DTC	CONSULT-III display	Detection condition	Action to take
U1201	GYRO NO CONN [U1201]	An internal malfunction is detected in AV control unit (gyrocompass disconnection).	Replace AV control unit. Refer to <a href="#">AV-438. "Removal and Installation"</a> .

# U1204 GPS COMM

< COMPONENT DIAGNOSIS >

[BOSE AUDIO WITH NAVIGATION]

## U1204 GPS COMM

### Description

INFOID:000000001278824

Refer to [AV-284, "System Description"](#).

### DTC Logic

INFOID:000000001278825

### DTC DETECTION LOGIC

DTC	CONSULT-III display	Detection condition	Action to take
U1204	GPS COMM [U1204]	An internal malfunction is detected in AV control unit (GPS malfunction).	Replace AV control unit. Refer to <a href="#">AV-438, "Removal and Installation"</a> .

A  
B  
C  
D  
E  
F  
G  
H  
I  
J  
K  
L  
M  
O  
P

AV

**U1205 GPS ROM**

**Description**

INFOID:000000001278826

Refer to [AV-288. "System Description"](#).

**DTC Logic**

INFOID:000000001278827

**DTC DETECTION LOGIC**

DTC	CONSULT-III display	Detection condition	Action to take
U1205	GPS ROM [U1205]	An internal malfunction is detected in AV control unit (GPS malfunction).	Replace AV control unit. Refer to <a href="#">AV-438. "Removal and Installation"</a> .

# U1206 GPS RAM

< COMPONENT DIAGNOSIS >

[BOSE AUDIO WITH NAVIGATION]

## U1206 GPS RAM

### Description

INFOID:000000001278828

Refer to [AV-288, "System Description"](#).

### DTC Logic

INFOID:000000001278829

### DTC DETECTION LOGIC

DTC	CONSULT-III display	Detection condition	Action to take
U1206	GPS RAM [U1206]	An internal malfunction is detected in AV control unit (GPS malfunction).	Replace AV control unit. Refer to <a href="#">AV-438, "Removal and Installation"</a> .

A  
B  
C  
D  
E  
F  
G  
H  
I  
J  
K  
L  
M  
O  
P

AV

# U1207 GPS RTC

< COMPONENT DIAGNOSIS >

[BOSE AUDIO WITH NAVIGATION]

## U1207 GPS RTC

### Description

INFOID:000000001278830

Refer to [AV-288. "System Description"](#).

### DTC Logic

INFOID:000000001278831

### DTC DETECTION LOGIC

DTC	CONSULT-III display	Detection condition	Action to take
U1207	GPS RTC [U1207]	An internal malfunction is detected in AV control unit (GPS malfunction).	Replace AV control unit. Refer to <a href="#">AV-438. "Removal and Installation"</a> .

# U1216 AV CONTROL UNIT

< COMPONENT DIAGNOSIS >

[BOSE AUDIO WITH NAVIGATION]

## U1216 AV CONTROL UNIT

### Description

INFOID:000000001348321

Replace the AV control unit if this DTC is displayed. Refer to [AV-438, "Removal and Installation"](#).

Part name	Description
AV CONTROL UNIT	<ul style="list-style-type: none"><li>• It is the master unit of the MULTI AV system and it is connected to each control unit by means of communication. It operates each system according to communication signals from the AV control unit.</li><li>• AV control unit includes audio function and vehicle information function.</li><li>• It is connected to ECM and combination meter via CAN communication to obtain necessary information for the vehicle information function.</li><li>• It inputs the automatic brightness ON/OFF signals that are required for the display dimming control.</li><li>• It inputs the signals for driving status recognition (vehicle speed, reverse and parking brake).</li></ul>

### DTC Logic

INFOID:000000001348322

DTC	Display contents of CONSULT-III	DTC Detection Condition	Action to take
U1216	CAN CONT [U1216]	Internal malfunction of AV control unit (CAN controller) is detected.	Replace AV control unit. Refer to <a href="#">AV-438, "Removal and Installation"</a>

A  
B  
C  
D  
E  
F  
G  
H  
I  
J  
K  
L  
M  
O  
P

AV

# U1217 AV CONTROL UNIT

< COMPONENT DIAGNOSIS >

[BOSE AUDIO WITH NAVIGATION]

## U1217 AV CONTROL UNIT

### Description

INFOID:000000001278864

Refer to [AV-288. "System Description"](#).

### DTC Logic

INFOID:000000001278865

### DTC DETECTION LOGIC

DTC	CONSULT-III display	Detection condition	Action to take
U1217	BLUETOOTH CONN [U1217]	An internal malfunction is detected in AV control unit (Bluetooth module connection malfunction).	Replace AV control unit. Refer to <a href="#">AV-438. "Removal and Installation"</a> .



# U1218 AV CONTROL UNIT

< COMPONENT DIAGNOSIS >

[BOSE AUDIO WITH NAVIGATION]

## U1218 AV CONTROL UNIT

### Description

INFOID:000000001315158

Replace the AV control unit if this DTC is displayed. Refer to [AV-438. "Removal and Installation"](#).

Part name	Description
AV CONTROL UNIT	<ul style="list-style-type: none"><li>• Integrates HDD (hard disk drive) allowing map data and music data to be stored.</li><li>• It is the master unit of the MULTI AV system, and it is connected to each control unit by means of communication. It operates each system according to communication signals from the AV control unit.</li><li>• The AV control unit includes the audio, hands-free phone, voice control, navigation, and vehicle information functions.</li><li>• It is connected to ECM and combination meter via CAN communication to obtain necessary information for the vehicle information function.</li><li>• It inputs the automatic brightness ON/OFF signals that are required for the display dimming control.</li><li>• It inputs the signals for driving status recognition (vehicle speed, reverse and parking brake).</li></ul>

### DTC Logic

INFOID:000000001315159

DTC	Display contents of CONSULT-III	DTC Detection Condition	Action to take
U1218	HDD-CONN [U1218]	Internal malfunction of AV control unit (HDD connection malfunction) is detected.	Replace AV control unit. Refer to <a href="#">AV-438. "Removal and Installation"</a>

A  
B  
C  
D  
E  
F  
G  
H  
I  
J  
K  
L  
M  
O  
P

AV

# U1219 AV CONTROL UNIT

< COMPONENT DIAGNOSIS >

[BOSE AUDIO WITH NAVIGATION]

## U1219 AV CONTROL UNIT

### Description

INFOID:000000001315160

Replace the AV control unit if this DTC is displayed. Refer to [AV-438. "Removal and Installation"](#).

Part name	Description
AV CONTROL UNIT	<ul style="list-style-type: none"><li>• Integrates HDD (hard disk drive) allowing map data and music data to be stored.</li><li>• It is the master unit of the MULTI AV system, and it is connected to each control unit by means of communication. It operates each system according to communication signals from the AV control unit.</li><li>• The AV control unit includes the audio, hands-free phone, voice control, navigation, and vehicle information functions.</li><li>• It is connected to ECM and combination meter via CAN communication to obtain necessary information for the vehicle information function.</li><li>• It inputs the automatic brightness ON/OFF signals that are required for the display dimming control.</li><li>• It inputs the signals for driving status recognition (vehicle speed, reverse and parking brake).</li></ul>

### DTC Logic

INFOID:000000001315161

DTC	Display contents of CONSULT-III	DTC Detection Condition	Action to take
U1219	HDD-READ [U1219]	Internal malfunction of AV control unit (HDD read malfunction) is detected.	Replace AV control unit. Refer to <a href="#">AV-438. "Removal and Installation"</a>

# U121A AV CONTROL UNIT

< COMPONENT DIAGNOSIS >

[BOSE AUDIO WITH NAVIGATION]

## U121A AV CONTROL UNIT

### Description

INFOID:000000001315162

Replace the AV control unit if this DTC is displayed. Refer to [AV-438. "Removal and Installation"](#).

Part name	Description
AV CONTROL UNIT	<ul style="list-style-type: none"><li>Integrates HDD (hard disk drive) allowing map data and music data to be stored.</li><li>It is the master unit of the MULTI AV system, and it is connected to each control unit by means of communication. It operates each system according to communication signals from the AV control unit.</li><li>The AV control unit includes the audio, hands-free phone, voice control, navigation, and vehicle information functions.</li><li>It is connected to ECM and combination meter via CAN communication to obtain necessary information for the vehicle information function.</li><li>It inputs the automatic brightness ON/OFF signals that are required for the display dimming control.</li><li>It inputs the signals for driving status recognition (vehicle speed, reverse and parking brake).</li></ul>

### DTC Logic

INFOID:000000001315163

DTC	Display contents of CONSULT-III	DTC Detection Condition	Action to take
U121A	HDD-WRITE [U121A]	Internal malfunction of AV control unit (HDD write malfunction) is detected.	Replace AV control unit. Refer to <a href="#">AV-438. "Removal and Installation"</a>

A  
B  
C  
D  
E  
F  
G  
H  
I  
J  
K  
L  
M  
O  
P

AV

# U121B AV CONTROL UNIT

< COMPONENT DIAGNOSIS >

[BOSE AUDIO WITH NAVIGATION]

## U121B AV CONTROL UNIT

### Description

INFOID:000000001315164

Replace the AV control unit if this DTC is displayed. Refer to [AV-438. "Removal and Installation"](#).

Part name	Description
AV CONTROL UNIT	<ul style="list-style-type: none"><li>• Integrates HDD (hard disk drive) allowing map data and music data to be stored.</li><li>• It is the master unit of the MULTI AV system, and it is connected to each control unit by means of communication. It operates each system according to communication signals from the AV control unit.</li><li>• The AV control unit includes the audio, hands-free phone, voice control, navigation, and vehicle information functions.</li><li>• It is connected to ECM and combination meter via CAN communication to obtain necessary information for the vehicle information function.</li><li>• It inputs the automatic brightness ON/OFF signals that are required for the display dimming control.</li><li>• It inputs the signals for driving status recognition (vehicle speed, reverse and parking brake).</li></ul>

### DTC Logic

INFOID:000000001315165

DTC	Display contents of CONSULT-III	DTC Detection Condition	Action to take
U121B	HDD-COMM [U121B]	Internal malfunction of AV control unit (HDD communication error) is detected.	Replace AV control unit. Refer to <a href="#">AV-438. "Removal and Installation"</a>

# U121C AV CONTROL UNIT

< COMPONENT DIAGNOSIS >

[BOSE AUDIO WITH NAVIGATION]

## U121C AV CONTROL UNIT

### Description

INFOID:000000001315166

Replace the AV control unit if this DTC is displayed. Refer to [AV-438. "Removal and Installation"](#).

Part name	Description
AV CONTROL UNIT	<ul style="list-style-type: none"><li>• Integrates HDD (hard disk drive) allowing map data and music data to be stored.</li><li>• It is the master unit of the MULTI AV system, and it is connected to each control unit by means of communication. It operates each system according to communication signals from the AV control unit.</li><li>• The AV control unit includes the audio, hands-free phone, voice control, navigation, and vehicle information functions.</li><li>• It is connected to ECM and combination meter via CAN communication to obtain necessary information for the vehicle information function.</li><li>• It inputs the automatic brightness ON/OFF signals that are required for the display dimming control.</li><li>• It inputs the signals for driving status recognition (vehicle speed, reverse and parking brake).</li></ul>

### DTC Logic

INFOID:000000001315167

DTC	Display contents of CONSULT-III	DTC Detection Condition	Action to take
U121C	HDD-ACCESS [U121C]	Internal malfunction of AV control unit (HDD access error) is detected.	Replace AV control unit. Refer to <a href="#">AV-438. "Removal and Installation"</a>

A  
B  
C  
D  
E  
F  
G  
H  
I  
J  
K  
L  
M  
O  
P

AV

# U121D AV CONTROL UNIT

< COMPONENT DIAGNOSIS >

[BOSE AUDIO WITH NAVIGATION]

## U121D AV CONTROL UNIT

### Description

INFOID:000000001315168

Replace the AV control unit if this DTC is displayed. Refer to [AV-438. "Removal and Installation"](#).

Part name	Description
AV CONTROL UNIT	<ul style="list-style-type: none"><li>• Integrates HDD (hard disk drive) allowing map data and music data to be stored.</li><li>• It is the master unit of the MULTI AV system, and it is connected to each control unit by means of communication. It operates each system according to communication signals from the AV control unit.</li><li>• The AV control unit includes the audio, hands-free phone, voice control, navigation, and vehicle information functions.</li><li>• It is connected to ECM and combination meter via CAN communication to obtain necessary information for the vehicle information function.</li><li>• It inputs the automatic brightness ON/OFF signals that are required for the display dimming control.</li><li>• It inputs the signals for driving status recognition (vehicle speed, reverse and parking brake).</li></ul>

### DTC Logic

INFOID:000000001315169

DTC	Display contents of CONSULT-III	DTC Detection Condition	Action to take
U121D	DSP CONN [U121D]	Internal malfunction of AV control unit (DSP connection error) is detected.	Replace AV control unit. Refer to <a href="#">AV-438. "Removal and Installation"</a>

# U121E AV CONTROL UNIT

< COMPONENT DIAGNOSIS >

[BOSE AUDIO WITH NAVIGATION]

## U121E AV CONTROL UNIT

### Description

INFOID:000000001315170

Replace the AV control unit if this DTC is displayed. Refer to [AV-438. "Removal and Installation"](#).

Part name	Description
AV CONTROL UNIT	<ul style="list-style-type: none"><li>• Integrates HDD (hard disk drive) allowing map data and music data to be stored.</li><li>• It is the master unit of the MULTI AV system, and it is connected to each control unit by means of communication. It operates each system according to communication signals from the AV control unit.</li><li>• The AV control unit includes the audio, hands-free phone, voice control, navigation, and vehicle information functions.</li><li>• It is connected to ECM and combination meter via CAN communication to obtain necessary information for the vehicle information function.</li><li>• It inputs the automatic brightness ON/OFF signals that are required for the display dimming control.</li><li>• It inputs the signals for driving status recognition (vehicle speed, reverse and parking brake).</li></ul>

### DTC Logic

INFOID:000000001315171

DTC	Display contents of CONSULT-III	DTC Detection Condition	Action to take
U121E	DSP COMM [U121E]	Internal malfunction of AV control unit (DSP communication error) is detected.	Replace AV control unit. Refer to <a href="#">AV-438. "Removal and Installation"</a>

A  
B  
C  
D  
E  
F  
G  
H  
I  
J  
K  
L  
M  
O  
P

AV

# U121F AV CONTROL UNIT

< COMPONENT DIAGNOSIS >

[BOSE AUDIO WITH NAVIGATION]

## U121F AV CONTROL UNIT

### Description

INFOID:000000001315172

Part name	Description
AV CONTROL UNIT	<ul style="list-style-type: none"><li>• Integrates HDD (hard disk drive) allowing map data and music data to be stored.</li><li>• It is the master unit of the MULTI AV system, and it is connected to each control unit by means of communication. It operates each system according to communication signals from the AV control unit.</li><li>• The AV control unit includes the audio, hands-free phone, voice control, navigation, and vehicle information functions.</li><li>• It is connected to ECM and combination meter via CAN communication to obtain necessary information for the vehicle information function.</li><li>• It inputs the automatic brightness ON/OFF signals that are required for the display dimming control.</li><li>• It inputs the signals for driving status recognition (vehicle speed, reverse and parking brake).</li></ul>

### DTC Logic

INFOID:000000001315173

DTC	Display contents of CONSULT-III	DTC Detection Condition	Action to take
U121F	INTERNAL COMM [U121F]	Internal malfunction of AV control unit (internal communication error) is detected.	AV control unit power supply and ground circuit

### Diagnosis Procedure

INFOID:000000001315174

#### 1. CHECK AV CONTROL UNIT POWER SUPPLY AND GROUND CIRCUIT

Check audio control unit power supply and ground circuit. Refer to [AV-338, "AV CONTROL UNIT : Diagnosis Procedure"](#).

Is inspection result OK?

- YES >> INSPECTION END
- NO >> Repair malfunctioning parts.



# U1220 AV CONTROL UNIT

< COMPONENT DIAGNOSIS >

[BOSE AUDIO WITH NAVIGATION]

## U1220 AV CONTROL UNIT

### Description

INFOID:000000001278866

Refer to [AV-284, "System Description"](#).

### DTC Logic

INFOID:000000001278867

### DTC DETECTION LOGIC

DTC	CONSULT-III display	Detection condition	Action to take
U1220	XM SERIAL COMM [U1220]	An internal malfunction is detected in AV control unit (satellite radio tuner communication malfunction).	Replace AV control unit. Refer to <a href="#">AV-438, "Removal and Installation"</a> .

A  
B  
C  
D  
E  
F  
G  
H  
I  
J  
K  
L  
M  
O  
P

AV

# U1243 DISPLAY UNIT

< COMPONENT DIAGNOSIS >

[BOSE AUDIO WITH NAVIGATION]

## U1243 DISPLAY UNIT

### Description

INFOID:000000001315175

Part name	Description
DISPLAY UNIT	<ul style="list-style-type: none"> <li>• Display image is controlled by the serial communication from AV control unit.</li> <li>• RGB image signal is input from AV control unit (RGB, RGB area and RGB synchronizing). Auxiliary image signal is input from the auxiliary input jack. Camera image signal is input from the camera control unit.</li> <li>• Synchronize signal (HP, VP) is output to AV control unit.</li> <li>• Touch panel function can be operated for each system by touching a display directly.</li> </ul>

### DTC Logic

INFOID:000000001315176

DTC	Display contents of CONSULT-III	DTC Detection Condition	Possible causes
U1243	FRONT DISP CONN [U1243]	<ul style="list-style-type: none"> <li>• Display unit power supply and ground circuit malfunction is detected</li> <li>• Malfunction is detected on communication circuit between display unit and AV control unit</li> <li>• Malfunction is detected on communication signal between display unit and AV control unit</li> </ul>	<ul style="list-style-type: none"> <li>• Display unit power supply and ground circuit</li> <li>• Communication circuit between display unit and AV control unit</li> </ul>

### Diagnosis Procedure

INFOID:000000001315177

#### 1. CHECK DISPLAY UNIT POWER SUPPLY AND GROUND CIRCUIT

Check display unit power supply and ground circuit. Refer to [AV-339. "DISPLAY UNIT : Diagnosis Procedure"](#).

Is inspection result OK?

YES >> GO TO 2.

NO >> Repair malfunctioning parts.

#### 2. CHECK CONTINUITY COMMUNICATION CIRCUIT

1. Turn ignition switch OFF.
2. Disconnect display unit connector M93 and AV control unit connector M43.
3. Check continuity between display unit harness connector M93 (A) terminals 11, 22 and AV control unit harness connector M43 (B) terminals 30, 31.

A		B		Continuity
Connector	Terminal	Connector	Terminal	
M93	11	M43	30	Yes
	22		31	

4. Check continuity between display unit harness connector M93 (A) terminals 11, 22 and ground.

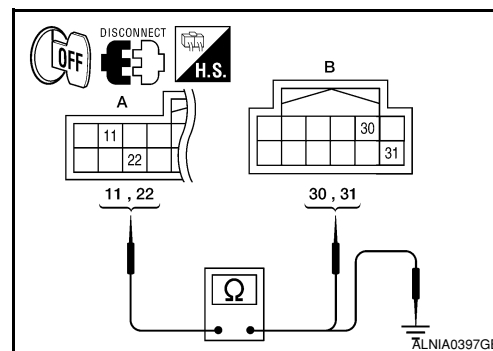

A		—	Continuity
Connector	Terminal		
M93	11	Ground	No
	22		

Are continuity results as specified?

YES >> GO TO 3.

NO >> Repair harness or connector.

# U1243 DISPLAY UNIT

< COMPONENT DIAGNOSIS >

[BOSE AUDIO WITH NAVIGATION]

## 3. CHECK COMMUNICATION SIGNAL

1. Connect display unit connector M93 and AV control unit connector M43.
2. Turn ignition switch ON.
3. Check signal between display unit harness connector M93 terminal 11 and ground.

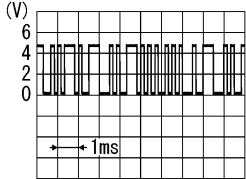
Connector	Terminals		Reference Signal
	(+)	(-)	
M93	11	Ground	 <p>PKIB5039J</p>

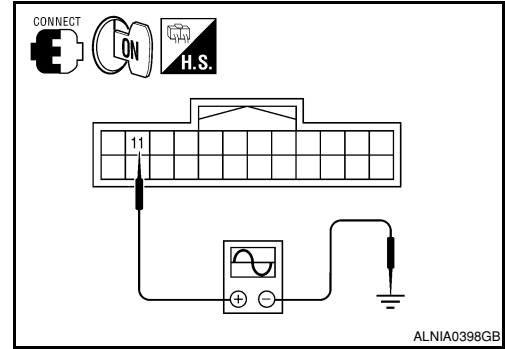

Are voltage readings as specified?

YES >> GO TO 4.

NO >> Replace AV control unit. Refer to [AV-438, "Removal and Installation"](#)

## 4. CHECK COMMUNICATION SIGNAL

Check signal between display unit harness connector M93 terminal 22 and ground.

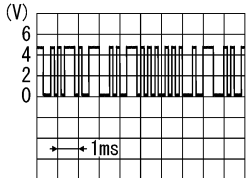
Connector	Terminals		Reference Signal
	(+)	(-)	
M93	22	Ground	 <p>PKIB5039J</p>

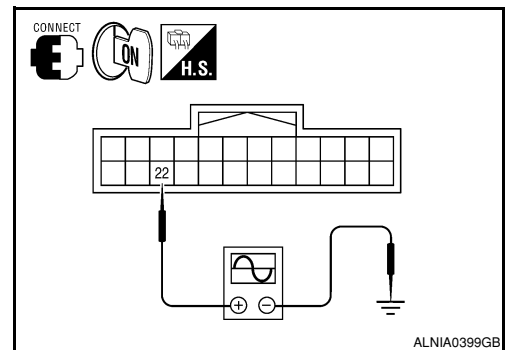

Are voltage readings as specified?

YES >> INSPECTION END

NO >> Replace display unit. Refer to [AV-439, "Removal and Installation"](#)

A  
B  
C  
D  
E  
F  
G  
H  
I  
J  
K  
L  
M  
O  
P

AV

# U1244 GPS ANTENNA

< COMPONENT DIAGNOSIS >

[BOSE AUDIO WITH NAVIGATION]

## U1244 GPS ANTENNA

### Description

INFOID:000000001278868

Refer to [AV-288. "System Description"](#).

### DTC Logic

INFOID:000000001278869

### DTC DETECTION LOGIC

DTC	CONSULT-III display	Detection condition
U1244	GPS ANTENNA CONN [U1244]	GPS antenna connection malfunction is detected.

### Diagnosis Procedure

INFOID:000000001278870

#### 1. GPS ANTENNA CHECK

Inspect GPS antenna and antenna feeder for damage or poor connection.

Is the GPS antenna and feeder clean and undamaged?

- YES >> GO TO 2
- NO >> Repair or replace malfunctioning parts.

#### 2. CHECK AV CONTROL UNIT VOLTAGE

1. Turn ignition switch ON.
2. Check voltage between AV control unit connector M124 terminal 116 and ground.

**116 - Ground : Approx. 5V**

Is the voltage reading as specified?

- YES >> Replace GPS antenna. Refer to [AV-453. "Removal and Installation"](#).
- NO >> Replace AV control unit. Refer to [AV-438. "Removal and Installation"](#).

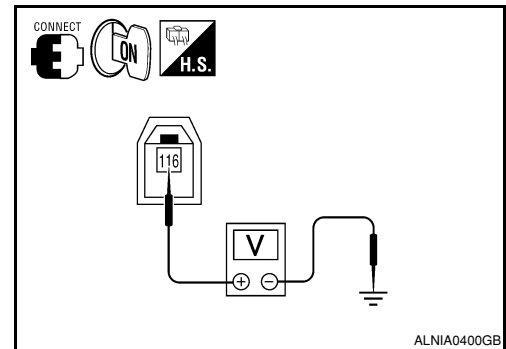

# U1250 CAMERA CONTROL UNIT

< COMPONENT DIAGNOSIS >

[BOSE AUDIO WITH NAVIGATION]

## U1250 CAMERA CONTROL UNIT

### Description

INFOID:000000001315178

Part name	Description
CAMERA CONTROL UNIT	<ul style="list-style-type: none"> <li>• Camera image signal is input from rear view camera, and camera image is indicated on the display.</li> <li>• Power (camera ON signal) is sent to rear view camera.</li> <li>• Controlled by audio communication sent from AV control unit.</li> <li>• AV control unit recognizes the presence of camera system with camera connection recognition signal.</li> </ul>

### DTC Logic

INFOID:000000001315179

DTC	Display contents of CONSULT-III	DTC Detection Condition	Possible causes
U1250	CAMERA CONT. CONN [U1250]	A malfunction is detected in camera-connection recognition signal circuit	Camera-connection recognition signal circuit

### Diagnosis Procedure

INFOID:000000001315180

#### 1. CHECK CAMERA-CONNECTION RECOGNITION SIGNAL CIRCUIT

1. Disconnect AV control unit connector and camera control unit connector.
2. Check continuity between AV control unit harness connector M45 (A) terminal 84 and camera control unit harness connector B73 (B) terminal 5.

A		B		Continuity
Connector	Terminal	Connector	Terminal	
M45	84	B73	5	Yes

3. Check continuity between AV control unit harness connector M45 (A) terminal 84 and ground.

A		—	Continuity
Connector	Terminal		
M45	84	Ground	No

Are the continuity results as specified?

YES >> GO TO 2.

NO >> Repair harness or connector.

#### 2. CHECK AV CONTROL UNIT VOLTAGE

1. Connect AV control unit connector.
2. Turn ignition switch ON.
3. Check voltage between AV control unit harness connector M45 terminal 84 and ground.

Connector	Terminals		Voltage
	(+)	(-)	
M45	84	Ground	Approx. 5V

Is voltage approximately 5 volts?

YES >> Replace camera control unit. Refer to [AV-456, "Removal and Installation"](#)

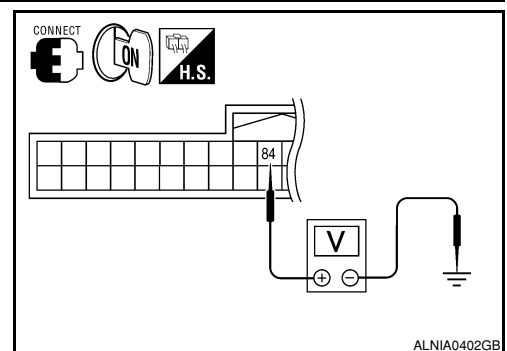
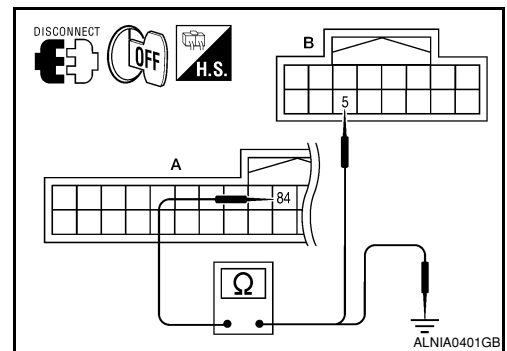

A

B

C

D

E

F

G

H

I

J

K

L

M

AV

O

P

## U1250 CAMERA CONTROL UNIT

< COMPONENT DIAGNOSIS >

[BOSE AUDIO WITH NAVIGATION]

---

NO >> Replace AV control unit. Refer to [AV-438. "Removal and Installation"](#).

# U1258 SATELLITE RADIO ANTENNA

< COMPONENT DIAGNOSIS >

[BOSE AUDIO WITH NAVIGATION]

## U1258 SATELLITE RADIO ANTENNA

### Description

INFOID:000000001315181

Part name	Description
SATELLITE RADIO ANTENNA	Satellite radio signal is received and sent to audio control unit.

### DTC Logic

INFOID:000000001315182

DTC	Display contents of CONSULT-III	DTC Detection Condition	Possible causes
U1258	XM ANETNNA CONN [U1258]	Satellite radio antenna connection malfunction is detected	Satellite radio antenna disconnection

### Diagnosis Procedure

INFOID:000000001315183

#### 1. SATELLITE RADIO ANTENNA CHECK

Visually check satellite radio antenna and antenna feeder.

Is inspection result OK?

YES >> GO TO 2.

NO >> Repair malfunctioning parts.

#### 2. CHECK AV CONTROL UNIT VOLTAGE

1. Disconnect AV control unit connector M125.
2. Turn ignition switch ON.
3. Check voltage between AV control unit connector M125 terminal 118 and ground.

**118 - Ground : Approx. 5 V**

Is voltage approximately 5 volts?

YES >> INSPECTION END

NO >> Replace AV control unit. Refer to [AV-438. "Removal and Installation"](#)

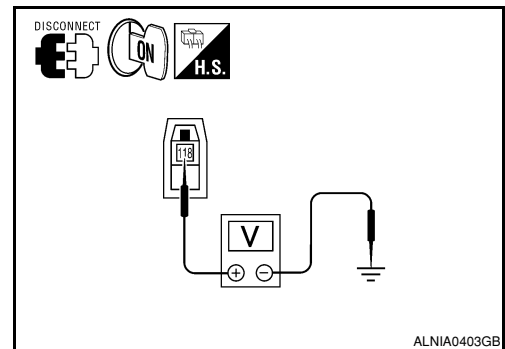

A  
B  
C  
D  
E  
F  
G  
H  
I  
J  
K  
L  
M  
O  
P

AV

# U1300 AV COMM CIRCUIT

< COMPONENT DIAGNOSIS >

[BOSE AUDIO WITH NAVIGATION]

## U1300 AV COMM CIRCUIT

### Description

INFOID:000000001348323

U1300 is indicated when malfunction occurs in communication signal of multi AV system. Indicated simultaneously, without fail, with the malfunction of control units connected to AV control unit with communication line. Determine the possible malfunction cause from the table below.

### Self-diagnosis results display item

DTC	Display contents of CONSULT-III	DTC Detection Condition	Possible causes
U1300	• AV COMM CIRCUIT [U1300]	When AV control unit is not transmitting or receiving AV communication signal for 2 seconds or more.	AV communication system



# U1310 AV CONTROL UNIT

< COMPONENT DIAGNOSIS >

[BOSE AUDIO WITH NAVIGATION]

## U1310 AV CONTROL UNIT

### Description

INFOID:000000001348317

Replace the AV control unit if this DTC is displayed. Refer to [AV-438, "Removal and Installation"](#).

Part name	Description
AV CONTROL UNIT	<ul style="list-style-type: none"><li>• It is the master unit of the MULTI AV system and it is connected to each control unit by means of communication. It operates each system according to communication signals from the AV control unit.</li><li>• AV control unit includes audio function and vehicle information function.</li><li>• It is connected to ECM and combination meter via CAN communication to obtain necessary information for the vehicle information function.</li><li>• It inputs the automatic brightness ON/OFF signals that are required for the display dimming control.</li><li>• It inputs the signals for driving status recognition (vehicle speed, reverse and parking brake).</li></ul>

### DTC Logic

INFOID:000000001348318

DTC	Display contents of CONSULT-III	DTC Detection Condition	Action to take
U1310	CONTROL UNIT (AV) [U1310]	An initial diagnosis error is detected in AV communication circuit.	Replace AV control unit. Refer to <a href="#">AV-104, "Removal and Installation"</a>

A  
B  
C  
D  
E  
F  
G  
H  
I  
J  
K  
L  
M  
O  
P

AV

# POWER SUPPLY AND GROUND CIRCUIT

< COMPONENT DIAGNOSIS >

[BOSE AUDIO WITH NAVIGATION]

## POWER SUPPLY AND GROUND CIRCUIT

### AV CONTROL UNIT

#### AV CONTROL UNIT : Diagnosis Procedure

INFOID:000000001317799

### 1. CHECK FUSES

Check that the following AV control unit fuses are not blown.

Unit	Terminals	Signal name	Fuse No.
AV control unit	19	Battery power	31
	7	Ignition switch ACC or ON	4
	79	Ignition switch ON or START	12

Are the fuses OK?

YES >> GO TO 2

NO >> If fuse is blown, be sure to eliminate cause of malfunction before installing new fuse.

### 2. POWER SUPPLY CIRCUIT CHECK

1. Disconnect AV control unit connectors M42 and M45.
2. Check voltage between the AV control unit connectors M42 and M45 and ground.

Connector	(+)		(-)	OFF	ACC	ON	START
	Terminal						
M42	7	Ground	0V	Battery voltage	Battery voltage	0V	0V
	19	Ground	Battery voltage	Battery voltage	Battery voltage	0V	0V
M45	79	Ground	0V	0V	Battery voltage	Battery voltage	

Are the voltage results as specified?

YES >> GO TO 3

- NO >>
- Check connector housings for disconnected or loose terminals.
  - Repair harness or connector.

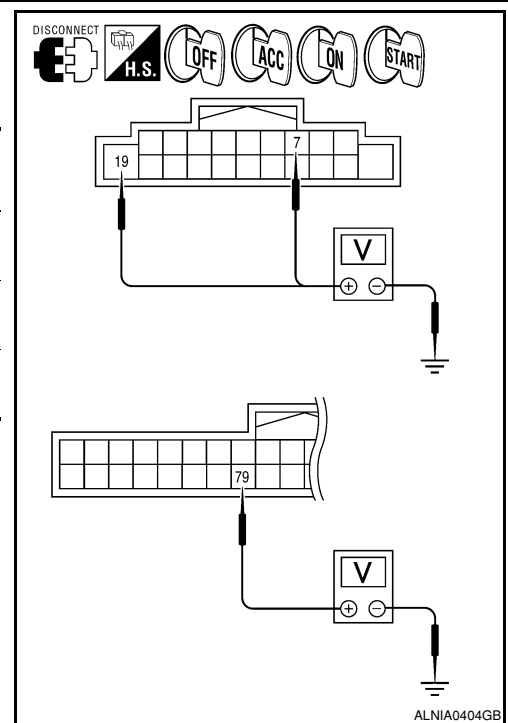

### 3. GROUND CIRCUIT CHECK

# POWER SUPPLY AND GROUND CIRCUIT

[BOSE AUDIO WITH NAVIGATION]

## < COMPONENT DIAGNOSIS >

1. Ignition OFF.
2. Check continuity between AV control unit harness connectors M42 and M45 and ground.

Connector	(+)	(-)	Continuity
	Terminal		
M42	20	Ground	Yes
M45	65		
	66		

Are the continuity results as specified?

- YES >> Inspection End.  
 NO >> Repair AV control unit ground.

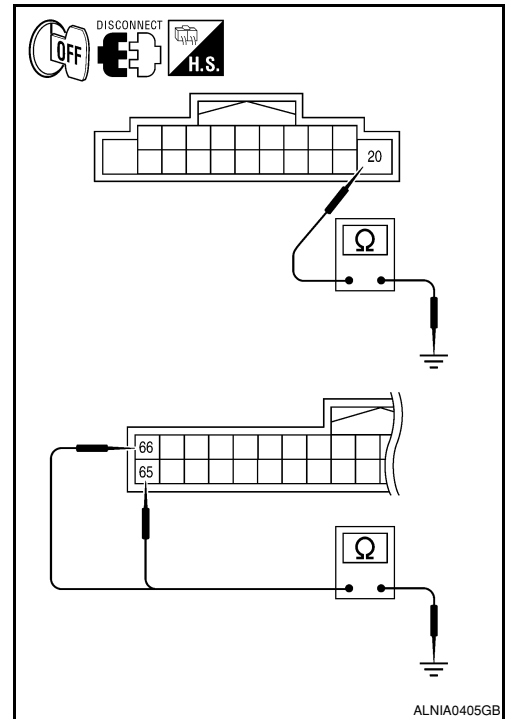

## DISPLAY UNIT

### DISPLAY UNIT : Diagnosis Procedure

INFOID:000000001317800

#### 1. CHECK POWER SUPPLY CIRCUIT

1. Turn ignition switch to ACC
2. Check voltage between display unit harness connector M93 and ground.

Signal name	Connector No.	Terminal No.	Ignition switch position	Value (Approx.)
B+	M93	2	ACC	9 V
ACC		3		

Does specified voltage exist?

- YES >> GO TO 3.  
 NO >> GO TO 2.

#### 2. CHECK POWER SUPPLY CIRCUIT

1. Turn ignition switch OFF.
2. Disconnect the display unit connector M93 and the AV control unit connector M45.
3. Check continuity between the display unit harness connector M93 (A) and the AV control unit connector M45 (B).

A		B		Continuity
Connector	Terminal	Connector	Terminal	
M93	2	M45	66	Yes
	3		69	

Does continuity exist?

- YES >> Check AV control unit power and ground supply. Refer to [AV-338. "AV CONTROL UNIT : Diagnosis Procedure"](#)  
 NO >> Repair harness or connector.

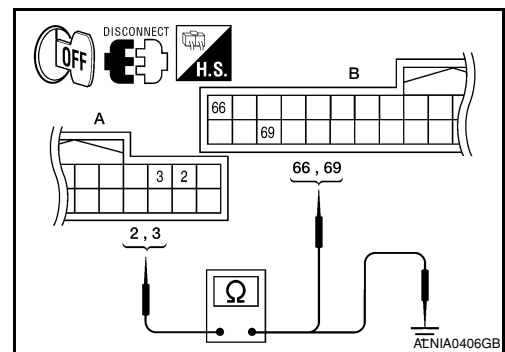
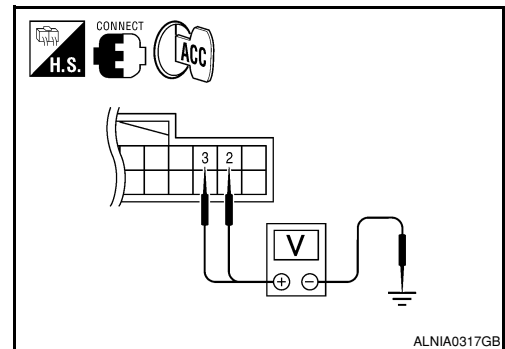

A  
B  
C  
D  
E  
F  
G  
H  
I  
J  
K  
L  
M  
O  
P

AV

# POWER SUPPLY AND GROUND CIRCUIT

< COMPONENT DIAGNOSIS >

[BOSE AUDIO WITH NAVIGATION]

## 3. CHECK GROUND CIRCUIT

1. Turn ignition switch OFF.
2. Disconnect display unit connector.
3. Check continuity between display unit harness connector M93 and ground.

(+)		(-)	Continuity
Connector	Terminal		
M93	1	Ground	Yes
	13		

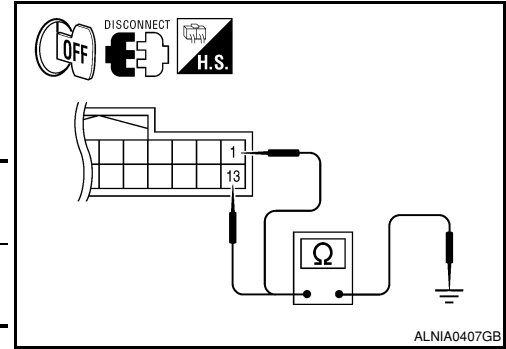

Does continuity exist?

- YES >> INSPECTION END  
 NO >> Repair harness or connector.

## A/C AND AV SWITCH ASSEMBLY

### A/C AND AV SWITCH ASSEMBLY : Diagnosis Procedure

INFOID:000000001317801

## 1. CHECK FUSE

Check that the A/C and AV switch assembly fuse is not blown.

Unit	Terminal	Signal name	Fuse No.
A/C and AV switch assembly	2	Ignition switch ACC or ON	4

Is the fuse OK?

- YES >> GO TO 2  
 NO >> If fuse is blown, be sure to eliminate cause of malfunction before installing new fuse.

## 2. POWER SUPPLY CIRCUIT CHECK

1. Disconnect A/C and AV switch assembly connector M98.
2. Check voltage between the A/C and AV switch assembly connector M98 and ground.

(+)		(-)	OFF	ACC	ON
Connector	Terminal				
M98	2	Ground	0V	Battery voltage	Battery voltage

Are the voltage results as specified?

- YES >> GO TO 3  
 NO >> • Check connector housings for disconnected or loose terminals.  
 • Repair harness or connector.

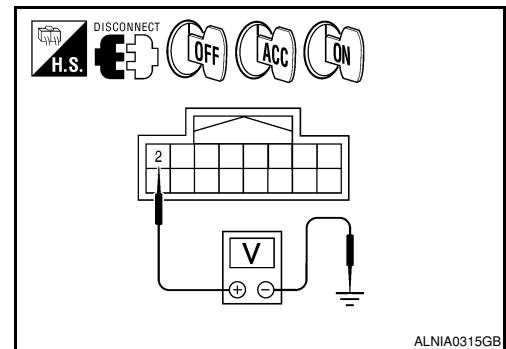

## 3. GROUND CIRCUIT CHECK

1. Ignition OFF.
2. Check continuity between A/C and AV switch assembly harness connector M98 and ground.

(+)		(-)	Continuity
Connector	Terminal		
M98	1	Ground	Yes

Are the continuity results as specified?

- YES >> Inspection End.  
 NO >> Repair A/C and AV switch assembly ground.

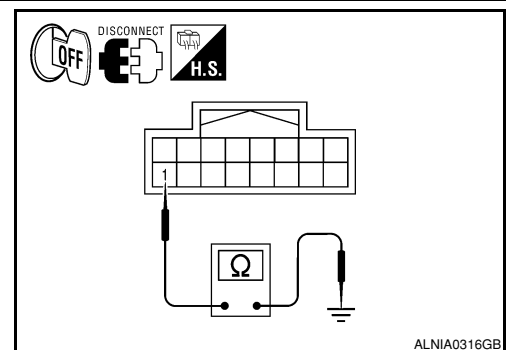

# POWER SUPPLY AND GROUND CIRCUIT

[BOSE AUDIO WITH NAVIGATION]

< COMPONENT DIAGNOSIS >

## BOSE SPEAKER AMP

### BOSE SPEAKER AMP : Diagnosis Procedure

INFOID:000000001317802

#### 1.CHECK FUSE

Check that the BOSE speaker amp. fuse is not blown.

Unit	Terminal	Signal name	Fuse No.
BOSE speaker amp.	11	Battery power	31

Are the fuses OK?

YES >> GO TO 2

NO >> Be sure to eliminate cause of malfunction before installing new fuse.

#### 2.CHECK POWER SUPPLY CIRCUIT

1. Turn ignition switch OFF.
2. Disconnect BOSE speaker amp. connector.
3. Check voltage between BOSE speaker amp. harness connector M112 terminal 11 and ground.

(+)		(-)	Voltage (approx.)
Connector	Terminal		
M112	11	Ground	Battery voltage

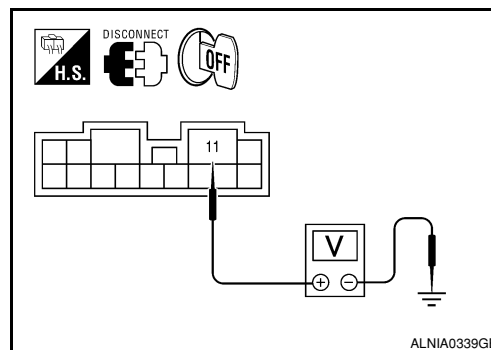

Is battery voltage present?

YES >> GO TO 3

NO >> Check harness between BOSE speaker amp. and fuse.

#### 3.CHECK GROUND CIRCUIT

1. Turn ignition switch OFF.
2. Disconnect BOSE speaker amp. connector.
3. Check continuity between BOSE speaker amp. harness connector M112 terminal 12 and ground.

(+)		(-)	Continuity
Connector	Terminal		
M112	12	Ground	Yes

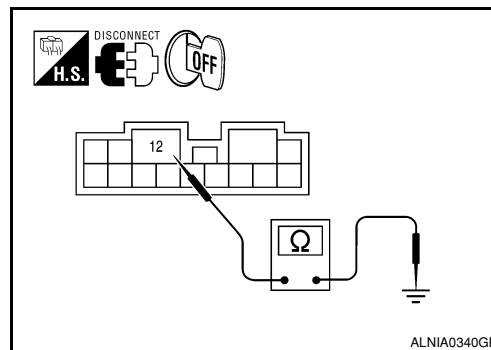

Does continuity exist?

YES >> Inspection End.

NO >> Repair harness or connector.

## WOOFER

### WOOFER : Diagnosis Procedure

INFOID:000000001317803

#### 1.CHECK FUSE

Check that the subwoofer fuse is not blown.

Unit	Terminal	Signal name	Fuse No.
Subwoofer	6	Battery power	17

Is the fuse OK?

YES >> GO TO 2

NO >> Be sure to eliminate cause of malfunction before installing new fuse.

#### 2.CHECK POWER SUPPLY CIRCUIT

A  
B  
C  
D  
E  
F  
G  
H  
I  
J  
K  
L  
M  
O  
P

AV

# POWER SUPPLY AND GROUND CIRCUIT

[BOSE AUDIO WITH NAVIGATION]

## < COMPONENT DIAGNOSIS >

1. Turn ignition switch OFF.
2. Disconnect subwoofer connector.
3. Check voltage between subwoofer harness connector B72 terminal 6 and ground.

(+)		(-)	Voltage (approx.)
Connector	Terminal		
B72	6	Ground	Battery voltage

Is battery voltage present?

YES >> GO TO 3

NO >> Check harness between subwoofer and fuse.

### 3.CHECK GROUND CIRCUIT

1. Turn ignition switch OFF.
2. Check continuity between subwoofer harness connector B72 terminal 5 and ground.

(+)		(-)	Continuity
Connector	Terminal		
B72	5	Ground	Yes

Does continuity exist?

YES >> Inspection End.

NO >> Repair harness or connector.

## REAR VIEW CAMERA CONTROL UNIT

### REAR VIEW CAMERA CONTROL UNIT : Diagnosis Procedure

INFOID:000000001317805

### 1.CHECK FUSE

Check that the following fuses of the rear view camera control unit are not blown.

Unit	Terminals	Signal name	Fuse No.
Rear view camera control unit	1	Battery power	31
	2	Ignition switch ACC or ON	4

Are the fuses OK?

YES >> GO TO 2

NO >> Be sure to eliminate cause of malfunction before installing new fuse.

### 2.CHECK POWER SUPPLY CIRCUIT

Check voltage between rear view camera control unit harness connector B73 and ground.

Signal name	Connector No.	Terminal No.	Ignition switch position	Value (Approx.)
Battery power supply	B73	1	OFF	Battery voltage
ACC power supply		2	ACC	

Are the voltage readings as specified?

YES >> GO TO 3

NO >> Check harness between rear view camera control unit and fuse.

### 3.CHECK GROUND CIRCUIT

1. Turn ignition switch OFF.
2. Disconnect rear view camera control unit connector.

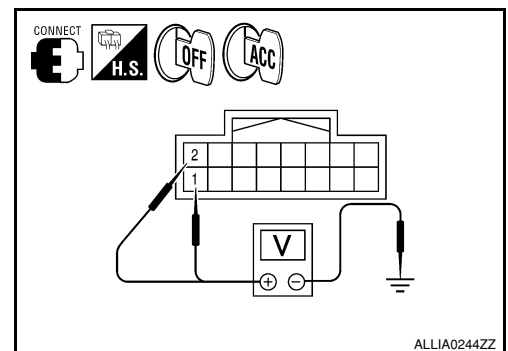
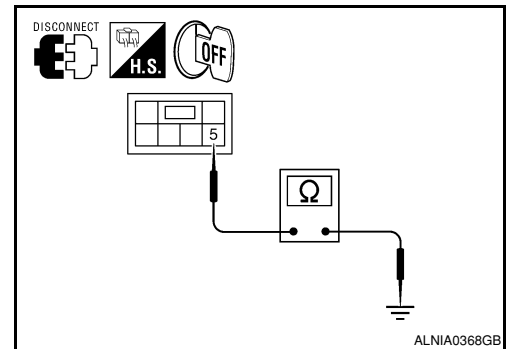
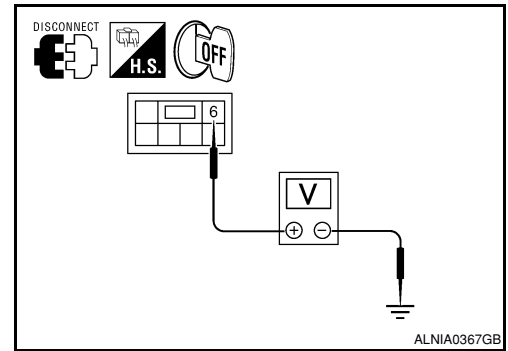

# POWER SUPPLY AND GROUND CIRCUIT

[BOSE AUDIO WITH NAVIGATION]

## < COMPONENT DIAGNOSIS >

- Check continuity between rear view camera control unit harness connector B31 terminal 3 and ground.

(+)		(-)	Continuity
Connector	Terminal		
B31	3	Ground	Yes

Does continuity exist?

- YES >> Inspection End.  
 NO >> Repair harness or connector.

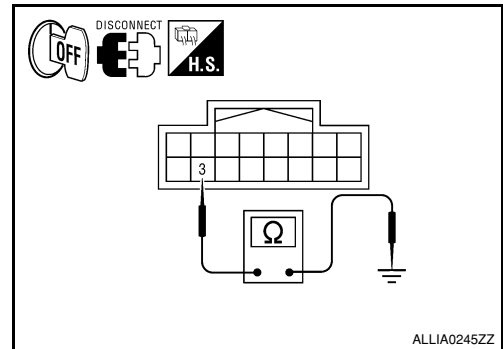

ALLIA0245ZZ

## REAR VIEW CAMERA

### REAR VIEW CAMERA : Diagnosis Procedure

INFOID:000000001317806

#### 1. CHECK POWER SUPPLY CIRCUIT (REAR VIEW CAMERA SIDE)

Check voltage between rear view camera harness connector D504 and ground.

Signal name	Connector No.	Terminal No.	Transmission position	Value (Approx.)
Camera ON signal	D504	1	Reverse	6V

Is voltage reading approximately 6 volts?

- YES >> GO TO 4  
 NO >> GO TO 2

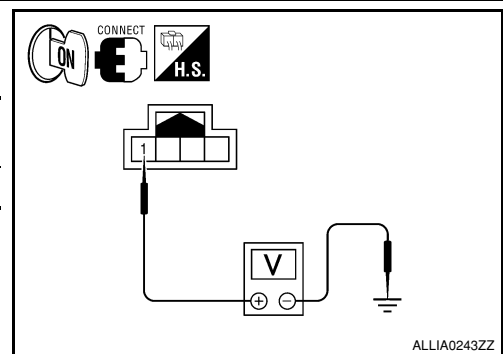

ALLIA0243ZZ

#### 2. CHECK POWER SUPPLY CIRCUIT (CONTINUITY)

- Turn ignition switch OFF.
- Disconnect rear view camera and rear view camera control unit connectors.
- Check continuity between rear view camera harness connector D504 (A) terminal 1 and rear view camera control unit harness connector B73 (B) terminal 8.

A		B		Continuity
Connector	Terminal	Connector	Terminal	
D504	1	B73	8	Yes

- Check continuity between rear view camera harness connector D504 (A) terminal 1 and ground.

A		—	Continuity
Connector	Terminal		
D504	1	Ground	No

Are continuity test results as specified?

- YES >> GO TO 3  
 NO >> Repair harness or connector.

#### 3. CHECK POWER SUPPLY CIRCUIT (REAR VIEW CAMERA CONTROL UNIT SIDE)

- Connect rear view camera control unit harness connector.
- Turn ignition switch ON.

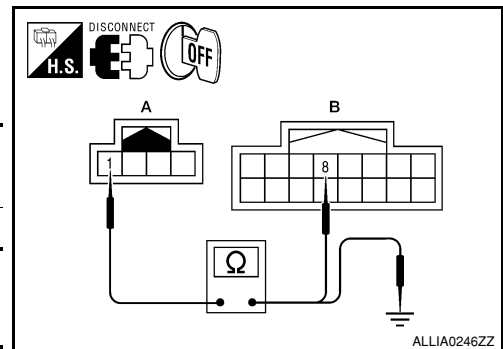

ALLIA0246ZZ

A  
B  
C  
D  
E  
F  
G  
H  
I  
J  
K  
L  
M  
N  
O  
P

AV

# POWER SUPPLY AND GROUND CIRCUIT

[BOSE AUDIO WITH NAVIGATION]

## < COMPONENT DIAGNOSIS >

- Check voltage between rear view camera control unit harness connector B73 and ground.

Signal name	Connector No.	Terminal No.	Transmission position	Value (Approx.)
Camera ON signal	B73	8	Reverse	6V

Is voltage reading approximately 6 volts?

- YES >> Inspection End.  
 NO >> Replace rear view camera control unit. Refer to [AV-456](#).  
 "Removal and Installation".

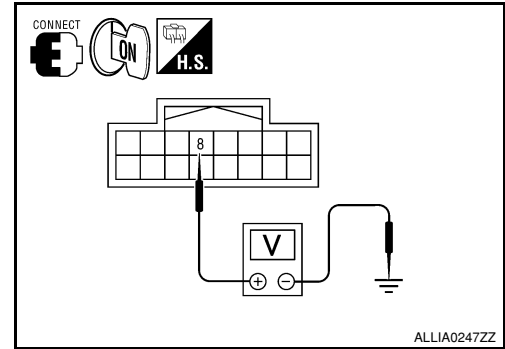

ALLIA0247ZZ

## 4.CHECK GROUND CIRCUIT

- Turn ignition switch OFF.
- Disconnect rear view camera harness connector.
- Check continuity between rear view camera harness connector D504 terminal 2 and ground.

Signal name	Continuity
Ground	Yes

Does continuity exist?

- YES >> Inspection End.  
 NO >> Repair harness or connector.

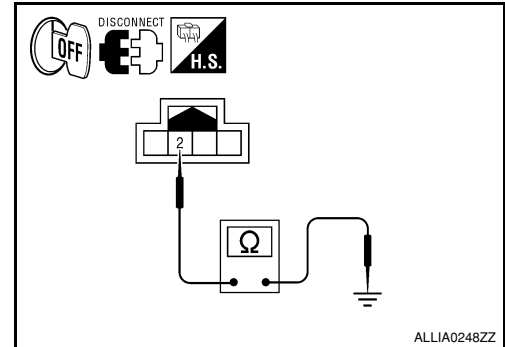

ALLIA0248ZZ

## DVD PLAYER

### DVD PLAYER : Diagnosis Procedure

INFOID:000000001317807

## 1.CHECK FUSE

Check that the DVD player fuse is not blown.

Unit	Terminal	Signal name	Fuse No.
DVD player	21	Battery power	31
	24	Ignition switch ACC or ON	4

Is the fuse OK?

- YES >> GO TO 2  
 NO >> If fuse is blown, be sure to eliminate cause of malfunction before installing new fuse.

## 2.POWER SUPPLY CIRCUIT CHECK

- Disconnect DVD player connector M205.
- Check voltage between the DVD player connector M205 and ground.

(+) Connector		Terminal	(-)	OFF	ACC	ON
M205	21			Ground	Batter voltage	Battery voltage
	24	0V	Battery voltage		Battery voltage	

Are the voltage results as specified?

- YES >> GO TO 3  
 NO >> • Check connector housings for disconnected or loose terminals.  
 • Repair harness or connector.

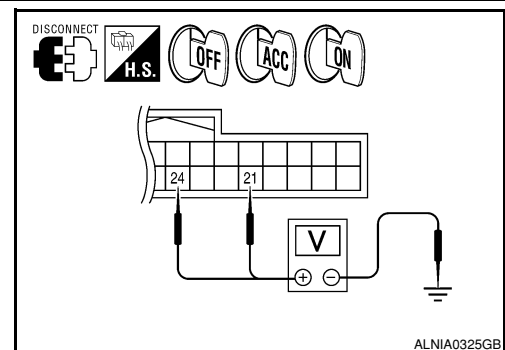

ALLNIA0325GB



# POWER SUPPLY AND GROUND CIRCUIT

[BOSE AUDIO WITH NAVIGATION]

< COMPONENT DIAGNOSIS >

## 3. GROUND CIRCUIT CHECK

1. Ignition OFF.
2. Check continuity between DVD player harness connector M205 terminal 5 and ground.

(+)		(-)	Continuity
Connector	Terminal		
M205	5	Ground	Yes

Are the continuity results as specified?

- YES >> Inspection End.  
 NO >> Repair DVD player ground.

## VIDEO MONITOR

### VIDEO MONITOR : Diagnosis Procedure

INFOID:000000001317808

#### 1. CHECK POWER SUPPLY CIRCUIT

Check voltage between video monitor harness connector R202 and ground.

Signal name	Connector No.	Terminal No.	Ignition switch position	Value (Approx.)
Display B+	R202	11	ACC	12V
		12		

Does specified voltage exist?

- YES >> GO TO 3.  
 NO >> GO TO 2.

#### 2. CHECK POWER SUPPLY CIRCUIT

1. Turn ignition switch OFF.
2. Disconnect the video monitor connector R202 and the DVD player connector M205.
3. Check continuity between the video monitor harness connector R202 (A) and the DVD player connector M205 (B).

A		B		Continuity
Connector	Terminal	Connector	Terminal	
R202	11	M205	9	Yes
	12		25	

4. Check continuity between video monitor harness connector R202 (A) and ground.

A		-	Continuity
Connector	Terminal		
R202	11	Ground	No
	12		

Are continuity test results as specified?

- YES >> Check DVD player power and ground supply. Refer to [AV-338. "AV CONTROL UNIT : Diagnosis Procedure"](#)  
 NO >> Repair harness or connector.

#### 3. CHECK GROUND CIRCUIT

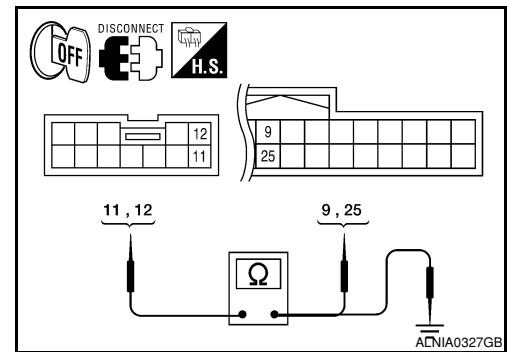
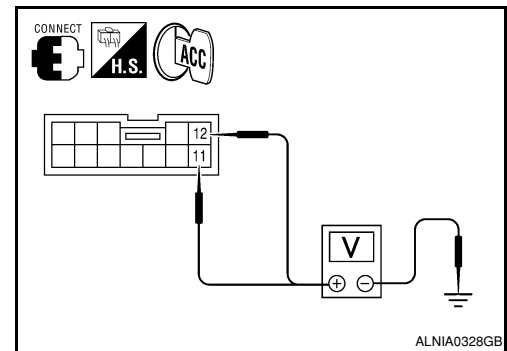
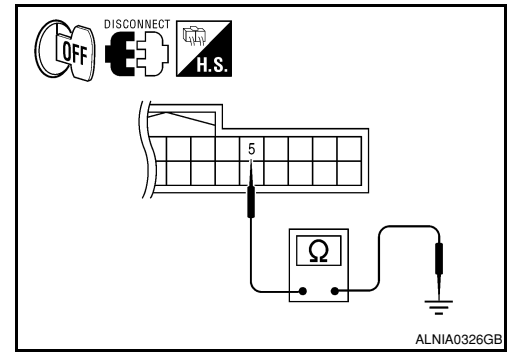

A  
B  
C  
D  
E  
F  
G  
H  
I  
J  
K  
L  
M  
AV  
O  
P

# POWER SUPPLY AND GROUND CIRCUIT

[BOSE AUDIO WITH NAVIGATION]

## < COMPONENT DIAGNOSIS >

1. Turn ignition switch OFF.
2. Disconnect video monitor connector.
3. Check continuity between video monitor harness connector R202 and ground.

Connector No.	Terminal No.	Ignition switch position	Continuity
R202	1	OFF	Yes
	2		

Does continuity exist?

- YES >> INSPECTION END  
 NO >> Repair harness or connector.

## MICROPHONE

### MICROPHONE : Diagnosis Procedure

INFOID:000000001317810

#### 1. CHECK POWER SUPPLY CIRCUIT

Check voltage between microphone harness connector R109 terminal 4 and ground.

Signal name	Connector No.	Terminal No.	Ignition switch position	Value (Approx.)
MIC power	R109	4	ON	5V

Is approximately 5V present?

- YES >> GO TO 3  
 NO >> GO TO 2

#### 2. CHECK POWER SUPPLY CIRCUIT (CONTINUITY)

1. Turn ignition switch OFF.
2. Disconnect microphone and AV control unit harness connectors.
3. Check continuity between microphone harness connector R109 (A) terminal 4 and AV control unit harness connector M45 (B) terminal 70.

A		B		Continuity
Connector	Terminal	Connector	Terminal	
R109	4	M45	70	Yes

4. Check continuity between microphone harness connector R109 (A) terminal 4 and ground.

A		—	Continuity
Connector	Terminal		
R109	4	Ground	No

Are the continuity test results as specified?

- YES >> Replace the AV control unit. Refer to [AV-438. "Removal and Installation"](#)  
 NO >> Repair harness or connector.

#### 3. CHECK GROUND CIRCUIT

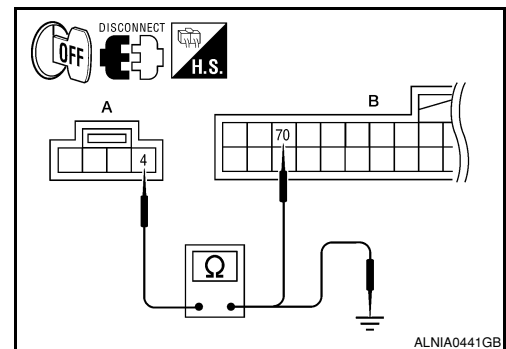
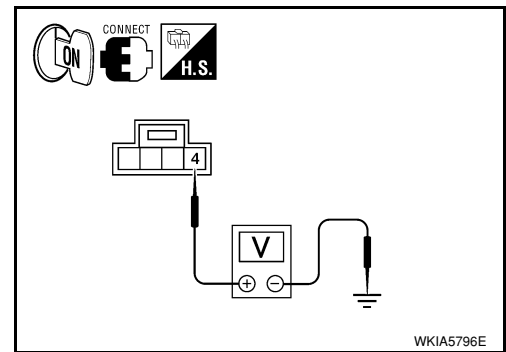
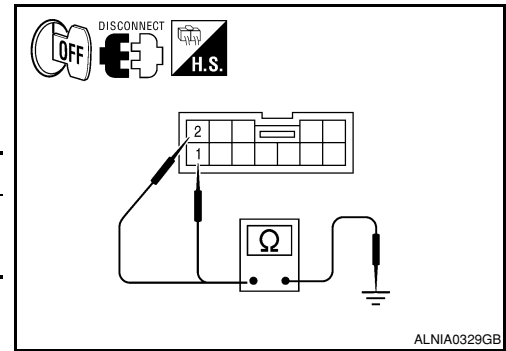

# POWER SUPPLY AND GROUND CIRCUIT

[BOSE AUDIO WITH NAVIGATION]

## < COMPONENT DIAGNOSIS >

1. Turn ignition switch OFF.
2. Disconnect microphone harness connector R109 and AV control unit harness connector M45.
3. Check continuity between microphone harness connector R109 (A) terminal 2 and AV control unit harness connector M45 (B) terminal 71.

A		B		Continuity
Connector	Terminal	Connector	Terminal	
R109	2	M45	71	Yes

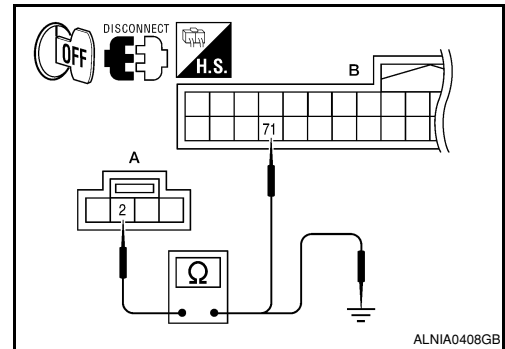

### Does continuity exist?

- YES >> Inspection End.  
NO >> Repair harness or connector.

A  
B  
C  
D  
E  
F  
G  
H  
I  
J  
K  
L  
M

AV

O  
P

# RGB (R: RED) SIGNAL CIRCUIT

< COMPONENT DIAGNOSIS >

[BOSE AUDIO WITH NAVIGATION]

## RGB (R: RED) SIGNAL CIRCUIT

### Description

INFOID:000000001329005

Transmit the image displayed with audio control unit with RGB signal to the display unit.

### Diagnosis Procedure

INFOID:000000001329006

#### 1. CHECK CONTINUITY RGB (R: RED) SIGNAL CIRCUIT

1. Turn ignition switch OFF.
2. Disconnect display unit connector M93 and AV control unit connector M43.
3. Check continuity between display unit harness connector M93 (A) terminal 17 and AV control unit harness connector M43 (B) terminal 21.

A		B		Continuity
Connector	Terminal	Connector	Terminal	
M93	17	M43	21	Yes

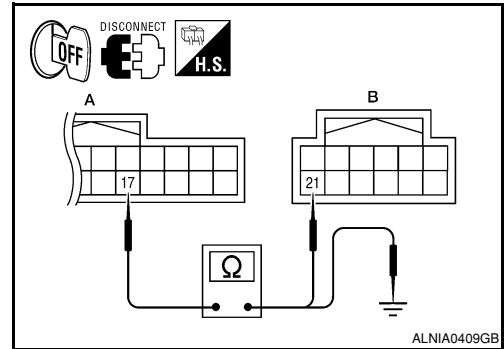

4. Check continuity between display unit harness connector M93 (A) terminal 17 and ground.

A		—	Continuity
Connector	Terminal		
M93	17	Ground	No

Are the continuity results as specified?

- YES >> GO TO 2.  
 NO >> Repair harness or connector.

#### 2. CHECK RGB (R: RED) SIGNAL

1. Connect display unit connector M93 and AV control unit connector M43.
2. Turn ignition switch ON.
3. Check signal between display unit harness connector M93 terminal 17 and ground.

(+) Connector		(-)	Condition	Reference signal
Connector	Terminal			
M93	17	Ground	Receive audio signal	<p>SK1B2238J</p>

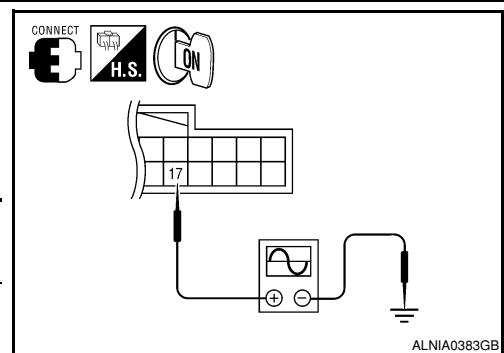

Are the voltage readings as specified?

- YES >> Replace display unit. Refer to [AV-106, "Removal and Installation"](#)  
 NO >> Replace AV control unit. Refer to [AV-104, "Removal and Installation"](#)

# RGB (G: GREEN) SIGNAL CIRCUIT

< COMPONENT DIAGNOSIS >

[BOSE AUDIO WITH NAVIGATION]

## RGB (G: GREEN) SIGNAL CIRCUIT

### Description

INFOID:000000001329007

Transmit the image displayed with AV control unit with RGB signal to the display unit.

### Diagnosis Procedure

INFOID:000000001329008

#### 1. CHECK CONTINUITY RGB (G: GREEN) SIGNAL CIRCUIT

1. Turn ignition switch OFF.
2. Disconnect display unit connector M93 and AV control unit connector M43.
3. Check continuity between display unit harness connector M93 (A) terminal 6 and AV control unit harness connector M43 (B) terminal 22.

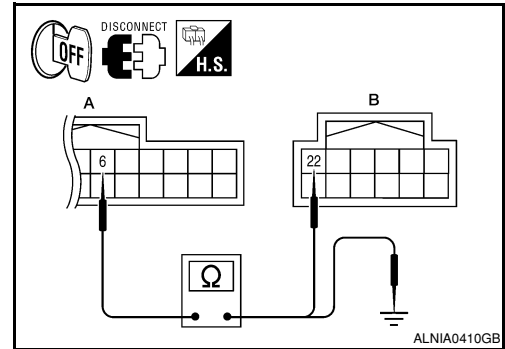

A		B		Continuity
Connector	Terminal	Connector	Terminal	
M93	6	M43	22	Yes

4. Check continuity between display unit harness connector M93 (A) terminal 6 and ground.

A		—	Continuity
Connector	Terminal		
M93	6	Ground	No

Are the continuity results as specified?

YES >> GO TO 2.

NO >> Repair harness or connector.

#### 2. CHECK RGB (G: GREEN) SIGNAL

1. Connect display unit connector M93 and AV control unit connector M43.
2. Turn ignition switch ON.
3. Check signal between display unit harness connector M93 terminal 6 and ground.

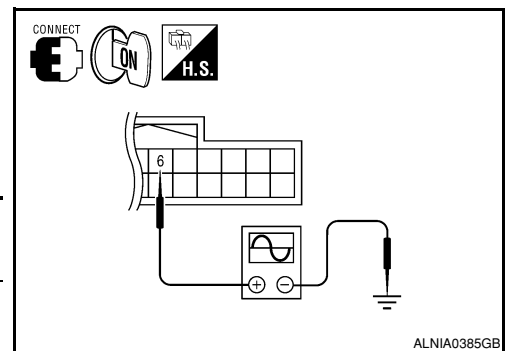

(+) Connector		(-) Terminal	Condition	Reference signal
Connector	Terminal	Terminal		
M93	6	Ground	Receive audio signal	<p>SKIB2236J</p>

Are voltage readings as specified?

YES >> Replace display unit. Refer to [AV-106, "Removal and Installation"](#)

NO >> Replace AV control unit. Refer to [AV-104, "Removal and Installation"](#)

A  
B  
C  
D  
E  
F  
G  
H  
I  
J  
K  
L  
M  
AV  
O  
P

# RGB (B: BLUE) SIGNAL CIRCUIT

< COMPONENT DIAGNOSIS >

[BOSE AUDIO WITH NAVIGATION]

## RGB (B: BLUE) SIGNAL CIRCUIT

### Description

INFOID:000000001329009

Transmit the image displayed with AV control unit with RGB signal to the display unit.

### Diagnosis Procedure

INFOID:000000001329010

#### 1. CHECK CONTINUITY RGB (B: BLUE) SIGNAL CIRCUIT

1. Turn ignition switch OFF.
2. Disconnect display unit connector M93 and AV control unit connector M43.
3. Check continuity between display unit harness connector M93 (A) terminal 18 and AV control unit harness connector M43 (B) terminal 23.

A		B		Continuity
Connector	Terminal	Connector	Terminal	
M93	18	M43	23	Yes

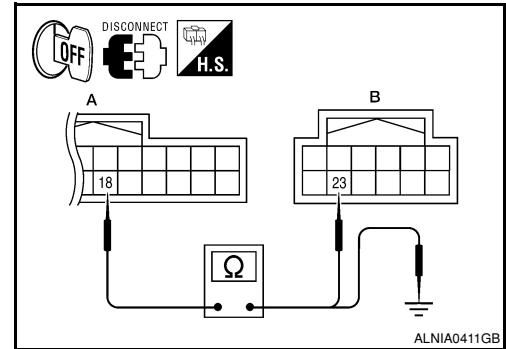

4. Check continuity between display unit harness connector M93 (A) terminal 18 and ground.

A		—	Continuity
Connector	Terminal		
M93	18	Ground	No

Are continuity results as specified?

YES >> GO TO 2.

NO >> Repair harness or connector.

#### 2. CHECK RGB (B: BLUE) SIGNAL

1. Connect display unit connector M93 and AV control unit connector M43.
2. Turn ignition switch ON.
3. Check signal between display unit harness connector M93 terminal 18 and ground.

(+) Connector		(-)	Condition	Reference signal
Connector	Terminal			
M93	18	Ground	Receive audio signal	<p>SK1B2237J</p>

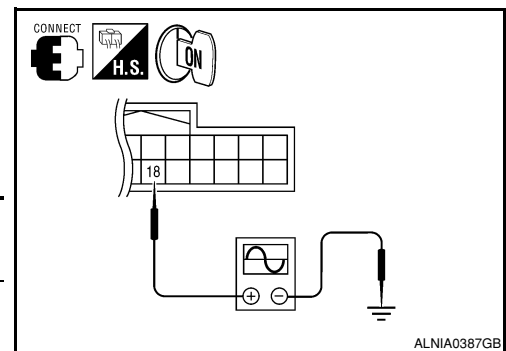

Are voltage readings as specified?

YES >> Replace display unit. Refer to [AV-106, "Removal and Installation"](#)

NO >> Replace AV control unit. Refer to [AV-104, "Removal and Installation"](#)

# RGB SYNCHRONIZING SIGNAL CIRCUIT

< COMPONENT DIAGNOSIS >

[BOSE AUDIO WITH NAVIGATION]

## RGB SYNCHRONIZING SIGNAL CIRCUIT

### Description

INFOID:000000001329011

Transmit the RGB synchronizing signal to the display unit so as to synchronize the RGB image displayed with AV control unit.

### Diagnosis Procedure

INFOID:000000001329012

#### 1. CHECK CONTINUITY RGB SYNCHRONIZING SIGNAL CIRCUIT

1. Turn ignition switch OFF.
2. Disconnect display unit connector M93 and AV control unit connector M43.
3. Check continuity between display unit harness connector M93 (A) terminal 19 and AV control unit harness connector M43 (B) terminal 25.

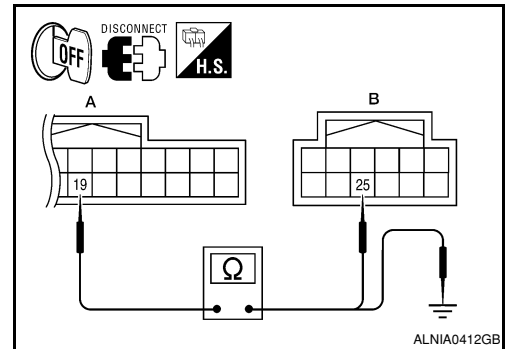

A		B		Continuity
Connector	Terminal	Connector	Terminal	
M93	19	M43	25	Yes

4. Check continuity between display unit harness connector M93 (A) terminal 19 and ground.

A		—	Continuity
Connector	Terminal		
M93	19	Ground	No

Are continuity results as specified?

YES >> GO TO 2.

NO >> Repair harness or connector.

#### 2. CHECK RGB SYNCHRONIZING SIGNAL

1. Connect display unit connector M93 and AV control unit connector M43.
2. Turn ignition switch ON.
3. Check signal between display unit harness connector M93 terminal 19 and ground.

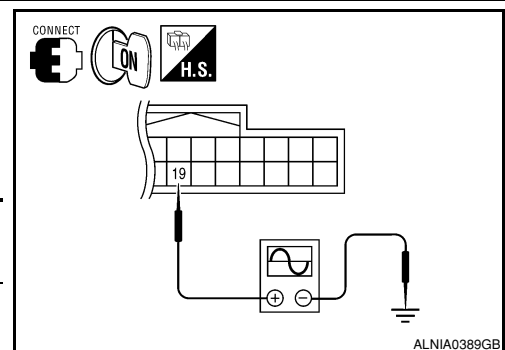

(+) Connector		(-)	Condition	Reference signal
Connector	Terminal			
M93	19	Ground	Receive audio signal	<p>SKIB3603E</p>

Are voltage readings as specified?

YES >> Replace display unit. Refer to [AV-106, "Removal and Installation"](#)

NO >> Replace AV control unit. Refer to [AV-104, "Removal and Installation"](#)

# RGB AREA (YS) SIGNAL CIRCUIT

< COMPONENT DIAGNOSIS >

[BOSE AUDIO WITH NAVIGATION]

## RGB AREA (YS) SIGNAL CIRCUIT

### Description

INFOID:000000001329013

Transmits the display area of RGB image displayed by AV control unit with RGB area (YS) signal to display unit.

### Diagnosis Procedure

INFOID:000000001329014

#### 1. CHECK CONTINUITY RGB AREA (YS) SIGNAL CIRCUIT

1. Turn ignition switch OFF.
2. Disconnect display unit connector M93 and AV control unit connector M43.
3. Check continuity between display unit harness connector M93 (A) terminal 9 and AV control unit harness connector M43 (B) terminal 27.

A		B		Continuity
Connector	Terminal	Connector	Terminal	
M93	9	M43	27	Yes

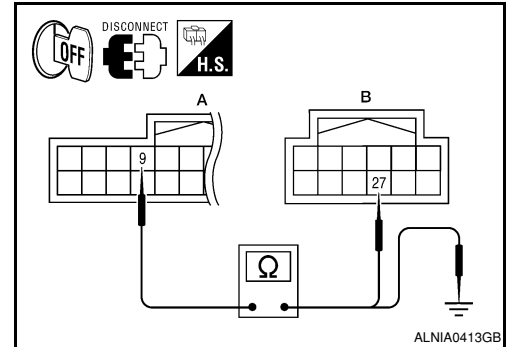

4. Check continuity between display unit harness connector M93 (A) terminal 9 and ground.

A		—	Continuity
Connector	Terminal		
M93	9	Ground	No

Are continuity results as specified?

- YES >> GO TO 2.  
NO >> Repair harness or connector.

#### 2. CHECK RGB SYNCHRONIZING SIGNAL

1. Connect display unit connector M93 and AV control unit connector M43.
2. Turn ignition switch ON.
3. Check signal between display unit harness connector M93 terminal 9 and ground.

(+) Connector		(-)	Condition	Reference signal
Connector	Terminal			
M93	9	Ground	Receive audio signal	

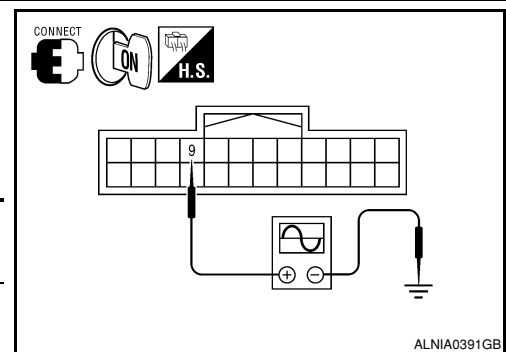

Are voltage readings as specified?

- YES >> Replace display unit. Refer to [AV-106, "Removal and Installation"](#)  
NO >> Replace AV control unit. Refer to [AV-104, "Removal and Installation"](#)



# HORIZONTAL SYNCHRONIZING (HP) SIGNAL CIRCUIT

< COMPONENT DIAGNOSIS >

[BOSE AUDIO WITH NAVIGATION]

## HORIZONTAL SYNCHRONIZING (HP) SIGNAL CIRCUIT

### Description

INFOID:000000001329015

In composite image (AUX image, camera image), transmit the vertical synchronizing (VP) signal and horizontal synchronizing (HP) signal from display unit to AV control unit so as to synchronize the RGB images displayed with AV control unit such as the image quality adjusting menu, etc.

### Diagnosis Procedure

INFOID:000000001329016

#### 1. CHECK CONTINUITY HORIZONTAL SYNCHRONIZING (HP) SIGNAL CIRCUIT

- Turn ignition switch OFF.
- Disconnect display unit connector M93 and AV control unit connector M43.
- Check continuity between display unit harness connector M93 (A) terminal 8 and AV control unit harness connector M43 (B) terminal 28.

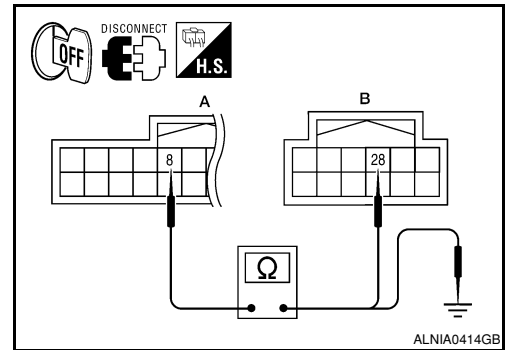

A		B		Continuity
Connector	Terminal	Connector	Terminal	
M93	8	M43	28	Yes

- Check continuity between display unit harness connector M93 (A) terminal 8 and ground.

A		—	Continuity
Connector	Terminal		
M93	8	Ground	No

Are continuity results as specified?

YES >> GO TO 2.

NO >> Repair harness or connector.

#### 2. CHECK HORIZONTAL SYNCHRONIZING (HP) SIGNAL

- Connect display unit connector M93 and AV control unit connector M43.
- Turn ignition switch ON.
- Check signal between display unit harness connector M93 terminal 8 and ground.

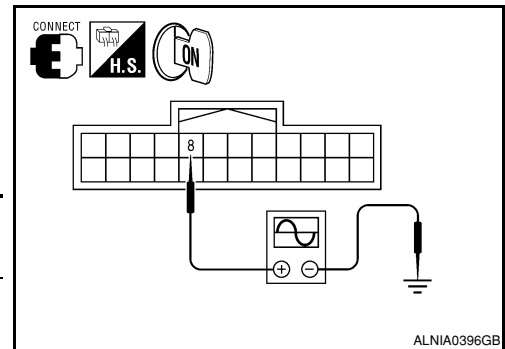

(+) Connector		(-)	Condition	Reference signal
Connector	Terminal			
M93	8	Ground	Receive audio signal	

Are voltage readings as specified?

YES >> Replace AV control unit. Refer to [AV-104, "Removal and Installation"](#)

NO >> Replace display unit. Refer to [AV-106, "Removal and Installation"](#)

# VERTICAL SYNCHRONIZING (VP) SIGNAL CIRCUIT

< COMPONENT DIAGNOSIS >

[BOSE AUDIO WITH NAVIGATION]

## VERTICAL SYNCHRONIZING (VP) SIGNAL CIRCUIT

### Description

INFOID:000000001329017

In composite image (AUX image, camera image), transmit the vertical synchronizing (VP) signal and horizontal synchronizing (HP) signal from display unit to AV control unit so as to synchronize the RGB images displayed with AV control unit such as the image quality adjusting menu, etc.

### Diagnosis Procedure

INFOID:000000001329018

#### 1. CHECK CONTINUITY VERTICAL SYNCHRONIZING (VP) SIGNAL CIRCUIT

1. Turn ignition switch OFF.
2. Disconnect display unit connector M93 and AV control unit connector M43.
3. Check continuity between display unit harness connector M93 (A) terminal 20 and AV control unit harness connector M43 (B) terminal 29.

A		B		Continuity
Connector	Terminal	Connector	Terminal	
M93	20	M43	29	Yes

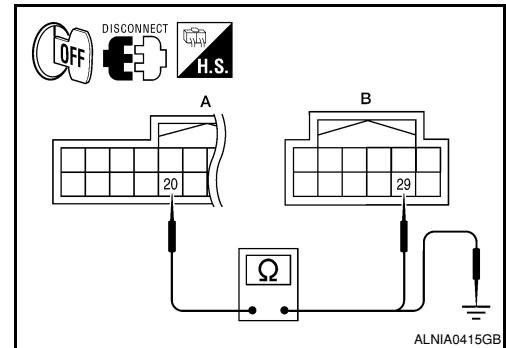

4. Check continuity between display unit harness connector M93 (A) terminal 20 and ground.

A		—	Continuity
Connector	Terminal		
M93	20	Ground	No

Are continuity results as specified?

YES >> GO TO 2.

NO >> Repair harness or connector.

#### 2. CHECK VERTICAL SYNCHRONIZING (VP) SIGNAL

1. Connect display unit connector M93 and AV control unit connector M43.
2. Turn ignition switch ON.
3. Check signal between display unit harness connector M93 terminal 20 and ground.

(+)		(-)	Condition	Reference signal
Connector	Terminal			
M93	20	Ground	Receive audio signal	

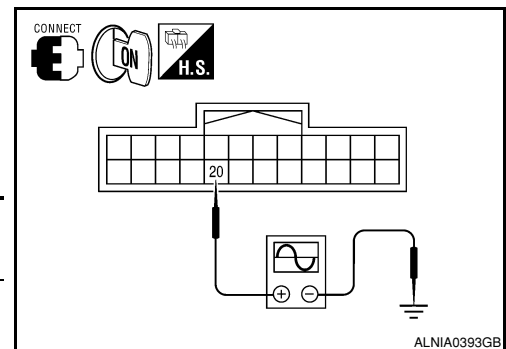

Are voltage readings as specified?

YES >> Replace AV control unit. Refer to [AV-104. "Removal and Installation"](#)

NO >> Replace display unit. Refer to [AV-106. "Removal and Installation"](#)

# FRONT DOOR SPEAKER

< COMPONENT DIAGNOSIS >

[BOSE AUDIO WITH NAVIGATION]

## FRONT DOOR SPEAKER

### Description

INFOID:000000001317811

The AV control unit sends audio signals to the BOSE speaker amp. The BOSE speaker amp. amplifies the audio signals before sending them to the front door speakers using the audio signal circuits.

### Diagnosis Procedure

INFOID:000000001317812

#### 1. HARNESS CHECK

1. Disconnect BOSE speaker amp. connector M112 and suspect speaker connector.
2. Check continuity between BOSE speaker amp. harness connector M112 (A) and suspect speaker harness connector (B).

A		B		Continuity
Connector	Terminal	Connector	Terminal	
M112	4	D12	1	Yes
	5		2	
	8	D112	1	
	13		2	

3. Check continuity between BOSE speaker amp. harness connector M112 (A) and ground.

A		—	Continuity
Connector	Terminal		
M112	4	Ground	No
	5		
	8		
	13		

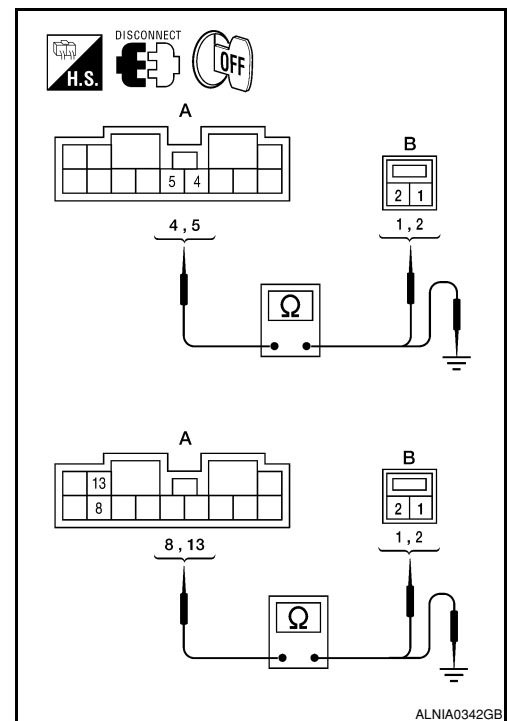

Are continuity test results as specified?

YES >> GO TO 2

- NO >> • Check connector housings for disconnected or loose terminals.  
• Repair harness or connector.

#### 2. FRONT SPEAKER SIGNAL CHECK

A  
B  
C  
D  
E  
F  
G  
H  
I  
J  
K  
L  
M  
O  
P

AV

# FRONT DOOR SPEAKER

[BOSE AUDIO WITH NAVIGATION]

## < COMPONENT DIAGNOSIS >

1. Connect BOSE speaker amp. connector M112 and suspect speaker connector.
2. Turn ignition switch to ACC.
3. Push "POWER" switch.
4. Check the signal between BOSE speaker amp. harness connector M112 terminals with CONSULT-III or oscilloscope.

Connector	Terminal		Condition	Reference signal
	(+)	(-)		
M112	4	5	Receive audio signal	
	8	13		

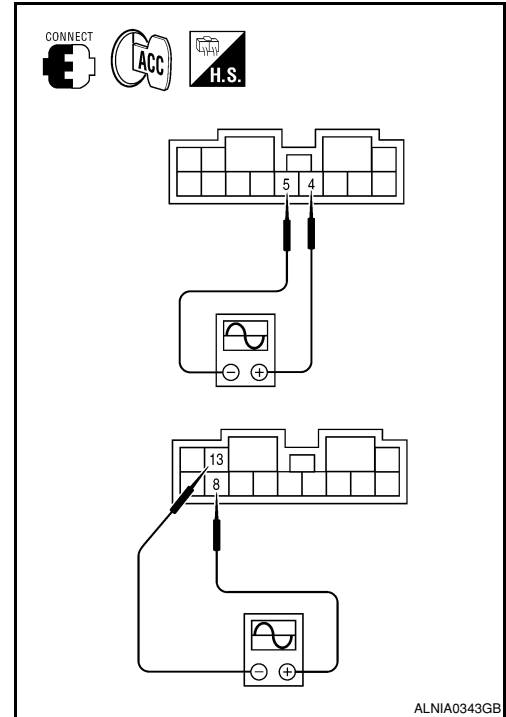

Is audio signal voltage as specified?

YES >> Replace suspect speaker. Refer to [AV-442. "Removal and Installation"](#).

NO >> GO TO 3

## 3. HARNESS CHECK

1. Disconnect AV control unit connector M42 and BOSE speaker amp. connector M113.
2. Check continuity between AV control unit harness connector M42 (A) and BOSE speaker amp. harness connector M113 (B).

A		B		Continuity
Connector	Terminal	Connector	Terminal	
M42	2	M113	18	Yes
	3		32	
	11		19	
	12		20	

3. Check continuity between AV control unit harness connector M42 (A) and ground.

A		—	Continuity
Connector	Terminal		
M42	2	Ground	No
	3		
	11		
	12		

Are continuity test results as specified?

YES >> GO TO 4

NO >> • Check connector housings for disconnected or loose terminals.  
• Repair harness or connector.

## 4. FRONT SPEAKER SIGNAL CHECK

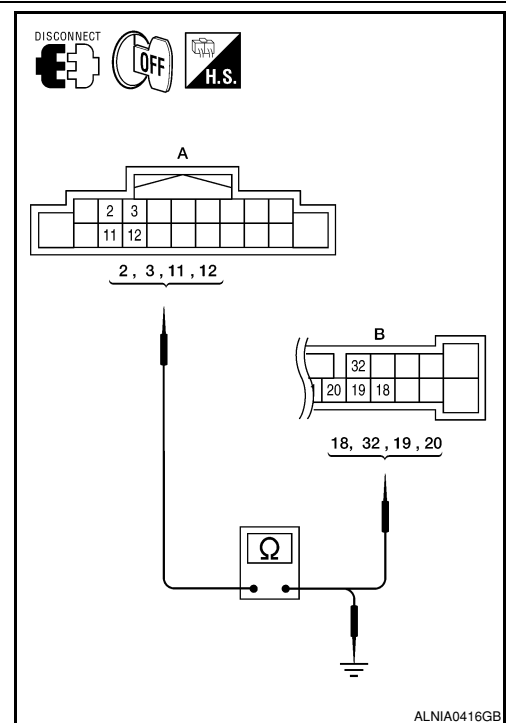

# FRONT DOOR SPEAKER

[BOSE AUDIO WITH NAVIGATION]

## < COMPONENT DIAGNOSIS >

1. Connect AV control unit connector and BOSE speaker amp. connector.
2. Turn ignition switch ACC.
3. Push "POWER" switch.
4. Check the signal between AV control unit harness connector M42 terminals with CONSULT-III or oscilloscope.

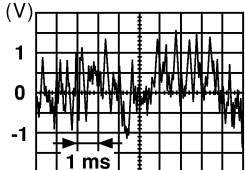
Connector	Terminals		Condition	Reference signal
	(+)	(-)		
M42	2	3	Receive audio signal	
	11	12		

SKIA0177E

Are the audio signal voltage readings as specified?

- YES >> Replace BOSE speaker amp. Refer to [AV-450, "Removal and Installation"](#).
- NO >> Replace AV control unit. Refer to [AV-438, "Removal and Installation"](#).

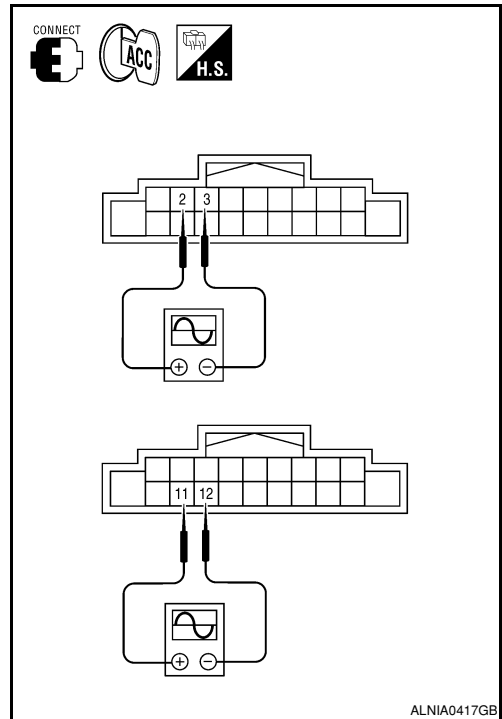

ALNIA0417GB

A  
B  
C  
D  
E  
F  
G  
H  
I  
J  
K  
L  
M  
O  
P

AV

## FRONT TWEETER

### Description

INFOID:000000001317813

The AV control unit sends audio signals to the BOSE speaker amp. The BOSE speaker amp. amplifies the audio signals before sending them to the tweeters using the audio signal circuits.

### Diagnosis Procedure

INFOID:000000001317814

#### 1. HARNESS CHECK

1. Disconnect BOSE speaker amp. connector M112 and suspect tweeter connector.
2. Check continuity between BOSE speaker amp. harness connector M112 (A) and suspect tweeter harness connector (B).

A		B		Continuity
Connector	Terminal	Connector	Terminal	
M112	4	D12	1	Yes
	5		2	
	8	D112	1	
	13		2	

3. Check continuity between BOSE speaker amp. harness connector M112 (A) and ground.

A		—	Continuity
Connector	Terminal		
M112	4	Ground	No
	5		
	8		
	13		

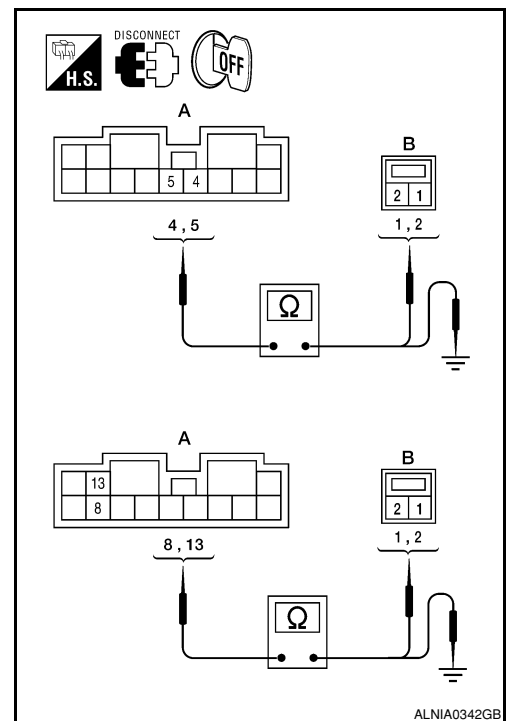

Are continuity test results as specified?

YES >> GO TO 2

- NO >> • Check connector housings for disconnected or loose terminals.  
 • Repair harness or connector.

#### 2. FRONT TWEETER SIGNAL CHECK

# FRONT TWEETER

[BOSE AUDIO WITH NAVIGATION]

## < COMPONENT DIAGNOSIS >

1. Connect BOSE speaker amp. connector M112 and suspect tweeter connector.
2. Turn ignition switch to ACC.
3. Push "POWER" switch.
4. Check the signal between BOSE speaker amp. harness connector M112 terminals with CONSULT-III or oscilloscope.

Connector	Terminal		Condition	Reference signal
	(+)	(-)		
M112	4	5	Receive audio signal	
	8	13		

Is audio signal voltage as specified?

YES >> Replace suspect tweeter. Refer to [AV-440. "Removal and Installation"](#).

NO >> GO TO 3

## 3. HARNESS CHECK

1. Disconnect AV control unit connector M42 and BOSE speaker amp. connector M113.
2. Check continuity between AV control unit harness connector M42 (A) and BOSE speaker amp. harness connector M113 (B).

A		B		Continuity
Connector	Terminal	Connector	Terminal	
M42	2	M113	18	Yes
	3		32	
	11		19	
	12		20	

3. Check continuity between AV control unit harness connector M42 (A) and ground.

A		—	Continuity
Connector	Terminal		
M42	2	Ground	No
	3		
	11		
	12		

Are continuity test results as specified?

YES >> GO TO 4

NO >> • Check connector housings for disconnected or loose terminals.  
• Repair harness or connector.

## 4. FRONT SPEAKER SIGNAL CHECK

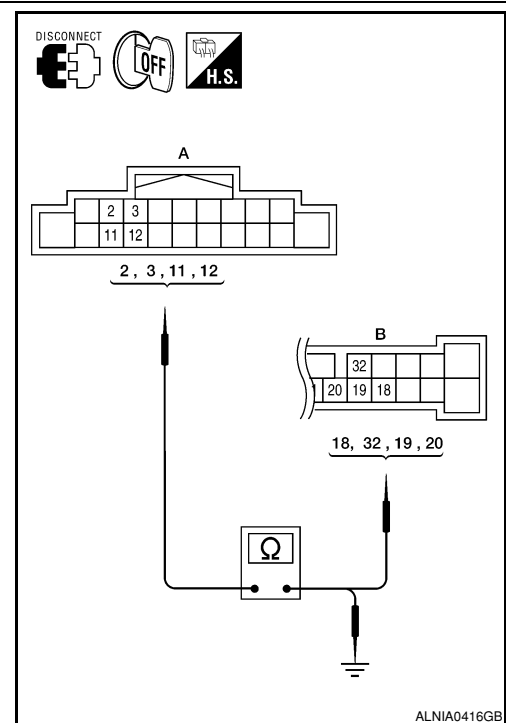
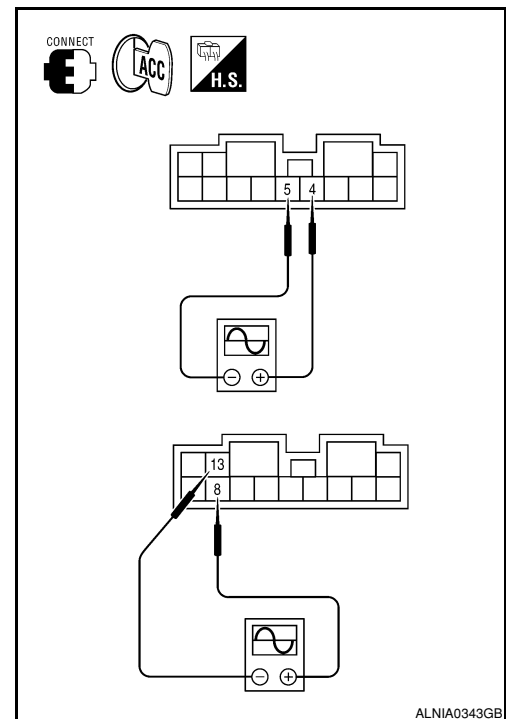

A  
B  
C  
D  
E  
F  
G  
H  
I  
J  
K  
L  
M  
O  
P

AV

# FRONT TWEETER

[BOSE AUDIO WITH NAVIGATION]

## < COMPONENT DIAGNOSIS >

1. Connect AV control unit connector and BOSE speaker amp. connector.
2. Turn ignition switch ACC.
3. Push "POWER" switch.
4. Check the signal between AV control unit harness connector M42 terminals with CONSULT-III or oscilloscope.

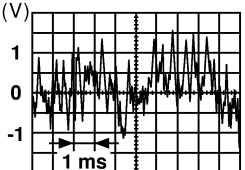
Connector	Terminals		Condition	Reference signal
	(+)	(-)		
M42	2	3	Receive audio signal	
	11	12		

SKIA0177E

Are the audio signal voltage readings as specified?

- YES >> Replace BOSE speaker amp. Refer to [AV-450. "Removal and Installation"](#).
- NO >> Replace AV control unit. Refer to [AV-438. "Removal and Installation"](#).

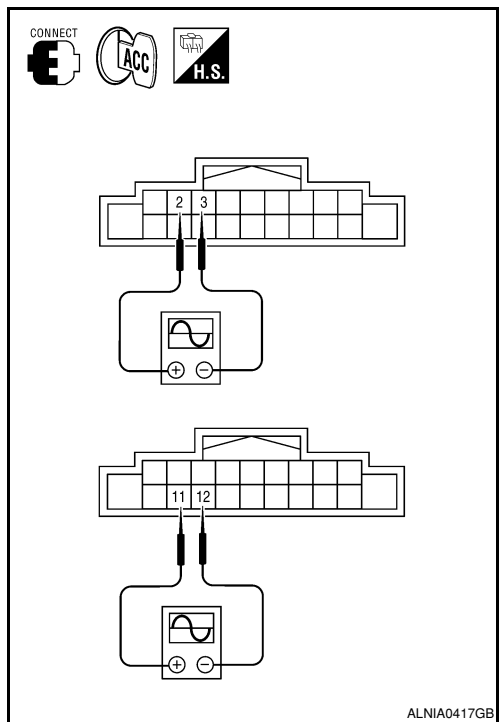

ALNIA0417GB



# CENTER SPEAKER

< COMPONENT DIAGNOSIS >

[BOSE AUDIO WITH NAVIGATION]

## CENTER SPEAKER

### Description

INFOID:000000001317815

The AV control unit sends audio signals to the BOSE speaker amp. The BOSE speaker amp. amplifies the audio signals before sending them to the center speaker using the audio signal circuits.

### Diagnosis Procedure

INFOID:000000001317816

#### 1. HARNESS CHECK

1. Disconnect BOSE speaker amp. connector M113 and center speaker connector M110.
2. Check continuity between BOSE speaker amp. harness connector M113 (A) and center speaker harness connector M110 (B).

A		B		Continuity
Connector	Terminal	Connector	Terminal	
M113	15	M110	1	Yes
	28		2	

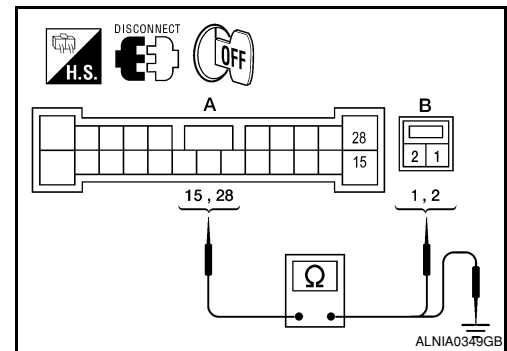

3. Check continuity between BOSE speaker amp. harness connector M113 (A) and ground.

A		—	Continuity
Connector	Terminal		
M113	15	Ground	No
	28		

Are continuity test results as specified?

- YES >> GO TO 2  
 NO >> • Check connector housings for disconnected or loose terminals.  
 • Repair harness or connector.

#### 2. CENTER SPEAKER SIGNAL CHECK

1. Connect BOSE speaker amp. connector M113 and center speaker connector M110.
2. Turn ignition switch to ACC.
3. Push "POWER" switch.
4. Check the signal between BOSE speaker amp. harness connector M113 terminals with CONSULT-III or oscilloscope.

Connector	Terminals		Condition	Reference signal
	(+)	(-)		
M113	15	28	Receive audio signal	

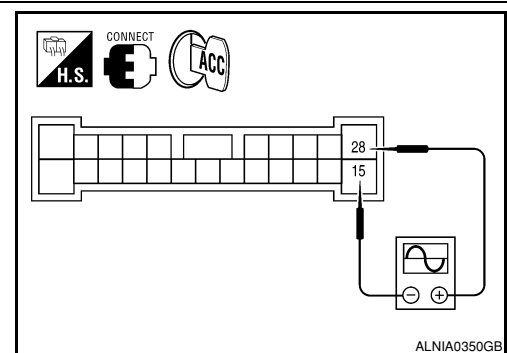

Is the audio signal voltage reading as specified?

- YES >> Replace center speaker. Refer to [AV-441. "Removal and Installation"](#).  
 NO >> GO TO 3

#### 3. HARNESS CHECK

# CENTER SPEAKER

**[BOSE AUDIO WITH NAVIGATION]**

## < COMPONENT DIAGNOSIS >

1. Disconnect AV control unit connector M42 and BOSE speaker amp. connector M113.
2. Check continuity between AV control unit harness connector M42 (A) and BOSE speaker amp. harness connector M113 (B).

A		B		Continuity
Connector	Terminal	Connector	Terminal	
M42	2	M113	18	Yes
	3		32	
	11		19	
	12		20	

3. Check continuity between AV control unit harness connector M42 (A) and ground.

A		—	Continuity
Connector	Terminal		
M42	2	Ground	No
	3		
	11		
	12		

Are continuity test results as specified?

YES >> GO TO 4

- NO >> • Check connector housings for disconnected or loose terminals.  
 • Repair harness or connector.

## 4. FRONT SPEAKER SIGNAL CHECK

1. Connect AV control unit connector and BOSE speaker amp. connector.
2. Turn ignition switch ACC.
3. Push "POWER" switch.
4. Check the signal between AV control unit harness connector M42 terminals with CONSULT-III or oscilloscope.

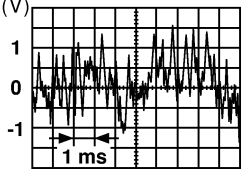
Connector	Terminals		Condition	Reference signal
	(+)	(-)		
M42	2	3	Receive audio signal	
	11	12		

Are the audio signal voltage readings as specified?

YES >> Replace BOSE speaker amp. Refer to [AV-450, "Removal and Installation"](#).

NO >> Replace AV control unit. Refer to [AV-438, "Removal and Installation"](#).

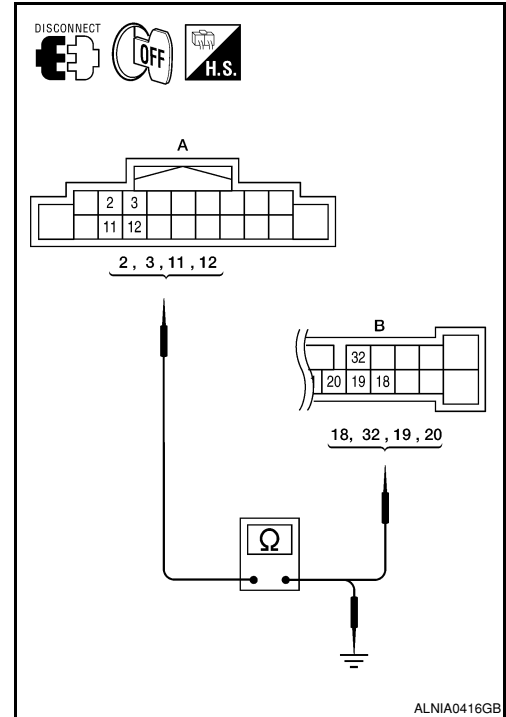

ALNIA0416GB

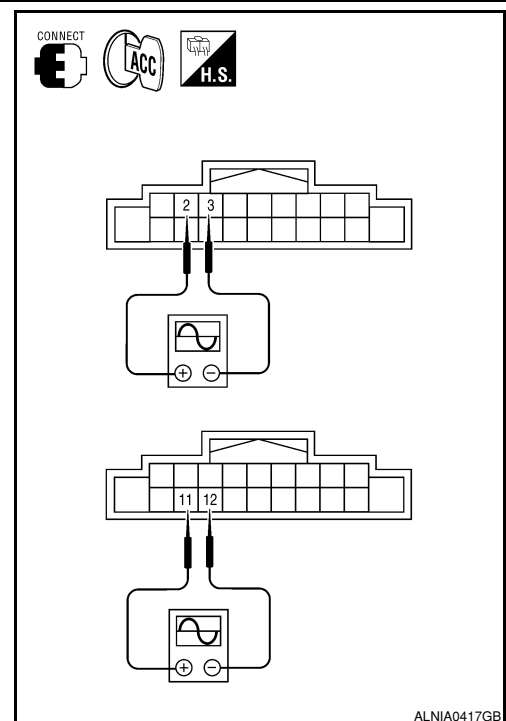

ALNIA0417GB

# REAR DOOR SPEAKER

< COMPONENT DIAGNOSIS >

[BOSE AUDIO WITH NAVIGATION]

## REAR DOOR SPEAKER

### Description

INFOID:000000001317817

The AV control unit sends audio signals to the BOSE speaker amp. The BOSE speaker amp. amplifies the audio signals before sending them to the rear door speakers using the audio signal circuits.

### Diagnosis Procedure

INFOID:000000001317818

#### 1. HARNESS CHECK

1. Disconnect BOSE speaker amp. connectors M112 and suspect speaker connector.
2. Check continuity between BOSE speaker amp. harness connectors M112 (A) and suspect speaker harness connector (B).

A		B		Continuity
Connector	Terminal	Connector	Terminal	
M112	1	D207	1	Yes
	10		2	
	2	D307	1	
	3		2	

3. Check continuity between BOSE speaker amp. harness connectors M112 (A) and ground.

Connector	Terminal	-	Continuity
M112	1	Ground	No
	10		
	2		
	3		

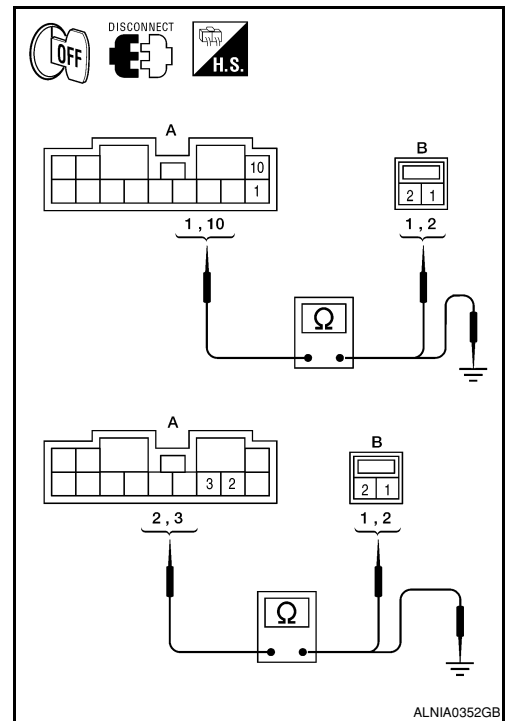

ALNIA0352GB

Are the continuity test results as specified?

YES >> GO TO 2

NO >> • Check connector housings for disconnected or loose terminals.  
• Repair harness or connector.

#### 2. REAR DOOR SPEAKER SIGNAL CHECK

A  
B  
C  
D  
E  
F  
G  
H  
I  
J  
K  
L  
M  
O  
P

AV

# REAR DOOR SPEAKER

[BOSE AUDIO WITH NAVIGATION]

## < COMPONENT DIAGNOSIS >

1. Connect BOSE speaker amp. connectors and suspect speaker connector.
2. Turn ignition switch to ACC.
3. Push "POWER" switch.
4. Check the signal between BOSE speaker amp. harness connectors M112 terminals with CONSULT-III or oscilloscope.

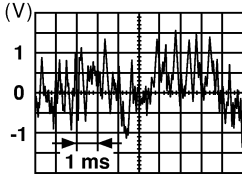
Connector	Terminals		Condition	Reference signal
	(+)	(-)		
M112	1	10	Receive audio signal	
	2	3		

SKIA0177E

Are audio signal voltage readings as specified?

YES >> Replace suspect speaker. Refer to [AV-443. "Removal and Installation"](#).

NO >> GO TO 3

### 3. HARNESS CHECK

1. Disconnect AV control unit connector M42 and BOSE speaker amp. connector M113.
2. Check continuity between AV control unit harness connector M42 (A) and BOSE speaker amp. harness connector M113 (B).

A		B		Continuity
Connector	Terminal	Connector	Terminal	
M42	4	M113	21	Yes
	5		22	
	13		23	
	14		33	

3. Check continuity between AV control unit harness connector M42 (A) and ground.

A		—	Continuity
Connector	Terminal		
M42	4	Ground	No
	5		
	13		
	14		

Are the continuity test results as specified?

YES >> GO TO 4

NO >> • Check connector housings for disconnected or loose terminals.  
• Repair harness or connector.

### 4. REAR DOOR SPEAKER SIGNAL CHECK

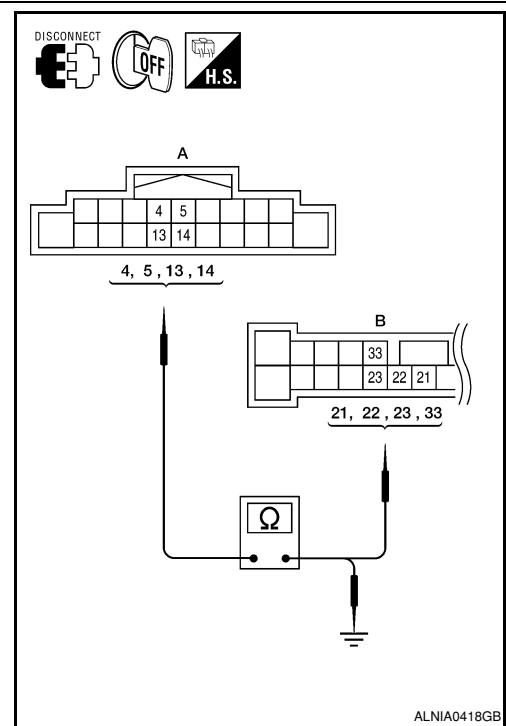
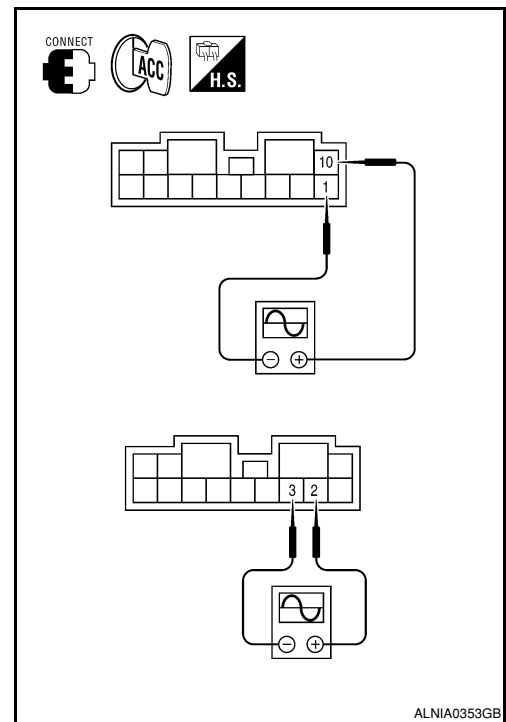

# REAR DOOR SPEAKER

[BOSE AUDIO WITH NAVIGATION]

## < COMPONENT DIAGNOSIS >

1. Connect AV control unit connector M42 and BOSE speaker amp. connector M113.
2. Turn ignition switch to ACC.
3. Push "POWER" switch.
4. Check the signal between AV control unit harness connector M42 terminals with CONSULT-III or oscilloscope.

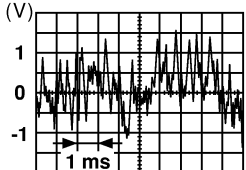
Connector	Terminals		Condition	Reference signal
	(+)	(-)		
M42	4	5	Receive audio signal	 <p style="text-align: right; font-size: small;">SKIA0177E</p>
	13	14		

Is the audio signal voltage reading as specified?

- YES >> Replace BOSE speaker amp. Refer to [AV-450, "Removal and Installation"](#).
- NO >> Replace AV control unit. Refer to [AV-438, "Removal and Installation"](#).

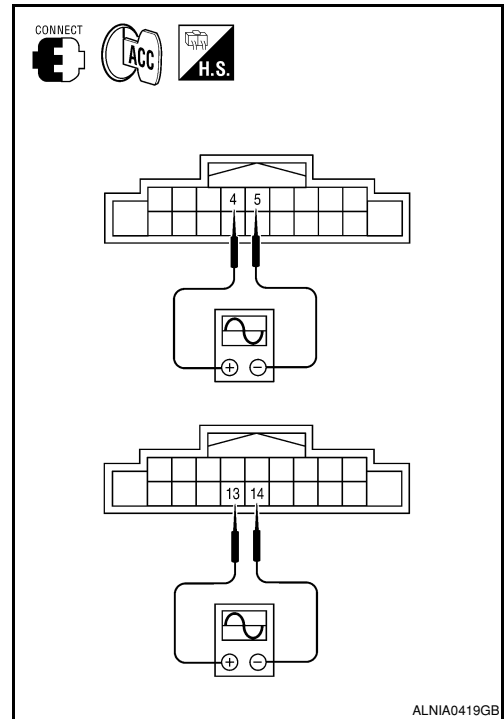

A  
B  
C  
D  
E  
F  
G  
H  
I  
J  
K  
L  
M  
O  
P

AV

# REAR TWEETER

< COMPONENT DIAGNOSIS >

[BOSE AUDIO WITH NAVIGATION]

## REAR TWEETER

### Description

INFOID:000000001317819

The AV control unit sends audio signals to the BOSE speaker amp. The BOSE speaker amp. amplifies the audio signals before sending them to the rear tweeters using the audio signal circuits.

### Diagnosis Procedure

INFOID:000000001317820

#### 1. HARNESS CHECK

1. Disconnect BOSE speaker amp. connectors M112 and suspect tweeter connector.
2. Check continuity between BOSE speaker amp. harness connectors M112 (A) and suspect tweeter harness connector (B).

A		B		Continuity
Connector	Terminal	Connector	Terminal	
M112	1	D207	1	Yes
	10		2	
	2	D307	1	
	3		2	

3. Check continuity between BOSE speaker amp. harness connectors M112 (A) and ground.

Connector	Terminal	-	Continuity
M112	1	Ground	No
	10		
	2		
	3		

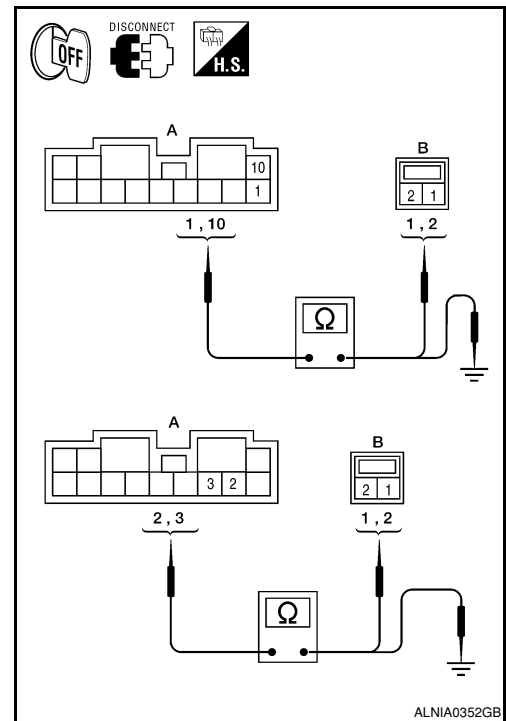

ALNIA0352GB

Are the continuity test results as specified?

YES >> GO TO 2

NO >> • Check connector housings for disconnected or loose terminals.  
• Repair harness or connector.

#### 2. REAR TWEETER SIGNAL CHECK

# REAR TWEETER

[BOSE AUDIO WITH NAVIGATION]

## < COMPONENT DIAGNOSIS >

1. Connect BOSE speaker amp. connectors and suspect tweeter connector.
2. Turn ignition switch to ACC.
3. Push "POWER" switch.
4. Check the signal between BOSE speaker amp. harness connectors M112 terminals with CONSULT-III or oscilloscope.

Connector	Terminals		Condition	Reference signal
	(+)	(-)		
M112	1	10	Receive audio signal	
	2	3		

SKIA0177E

Are audio signal voltage readings as specified?

YES >> Replace suspect tweeter. Refer to [AV-444, "Removal and Installation"](#).

NO >> GO TO 3

## 3. HARNESS CHECK

1. Disconnect AV control unit connector M42 and BOSE speaker amp. connector M113.
2. Check continuity between AV control unit harness connector M42 (A) and BOSE speaker amp. harness connector M113 (B).

A		B		Continuity
Connector	Terminal	Connector	Terminal	
M42	4	M113	21	Yes
	5		22	
	13		23	
	14		33	

3. Check continuity between AV control unit harness connector M42 (A) and ground.

A		—	Continuity
Connector	Terminal		
M42	4	Ground	No
	5		
	13		
	14		

Are the continuity test results as specified?

YES >> GO TO 4

NO >> • Check connector housings for disconnected or loose terminals.  
• Repair harness or connector.

## 4. REAR DOOR SPEAKER SIGNAL CHECK

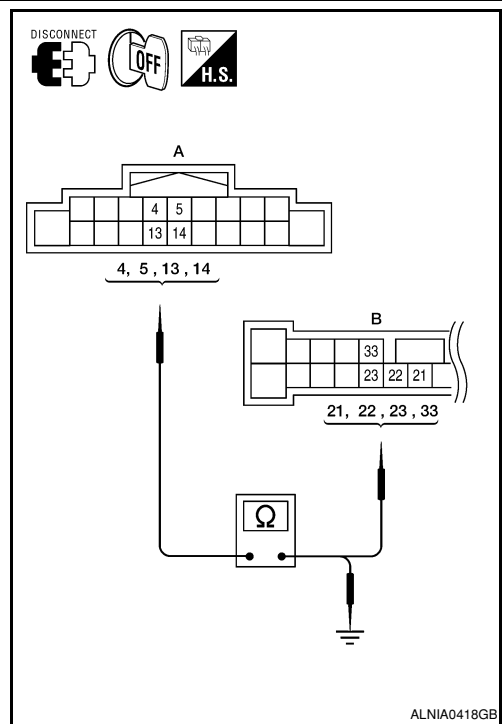
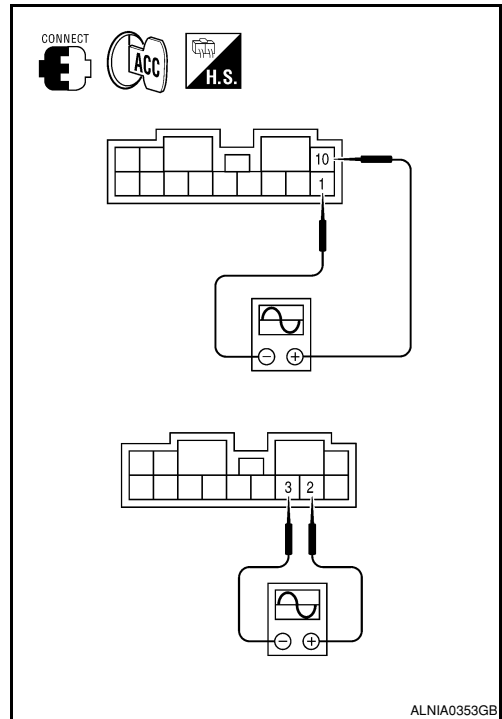

A  
B  
C  
D  
E  
F  
G  
H  
I  
J  
K  
L  
M  
O  
P

AV

## REAR TWEETER

**[BOSE AUDIO WITH NAVIGATION]**

### < COMPONENT DIAGNOSIS >

1. Connect AV control unit connector M42 and BOSE speaker amp. connector M113.
2. Turn ignition switch to ACC.
3. Push "POWER" switch.
4. Check the signal between AV control unit harness connector M42 terminals with CONSULT-III or oscilloscope.

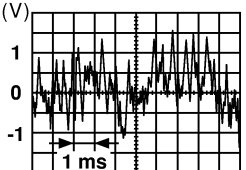
Connector	Terminals		Condition	Reference signal
	(+)	(-)		
M42	4	5	Receive audio signal	 <p style="text-align: right; font-size: small;">SKIA0177E</p>
	13	14		

Is the audio signal voltage reading as specified?

- YES >> Replace BOSE speaker amp. Refer to [AV-450. "Removal and Installation"](#).
- NO >> Replace AV control unit. Refer to [AV-438. "Removal and Installation"](#).

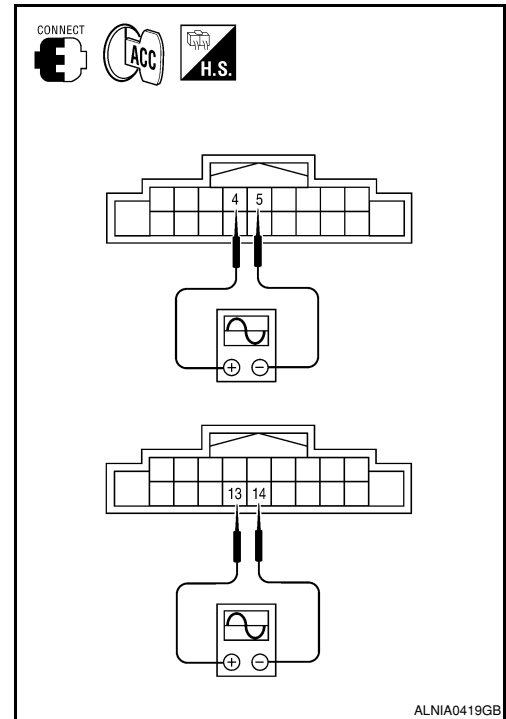



# BACK DOOR SPEAKER

< COMPONENT DIAGNOSIS >

[BOSE AUDIO WITH NAVIGATION]

## BACK DOOR SPEAKER

### Description

INFOID:000000001317821

The AV control unit sends audio signals to the BOSE speaker amp. The BOSE speaker amp. amplifies the audio signals before sending them to the back door speakers using the audio signal circuits.

### Diagnosis Procedure

INFOID:000000001317822

#### 1. HARNESS CHECK

1. Disconnect BOSE speaker amp. connectors and suspect speaker connector.
2. Check continuity between BOSE speaker amp. harness connectors M112 and M113 (A) and suspect speaker harness connector (B).

A		B		Continuity
Connector	Terminal	Connector	Terminal	
M112	6	D518	1	Yes
	7		2	
M113	37	D716	1	
	27		2	

3. Check continuity between BOSE speaker amp. harness connectors M112 and M113 (A) and ground.

Connector	Terminal	-	Continuity
M112	6	Ground	No
	7		
M113	27		
	37		

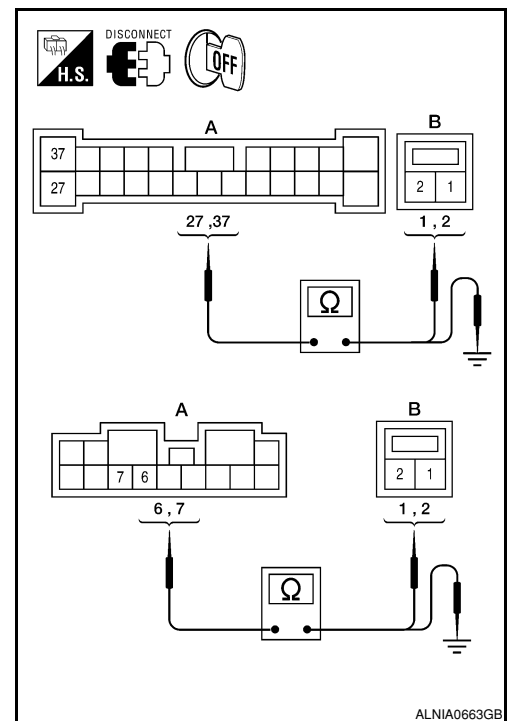

ALNIA0663GB

Are the continuity test results as specified?

YES >> GO TO 2

NO >> • Check connector housings for disconnected or loose terminals.  
• Repair harness or connector.

#### 2. BACK DOOR SPEAKER SIGNAL CHECK

A  
B  
C  
D  
E  
F  
G  
H  
I  
J  
K  
L  
M  
O  
P

AV

# BACK DOOR SPEAKER

[BOSE AUDIO WITH NAVIGATION]

## < COMPONENT DIAGNOSIS >

1. Connect BOSE speaker amp. connectors and suspect speaker connector.
2. Turn ignition switch to ACC.
3. Push "POWER" switch.
4. Check the signal between BOSE speaker amp. harness connectors M112 terminals with CONSULT-III or oscilloscope.

Connector	Terminals		Condition	Reference signal
	(+)	(-)		
M112	6	7	Receive audio signal	
M113	37	27		

SKIA0177E

Are audio signal voltage readings as specified?

YES >> Replace suspect speaker. Refer to [AV-444, "Removal and Installation"](#).

NO >> GO TO 3

## 3. HARNESS CHECK

1. Disconnect AV control unit connector M42 and BOSE speaker amp. connector M113.
2. Check continuity between AV control unit harness connector M42 (A) and BOSE speaker amp. harness connector M113 (B).

A		B		Continuity
Connector	Terminal	Connector	Terminal	
M42	4	M113	21	Yes
	5		22	
	13		23	
	14		33	

3. Check continuity between AV control unit harness connector M42 (A) and ground.

A		—	Continuity
Connector	Terminal		
M42	4	Ground	No
	5		
	13		
	14		

Are the continuity test results as specified?

YES >> GO TO 4

NO >> • Check connector housings for disconnected or loose terminals.  
• Repair harness or connector.

## 4. REAR DOOR SPEAKER SIGNAL CHECK

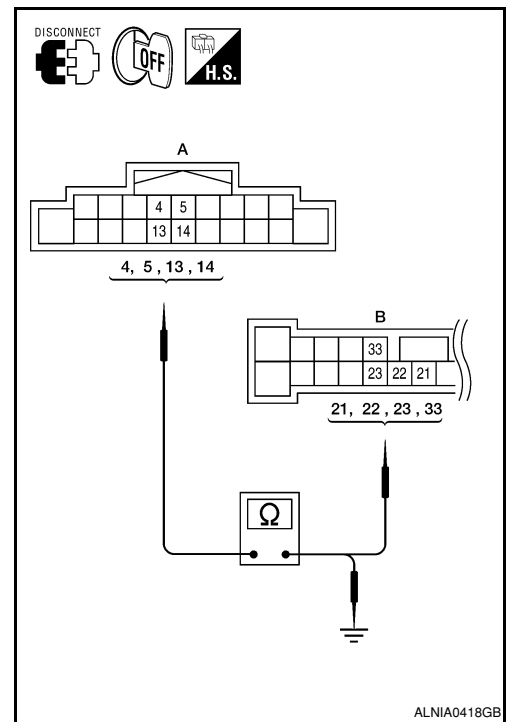
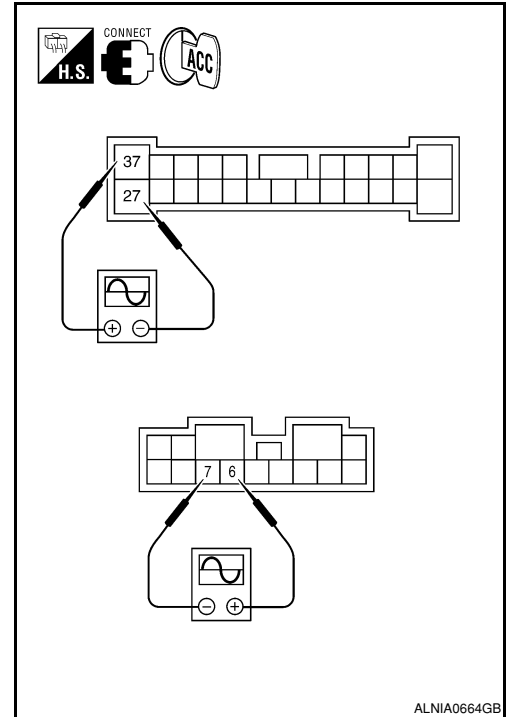

# BACK DOOR SPEAKER

[BOSE AUDIO WITH NAVIGATION]

## < COMPONENT DIAGNOSIS >

1. Connect AV control unit connector M42 and BOSE speaker amp. connector M113.
2. Turn ignition switch to ACC.
3. Push "POWER" switch.
4. Check the signal between AV control unit harness connector M42 terminals with CONSULT-III or oscilloscope.

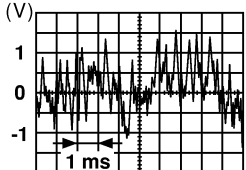
Connector	Terminals		Condition	Reference signal
	(+)	(-)		
M42	4	5	Receive audio signal	 <p>SKIA0177E</p>
	13	14		

Is the audio signal voltage reading as specified?

- YES >> Replace BOSE speaker amp. Refer to [AV-450, "Removal and Installation"](#).
- NO >> Replace AV control unit. Refer to [AV-438, "Removal and Installation"](#).

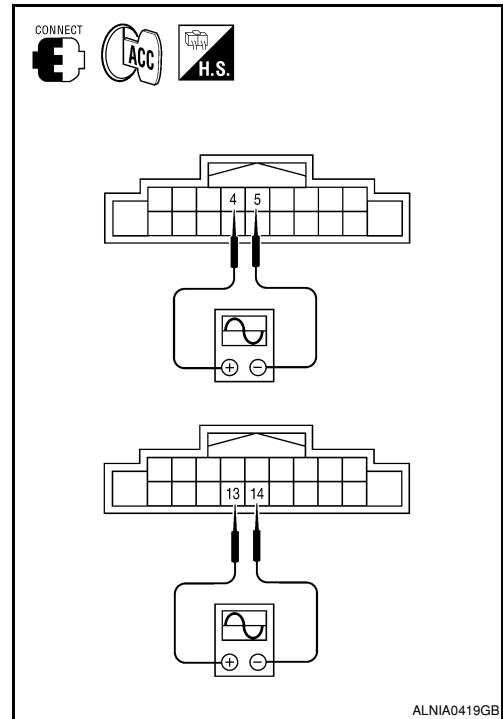

A  
B  
C  
D  
E  
F  
G  
H  
I  
J  
K  
L  
M  
O  
P

AV

## WOOFER

### Description

INFOID:000000001317823

The AV control unit sends audio signals to the BOSE speaker amp. The BOSE speaker amp. amplifies the audio signals before sending them to the subwoofer using the audio signal circuits.

### Diagnosis Procedure

INFOID:000000001317824

#### 1. VERIFY SUBWOOFER POWER AND GROUND SUPPLY

Check power and ground supply to the subwoofer. Refer to [AV-341. "WOOFER : Diagnosis Procedure"](#)

Did the power and ground supply check OK?

YES >> GO TO 2

NO >> • Check connector housings for disconnected or loose terminals.  
• Repair harness or connector.

#### 2. HARNESS CHECK

1. Disconnect BOSE speaker amp. connector M112 and subwoofer connector.
2. Check continuity between BOSE speaker amp. harness connector M112 (A) and M113 (B) and subwoofer harness connector B72 (C).

Connector	Terminal	Connector	Terminal	Continuity
A: M112	9	C: B72	2	Yes
	14		1	
B: M113	25		4	

3. Check continuity between BOSE speaker amp. harness connector M112 (A) and M113 (B) and ground.

Connector	Terminal	-	Continuity
A: M112	9	Ground	No
	14		
B: M113	25		

Are the continuity test results as specified?

YES >> GO TO 3

NO >> • Check connector housings for disconnected or loose terminals.  
• Repair harness or connector.

#### 3. SUBWOOFER AMP ON SIGNAL CHECK

1. Connect BOSE speaker amp. connector M112.
2. Turn ignition switch to ACC.
3. Push "POWER" switch.
4. Check voltage between subwoofer connector B72 terminal 4 and ground.

(+)		(-)	ACC
Connector	Terminal		
B72	4	Ground	Battery voltage

Are the voltage test results as specified?

YES >> GO TO 4

NO >> Replace BOSE speaker amp. Refer to [AV-450. "Removal and Installation"](#)

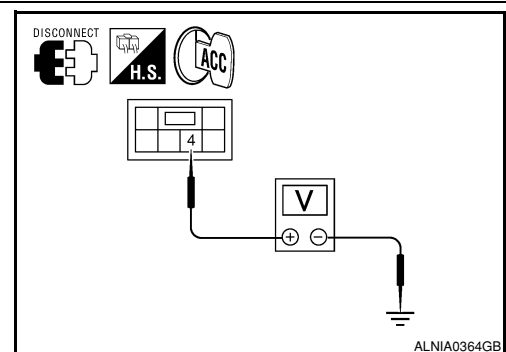
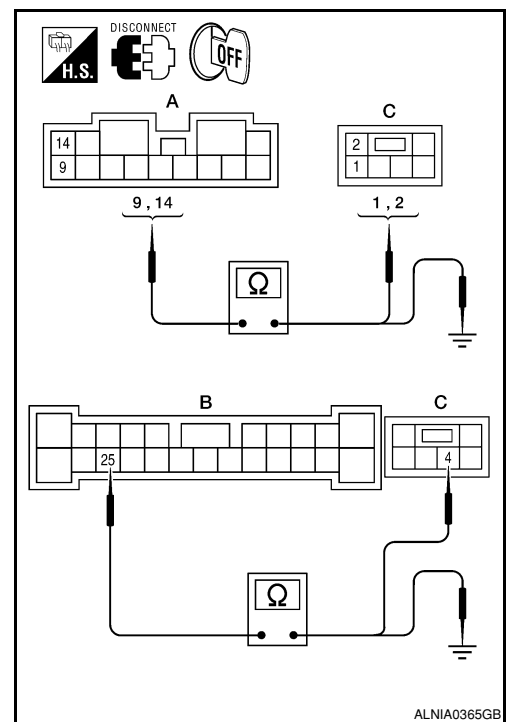

## 4. SUBWOOFER AUDIO SIGNAL CHECK

1. Connect BOSE speaker amp. connector M112 and subwoofer connector B72.
2. Turn ignition switch to ACC.
3. Push "POWER" switch.
4. Check the signal between BOSE speaker amp. harness connector M112 terminals with CONSULT-III or oscilloscope.

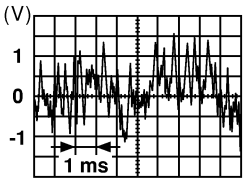
Connector	Terminals		Condition	Reference signal
	(+)	(-)		
M112	9	14	Receive audio signal	

SKIA0177E

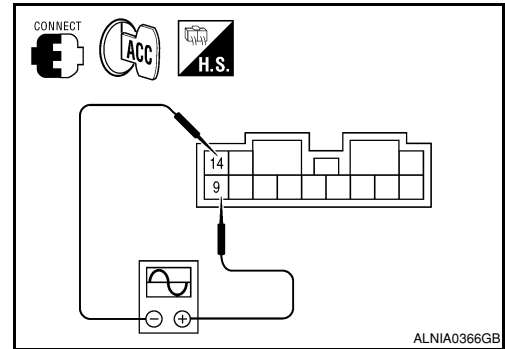

Is the audio signal voltage as specified?

YES >> Replace subwoofer. Refer to [AV-445. "Removal and Installation"](#).

NO >> GO TO 5

## 5. HARNESS CHECK

1. Disconnect AV control unit connector M42 and BOSE speaker amp. connector M113.
2. Check continuity between AV control unit harness connector M42 (A) and BOSE speaker amp. harness connector M113 (B).

A		B		Continuity
Connector	Terminal	Connector	Terminal	
M42	4	M113	21	Yes
	5		22	
	13		23	
	14		33	

3. Check continuity between AV control unit harness connector M42 (A) and ground.

A		—	Continuity
Connector	Terminal		
M42	4	Ground	No
	5		
	13		
	14		

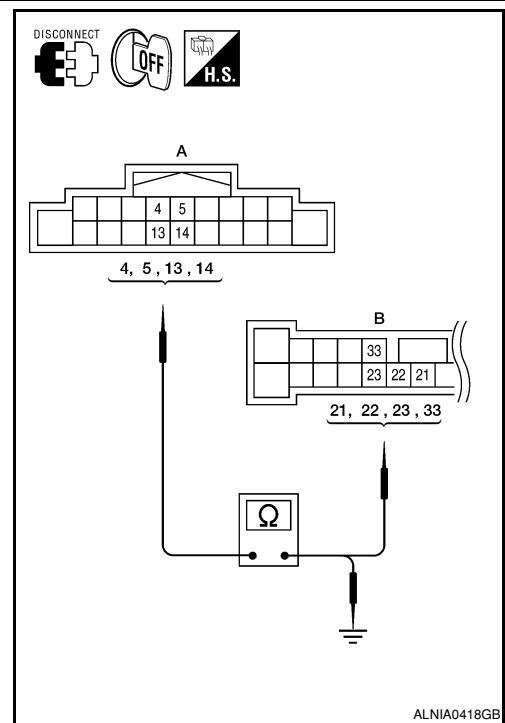

Are the continuity test results as specified?

YES >> GO TO 6

NO >> • Check connector housings for disconnected or loose terminals.  
• Repair harness or connector.

## 6. REAR DOOR SPEAKER SIGNAL CHECK

# WOOFER

## < COMPONENT DIAGNOSIS >

## [BOSE AUDIO WITH NAVIGATION]

1. Connect AV control unit connector M42 and BOSE speaker amp. connector M113.
2. Turn ignition switch to ACC.
3. Push "POWER" switch.
4. Check the signal between AV control unit harness connector M42 terminals with CONSULT-III or oscilloscope.

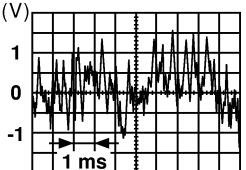
Connector	Terminals		Condition	Reference signal
	(+)	(-)		
M42	4	5	Receive audio signal	 <p style="text-align: right; font-size: small;">SKIA0177E</p>
	13	14		

Is the audio signal voltage reading as specified?

- YES >> Replace BOSE speaker amp. Refer to [AV-450. "Removal and Installation"](#).
- NO >> Replace AV control unit. Refer to [AV-438. "Removal and Installation"](#).

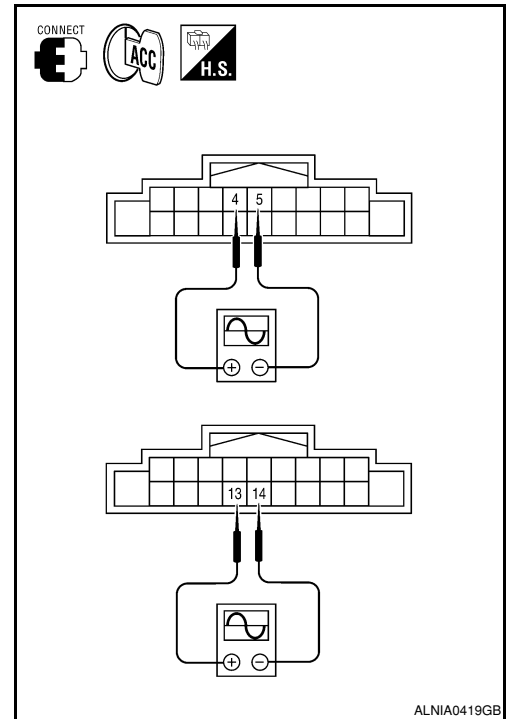

# AMP ON SIGNAL CIRCUIT

< COMPONENT DIAGNOSIS >

[BOSE AUDIO WITH NAVIGATION]

## AMP ON SIGNAL CIRCUIT

### Description

INFOID:000000001317825

When the audio system is turned on, a voltage signal is supplied from the AV control unit to the BOSE speaker amp. When this signal is received, the BOSE speaker amp. will turn on.

### Diagnosis Procedure

INFOID:000000001317826

#### 1. CHECK AMP ON SIGNAL (BOSE SPEAKER AMP)

1. Turn audio system ON.
2. Check voltage between BOSE speaker amp. harness connector M113 terminal 31 and ground.

**31 - Ground : Battery voltage**

Is battery voltage present?

- YES >> Inspection End.  
NO >> GO TO 2

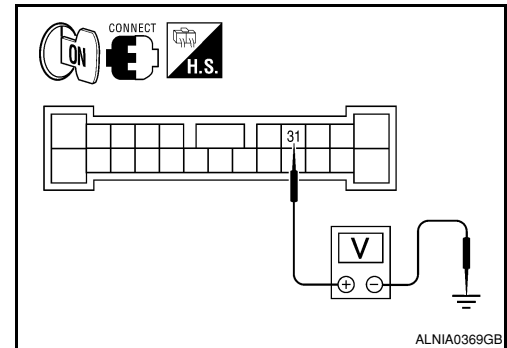

#### 2. CHECK AMP ON SIGNAL (AV CONTROL UNIT)

Check voltage between AV control unit harness connector M42 terminal 1 and ground.

**1 - Ground : Battery voltage**

Is battery voltage present?

- YES >> Repair harness or connector.  
NO >> Replace AV control unit. Refer to [AV-438. "Removal and Installation"](#).

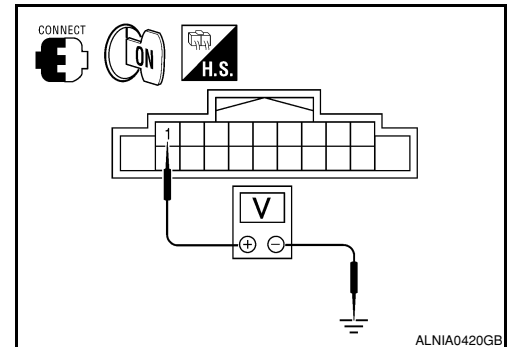

A  
B  
C  
D  
E  
F  
G  
H  
I  
J  
K  
L  
M  
O  
P

AV

# STEERING SWITCH

< COMPONENT DIAGNOSIS >

[BOSE AUDIO WITH NAVIGATION]

## STEERING SWITCH

### Description

INFOID:000000001317827

When one of the steering wheel audio control switches is pushed, the resistance in the steering wheel audio control switch circuit changes depending on which button is pushed.

### Diagnosis Procedure

INFOID:000000001317828

#### 1. CHECK STEERING WHEEL AUDIO CONTROL SWITCH RESISTANCE

1. Turn ignition switch OFF.
2. Disconnect steering wheel audio control switch connector M102.
3. Check resistance between steering switch connector terminals.

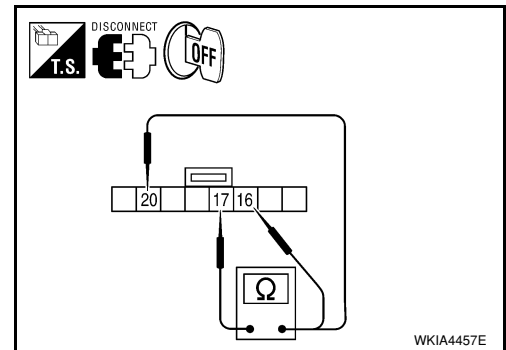

Terminal	Signal name	Condition	Resistance (Ω) (Approx.)	
16	17	Seek (down)	Depress ▽ switch.	165
		Volume (down)	Depress VOL down switch.	487
		Phone/Send	Depress MODE switch.	0
20	17	Seek (up)	Depress △ switch.	165
		Volume (up)	Depress VOL up switch.	487
		Mode/End	Depress ↶ ↷ switch.	0

Do the steering wheel audio control switches check OK?

YES >> GO TO 2

NO >> Replace steering wheel audio control switch. Refer to [AV-447, "Removal and Installation"](#).

#### 2. CHECK HARNESS

1. Turn ignition switch OFF.
2. Disconnect AV control unit connector M42 and spiral cable connector M30.
3. Check continuity between AV control unit harness connector M42 (A) and spiral cable harness connector M30 (B).

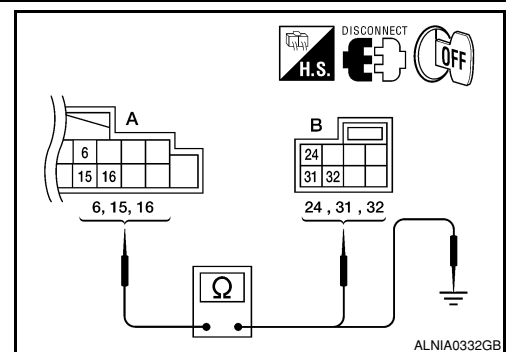

A		B		Continuity
Connector	Terminal	Connector	Terminal	
M42	6	M30	24	Yes
	15		31	
	16		32	

4. Check continuity between AV control unit connector M42 (A) and ground.

A		—	Continuity
Connector	Terminal		
M42	6	Ground	No
	15		
	16		

Are the continuity results as specified?

YES >> GO TO 3

NO >> Repair harness.



# STEERING SWITCH

< COMPONENT DIAGNOSIS >

[BOSE AUDIO WITH NAVIGATION]

## 3. SPIRAL CABLE CHECK

1. Disconnect spiral cable connector M102.
2. Check continuity between spiral cable harness connector M30 (A) and M102 (B).

Spiral cable				Continuity
Connector	Terminal	Connector	Terminal	
M30	24	M102	20	Yes
	31		17	
	32		16	

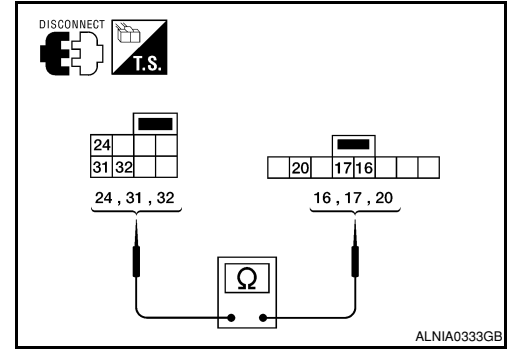

Does the spiral cable check OK?

- YES >> Inspection End.
- NO >> Replace spiral cable. Refer to [SR-6, "Removal and Installation"](#).

A  
B  
C  
D  
E  
F  
G  
H  
I  
J  
K  
L  
M  
N  
O  
P

AV

# MICROPHONE SIGNAL CIRCUIT

< COMPONENT DIAGNOSIS >

[BOSE AUDIO WITH NAVIGATION]

## MICROPHONE SIGNAL CIRCUIT

### Description

INFOID:000000001317833

Voice signals are transmitted from the microphone to the AV control unit using the microphone signal circuits.

### Diagnosis Procedure

INFOID:000000001317834

#### 1. CHECK HARNESS BETWEEN AV CONTROL UNIT AND MICROPHONE

1. Turn ignition switch OFF.
2. Disconnect AV control unit connector and microphone connector.
3. Check continuity between AV control unit harness connector M45 (A) and microphone harness connector R109 (B).

A		B		Continuity
Connector	Terminal	Connector	Terminal	
M45	72	R109	1	Yes
	71		2	
	70		4	

4. Check continuity between AV control unit harness connector M45 (A) and ground.

A		—	Continuity
Connector	Terminal		
M45	70	Ground	No
	71		
	72		

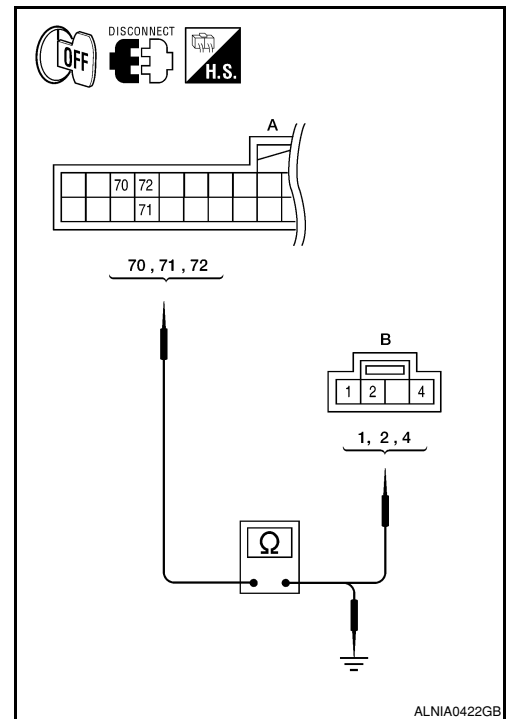

ALNIA0422GB

Are the continuity test results as specified?

- YES >> GO TO 2  
 NO >> Repair harness or connector.

#### 2. CHECK MICROPHONE POWER SUPPLY

1. Connect AV control unit connector and microphone connector.
2. Turn ignition switch ON.
3. Check voltage between microphone harness connector R109 terminal 4 and ground.

**4 - Ground : Approx. 5V**

Is voltage reading approx. 5 volts?

- YES >> GO TO 3  
 NO >> Replace AV control unit. Refer to [AV-438, "Removal and Installation"](#).

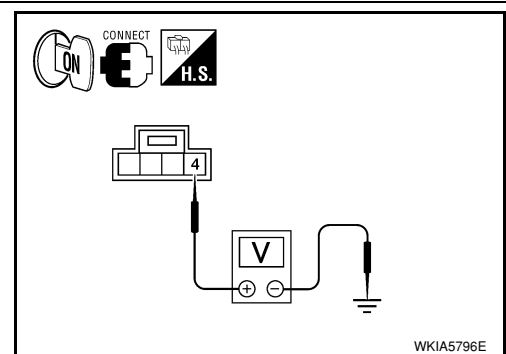

WKIA5796E

#### 3. CHECK MICROPHONE SIGNAL

# MICROPHONE SIGNAL CIRCUIT

[BOSE AUDIO WITH NAVIGATION]

## < COMPONENT DIAGNOSIS >

Check signal between AV control unit harness connector M45 terminals 71 and 72.

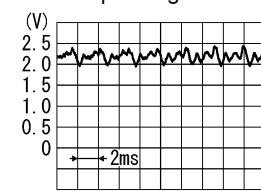
Connector	(+)	(-)	Reference signal
	Terminal	Terminal	
M45	71	72	<p>While speaking into MIC</p>  <p>PKIB5037J</p>

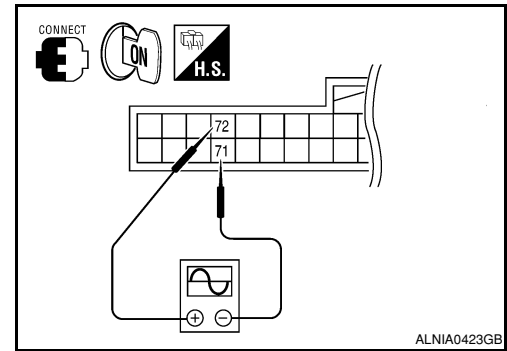

Are voltage readings as specified?

- YES >> Replace AV control unit. Refer to [AV-438, "Removal and Installation"](#).
- NO >> Replace microphone. Refer to [AV-454, "Removal and Installation"](#).

A  
B  
C  
D  
E  
F  
G  
H  
I  
J  
K  
L  
M  
O  
P

AV

# AV CONTROL UNIT

< ECU DIAGNOSIS >

[BOSE AUDIO WITH NAVIGATION]

## ECU DIAGNOSIS

### AV CONTROL UNIT

#### Reference Value

INFOID:000000001396340

#### VALUES ON THE DIAGNOSIS TOOL

CONSULT-III data monitor item

Display Item	Display	Vehicle status	Remarks
VHCL SPD SIG	ON	Vehicle speed >0 km/h (0 MPH)	Changes in indication may be delayed. This is normal.
	OFF	Vehicle speed =0 km/h (0 MPH)	
PKB SIG	ON	Parking brake is applied.	Changes in indication may be delayed. This is normal.
	OFF	Parking brake is released.	
ILLUM SIG	ON	Block the light beam from the auto light optical sensor when the light SW is ON.	—
	OFF	Expose the auto light optical sensor to light when the light SW is OFF or ON.	
IGN SIG	ON	Ignition switch ON	—
	OFF	Ignition switch in ACC position	
REV SIG	ON	Selector lever in R position	Changes in indication may be delayed. This is normal.
	OFF	Selector lever in any position other than R	

#### TERMINAL LAYOUT

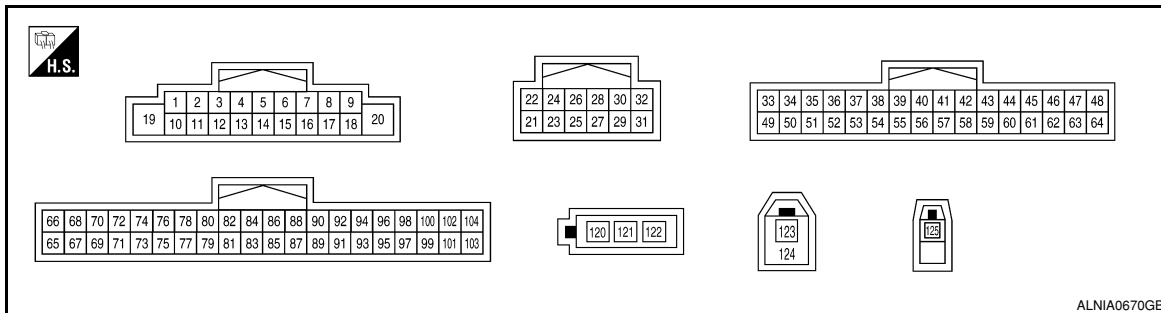

ALNIA0670GB

#### PHYSICAL VALUES





Terminal (Wire color)		Description		Condition		Reference value (Approx.)
+	-	Signal name	Input/ Output			
1 (GR/L)	Ground	Amp. ON signal	Output	Ignition switch ON	—	12V
2 (LG)	3 (V)	Pre-amp. audio signal front LH	Output	Ignition switch ON	Audio output	

SKIB3609E

# AV CONTROL UNIT

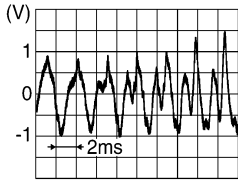
< ECU DIAGNOSIS >

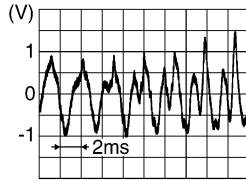
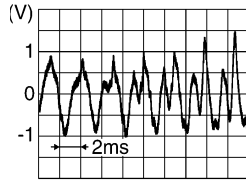
[BOSE AUDIO WITH NAVIGATION]

Terminal (Wire color)		Description		Condition		Reference value (Approx.)
+	-	Signal name	Input/ Output			
4 (L)	5 (B/W)	Pre-amp. audio signal rear LH	Output	Ignition switch ON	Audio output	 <p style="text-align: right; font-size: small;">SKIB3609E</p>
6 (Y)	15	Steering switch signal A	Input	Ignition switch ON	Pressing  switch	0V
					Pressing  switch	0.75
					Pressing VOL up switch	2V
					Except for above	5V
7 (V)	Ground	ACC power supply	Input	Ignition switch ACC	-	Battery voltage
9 (R/L)	Ground	Illumination signal	Input	OFF	Lighting switch is OFF	0V
					Lighting switch is ON	12V
10	—	Shield	—	—	—	—
11 (BR)	12 (B/R)	Pre-amp. audio signal front RH	Output	Ignition switch ON	Audio output	 <p style="text-align: right; font-size: small;">SKIB3609E</p>
13 (W)	14 (B)	Audio signal rear RH	Output	Ignition switch ON	Audio output	 <p style="text-align: right; font-size: small;">SKIB3609E</p>
15	Ground	Steering switch signal ground	—	Ignition switch ON	—	0V
16 (G)	15	Steering switch signal B	Input	Ignition switch ON	Pressing  switch	0V
					Pressing  switch	0.75V
					Pressing VOL down switch	2V
					Except for above	5V
19 (Y)	Ground	Battery power supply	Input	Ignition switch OFF	—	Battery voltage
20 (B)	Ground	Ground	—	Ignition switch ON	—	0V

A  
B  
C  
D  
E  
F  
G  
H  
I  
J  
K  
L  
M  
AV  
O  
P

# AV CONTROL UNIT

< ECU DIAGNOSIS >

[BOSE AUDIO WITH NAVIGATION]

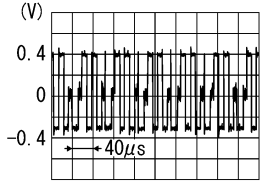
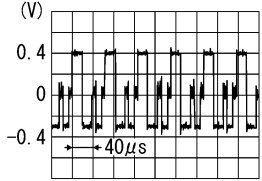
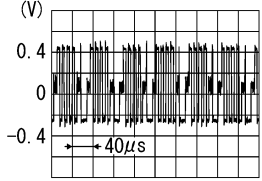
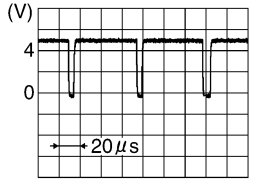
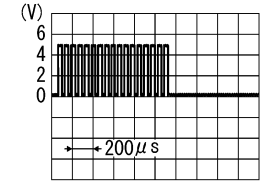
Terminal (Wire color)		Description		Condition	Reference value (Approx.)	
+	-	Signal name	Input/ Output			
21 (W)	24	RGB signal (R: red)	Output	Ignition switch ON	Start confirmation/adjust- ment mode, and then dis- play color bar by selecting "Color Spectrum Bar" on DISPLAY DIAGNOSIS screen.   <small>SKIB2238J</small>	
22 (B)	24	RGB signal (G: green)	Output	Ignition switch ON	Start confirmation/adjust- ment mode, and then dis- play color bar by selecting "Color Spectrum Bar" on DISPLAY DIAGNOSIS screen.   <small>SKIB2236J</small>	
23 (R)	24	RGB signal (B: blue)	Output	Ignition switch ON	Start confirmation/adjust- ment mode, and then dis- play color bar by selecting "Color Spectrum Bar" on DISPLAY DIAGNOSIS screen.   <small>SKIB2237J</small>	
24	Ground	RGB signal ground	—	Ignition switch OFF	—  0V	
25 (W)	26	RGB synchronizing signal	Output	Ignition switch ON	—   <small>SKIB3603E</small>	
26 (G)	Ground	RGB synchronizing signal ground	—	Ignition switch ON	—  0V	
27 (O)	Ground	RGB area (YS) signal	Output	Ignition switch ON	At RGB image displayed	5V
					At rear view camera image displayed	 <small>PKIB4948J</small>

# AV CONTROL UNIT

< ECU DIAGNOSIS >

[BOSE AUDIO WITH NAVIGATION]

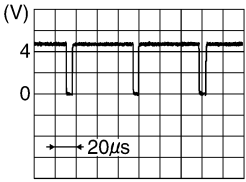
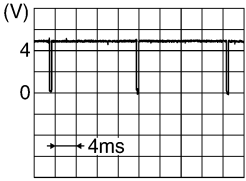
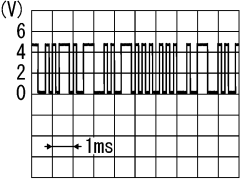
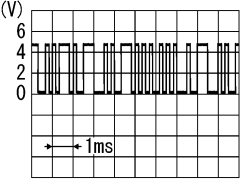
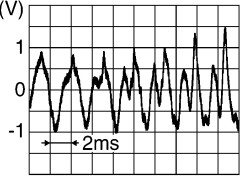
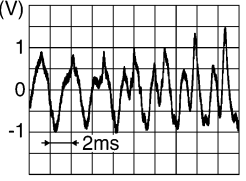
Terminal (Wire color)		Description		Condition		Reference value (Approx.)
+	-	Signal name	Input/ Output			
28 (W/L)	Ground	Horizontal synchronizing (HP) signal	Input	Ignition switch ON	—	 <p style="text-align: right; font-size: small;">SKIB3601E</p>
29 (O/L)	Ground	Vertical synchronizing (VP) signal	Input	Ignition switch On	—	 <p style="text-align: right; font-size: small;">SKIB3598E</p>
30 (V)	Ground	Communication signal (CONT→DISP)	Output	Ignition switch ON	When adjusting display- brightness	 <p style="text-align: right; font-size: small;">PKIB5039J</p>
31 (LG)	Ground	Communication signal (DISP→CONT)	Input	Ignition switch ON	When adjusting display- brightness	 <p style="text-align: right; font-size: small;">PKIB5039J</p>
32	—	Shield	—	—	—	—
39 (W)	55 (B)	DVD audio signal LH	Input	Ignition switch ON	When DVD player is oper- ating	 <p style="text-align: right; font-size: small;">SKIB3609E</p>
40 (R)	56 (G)	DVD audio signal RH	Input	Ignition switch ON	When DVD player is oper- ating	 <p style="text-align: right; font-size: small;">SKIB3609E</p>
45 (SB)	Ground	CD/DVD eject signal	Input	—	Pressing the eject switch	0V
				—	Except for above	3.3V
46	—	Shield	—	—	—	—

A  
B  
C  
D  
E  
F  
G  
H  
I  
J  
K  
L  
M  
O  
P

AV

# AV CONTROL UNIT

< ECU DIAGNOSIS >

[BOSE AUDIO WITH NAVIGATION]

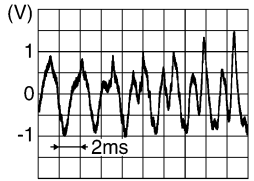
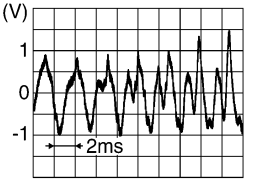
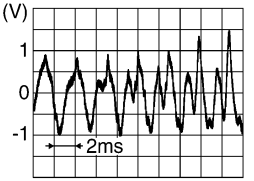
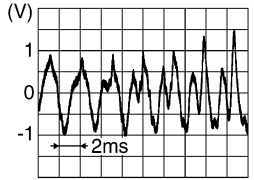
Terminal (Wire color)		Description		Condition		Reference value (Approx.)
+	-	Signal name	Input/ Output			
47 (W)	48 (R)	AUX jack audio signal LH	Input	Ignition switch ON	When AUX mode is select- ed	 <p style="text-align: right; font-size: small;">SKIB3609E</p>
58 (O/L)	42 (W)	Headphone LH audio sig- nal	Output	Ignition switch ON	When DVD player is oper- ating	 <p style="text-align: right; font-size: small;">SKIB3609E</p>
59 (W/L)	43 (O)	Headphone RH audio sig- nal	Output	Ignition switch ON	When DVD player is oper- ating	 <p style="text-align: right; font-size: small;">SKIB3609E</p>
60	—	Shield	—	—	—	—
62 (B)	Ground	A/C and AV switch assem- bly ground	—	Ignition switch ON	—	0V
63 (B)	48 (R)	AUX jack audio signal RH	Input	Ignition switch ON	When AUX mode is select- ed	 <p style="text-align: right; font-size: small;">SKIB3609E</p>
66 (Y)	Ground	Battery power supply	Input	Ignition switch OFF	—	Battery voltage
68 (Y)	Ground	Battery power supply	Input	Ignition switch OFF	—	Battery voltage
69 (V)	Ground	ACC power supply	Input	Ignition switch ACC	—	Battery voltage
70 (R/W)	Ground	MIC power	Output	Ignition switch ON	—	5V
72 (B)	71 (R/L)	MIC signal	Input	Ignition switch ON	—	—



# AV CONTROL UNIT

< ECU DIAGNOSIS >

[BOSE AUDIO WITH NAVIGATION]

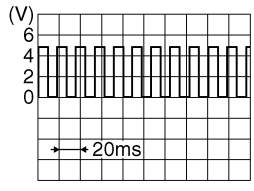
Terminal (Wire color)		Description		Condition		Reference value (Approx.)
+	-	Signal name	Input/ Output			
79 (G/R)	Ground	IGN ON or START power supply	Input	Ignition switch ON or START	—	Battery voltage
80 (GR/R)	Ground	Parking brake signal	Input	Ignition switch ON	Parking brake ON	0V
					Parking brake OFF	12V
81 (G/W)	Ground	Reverse signal	Input	Ignition switch ON	R position	12V
					Other than R position	0V
82 (W/R)	Ground	Vehicle speed signal (8-pulse)	Input	Ignition switch ON	When vehicle speed is approx. 40 km/h (25MPH)	 <p style="text-align: right; font-size: small;">SKIA6649J</p>
84 (BR)	—	Rear view camera control signal	Input	—	—	—
92 (W/L)	—	AV communication signal 2 (H)	Input/ Output	—	—	—
93 (P/B)	—	AV communication signal 2 (L)	Input/ Output	—	—	—
94 (W/L)	—	AV communication signal 1 (H)	Input/ Output	—	—	—
95 (P/B)	—	AV communication signal 1 (L)	Input/ Output	—	—	—
96 (L)	—	CAN-H	Input/ Output	—	—	—
97 (P)	—	CAN-L	Input/ Output	—	—	—
121	Ground	Antenna amp. ON signal	Output	Ignition switch ACC	—	12V
122	—	Amplified window antenna signal	Input	—	—	—
123	—	GPS antenna signal	—	—	—	—
124	—	Shield	—	—	—	—
125	—	Satellite antenna signal	Input	Ignition switch ACC	—	—

A  
B  
C  
D  
E  
F  
G  
H  
I  
J  
K  
L  
M  
AV  
O  
P



# AV CONTROL UNIT

< ECU DIAGNOSIS >

[BOSE AUDIO WITH NAVIGATION]

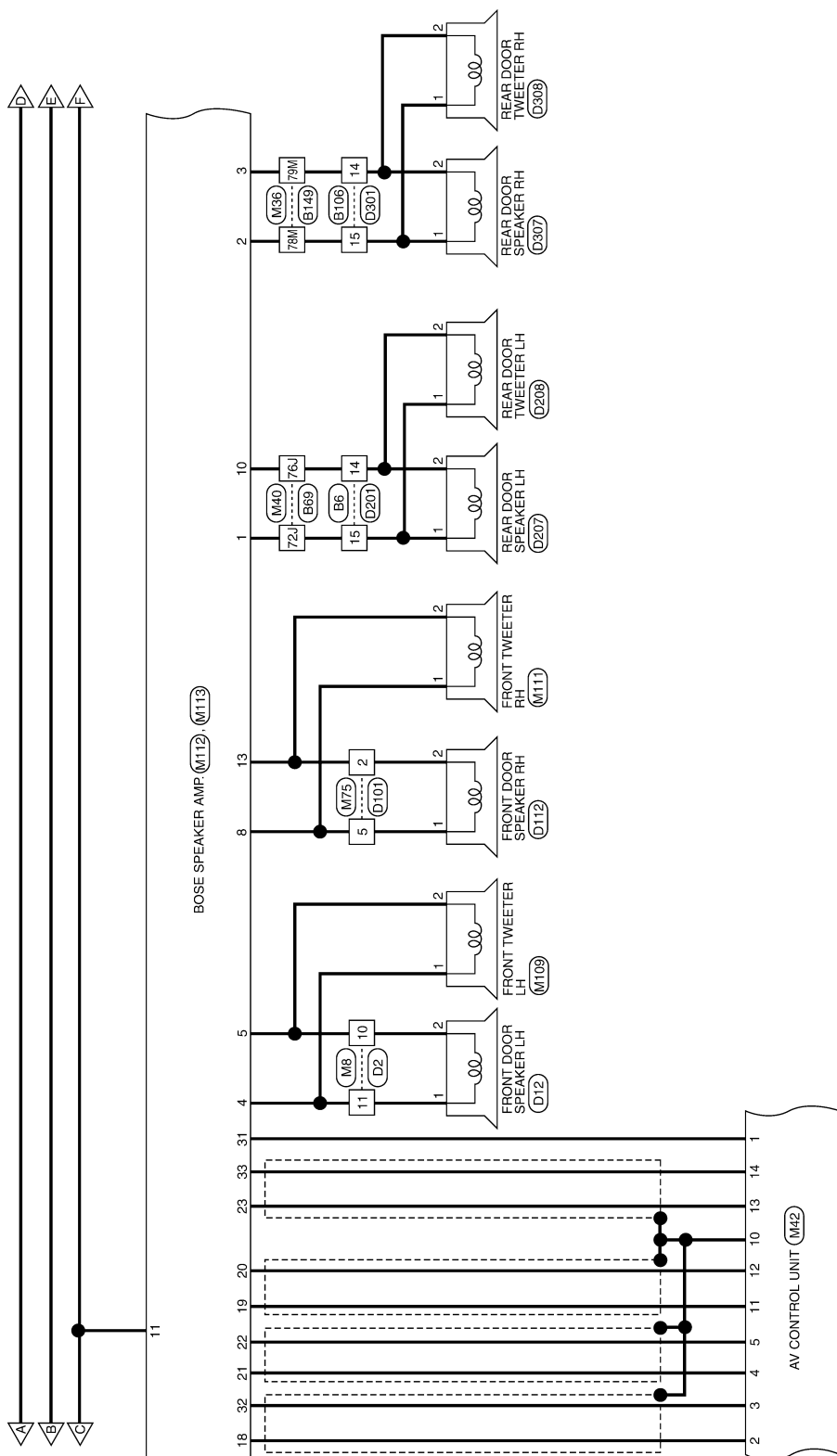

ALNWA0084GE

A  
B  
C  
D  
E  
F  
G  
H  
I  
J  
K  
L  
M  
N  
O  
P

AV

# AV CONTROL UNIT

< ECU DIAGNOSIS >

[BOSE AUDIO WITH NAVIGATION]

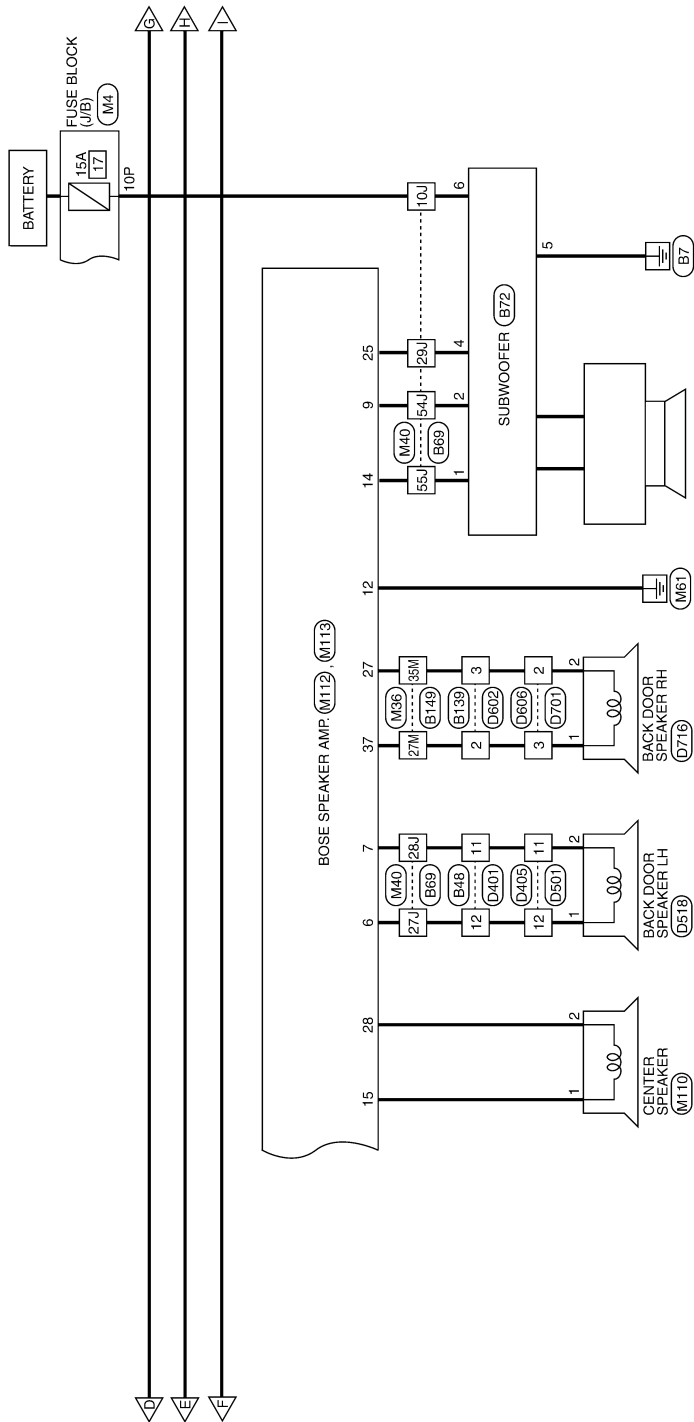

ALNWA0085GE

# AV CONTROL UNIT

< ECU DIAGNOSIS >

[BOSE AUDIO WITH NAVIGATION]

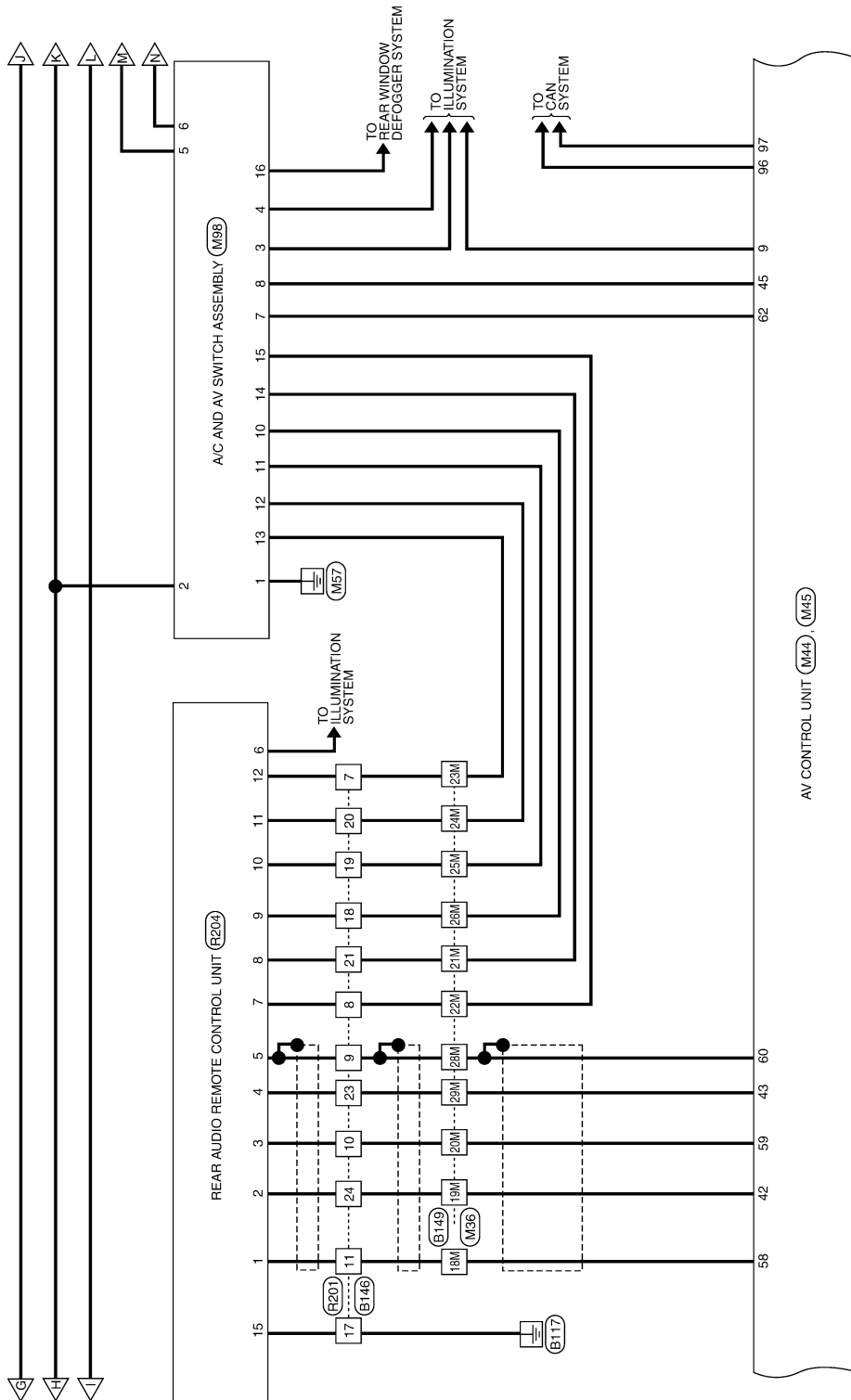

ALNWA0086GE

A  
B  
C  
D  
E  
F  
G  
H  
I  
J  
K  
L  
M  
N  
O  
P

AV

# AV CONTROL UNIT

< ECU DIAGNOSIS >

[BOSE AUDIO WITH NAVIGATION]

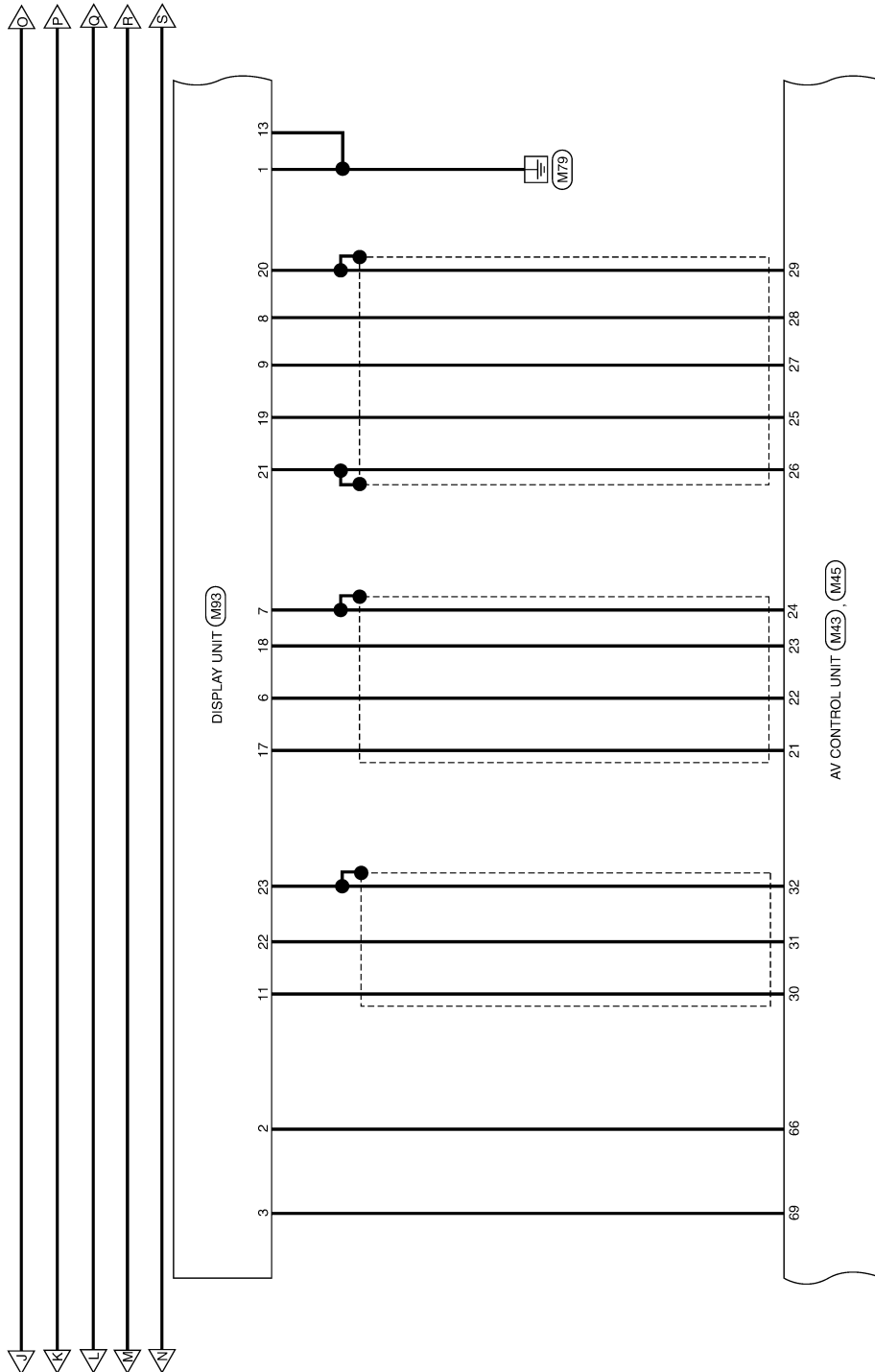

ALNWA0087GE

# AV CONTROL UNIT

< ECU DIAGNOSIS >

[BOSE AUDIO WITH NAVIGATION]

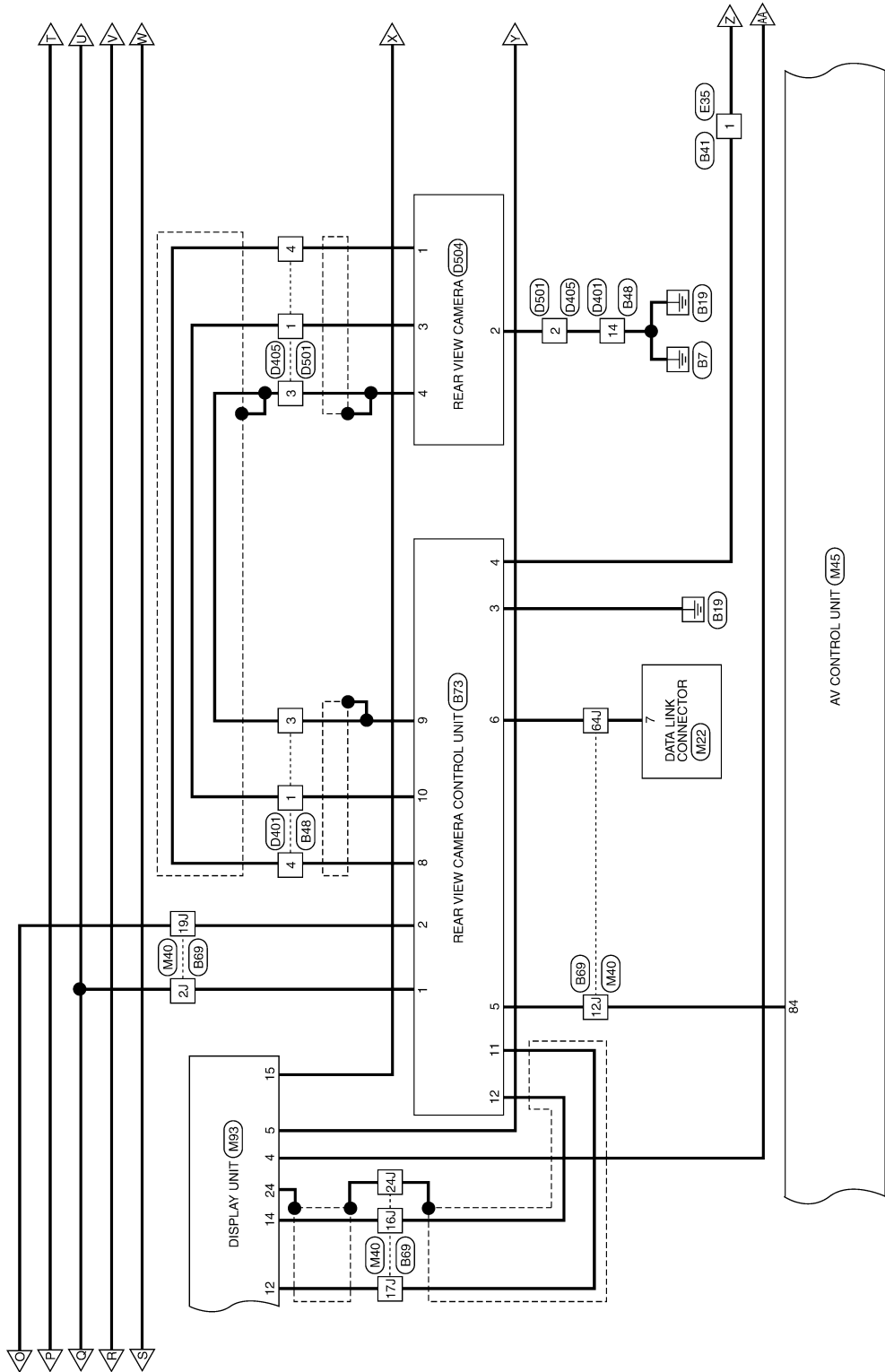

ALNWA0088GE

A  
B  
C  
D  
E  
F  
G  
H  
I  
J  
K  
L  
M  
N  
O  
P

AV

# AV CONTROL UNIT

< ECU DIAGNOSIS >

[BOSE AUDIO WITH NAVIGATION]

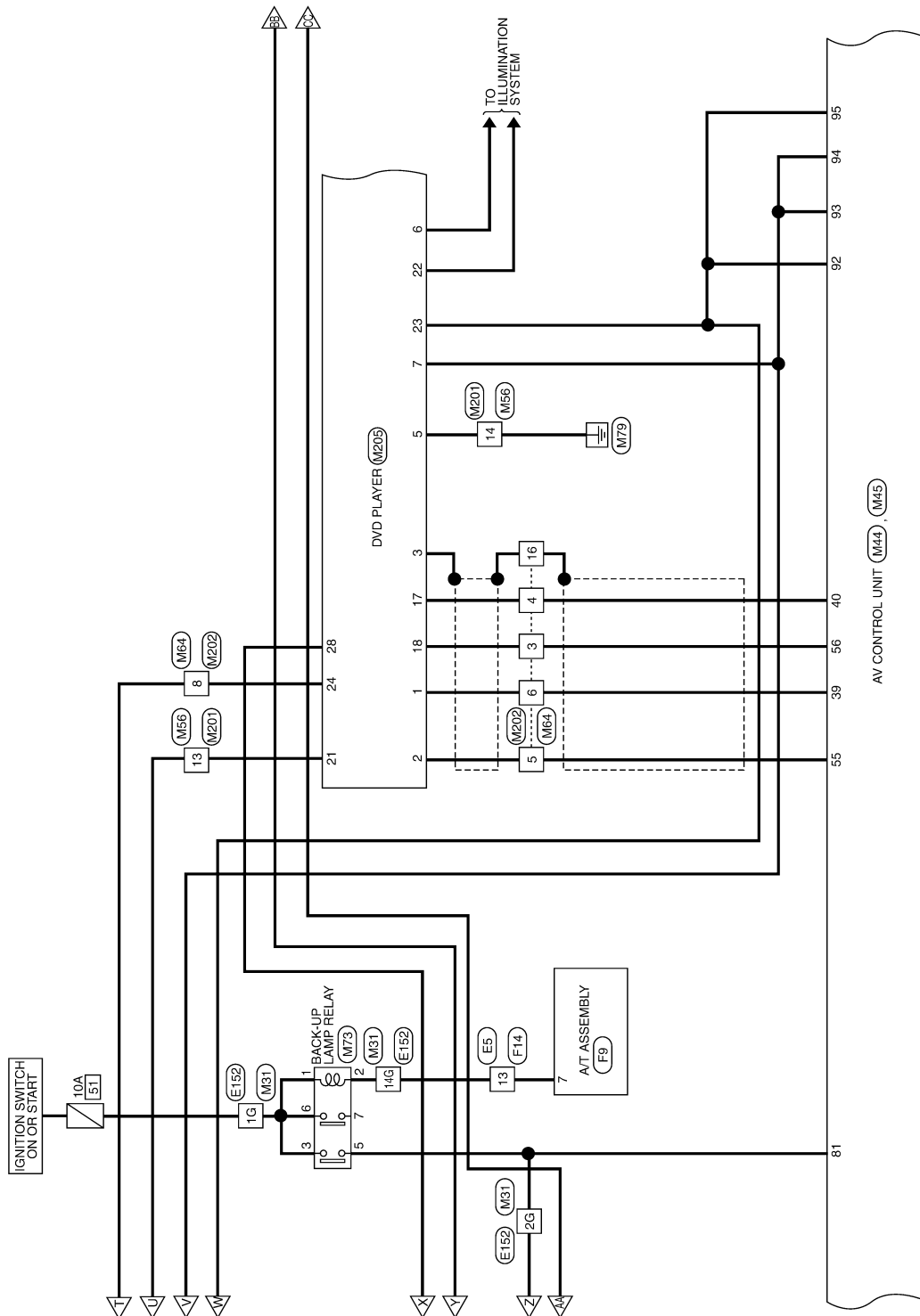

ALNWA0089GE



# AV CONTROL UNIT

< ECU DIAGNOSIS >

[BOSE AUDIO WITH NAVIGATION]

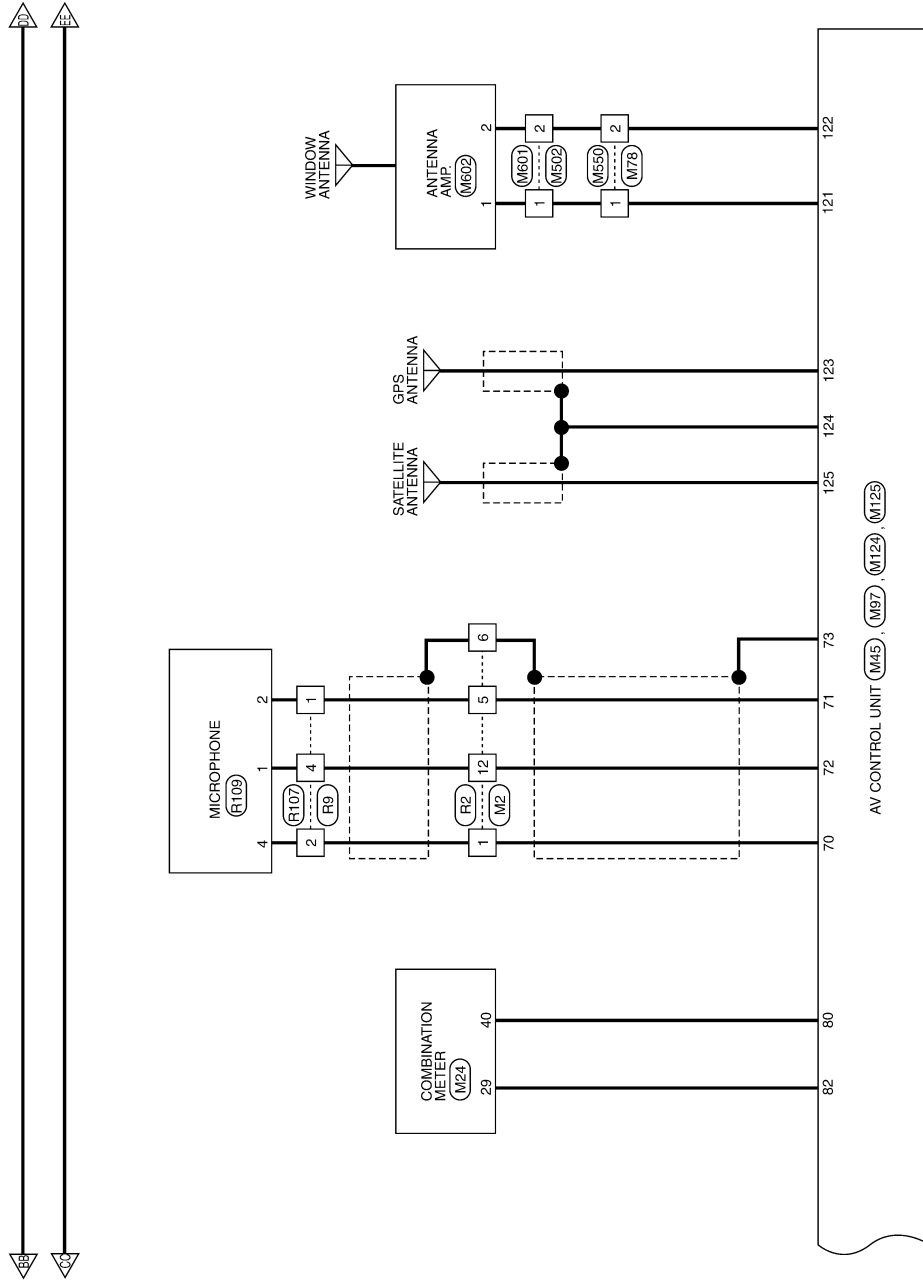

A  
B  
C  
D  
E  
F  
G  
H  
I  
J  
K  
L  
M  
AV  
O  
P

ALNWA0091GE

# AV CONTROL UNIT

< ECU DIAGNOSIS >

[BOSE AUDIO WITH NAVIGATION]

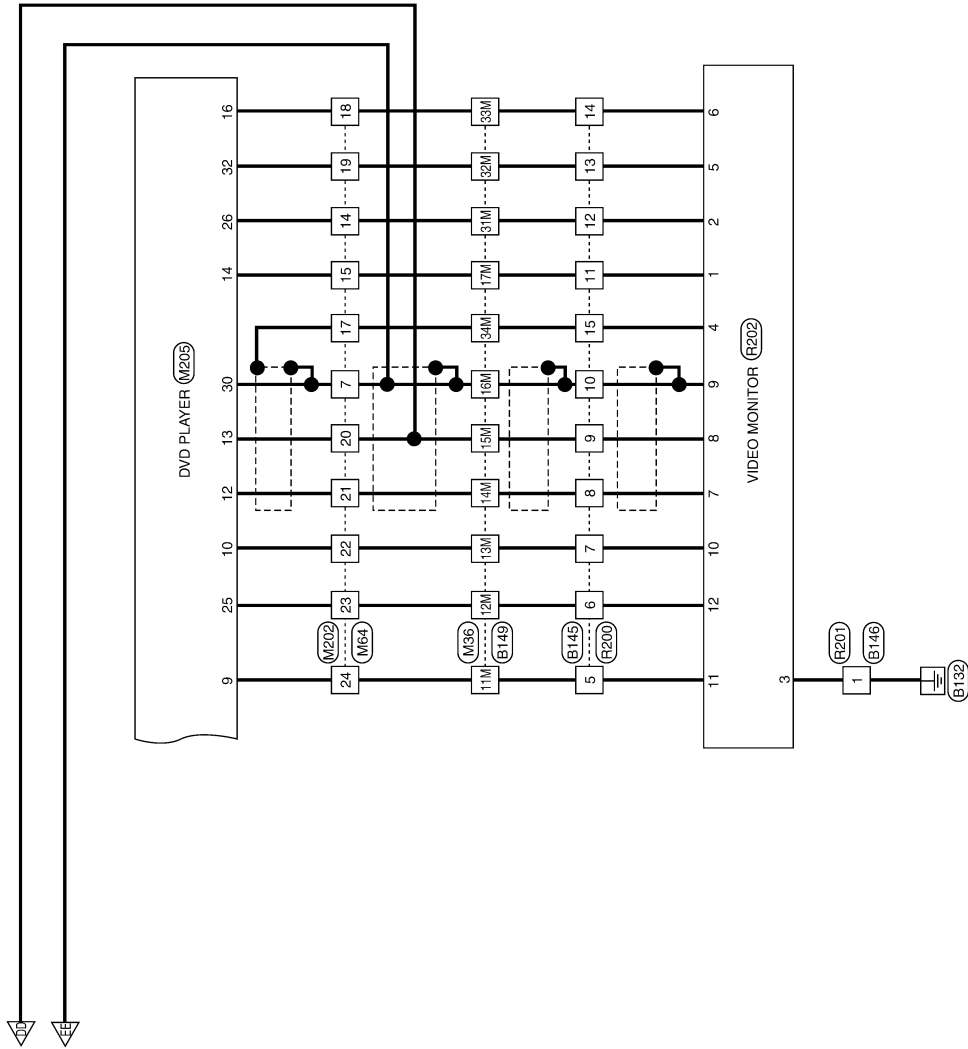

ALNWA0090GE

## BOSE AUDIO SYSTEM (WITH NAVI) CONNECTORS

Connector No.	M2
Connector Name	WIRE TO WIRE
Connector Color	WHITE

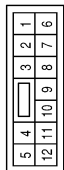

Terminal No.	Color of Wire	Signal Name
1	R/W	-
5	R/L	-
6	SHILD	-
12	B	-

Connector No.	M4
Connector Name	FUSE BLOCK (J/B)
Connector Color	WHITE



Terminal No.	Color of Wire	Signal Name
4P	V	-
10P	GR	-

Connector No.	M8
Connector Name	WIRE TO WIRE
Connector Color	WHITE



Terminal No.	Color of Wire	Signal Name
10	L/R	-
11	L/W	-

Connector No.	M22
Connector Name	DATA LINK CONNECTOR
Connector Color	WHITE

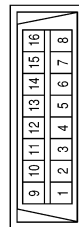

Terminal No.	Color of Wire	Signal Name
7	G/W	K-LINE

Connector No.	M24
Connector Name	COMBINATION METER
Connector Color	WHITE

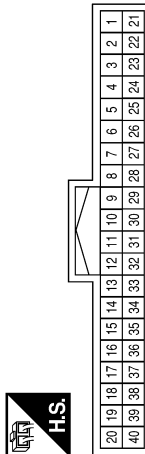

Terminal No.	Color of Wire	Signal Name
29	W/R	SPEED_8P
40	GR/R	-

Connector No.	M30
Connector Name	COMBINATION SWITCH (SPIRAL CABLE)
Connector Color	GRAY

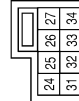

Terminal No.	Color of Wire	Signal Name
24	Y	STRG_SW_A
31	SHIELD	STRG_SW_C
32	BR	STRG_SW_B

# AV CONTROL UNIT

< ECU DIAGNOSIS >

[BOSE AUDIO WITH NAVIGATION]

Connector No.	M31
Connector Name	WIRE TO WIRE
Connector Color	WHITE

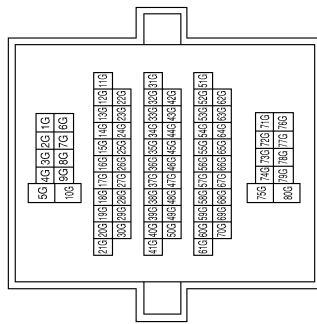

Terminal No.	Color of Wire	Signal Name
1G	G	-
2G	G/W	-
5G	Y	-
14G	R	-

Connector No.	M36
Connector Name	WIRE TO WIRE
Connector Color	WHITE

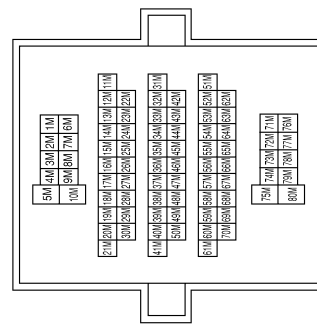

Terminal No.	Color of Wire	Signal Name
11M	SB	-
12M	BR	-
13M	G/Y	-
14M	B/W	-
15M	L	-
16M	SHIELD	-
17M	B/W	-
18M	O/L	-
19M	W	-
20M	W/L	-
21M	R	-
22M	Y	-
23M	G	-
24M	BR	-

Terminal No.	Color of Wire	Signal Name
25M	LG	-
26M	GR	-
27M	W/R	-
28M	SHIELD	-
29M	O	-
31M	B/Y	-
32M	BR	-
33M	Y	-
34M	SHIELD	-
35M	L	-
78M	O/L	-
79M	R/L	-

ALNIA0497GB

# AV CONTROL UNIT

< ECU DIAGNOSIS >

[BOSE AUDIO WITH NAVIGATION]

Connector No.	M39
Connector Name	FUSE BLOCK (J/B)
Connector Color	WHITE

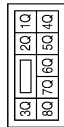

Terminal No.	Color of Wire	Signal Name
1Q	G/R	-

Connector No.	M40
Connector Name	WIRE TO WIRE
Connector Color	WHITE

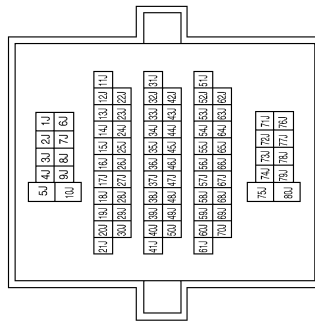

Terminal No.	Color of Wire	Signal Name
2J	Y	-
10J	R	-
12J	B	-
16J	W	-
17J	V	-
19J	SHIELD	-
24J	G	-
27J	R	-
28J	SB	-
29J	W/G	-
54J	W	-
55J	B	-
64J	G/W	-
72J	SB	-
76J	B/Y	-

Connector No.	M42
Connector Name	AV CONTROL UNIT
Connector Color	WHITE

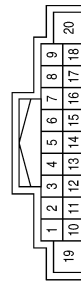

Terminal No.	Color of Wire	Signal Name
1	GR/L	AMP_ON
2	LG	FR_LH_PRE+
3	V	FR_LH_PRE-
4	L	RR_LH_PRE+
5	B/W	RR_LH_PRE-

Terminal No.	Color of Wire	Signal Name
6	Y	STRG_SW_A
7	V	ACC
8	-	-
9	R/L	ILL
10	SHIELD	SHIELD
11	BR	FR_RH_PRE+
12	B/R	FR_RH_PRE-
13	W	RR_RH_PRE+
14	B	RR_RH_PRE-
15	SHIELD	STRG_SW_GND
16	G	STRG_SW_B
17	-	-
19	Y	B+
20	B	GND

ALNIA0498GB

A  
B  
C  
D  
E  
F  
G  
H  
I  
J  
K  
L  
M  
N  
O  
P

AV

# AV CONTROL UNIT

< ECU DIAGNOSIS >

[BOSE AUDIO WITH NAVIGATION]

Connector No.	M43
Connector Name	AV CONTROL UNIT
Connector Color	WHITE

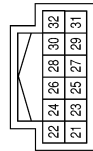

Terminal No.	Color of Wire	Signal Name
21	W	R
22	B	G

Terminal No.	Color of Wire	Signal Name
23	R	B
24	SHIELD	RGB_GND
25	W	RGB_SYNC
26	SHIELD	RGB_SYNC_GND
27	O	YS
28	W/L	HP
29	O/L	VP
30	V	IT_DISP
31	LG	DISP_IT
32	SHIELD	SHIELD

Connector No.	M44
Connector Name	AV CONTROL UNIT
Connector Color	WHITE

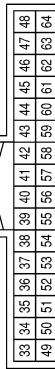

Terminal No.	Color of Wire	Signal Name
33	-	-
34	-	-
35	-	-
36	-	-
37	-	-
38	-	-

Terminal No.	Color of Wire	Signal Name
39	W	AUDIO_BUS_LH+
40	R	AUDIO_BUS_RH+
41	-	-
42	W	HP_LH-
43	O	HP_RH-
44	-	-
45	SB	CD_DVD_EJECT
46	SHIELD	SHIELD
47	W	AUX_AUDIO_LH+
48	R	AUX_GND
49	-	-
50	-	-
51	-	-
52	-	-
53	-	-

Terminal No.	Color of Wire	Signal Name
54	-	-
55	B	AUDIO_BUS_LH-
56	G	AUDIO_BUS_RH-
58	O/L	HP_LH+
59	W/L	HP_RH+
60	SHIELD	HP_SHIELD
61	-	-
62	B	SW_GND
63	B	AUX_AUDIO_RH+
64	-	-

ALNIA0499GB

# AV CONTROL UNIT

< ECU DIAGNOSIS >

[BOSE AUDIO WITH NAVIGATION]

Connector No.	M56
Connector Name	WIRE TO WIRE
Connector Color	WHITE



1	2	3	4	5	6	7		
8	9	10	11	12	13	14	15	16

Terminal No.	Color of Wire	Signal Name
13	Y	-
14	B	-

Terminal No.	Color of Wire	Signal Name
69	V	ACC
70	R/W	MIC_VCC_(PWR)
71	R/L	MIC_GND_(IN-)
72	B	MIC_GND_(IN+)
73	SHIELD	MIC_SHIELD
79	G/R	IGN
80	G/R/R	PKB_SIG
81	G/W	REVERSE_SIG
82	W/R	SPEED_8P
84	BR	RV_CAM_SIG
96	L	CAN-H
97	P	CAN-L

Connector No.	M45
Connector Name	AV CONTROL UNIT
Connector Color	WHITE



66	68	70	72	74	76	78	80	82	84	86	88	90	92	94	96	98	100	102	104
65	67	69	71	73	75	77	79	81	83	85	87	89	91	93	95	97	99	101	103

Terminal No.	Color of Wire	Signal Name
66	Y	+B
68	Y	+B

Connector No.	M64
Connector Name	WIRE TO WIRE
Connector Color	BROWN



1	2	3	4	5	6	7	8	9	10	11		
12	13	14	15	16	17	18	19	20	21	22	23	24

Terminal No.	Color of Wire	Signal Name
3	G	-
4	R	-
5	B	-
6	W	-
7	SHIELD	-
8	V	-

Terminal No.	Color of Wire	Signal Name
11	B/W	-
14	B/Y	-
15	B/W	-
16	SHIELD	-
17	SHIELD	-
18	Y	-
19	BR	-
20	L	-
21	B/W	-
22	G/Y	-
23	BR	-
24	SB	-

ALNIA0500GB

A  
B  
C  
D  
E  
F  
G  
H  
I  
J  
K  
L  
M  
N  
O  
P

AV

# AV CONTROL UNIT

< ECU DIAGNOSIS >

[BOSE AUDIO WITH NAVIGATION]

Connector No.	M78
Connector Name	WIRE TO WIRE
Connector Color	BROWN



Terminal No.	Color of Wire	Signal Name
1	B	-
2	B	-

Connector No.	M75
Connector Name	WIRE TO WIRE
Connector Color	BROWN

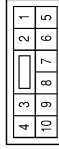

Terminal No.	Color of Wire	Signal Name
2	L/B	-
5	W/B	-

Connector No.	M73
Connector Name	BACK-UP LAMP RELAY
Connector Color	BROWN



Terminal No.	Color of Wire	Signal Name
1	R	-
2	G	-
3	Y/R	-
5	W/B	-

Terminal No.	Color of Wire	Signal Name
6	B	G
7	SHIELD	RGB_GND
8	W/L	HP
9	O	YS
11	V	IT-DISP
12	W	COMP2_IN+
13	B	INV_GND
14	B	COMP2_IN -
15	B/W	COMP1_IN+
17	W	R
18	R	B
19	W	RGB_SYNC

Connector No.	M93
Connector Name	DISPLAY UNIT
Connector Color	WHITE

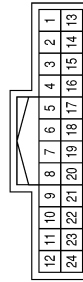

Terminal No.	Color of Wire	Signal Name
1	B	GND
2	Y	+B
3	V	ACC
5	L	COMP1_IN -

ALNIA0501GB



# AV CONTROL UNIT

< ECU DIAGNOSIS >

[BOSE AUDIO WITH NAVIGATION]

Terminal No.	Color of Wire	Signal Name
4	BR	ILL_CONT_GND
5	W/L	M-CAN1_H
6	P/B	M-CAN1_L
7	B	SW_GND
8	SB	CD_DVD_EJECT
10	GR	REMOTE_A
11	LG	REMOTE_B
12	BR	REMOTE_C
13	G	REMOTE_D
14	R	ENABLE
15	Y	REMOTE_GND
16	GR/R	RR DEFOG

Connector No.	M98
Connector Name	A/C AND AV SWITCH ASSEMBLY
Connector Color	WHITE

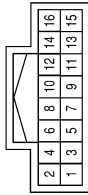

Terminal No.	Color of Wire	Signal Name
1	B	GND
2	V	ACC
3	R/L	ILL

Connector No.	M97
Connector Name	GPS ANTENNA
Connector Color	-



Terminal No.	Color of Wire	Signal Name
123	-	-
124	-	-

Connector No.	M109
Connector Name	FRONT TWEETER LH
Connector Color	BROWN



Terminal No.	Color of Wire	Signal Name
1	L/W	-
2	L/R	-

Connector No.	M104
Connector Name	AUX JACK
Connector Color	WHITE

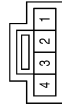

Terminal No.	Color of Wire	Signal Name
1	B	AUX_AUDIO_RH +
2	R	AUX_GND
4	W	AUX_AUDIO_LH +

Connector No.	M102
Connector Name	COMBINATION SWITCH (SPIRAL CABLE)
Connector Color	GRAY



Terminal No.	Color of Wire	Signal Name
16	B	-
17	BR	-
20	W	-

ALNIA0502GB

A  
B  
C  
D  
E  
F  
G  
H  
I  
J  
K  
L  
M  
N  
O  
P

AV

# AV CONTROL UNIT

< ECU DIAGNOSIS >

[BOSE AUDIO WITH NAVIGATION]

Connector No.	M110
Connector Name	CENTER SPEAKER
Connector Color	BROWN



Terminal No.	Color of Wire	Signal Name
1	V	-
2	R	-

Connector No.	M111
Connector Name	FRONT TWEETER RH
Connector Color	BROWN



Terminal No.	Color of Wire	Signal Name
1	W/B	-
2	L/B	-

Connector No.	M112
Connector Name	BOSE SPEAKER AMP.
Connector Color	BROWN

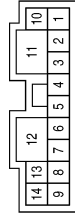

Terminal No.	Color of Wire	Signal Name
1	SB	RR_DR_LH+_OUT
2	O/L	RR_DR_RH+_OUT
3	R/L	RR_DR_RH-_OUT
4	L/W	FR_DR_LH+_OUT
5	L/R	FR_DR_LH-_OUT
6	G	PWR_BK_DR_LH-
7	R	PWR_BK_DR_LH+
8	W/B	FR_DR_RH+_OUT
9	W	WOOFER+_OUT
10	B/Y	RR DR LH-_OUT
11	Y	BATT
12	B	GND
13	L/B	FR DR RH+_OUT
14	B	WOOFER-_OUT

Connector No.	M113
Connector Name	BOSE SPEAKER AMP.
Connector Color	BROWN

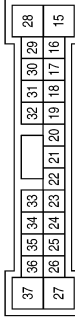

Terminal No.	Color of Wire	Signal Name
15	V	CENTER+
18	LG	FR_LH+ (IN)
19	BR	FR_RH+ (IN)
20	B/R	FR_RH- (IN)
21	L	RR_LH+ (IN)
22	B/W	RR_LH- (IN)
23	W	RR_RH+ (IN)
25	W/G	AMP_CTRL
27	L	PWR_BK_DR_RH-
28	R	CENTER-
31	GR/L	AMP_ON
32	V	FR_LH+ (IN)
33	B	RR_RH+ (IN)
37	W/R	PWR_BK_DR_RH+

Connector No.	M124
Connector Name	AV CONTROL UNIT
Connector Color	GRAY

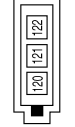

Terminal No.	Color of Wire	Signal Name
120	B	-
121	B	-
122	B	-

ALNIA0503GB

# AV CONTROL UNIT

< ECU DIAGNOSIS >

[BOSE AUDIO WITH NAVIGATION]

Connector No.	M201
Connector Name	WIRE TO WIRE
Connector Color	WHITE

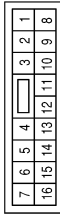

Terminal No.	Color of Wire	Signal Name
13	Y	-
14	B	-

Connector No.	M125
Connector Name	SAT (XM) ANTENNA
Connector Color	-



Terminal No.	Color of Wire	Signal Name
125	-	XM_ANTENNA

Terminal No.	Color of Wire	Signal Name
7	SHIELD	-
8	V	-
11	B/W	-
14	B/Y	-
15	B/W	-
16	SHIELD	-
17	SHIELD	-
18	Y	-
19	BR	-
20	L	-
21	B/W	-
22	G/Y	-
23	BR	-
24	SB	-

Connector No.	M202
Connector Name	WIRE TO WIRE
Connector Color	BROWN



Terminal No.	Color of Wire	Signal Name
3	G	-
4	R	-
5	B	-
6	W	-

ALNIA0504GB

A  
B  
C  
D  
E  
F  
G  
H  
I  
J  
K  
L  
M  
N  
O  
P

AV

# AV CONTROL UNIT

< ECU DIAGNOSIS >

[BOSE AUDIO WITH NAVIGATION]

Connector No.	M205
Connector Name	DVD PLAYER
Connector Color	WHITE



16	15	14	13	12	11	10	9	8	7	6	5	4	3	2	1
32	31	30	29	28	27	26	25	24	23	22	21	20	19	18	17

Terminal No.	Color of Wire	Signal Name
1	W	FES_L+_OUTPUT
2	B	FES_L-_OUTPUT
3	SHIELD	AUDIO_SHIELD
5	B	GND



2	1
---	---

Connector No.	M550
Connector Name	WIRE TO WIRE
Connector Color	BROWN

Connector No.	M551
Connector Name	WIRE TO WIRE
Connector Color	BROWN



1	2	3
---	---	---

Terminal No.	Color of Wire	Signal Name
1	B	-
2	B	-

Terminal No.	Color of Wire	Signal Name
1	B	-
2	B	-

Terminal No.	Color of Wire	Signal Name
6	BR	ILL+
7	W/L	M_CAN2-H
9	SB	DISPLAY_+B
10	G/Y	SW_POWER+ 5V
12	B/W	VTR+
13	L	VTR-
14	B/W	DISPLAY_GND
16	Y	DATA_RX
17	R	FES_R+_OUTPUT
18	G	FES_R-_OUTPUT
21	Y	+B
22	R/L	LIGHTING SW

Terminal No.	Color of Wire	Signal Name
23	P/B	M_CAN2-L
24	V	ACC
25	BR	DISPLAY_+B
26	B/Y	DISPLAY_GND
28	B/W	VIDEO_OUT
30	SHIELD	VTR_SHIELD
32	BR	DATA_TX

Connector No.	M601
Connector Name	WIRE TO WIRE
Connector Color	GRAY



1	2	3
---	---	---

Terminal No.	Color of Wire	Signal Name
1	B	-
2	B	-

ALNIA0505GB

# AV CONTROL UNIT

< ECU DIAGNOSIS >

[BOSE AUDIO WITH NAVIGATION]

Connector No.	E35
Connector Name	WIRE TO WIRE
Connector Color	WHITE

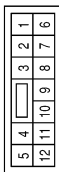

Terminal No.	Color of Wire	Signal Name
1	GW	-

Connector No.	E5
Connector Name	WIRE TO WIRE
Connector Color	WHITE

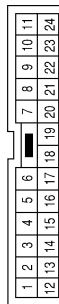

Terminal No.	Color of Wire	Signal Name
13	R	-

Connector No.	M602
Connector Name	WIRE TO WIRE
Connector Color	WHITE



Terminal No.	Color of Wire	Signal Name
1	B	-
2	B	-

Connector No.	F9
Connector Name	A/T ASSEMBLY
Connector Color	GREEN

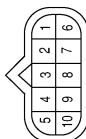

Terminal No.	Color of Wire	Signal Name
7	R	-

Terminal No.	Color of Wire	Signal Name
1G	G	-
2G	G/W	-
5G	Y	-
14G	R	-

Connector No.	E152
Connector Name	WIRE TO WIRE
Connector Color	WHITE

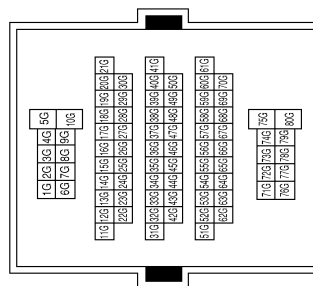

ALNIA0506GB

A  
B  
C  
D  
E  
F  
G  
H  
I  
J  
K  
L  
M  
N  
O  
P

AV

# AV CONTROL UNIT

< ECU DIAGNOSIS >

[BOSE AUDIO WITH NAVIGATION]

Connector No.	F14
Connector Name	WIRE TO WIRE
Connector Color	WHITE

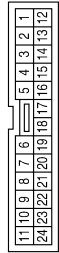

Terminal No.	Color of Wire	Signal Name
13	R	-

Connector No.	B6
Connector Name	WIRE TO WIRE
Connector Color	WHITE

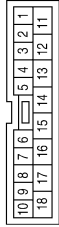

Terminal No.	Color of Wire	Signal Name
14	B/Y	-
15	SB	-

Connector No.	B41
Connector Name	WIRE TO WIRE
Connector Color	WHITE

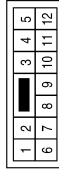

Terminal No.	Color of Wire	Signal Name
1	GW	-

Connector No.	B48
Connector Name	WIRE TO WIRE
Connector Color	WHITE

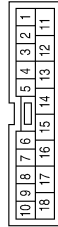

Terminal No.	Color of Wire	Signal Name
1	G	-
3	SHIELD	-
4	Y	-
11	R	-
12	G	-
14	B	-

Connector No.	B69
Connector Name	WIRE TO WIRE
Connector Color	WHITE

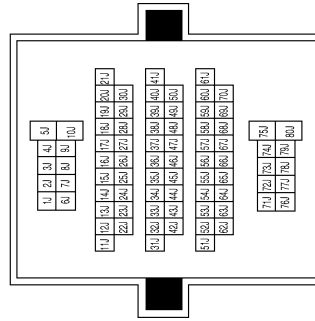

Terminal No.	Color of Wire	Signal Name
2J	V	-
10J	R	-
12J	BR	-
16J	B	-
17J	W	-
19J	Y	-
24J	SHIELD	-
27J	G	-
28J	R	-
29J	W/G	-
54J	W	-
55J	B	-
64J	GW	-
72J	SB	-
76J	B/Y	-

# AV CONTROL UNIT

< ECU DIAGNOSIS >

[BOSE AUDIO WITH NAVIGATION]

Terminal No.	Color of Wire	Signal Name
3	B	GND
4	G/W	REVERSE
5	BR	AV_CONT
6	G/W	DDL
8	Y	CAMERA_6V
9	SHIELD	CAMERA_-
10	G	CAMERA_+
11	B	VIDEO_GND
12	W	VIDEO +

Connector No.	B73
Connector Name	REAR VIEW CAMERA CONTROL UNIT
Connector Color	WHITE

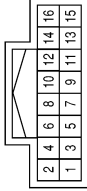

Terminal No.	Color of Wire	Signal Name
1	Y	BAT+
2	V	ACC

Connector No.	B72
Connector Name	SUBWOOFER
Connector Color	BROWN



Terminal No.	Color of Wire	Signal Name
1	B	WOOFER-
2	W	WOOFER+
4	W/G	AMP_ON
5	B	GND
6	R	BATT

Connector No.	B139
Connector Name	WIRE TO WIRE
Connector Color	WHITE

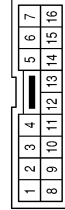

Terminal No.	Color of Wire	Signal Name
2	P	-
3	L	-

Connector No.	B106
Connector Name	WIRE TO WIRE
Connector Color	WHITE

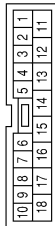

Terminal No.	Color of Wire	Signal Name
14	R/L	-
15	O/L	-

ALNIA0508GB

A  
B  
C  
D  
E  
F  
G  
H  
I  
J  
K  
L  
M  
N  
O  
P

AV

# AV CONTROL UNIT

< ECU DIAGNOSIS >

[BOSE AUDIO WITH NAVIGATION]

Terminal No.	Color of Wire	Signal Name
7	G/Y	-
8	W	-
9	L	-
10	SHIELD	-
11	B/W	-
12	B/Y	-
13	BR	-
14	Y	-
15	SHIELD	-

Connector No.	B145
Connector Name	WIRE TO WIRE
Connector Color	WHITE

1	2	3	4	5	6	7		
8	9	10	11	12	13	14	15	16



Terminal No.	Color of Wire	Signal Name
5	SB	-
6	BR	-

Terminal No.	Color of Wire	Signal Name
10	W/L	-
11	O/L	-
17	B	-
18	GR	-
19	LG	-
20	BR	-
21	R	-
23	O	-
24	W	-

Connector No.	B146
Connector Name	WIRE TO WIRE
Connector Color	BROWN

1	2	3	4	5	6	7	8	9	10	11		
12	13	14	15	16	17	18	19	20	21	22	23	24



Terminal No.	Color of Wire	Signal Name
1	B	-
7	G	-
8	Y	-
9	SHIELD	-

ALNIA0509GB



# AV CONTROL UNIT

< ECU DIAGNOSIS >

[BOSE AUDIO WITH NAVIGATION]

Connector No.	B149
Connector Name	WIRE TO WIRE
Connector Color	WHITE

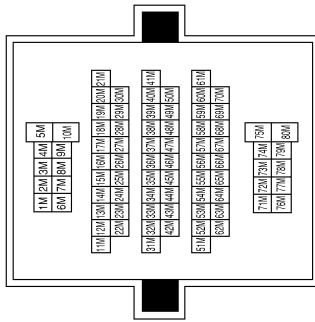

Terminal No.	Color of Wire	Signal Name
11M	SB	-
12M	BR	-
13M	G/Y	-
14M	B/W	-
15M	L	-
16M	SHIELD	-
17M	B/W	-
18M	O/L	-
19M	W	-
20M	W/L	-
21M	R	-
22M	Y	-
23M	G	-
24M	BR	-
25M	LG	-

Terminal No.	Color of Wire	Signal Name
26M	GR	-
27M	W/R	-
28M	SHIELD	-
29M	O	-
31M	B/Y	-
32M	BR	-
33M	Y	-
34M	SHIELD	-
35M	L	-
78M	O/L	-
79M	R/L	-

Connector No.	R2
Connector Name	WIRE TO WIRE
Connector Color	WHITE

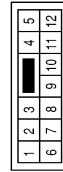

Connector No.	R9
Connector Name	WIRE TO WIRE
Connector Color	WHITE

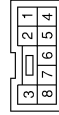

Connector No.	R107
Connector Name	WIRE TO WIRE
Connector Color	WHITE

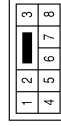

Terminal No.	Color of Wire	Signal Name
1	R/W	-
5	R/L	-
6	SHIELD	-
12	B	-

Terminal No.	Color of Wire	Signal Name
1	R/L	-
2	R/W	-
4	B	-

Terminal No.	Color of Wire	Signal Name
1	R/L	-
2	R/W	-
4	B	-

ALNIA0510GB

A  
B  
C  
D  
E  
F  
G  
H  
I  
J  
K  
L  
M  
AV  
O  
P

# AV CONTROL UNIT

< ECU DIAGNOSIS >

[BOSE AUDIO WITH NAVIGATION]

Connector No.	R109
Connector Name	MICROPHONE
Connector Color	WHITE

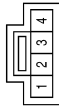

Terminal No.	Color of Wire	Signal Name
1	B	MIC OUT+
2	R/L	MIC OUT-
4	R/W	MIC POWER

Connector No.	R200
Connector Name	WIRE TO WIRE
Connector Color	WHITE

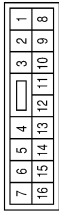

Terminal No.	Color of Wire	Signal Name
5	SB	-
6	BR	-
7	G/Y	-
8	W	-
9	L	-

Terminal No.	Color of Wire	Signal Name
10	SHIELD	-
11	B/W	-
12	B/Y	-
13	G	-
14	L	-
15	SHIELD	-

Connector No.	R201
Connector Name	WIRE TO WIRE
Connector Color	BROWN

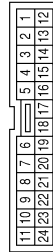

Terminal No.	Color of Wire	Signal Name
1	B	-
7	G	-
8	Y	-
9	SHIELD	-
10	W/L	-
11	O/L	-

Terminal No.	Color of Wire	Signal Name
17	B	-
18	GR	-
19	LG	-
20	BR	-
21	R	-
23	O	-
24	W	-

ALNIA0511GB

# AV CONTROL UNIT

< ECU DIAGNOSIS >

[BOSE AUDIO WITH NAVIGATION]

Terminal No.	Color of Wire	Signal Name
8	L	VIDEO IN-
9	SHIELD	VIDEO SHIELD
10	G/Y	SW POWER +5V
11	SB	FILTERED BAT
12	BR	FILTERED BAT

Connector No.	R202
Connector Name	VIDEO MONITOR
Connector Color	WHITE

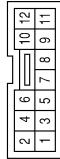

Terminal No.	Color of Wire	Signal Name
1	B/W	GND
2	B/Y	GND
3	B	ID
4	SHIELD	O/A SHIELD
5	G	DATA RX
6	L	DATA TX
7	W	VIDEO IN+

Connector No.	D2
Connector Name	WIRE TO WIRE
Connector Color	WHITE



Terminal No.	Color of Wire	Signal Name
10	L/R	-
11	L/W	-

Terminal No.	Color of Wire	Signal Name
8	R	ENABLE
9	GR	REMOTE_A
10	LG	REMOTE_B
11	BR	REMOTE_C
12	G	REMOTE_D
15	B	GND

Connector No.	R204
Connector Name	REAR AUDIO REMOTE CONTROL UNIT
Connector Color	WHITE

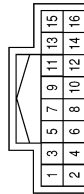

Terminal No.	Color of Wire	Signal Name
1	O/L	L_CH_INPUT
2	W	L_CH_INPUT
3	W/L	R_CH_INPUT
4	O	R_CH_INPUT
5	SHIELD	SHIELD
6	R/L	ILL+
7	Y	REMOTE

ALNIA0512GB

# AV CONTROL UNIT

< ECU DIAGNOSIS >

[BOSE AUDIO WITH NAVIGATION]

Connector No.	D12
Connector Name	FRONT DOOR SPEAKER LH
Connector Color	WHITE



Terminal No.	Color of Wire	Signal Name
1	L/W	-
2	L/R	-

Connector No.	D101
Connector Name	WIRE TO WIRE
Connector Color	WHITE

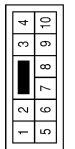

Terminal No.	Color of Wire	Signal Name
2	L/B	-
5	W/B	-

Connector No.	D112
Connector Name	FRONT DOOR SPEAKER RH
Connector Color	WHITE



Terminal No.	Color of Wire	Signal Name
1	W/B	-
2	L/B	-

Connector No.	D201
Connector Name	WIRE TO WIRE
Connector Color	WHITE

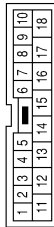

Terminal No.	Color of Wire	Signal Name
14	B/Y	-
15	SB	-

Connector No.	D207
Connector Name	REAR DOOR SPEAKER LH
Connector Color	WHITE



Terminal No.	Color of Wire	Signal Name
1	SB	-
2	B/Y	-

Connector No.	D208
Connector Name	REAR DOOR TWEETER LH
Connector Color	BROWN



Terminal No.	Color of Wire	Signal Name
1	SB	-
2	B/Y	-

ALNIA0513GB

# AV CONTROL UNIT

< ECU DIAGNOSIS >

[BOSE AUDIO WITH NAVIGATION]

Connector No.	D308
Connector Name	REAR DOOR TWEETER RH
Connector Color	BROWN



Terminal No.	Color of Wire	Signal Name
1	O/L	-
2	R/L	-

Connector No.	D307
Connector Name	REAR DOOR SPEAKER RH
Connector Color	WHITE



Terminal No.	Color of Wire	Signal Name
1	O/L	-
2	R/L	-

Connector No.	D301
Connector Name	WIRE TO WIRE
Connector Color	WHITE



Terminal No.	Color of Wire	Signal Name
14	R/L	-
15	O/L	-

Connector No.	D501
Connector Name	WIRE TO WIRE
Connector Color	WHITE

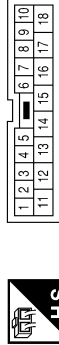

Terminal No.	Color of Wire	Signal Name
1	G	-
2	B	-
3	SHIELD	-
4	Y	-
11	R	-
12	G	-

Connector No.	D405
Connector Name	WIRE TO WIRE
Connector Color	WHITE



Terminal No.	Color of Wire	Signal Name
1	G	-
2	B	-
3	SHIELD	-
4	Y	-
11	R	-
12	G	-

Connector No.	D401
Connector Name	WIRE TO WIRE
Connector Color	WHITE



Terminal No.	Color of Wire	Signal Name
1	G	-
3	SHIELD	-
4	Y	-
11	R	-
12	G	-
14	B	-

ALNIA0514GB

A  
B  
C  
D  
E  
F  
G  
H  
I  
J  
K  
L  
M  
N  
O  
P

AV

# AV CONTROL UNIT

< ECU DIAGNOSIS >

[BOSE AUDIO WITH NAVIGATION]

Connector No.	D602
Connector Name	WIRE TO WIRE
Connector Color	WHITE

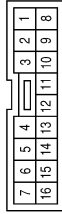

Terminal No.	Color of Wire	Signal Name
2	P	-
3	L	-

Connector No.	D518
Connector Name	BACK DOOR SPEAKER LH
Connector Color	BROWN



Terminal No.	Color of Wire	Signal Name
1	G	-
2	R	-

Connector No.	D504
Connector Name	REAR VIEW CAMERA
Connector Color	WHITE

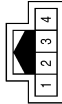

Terminal No.	Color of Wire	Signal Name
1	Y	CAMERA 6V
2	B	GND
3	G	CAMERA +
4	SHIELD	CAMERA -

Connector No.	D716
Connector Name	BACK DOOR SPEAKER RH
Connector Color	BROWN



Terminal No.	Color of Wire	Signal Name
1	P	-
2	L	-

Connector No.	D701
Connector Name	WIRE TO WIRE
Connector Color	WHITE

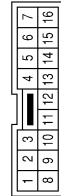

Terminal No.	Color of Wire	Signal Name
2	L	-
3	P	-

Connector No.	D606
Connector Name	WIRE TO WIRE
Connector Color	WHITE

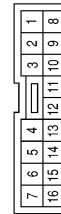

Terminal No.	Color of Wire	Signal Name
2	P	-
3	L	-

ALNIA0515GB

INFOID:000000001337880

DTC Index

Self-diagnosis results display item

# AV CONTROL UNIT

< ECU DIAGNOSIS >

[BOSE AUDIO WITH NAVIGATION]

Error item	Refer to
CAN COMM CIRCUIT [U1000]	<a href="#">AV-311</a>
CONTROL UNIT (CAN) [U1010]	<a href="#">AV-312</a>
CONTROL UNIT (AV) [U1310]	<a href="#">AV-337</a>
Control Unit FLASH-ROM [U1200]	<a href="#">AV-313</a>
Gyro NO CONN [U1201]	<a href="#">AV-314</a>
CAN CONT [U1216]	<a href="#">AV-319</a>
BLUETOOTH CONN [U1217]	<a href="#">AV-320</a>
HDD CONN [U1218]	<a href="#">AV-321</a>
HDD READ [U1219]	<a href="#">AV-322</a>
XM SERIAL COMM [U1220]	<a href="#">AV-329</a>
HDD WRITE [U121A]	<a href="#">AV-323</a>
HDD COMM [U121B]	<a href="#">AV-324</a>
HDD ACCESS [U121C]	<a href="#">AV-325</a>
DSP CONN [U121D]	<a href="#">AV-326</a>
DSP COMM [U121E]	<a href="#">AV-327</a>
INTERNAL COMM [U121F]	<a href="#">AV-328</a>
GPS COMM [U1204]	<a href="#">AV-315</a>
GPS ROM [U1205]	<a href="#">AV-316</a>
GPS RAM [U1206]	<a href="#">AV-317</a>
GPS RTC [U1207]	<a href="#">AV-318</a>
FRONT DISP CONN [U1243]	<a href="#">AV-330</a>
GPS ANTENNA CONN [U1244]	<a href="#">AV-332</a>
CD CHANGER [N-BUS] [U124C]	<a href="#">AV-325</a>
CAMERA CONT. CONN [U1250]	<a href="#">AV-333</a>
XM ANTENNA CONN [U1258]	<a href="#">AV-335</a>
<ul style="list-style-type: none"> <li>• AV COMM CIRCUIT [U1300]</li> <li>• SWITCHE CONN [U1240]</li> </ul>	<a href="#">AV-336</a>
<ul style="list-style-type: none"> <li>• AV COMM CIRCUIT [U1300]</li> <li>• REAR CAMERA LAN CONN [U1252]</li> </ul>	<a href="#">AV-336</a>

A

B

C

D

E

F

G

H

I

J

K

L

M

AV

O

P

# DISPLAY UNIT

< ECU DIAGNOSIS >

[BOSE AUDIO WITH NAVIGATION]

## DISPLAY UNIT

Reference Value

INFOID:000000001396310

### TERMINAL LAYOUT

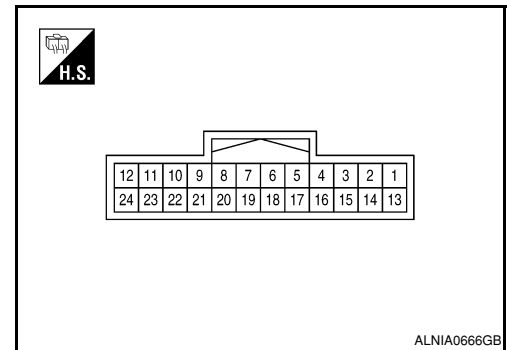

### PHYSICAL VALUES

Terminal (Wire color)		Description		Condition		Reference value (Approx.)
+	-	Signal name	Input/ Output			
1 (B)	Ground	Ground	—	Ignition switch ON	—	0V
2 (BR/Y)	Ground	Inverter VCC	Input	Ignition switch ACC	—	9V
3 (B/O)	Ground	Signal VCC	Input	Ignition switch ACC	—	9V
4	—	Shield	—	—	—	—
5 (L)	Ground	AUX image ground	—	Ignition switch ON	—	0V
6 (B)	Ground	RGB signal (G: green)	Input	Ignition switch ON	Start confirmation/adjust- ment mode, and then dis- play color bar by selecting "Color Spectrum Bar" on DISPLAY DIAGNO- SIS screen.	<p>SKIB2236J</p>
7	—	Shield	—	—	—	—
8 (W/L)	Ground	Horizontal synchronizing (HP) signal	Output	Ignition switch ON	—	<p>SKIB3601E</p>



# DISPLAY UNIT

< ECU DIAGNOSIS >

[BOSE AUDIO WITH NAVIGATION]

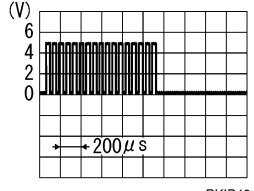
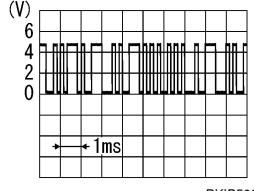
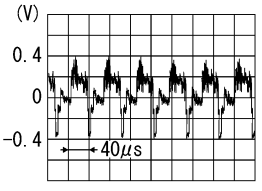
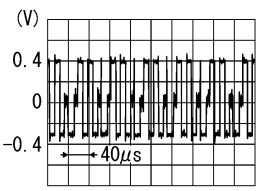
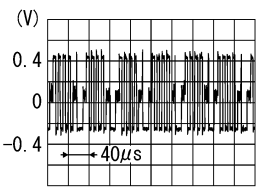
Terminal (Wire color)		Description		Condition	Reference value (Approx.)
+	-	Signal name	Input/ Output		
9 (O)	Ground	RGB area (YS) signal	Input	Ignition switch ON	At RGB image displayed 5V
				Ignition switch ON	At rear view camera image displayed 
11 (V)	Ground	Communication signal (CONT→DISP)	Input	Ignition switch ON	When adjusting display-brightness 
13 (B)	Ground	Inverter ground	—	Ignition switch ON	— 0V
14 (G/O)	Ground	Signal ground	—	Ignition switch ON	— 0V
15 (Y)	Ground	AUX image signal	Input	Ignition switch ON	When AUX mode is selected 
16 (G)	—	AUX image synchronizing signal	Input	—	—
17 (W)	Ground	RGB signal (R: red)	Input	Ignition switch ON	Start confirmation/adjustment mode, and then display color bar by selecting "Color Spectrum Bar" on DISPLAY DIAGNOSIS screen. 
18 (R)	Ground	RGB signal (B: blue)	Input	Ignition switch ON	Start confirmation/adjustment mode, and then display color bar by selecting "Color Spectrum Bar" on DISPLAY DIAGNOSIS screen. 

A  
B  
C  
D  
E  
F  
G  
H  
I  
J  
K  
L  
M  
AV  
O  
P

# DISPLAY UNIT

< ECU DIAGNOSIS >

[BOSE AUDIO WITH NAVIGATION]

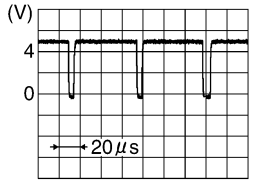
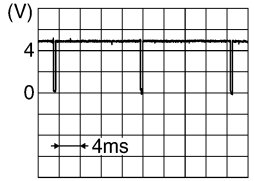
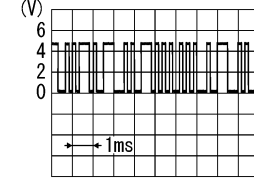
Terminal (Wire color)		Description		Condition		Reference value (Approx.)
+	-	Signal name	Input/ Output			
19 (W)	Ground	RGB synchronizing signal	Input	Ignition switch ON	—	 <p style="text-align: right;">SKIB3603E</p>
20 (O/L)	Ground	Vertical synchronizing (VP) signal	Output	Ignition switch On	—	 <p style="text-align: right;">SKIB3598E</p>
21	—	Shield	—	—	—	—
22 (LG)	Ground	Communication signal (DISP→CONT)	Output	Ignition switch ON	When adjusting display- brightness	 <p style="text-align: right;">PKIB5039J</p>
23	—	Shield	—	—	—	—

# BOSE SPEAKER AMP

< ECU DIAGNOSIS >

[BOSE AUDIO WITH NAVIGATION]

## BOSE SPEAKER AMP

Reference Value

INFOID:000000001396311

TERMINAL LAYOUT

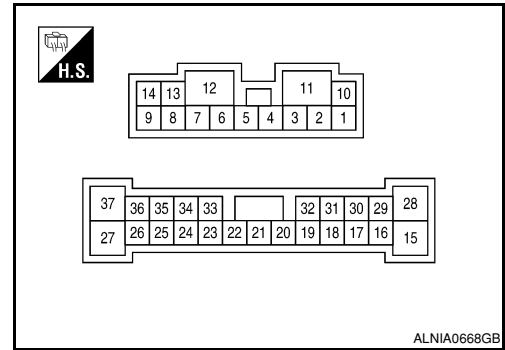

PHYSICAL VALUES

Terminal (Wire color)		Description		Condition		Reference value (Approx.)
+	-	Signal name	Input/Output			
1 (SB)	10 (B/Y)	Audio signal rear door speaker and tweeter LH	Output	Ignition switch ON	Audio output	<p>SKIB3609E</p>
2 (O/L)	3 (R/L)	Audio signal rear door speaker and tweeter RH	Output	Ignition switch ON	Audio output	<p>SKIB3609E</p>
4 (L/W)	5 (L/R)	Audio signal front door speaker and tweeter LH	Output	Ignition switch ON	Audio output	<p>SKIB3609E</p>
6 (G)	7 (R)	Audio signal back door speaker LH	Output	Ignition switch ON	Audio output	<p>SKIB3609E</p>

A  
B  
C  
D  
E  
F  
G  
H  
I  
J  
K  
L  
M  
O  
P

AV

# BOSE SPEAKER AMP

< ECU DIAGNOSIS >

[BOSE AUDIO WITH NAVIGATION]

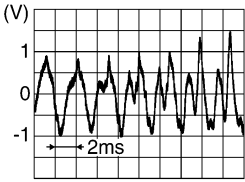
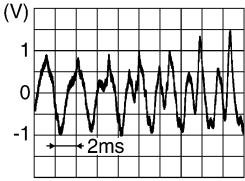
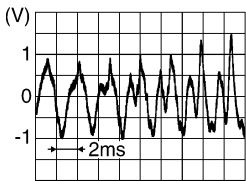
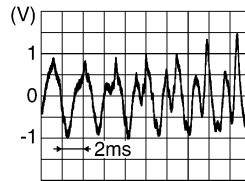
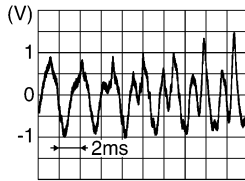
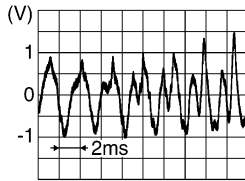
Terminal (Wire color)		Description		Condition		Reference value (Approx.)
+	-	Signal name	Input/ Output			
8 (W/B)	13 (L/B)	Audio signal front door speaker and tweeter RH	Output	Ignition switch ON	Audio output	 <p style="text-align: right; font-size: small;">SKIB3609E</p>
9 (W)	14 (B)	Audio signal subwoofer	Output	Ignition switch ON	Audio output	 <p style="text-align: right; font-size: small;">SKIB3609E</p>
11 (Y)	Ground	Battery power supply	Input	Ignition switch OFF	—	Battery voltage
12 (B)	Ground	Ground	—	Ignition switch ON	—	0V
15 (V)	28 (R)	Audio signal center speaker	Output	Ignition switch ON	Audio output	 <p style="text-align: right; font-size: small;">SKIB3609E</p>
18 (LG)	32 (V)	Audio signal front LH	Input	Ignition switch ON	Audio input	 <p style="text-align: right; font-size: small;">SKIB3609E</p>
19 (B/R)	20 (B/R)	Audio signal front RH	Input	Ignition switch ON	Audio input	 <p style="text-align: right; font-size: small;">SKIB3609E</p>
21 (L)	22 (B/W)	Audio signal rear LH	Input	Ignition switch ON	Audio input	 <p style="text-align: right; font-size: small;">SKIB3609E</p>

# BOSE SPEAKER AMP

< ECU DIAGNOSIS >

[BOSE AUDIO WITH NAVIGATION]

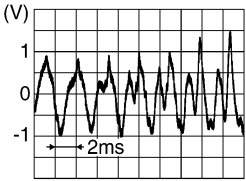
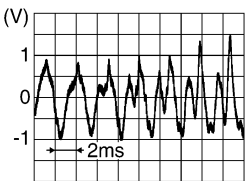
Terminal (Wire color)		Description		Condition		Reference value (Approx.)
+	-	Signal name	Input/ Output			
23 (W)	33 (B)	Audio signal rear RH	Input	Ignition switch ON	Audio input	
25 (W/G)	Ground	Subwoofer amp. ON signal	Output	Ignition switch ACC	—	12V
31 (GR/L)	Ground	Amp. ON signal	Input	Ignition switch ACC	—	12V
37 (W/R)	27 (L)	Audio signal back door speaker RH	Input	Ignition switch ON	Audio input	

A  
B  
C  
D  
E  
F  
G  
H  
I  
J  
K  
L  
M

AV

O  
P

# REAR VIEW CAMERA CONTROL UNIT

< ECU DIAGNOSIS >

[BOSE AUDIO WITH NAVIGATION]

## REAR VIEW CAMERA CONTROL UNIT

Reference Value

INFOID:000000001278909

### TERMINAL LAYOUT

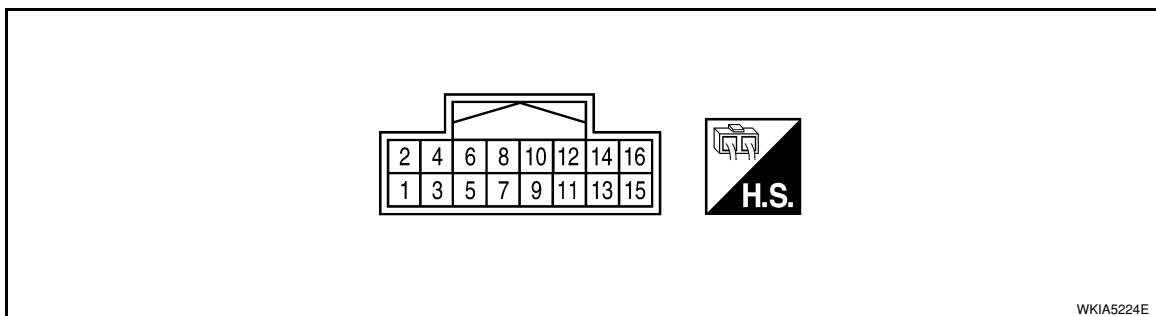

### PHYSICAL VALUES

Terminal (wire color)	-	Description		Condition		Reference value (Approx.)
		Signal name	Input/ Output			
1 (Y)	Ground	Battery power	Input	Ignition switch OFF	—	Battery voltage
2 (V)	Ground	ACC power	Input	Ignition switch ACC	—	Battery voltage
3 (B)	Ground	Ground	—	Ignition switch ON	—	0V
4 (G/W)	Ground	Reverse signal input	Input	Ignition switch ON	A/T selector lever R position	Battery voltage
					A/T selector lever in other than R position	0V
5 (BR)	Ground	AV Control	Output	Ignition switch ON	—	0V
6 (G/W)	Ground	DDL	Output	—	—	—
8 (Y)	Ground	Camera power output	Output	Ignition switch ON	A/T selector lever R position	6V
9	Ground	Camera image input (-)	Input	Ignition switch ON	—	0V
10 (G)	Ground	Camera image input (+)	Input	Ignition switch ON	A/T selector lever R position	

SKIA4894E

# REAR VIEW CAMERA CONTROL UNIT

[BOSE AUDIO WITH NAVIGATION]

< ECU DIAGNOSIS >

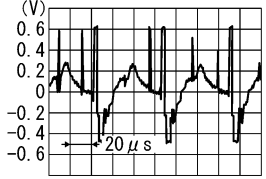
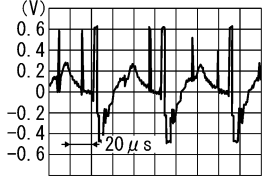
Terminal (wire color)		Description		Condition		Reference value (Approx.)
+	-	Signal name	Input/ Output			
11 (B)	Ground	Composite image output (-)	Output	Ignition switch ON	A/T selector lever R position	 <p style="text-align: right; font-size: small;">SKIA4896E</p>
12 (W)	Ground	Composite image output (+)	Output	Ignition switch ON	A/T selector lever R position	 <p style="text-align: right; font-size: small;">SKIA4896E</p>

A  
B  
C  
D  
E  
F  
G  
H  
I  
J  
K  
L  
M  
O  
P

AV

# DVD PLAYER

< ECU DIAGNOSIS >

[BOSE AUDIO WITH NAVIGATION]

## DVD PLAYER

### Reference Value

INFOID:000000001396312

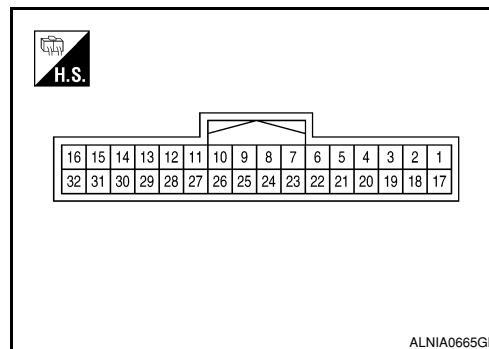

### PHYSICAL VALUES

Terminal (Wire color)		Description		Condition		Reference value (Approx.)
+	-	Signal name	Input/ Output			
1 (W)	2 (B)	DVD audio signal LH	Output	Ignition switch ON	With operation of the DVD player	<p>SKIB3609E</p>
3	—	Shield	—	—	—	—
5 (B)	Ground	Ground	—	Ignition switch ON	—	0V
6 (BR)	Ground	Illumination control (pulse width modulated)	—	—	With lighting switch ON	—
7 (W/L)	Ground	Can communication	Input/ Output	Ignition switch ON	—	—
9 (SB)	Ground	Video monitor power sup- ply	Output	Ignition switch ON	With DVD player operation	12V
10 (G/Y)	Ground	Switch power	Output	Ignition switch ON	With DVD player operation	5V
12 (B/W)	Ground	VTR (+)	Output	Ignition switch ON	With DVD player operation	—
13 (L)	Ground	VTR (-)	Output	Ignition switch ON	With DVD player operation	—
14 (B/W)	Ground	Display ground	—	Ignition switch ON	With DVD player operation	0V
16 (Y)	—	Data receive	Input	—	—	—



# DVD PLAYER

< ECU DIAGNOSIS >

[BOSE AUDIO WITH NAVIGATION]

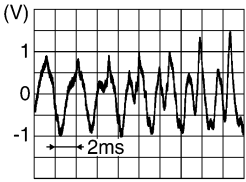
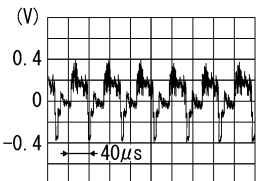
Terminal (Wire color)		Description		Condition		Reference value (Approx.)
+	-	Signal name	Input/ Output			
17 (R)	18 (G)	DVD audio signal RH	Output	Ignition switch ON	With DVD player operation	
21 (Y)	Ground	Battery power	Input	—	—	12V
22 (R/L)	Ground	Illumination power	Input	—	With instrument illumination ON	12V
23 (P/B)	Ground	CAN communication	Input/ Output	Ignition switch ON	—	0V
24 (V)	Ground	ACC power	Input	Ignition switch ACC or ON	—	12V
25 (BR)	Ground	Video monitor power	Output	Ignition switch ON	With DVD player operation	12V
26 (B/Y)	Ground	Video monitor ground	Input	Ignition switch ON	With instrument illumination ON	0V
28 (B/W)	Ground	Video out	Input	Ignition switch ACC or ON	—	
30	—	Shield	—	—	—	—
32 (BR)	—	Data transmit	Output	—	—	—

A  
B  
C  
D  
E  
F  
G  
H  
I  
J  
K  
L  
M

AV

# MULTI AV SYSTEM

< SYMPTOM DIAGNOSIS >

[BOSE AUDIO WITH NAVIGATION]

## SYMPTOM DIAGNOSIS

### MULTI AV SYSTEM

#### Symptom Table

INFOID:000000001278911

#### AUDIO SYSTEM

Symptom	Possible cause	Reference page
Inoperative	<ul style="list-style-type: none"><li>• AV control unit power and ground circuit</li><li>• AV control unit</li></ul>	<ul style="list-style-type: none"><li>• <a href="#">AV-338</a></li><li>• <a href="#">AV-297</a></li></ul>
Steering switch does not operate	<ul style="list-style-type: none"><li>• Steering switch</li><li>• AV control unit</li></ul>	<ul style="list-style-type: none"><li>• <a href="#">AV-310</a></li><li>• <a href="#">AV-297</a></li></ul>
All speakers do not sound	<ul style="list-style-type: none"><li>• AV control unit power and ground circuit</li><li>• BOSE speaker amp. ON signal</li><li>• BOSE speaker amp. power and ground circuit</li><li>• BOSE speaker amp.</li><li>• AV control unit</li></ul>	<ul style="list-style-type: none"><li>• <a href="#">AV-338</a></li><li>• <a href="#">AV-375</a></li><li>• <a href="#">AV-341</a></li><li>• <a href="#">AV-450</a></li><li>• <a href="#">AV-338</a></li></ul>
One or several speakers do not sound	<ul style="list-style-type: none"><li>• Front door speaker</li><li>• Front tweeter</li><li>• Center speaker</li><li>• Rear tweeter</li><li>• Rear door speaker</li><li>• Back door speaker</li><li>• Subwoofer</li></ul>	<ul style="list-style-type: none"><li>• <a href="#">AV-355</a></li><li>• <a href="#">AV-358</a></li><li>• <a href="#">AV-361</a></li><li>• <a href="#">AV-366</a></li><li>• <a href="#">AV-363</a></li><li>• <a href="#">AV-369</a></li><li>• <a href="#">AV-372</a></li></ul>

#### NAVIGATION SYSTEM

Symptom	Possible cause	Reference page
Inoperative	<ul style="list-style-type: none"><li>• AV control unit power and ground circuit</li><li>• AV control unit</li></ul>	<ul style="list-style-type: none"><li>• <a href="#">AV-338</a></li><li>• <a href="#">AV-297</a></li></ul>
Steering switch does not operate	<ul style="list-style-type: none"><li>• Steering switch</li><li>• AV control unit</li></ul>	<ul style="list-style-type: none"><li>• <a href="#">AV-376</a></li><li>• <a href="#">AV-297</a></li></ul>
Voice activated control does not operate	<ul style="list-style-type: none"><li>• Microphone</li><li>• Steering switch</li><li>• AV control unit</li></ul>	<ul style="list-style-type: none"><li>• <a href="#">AV-378</a></li><li>• <a href="#">AV-376</a></li><li>• <a href="#">AV-297</a></li></ul>

#### HANDS-FREE PHONE SYSTEM

Symptom	Possible cause	Reference page
Inoperative	<ul style="list-style-type: none"><li>• AV control unit power and ground circuit</li><li>• AV control unit</li></ul>	<ul style="list-style-type: none"><li>• <a href="#">AV-338</a></li><li>• <a href="#">AV-297</a></li></ul>
Steering switch does not operate	<ul style="list-style-type: none"><li>• Steering switch</li><li>• AV control unit</li></ul>	<ul style="list-style-type: none"><li>• <a href="#">AV-376</a></li><li>• <a href="#">AV-297</a></li></ul>
Voice activated control does not operate	<ul style="list-style-type: none"><li>• Microphone</li><li>• Steering switch</li><li>• AV control unit</li></ul>	<ul style="list-style-type: none"><li>• <a href="#">AV-378</a></li><li>• <a href="#">AV-376</a></li><li>• <a href="#">AV-297</a></li></ul>

#### REAR VIEW MONITOR

Symptom	Possible cause	Reference page
Inoperative	<ul style="list-style-type: none"><li>• Rear view camera control unit power and ground circuit</li><li>• Reverse signal circuit</li><li>• Camera ON signal circuit</li><li>• Camera image signal circuit (rear view camera to rear view camera control unit)</li><li>• Camera image signal circuit (rear view camera control unit to AV control unit)</li><li>• Rear view camera control unit</li></ul>	<ul style="list-style-type: none"><li>• <a href="#">AV-342</a></li><li>• <a href="#">AV-422</a></li><li>• <a href="#">AV-422</a></li><li>• <a href="#">AV-422</a></li><li>• <a href="#">AV-422</a></li><li>• <a href="#">AV-422</a></li></ul>

# MULTI AV SYSTEM

< SYMPTOM DIAGNOSIS >

[BOSE AUDIO WITH NAVIGATION]

## DVD PLAYER

Symptom	Possible cause	Reference page
DVD player inoperative	<ul style="list-style-type: none"> <li>Power supply and ground circuits</li> <li>DVD player</li> </ul>	<ul style="list-style-type: none"> <li><a href="#">AV-344</a></li> <li><a href="#">AV-446</a></li> </ul>
No sound when playing a DVD	<ul style="list-style-type: none"> <li>Audio signal circuits</li> <li>AV control unit</li> <li>DVD player</li> </ul>	<ul style="list-style-type: none"> <li><a href="#">AV-355</a></li> <li><a href="#">AV-338</a></li> <li><a href="#">AV-344</a></li> </ul>
Video monitor is inoperative/does not display properly	<ul style="list-style-type: none"> <li>Power supply and ground circuits</li> <li>Video out circuit</li> <li>DVD player</li> <li>Display monitor</li> </ul>	<ul style="list-style-type: none"> <li><a href="#">AV-345</a></li> <li><a href="#">AV-424</a></li> <li><a href="#">AV-344</a></li> <li><a href="#">AV-345</a></li> </ul>
DVD remote control is inoperative/does not operate properly	<ul style="list-style-type: none"> <li>DVD player</li> <li>Rear audio remote control unit</li> </ul>	<ul style="list-style-type: none"> <li><a href="#">AV-344</a></li> <li><a href="#">AV-448</a></li> </ul>
Headphones inoperative	<ul style="list-style-type: none"> <li>Headphone batteries</li> <li>Headphone audio signal circuits from AV control unit</li> <li>AV control unit</li> <li>Rear audio remote control unit</li> </ul>	<ul style="list-style-type: none"> <li><a href="#">AV-424</a></li> <li><a href="#">AV-380</a></li> <li><a href="#">AV-380</a></li> </ul>

A  
B  
C  
D  
E  
F  
G  
H  
I  
J  
K  
L  
M  
O  
P

AV

# NORMAL OPERATING CONDITION

< SYMPTOM DIAGNOSIS >

[BOSE AUDIO WITH NAVIGATION]

## NORMAL OPERATING CONDITION

### Description

INFOID:000000001278912

#### AUDIO SYSTEM

The majority of the audio troubles are the result of outside causes (bad CD, electromagnetic interference, etc.).

#### Noise

The following noise results from variations in field strength, such as fading noise and multi-path noise, or external noise from trains and other sources. It is not a malfunction.

- Fading noise: This noise occurs because of variations in the field strength in a narrow range due to mountains or buildings blocking the signal.
- Multi-path noise: This noise results from the waves sent directly from the broadcast station arriving at the antenna at a different time from the waves which reflect off mountains or buildings.

The vehicle itself can be a source of noise if noise prevention parts or electrical equipment is malfunctioning. Check if noise is caused and/or changed by engine speed, ignition switch turned to each position, and operation of each piece of electrical equipment, and determine the cause.

#### NOTE:

The source of the noise can be found easily by listening to the noise while removing the fuses of electrical components, one by one.

#### Type of Noise and Possible Cause

Occurrence condition		Possible cause
Occurs only when engine is ON.	A continuous growling noise occurs. The speed of the noise varies with changes in the engine speed.	<ul style="list-style-type: none"> <li>• Ignition components</li> </ul>
The occurrence of the noise is linked with the operation of the fuel pump.		<ul style="list-style-type: none"> <li>• Fuel pump condenser</li> </ul>
Noise only occurs when various electrical components are operating.	A cracking or snapping sound occurs with the operation of various switches.	<ul style="list-style-type: none"> <li>• Relay malfunction, audio unit malfunction</li> </ul>
	The noise occurs when various motors are operating.	<ul style="list-style-type: none"> <li>• Motor case ground</li> <li>• Motor</li> </ul>
The noise occurs constantly, not just under certain conditions.		<ul style="list-style-type: none"> <li>• Rear defogger coil malfunction</li> <li>• Open circuit in printed heater</li> <li>• Poor ground of antenna feeder line</li> </ul>
A cracking or snapping sound occurs while the vehicle is being driven, especially when it is vibrating excessively.		<ul style="list-style-type: none"> <li>• Ground wire of body parts</li> <li>• Ground due to improper part installation</li> <li>• Wiring connections or a short circuit</li> </ul>

#### NAVIGATION SYSTEM

##### Basic Operation

Symptom	Cause	Remedy
No image is shown.	Display brightness adjustment is set fully to DARK side.	Adjust the display brightness.
No guide sound is heard. Audio guide volume is too low or too high.	Volume control is set to OFF, MIN or MAX.	Adjust the audio guide volume.
	Audio guidance is not available while the vehicle is driving on a dark pink route.	System is not malfunctioning.
Screen is too dark. Motion of the image is too slow.	Temperature inside the vehicle is low.	Wait until the temperature inside the vehicle reaches the proper temperature.
Small black or bright spots appear on the screen.	Symptom peculiar to a liquid crystal display (display unit).	System is not malfunctioning.

##### Vehicle Mark

## NORMAL OPERATING CONDITION

< SYMPTOM DIAGNOSIS >

[BOSE AUDIO WITH NAVIGATION]

Symptom	Cause	Remedy	A
Map screen and BIRDVIEW™ Name of the place vary with the screen.	Some thinning of the character data is done to prevent the display becoming to complex. In some cases and in some locations, the display contents may differ. The same place name, street name, etc. may not be displayed every time on account of the data processing.	System is not malfunctioning.	B
Vehicle mark is not positioned correctly.	Vehicle is transferred by ferry or by towing after its ignition switch is turned to OFF.	Drive the vehicle for a while in the GPS satellite signal receiving condition.	C
Screen will not switch to nighttime mode after the lighting switch is turned ON.	The daytime screen is selected by the "SWITCH SCREENS" when the last time the screen dimming setting is done. Switching between daytime/nighttime screen may be inhibited by the automatic illumination adjustment function.	Perform screen dimming and select the nighttime screen by "SWITCH SCREENS".	D
Map screen will not scroll in accordance with the vehicle travel.	Current location is not displayed.	Press "MAP" button to display the current location.	E
Vehicle mark will not be shown.	Current location is not displayed.	Press "MAP" button to display the current location.	F
Accuracy indicator (GPS satellite mark) on the map screen stays gray.	GPS satellite signal is intercepted because the vehicle is in or behind a building.	Move the vehicle out to an open space.	G
	GPS satellite signal cannot be received because an obstacle is placed on top of the instrument panel.	Do not place anything on top of the meter display (instrument panel).	H
	GPS satellites are not visible from current location.	Wait until GPS satellites are visible by moving the vehicle.	I
Vehicle location accuracy is low.	Accuracy indicator (GPS satellite mark) on the map screen stays gray.	Current location is not determined.	J
	Vehicle speed setting by the vehicle speed pulse has been deviated (advanced or retarded) from the actual vehicle speed because tire chain is fitted or the system has been used on another vehicle.	Drive the vehicle for a while [for approx. 30 minutes at approx. 30 km/h (19 MPH)] and the deviation will be automatically adjusted. If advancement or retard still occur, perform the distance adjustment by CONFIRMATION/ADJUSTMENT mode of diagnosis function.	K
	Map data has error or omission. (Vehicle mark is always deviated to the same position.)	As a rule, an updated map DVD-ROM will be released once a year.	L

### Destination, Passing Points and Menu Items Cannot be Selected/Set

Symptom	Cause	Remedy	M
Destination cannot be set.	Destination to be set is on an expressway.	Set the destination on an ordinary road.	AV
Passing point is not searched when re-searching the route.	The vehicle has already passed the passing point, or the system judged so.	To include the passing points that have been passed into the route again, set the route again.	O
Route information will not be displayed.	Route searching has not been done.	Set the destination and perform route searching.	P
	Vehicle mark is not on the recommended route.	Drive on the recommended route.	
	Route guide is turned OFF.	Turn route guide ON.	
	Route information is not available on the dark pink route.	System is not malfunctioning.	
After the route searching, no guide sign will appear as the vehicle goes near the entrance/exit to the toll road.	Vehicle mark is not on the recommended route. (On the display, only guide signs related to the recommended route will be shown.)	Drive on the recommended route.	

## NORMAL OPERATING CONDITION

< SYMPTOM DIAGNOSIS >

[BOSE AUDIO WITH NAVIGATION]

Symptom	Cause	Remedy
Automatic route searching is not possible.	Vehicle is driving on a highway (gray route), or no recommended route is available.	Drive on a road to be searched. Or re-search the route manually. In this case, however, the whole route will be searched.
Performed automatic detour search (or detour search). However, the result is the same as that of the previous search.	Performed search with every conditions considered. However, the result is the same as that of the previous search.	System is not malfunctioning.
Passing points cannot be set.	More than five passing points were set.	Passing points can be set up to five. To stop at more than five points, perform sharing in several steps.
When setting the route, the starting point cannot be selected.	The current vehicle location is always set as the starting point of a route.	System is not malfunctioning.
Some menu items cannot be selected.	The vehicle is being driven.	Stop the vehicle at a safe place and then operate the system.

### Voice Guide

Symptom	Cause	Remedy
Voice guide will not operate.	Note: Voice guide is only available at intersections that satisfy certain conditions (indicated by ● on the map). Therefore, guidance may not be given even when the route on the map changes direction.	System is not malfunctioning.
	The vehicle is not on the recommended route.	Return to the recommended route or re-search the route.
	Voice guide is turned OFF.	Turn voice guide ON.
	Route guide is turned OFF.	Turn route guide ON.
Voice guide does not match the actual road pattern.	Voice guide may vary with the direction to which the vehicle is turn and the connection of the road to other roads.	Drive in conformity to the actual traffic rules.

### Route Search

Symptom	Cause	Remedy
No route is shown.	No road to be searched is found around the destination.	Find wider road (orange road or wider) nearby and reset the destination and passing points onto it. Take care of the traveling direction when there are separate up and down roads.
	Starting point and the destination are too close.	Set the destination at more distant point.
	Conditional traffic regulation (day of the week/ time of the day) is set at the area around the current location or the destination.	Turn the time-regulating search conditions OFF. Turn "Avoid regulation time" in the search conditions OFF.
Indicated route is intermittent.	In some areas, highways (gray routes) are not used for the search <sup>(Note)</sup> Therefore, the route to the current location or the passing points may be intermittent.	System is not malfunctioning.
When the vehicle has passed the recommended route, it is deleted from the screen.	A recommended route is controlled by each section. When the vehicle has passed the passing point 1, then the map data from the starting point up to the passing point 1 will be deleted. (The data may remain undeleted in some area.)	System is not malfunctioning.

# NORMAL OPERATING CONDITION

[BOSE AUDIO WITH NAVIGATION]

< SYMPTOM DIAGNOSIS >

Symptom	Cause	Remedy
Detouring route is recommended.	In some areas, highways (gray routes) are not used for the search. (Note). Therefore, detour route may be recommended.	Set the route closer to the basic route (gray route).
	A detour route may be shown when some traffic regulation (one-way traffic, etc.) is set at the area around the starting point or the destination.	Slightly move the starting point or the destination, or set the passing point on the route of your choice.
	In the area where highways (gray routes) are used for the search, left turn has priority around the current location and the destination (passing points). For this reason, the recommended route may be detouring.	System is not malfunctioning.
Landmarks on the map do not match the actual ones.	This can be happen due to omission or error in the map data.	As a rule, an updated map DVD-ROM will be released once a year. Wait until the latest map has become available.
Recommended route is far from the starting point, passing points, and destination.	Starting point, passing points, and destination of the route guide were set far from the desired points because route searching data around these area were not stored.	Reset the destination onto the road nearby. If this road is one of the highways (gray routes), an ordinary road nearby may be displayed as the recommended route.

**NOTE:**

Except for the ordinance-designated cities. (Malfunctioning areas may be changed in the updated map disc.)

**Examples of Current-Location Mark Displacement**

Vehicle's travel amount is calculated by reading its travel distance and turning angle. Therefore, if the vehicle is driven in the following manner, an error will occur in the vehicle's current location display. If correct location has not been restored after driving the vehicle for a while, perform location correction.

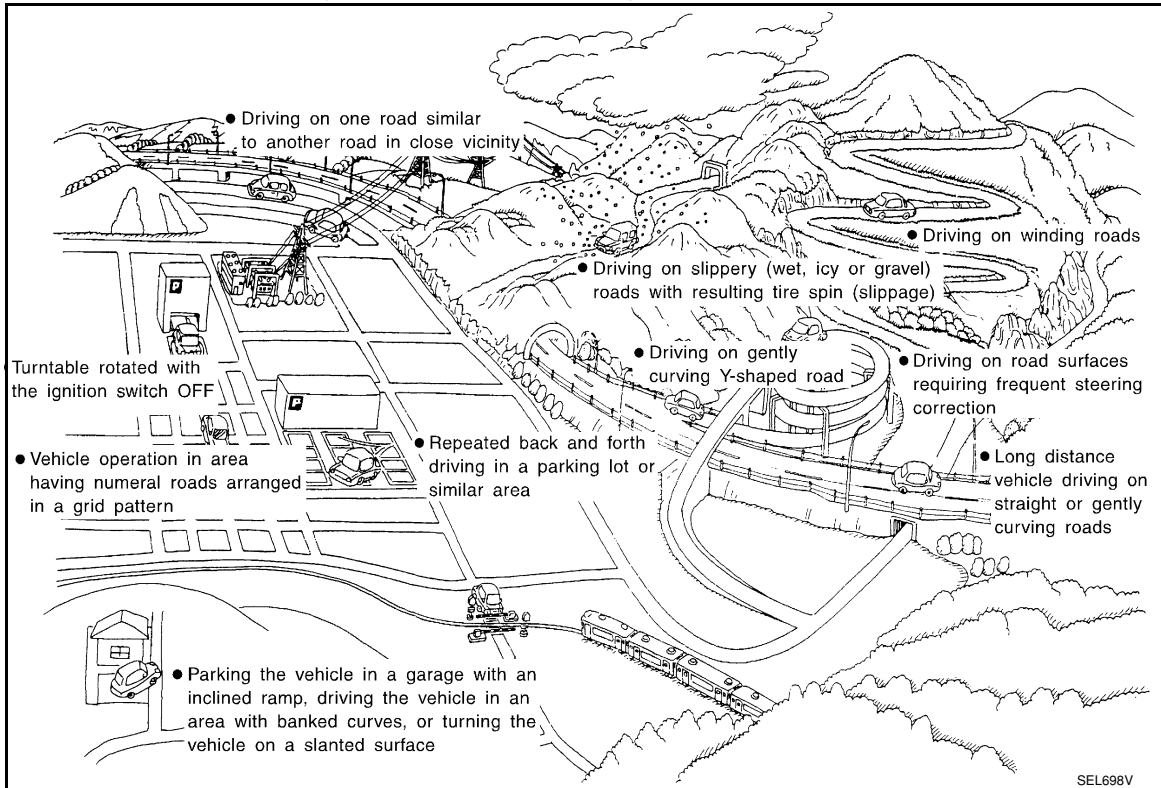

A  
B  
C  
D  
E  
F  
G  
H  
I  
J  
K  
L  
M  
AV  
O  
P

# NORMAL OPERATING CONDITION

< SYMPTOM DIAGNOSIS >

[BOSE AUDIO WITH NAVIGATION]

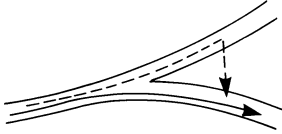
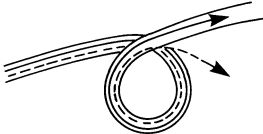
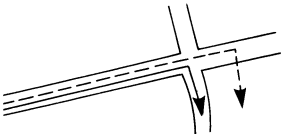
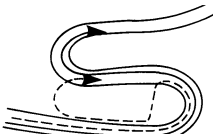
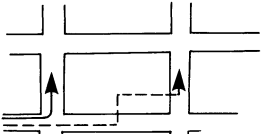
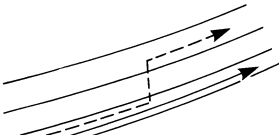
Cause (condition)	-: While driving    ooo: Display	Driving condition	Remarks (correction, etc.)
Road configuration	<p>Y-intersections</p>  <p style="text-align: center; font-size: small;">ELK0192D</p>	<p>At a Y intersection or similar gradual division of roads, an error in the direction of travel deduced by the sensor may result in the current-location mark appearing on the wrong road.</p>	<p>If after travelling about 10 km (6 miles) the correct location has not been restored, perform location correction and, if necessary, direction correction.</p>
	<p>Spiral roads</p>  <p style="text-align: center; font-size: small;">ELK0193D</p>	<p>When driving on a large, continuous spiral road (such as loop bridge), turning angle error is accumulated and the vehicle mark may deviate from the correct location.</p>	
	<p>Straight roads</p>  <p style="text-align: center; font-size: small;">ELK0194D</p>	<p>When driving on a long, straight road and slow curve without stopping, map-matching does not work effectively enough and distance errors may accumulate. As a result, the vehicle mark may deviate from the correct location when the vehicle is turned at a corner.</p>	
	<p>Zigzag roads</p>  <p style="text-align: center; font-size: small;">ELK0195D</p>	<p>When driving on a zigzag road, the map may be matched to other roads in the similar direction nearby at every turn, and the vehicle mark may deviate from the correct location.</p>	
	<p>Roads laid out in a grid pattern</p>  <p style="text-align: center; font-size: small;">ELK0196D</p>	<p>When driving where roads are laid out in a grid pattern, or where many roads are running in the similar direction nearby, the map may be matched to them by mistake and the vehicle mark may deviate from the correct location.</p>	
	<p>Parallel roads</p>  <p style="text-align: center; font-size: small;">ELK0197D</p>	<p>When two roads are running in parallel (such as highway and sideways), the map may be matched to the other road by mistake and the vehicle mark may deviate from the correct location.</p>	



# NORMAL OPERATING CONDITION

< SYMPTOM DIAGNOSIS >

[BOSE AUDIO WITH NAVIGATION]

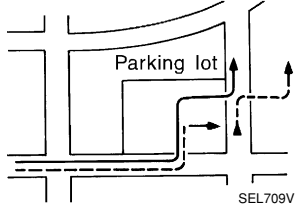
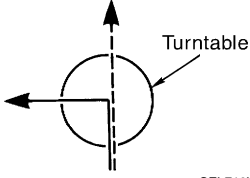
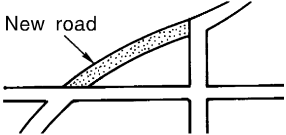
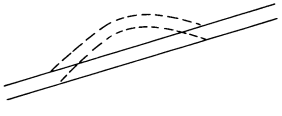
	Cause (condition)    -: While driving    ooo: Display	Driving condition	Remarks (correction, etc.)
Place	In a parking lot  <small>SEL709V</small>	When driving in a parking lot, or other location where there are no roads on the map, matching may place the vehicle mark on a nearby road. When the vehicle returns to the road, the vehicle mark may have deviated from the correct location. When driving in circle or turning the steering wheel repeatedly, direction errors accumulate, and the vehicle mark may deviate from the correct location.	If after travelling about 10 km (6 miles) the correct location has not been restored, perform location correction and, if necessary, direction correction.
	Turntable  <small>SEL710V</small>	When the ignition switch is OFF, the navigation system cannot get the signal from the gyroscope (angular speed sensor). Therefore, the displayed direction may be wrong and the correct road may not be easily returned to after rotating the vehicle on a turntable with the ignition OFF.	
	Slippery roads	On snow, wet roads, gravel, or other roads where tires may slip easily, accumulated mileage errors may cause the vehicle mark to deviate from the correct road.	
	Slopes	When parking in sloped garages, when travelling on banked roads, or in other cases where the vehicle turns when tilted, an error in the turning angle will occur, and the vehicle mark may deviate from the road.	
Map data	Road not displayed on the map screen  <small>SEL699V</small>	When driving on new roads or other roads not displayed on the map screen, map matching does not function correctly and matches the location to a nearby road. When the vehicle returns to a road which is on the map, the vehicle mark may deviate from the correct road.	
	Different road pattern (Changed due to repair)  <small>ELK0201D</small>	If the road pattern stored in the map data and the actual road pattern are different, map matching does not function correctly and matches the location to a nearby road. The vehicle mark may deviate from the correct road.	
Vehicle	Use of tire chains	When tire chains are used, the mileage is not correctly detected, and the vehicle mark may deviate from the correct road.	Drive the vehicle for a while. If the distance still deviates, adjust it by using the distance adjustment function. (If the tire chain is removed, recover the original value.)

A  
B  
C  
D  
E  
F  
G  
H  
I  
J  
K  
L  
M  
AV  
O  
P

# NORMAL OPERATING CONDITION

< SYMPTOM DIAGNOSIS >

[BOSE AUDIO WITH NAVIGATION]

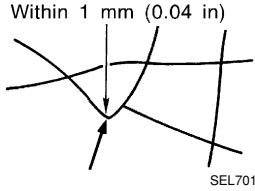
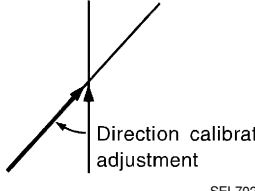
Cause (condition)	-: While driving    ooo: Display	Driving condition	Remarks (correction, etc.)
Precautions for driving	Just after the engine is started	If the vehicle is driven just after the engine is started when the gyroscope (angular speed sensor) correction is not completed, the vehicle can lose its direction and may have deviated from the correct location.	Wait for a short while before driving after starting the engine.
	Continuous driving without stopping	When driving long distances without stopping, direction errors may accumulate, and the current-location mark may deviate from the correct road.	Stop and adjust the orientation.
	Abusive driving	Spinning the wheels or engaging in other kinds of abusive driving may result in the system being unable to perform correct detection, and may cause the vehicle mark to deviate from the correct road.	If after travelling about 10 km (6 miles) the correct location has not been restored, perform location correction and, if necessary, direction correction.
How to correct location	Position correction accuracy 	If the accuracy of location settings is poor, accuracy may be reduced when the correct road cannot be found, particularly in places where there are many roads.	Enter in the road displayed on the screen with an accuracy of approx. 1mm. Caution: Whenever possible, use detailed map for the correction.
	Direction when location is corrected 	If the accuracy of location settings during correction is poor, accuracy may be reduced afterwards.	Perform direction correction.

### Location Correction by Map-Matching is Slow

- The map-matching function needs to refer to the data of the surrounding area. It is necessary to drive some distance for the function to work.
- Because map-matching operates on this principle, when there are many roads running in similar directions in the surrounding area, no matching determination may be made. The location may not be corrected until some special feature is found.

### Name of Road is Not Displayed

The current road name may not be displayed if there are no road names displayed on the map screen.

### Contents of Display Differ for Birdview™ and the (Flat) Map Screen

Difference of the BIRDVIEW™ screen from the flat map screen are as follows.

- The current place name displays names which are primarily in the direction of vehicle travel.
- The amount of time before the vehicle travel or turn angle is updated on the screen is longer than for the (flat) map display.
- The conditions for display of place names, roads, and other data are different for nearby areas and for more distant areas.
- Some thinning of the character data is done to prevent the display becoming too complex. In some cases and in some locations, the display contents may differ.
- The same place name, street name, etc. may be displayed multiple times.

### Vehicle Mark Shows a Position Which is Completely Wrong

In the following cases, the vehicle mark may appear on completely different position in the map depending on the GPS satellite signal receiving conditions. In this case, perform location correction and direction correction.

- When location correction has not been done
- If the receiving conditions of the GPS satellite signal is poor, if the vehicle mark becomes out of place, it may move to a completely different location and not come back if location correction is not done. The position will be corrected if the GPS signal can be received.
- When the vehicle has traveled by ferry, or when the vehicle has been being towed

## NORMAL OPERATING CONDITION

< SYMPTOM DIAGNOSIS >

[BOSE AUDIO WITH NAVIGATION]

- Because calculation of the current location cannot be done when traveling with the ignition off, for example when traveling by ferry or when being towed, the location before travel is displayed. If the precise location can be detected with GPS, the location will be corrected.

A

### Vehicle Mark Jumps

In the following cases, the vehicle mark may appear to jump as a result of automatic correction of the current location.

B

- When map matching has been done
- If the current location and the vehicle mark are different when map matching is done, the vehicle mark may seem to jump. At this time, the location may be “corrected” to the wrong road or to a location which is not on a road.
- When GPS location correction has been done
- If the current location and the vehicle mark are different when the location is corrected using GPS measurements, the vehicle mark may seem to jump. At this time, the location may be “corrected” to a location which is not on a road.

C

D

### Vehicle Mark is in a River or Sea

The navigation system moves the vehicle mark with no distinction between land and rivers or sea. If the vehicle mark is somehow out of place, it may appear that the vehicle is driving in a river or the sea.

E

### Vehicle Mark Automatically Rotates

The system wrongly memorizes the rotating status as stopping when the ignition switch is turned ON with the turntable rotating. That causes the vehicle mark to rotate when the vehicle is stopped.

F

### When Driving on Same Road, Sometimes Vehicle Mark is in Right Place and Sometimes it is in Wrong Place

The conditions of the GPS antenna (GPS data) and gyroscope (angular speed sensor) change gradually. Depending on the road traveled and the operation of the steering wheel, the location detection results will be different. Therefore, even on a road on which the location has never been wrong, conditions may cause the vehicle mark to deviate.

G

H

I

J

K

L

M

AV

O

P

PRECAUTION

PRECAUTIONS

Supplemental Restraint System (SRS) "AIR BAG" and "SEAT BELT PRE-TENSIONER"

INFOID:000000001278913

The Supplemental Restraint System such as "AIR BAG" and "SEAT BELT PRE-TENSIONER", used along with a front seat belt, helps to reduce the risk or severity of injury to the driver and front passenger for certain types of collision. This system includes seat belt switch inputs and dual stage front air bag modules. The SRS system uses the seat belt switches to determine the front air bag deployment, and may only deploy one front air bag, depending on the severity of a collision and whether the front occupants are belted or unbelted. Information necessary to service the system safely is included in the SRS and SB section of this Service Manual.

**WARNING:**

- To avoid rendering the SRS inoperative, which could increase the risk of personal injury or death in the event of a collision which would result in air bag inflation, all maintenance must be performed by an authorized NISSAN/INFINITI dealer.
- Improper maintenance, including incorrect removal and installation of the SRS, can lead to personal injury caused by unintentional activation of the system. For removal of Spiral Cable and Air Bag Module, see the SRS section.
- Do not use electrical test equipment on any circuit related to the SRS unless instructed to in this Service Manual. SRS wiring harnesses can be identified by yellow and/or orange harnesses or harness connectors.

Precaution for Trouble Diagnosis

INFOID:000000001278914

AV COMMUNICATION SYSTEM

- Do not apply voltage of 7.0 V or higher to the measurement terminals.
- Use the tester with its open terminal voltage being 7.0 V or less.
- Be sure to turn ignition switch OFF and disconnect the battery cable from the negative terminal before checking the circuit.

Precaution for Harness Repair

INFOID:000000001278915

AV COMMUNICATION SYSTEM

- Solder the repaired parts, and wrap with tape. [Frays of twisted line must be within 110 mm (4.33 in).]

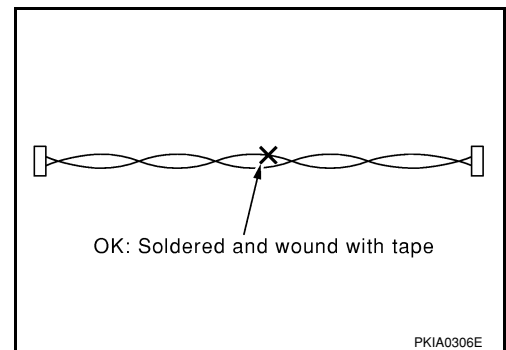

- Do not perform bypass wire connections for the repair parts. (The spliced wire will become separated and the characteristics of twisted line will be lost.)

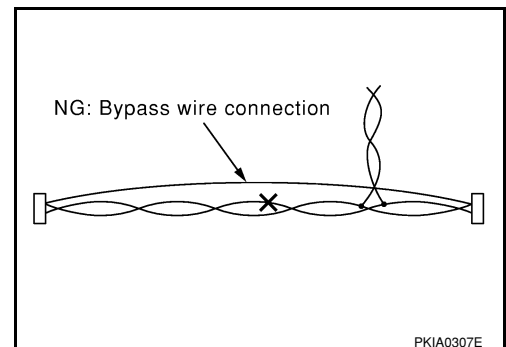

PREPARATION

PREPARATION

Commercial Service Tools

INFOID:000000001278916

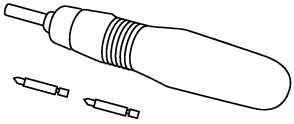
Tool name	Description
<p>Power tool</p>  <p>PBIC0191E</p>	<p>Loosening bolts and nuts</p>

A  
B  
C  
D  
E  
F  
G  
H  
I  
J  
K  
L  
M  
AV  
O  
P

AV

## ON-VEHICLE REPAIR

### AV CONTROL UNIT

#### Removal and Installation

INFOID:000000001282607

For removal and installation, refer to [AV-104, "Removal and Installation"](#).

DISPLAY UNIT

Removal and Installation

INFOID:000000001346469

For removal and installation, refer to [AV-106. "Removal and Installation"](#).

A

B

C

D

E

F

G

H

I

J

K

L

M

AV

O

P

## FRONT TWEETER

< ON-VEHICLE REPAIR >

[BOSE AUDIO WITH NAVIGATION]

---

### FRONT TWEETER

#### Removal and Installation

INFOID:000000001282610

For removal and installation, refer to [AV-107, "Removal and Installation"](#).



# CENTER SPEAKER

< ON-VEHICLE REPAIR >

[BOSE AUDIO WITH NAVIGATION]

## CENTER SPEAKER

### Removal and Installation

INFOID:000000001282611

For removal and installation, refer to [AV-262. "Removal and Installation"](#).

A

B

C

D

E

F

G

H

I

J

K

L

M

AV

O

P

## FRONT DOOR SPEAKER

< ON-VEHICLE REPAIR >

[BOSE AUDIO WITH NAVIGATION]

---

### FRONT DOOR SPEAKER

#### Removal and Installation

INFOID:000000001282612

For removal and installation, refer to [AV-108, "Removal and Installation"](#).

# REAR DOOR SPEAKER

< ON-VEHICLE REPAIR >

[BOSE AUDIO WITH NAVIGATION]

## REAR DOOR SPEAKER

### Removal and Installation

INFOID:000000001282613

#### REAR DOOR SPEAKER

For removal and installation, refer to [AV-109. "Removal and Installation"](#).

#### REAR DOOR TWEETER

For removal and installation, refer to [AV-264. "Removal and Installation"](#).

A

B

C

D

E

F

G

H

I

J

K

L

M

AV

O

P

## BACK DOOR SPEAKER

< ON-VEHICLE REPAIR >

[BOSE AUDIO WITH NAVIGATION]

---

### BACK DOOR SPEAKER

#### Removal and Installation

INFOID:000000001337884

For removal and installation, refer to [AV-265. "Removal and Installation"](#).

WOOFER

Removal and Installation

INFOID:000000001430762

SUBWOOFER (BOSE SYSTEM)

For removal and installation. Refer to [AV-266. "Removal and Installation"](#).

A

B

C

D

E

F

G

H

I

J

K

L

M

AV

O

P

**DVD PLAYER**

**Removal and Installation**

*INFOID:000000001346518*

For removal and installation, refer to [AV-112. "Removal and Installation"](#).

# STEERING SWITCH

< ON-VEHICLE REPAIR >

[BOSE AUDIO WITH NAVIGATION]

## STEERING SWITCH

### Removal and Installation

INFOID:000000001282618

For removal and installation of the steering wheel audio control switch, refer to [AV-110. "Removal and Installation"](#).

- A
- B
- C
- D
- E
- F
- G
- H
- I
- J
- K
- L
- M
- AV
- O
- P

## REAR AUDIO REMOTE CONTROL UNIT

< ON-VEHICLE REPAIR >

[BOSE AUDIO WITH NAVIGATION]

---

### REAR AUDIO REMOTE CONTROL UNIT

#### Removal and Installation

INFOID:000000001309612

For removal and installation, refer to [AV-111. "Removal and Installation"](#)



# DVD ENTERTAINMENT SYSTEM

< ON-VEHICLE REPAIR >

[BOSE AUDIO WITH NAVIGATION]

## DVD ENTERTAINMENT SYSTEM

### Removal and Installation

INFOID:000000001346517

For removal and installation, refer to [AV-113, "Removal and Installation"](#).

A

B

C

D

E

F

G

H

I

J

K

L

M

AV

O

P

**BOSE AMP.**

**Removal and Installation**

INFOID:000000001282608

For removal and installation, refer to [AV-271. "Removal and Installation"](#).

# AUDIO ANTENNA

< ON-VEHICLE REPAIR >

[BOSE AUDIO WITH NAVIGATION]

## AUDIO ANTENNA

### Location of Antenna

INFOID:000000001282615

For location of antenna, refer to [AV-114. "Location of Antennas"](#).

### Window Antenna Repair

INFOID:000000001282616

For window antenna repair, refer to [AV-114. "Window Antenna Repair"](#).

A  
B  
C  
D  
E  
F  
G  
H  
I  
J  
K  
L  
M  
AV  
O  
P

AV

## SATELLITE RADIO ANTENNA

< ON-VEHICLE REPAIR >

[BOSE AUDIO WITH NAVIGATION]

---

### SATELLITE RADIO ANTENNA

#### Removal and Installation

INFOID:000000001346521

For removal and installation, refer to [AV-116. "Removal and Installation"](#).

## GPS ANTENNA

## Removal and Installation

INFOID:000000001282617

## REMOVAL

1. Remove control device. Refer to [TM-208. "Control Device Removal and Installation"](#).
2. Remove center console. Refer to [IP-19. "Removal and Installation"](#).
3. Remove cluster lid D. Refer to [IP-11. "Removal and Installation"](#).
4. Disconnect center speaker.
5. Remove defroster grille. Refer to [IP-11. "Removal and Installation"](#).
6. Disconnect GPS antenna connector.

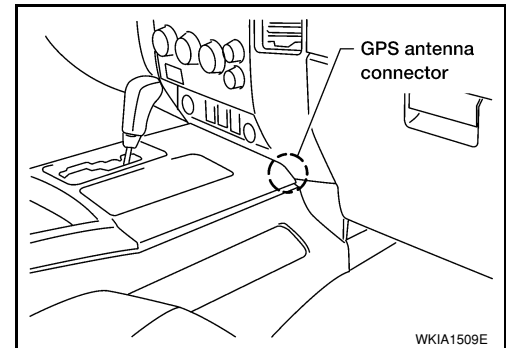

7. Remove the GPS antenna.

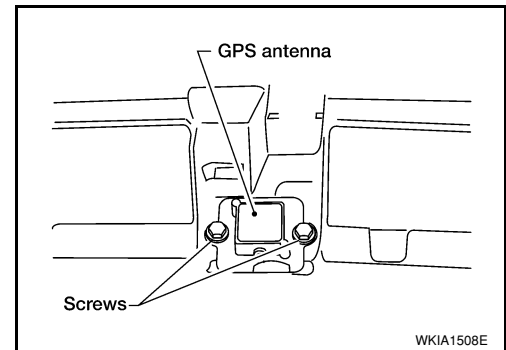

## INSTALLATION

Installation is in the reverse order of removal.

A  
B  
C  
D  
E  
F  
G  
H  
I  
J  
K  
L  
M  
AV  
O  
P

**MICROPHONE**

**Removal and Installation**

INFOID:000000001282619

For removal and installation, refer to [AV-454, "Removal and Installation"](#).

# REAR VIEW CAMERA

< ON-VEHICLE REPAIR >

[BOSE AUDIO WITH NAVIGATION]

## REAR VIEW CAMERA

### Removal and Installation

INFOID:000000001303726

### REAR VIEW CAMERA

For removal and installation, refer to [AV-455. "Removal and Installation"](#).

### Adjustment

INFOID:000000001303727

For adjustment on the rear view camera, refer to [AV-127. "System Diagram"](#).

A

B

C

D

E

F

G

H

I

J

K

L

M

AV

O

P

## REAR VIEW CAMERA CONTROL UNIT

< ON-VEHICLE REPAIR >

[BOSE AUDIO WITH NAVIGATION]

---

### REAR VIEW CAMERA CONTROL UNIT

#### Removal and Installation

INFOID:000000001303728

For removal and installation, refer to [AV-279. "Removal and Installation"](#).