

SECTION **DEF**
DEFOGGER

A
B
C

CONTENTS

BASIC INSPECTION	3	Component Inspection	17	F
DIAGNOSIS AND REPAIR WORKFLOW	3	REAR WINDOW DEFOGGER	19	G
Work Flow	3	Description	19	
FUNCTION DIAGNOSIS	4	Component Function Check	19	
REAR WINDOW DEFOGGER SYSTEM	4	Diagnosis Procedure	19	
System Diagram	4	Component Inspection	20	H
System Description	4	DOOR MIRROR DEFOGGER	21	
Component Parts Location	5	DRIVER SIDE	21	I
Component Description	5	DRIVER SIDE : Description	21	
DIAGNOSIS SYSTEM (BCM)	6	DRIVER SIDE : Component Function Check	21	
COMMON ITEM	6	DRIVER SIDE : Diagnosis Procedure	21	J
COMMON ITEM : CONSULT-III Function (BCM -		DRIVER SIDE : Component Inspection	22	
COMMON ITEM)	6	PASSENGER SIDE	22	K
REAR WINDOW DEFOGGER	6	PASSENGER SIDE : Description	22	
REAR WINDOW DEFOGGER : CONSULT-III		PASSENGER SIDE : Component Function Check	22	
Function (BCM - REAR DEFOGGER)	7	PASSENGER SIDE : Diagnosis Procedure	22	
DIAGNOSIS SYSTEM (IPDM E/R)	8	PASSENGER SIDE : Component Inspection	24	DEF
Diagnosis Description	8	REAR WINDOW DEFOGGER ON SIGNAL	25	M
CONSULT-III Function (IPDM E/R)	10	Description	25	
COMPONENT DIAGNOSIS	13	Component Function Check	25	
REAR WINDOW DEFOGGER SWITCH	13	Diagnosis Procedure	25	
Description	13	REAR WINDOW DEFOGGER SYSTEM	27	N
Component Function Check	13	Wiring Diagram - REAR WINDOW DEFOGGER		
Diagnosis Procedure	13	SYSTEM -	27	
REAR WINDOW DEFOGGER RELAY	15	ECU DIAGNOSIS	31	O
Description	15	BCM (BODY CONTROL MODULE)	31	P
Component Function Check	15	Reference Value	31	
Diagnosis Procedure	15	Wiring Diagram - BCM -	46	
DOOR MIRROR DEFOGGER RELAY	16	Fail-safe	50	
Description	16	DTC Inspection Priority Chart	51	
Component Function Check	16	DTC Index	51	
Diagnosis Procedure	16	IPDM E/R (INTELLIGENT POWER DISTRI-		
		BUTION MODULE ENGINE ROOM)	53	

D
E

F
G

H
I

J
K

L
M

N
O

P

Reference Value	53	PASSENGER SIDE	67
Wiring Diagram - IPDM E/R -	58	PASSENGER SIDE : Diagnosis Procedure	67
Fail-safe	61	REAR WINDOW DEFOGGER SWITCH DOES NOT LIGHT, BUT REAR WINDOW DEFOGGER OPERATES	68
DTC Index	63	Diagnosis Procedure	68
SYMPTOM DIAGNOSIS	64	PRECAUTION	69
REAR WINDOW DEFOGGER DOES NOT OPERATE	64	PRECAUTIONS	69
Diagnosis Procedure	64	FOR USA AND CANADA	69
REAR WINDOW DEFOGGER AND DOOR MIRROR DEFOGGER DO NOT OPERATE.	65	FOR USA AND CANADA : Precaution for Supplemental Restraint System (SRS) "AIR BAG" and "SEAT BELT PRE-TENSIONER"	69
Diagnosis Procedure	65	FOR MEXICO	69
REAR WINDOW DEFOGGER DOES NOT OPERATE BUT BOTH OF DOOR MIRROR DEFOGGER OPERATE.	66	FOR MEXICO : Precaution for Supplemental Restraint System (SRS) "AIR BAG" and "SEAT BELT PRE-TENSIONER"	69
Diagnosis Procedure	66	ON-VEHICLE REPAIR	70
DOOR MIRROR DEFOGGER DOES NOT OPERATE	67	FILAMENT	70
BOTH SIDE	67	Inspection and Repair	70
BOTH SIDE : Diagnosis Procedure	67		
DRIVER SIDE	67		
DRIVER SIDE : Diagnosis Procedure	67		

DIAGNOSIS AND REPAIR WORKFLOW

< BASIC INSPECTION >

BASIC INSPECTION

DIAGNOSIS AND REPAIR WORKFLOW

Work Flow

INFOID:000000004231704

DETAILED FLOW

1.OBTAIN INFORMATION ABOUT SYMPTOM

Interview the customer to obtain the malfunction information (conditions and environment when the malfunction occurred) as much as possible when the customer brings the vehicle in.

>> GO TO 2.

2.CHECK DTC

Perform self diagnosis with CONSULT-III

Is any DTC detected?

YES >> Refer to [DEF-51, "DTC Index"](#).

NO >> GO TO 3.

3.REPRODUCE THE MALFUNCTION INFORMATION

Check the malfunction on the vehicle that the customer describes.

Inspect the relation of the symptoms and the condition when the symptoms occur.

>> GO TO 4.

4.IDENTIFY THE MALFUNCTIONING SYSTEM WITH "SYMPTOM DIAGNOSIS"

Use "Symptom diagnosis" from the symptom inspection result in step 3. Then identify where to start performing the diagnosis based on possible causes and symptoms.

>> GO TO 5.

5.IDENTIFY THE MALFUNCTIONING PARTS WITH "COMPONENT DIAGNOSIS"

Perform the diagnosis with "Component diagnosis" of the applicable system.

>> GO TO 6.

6.REPAIR OR REPLACE THE MALFUNCTIONING PARTS

Repair or replace the specified malfunctioning parts.

>> GO TO 7.

7.FINAL CHECK

Check that malfunctions are not reproduced when obtaining the malfunction information from the customer, referring to the symptom inspection result in step 3.

Are all malfunctions corrected?

YES >> INSPECTION END

NO >> GO TO 4.

A
B
C
D
E
F
G
H
I
J
K
DEF
M
N
O
P

REAR WINDOW DEFOGGER SYSTEM

< FUNCTION DIAGNOSIS >

FUNCTION DIAGNOSIS

REAR WINDOW DEFOGGER SYSTEM

System Diagram

INFOID:000000004231705

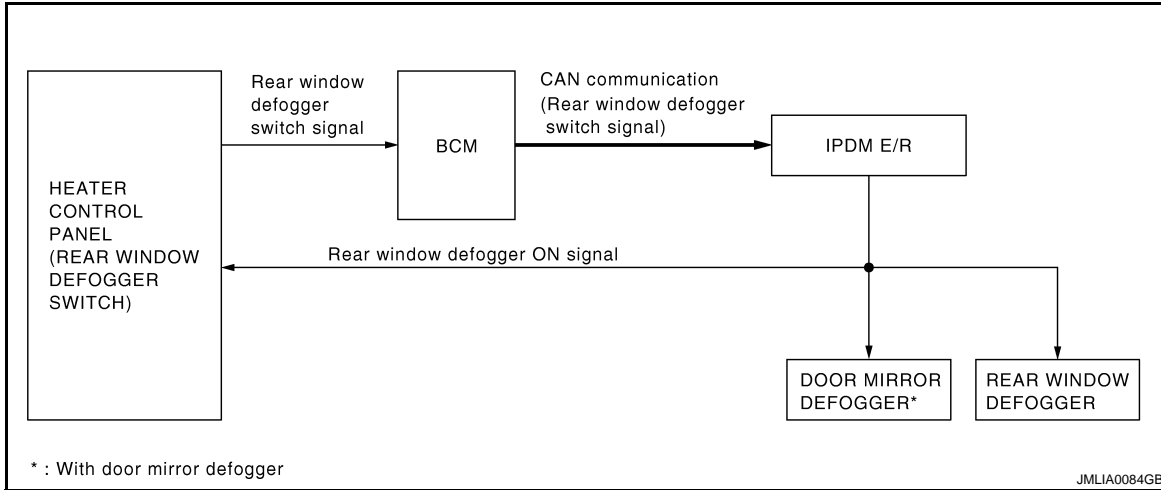

System Description

INFOID:000000004231706

OPERATION DESCRIPTION

- BCM detects that the rear window defogger switch is turned ON when the ignition switch is ON, and then transmits the rear window defogger switch signal to IPDM E/R via CAN communication for approximately 15 minutes.
- IPDM E/R turns rear window defogger relay ON when it receives the rear window defogger switch signal.
- The power is supplied by IPDM E/R to the rear window defogger and door mirror defogger (with door mirror defogger) when the rear window defogger relay is turned ON.

TIMER FUNCTION

- BCM transmits the rear window defogger switch signal to IPDM E/R for approximately 15 minutes when the rear window defogger switch is turned ON with the ignition switch ON. Then, IPDM E/R operates the rear window defogger and door mirror defogger (with door mirror defogger).
- The timer is cancelled if the rear window defogger switch is pressed again during timer operation. Then BCM stops the output of rear window defogger switch signal. The same reaction also occurs during timer operation if the ignition switch is turned OFF.

INPUT/OUTPUT SIGNAL CHART

Switch	Input signal to BCM	BCM function	Acuator
Rear window defogger switch	Defogger switch signal	Rear window defogger & Door mirror defogger control	Rear window defogger Door mirror defogger
Ignition switch	Ignition switch ON signal Ignition switch ACC signal		

REAR WINDOW DEFOGGER SYSTEM

< FUNCTION DIAGNOSIS >

Component Parts Location

INFOID:000000004231707

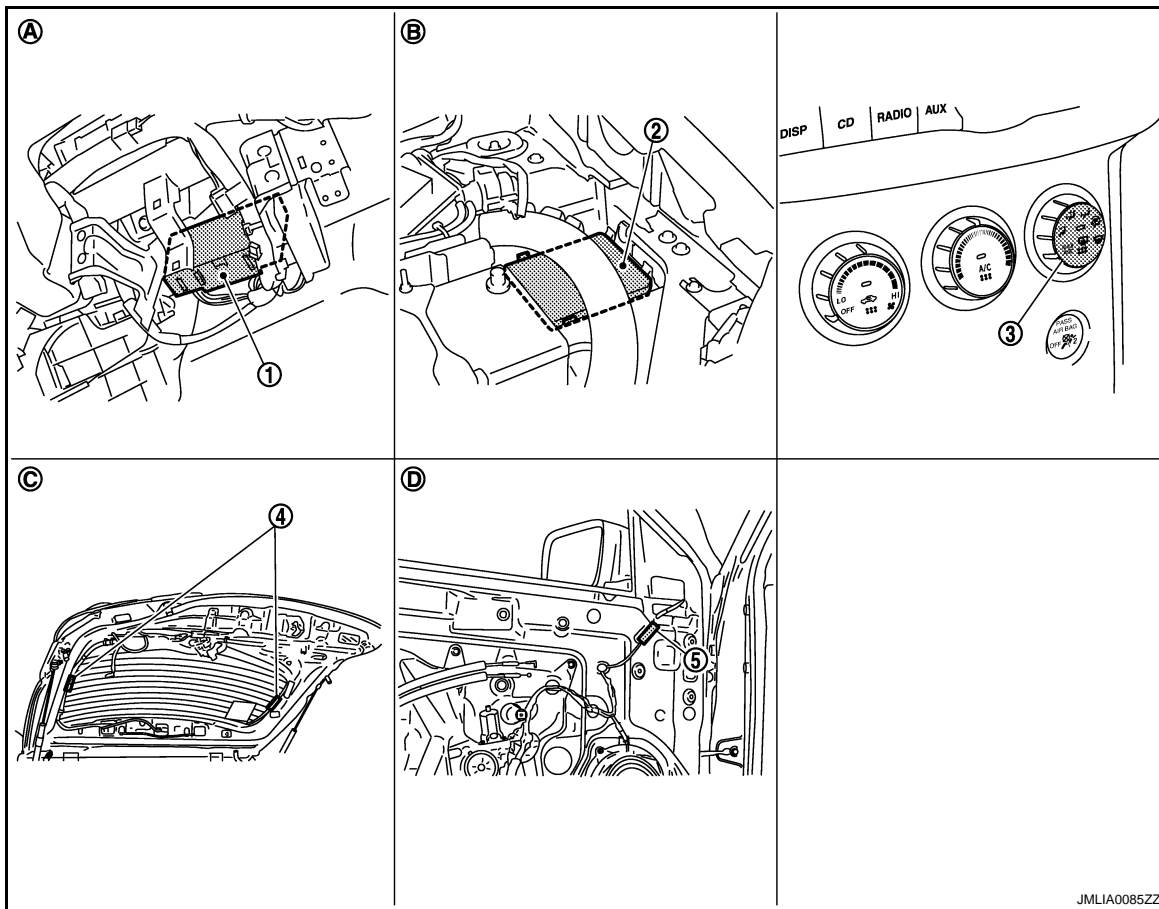

- | | | |
|------------------------------------|---------------------------------|--|
| 1. BCM M65, M67 | 2. IPDM E/R E11, E13 | 3. Rear window defogger switch (built in A/C amp.) M50 |
| 4. Rear window defogger D160, D185 | 5. Door mirror defogger D3, D43 | |
| A. Behind glove box | B. Engine room (LH) | C. Behind back door side finisher |
| D. Behind front door finisher | | |

Component Description

INFOID:000000004231708

BCM	<ul style="list-style-type: none"> Rear window defogger switch operation is transmitted to IPDM E/R via CAN communication. Performs the timer control of rear window defogger.
Rear window defogger relay	<ul style="list-style-type: none"> Operates the rear window defogger and the door mirror defogger relay with the control signal from IPDM E/R.
Door mirror defogger relay	<ul style="list-style-type: none"> Operates the door mirror defogger with the control signal from IPDM E/R (rear window defogger relay).
IPDM E/R	<ul style="list-style-type: none"> BCM controls rear window defogger relay via CAN communication, and then operates rear window defogger or door mirror defogger.
A/C amp. (Rear window defogger switch)	<ul style="list-style-type: none"> The rear window defogger switch is installed. Turns the indicator lamp ON when detecting the operation of rear window defogger.
Rear window defogger	<ul style="list-style-type: none"> Heats the heating wire with the power supply from the rear window defogger relay to prevent the rear window from fogging up.
Door mirror defogger	<ul style="list-style-type: none"> Heats the heating wire with the power supply from the rear window defogger relay to prevent the door mirror from fogging up.

A
B
C
D
E
F
G
H
I
J
K

DEF

M
N
O
P

DIAGNOSIS SYSTEM (BCM)

< FUNCTION DIAGNOSIS >

DIAGNOSIS SYSTEM (BCM)

COMMON ITEM

COMMON ITEM : CONSULT-III Function (BCM - COMMON ITEM)

INFOID:000000004231709

APPLICATION ITEM

CONSULT-III can display each diagnostic item using the diagnostic test modes shown following.

Diagnosis mode	Function description
ECU Identification	BCM part number is displayed.
Self-Diagnostic Result	Displays the diagnosis results judged by BCM. Refer to BCS-63, "DTC Index" .
Data Monitor	BCM input/output signals are displayed.
Active Test	The signals used to activate each device are forcibly supplied from BCM.
Work Support	Changes the setting for each system function.
Configuration	<ul style="list-style-type: none"> Read and save the vehicle specification. Write the vehicle specification when replacing BCM.
CAN Diag Support Monitor	Monitors the reception status of CAN communication viewed from BCM.

SYSTEM APPLICATION

BCM can perform the following functions for each system.

NOTE:

It can perform the diagnosis modes except the following for all sub system selection items.

×: Applicable item

System	CONSULT-III sub system selection item	Diagnosis mode		
		Work Support	Data Monitor	Active Test
Door lock	DOOR LOCK	×	×	×
Rear window defogger	REAR DEFOGGER		×	×
Warning chime	BUZZER		×	×
Interior room lamp control	INT LAMP	×	×	×
Remote keyless entry system	MULTI REMOTE ENT	×	×	×
Exterior lamp	HEAD LAMP	×	×	×
Wiper and washer	WIPER	×	×	×
Turn signal and hazard warning lamps	FLASHER		×	×
Air conditioner	AIR CONDITONER		×	
Intelligent Key system	INTELLIGENT KEY		×	
Combination switch	COMB SW		×	
—	BCM	×		
Immobilizer	IMMU		×	×
Interior room lamp battery saver	BATTERY SAVER	×	×	×
Back door open	TRUNK		×	×
Vehicle security system	THEFT ALM	×	×	×
RAP system	RETAINED PWR	×	×	×
Signal buffer system	SIGNAL BUFFER		×	×
—	FUEL LID*			
TPMS	TPMS (AIR PRESSURE MONITOR)	×	×	×
Panic alarm system	PANIC ALARM			×

*: This item is displayed, but is not function.

REAR WINDOW DEFOGGER

DIAGNOSIS SYSTEM (BCM)

< FUNCTION DIAGNOSIS >

REAR WINDOW DEFOGGER : CONSULT-III Function (BCM - REAR DEFOGGER)

INFOID:000000004231710

Data monitor

Monitor Item	Description
REAR DEF SW	Displays "Press (ON)/other (OFF)" status determined with the rear window defogger switch.
IGN ON SW	Indicates [ON/OFF] condition of ignition switch in ON position.
ACC ON SW	Indicates [ON/OFF] condition of ignition switch in ACC position.

ACTIVE TEST

Test Item	Description
REAR DEFOGGER	This test is able to check rear window defogger operation.

A
B
C
D
E
F
G
H
I
J
K
DEF
M
N
O
P

DEF

DIAGNOSIS SYSTEM (IPDM E/R)

< FUNCTION DIAGNOSIS >

DIAGNOSIS SYSTEM (IPDM E/R)

Diagnosis Description

INFOID:000000004231711

Auto active test

Description

In auto active test mode, the IPDM E/R sends a drive signal to the following systems to check their operation.

- Oil pressure warning lamp
- Rear window defogger
- Front wiper (LO, HI)
- Parking lamps
- License plate lamps
- Tail lamps
- Front fog lamps
- Headlamps (LO, HI)
- A/C compressor (magnet clutch)
- Cooling fan (LO, MID, HI)

Operation procedure

1. Close the hood and lift the wiper arms from the windshield. (Prevent windshield damage due to wiper operation)

NOTE:

When auto active test is performed with hood opened, sprinkle water on windshield beforehand.

2. Turn the ignition switch OFF.
3. Turn the ignition switch ON, and within 20 seconds, press the driver door switch 10 times. Then turn the ignition switch OFF.

CAUTION:

Close passenger door.

4. Turn the ignition switch ON within 10 seconds. Then the horn sounds once and the auto active test starts.

NOTE:

Only a vehicle with the vehicle security system, the horn sounds.

5. The oil pressure warning lamp starts blinking when the auto active test starts.
6. After a series of the following operations is repeated 3 times, auto active test is completed.

NOTE:

When auto active test mode has to be cancelled halfway through test, turn the ignition switch OFF.

CAUTION:

- **If auto active test mode cannot be actuated, check door switch system.**
- **Never start the engine.**

Inspection in auto active test mode

When auto active test mode is actuated, the following 6 steps are repeated 3 times.

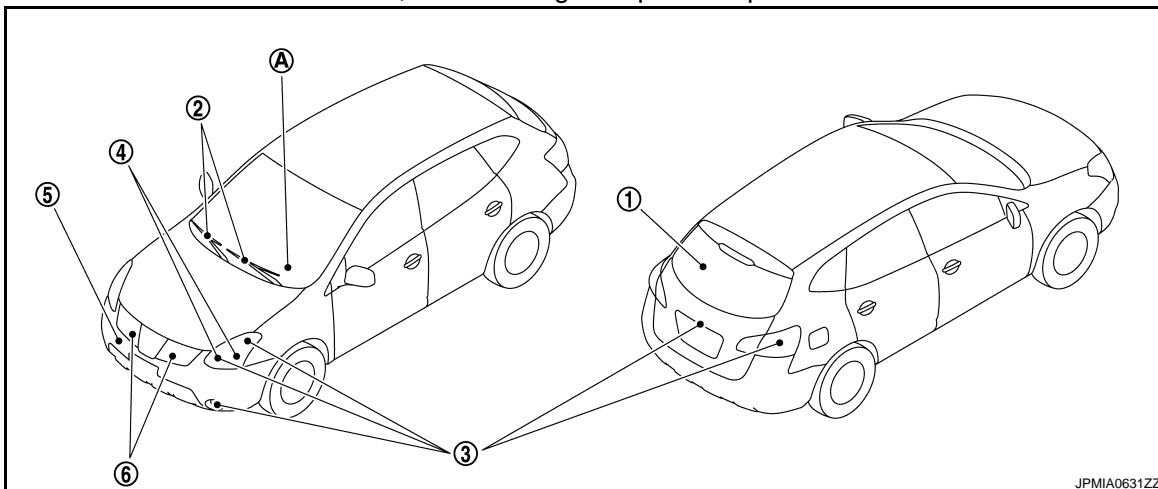

DIAGNOSIS SYSTEM (IPDM E/R)

< FUNCTION DIAGNOSIS >

Operation sequence	Inspection location	Operation
A	Oil pressure warning lamp	Blinks continuously during operation of auto active test.
1	Rear window defogger	10 seconds
2	Front wiper	LO for 5 seconds → HI for 5 seconds
3	<ul style="list-style-type: none"> • Parking lamps • License plate lamps • Tail lamps • Front fog lamps • Headlamps HI (daytime running light operation)* 	10 seconds
4	Headlamps	LO ↔ HI 5 times
5	A/C compressor (magnet clutch)	ON ↔ OFF 5 times
6	Cooling fan	LO for 5 seconds → MID for 3 seconds → HI for 2 seconds

NOTE:

*: With daytime running light system

Concept of auto active test

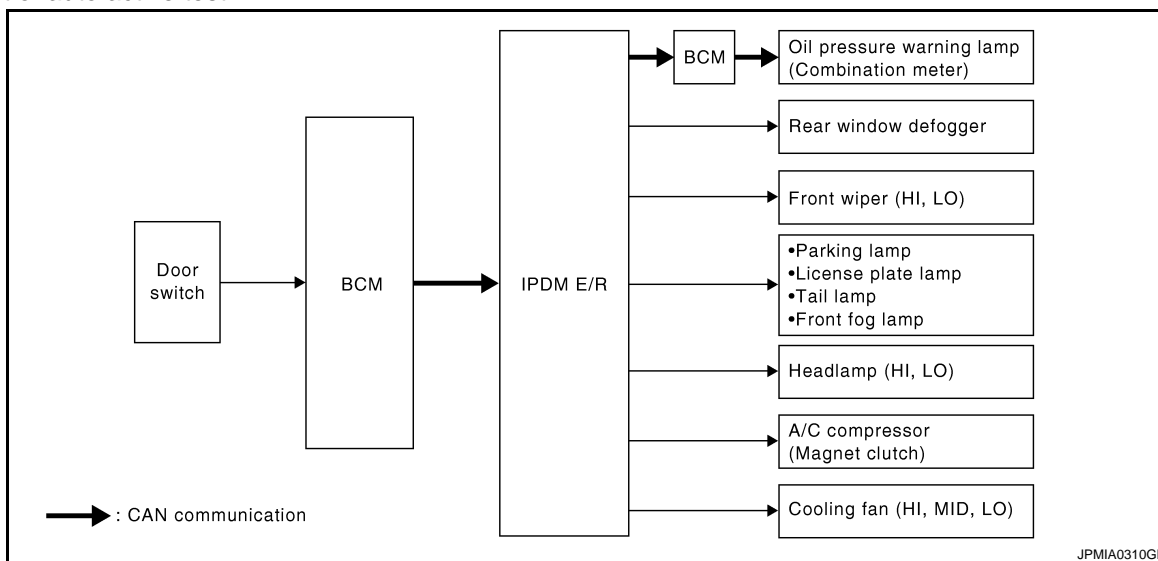

- IPDM E/R starts the auto active test with the door switch signals transmitted by BCM via CAN communication. Therefore, the CAN communication line between IPDM E/R and BCM is considered normal if the auto active test starts successfully.
- The auto active test facilitates troubleshooting if any systems controlled by IPDM E/R cannot be operated.

Diagnosis chart in auto active test mode

Symptom	Inspection contents	Possible cause
Rear window defogger does not operate	Perform auto active test. Does the rear window defogger operate?	YES BCM signal input circuit
		NO <ul style="list-style-type: none"> • Rear window defogger • Rear window defogger ground circuit • Harness or connector between IPDM E/R and rear window defogger • IPDM E/R
Any of the following components do not operate <ul style="list-style-type: none"> • Parking lamps • License plate lamps • Tail lamps • Front fog lamps • Headlamps (HI, LO) • Front wiper (HI, LO) 	Perform auto active test. Does the applicable system operate?	YES BCM signal input circuit
		NO <ul style="list-style-type: none"> • Lamp or motor • Lamp or motor ground circuit • Harness or connector between IPDM E/R and applicable system • IPDM E/R

DIAGNOSIS SYSTEM (IPDM E/R)

< FUNCTION DIAGNOSIS >

Symptom	Inspection contents	Possible cause
Headlamps HI (daytime running light operation) do not operate	Perform auto active test. Do headlamps HI (daytime running light operation) operate?	YES <ul style="list-style-type: none"> • CAN communication signal between ECM and BCM • CAN communication signal between combination meter and BCM • BCM signal input circuit
		NO <ul style="list-style-type: none"> • Daytime running light relay power supply circuit • Harness or connector between IPDM E/R and daytime running light relay • Daytime running light relay
A/C compressor does not operate	Perform auto active test. Does the magnet clutch operate?	YES <ul style="list-style-type: none"> • BCM signal input circuit • CAN communication signal between BCM and ECM • CAN communication signal between ECM and IPDM E/R
		NO <ul style="list-style-type: none"> • Magnet clutch • Harness or connector between IPDM E/R and magnet clutch • IPDM E/R
Oil pressure warning lamp does not operate	Perform auto active test. Does the oil pressure warning lamp blink?	YES <ul style="list-style-type: none"> • Harness or connector between IPDM E/R and oil pressure switch • Oil pressure switch • IPDM E/R
		NO <ul style="list-style-type: none"> • CAN communication signal between IPDM E/R and BCM • CAN communication signal between BCM and combination meter • Combination meter
Cooling fan does not operate	Perform auto active test. Does the cooling fan operate?	YES <ul style="list-style-type: none"> • ECM signal input circuit • CAN communication signal between ECM and IPDM E/R
		NO <ul style="list-style-type: none"> • Cooling fan motor-2 power supply circuit • Cooling fan motor-1 ground circuit • Cooling fan relay-4 or cooling fan relay-5 power supply circuit • Cooling fan relay-5 ground circuit • Harness or connector between IPDM E/R and cooling fan motor • Harness or connector between IPDM E/R, and cooling fan relay-4 or cooling fan relay-5 • Harness or connector between cooling fan motor-2, and cooling fan relay-4 or cooling fan relay-5 • Cooling fan relay-4 or cooling fan relay-5 • Cooling fan motor • IPDM E/R

CONSULT-III Function (IPDM E/R)

INFOID:000000004231712

APPLICATION ITEM

CONSULT-III performs the following functions via CAN communication with IPDM E/R.

Diagnosis mode	Description
Self Diagnostic Result	Displays the diagnosis results judged by IPDM E/R.
Data Monitor	Displays the real-time input/output data from IPDM E/R input/output data.

DIAGNOSIS SYSTEM (IPDM E/R)

< FUNCTION DIAGNOSIS >

Diagnosis mode	Description
Active Test	IPDM E/R can provide a drive signal to electronic components to check their operations.
CAN Diag Support Monitor	The results of transmit/receive diagnosis of CAN communication can be read.

SELF DIAGNOSTIC

Refer to [PCS-26. "DTC Index"](#).

DATA MONITOR

Monitor item

Monitor Item [Unit]	MAIN SIGNALS	Description
MOTOR FAN REQ [1 - 4]	×	Displays the value of the cooling fan speed signal received from ECM via CAN communication.
AC COMP REQ [Off/On]	×	Displays the status of the A/C compressor request signal received from ECM via CAN communication.
TAIL&CLR REQ [Off/On]	×	Displays the status of the position light request signal received from BCM via CAN communication.
HL LO REQ [Off/On]	×	Displays the status of the low beam request signal received from BCM via CAN communication.
HL HI REQ [Off/On]	×	Displays the status of the high beam request signal received from BCM via CAN communication.
FR FOG REQ [Off/On]	×	Displays the status of the front fog light request signal received from BCM via CAN communication. NOTE: This item is monitored only the vehicle with front fog lamp system.
FR WIP REQ [Stop/1LOW/Low/Hi]	×	Displays the status of the front wiper request signal received from BCM via CAN communication.
WIP AUTO STOP [STOP P/ACT P]	×	Displays the status of the front wiper stop position signal judged by IPDM E/R.
WIP PROT [Off/BLOCK]	×	Displays the status of the front wiper fail-safe operation judged by IPDM E/R.
ST RLY REQ [Off/On]		Displays the status of the starter request signal.
IGN RLY [Off/On]	×	Displays the status of the ignition relay judged by IPDM E/R.
RR DEF REQ [Off/On]	×	Displays the status of the rear defogger request signal received from BCM via CAN communication.
OIL P SW [Open/Close]		Displays the status of the oil pressure switch judged by IPDM E/R.
DTRL REQ [Off/On]		Displays the status of the daytime running light request signal received from BCM via CAN communication. NOTE: This item is monitored only the vehicle with daytime running light system.
HOOD SW [Off/On]		Displays the status of the hood switch judged by IPDM E/R. NOTE: This item is monitored only the vehicle for Mexico.
THFT HRN REQ [Off/On]		Displays the status of the horn request signal by vehicle security system or panic alarm system received from BCM via CAN communication.
HORN CHIRP [Off/On]		Displays the status of the horn request signal by key fob LOCK operation received from BCM via CAN communication.

ACTIVE TEST

Test item

DIAGNOSIS SYSTEM (IPDM E/R)

< FUNCTION DIAGNOSIS >

Test item	Operation	Description
REAR DEFOGGER	Off	OFF
	On	Operates the rear window defogger relay.
FRONT WIPER	Off	OFF
	Lo	Operates the front wiper relay.
	Hi	Operates the front wiper relay and front wiper high relay.
MOTOR FAN	1	OFF
	2	Operates the cooling fan relay (LO operation).
	3	Operates the cooling fan relay (MID operation).
	4	Operates the cooling fan relay (HI operation).
EXTERNAL LAMPS	Off	OFF
	TAIL	Operates the tail lamp relay and the daytime running light relay. NOTE: Daytime running light relay is with daytime running light system only.
	Lo	Operates the headlamp low relay.
	Hi	Operates the headlamp low relay and ON/OFF the headlamp high relay at 4 seconds intervals.
	Fog	Operates the front fog lamp relay. NOTE: This item can test only the vehicle with front fog lamp system.
HORN	On	Operates horn relay for 20 ms.

REAR WINDOW DEFOGGER SWITCH

< COMPONENT DIAGNOSIS >

COMPONENT DIAGNOSIS

REAR WINDOW DEFOGGER SWITCH

Description

INFOID:000000004231713

Rear window defogger switch is installed on A/C amp.
The rear window defogger is operated by turning the rear window defogger switch ON.

Component Function Check

INFOID:000000004231714

1. CHECK REAR WINDOW DEFOGGER SWITCH

1. Select "REAR DEF SW" in "Data Monitor" (BCM) mode with CONSULT-III.
2. Check rear window defogger switch signal under following condition.

Monitor item	Condition		Status
REAR DEF SW	Rear window defogger switch	Pressed	ON
		Other than above	OFF

Is the inspection result normal?

- YES >> Rear window defogger switch is OK.
NO >> Refer to [DEF-13, "Diagnosis Procedure"](#).

Diagnosis Procedure

INFOID:000000004231715

1. CHECK REAR WINDOW DEFOGGER SWITCH

1. Turn ignition switch ON.
2. Check voltage between BCM harness connector and ground.

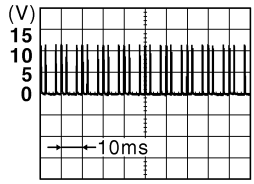
(+)		(-)	Condition	Voltage (V) (Approx.)
BCM				
Connector	Terminal			
M65	10	Ground	Rear window defogger switch	0
			Other than above	

JPMAI0154GB

Is the inspection result normal?

- YES >> GO TO 5.
NO >> GO TO 2.

2. CHECK REAR WINDOW DEFOGGER SWITCH CIRCUIT

1. Turn ignition switch OFF.
2. Disconnect BCM connector and A/C amp. connector.
3. Check continuity between BCM harness connector and A/C amp. harness connector.

BCM		A/C amp.		Continuity
Connector	Terminal	Connector	Terminal	
M65	10	M50	38	Existed

4. Check continuity between BCM harness connector and ground.

REAR WINDOW DEFOGGER SWITCH

< COMPONENT DIAGNOSIS >

BCM		Ground	Continuity
Connector	Terminal		
M65	10		Not existed

Is the inspection result normal?

- YES >> GO TO 3.
 NO >> Repair or replace harness.

3. CHECK REAR WINDOW DEFOGGER SWITCH GROUND CIRCUIT

Check continuity between A/C amp. harness connector and ground.

A/C amp.		Ground	Continuity
Connector	Terminal		
M50	3		Existed

Is the inspection result normal?

- YES >> GO TO 4.
 NO >> Repair or replace harness.

4. CHECK BCM OUTPUT SIGNAL

1. Connect BCM connector.
2. Turn ignition switch ON.
3. Check voltage between BCM harness connector and ground.

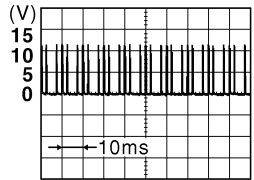
(+)		(-)	Voltage (V) (Approx.)
BCM			
Connector	Terminal		
M65	10	Ground	

JPMIA0154GB

Is the inspection result normal?

- YES >> GO TO 5.
 NO >> Replace BCM. Refer to [BCS-67, "Removal and Installation"](#).

5. CHECK IINTERMITTENT INCIDENT

Refer to [GI-41, "Intermittent Incident"](#)

Is the inspection result normal?

- YES >> Check A/C control system. Refer to [HAC-3, "Work Flow"](#).
 NO >> Repair or replace the malfunctioning parts.

REAR WINDOW DEFOGGER RELAY

< COMPONENT DIAGNOSIS >

REAR WINDOW DEFOGGER RELAY

Description

INFOID:000000004231716

Rear window defogger relay is installed on IPDM E/R.
The rear window defogger relay is operated by turning the rear window defogger switch ON.

Component Function Check

INFOID:000000004231717

1.CHECK REAR WINDOW DEFOGGER RELAY

1. Select "REAR DEFOGGER" in "Active Test" (IPDM E/R) mode with CONSULT-III.
2. Check rear window defogger relay operation.

Test item		Description	
REAR DEFOGGER	ON	Rear window defogger relay	ON
	OFF		OFF

Is the inspection result normal?

- YES >> Rear window defogger relay is OK.
NO >> Refer to [DEF-15. "Diagnosis Procedure"](#).

Diagnosis Procedure

INFOID:000000004231718

1.CHECK FUSE

1. Turn ignition switch OFF.
2. Check the following.
 - 15A fuse (No. 55, located in IPDM E/R)
 - 15A fuse (No. 56, located in IPDM E/R)

Is the inspection result normal?

- YES >> GO TO 2.
NO >> Replace the blown fuse after repairing the affected circuit if a fuse is blown.

2.CHECK IPDM E/R OUTPUT SIGNAL

1. Turn ignition switch ON.
2. Check voltage between IPDM E/R harness connector and ground.

(+)		(-)	Condition	Voltage (V) (Approx.)
IPDM E/R				
Connector	Terminal			
E11	12	Ground	Rear window de-fogger	Battery voltage
				0

Is the inspection result normal?

- YES >> GO TO 3.
NO >> Replace IPDM E/R. Refer to [PCS-28. "Removal and Installation"](#).

3.CHECK INTERMITTENT INCIDENT

Refer to [GI-41. "Intermittent Incident"](#)

>> INSPECTION END

DOOR MIRROR DEFOGGER RELAY

< COMPONENT DIAGNOSIS >

DOOR MIRROR DEFOGGER RELAY

Description

INFOID:000000004231719

The door mirror defogger relay is operated by turning the rear window defogger switch ON.

Component Function Check

INFOID:000000004231720

1.CHECK DRIVER SIDE DOOR MIRROR DEFOGGER

Check that heating wire of driver side door mirror defogger is heated when turning the rear window defogger switch ON.

Is the inspection result normal?

- YES >> Door mirror defogger relay is OK.
 NO >> Refer to [DEF-16, "Diagnosis Procedure"](#).

Diagnosis Procedure

INFOID:000000004231721

1.CHECK DOOR MIRROR DEFOGGER RELAY POWER SUPPLY 1

1. Turn ignition switch OFF.
2. Disconnect door mirror defogger relay.
3. Check voltage between door mirror defogger relay harness connector and ground.

(+)		(-)	Voltage (V) (Approx.)
Door mirror defogger relay			
Connector	Terminal		
M10	1	Ground	Battery voltage

Is the inspection result normal?

- YES >> GO TO 2.
 NO >> Check the following
- Repair or replace harness between door mirror defogger relay and fuse block (J/B).
 - 10A fuse [No.7, located fuse block (J/B)]

2.CHECK DOOR MIRROR DEFOGGER RELAY POWER SUPPLY 2

Check voltage between door mirror defogger relay harness connector and ground.

(+)		(-)	Condition	Voltage (V) (Approx.)
Door mirror defogger relay				
Connector	Terminal			
M10	3	Ground	Turn ignition switch is ON and rear window defogger is ON	Battery voltage
			Other than above	0

Is the inspection result normal?

- YES >> GO TO 4.
 NO >> GO TO 3.

3.CHECK DOOR MIRROR DEFOGGER RELAY POWER SUPPLY CIRCUIT

1. Disconnect IPDM E/R connector.
2. Check continuity between door mirror defogger harness connector and IPDM E/R harness connector.

Door mirror defogger relay		IPDM E/R		Continuity
Connector	Terminal	Connector	Terminal	
M10	3	E11	12	Existed

3. Check continuity between door mirror defogger relay harness connector and ground.

DOOR MIRROR DEFOGGER RELAY

< COMPONENT DIAGNOSIS >

Door mirror defogger relay		Ground	Continuity
Connector	Terminal		
M10	3		Not existed

Is the inspection result normal?

- YES >> Replace IPDM E/R. Refer to [PCS-28, "Removal and Installation"](#).
 NO >> Repair or replace harness.

4.CHECK DOOR MIRROR DEFOGGER RELAY GROUND CIRCUIT

Check continuity between door mirror defogger relay harness connector and ground.

Door mirror defogger relay		Ground	Continuity
Connector	Terminal		
M10	4		Existed

Is the inspection result normal?

- YES >> GO TO 5.
 NO >> Repair or replace harness.

5.CHECK DOOR MIRROR DEFOGGER POWER SUPPLY CIRCUIT

1. Disconnect door mirror connector.
2. Check continuity between door mirror harness connector and door mirror defogger relay harness connector.

Door mirror defogger relay		Door mirror defogger		Continuity
Connector	Terminal	Connector	Terminal	
M10	2	D3 (driver side)	1	Existed
		D43 (passenger side)		

3. Check continuity between door mirror defogger relay harness connector and ground.

Door mirror defogger relay		Ground	Continuity
Connector	Terminal		
M10	2		Not existed

Is the inspection result normal?

- YES >> GO TO 6.
 NO >> Repair or replace harness.

6.CHECK DOOR MIRROR DEFOGGER GROUND CIRCUIT

1. Check continuity between door mirror defogger relay harness connector and ground.

Door mirror defogger		Ground	Continuity
Connector	Terminal		
D3 (driver side)	5		Existed
D43 (passenger side)			

Is the inspection result normal?

- YES >> Replace mirror. Refer to [MIR-20, "GLASS MIRROR : Disassembly and Assembly"](#).
 NO >> Repair or replace harness.

Component Inspection

INFOID:000000004231722

1.CHECK DOOR MIRROR DEFOGGER RELAY

Check continuity door mirror defogger relay terminals.

A
B
C
D
E
F
G
H
I
J
K
M
N
O
P

DEF

DOOR MIRROR DEFOGGER RELAY

< COMPONENT DIAGNOSIS >

Door mirror defogger relay	Terminal		Condition	Continuity
M10	1	2	Battery voltage direct current supply between terminals 3 and 4	Existed
			Other than above	Does not existed

Is the inspection result normal?

- YES >> Door mirror defogger relay is OK.
NO >> Replace door mirror defogger relay.

REAR WINDOW DEFOGGER

< COMPONENT DIAGNOSIS >

REAR WINDOW DEFOGGER

Description

INFOID:000000004231723

Heats the heating wire with the power supply from the rear window defogger relay to prevent the rear window from fogging up.

Component Function Check

INFOID:000000004231724

1.CHECK REAR WINDOW DEFOGGER

Check that the heating wire of rear window defogger is heated when turning the rear window defogger switch ON.

Is the inspection result normal?

- YES >> Rear window defogger is OK.
NO >> Refer to [DEF-19. "Diagnosis Procedure"](#).

Diagnosis Procedure

INFOID:000000004231725

1.CHECK REAR WINDOW DEFOGGER POWER SUPPLY CIRCUIT

1. Turn ignition switch OFF.
2. Disconnect rear window defogger connector.
3. Turn ignition switch ON.
4. Check voltage between rear window defogger harness connector and ground.

(+)		(-)	Condition	Voltage (V) (Approx.)
Connector	Terminal			
D160	1	Ground	Rear window de-fogger switch ON	Battery voltage
			OFF	0

Is the inspection result normal?

- YES >> GO TO 2.
NO >> GO TO 4.

2.CHECK REAR WINDOW DEFOGGER GROUND CIRCUIT

1. Turn ignition switch OFF.
2. Check continuity between rear window defogger harness connector and ground.

Rear window defogger		Ground	Continuity
Connector	Terminal		
D185	2		Existed

Is the inspection result normal?

- YES >> GO TO 3.
NO >> Repair or replace harness.

3.CHECK FILAMENT

Check filament.

Refer to [DEF-20. "Component Inspection"](#).

Is the inspection result normal?

- YES >> GO TO 5.
NO >> Repair filament.

4.CHECK REAR WINDOW DEFOGGER POWER SUPPLY CIRCUIT

1. Turn ignition switch OFF.
2. Disconnect IPDM E/R and rear window defogger connectors.

REAR WINDOW DEFOGGER

< COMPONENT DIAGNOSIS >

3. Check continuity between IPDM E/R harness connector and rear window defogger harness connector.

IPDM E/R		Rear window defogger		Continuity
Connector	Terminal	Connector	Terminal	
E11	12	D160	1	Existed

4. Check continuity between IPDM E/R harness connector and ground.

IPDM E/R		Ground	Continuity
Connector	Terminal		
E11	12		Not existed

Is the inspection result normal?

YES >> GO TO 5.

NO >> Repair or replace harness.

5.CHECK INTERMITTENT INCIDENT

Refer to [GI-41, "Intermittent Incident"](#)

>> INSPECTION END

Component Inspection

INFOID:000000004231726

1.CHECK FILAMENT

Check the filament for damage or blown.
Refer to [DEF-70, "Inspection and Repair"](#).

Is the inspection result normal?

YES >> INSPECTION END

NO >> Repair filament.

DOOR MIRROR DEFOGGER

< COMPONENT DIAGNOSIS >

DOOR MIRROR DEFOGGER DRIVER SIDE

DRIVER SIDE : Description

INFOID:000000004231727

Heats the heating wire with the power supply from the door mirror defogger relay to prevent the door mirror from fogging up.

DRIVER SIDE : Component Function Check

INFOID:000000004231728

1.CHECK DRIVER SIDE DOOR MIRROR DEFOGGER

Check that heating wire of driver side door mirror defogger is heated when turning the rear window defogger switch ON.

Is the inspection result normal?

YES >> Driver side door mirror defogger is OK.

NO >> Refer to [DEF-21, "DRIVER SIDE : Diagnosis Procedure"](#).

DRIVER SIDE : Diagnosis Procedure

INFOID:000000004231729

1.CHECK DOOR MIRROR DEFOGGER POWER SUPPLY CIRCUIT

1. Turn ignition switch OFF.
2. Disconnect door mirror (driver side) connector.
3. Turn ignition switch ON.
4. Check voltage between door mirror (driver side) harness connector and ground.

(+)		(-)	Condition	Voltage (V) (Approx.)	
Connector	Terminal				
D3	1	Ground	Rear window de-fogger switch	ON	Battery voltage
			OFF	0	

Is the inspection result normal?

YES >> GO TO 2.

NO >> GO TO 4.

2.CHECK DOOR MIRROR DEFOGGER GROUND CIRCUIT

1. Turn ignition switch OFF.
2. Check continuity between door mirror (driver side) harness connector and ground.

Door mirror (driver side)		Ground	Continuity
Connector	Terminal		
D3	5		Existed

Is the inspection result normal?

YES >> GO TO 3.

NO >> Repair or replace harness.

3.CHECK DRIVER SIDE DOOR MIRROR DEFOGGER

Check driver side door mirror defogger.

Refer to [DEF-22, "DRIVER SIDE : Component Inspection"](#).

Is the inspection result normal?

YES >> GO TO 5.

NO >> Replace door mirror glass (driver side). Refer to [MIR-20, "GLASS MIRROR : Disassembly and Assembly"](#).

4.CHECK DOOR MIRROR CIRCUIT

1. Turn ignition switch OFF.

DOOR MIRROR DEFOGGER

< COMPONENT DIAGNOSIS >

2. Disconnect door mirror defogger relay connector and door mirror (driver side) connector.
3. Check continuity between door mirror (driver side) harness connector and door mirror defogger relay harness connector.

Door mirror (driver side)		Door mirror defogger relay		Continuity
Connector	Terminal	Connector	Terminal	
D3	1	M10	2	Existed

4. Check continuity between door mirror (driver side) harness connector and ground.

Door mirror (driver side)		Ground	Continuity
Connector	Terminal		
D3	1		Not existed

Is the inspection result normal?

YES >> GO TO 5.

NO >> Repair or replace harness.

5.CHECK INTERMITTENT

Refer to [GI-41, "Intermittent Incident"](#)

>> INSPECTION END

DRIVER SIDE : Component Inspection

INFOID:000000004231730

1.CHECK DRIVER SIDE DOOR MIRROR DEFOGGER

1. Turn ignition switch OFF.
2. Disconnect door mirror (driver side) connector.
3. Check continuity between door mirror terminals.

Door mirror (diver side)			Continuity
Connector	Terminal		
D3	1	5	Existed

Is the inspection result normal?

YES >> INSPECTION END

NO >> Replace door mirror glass (driver side). Refer to [MIR-20, "GLASS MIRROR : Disassembly and Assembly"](#).

PASSENGER SIDE

PASSENGER SIDE : Description

INFOID:000000004231731

Heats the heating wire with the power supply from the door mirror defogger relay to prevent the door mirror from fogging up.

PASSENGER SIDE : Component Function Check

INFOID:000000004231732

1.CHECK PASSENGER SIDE DOOR MIRROR DEFOGGER

Check that heating wire of passenger side door mirror defogger is heated when turning the rear window defogger switch ON.

Is the inspection result normal?

YES >> Passenger side door mirror defogger is OK.

NO >> Refer to [DEF-22, "PASSENGER SIDE : Diagnosis Procedure"](#).

PASSENGER SIDE : Diagnosis Procedure

INFOID:000000004231733

1.CHECK DOOR MIRROR DEFOGGER POWER SUPPLY CIRCUIT

1. Turn ignition switch OFF.

DOOR MIRROR DEFOGGER

< COMPONENT DIAGNOSIS >

2. Disconnect door mirror (passenger side) connector.
3. Turn ignition switch ON.
4. Check voltage between door mirror (passenger side) harness connector and ground.

(+)		(-)	Condition	Voltage (V) (Approx.)
Door mirror (passenger side) Connector	Terminal			
D43	1	Ground	Rear window defogger switch	ON
			OFF	Battery voltage
				0

Is the inspection result normal?

- YES >> GO TO 2.
NO >> GO TO 4.

2.CHECK DOOR MIRROR DEFOGGER GROUND CIRCUIT

1. Turn ignition switch OFF.
2. Check continuity between door mirror (passenger side) harness connector and ground.

Door mirror (passenger side)		Ground	Continuity
Connector	Terminal		
D43	5		Existed

Is the inspection result normal?

- YES >> GO TO 3.
NO >> Repair or replace harness.

3.CHECK PASSENGER SIDE DOOR MIRROR DEFOGGER

Check passenger side door mirror defogger.
Refer to [DEF-24, "PASSENGER SIDE : Component Inspection"](#).

Is the inspection result normal?

- YES >> GO TO 5.
NO >> Replace door mirror glass (passenger side). Refer to [MIR-20, "GLASS MIRROR : Disassembly and Assembly"](#).

4.CHECK DOOR MIRROR CIRCUIT

1. Turn ignition switch OFF.
2. Disconnect door mirror defogger connector and door mirror (passenger side) connector.
3. Check continuity between door mirror (passenger side) harness connector and door mirror defogger relay harness connector.

Door mirror (passenger side)		Door mirror defogger relay		Continuity
Connector	Terminal	Connector	Terminal	
D43	1	M10	2	Existed

4. Check continuity between door mirror (passenger side) harness connector and ground.

Door mirror (passenger side)		Ground	Continuity
Connector	Terminal		
D43	1		Not existed

Is the inspection result normal?

- YES >> GO TO 5.
NO >> Repair or replace harness.

5.CHECK INTERMITTENT

Refer to [GI-41, "Intermittent Incident"](#)

>> INSPECTION END

DOOR MIRROR DEFOGGER

< COMPONENT DIAGNOSIS >

PASSENGER SIDE : Component Inspection

INFOID:000000004231734

1. CHECK PASSENGER SIDE DOOR MIRROR DEFOGGER

1. Turn ignition switch OFF.
2. Disconnect door mirror (passenger side) connector.
3. Check continuity between door mirror terminals connector.

Door mirror (passenger side)		Continuity
Connector	Terminal	
D43	1 5	Existed

Is the inspection result normal?

YES >> INSPECTION END

NO >> Replace door mirror glass (passenger side). Refer to [MIR-20, "GLASS MIRROR : Disassembly and Assembly"](#).

REAR WINDOW DEFOGGER ON SIGNAL

< COMPONENT DIAGNOSIS >

REAR WINDOW DEFOGGER ON SIGNAL

Description

INFOID:000000004231735

Turns the indicator lamp in the rear window defogger switch ON when operating the rear window defogger.

Component Function Check

INFOID:000000004231736

1.CHECK REAR WINDOW DEFOGGER ON SIGNAL

Check that the indicator lamps of rear window defogger switch are illuminated when turning the rear window defogger switch ON.

Is the inspection result normal?

- OK >> Rear window defogger ON signal is OK.
- NG >> Refer to [DEF-25. "Diagnosis Procedure"](#).

Diagnosis Procedure

INFOID:000000004231737

1.CHECK FUSE

1. Turn ignition switch OFF.
2. Check the following.
 - 10A fuse [No. 5, located in fuse block (J/B)]

Is the inspection result normal?

- YES >> GO TO 2.
- NO >> Replace the blown fuse after repairing the affected circuit if a fuse is blown.

2.CHECK REAR WINDOW DEFOGGER INDICATOR LAMPS ON SIGNAL

1. Turn ignition switch ON.
2. Check voltage between A/C amp. connector ground.

(+)		(-)	Condition		Voltage (V) (Approx.)
Connector	Terminal				
M50	20	Ground	Rear window defogger switch	ON	Battery voltage
				OFF	0

Is the inspection result normal?

- YES >> Replace A/C amp. Refer to [HAC-88. "Removal and Installation"](#).
- NO >> GO TO 3.

3.CHECK REAR WINDOW DEFOGGER INDICATOR LAMPS CIRCUIT

1. Turn ignition switch OFF.
2. Disconnect IPDM E/R connector and A/C amp. connector.
3. Check continuity between IPDM E/R harness connector and a/c amp. harness connector.

IPDM E/R		A/C amp.		Continuity
Connector	Terminal	Connector	Terminal	
E11	12	M50	20	Existed

4. Check continuity between IPDM E/R connector and ground.

IPDM E/R		Ground	Continuity
Connector	Terminal		
E11	12		Not existed

Is the inspection result normal?

- YES >> GO TO 4.
- NO >> Repair or replace harness.

4.CHECK INTERMITTENT INCIDENT

A
B
C
D
E
F
G
H
I
J
K
DEF
M
N
O
P

REAR WINDOW DEFOGGER ON SIGNAL

< COMPONENT DIAGNOSIS >

Refer to [GI-41, "Intermittent Incident"](#).

>> INSPECTION END

REAR WINDOW DEFOGGER SYSTEM

< COMPONENT DIAGNOSIS >

REAR WINDOW DEFOGGER SYSTEM

Wiring Diagram - REAR WINDOW DEFOGGER SYSTEM -



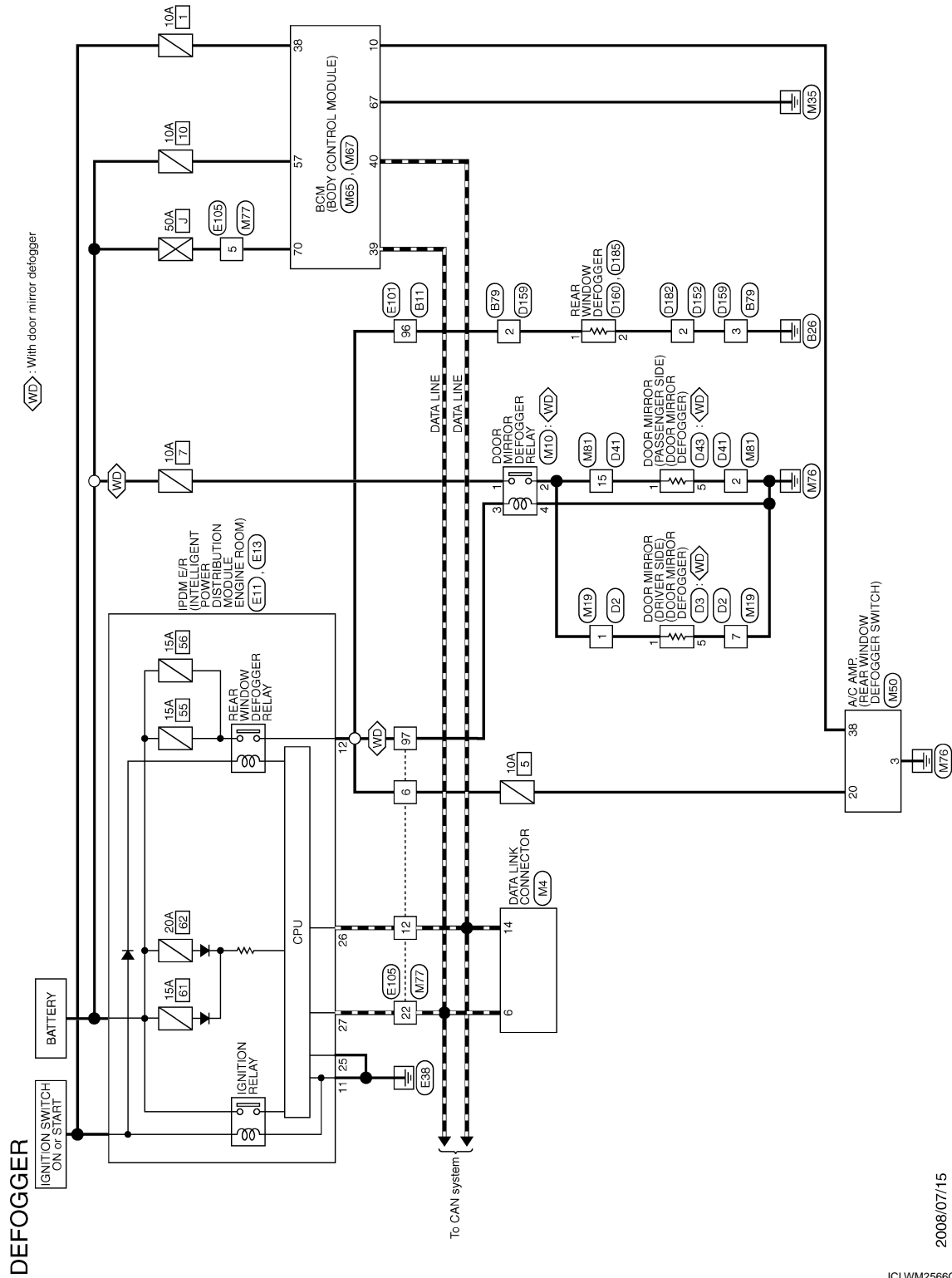



INFOID:000000004534042

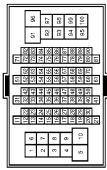

REAR WINDOW DEFOGGER SYSTEM

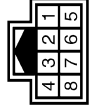
< COMPONENT DIAGNOSIS >

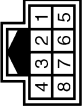
DEFOGGER



Connector No. B11	WIRE TO WIRE TH80MW-CS16F-TM4		Terminal No. 96	Color of Wire G	Signal Name [Specification]
Connector No. B79	WIRE TO WIRE M04MW-LC		Terminal No. 2	Color of Wire G	Signal Name [Specification]
Connector No. D2	WIRE TO WIRE N16FW-CS		Terminal No. 1	Color of Wire GR	Signal Name [Specification]
Connector No. D3	DOOR MIRROR (DRIVER SIDE) TH08MW-NH		Terminal No. 5	Color of Wire B	Signal Name [Specification]
Connector No. D41	WIRE TO WIRE TH16FW-NH		Terminal No. 2	Color of Wire B	Signal Name [Specification]
Connector No. D43	DOOR MIRROR (PASSENGER SIDE) TH08MW-NH		Terminal No. 1	Color of Wire GR	Signal Name [Specification]
Connector No. D152	WIRE TO WIRE M02FW-GY-LC		Terminal No. 2	Color of Wire B	Signal Name [Specification]
Connector No. D159	WIRE TO WIRE M04FW-LC		Terminal No. 2	Color of Wire G	Signal Name [Specification]

JCLWM2567GE

REAR WINDOW DEFOGGER SYSTEM

< COMPONENT DIAGNOSIS >



DEFOGGER

Connector No.	D185	REAR WINDOW DEFOGGER	P01FE-A
Connector Name	REAR WINDOW DEFOGGER		
Connector Type	P01FE-A		
			
			
Terminal No.	2	Color of Wire	B
Terminal No.	2	Signal Name [Specification]	-



Terminal No.	1	Color of Wire	G
Terminal No.	1	Signal Name [Specification]	-

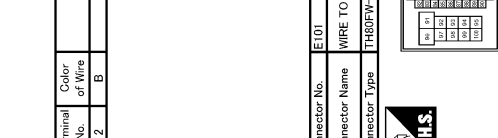

Terminal No.	1	Color of Wire	B
Terminal No.	2	Color of Wire	B
Terminal No.	2	Signal Name [Specification]	-

Terminal No.	11	Color of Wire	B
Terminal No.	12	Color of Wire	O
Terminal No.	11	Signal Name [Specification]	-
Terminal No.	12	Signal Name [Specification]	-



Connector No.	D182	WIRE TO WIRE	M02MM-GY-LC
Connector Name	WIRE TO WIRE		
Connector Type	M02MM-GY-LC		
			
			
Terminal No.	2	Color of Wire	B
Terminal No.	2	Signal Name [Specification]	-

Connector No.	E105	WIRE TO WIRE	TH80FW-GS16-TM4
Connector Name	WIRE TO WIRE		
Connector Type	TH80FW-GS16-TM4		
			
			
Terminal No.	5	Color of Wire	Y
Terminal No.	6	Color of Wire	G
Terminal No.	12	Color of Wire	P
Terminal No.	22	Color of Wire	L
Terminal No.	97	Color of Wire	G
Terminal No.	5	Signal Name [Specification]	-
Terminal No.	6	Signal Name [Specification]	-
Terminal No.	12	Signal Name [Specification]	-
Terminal No.	22	Signal Name [Specification]	-
Terminal No.	97	Signal Name [Specification]	-

Connector No.	E11	IPDM E/R (INTELLIGENT POWER DISTRIBUTION MODULE ENGINE ROOM)	M08FB-LC
Connector Name	IPDM E/R (INTELLIGENT POWER DISTRIBUTION MODULE ENGINE ROOM)		
Connector Type	M08FB-LC		
			
			
Terminal No.	11	Color of Wire	B
Terminal No.	12	Color of Wire	O
Terminal No.	11	Signal Name [Specification]	-
Terminal No.	12	Signal Name [Specification]	-

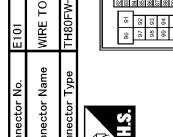
Connector No.	E13	IPDM E/R (INTELLIGENT POWER DISTRIBUTION MODULE ENGINE ROOM)	TH12FW-NH
Connector Name	IPDM E/R (INTELLIGENT POWER DISTRIBUTION MODULE ENGINE ROOM)		
Connector Type	TH12FW-NH		
			
			
Terminal No.	25	Color of Wire	B
Terminal No.	26	Color of Wire	P
Terminal No.	27	Color of Wire	L
Terminal No.	25	Signal Name [Specification]	-
Terminal No.	26	Signal Name [Specification]	-
Terminal No.	27	Signal Name [Specification]	-

Connector No.	E101	WIRE TO WIRE	TH80FW-GS16-TM4
Connector Name	WIRE TO WIRE		
Connector Type	TH80FW-GS16-TM4		
			
			
Terminal No.	96	Color of Wire	O
Terminal No.	96	Signal Name [Specification]	-

Connector No.	M4	DATA LINK CONNECTOR	BD16FW
Connector Name	DATA LINK CONNECTOR		
Connector Type	BD16FW		
			
			
Terminal No.	6	Color of Wire	L
Terminal No.	14	Color of Wire	P
Terminal No.	6	Signal Name [Specification]	-
Terminal No.	14	Signal Name [Specification]	-

A
B
C
D
E
F
G
H
I
J
K
DEF
M
N
O
P

REAR WINDOW DEFOGGER SYSTEM

< COMPONENT DIAGNOSIS >

DEFOGGER

Connector No.	M10
Connector Name	DOOR MIRROR DEFOGGER RELAY
Connector Type	MS2FL-MZ-LC

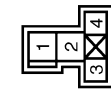

Terminal No.	Color of Wire	Signal Name [Specification]
1	P	-
2	GR	-
3	G	-
4	B	-

Connector No.	M19
Connector Name	WIRE TO WIRE
Connector Type	NS1(BMW)-CS

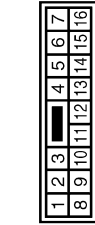

Terminal No.	Color of Wire	Signal Name [Specification]
1	GR	-
7	B	-

Connector No.	M50
Connector Name	A/C AMP.
Connector Type	SAB4QFW



Terminal No.	Color of Wire	Signal Name [Specification]
3	B	GND
20	GR	RR DEF F/S
38	SB	RR DEF SW

Connector No.	M65
Connector Name	BCM (BODY CONTROL MODULE)
Connector Type	TH40FW-NH

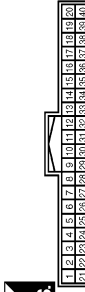

Terminal No.	Color of Wire	Signal Name [Specification]
10	SB	RR DEF SW
38	G	IGN
39	L	CAN-H
40	P	CAN-L

Connector No.	M67
Connector Name	BCM (BODY CONTROL MODULE)
Connector Type	FEA09FB-FHA6-SA



Terminal No.	Color of Wire	Signal Name [Specification]
57	G	BAT FUSE
67	B	GND
70	Y	BAT FL

Connector No.	M77
Connector Name	WIRE TO WIRE
Connector Type	TH8(BMW)-CS16-TM4

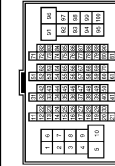

Terminal No.	Color of Wire	Signal Name [Specification]
5	Y	-
6	G	-
12	P	-
22	L	-
97	G	-

Connector No.	M81
Connector Name	WIRE TO WIRE
Connector Type	TH1(BMW)-NH

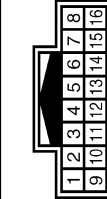

Terminal No.	Color of Wire	Signal Name [Specification]
2	B	-
15	GR	-

JCLWM2569GE

BCM (BODY CONTROL MODULE)

< ECU DIAGNOSIS >

ECU DIAGNOSIS

BCM (BODY CONTROL MODULE)

Reference Value

INFOID:000000004534030

VALUES ON THE DIAGNOSIS TOOL

Monitor Item	Condition	Value/Status
IGN ON SW	Ignition switch OFF or ACC	Off
	Ignition switch ON	On
KEY ON SW	Mechanical key is removed from key cylinder	Off
	Mechanical key is inserted to key cylinder	On
CDL LOCK SW	Door lock/unlock switch does not operate	Off
	Press door lock/unlock switch to the lock side	On
CDL UNLOCK SW	Door lock/unlock switch does not operate	Off
	Press door lock/unlock switch to the unlock side	On
DOOR SW-DR	Driver's door closed	Off
	Driver's door opened	On
DOOR SW-AS	Passenger door closed	Off
	Passenger door opened	On
DOOR SW-RR	Rear RH door closed	Off
	Rear RH door opened	On
DOOR SW-RL	Rear LH door closed	Off
	Rear LH door opened	On
BACK DOOR SW	Back door closed	Off
	Back door opened	On
KEY CYL LK-SW	Other than driver door key cylinder LOCK position	Off
	Driver door key cylinder LOCK position	On
KEY CYL UN-SW	Other than driver door key cylinder UNLOCK position	Off
	Driver door key cylinder UNLOCK position	On
KEYLESS LOCK	"LOCK" button of key fob is not pressed	Off
	"LOCK" button of key fob is pressed	On
KEYLESS UNLOCK	"UNLOCK" button of key fob is not pressed	Off
	"UNLOCK" button of key fob is pressed	On
I-KEY LOCK	"LOCK" button of Intelligent Key or door request switch are not pressed	Off
	"LOCK" button of Intelligent Key or door request switch are pressed	On
I-KEY UNLOCK	"UNLOCK" button of Intelligent Key or door request switch are not pressed	Off
	"UNLOCK" button of Intelligent Key or door request switch are pressed	On
ACC ON SW	Ignition switch OFF	Off
	Ignition switch ACC or ON	On
REAR DEF SW	Rear window defogger switch OFF	Off
	Rear window defogger switch ON	On
LIGHT SW 1ST	Lighting switch OFF	Off
	Lighting switch 1ST	On

A

B

C

D

E

F

G

H

I

J

K

DEF

M

N

O

P

BCM (BODY CONTROL MODULE)

< ECU DIAGNOSIS >

Monitor Item	Condition	Value/Status
BUCKLE SW	The seat belt (driver side) is unfastened. [Seat belt switch (driver side) OFF]	Off
	The seat belt (driver side) is fastened. [Seat belt switch (driver side) ON]	On
KEYLESS PANIC	PANIC button of key fob is not pressed	Off
	PANIC button of key fob is pressed	On
KEYLESS TRUNK	NOTE: The item is indicated, but not monitored.	Off
TRNK OPN MNTR	NOTE: The item is indicated, but not monitored.	Off
RKE LCK-UNLCK	LOCK/UNLOCK button of key fob is not pressed and held simultaneously	Off
	LOCK/UNLOCK button of key fob is pressed and held simultaneously	On
RKE KEEP UNLK	UNLOCK button of key fob is not pressed	Off
	UNLOCK button of key fob is pressed and held	On
HI BEAM SW	Lighting switch OFF	Off
	Lighting switch HI	On
HEAD LAMP SW 1	Lighting switch OFF	Off
	Lighting switch 2ND	On
HEAD LAMP SW 2	Lighting switch OFF	Off
	Lighting switch 2ND	On
AUTO LIGHT SW	NOTE: The item is indicated, but not monitored.	Off
PASSING SW	Other than lighting switch PASS	Off
	Lighting switch PASS	On
FR FOG SW	Front fog lamp switch OFF	Off
	Front fog lamp switch ON	On
RR FOG SW	NOTE: The item is indicated, but not monitored.	Off
TURN SIGNAL R	Turn signal switch OFF	Off
	Turn signal switch RH	On
TURN SIGNAL L	Turn signal switch OFF	Off
	Turn signal switch LH	On
ENGINE RUN	Engine stopped	Off
	Engine running	On
PKB SW	Parking brake switch is OFF	Off
	Parking brake switch is ON	On
CARGO LAMP SW	NOTE: The item is indicated, but not monitored.	Off
OPTICAL SENSOR	NOTE: The item is indicated, but not monitored.	0 V
IGN SW CAN	Ignition switch OFF or ACC	Off
	Ignition switch ON	On
FR WIPER HI	Front wiper switch OFF	Off
	Front wiper switch HI	On
FR WIPER LOW	Front wiper switch OFF	Off
	Front wiper switch LO	On

BCM (BODY CONTROL MODULE)

< ECU DIAGNOSIS >

Monitor Item	Condition	Value/Status	
FR WIPER INT	Front wiper switch OFF	Off	A
	Front wiper switch INT	On	
FR WASHER SW	Front washer switch OFF	Off	B
	Front washer switch ON	On	
INT VOLUME	Wiper intermittent dial is in a dial position 1 - 7	1 - 7	
FR WIPER STOP	Any position other than front wiper stop position	Off	C
	Front wiper stop position	On	
VEHICLE SPEED	While driving	Equivalent to speedometer reading	D
RR WIPER ON	Rear wiper switch OFF	Off	
	Rear wiper switch ON	On	
RR WIPER INT	Rear wiper switch OFF	Off	E
	Rear wiper switch INT	On	
RR WASHER SW	Rear washer switch OFF	Off	F
	Rear washer switch ON	On	
RR WIPER STOP	Rear wiper stop position	Off	
	Other than rear wiper stop position	On	G
RR WIPER STP2	NOTE: The item is indicated, but not monitored.	Off	
H/L WASH SW	NOTE: The item is indicated, but not monitored.	Off	H
HAZARD SW	Hazard switch OFF	Off	
	Hazard switch ON	On	I
BRAKE SW	Brake pedal is not depressed	Off	
	Brake pedal is depressed	On	J
FAN ON SIG	Blower fan motor switch OFF	Off	
	Blower fan motor switch ON (other than OFF)	On	
AIR COND SW	Compressor ON is not requested from auto amp. (A/C indicator OFF, blower fan motor switch OFF or etc.)	Off	K
	Compressor ON is requested from auto amp. (A/C indicator ON and blower fan motor switch ON).	On	DEF
I-KEY TRUNK	NOTE: The item is indicated, but not monitored.	Off	
I-KEY PW DWN	UNLOCK button of Intelligent Key is not pressed	Off	M
	UNLOCK button of Intelligent Key is pressed and held	On	
I-KEY PANIC	PANIC button of Intelligent Key is not pressed	Off	
	PANIC button of Intelligent Key is pressed	On	N
PUSH SW	Return to ignition switch to "LOCK" position	Off	
	Press ignition switch	On	O
TRNK OPNR SW	When back door opener switch is not pressed	Off	
	When back door opener switch is pressed	On	
TRUNK CYL SW	NOTE: The item is indicated, but not monitored.	Off	P
HOOD SW	Close the hood	Off	
	NOTE: Vehicles of except for Mexico are OFF-fixed Open the hood	On	

BCM (BODY CONTROL MODULE)

< ECU DIAGNOSIS >

Monitor Item	Condition	Value/Status
OIL PRESS SW	<ul style="list-style-type: none"> • Ignition switch OFF or ACC • Engine running 	Off
	Ignition switch ON	On
AIR PRESS FL	Ignition switch ON (Only when the signal from the transmitter is received)	Air pressure of front LH tire
AIR PRESS FR	Ignition switch ON (Only when the signal from the transmitter is received)	Air pressure of front RH tire
AIR PRESS RR	Ignition switch ON (Only when the signal from the transmitter is received)	Air pressure of rear RH tire
AIR PRESS RL	Ignition switch ON (Only when the signal from the transmitter is received)	Air pressure of rear LH tire
ID REGST FL1	ID of front LH tire transmitter is registered	Done
	ID of front LH tire transmitter is not registered	Yet
ID REGST FR1	ID of front RH tire transmitter is registered	Done
	ID of front RH tire transmitter is not registered	Yet
ID REGST RR1	ID of rear RH tire transmitter is registered	Done
	ID of rear RH tire transmitter is not registered	Yet
ID REGST RL1	ID of rear LH tire transmitter is registered	Done
	ID of rear LH tire transmitter is not registered	Yet
WARNING LAMP	Tire pressure indicator OFF	Off
	Tire pressure indicator ON	On
BUZZER	Tire pressure warning alarm is not sounding	Off
	Tire pressure warning alarm is sounding	On

BCM (BODY CONTROL MODULE)

< ECU DIAGNOSIS >

TERMINAL LAYOUT

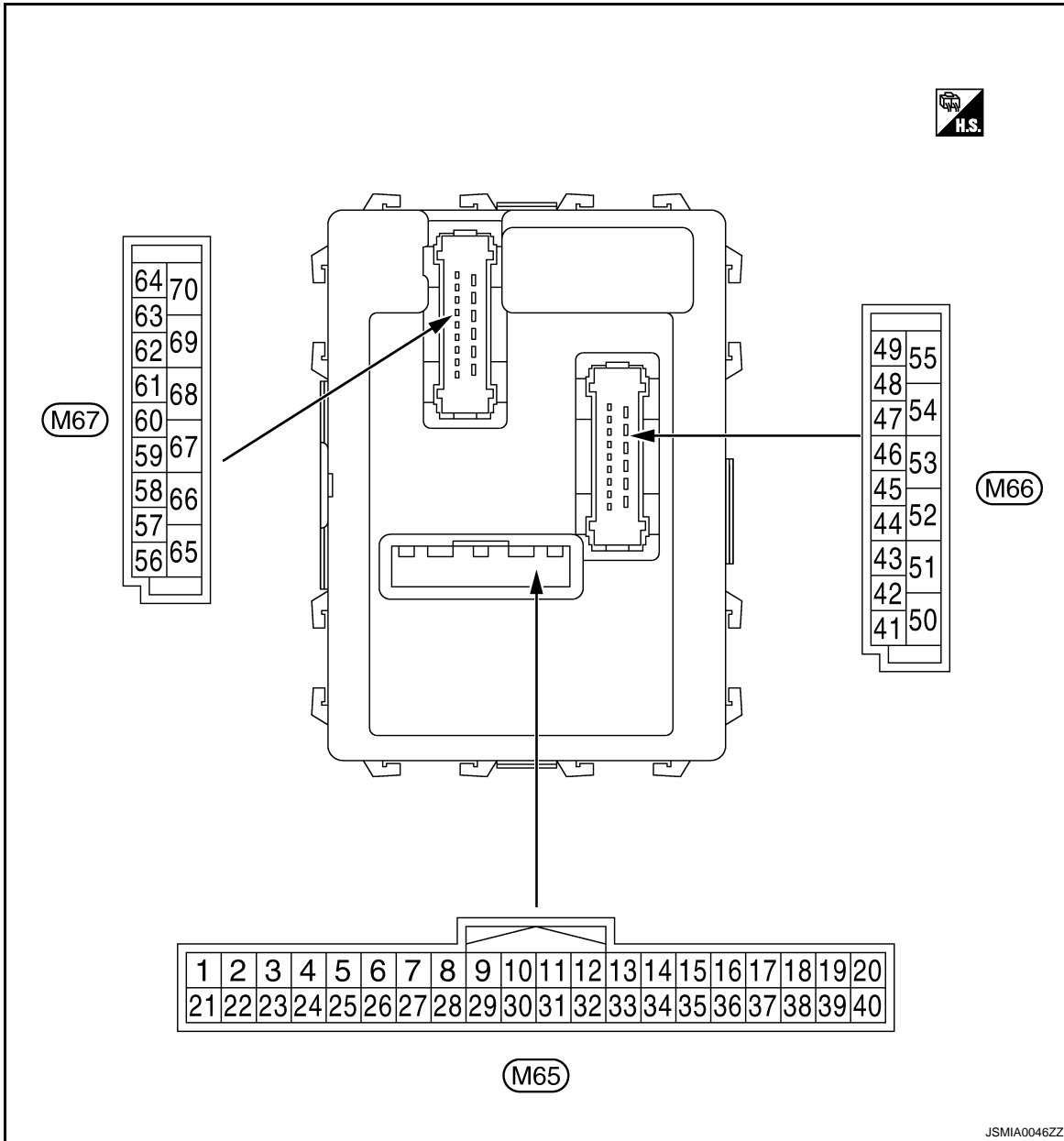

PHYSICAL VALUES

CAUTION:

- Check combination switch system terminal waveform under the loaded condition with lighting switch, turn signal switch and wiper switch OFF is not to be fluctuated by being overloaded.
- Turn wiper intermittent dial position to 4 except when checking waveform or voltage of wiper intermittent dial position. Wiper intermittent dial position can be confirmed on CONSULT-III. Refer to [BCS-27, "COMB SW : CONSULT-III Function \(BCM - COMB SW\)"](#).
- BCM reads the status of the combination switch at 10 ms internal normally. Refer to [BCS-9, "System Diagram"](#).

Terminal No. (Wire color)		Description		Condition		Value (Approx.)
+	-	Signal name	Input/ Output	Ignition key hole illumination	OFF	Battery voltage
1 (V)	Ground	Ignition key hole illumination control	Output		ON	

BCM (BODY CONTROL MODULE)

< ECU DIAGNOSIS >

Terminal No. (Wire color)		Description		Condition	Value (Approx.)	
+	-	Signal name	Input/ Output			
2 (G)	Ground	Combination switch INPUT 5	Input	Combination switch (Wiper intermit- tent dial 4)	All switch OFF	0 V
					Turn signal switch RH	
					Lighting switch HI	
					Lighting switch 1ST	
					1.0 V	
						2.0 V
3 (Y)	Ground	Combination switch INPUT 4	Input	Combination switch (Wiper intermit- tent dial 4)	All switch OFF	0 V
					Turn signal switch LH	
					Lighting switch PASS	
					Lighting switch 2ND	
					1.0 V	
						0.8 V
4 (W)	Ground	Combination switch INPUT 3	Input	Combination switch (Wiper intermit- tent dial 4)	All switch OFF	0 V
					Front wiper switch LO	
					Front wiper switch MIST	
					Front wiper switch INT	
					1.0 V	

BCM (BODY CONTROL MODULE)

< ECU DIAGNOSIS >

Terminal No. (Wire color)		Description		Condition	Value (Approx.)			
+	-	Signal name	Input/ Output					
5 (R)	Ground	Combination switch INPUT 2	Input	Combination switch	All switch OFF (Wiper intermittent dial 4)	0 V	A	
					Front washer switch (Wiper intermittent dial 4)		B	
					Rear washer ON (Wiper intermittent dial 4)		C	
					Any of the condition below with all switch OFF <ul style="list-style-type: none"> • Wiper intermittent dial 1 • Wiper intermittent dial 5 • Wiper intermittent dial 6 		1.0 V	D
					Rear wiper switch ON (Wiper intermittent dial 4)		0.8 V	E
6 (P)	Ground	Combination switch INPUT 1	Input	Combination switch	All switch OFF (Wiper intermittent dial 4)	0 V	F	
					Front wiper switch HI (Wiper intermittent dial 4)		G	
					Rear wiper switch INT (Wiper intermittent dial 4)		H	
					Wiper intermittent dial 3 (All switch OFF)		1.0 V	I
					Any of the condition below with all switch OFF <ul style="list-style-type: none"> • Wiper intermittent dial 6 • Wiper intermittent dial 7 		0.8 V	K

DEF

BCM (BODY CONTROL MODULE)

< ECU DIAGNOSIS >

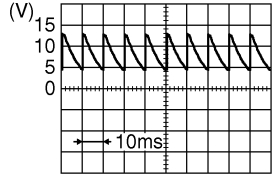
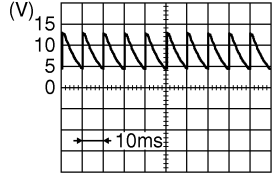
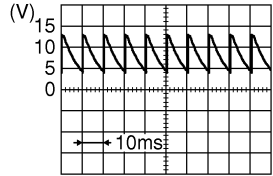
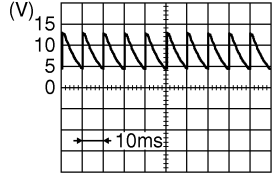
Terminal No. (Wire color)		Description		Condition	Value (Approx.)
+	-	Signal name	Input/ Output		
7 (L)	Ground	Door key cylinder switch UNLOCK signal	Input	Door key cylinder switch	NEUTRAL position  8.0 - 8.5 V <small>JPMIA0587GB</small>
				UNLOCK position	0 V
8 (R)	Ground	Door key cylinder switch LOCK signal	Input	Door key cylinder switch	NEUTRAL position  8.0 - 8.5 V <small>JPMIA0587GB</small>
				LOCK position	0 V
9 (R)	Ground	Stop lamp switch	Input	Stop lamp switch	OFF (Brake pedal is not depressed) 0 V ON (Brake pedal is de- pressed) Battery voltage
10 (SB)	Ground	Rear window defog- ger switch	Input	Rear window defogger switch	Not pressed Battery voltage Pressed 0 V
11 (SB)	Ground	Ignition switch ACC	Input	Ignition switch OFF	0 V
				Ignition switch ACC or ON	Battery voltage
12 (P)	Ground	Passenger door switch	Input	Passenger door switch	OFF (When passenger door closed)  7.5 - 8.0 V <small>JPMIA0586GB</small>
				ON (When passenger door opened)	0 V
13 (LG)	Ground	Rear door switch RH	Input	Rear door switch RH	OFF (When rear door RH closed)  8.0 - 8.5 V <small>JPMIA0587GB</small>
				ON (When rear door RH opened)	0 V

BCM (BODY CONTROL MODULE)

< ECU DIAGNOSIS >

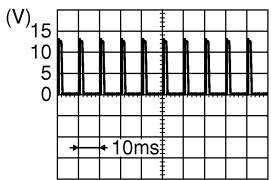
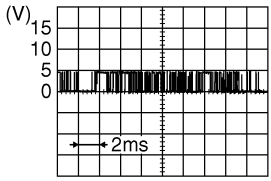
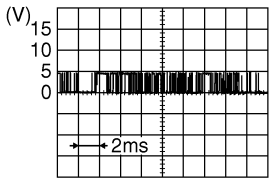
Terminal No. (Wire color)		Description		Condition		Value (Approx.)
+	-	Signal name	Input/ Output			
15* (O)	Ground	Tire pressure warning check switch	Input	Ignition switch OFF		 <p style="text-align: right; font-size: small;">JPMIA0588GB</p> <p style="text-align: center;">1.5 V</p>
18* (O)	Ground	Remote keyless entry receiver ground	Input	Ignition switch ON		0 V
19* (V)	Ground	Remote keyless entry receiver power supply	Input	Without Intelligent Key system	At any condition	5 V
				With Intelligent Key system	<ul style="list-style-type: none"> Ignition switch OFF For 3 seconds after ignition switch OFF to ON 	0 V
					3 seconds or later after ignition switch OFF to ON	5 V
20* (GR)	Ground	Remote keyless entry receiver signal	Input	Without Intelligent Key system	At any condition	 <p style="text-align: right; font-size: small;">JPMIA0589GB</p> <p>NOTE: The wave form changes according to signal-receiving condition.</p>
				With Intelligent Key system	<ul style="list-style-type: none"> Ignition switch OFF For 3 seconds after ignition switch OFF to ON 	0 V
					3 seconds or later after ignition switch OFF to ON	 <p style="text-align: right; font-size: small;">JPMIA0589GB</p> <p>NOTE: The wave form changes according to signal-receiving condition.</p>
21 (G)	Ground	Immobilizer antenna signal (Clock)	Input/ Output	Ignition switch OFF		Battery voltage

A
B
C
D
E
F
G
H
I
J
K
DEF
M
N
O
P

BCM (BODY CONTROL MODULE)

< ECU DIAGNOSIS >

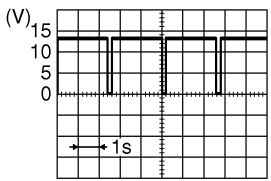
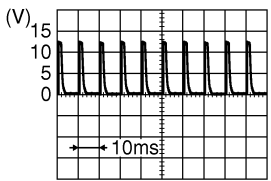
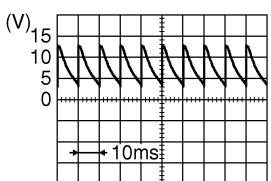
Terminal No. (Wire color)		Description		Condition		Value (Approx.)
+	-	Signal name	Input/ Output			
23 (B)	Ground	Security indicator signal	Input	Security indica- tor	ON	0 V
					Blinking (Ignition switch OFF)	 12.0 V
					OFF	Battery voltage
25 (BR)	Ground	Immobilizer anten- na signal (Rx, Tx)	Input/ Output	Ignition switch OFF		Battery voltage
27 (Y)	Ground	A/C switch	Input	Ignition switch ON	A/C switch OFF	 1.6 V
					A/C switch ON	0 V
28 (LG)	Ground	Blower fan switch	Input	Ignition switch ON	Blower fan switch OFF	 7.0 - 7.5 V
					Blower fan switch ON	0 V
29 (W)	Ground	Hazard switch	Input	Hazard switch	OFF	Battery voltage
					ON	0 V
30 (G)	Ground	Back door opener switch	Input	Back door opener switch	Not pressed	Battery voltage
					Pressed	0 V

BCM (BODY CONTROL MODULE)

< ECU DIAGNOSIS >

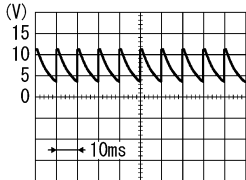
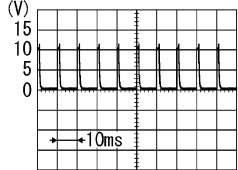
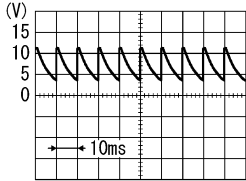
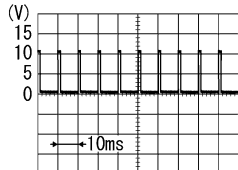
Terminal No. (Wire color)		Description		Condition	Value (Approx.)	
		Signal name	Input/ Output			
+	-					
32 (BR)	Ground	Combination switch OUTPUT 5	Output	Combination switch	All switch OFF (Wiper intermittent dial 4)	 <p style="text-align: right; font-size: small;">PKIB4960J</p>
					7.2 V	
					Front fog lamp switch ON (Wiper intermittent dial 4)	 <p style="text-align: right; font-size: small;">PKIB4956J</p>
					Rear wiper switch ON (Wiper intermittent dial 4)	
Any of the condition below with all switch OFF	<ul style="list-style-type: none"> • Wiper intermittent dial 1 • Wiper intermittent dial 2 • Wiper intermittent dial 6 • Wiper intermittent dial 7 					
1.0 V						
33 (GR)	Ground	Combination switch OUTPUT 4	Output	Combination switch	All switch OFF (Wiper intermittent dial 4)	 <p style="text-align: right; font-size: small;">PKIB4960J</p>
					7.2 V	
					Lighting switch 1ST (Wiper intermittent dial 4)	 <p style="text-align: right; font-size: small;">PKIB4958J</p>
					Rear wiper switch INT (Wiper intermittent dial 4)	
Any of the condition below with all switch OFF	<ul style="list-style-type: none"> • Wiper intermittent dial 1 • Wiper intermittent dial 5 • Wiper intermittent dial 6 					
1.2 V						

A
B
C
D
E
F
G
H
I
J
K
DEF
M
N
O
P



BCM (BODY CONTROL MODULE)

< ECU DIAGNOSIS >

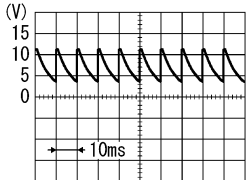
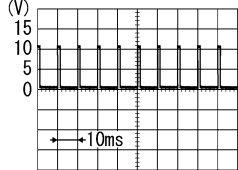
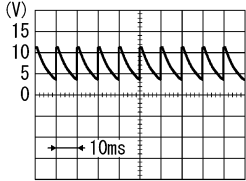
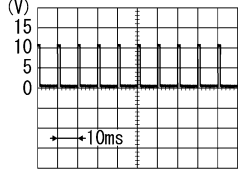
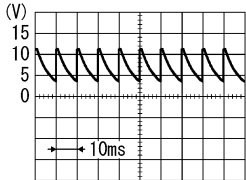
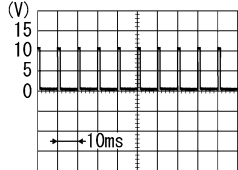
Terminal No. (Wire color)		Description		Condition	Value (Approx.)	
+	-	Signal name	Input/ Output			
34 (L)	Ground	Combination switch OUTPUT 3	Output	Combination switch	All switch OFF (Wiper intermittent dial 4)	 <p style="text-align: right; font-size: small;">PKIB4960J</p> <p style="text-align: center;">7.2 V</p>
					Lighting switch 2ND (Wiper intermittent dial 4)	 <p style="text-align: right; font-size: small;">PKIB4958J</p> <p style="text-align: center;">1.2 V</p>
					Lighting switch HI (Wiper intermittent dial 4)	
					Rear washer switch ON (Wiper intermittent dial 4)	
Any of the condition below with all switch OFF <ul style="list-style-type: none"> • Wiper intermittent dial 1 • Wiper intermittent dial 2 • Wiper intermittent dial 3 						
35 (B)	Ground	Combination switch OUTPUT 2	Output	Combination switch (Wiper intermit- tent dial 4)	All switch OFF	 <p style="text-align: right; font-size: small;">PKIB4960J</p> <p style="text-align: center;">7.2 V</p>
					Lighting switch 2ND	 <p style="text-align: right; font-size: small;">PKIB4958J</p> <p style="text-align: center;">1.2 V</p>
					Lighting switch PASS	
					Front wiper switch INT	
Front wiper switch HI						
36 (V)	Ground	Combination switch OUTPUT 1	Output	Combination switch (Wiper intermit- tent dial 4)	All switch OFF	 <p style="text-align: right; font-size: small;">PKIB4960J</p> <p style="text-align: center;">7.2 V</p>
					Turn signal switch RH	 <p style="text-align: right; font-size: small;">PKIB4958J</p> <p style="text-align: center;">1.2 V</p>
					Turn signal switch LH	
					Front wiper switch LO (Front wiper switch MIST)	
Front washer switch ON						

BCM (BODY CONTROL MODULE)

< ECU DIAGNOSIS >

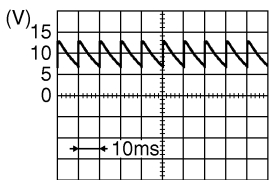
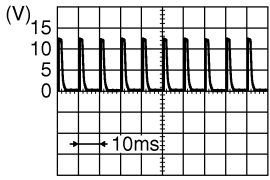
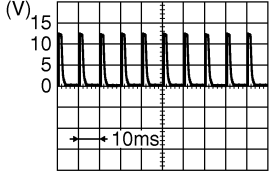
Terminal No. (Wire color)		Description		Condition	Value (Approx.)	
		Signal name	Input/ Output			
+	-					
37 (LG)	Ground	Key switch	Input	Insert mechanical key into ignition key cylinder	Battery voltage	A
				Remove mechanical key from ignition key cylinder	0 V	B
38 (G)	Ground	Ignition switch ON	Input	Ignition switch OFF or ACC	0 V	C
				Ignition switch ON or START	Battery voltage	
39 (L)	Ground	CAN-H	Input/ Output	—	—	D
40 (P)	Ground	CAN-L	Input/ Output	—	—	E
43 (V)	Ground	Back door switch	Input	Back door switch		
				OFF (When back door closed)	 <p style="text-align: right; font-size: small;">JPMIA0593GB</p>	F
				ON (When back door opened)	0 V	G
44 (B)	Ground	Rear wiper auto stop	Input	Ignition switch ON		
				Rear wiper stop position	0 V	H
				Any position other than rear wiper stop position	Battery voltage	I
45 (P)	Ground	Door lock and unlock switch LOCK signal	Input	Door lock and unlock switch		
				NEUTRAL position	 <p style="text-align: right; font-size: small;">JPMIA0591GB</p>	J
				LOCK position	0 V	K
46 (BR)	Ground	Door lock and unlock switch UNLOCK signal	Input	Door lock and unlock switch		
				NEUTRAL position	 <p style="text-align: right; font-size: small;">JPMIA0591GB</p>	M
				UNLOCK position	0 V	N
					1.6 V	O
					0 V	P

DEF

BCM (BODY CONTROL MODULE)

< ECU DIAGNOSIS >

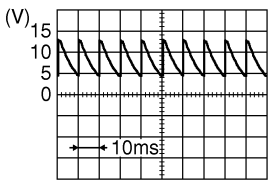
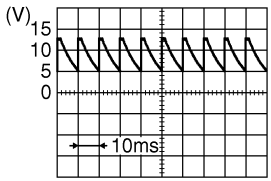
Terminal No. (Wire color)		Description		Condition		Value (Approx.)
+	-	Signal name	Input/ Output			
47 (W)	Ground	Driver door switch	Input	Driver door switch	OFF (When driver door closed)	 <p style="text-align: right; font-size: small;">JPMIA0587GB</p> <p style="text-align: center;">8.0 - 8.5 V</p>
					ON (When driver door opened)	0 V
48 (GR)	Ground	Rear door switch LH	Input	Rear door switch LH	OFF (When rear door LH closed)	 <p style="text-align: right; font-size: small;">JPMIA0594GB</p> <p style="text-align: center;">8.5 - 9.0 V</p>
					ON (When rear door LH opened)	0 V
49 (L)	Ground	Back door lamp control	Output	Back door lamp switch DOOR position	Back door is closed (Back door lamp turns OFF)	Battery voltage
					Back door is opened (Back door lamp turns ON)	0 V
53 (V)	Ground	Back door open	Output	Back door opener switch	Not pressed (Back door actuator is activated)	0 V
					Pressed (Back door actuator is activated)	Battery voltage
55 (SB)	Ground	Rear wiper motor	Output	Ignition switch ON	Rear wiper switch OFF	0 V
					Rear wiper switch ON	Battery voltage
56 (Y)	Ground	Interior room lamp power supply	Output		After passing the interior room lamp battery saver operation time	0 V
					Any other time after passing the interior room lamp battery saver operation time	Battery voltage
57 (G)	Ground	Battery power supply	Input	Ignition switch OFF	Battery voltage	
59 (L)	Ground	Driver door UN-LOCK	Output	Driver door	UNLOCK (Actuator is activated)	Battery voltage
					Other than UNLOCK (Actuator is not activated)	0 V

BCM (BODY CONTROL MODULE)

< ECU DIAGNOSIS >

Terminal No. (Wire color)		Description		Condition	Value (Approx.)	
+	-	Signal name	Input/ Output			
60 (BR)	Ground	Turn signal LH	Output	Ignition switch OFF	0 V	
				Ignition switch ON	Turn signal switch LH	 6.0 V
61 (GR)	Ground	Turn signal RH	Output	Ignition switch OFF	0 V	
				Ignition switch ON	Turn signal switch RH	 6.0 V
63 (R)	Ground	Interior room lamp timer control	Output	Interior room lamp	OFF	Battery voltage
				ON	0 V	
65 (V)	Ground	All doors LOCK	Output	All doors	LOCK (Actuator is activated)	Battery voltage
				Other then LOCK (Actuator is not activated)	0 V	
66 (G)	Ground	Passenger door and rear door UNLOCK	Output	Passenger door and rear door	UNLOCK (Actuator is activated)	Battery voltage
					Other then UNLOCK (Actuator is not activated)	0 V
67 (B)	Ground	Ground	Output	Ignition switch ON	0 V	
68 (L)	Ground	P/W power supply (RAP)	Output	Ignition switch ON	Battery voltage	
69 (P)	Ground	P/W power supply (BAT)	Output	Ignition switch OFF	Battery voltage	
70 (Y)	Ground	Battery power supply	Input	Ignition switch OFF	Battery voltage	

*: Except for Mexico

A
B
C
D
E
F
G
H
I
J
K
DEF
M
N
O
P

BCM (BODY CONTROL MODULE)

< ECU DIAGNOSIS >

Wiring Diagram - BCM -

INFOID:000000004534031

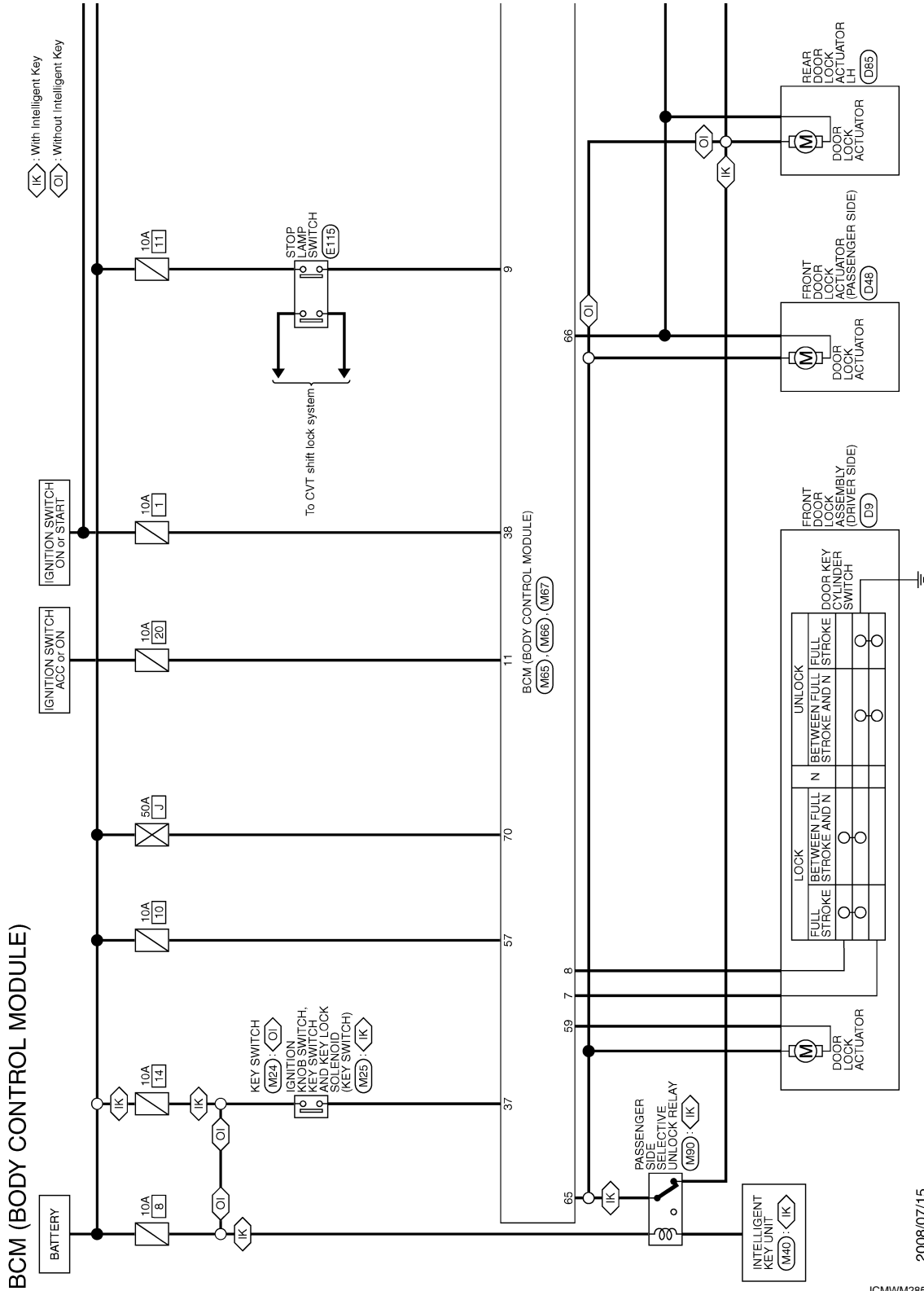

2008/07/15

JCMWM2850G

BCM (BODY CONTROL MODULE)

< ECU DIAGNOSIS >

IK : With Intelligent Key
OI : Without Intelligent Key

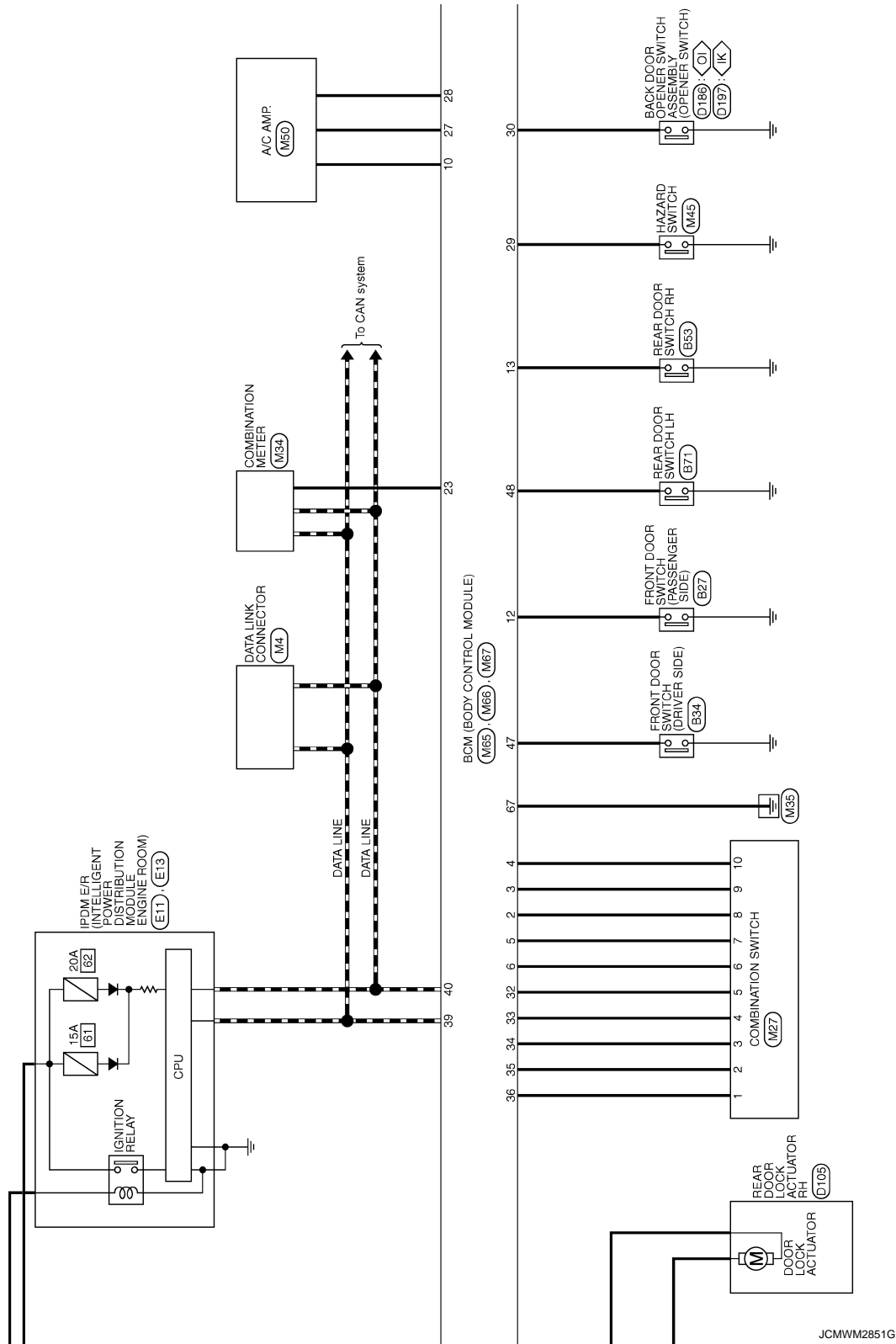

A
B
C
D
E
F
G
H
I
J
K
DEF
M
N
O
P

JCMWM2851G1

BCM (BODY CONTROL MODULE)

< ECU DIAGNOSIS >

- <XM> : Except for Mexico
- <SR> : With sunroof
- <PS> : With power seat
- <AN> : With anti-pinch system
- <VM> : With vanity mirror lamp

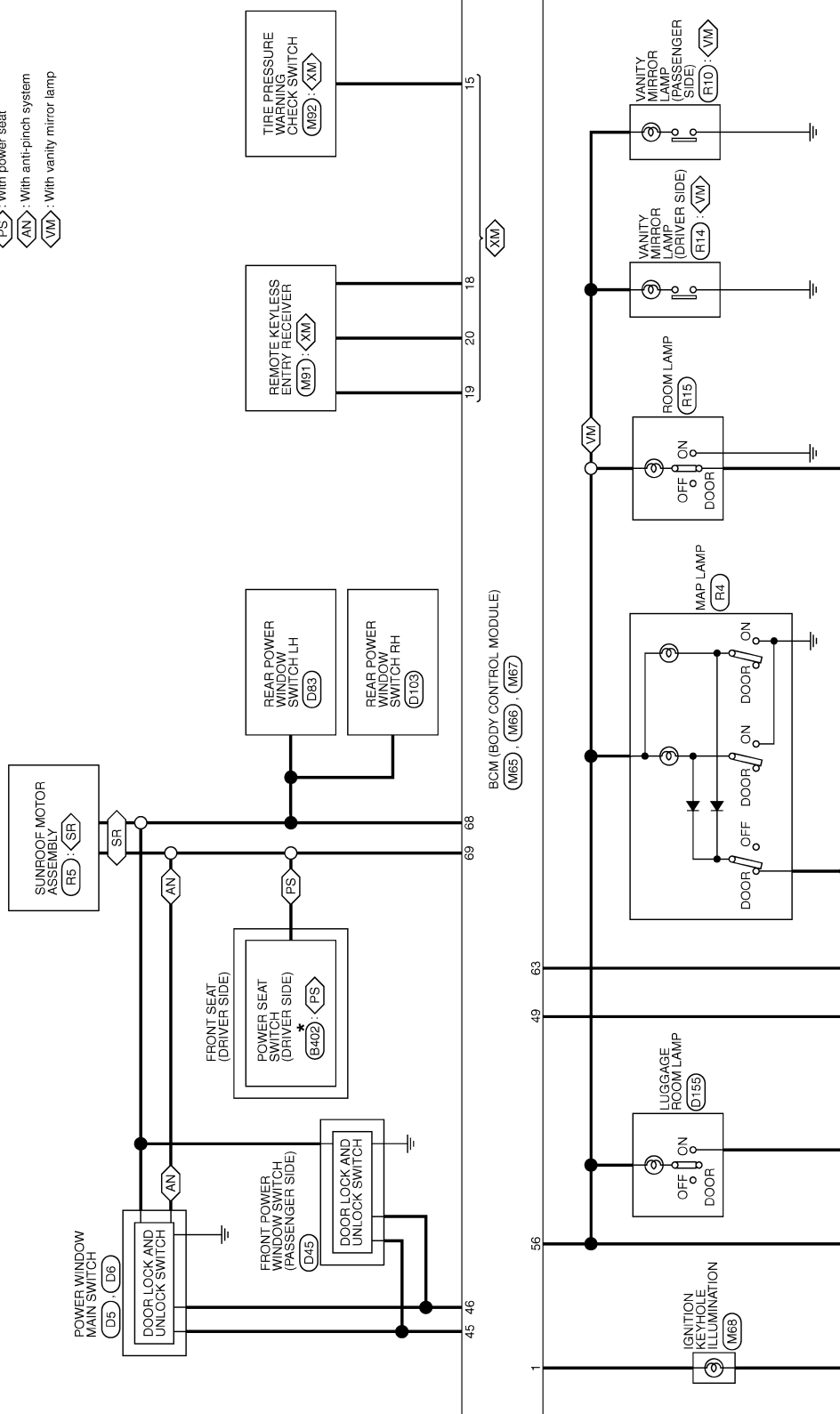

*: This connector is not shown in "Harness Layout".

JCMWM2852G

BCM (BODY CONTROL MODULE)

< ECU DIAGNOSIS >

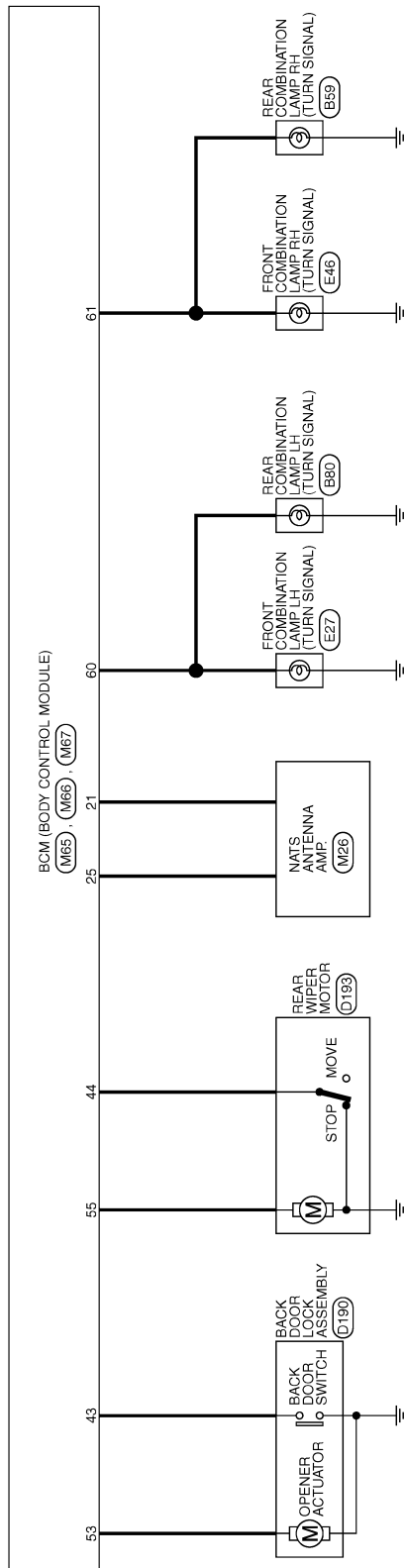

JCMWM2853GI

- A
- B
- C
- D
- E
- F
- G
- H
- I
- J
- K
- DEF**
- M
- N
- O
- P

BCM (BODY CONTROL MODULE)

< ECU DIAGNOSIS >

BCM (BODY CONTROL MODULE)

Connector No.	M27
Connector Name	COMBINATION SWITCH
Connector Type	TK16FW



12	13	14	15	16	17	18	19	20	21	22	23	24	25	26	27	28	29	30	31	32	33	34	35	36	37	38	39	40	41	42	43	44	45	46	47	48	49	50	51	52	53	54	55
----	----	----	----	----	----	----	----	----	----	----	----	----	----	----	----	----	----	----	----	----	----	----	----	----	----	----	----	----	----	----	----	----	----	----	----	----	----	----	----	----	----	----	----

Terminal No.	Color of Wire	Signal Name [Specification]
1	V	INPUT 1
2	B	INPUT 2
3	L	INPUT 3
4	GR	INPUT 4
5	BR	INPUT 5
6	P	OUTPUT 1
7	R	OUTPUT 2
8	G	OUTPUT 5
9	Y	OUTPUT 4
10	W	OUTPUT 3

Connector No.	M67
Connector Name	BCM (BODY CONTROL MODULE)
Connector Type	FEA09FB-FHA6-SA



56	57	58	59	60	61	62	63	64	65	66	67	68	69	70
----	----	----	----	----	----	----	----	----	----	----	----	----	----	----

Terminal No.	Color of Wire	Signal Name [Specification]
56	Y	BATTERYSAVEROUTPUT
57	G	BAT FUSE
58	L	D/L UNLOCK DR
59	BR	FLASHER OUT PUT (LEFT)
60	GR	FLASHER OUT PUT (RIGHT)
61	GR	ROOMLAMPOUTPUT
62	V	D/L LOCK ALL
63	G	D/L UNLOCK OTHER
64	GND	GND
65	B	POWER WDM OUTPUT(GAP)
66	L	POWER WDM OUTPUT(BAT)
67	P	

Terminal No.	Color of Wire	Signal Name [Specification]
12	P	DR SW AS
13	LG	DR SW RR
14	O	TPMS MODE TRIGGER SW
15	O	KEYLESS TUNER SEQS GND
16	V	KEYLESS TUNER POWER
17	GR	KEYLESS TUNER SIGNAL
18	GR	IMMOBI ANT(CLOCK)
19	G	SECURITY IN0 OUT PUT
20	B	IMMOBI ANT(RX, TX)
21	BR	AIRCORN SW
22	Y	BLOWER FAN SW
23	LG	HAZARD SW
24	W	BACK DOOR OPEN SW
25	G	OUTPUT 5
26	BR	OUTPUT 4
27	GR	OUTPUT 3
28	L	OUTPUT 2
29	B	OUTPUT 1
30	V	KEY SW
31	GR	IGN
32	LG	CAN-H
33	G	CAN-L

Connector No.	M66
Connector Name	BCM (BODY CONTROL MODULE)
Connector Type	FEA09FW-FHA6-SA



41	42	43	44	45	46	47	48	49	50	51	52	53	54	55
----	----	----	----	----	----	----	----	----	----	----	----	----	----	----

Terminal No.	Color of Wire	Signal Name [Specification]
43	V	BACK DOOR SW
44	B	RR WIP AUTO STOP
45	P	CDL LOCK SW
46	BR	CDL UNLOCK SW
47	W	DR SW DR
48	GR	DR SW RL
49	L	LUGGAGE LAMP OUTPUT
50	V	BACKDOORPEPPEROUTPUT
51	SB	RR WIP WTR OUT

Fail-safe

REAR WIPER MOTOR PROTECTION

BCM detects the rear wiper stopping position according to the rear wiper stop position signal. When the rear wiper stop position signal does not change more than 5 seconds while driving the rear wiper, BCM stops power supply to protect the rear wiper motor.

Condition of cancellation

BCM (BODY CONTROL MODULE)

< ECU DIAGNOSIS >

1. Pass more than 1 minute after the rear wiper stop.
2. Turn the rear wiper switch OFF.
3. Operate the rear wiper switch or rear washer switch.

HIGH FLASHER OPERATION

BCM detects the turn signal lamp circuit status by the current value.

BCM increases the turn signal lamp blinking speed if the bulb or harness open is detected with the turn signal lamp operating.

NOTE:

The blinking speed is normal while activating the hazard warning lamp.

DTC Inspection Priority Chart

INFOID:000000004534033

If some DTCs are displayed at the same time, perform inspections one by one based on the following priority chart.

Priority	DTC
1	U1000: CAN COMM CIRCUIT
2	C1735: IGN CIRCUIT OPEN
3	<ul style="list-style-type: none"> • C1704: LOW PRESSURE FL • C1705: LOW PRESSURE FR • C1706: LOW PRESSURE RR • C1707: LOW PRESSURE RL • C1708: [NO DATA] FL • C1709: [NO DATA] FR • C1710: [NO DATA] RR • C1711: [NO DATA] RL • C1712: [CHECKSUM ERR] FL • C1713: [CHECKSUM ERR] FR • C1714: [CHECKSUM ERR] RR • C1715: [CHECKSUM ERR] RL • C1716: [PRESS DATA ERR] FL • C1717: [PRESS DATA ERR] FR • C1718: [PRESS DATA ERR] RR • C1719: [PRESS DATA ERR] RL • C1720: [CODE ERR] FL • C1721: [CODE ERR] FR • C1722: [CODE ERR] RR • C1723: [CODE ERR] RL • C1724: [BATT VOLT LOW] FL • C1725: [BATT VOLT LOW] FR • C1726: [BATT VOLT LOW] RR • C1727: [BATT VOLT LOW] RL • C1729: VHCL SPEED SIG ERR

DTC Index

INFOID:000000004534034

NOTE:

- Details of time display
- CRNT: Displays when there is a malfunction now or after returning to the normal condition until turning ignition switch OFF → ON again.
- 1 - 39: Displayed if any previous malfunction is present when current condition is normal. It increases like 1 → 2 → 3...38 → 39 after returning to the normal condition whenever ignition switch OFF → ON. The counter remains at 39 even if the number of cycles exceeds it. It is counted from 1 again when turning ignition switch OFF → ON after returning to the normal condition if the malfunction is detected again.

CONSULT display	Tire pressure monitor warning lamp ON	Reference
U1000: CAN COMM CIRCUIT	—	BCS-35

BCM (BODY CONTROL MODULE)

< ECU DIAGNOSIS >

CONSULT display	Tire pressure monitor warning lamp ON	Reference
C1704: LOW PRESSURE FL	×	WT-15
C1705: LOW PRESSURE FR	×	
C1706: LOW PRESSURE RR	×	
C1707: LOW PRESSURE RL	×	
C1708: [NO DATA] FL	×	WT-17
C1709: [NO DATA] FR	×	
C1710: [NO DATA] RR	×	
C1711: [NO DATA] RL	×	
C1712: [CHECKSUM ERR] FL	×	WT-20
C1713: [CHECKSUM ERR] FR	×	
C1714: [CHECKSUM ERR] RR	×	
C1715: [CHECKSUM ERR] RL	×	
C1716: [PRESS DATA ERR] FL	×	WT-23
C1717: [PRESS DATA ERR] FR	×	
C1718: [PRESS DATA ERR] RR	×	
C1719: [PRESS DATA ERR] RL	×	
C1720: [CODE ERR] FL	×	WT-25
C1721: [CODE ERR] FR	×	
C1722: [CODE ERR] RR	×	
C1723: [CODE ERR] RL	×	
C1724: [BATT VOLT LOW] FL	—	WT-28
C1725: [BATT VOLT LOW] FR	—	
C1726: [BATT VOLT LOW] RR	—	
C1727: [BATT VOLT LOW] RL	—	
C1729: VHCL SPEED SIG ERR	×	WT-31
C1735: IGN CIRCUIT OPEN	—	BCS-36

IPDM E/R (INTELLIGENT POWER DISTRIBUTION MODULE ENGINE ROOM)

< ECU DIAGNOSIS >

IPDM E/R (INTELLIGENT POWER DISTRIBUTION MODULE ENGINE ROOM)

Reference Value

INFOID:000000004534035

VALUES ON THE DIAGNOSIS TOOL

Monitor Item	Condition		Value/Status
MOTOR FAN REQ	Engine idle speed	Changes depending on engine coolant temperature, air conditioner operation status, vehicle speed, etc.	1 - 4
AC COMP REQ	Engine running	A/C switch OFF	Off
		A/C switch ON (Compressor is operating)	On
TAIL&CLR REQ	Lighting switch OFF		Off
	Lighting switch 1ST or 2ND		On
HL LO REQ	Lighting switch OFF		Off
	Lighting switch 2ND		On
HL HI REQ	Lighting switch OFF		Off
	Lighting switch HI (Light is illuminated)		On
FR FOG REQ NOTE: This item is monitored only on the vehicle with front fog lamp.	Lighting switch 2ND	Front fog lamp switch OFF	Off
		Front fog lamp switch ON	On
FR WIP REQ	Ignition switch ON	Front wiper switch OFF	Stop
		Front wiper switch INT	1LOW
		Front wiper switch LO	Low
		Front wiper switch HI	Hi
WIP AUTO STOP	Ignition switch ON	Front wiper stop position	STOP P
		Any position other than front wiper stop position	ACT P
WIP PROT	Ignition switch ON	Front wiper operates normally	Off
		Front wiper stops at fail-safe operation	BLOCK
ST RLY REQ NOTE: Vehicle without Intelligent Key system indicates only "ON", and it does not change.	When Intelligent Key is outside the vehicle, and the push switch is pushed		Off
	When Intelligent Key is inside the vehicle, and the push switch is pushed		On
IGN RLY	Ignition switch OFF or ACC		Off
	Ignition switch ON		On
RR DEF REQ	Ignition switch ON	Rear window defogger switch OFF	Off
		Rear window defogger switch ON (Rear window defogger is operating)	On
OIL P SW	Ignition switch OFF, ACC or engine running		Open
	Ignition switch ON		Close
DTRL REQ NOTE: This item is monitored only on the vehicle with the daytime running light system.	Daytime running light system is not operated.		Off
	Daytime running light system is operated.		On

IPDM E/R (INTELLIGENT POWER DISTRIBUTION MODULE ENGINE ROOM)

< ECU DIAGNOSIS >

Monitor Item	Condition	Value/Status
HOOD SW NOTE: This item is monitored only the vehicle for Mexico.	Close the hood	Off
	Open the hood	On
THFT HRN REQ	Not operation	Off
	Horn is activated with vehicle security system or panic alarm system.	On
HORN CHIRP	Not operation	Off
	Horn is activated with key fob LOCK operation.	On

TERMINAL LAYOUT

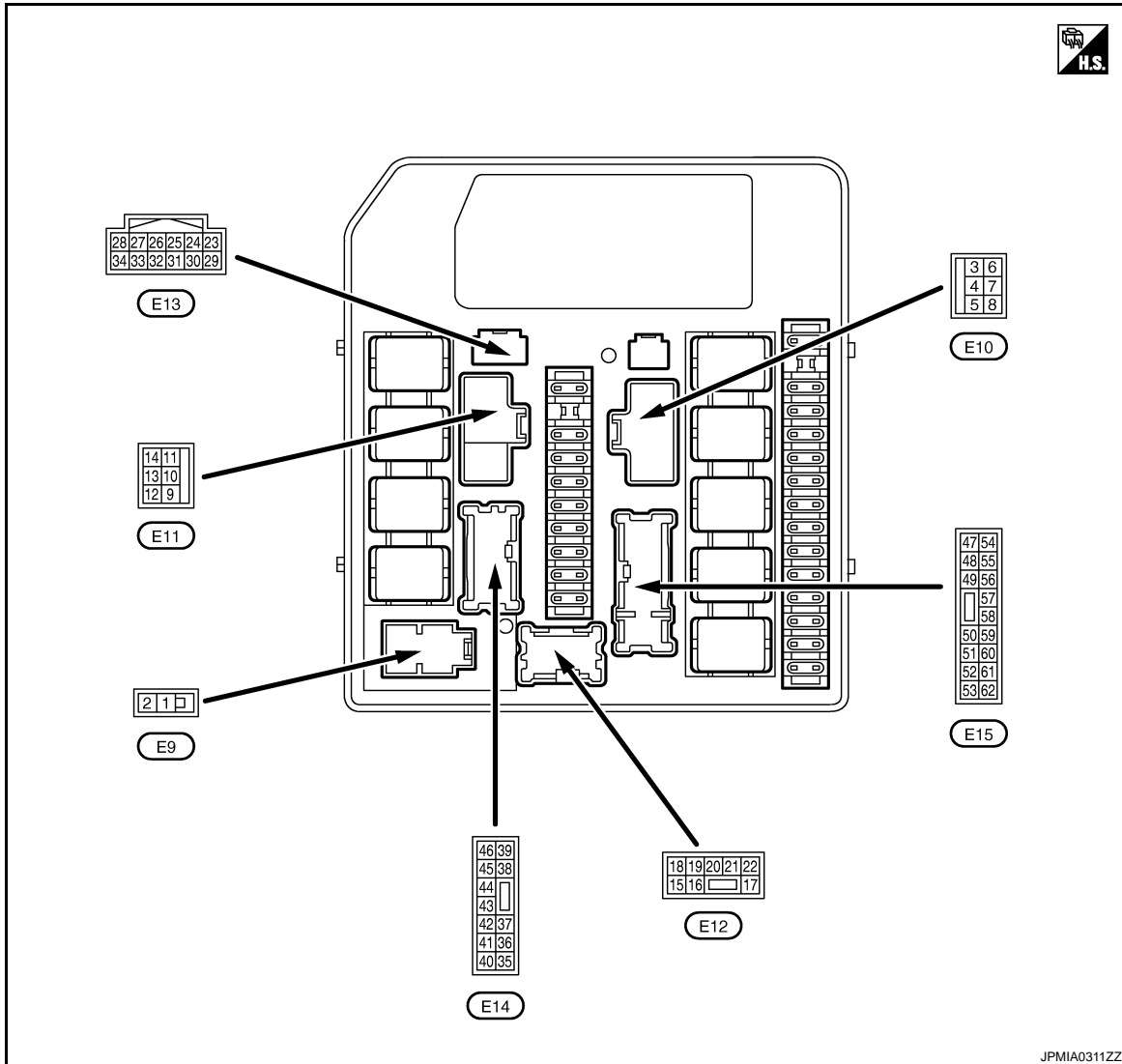

PHYSICAL VALUES

Terminal No. (Wire color)		Description		Condition	Value (Approx.)
+	-	Signal name	Input/ Output		
1 (R)	Ground	Battery power supply	Input	Ignition switch OFF	Battery voltage
2 (G)	Ground	Battery power supply	Input	Ignition switch OFF	Battery voltage

IPDM E/R (INTELLIGENT POWER DISTRIBUTION MODULE ENGINE ROOM)

< ECU DIAGNOSIS >

Terminal No. (Wire color)		Description		Condition		Value (Approx.)
+	-	Signal name	Input/ Output			
3 (O)	Ground	Starter relay power supply	Output	When engine is clanking		Battery voltage
				When engine is not clanking		0 V
4 (W)	Ground	Cooling fan relay-1 power supply	Output	Cooling fan operation	OFF	0 V
					MID or HI	Battery voltage
5 (R)	Ground	Ignition switch START	Input	Ignition switch OFF, ACC or ON		0 V
				Ignition switch START		Battery voltage
6 (BR)	Ground	Battery power supply (Cooling fan relay)	Input	Ignition switch OFF		Battery voltage
7 (P)	Ground	Cooling fan motor-2 (HI) ground	—	Cooling fan operation	OFF	Battery voltage
					HI	0 V
8 (G)	Ground	Cooling fan relay-2 power supply	Output	Cooling fan operation	OFF	0 V
					HI	Battery voltage
11 (B)	Ground	Ground	—	Ignition switch ON		0 V
12 (O)	Ground	Rear window defogger relay power supply	Output	Ignition switch ON	Rear window defogger switch OFF	0 V
					Rear window defogger switch ON	Battery voltage
15 ^{*1} (SB)	Ground	Daytime running light relay control	Output	Daytime running light system	Not operated	Battery voltage
					Operated	0 V
16 ^{*2} (Y)	Ground	Front fog lamp (LH)	Output	Lighting switch 2ND	Front fog lamp switch OFF	0 V
					Front fog lamp switch ON	Battery voltage
17 ^{*2} (W)	Ground	Front fog lamp (RH)	Output	Lighting switch 2ND	Front fog lamp switch OFF	0 V
					Front fog lamp switch ON	Battery voltage
18 (L)	Ground	Headlamp LO (LH)	Output	Lighting switch OFF		0 V
				Lighting switch 2ND		Battery voltage
20 (SB)	Ground	Headlamp LO (RH)	Output	Lighting switch OFF		0 V
				Lighting switch 2ND		Battery voltage
21 (G)	Ground	Headlamp HI (LH)	Output	Lighting switch OFF		0 V
				<ul style="list-style-type: none"> Lighting switch 2ND and HI Lighting switch PASS 		Battery voltage
				Daytime running light system Operated ^{*1}		7.0 V
22 (LG)	Ground	Headlamp HI (RH)	Output	Lighting switch OFF		0 V
				<ul style="list-style-type: none"> Lighting switch 2ND and HI Lighting switch PASS 		Battery voltage
				Daytime running light system Operated ^{*1}		7.0 V
23 (W)	Ground	Oil pressure switch	Input	Ignition switch ON	Engine stopped	0 V
					Engine running	Battery voltage
24 (Y)	Ground	Front wiper auto stop	Input	Ignition switch ON	Front wiper stop position	0 V
					Any position other than front wiper stop position	Battery voltage
25 (B)	Ground	Ground	—	Ignition switch ON		0 V
26 (P)	—	CAN-L	Input/ Output	—		—

A
B
C
D
E
F
G
H
I
J
K
DEF
M
N
O
P

IPDM E/R (INTELLIGENT POWER DISTRIBUTION MODULE ENGINE ROOM)

< ECU DIAGNOSIS >

Terminal No. (Wire color)		Description		Condition		Value (Approx.)
+	-	Signal name	Input/ Output			
27 (L)	—	CAN-H	Input/ Output	—		—
31 (LG)	Ground	Cooling fan relay-4 control	Output	Cooling fan operation	OFF LO	Battery voltage 0 - 1.0 V
32 (V)	Ground	Throttle control motor relay control	Input	After passing approximately 2 seconds or more after turning the ignition switch from ON to OFF		Battery voltage
				<ul style="list-style-type: none"> Ignition switch ON For approximately 2 seconds after turning ignition switch from ON to OFF 		0 - 1.0 V
33 (GR)	Ground	Fuel pump relay control	Input	Ignition switch OFF		0 V
				Ignition switch ON	Engine stopped	Battery voltage
					Engine running	0.8 V
34*3 (W)	Ground	Hood switch	Input	Close the hood		Battery voltage
				Open the hood		0 V
37 (R)	Ground	Tail, license plate lamps and illuminations	Output	Lighting switch OFF		0 V
				Lighting switch 1ST		Battery voltage
38 (R)	Ground	Parking lamp (LH)	Output	Lighting switch OFF		0 V
				Lighting switch 1ST		Battery voltage
39 (GR)	Ground	Parking lamp (RH)	Output	Lighting switch OFF		0 V
				Lighting switch 1ST		Battery voltage
40 (BR)	Ground	Ignition relay power supply	Output	Ignition switch OFF or ACC		0 V
				Ignition switch ON		Battery voltage
41 (O)	Ground	Ignition relay power supply	Output	Ignition switch OFF or ACC		0 V
				Ignition switch ON		Battery voltage
42 (L)	Ground	Front wiper HI	Output	Ignition switch ON	Front wiper switch OFF	0 V
					Front wiper switch HI	Battery voltage
43 (G)	Ground	Front wiper LO	Output	Ignition switch ON	Front wiper switch OFF	0 V
					Front wiper switch LO	Battery voltage
45 (Y)	Ground	Starter relay power supply	Input	Ignition switch ON	Selector lever "P" or "N"	Battery voltage
					Selector lever in any position other than "P" or "N"	0 V
46 (W)	Ground	Fuel pump relay power supply	Output	<ul style="list-style-type: none"> Ignition switch OFF or ACC After passing approximately 1 second or more after turning the ignition switch ON 		0 V
				<ul style="list-style-type: none"> For approximately 1 second after turning the ignition switch ON Engine running 		Battery voltage
47 (BR)	Ground	ECM relay power supply	Output	After passing approximately 4 seconds or more after turning the ignition switch from ON to OFF		0 V
				<ul style="list-style-type: none"> Ignition switch ON For approximately 4 seconds after turning ignition switch from ON to OFF 		Battery voltage
48 (R)	Ground	ECM relay power supply	Output	After passing approximately 4 seconds or more after turning the ignition switch from ON to OFF		0 V
				<ul style="list-style-type: none"> Ignition switch ON For approximately 4 seconds after turning ignition switch from ON to OFF 		Battery voltage

IPDM E/R (INTELLIGENT POWER DISTRIBUTION MODULE ENGINE ROOM)

< ECU DIAGNOSIS >

Terminal No. (Wire color)		Description		Condition		Value (Approx.)
+	-	Signal name	Input/ Output			
50 (G)	Ground	Cooling fan relay-5 control	Output	Cooling fan operation	OFF	Battery voltage
					MID or HI	0 - 1.0 V
51 (L)	Ground	ECM relay control	Output	After passing approximately 4 seconds or more after turning the ignition switch from ON to OFF		Battery voltage
				<ul style="list-style-type: none"> Ignition switch ON For approximately 4 seconds after turning ignition switch from ON to OFF 		0 - 1.0 V
52 (P)	Ground	Throttle control motor relay power supply	Output	After passing approximately 2 seconds or more after turning the ignition switch from ON to OFF		0 V
				<ul style="list-style-type: none"> Ignition switch ON For approximately 2 seconds after turning ignition switch from ON to OFF 		Battery voltage
55 (O)	Ground	A/C relay power supply	Output	Engine stopped		0 V
				Engine running	A/C switch OFF	0 V
					A/C switch ON (A/C compressor is operating)	Battery voltage
56 (SB)	Ground	Ignition switch ON	Input	Ignition switch OFF or ACC		0 V
				Ignition switch ON		Battery voltage
57 (V)	Ground	Horn relay control	Output	The horn is not activated		Battery voltage
				The horn is activated		0 V
58 (LG)	Ground	Ignition relay power supply	Output	Ignition switch OFF or ACC		0 V
				Ignition switch ON		Battery voltage
59 (BR)	Ground	Ignition relay power supply	Output	Ignition switch OFF or ACC		0 V
				Ignition switch ON		Battery voltage
60 (SB)	Ground	Ignition relay power supply	Output	Ignition switch OFF or ACC		0 V
				Ignition switch ON		Battery voltage
61 (R)	Ground	ECM power supply	Output	Ignition switch OFF		Battery voltage

*1: With daytime running light system

*2: With front fog lamp system

*3: For Mexico

A
B
C
D
E
F
G
H
I
J
K
DEF
M
N
O
P

IPDM E/R (INTELLIGENT POWER DISTRIBUTION MODULE ENGINE ROOM)

< ECU DIAGNOSIS >

Wiring Diagram - IPDM E/R -

INFOID:000000004534036

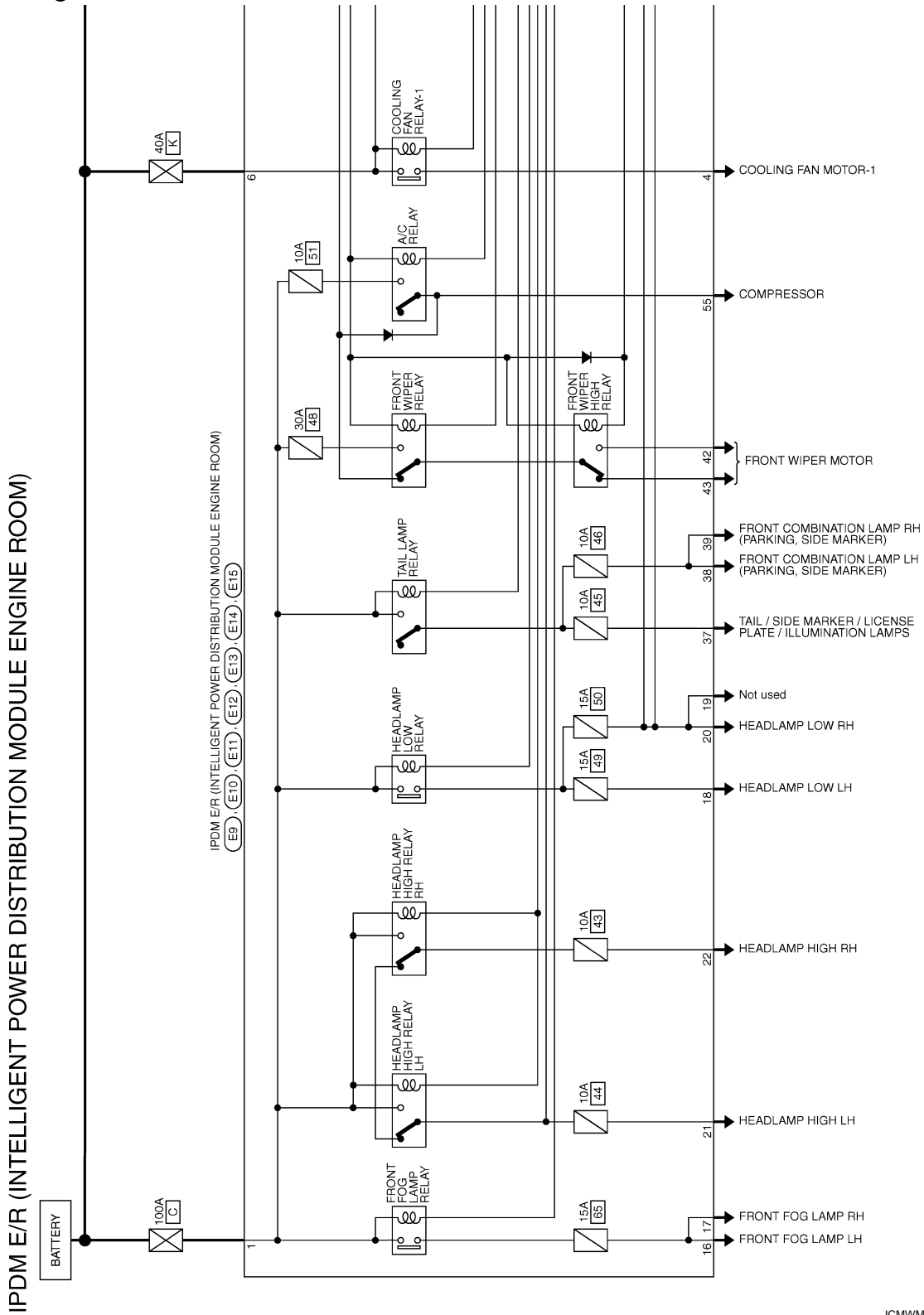

2008/07/15

JCMWM2858G

IPDM E/R (INTELLIGENT POWER DISTRIBUTION MODULE ENGINE ROOM)

< ECU DIAGNOSIS >

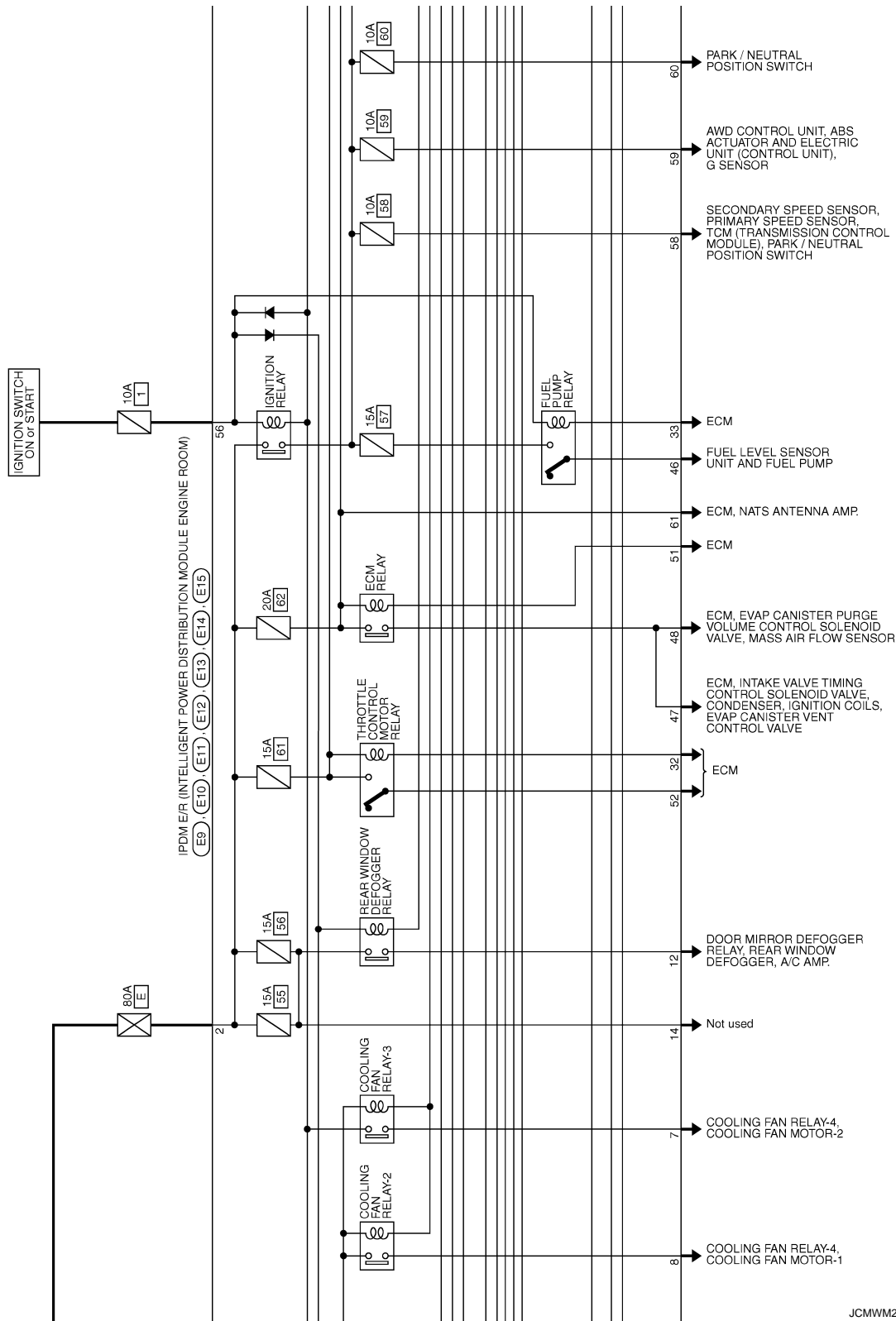

A
B
C
D
E
F
G
H
I
J
K
DEF
M
N
O
P

JCMWM2859GI

IPDM E/R (INTELLIGENT POWER DISTRIBUTION MODULE ENGINE ROOM)

< ECU DIAGNOSIS >

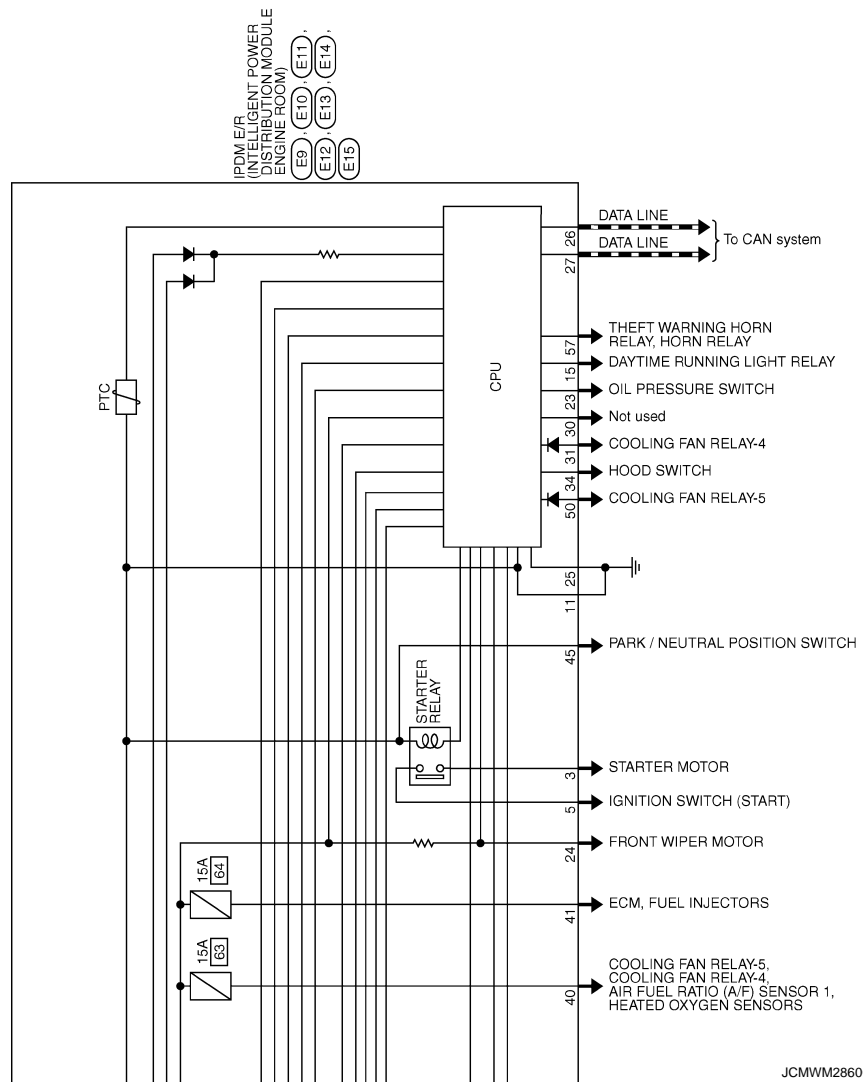

IPDM E/R (INTELLIGENT POWER DISTRIBUTION MODULE ENGINE ROOM)

< ECU DIAGNOSIS >

Control part	Fail-safe in operation
Cooling fan	<ul style="list-style-type: none"> The cooling fan relay-1, the cooling fan relay-2, the cooling fan relay-3 and the cooling fan relay-5 turn ON when the ignition switch is turned ON The cooling fan relay-1, the cooling fan relay-2, the cooling fan relay-3 and the cooling fan relay-5 turn OFF when the ignition switch is turned OFF Cooling fan relay-4 OFF
A/C compressor	A/C relay OFF

If no CAN communication is available with BCM

Control part	Fail-safe in operation
Headlamp	<ul style="list-style-type: none"> The headlamp low relay turns ON when the ignition switch is turned ON The headlamp low relay turns OFF when the ignition switch is turned OFF Headlamp high relay OFF
<ul style="list-style-type: none"> Parking lamps License plate lamps Tail lamps Illuminations 	<ul style="list-style-type: none"> The tail lamp relay and the daytime running light relay* turn ON when the ignition switch is turned ON The tail lamp relay and the daytime running light relay* turn OFF when the ignition switch is turned OFF
Front wiper	<ul style="list-style-type: none"> The status just before activation of fail-safe control is maintained until the ignition switch is turned OFF while the front wiper is operating at LO or HI speed. The front wiper is operated at LO speed until the ignition switch is turned OFF if the fail-safe control is activated while the front wiper is set in the INT mode and the front wiper motor is operating.
Front fog lamps	Front fog lamp relay OFF
Starter motor	Starter relay OFF
Rear window defogger	Rear window defogger relay OFF
Horn	Horn relay OFF

NOTE:

*: With daytime running light system

IGNITION RELAY MALFUNCTION DETECTION FUNCTION

- IPDM E/R monitors status of ignition relay by the voltage at ignition relay contact circuit inside it.
- IPDM E/R judges that the ignition relay is error, if status of the ignition relay and ignition switch ON signal (CAN).
- If the ignition relay cannot turn OFF due to contact seizure, it activates the tail lamp relay and daytime running light relay* for 10 minutes to alert the user to the ignition relay malfunction when the ignition switch is turned OFF.

Detection		IPDM E/R judgment	Operation
Ignition switch ON signal	Ignition relay		
ON	ON	Ignition relay normal	—
OFF	OFF	Ignition relay normal	—
OFF	ON	Ignition relay ON stuck	Turn on the tail lamp relay and daytime running light relay* for 10 minutes
ON	OFF	Ignition relay OFF stuck	Detect DTC "B2099: IGN RELAY OFF"

NOTE:

*: With daytime running light system

FRONT WIPER CONTROL

IPDM E/R detects the front wiper stop position with the front wiper stop position signal.

When the front wiper stop position signal is in the conditions listed below, IPDM E/R repeats a front wiper 10 seconds operation and 20 seconds stop five times.

IPDM E/R (INTELLIGENT POWER DISTRIBUTION MODULE ENGINE ROOM)

< ECU DIAGNOSIS >

Ignition switch	Front wiper switch	Front wiper stop position signal
ON	OFF	The front wiper stop position signal (stop position) cannot be input for 10 seconds.
	ON	The front wiper stop position signal does not change for 10 seconds.

NOTE:

This operation status can be confirmed on the IPDM E/R “Data Monitor” that displays “BLOCK” for the item “WIP PROT” while the wiper is stopped.

DTC Index

INFOID:000000004534038

CONSULT display	Fail-safe	Timing ^{NOTE}		Reference page
No DTC is detected. further testing may be required.	—	—	—	—
U1000: CAN COMM CIRCUIT	×	CRNT	PAST	PCS-13
B2099: IGN RELAY OFF	—	CRNT	PAST	PCS-14

NOTE:

The details of time display are as follows.

- CRNT: The malfunctions that are detected now.
- PAST: The number is indicated when it is normal at present and a malfunction was detected in the past.

A
B
C
D
E
F
G
H
I
J
K
DEF
M
N
O
P



REAR WINDOW DEFOGGER DOES NOT OPERATE

< SYMPTOM DIAGNOSIS >

SYMPTOM DIAGNOSIS

REAR WINDOW DEFOGGER DOES NOT OPERATE

Diagnosis Procedure

INFOID:000000004231747

1. IPDM E/R AUTO ACTIVE TEST

Check IPDM E/R active test.

Refer to [DEF-8, "Diagnosis Description"](#).

Is the inspection result normal?

YES >> GO TO 2.

NO >> Repair or replace the malfunctioning parts.

2. CHECK REAR WINDOW DEFOGGER SWITCH

Check rear window defogger switch.

Refer to [DEF-13, "Component Function Check"](#).

Is the inspection result normal?

YES >> GO TO 3.

NO >> Repair or replace the malfunctioning parts.

3. CHECK REAR WINDOW DEFOGGER RELAY

Check rear window defogger relay.

Refer to [DEF-15, "Component Function Check"](#).

Is the inspection result normal?

YES >> GO TO 4.

NO >> Repair or replace the malfunctioning parts.

4. CHECK REAR WINDOW DEFOGGER

Check rear window defogger.

Refer to [DEF-19, "Component Function Check"](#).

Is the inspection result normal?

YES >> GO TO 5.

NO >> Repair or replace the malfunctioning parts.

5. CONFIRM THE OPERATION

Confirm the operation again.

Is the result normal?

YES >> Check intermittent incident. Refer to [GI-41, "Intermittent Incident"](#)

NO >> GO TO 1.

REAR WINDOW DEFOGGER AND DOOR MIRROR DEFOGGER DO NOT OPERATE.

< SYMPTOM DIAGNOSIS >

REAR WINDOW DEFOGGER AND DOOR MIRROR DEFOGGER DO NOT OPERATE.

Diagnosis Procedure

INFOID:000000004231748

1. IPDM E/R AUTO ACTIVE TEST

Check IPDM E/R active test.

Refer to [DEF-8, "Diagnosis Description"](#).

Is the inspection result normal?

YES >> GO TO 2.

NO >> Repair or replace the malfunctioning parts.

2. CHECK REAR WINDOW DEFOGGER SWITCH

Check rear window defogger switch.

Refer to [DEF-13, "Component Function Check"](#).

Is the inspection result normal?

YES >> GO TO 3.

NO >> Repair or replace the malfunctioning parts.

3. CHECK REAR WINDOW DEFOGGER RELAY

Check rear window defogger relay.

Refer to [DEF-15, "Component Function Check"](#).

Is the inspection result normal?

YES >> GO TO 4.

NO >> Repair or replace the malfunctioning parts.

4. CHECK REAR WINDOW DEFOGGER

Check rear window defogger.

Refer to [DEF-19, "Component Function Check"](#).

Is the inspection result normal?

YES >> GO TO 5.

NO >> Repair or replace the malfunctioning parts.

5. CONFIRM THE OPERATION

Confirm the operation again.

Is the result normal?

YES >> Check intermittent incident. Refer to [GI-41, "Intermittent Incident"](#)

NO >> GO TO 1.

A
B
C
D
E
F
G
H
I
J
K
DEF
M
N
O
P

REAR WINDOW DEFOGGER DOES NOT OPERATE BUT BOTH OF DOOR MIRROR DEFOGGER OPERATE.

< SYMPTOM DIAGNOSIS >

REAR WINDOW DEFOGGER DOES NOT OPERATE BUT BOTH OF DOOR MIRROR DEFOGGER OPERATE.

Diagnosis Procedure

INFOID:000000004231749

1.CHECK REAR WINDOW DEFOGGER

Check rear window defogger.

Refer to [DEF-19, "Component Function Check"](#).

Is the inspection result normal?

YES >> GO TO 2.

NO >> Repair or replace the malfunctioning parts.

2.CONFIRM THE OPERATION

Confirm the operation again.

Is the result normal?

YES >> Check intermittent incident. Refer to [GI-41, "Intermittent Incident"](#)

NO >> GO TO 1.

DOOR MIRROR DEFOGGER DOES NOT OPERATE

< SYMPTOM DIAGNOSIS >

DOOR MIRROR DEFOGGER DOES NOT OPERATE BOTH SIDE

BOTH SIDE : Diagnosis Procedure

INFOID:000000004231750

1.CHECK DOOR MIRROR DEFOGGER CIRCUIT

Check door mirror defogger circuit.

Refer to [DEF-21, "DRIVER SIDE : Component Function Check"](#)

Is the inspection result normal?

YES >> GO TO 2.

NO >> Repair or replace the malfunctioning parts.

2.CONFIRM THE OPERATION

Confirm the operation again.

Is the result normal?

YES >> Check intermittent incident. Refer to [GI-41, "Intermittent Incident"](#)

NO >> GO TO 1.

DRIVER SIDE

DRIVER SIDE : Diagnosis Procedure

INFOID:000000004231751

1.CHECK DRIVER SIDE DOOR MIRROR DEFOGGER

Check driver side door mirror defogger.

Refer to [DEF-22, "DRIVER SIDE : Component Inspection"](#).

Is the inspection result normal?

YES >> GO TO 2.

NO >> Repair or replace the malfunctioning parts.

2.CONFIRM THE OPERATION

Confirm the operation again.

Is the result normal?

YES >> Check intermittent incident. Refer to [GI-41, "Intermittent Incident"](#)

NO >> GO TO 1.

PASSENGER SIDE

PASSENGER SIDE : Diagnosis Procedure

INFOID:000000004231752

1.CHECK PASSENGER SIDE DOOR MIRROR DEFOGGER.

Check passenger side door mirror defogger.

Refer to [DEF-24, "PASSENGER SIDE : Component Inspection"](#)

Is the inspection result normal?

YES >> GO TO 2.

NO >> Repair or replace the malfunctioning parts.

2.CONFIRM THE OPERATION

Confirm the operation again.

Is the result normal?

YES >> Check intermittent incident. Refer to [GI-41, "Intermittent Incident"](#)

NO >> GO TO 1.

A
B
C
D
E
F
G
H
I
J
K
M
N
O
P

DEF

REAR WINDOW DEFOGGER SWITCH DOES NOT LIGHT, BUT REAR WINDOW DEFOGGER OPERATES

< SYMPTOM DIAGNOSIS >

REAR WINDOW DEFOGGER SWITCH DOES NOT LIGHT, BUT REAR WINDOW DEFOGGER OPERATES

Diagnosis Procedure

INFOID:000000004231753

1. CHECK REAR WINDOW DEFOGGER INDICATOR

Check rear window defogger ON signal.

Refer to [DEF-25, "Component Function Check"](#).

Is the inspection result normal?

YES >> GO TO 2.

NO >> Repair or replace the malfunctioning parts.

2. CONFIRM THE OPERATION

Confirm the operation again.

Is the result normal?

YES >> Check intermittent incident. Refer to [GI-41, "Intermittent Incident"](#)

NO >> GO TO 1.

PRECAUTIONS

< PRECAUTION >

PRECAUTION

PRECAUTIONS FOR USA AND CANADA

FOR USA AND CANADA : Precaution for Supplemental Restraint System (SRS) "AIR BAG" and "SEAT BELT PRE-TENSIONER"

INFOID:000000004231754

The Supplemental Restraint System such as "AIR BAG" and "SEAT BELT PRE-TENSIONER", used along with a front seat belt, helps to reduce the risk or severity of injury to the driver and front passenger for certain types of collision. This system includes seat belt switch inputs and dual stage front air bag modules. The SRS system uses the seat belt switches to determine the front air bag deployment, and may only deploy one front air bag, depending on the severity of a collision and whether the front occupants are belted or unbelted. Information necessary to service the system safely is included in the "SRS AIRBAG" and "SEAT BELT" of this Service Manual.

WARNING:

- To avoid rendering the SRS inoperative, which could increase the risk of personal injury or death in the event of a collision which would result in air bag inflation, all maintenance must be performed by an authorized NISSAN/INFINITI dealer.
- Improper maintenance, including incorrect removal and installation of the SRS, can lead to personal injury caused by unintentional activation of the system. For removal of Spiral Cable and Air Bag Module, see the "SRS AIRBAG".
- Never use electrical test equipment on any circuit related to the SRS unless instructed to in this Service Manual. SRS wiring harnesses can be identified by yellow and/or orange harnesses or harness connectors.

FOR MEXICO

FOR MEXICO : Precaution for Supplemental Restraint System (SRS) "AIR BAG" and "SEAT BELT PRE-TENSIONER"

INFOID:000000004231755

The Supplemental Restraint System such as "AIR BAG" and "SEAT BELT PRE-TENSIONER", used along with a front seat belt, helps to reduce the risk or severity of injury to the driver and front passenger for certain types of collision. Information necessary to service the system safely is included in the "SRS AIRBAG" and "SEAT BELT" of this Service Manual.

WARNING:

- To avoid rendering the SRS inoperative, which could increase the risk of personal injury or death in the event of a collision which would result in air bag inflation, all maintenance must be performed by an authorized NISSAN/INFINITI dealer.
- Improper maintenance, including incorrect removal and installation of the SRS, can lead to personal injury caused by unintentional activation of the system. For removal of Spiral Cable and Air Bag Module, see the "SRS AIRBAG".
- Do not use electrical test equipment on any circuit related to the SRS unless instructed to in this Service Manual. SRS wiring harnesses can be identified by yellow and/or orange harnesses or harness connectors.

A
B
C
D
E
F
G
H
I
J
K
DEF
M
N
O
P

FILAMENT

< ON-VEHICLE REPAIR >

ON-VEHICLE REPAIR

FILAMENT

Inspection and Repair

INFOID:000000004231756

INSPECTION

1. When measuring voltage, wrap tin foil around the top of the negative probe. Then press the foil against the wire with your finger.

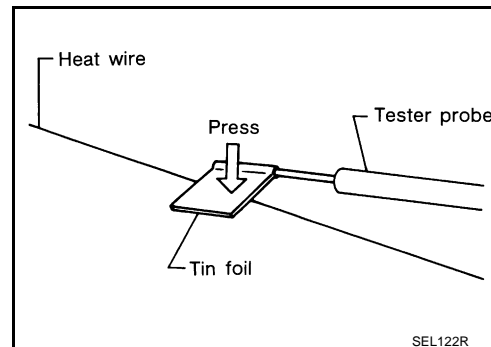

2. Attach probe circuit tester (in Volt range) to middle portion of each filament.

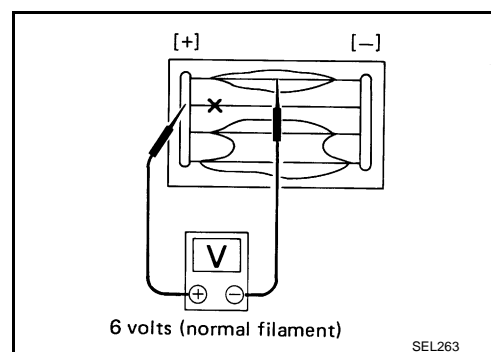

3. If a filament is burned out, circuit tester registers 0 or battery voltage.
4. To locate burned out point, move probe to left and right along filament. Test needle will swing abruptly when probe passes the point.

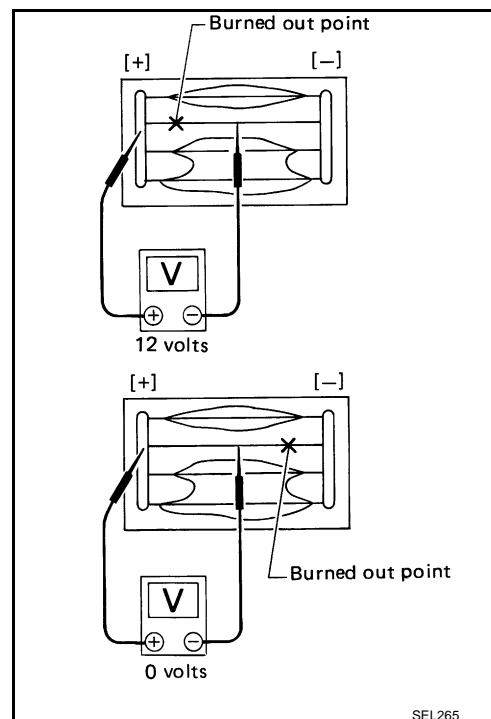

REPAIR

REPAIR EQUIPMENT

- Conductive silver composition (Dupont No. 4817 or equivalent)

FILAMENT

< ON-VEHICLE REPAIR >

- Ruler 30 cm (11.8 in) long
- Drawing pen
- Heat gun
- Alcohol
- Cloth

REPAIRING PROCEDURE

1. Wipe broken heat wire and its surrounding area clean with a cloth dampened in alcohol.
2. Apply a small amount of conductive silver composition to tip of drawing pen. Shake silver composition container before use.
3. Place ruler on glass along broken line. Deposit conductive silver composition on break with drawing pen. Slightly overlap existing heat wire on both sides [preferably 5 mm (0.20 in)] of the break.

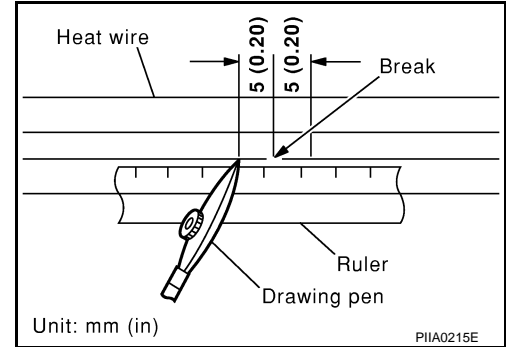

4. After repair has been completed, check repaired wire for continuity. This check should be conducted 10 minutes after silver composition is deposited. Do not touch repaired area while test is being conducted.

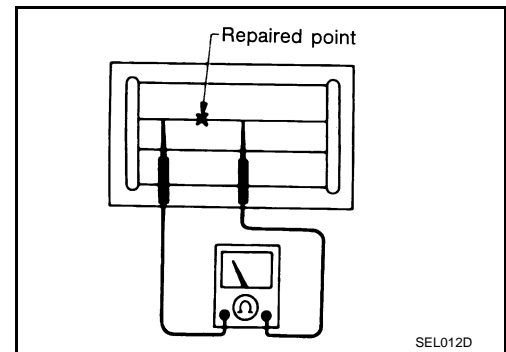

5. Apply a constant stream of hot air directly to the repaired area for approximately 20 minutes with a heat gun. A minimum distance of 3 cm (1.2 in) should be kept between repaired area and hot air outlet. If a heat gun is not available, let the repaired area dry for 24 hours.

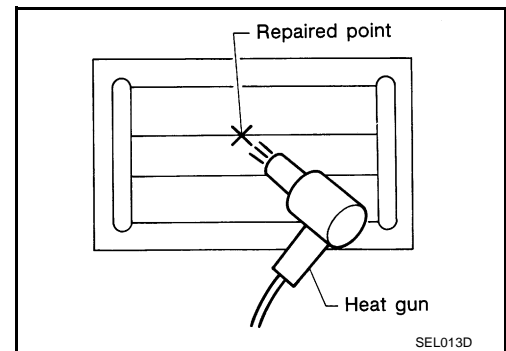

A
B
C
D
E
F
G
H
I
J
K
DEF
M
N
O
P