

# SECTION **STC**

## STEERING CONTROL SYSTEM

A  
B  
C  
D  
E  
F  
G  
H  
I  
J  
K  
L  
M  
N  
O  
P

### CONTENTS

<p><b>BASIC INSPECTION</b> ..... 3</p> <p><b>DIAGNOSIS AND REPAIR WORKFLOW</b> ..... 3</p> <p style="padding-left: 20px;">Work Flow .....3</p> <p><b>FUNCTION DIAGNOSIS</b> ..... 4</p> <p><b>EPS SYSTEM</b> ..... 4</p> <p style="padding-left: 20px;">System Diagram .....4</p> <p style="padding-left: 20px;">System Description .....4</p> <p style="padding-left: 20px;">Component Parts Location .....5</p> <p style="padding-left: 20px;">Component Description .....5</p> <p><b>DIAGNOSIS SYSTEM (EPS CONTROL UNIT)</b></p> <p style="padding-left: 20px;">CONSULT-III Function (EPS) .....7</p> <p><b>COMPONENT DIAGNOSIS</b> ..... 8</p> <p><b>C1601 BATTERY POWER SUPPLY</b> ..... 8</p> <p style="padding-left: 20px;">Description .....8</p> <p style="padding-left: 20px;">DTC Logic .....8</p> <p style="padding-left: 20px;">Diagnosis Procedure .....8</p> <p style="padding-left: 20px;">Special Repair Requirement .....9</p> <p><b>C1604 TORQUE SENSOR</b> .....10</p> <p style="padding-left: 20px;">Description ..... 10</p> <p style="padding-left: 20px;">DTC Logic ..... 10</p> <p style="padding-left: 20px;">Diagnosis Procedure ..... 10</p> <p style="padding-left: 20px;">Special Repair Requirement ..... 10</p> <p><b>C1606 EPS MOTOR</b> .....11</p> <p style="padding-left: 20px;">Description ..... 11</p> <p style="padding-left: 20px;">DTC Logic ..... 11</p> <p style="padding-left: 20px;">Diagnosis Procedure ..... 11</p> <p style="padding-left: 20px;">Special Repair Requirement ..... 11</p> <p><b>C1607 EEPROM</b> .....12</p> <p style="padding-left: 20px;">Description ..... 12</p> <p style="padding-left: 20px;">DTC Logic ..... 12</p> <p style="padding-left: 20px;">Diagnosis Procedure ..... 12</p> <p style="padding-left: 20px;">Special Repair Requirement ..... 12</p>	<p><b>C1608 CONTROL UNIT</b> .....13</p> <p style="padding-left: 20px;">Description .....13</p> <p style="padding-left: 20px;">DTC Logic .....13</p> <p style="padding-left: 20px;">Diagnosis Procedure .....13</p> <p style="padding-left: 20px;">Special Repair Requirement .....14</p> <p><b>U1200 VEHICLE SPEED SIGNAL (ABS)</b> .....15</p> <p style="padding-left: 20px;">Description .....15</p> <p style="padding-left: 20px;">DTC Logic .....15</p> <p style="padding-left: 20px;">Diagnosis Procedure .....15</p> <p style="padding-left: 20px;">Special Repair Requirement .....15</p> <p><b>U14FF VEHICLE SPEED SIGNAL (METER)</b> ...16</p> <p style="padding-left: 20px;">Description .....16</p> <p style="padding-left: 20px;">DTC Logic .....16</p> <p style="padding-left: 20px;">Diagnosis Procedure .....16</p> <p style="padding-left: 20px;">Special Repair Requirement .....16</p> <p><b>U1000 CAN COMM CIRCUIT</b> .....17</p> <p style="padding-left: 20px;">Description .....17</p> <p style="padding-left: 20px;">DTC Logic .....17</p> <p style="padding-left: 20px;">Diagnosis Procedure .....17</p> <p style="padding-left: 20px;">Special Repair Requirement .....17</p> <p><b>ECU DIAGNOSIS</b> .....18</p> <p><b>EPS CONTROL UNIT</b> .....18</p> <p style="padding-left: 20px;">Reference Value .....18</p> <p style="padding-left: 20px;">Wiring Diagram - ELECTRONICALLY CONTROLLED POWER STEERING SYSTEM - .....20</p> <p style="padding-left: 20px;">Fail-Safe .....22</p> <p style="padding-left: 20px;">DTC No. Index .....23</p> <p><b>SYMPTOM DIAGNOSIS</b> .....24</p> <p><b>EPS WARNING LAMP DOES NOT TURN ON...</b>24</p> <p style="padding-left: 20px;">Description .....24</p> <p style="padding-left: 20px;">Diagnosis Procedure .....24</p> <p><b>EPS WARNING LAMP DOES NOT TURN OFF</b> .....25</p> <p style="padding-left: 20px;">Description .....25</p>
--	--

STC

Diagnosis Procedure .....	25	FOR USA AND CANADA : Precaution Necessary for Steering Wheel Rotation After Battery Disconnect .....	30
<b>STEERING WHEEL TURNING FORCE IS HEAVY OR LIGHT .....</b>	<b>27</b>	FOR USA AND CANADA : Service Notice or Precautions for EPS System .....	30
Diagnosis Procedure .....	27	<b>EXCEPT FOR MEXICO .....</b>	<b>31</b>
<b>UNBALANCE STEERING WHEEL TURNING FORCE AND RETURN BETWEEN RIGHT AND LEFT .....</b>	<b>28</b>	EXCEPT FOR MEXICO : Precaution for Supplemental Restraint System (SRS) "AIR BAG" and "SEAT BELT PRE-TENSIONER" .....	31
Diagnosis Procedure .....	28	EXCEPT FOR MEXICO : Precaution Necessary for Steering Wheel Rotation After Battery Disconnect .....	31
<b>UNBALANCE STEERING WHEEL TURNING FORCE (TORQUE VARIATION) .....</b>	<b>29</b>	EXCEPT FOR MEXICO : Service Notice or Precautions for EPS System .....	32
Diagnosis Procedure .....	29	<b>ON-VEHICLE REPAIR .....</b>	<b>34</b>
<b>PRECAUTION .....</b>	<b>30</b>	<b>EPS CONTROL UNIT .....</b>	<b>34</b>
<b>PRECAUTIONS .....</b>	<b>30</b>	Exploded View .....	34
<b>FOR USA AND CANADA .....</b>	<b>30</b>	Removal and Installation .....	34
FOR USA AND CANADA : Precaution for Supplemental Restraint System (SRS) "AIR BAG" and "SEAT BELT PRE-TENSIONER" .....	30		

# DIAGNOSIS AND REPAIR WORKFLOW

< BASIC INSPECTION >

## BASIC INSPECTION

### DIAGNOSIS AND REPAIR WORKFLOW

Work Flow

INFOID:000000001731504

DETAILED FLOW

#### 1. COLLECT THE INFORMATION FROM THE CUSTOMER

Get the detailed information from the customer about the symptom (the condition and the environment when the incident/malfunction occurred) using the diagnosis worksheet.

>> GO TO 2.

#### 2. PERFORM THE SELF-DIAGNOSIS

Check the DTC display with the self-diagnosis function. Refer to [STC-7, "CONSULT-III Function \(EPS\)"](#).

Is there any DTC displayed?

YES >> GO TO 3.

NO >> GO TO 4.

#### 3. PERFORM THE SYSTEM DIAGNOSIS

Perform the diagnosis applicable to the displayed DTC. Refer to [STC-23, "DTC No. Index"](#).

>> GO TO 6.

#### 4. CHECK THE WARNING LAMP FOR ILLUMINATION

Check that the warning lamp illuminate.

Is ON/OFF timing normal?

YES >> GO TO 5.

NO >> GO TO 2.

#### 5. PERFORM THE DIAGNOSIS BY SYMPTOM

Perform the diagnosis applicable to the symptom.

>> GO TO 6.

#### 6. REPAIR OR REPLACE THE MALFUNCTIONING PARTS

Repair or replace the specified malfunctioning parts.

>> GO TO 7.

#### 7. FINAL CHECK

Perform the self-diagnosis again, and check that the malfunction is repaired completely. After checking, erase the self-diagnosis memory. Refer to [STC-7, "CONSULT-III Function \(EPS\)"](#).

Is no other DTC present and the repair completed?

YES >> INSPECTION END

NO >> GO TO 3.

A  
B  
C  
D  
E  
F  
STC  
H  
I  
J  
K  
L  
M  
N  
O  
P

# EPS SYSTEM

< FUNCTION DIAGNOSIS >

## FUNCTION DIAGNOSIS

### EPS SYSTEM

#### System Diagram

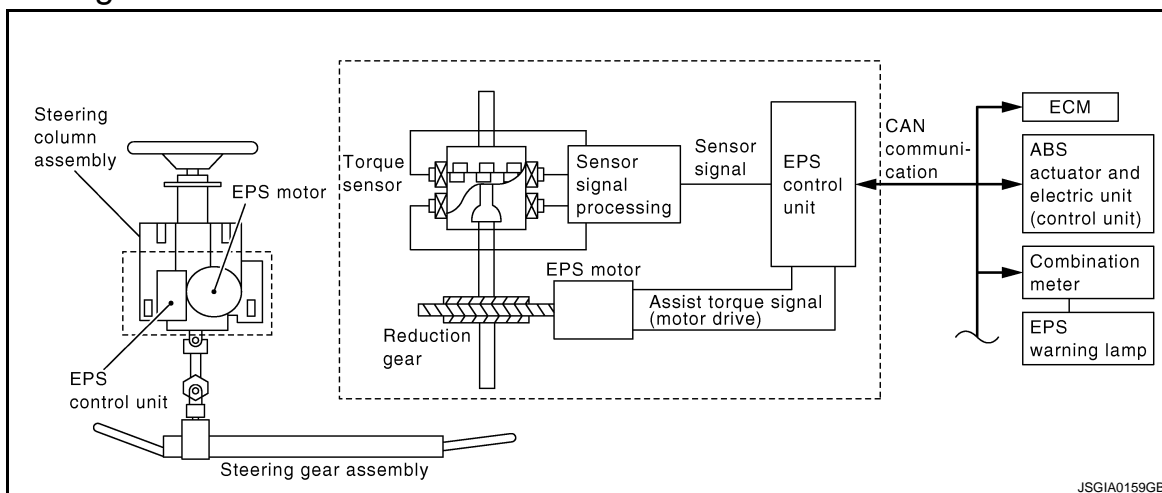

#### System Description

INFOID:000000001731506

- EPS control unit performs an arithmetical operation on data, such as steering wheel turning force (sensor signal) from the torque sensor, vehicle speed signal, etc. Then it generates an optimum assist torque signal to the EPS motor according to the driving condition.
- EPS control unit decreases the output signal to EPS motor while extremely using the power steering function (e.g., full steering) consecutively for protecting EPS motor and EPS control unit (Overload protection control). While activating overload protection control, the assist torque gradually decreases, and the steering wheel turning force becomes heavy. The normal assist torque reactivates by no steering.
- In case of an error in the electrical system, the fail-safe function stops output signals to the EPS motor. Then the previous state is changed to the manual steering state.
- Self-diagnosis can be done with CONSULT-III.
- EPS control unit will decrease assistance under the following 2 conditions.
  - Extensive steering at low speed will cause the ECU and MOTOR to heat up, once temperature reaches critical point ECU will reduce current to reduce heat up. System will recover as temperature lowers (reduced or no assistance).
  - Holding steering on rack-end (full lock) for 1 second will cause the system to engage rack-end protection. This reduces assistance down to 50% in order to prevent heat up. Assistance is immediately returned to 100% when steering released or turned away from rack-end.

# EPS SYSTEM

< FUNCTION DIAGNOSIS >

## Component Parts Location

INFOID:000000001731507

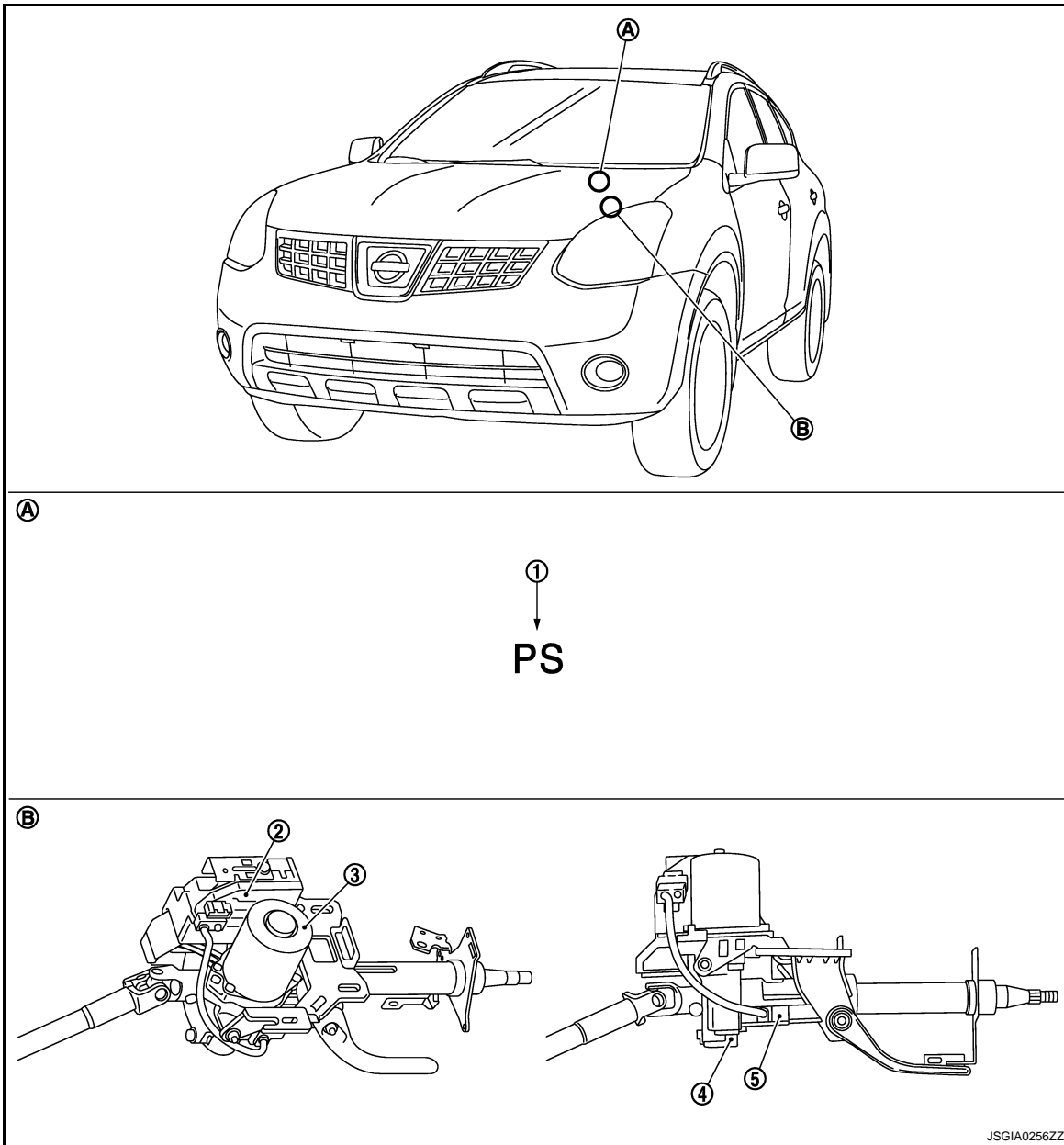

- 1. EPS warning lamp
- 2. EPS control unit
- 3. EPS motor
- 4. Reduction gear
- 5. Torque sensor
- A. Combination meter
- B. Steering column assembly

## Component Description

INFOID:000000001731508

Components parts	Reference
EPS control unit	<a href="#">STC-13, "Description"</a>
EPS motor	<a href="#">STC-11, "Description"</a>
Torque sensor	<a href="#">STC-10, "Description"</a>

# EPS SYSTEM

## < FUNCTION DIAGNOSIS >

Components parts	Reference
Reduction gear	Reduction gear increases the assist torque provided from EPS motor with worm gears, and outputs to the column shaft.
EPS warning lamp	Turn on when a malfunction occurs in the EPS system, and tells the driver the malfunction.

# DIAGNOSIS SYSTEM (EPS CONTROL UNIT)

< FUNCTION DIAGNOSIS >

## DIAGNOSIS SYSTEM (EPS CONTROL UNIT)

### CONSULT-III Function (EPS)

INFOID:000000001731509

#### FUNCTION

CONSULT-III can display each diagnostic item using the diagnostic test modes shown following.

Diagnostic test mode	Function
Self-diagnostic results	Self-diagnostic results can be read and erased quickly.
Data monitor	Input/Output data in the EPS control unit can be read.
ECU part number	Steering column assembly number can be read.

#### SELF-DIAG RESULTS MODE

Display Item List

Refer to [STC-23, "DTC No. Index"](#).

#### DATA MONITOR MODE

Display Item List

Monitor item (Unit)	Remarks
BATTERY VOLT (V)	Displays the power supply voltage for EPS control unit.
TORQUE SENSOR (Nm)	Displays steering wheel turning force detected by torque sensor.
MOTOR SIG (A)	Displays the current commanded value to EPS motor.
MOTOR CURRENT (A)	Displays the current value consumed by EPS motor.
ASSIST TORQUE (Nm)	Displays assist torque being output by the electric power steering.
C/U TEMP (°C)	Displays the temperature of the EPS control unit.
ASSIST LEVEL (%)	Normally displays 100%. In case of an excessive stationary steering, the assist curvature gradually falls. However, it return to 100% when left standing.
VEHICLE SPEED (km/h) or (MPH)	Vehicle speed is displayed from vehicle speed signal via CAN communication.
WARNING LAMP (On/Off)	EPS warning lamp control status is displayed.
ENGINE STATUS (STOP/RUN/STALL/CRANK)	Engine speed is displayed from engine status signal via CAN communication.
MOTOR TEMP (°C)	Displays the temperature of EPS motor.
VHCL SPD CALC (km/h) or (MPH)	Displays vehicle speeds used for controlling EPS.

A

B

C

D

E

F

STC

H

I

J

K

L

M

N

O

P

# C1601 BATTERY POWER SUPPLY

< COMPONENT DIAGNOSIS >

## COMPONENT DIAGNOSIS

### C1601 BATTERY POWER SUPPLY

#### Description

INFOID:000000001731510

Power is supplied from the battery to EPS control unit.

#### DTC Logic

INFOID:000000001731511

#### DTC DETECTION LOGIC

DTC	Display item	Malfunction detected condition	Possible cause
C1601	BATTERY VOLT	When the EPS control unit power supply malfunction is detected.	<ul style="list-style-type: none"><li>• Harness or connector</li><li>• EPS control unit</li></ul>

#### DTC CONFIRMATION PROCEDURE

##### 1.CHECK SELF-DIAGNOSIS RESULTS

Check the self-diagnosis results.

Self-diagnosis results
BATTERY VOLT

Is above displayed on the self-diagnosis display?

- YES >> Proceed to diagnosis procedure. Refer to [STC-8. "Diagnosis Procedure"](#).  
NO >> INSPECTION END

#### Diagnosis Procedure

INFOID:000000001731512

##### 1.CHECK CONNECTOR

1. Turn ignition switch OFF.
2. Disconnect EPS control unit harness connector.
3. Check terminal for deformation, disconnection, looseness, and so on. If any malfunction is found, repair or replace terminal.
4. Reconnect connector and then perform self-diagnosis.

Is any item indicated on the self-diagnosis display?

- YES >> GO TO 2.  
NO >> Poor connection of connector terminal. Repair or replace connector.

##### 2.CHECK EPS CONTROL UNIT POWER SUPPLY CIRCUIT

1. Turn ignition switch OFF.
2. Disconnect EPS control unit harness connector.
3. Turn ignition switch ON. (Do not start engine.)
4. Check voltage between EPS control unit harness connector terminals and ground.

EPS control unit		—	Voltage
Connector	Terminal		
M38	1	Ground	Battery voltage
M37	3		

5. Turn ignition switch OFF.
6. Check voltage between EPS control unit harness connector terminals and ground.



# C1601 BATTERY POWER SUPPLY

## < COMPONENT DIAGNOSIS >

EPS control unit		—	Voltage
Connector	Terminal		
M38	1	Ground	Battery voltage
M37	3		Approx. 0 V

Is the inspection result normal?

YES >> GO TO 3.

NO >> Repair or replace malfunctioning components.

### 3.CHECK EPS CONTROL UNIT GROUND CIRCUIT

1. Check continuity between EPS control unit harness connector terminal and ground.

EPS control unit		—	Continuity
Connector	Terminal		
M38	2	Ground	Existed

2. Connect EPS control unit harness connector.

Is the inspection result normal?

YES >> GO TO 4.

NO >> Repair open circuit or short to ground or short to power in harness or connectors.

### 4.CHECK EPS CONTROL UNIT

1. Turn ignition switch OFF.
2. Connect EPS control unit harness connector.
3. Start engine.
4. Check "BATTERY VOLT" in "DATA MONITOR".

**Voltage : Almost same as battery voltage.**

Is the inspection result normal?

YES >> GO TO 5.

NO >> Replace EPS control unit. Refer to [STC-34. "Exploded View"](#).

### 5.CHECK POWER SUPPLY CIRCUIT

1. Turn head lamp, A/C, blower fan and rear window defogger OFF.
2. Turn steering wheel until it stops.
3. At that time, check "BATTERY VOLT" in "DATA MONITOR".

**Voltage : Almost same as battery voltage.**

Is the inspection result normal?

YES >> INSPECTION END

NO >> Power supply circuit is defective. Repair or replace any inoperative parts.

## Special Repair Requirement

INFOID:000000001731513

### 1.AJUSTMENT OF STEERING ANGLE SENSOR NEUTRAL POSITION

Always perform the neutral position adjustment for the steering angle sensor, when replacing the steering column assembly. Refer to [BRC-76. "ADJUSTMENT OF STEERING ANGLE SENSOR NEUTRAL POSITION : Special Repair Requirement"](#). (VDC models)

>> END

# C1604 TORQUE SENSOR

< COMPONENT DIAGNOSIS >

## C1604 TORQUE SENSOR

### Description

INFOID:000000001731514

Torque sensor detects the steering torque, and transmit the signal to EPS control unit.

### DTC Logic

INFOID:000000001731515

### DTC DETECTION LOGIC

DTC	Display item	Malfunction detected condition	Possible cause
C1604	TORQUE SENSOR	Malfunction of the torque sensor in steering column assembly is detected.	<ul style="list-style-type: none"><li>• Harness or connector</li><li>• Torque sensor</li><li>• EPS control unit</li></ul>

### DTC CONFIRMATION PROCEDURE

#### 1.CHECK SELF-DIAGNOSIS RESULTS

Check the self-diagnosis results.

Self-diagnosis results
TORQUE SENSOR

Is above displayed on the self-diagnosis display?

- YES >> Proceed to diagnosis procedure. Refer to [STC-10, "Diagnosis Procedure"](#).  
NO >> INSPECTION END

### Diagnosis Procedure

INFOID:000000001731516

#### 1.CHECK CONNECTOR

1. Turn ignition switch OFF.
2. Disconnect EPS control unit harness connector.
3. Check terminal for deformation, disconnection, looseness, and so on. If any malfunction is found, repair or replace terminal.
4. Reconnect connectors and then perform the self-diagnosis.

Is the "TORQUE SENSOR" [C1604] displayed?

- YES >> Torque sensor is malfunction. Replace steering column assembly. Refer to [ST-11, "Exploded View"](#).  
NO >> Poor connection of connector terminal. Repair or replace connector.

### Special Repair Requirement

INFOID:000000001731517

#### 1.AJUSTMENT OF STEERING ANGLE SENSOR NEUTRAL POSITION

Always perform the neutral position adjustment for the steering angle sensor, when replacing the steering column assembly. Refer to [BRC-76, "ADJUSTMENT OF STEERING ANGLE SENSOR NEUTRAL POSITION : Special Repair Requirement"](#). (VDC models)

>> END

# C1606 EPS MOTOR

< COMPONENT DIAGNOSIS >

## C1606 EPS MOTOR

### Description

INFOID:000000001731518

EPS motor provides the assist torque by the control signal from EPS control unit.

### DTC Logic

INFOID:000000001731519

### DTC DETECTION LOGIC

DTC	Display item	Malfunction detected condition	Possible cause
C1606	EPS MOTOR	When the motor driver malfunction of EPS control unit or EPS motor malfunction is detected.	<ul style="list-style-type: none"><li>• Harness or connector</li><li>• EPS motor</li><li>• EPS control unit</li></ul>

### DTC CONFIRMATION PROCEDURE

#### 1.CHECK SELF-DIAGNOSIS RESULTS

Check the self-diagnosis results.

Self-diagnosis results
EPS MOTOR

Is above displayed on the self-diagnosis display?

- YES >> Proceed to diagnosis procedure. Refer to [STC-11, "Diagnosis Procedure"](#).  
NO >> INSPECTION END

### Diagnosis Procedure

INFOID:000000001731520

#### 1.CHECK CONNECTOR

1. Turn ignition switch OFF.
2. Disconnect EPS control unit harness connector.
3. Check terminal for deformation, disconnection, looseness, and so on. If any malfunction is found, repair or replace terminal.
4. Reconnect connectors and then perform the self-diagnosis.

Is the "EPS MOTOR" [C1606] displayed?

- YES >> EPS motor malfunctions. Replace steering column assembly. Refer to [ST-11, "Exploded View"](#).  
NO >> Poor connection of connector terminal. Repair or replace connector.

### Special Repair Requirement

INFOID:000000001731521

#### 1.AJUSTMENT OF STEERING ANGLE SENSOR NEUTRAL POSITION

Always perform the neutral position adjustment for the steering angle sensor, when replacing the steering column assembly. Refer to [BRC-76, "ADJUSTMENT OF STEERING ANGLE SENSOR NEUTRAL POSITION : Special Repair Requirement"](#). (VDC models)

>> END

# C1607 EEPROM

< COMPONENT DIAGNOSIS >

## C1607 EEPROM

### Description

INFOID:000000001731522

EPS control unit incorporates a memory function.

### DTC Logic

INFOID:000000001731523

### DTC DETECTION LOGIC

DTC	Display item	Malfunction detected condition	Possible cause
C1607	EEPROM	When the memory (EEPROM) system malfunction is detected in EPS control unit.	<ul style="list-style-type: none"><li>• Harness or connector</li><li>• EPS control unit</li></ul>

### DTC CONFIRMATION PROCEDURE

#### 1.CHECK SELF-DIAGNOSIS RESULTS

Check the self-diagnosis results.

Self-diagnosis results
EEPROM

Is above displayed on the self-diagnosis display?

- YES >> Proceed to diagnosis procedure. Refer to [STC-12. "Diagnosis Procedure"](#).  
NO >> INSPECTION END

### Diagnosis Procedure

INFOID:000000001731524

#### 1.CHECK CONNECTOR

1. Turn ignition switch OFF.
2. Disconnect EPS control unit harness connector.
3. Check terminal for deformation, disconnection, looseness, and so on. If any malfunction is found, repair or replace terminal.
4. Reconnect connectors and then perform the self-diagnosis.

Is the "EEPROM" [C1607] displayed?

- YES >> Replace EPS control unit. Refer to [STC-34. "Exploded View"](#).  
NO >> Poor connection of connector terminal. Repair or replace connector.

### Special Repair Requirement

INFOID:000000001731525

#### 1.AJUSTMENT OF STEERING ANGLE SENSOR NEUTRAL POSITION

Always perform the neutral position adjustment for the steering angle sensor, when replacing the steering column assembly. Refer to [BRC-76. "ADJUSTMENT OF STEERING ANGLE SENSOR NEUTRAL POSITION : Special Repair Requirement"](#). (VDC models)

>> END

# C1608 CONTROL UNIT

< COMPONENT DIAGNOSIS >

## C1608 CONTROL UNIT

### Description

INFOID:000000001731526

EPS control unit performs an arithmetical operation on data, such as steering wheel turning force (sensor signal) from the torque sensor, vehicle speed signal, etc. Then it generates an optimum assist torque signal to the EPS motor according to the driving condition.

### DTC Logic

INFOID:000000001731527

### DTC DETECTION LOGIC

DTC	Display item	Malfunction detected condition	Possible cause
C1608	CONTROL UNIT	When the internal malfunction is detected in EPS control unit.	<ul style="list-style-type: none"><li>• Harness or connector</li><li>• EPS control unit</li></ul>

### DTC CONFIRMATION PROCEDURE

#### 1.CHECK SELF-DIAGNOSIS RESULTS

Check the self-diagnosis results.

Self-diagnosis results
CONTROL UNIT

Is above displayed on the self-diagnosis display?

- YES >> Proceed to diagnosis procedure. Refer to [STC-13, "Diagnosis Procedure"](#).  
NO >> INSPECTION END

### Diagnosis Procedure

INFOID:000000001731528

#### 1.CHECK CONNECTOR

1. Turn ignition switch OFF.
2. Disconnect EPS control unit harness connector.
3. Check terminal for deformation, disconnection, looseness, and so on. If any malfunction is found, repair or replace terminal.
4. Reconnect connectors and then perform self-diagnosis.

Is any item indicated on the self-diagnosis display?

- YES >> GO TO 2.  
NO >> Poor connection of connector terminal. Repair or replace connector.

#### 2.CHECK EPS CONTROL UNIT POWER SUPPLY CIRCUIT

1. Turn ignition switch OFF.
2. Disconnect EPS control unit harness connector.
3. Turn ignition switch ON. (Do not start engine.)
4. Check voltage between EPS control unit harness connector terminals and ground.

EPS control unit		—	Voltage
Connector	Terminal		
M38	1	Ground	Battery voltage
M37	3		

5. Turn ignition switch OFF.
6. Check voltage between EPS control unit harness connector terminals and ground.

# C1608 CONTROL UNIT

## < COMPONENT DIAGNOSIS >

EPS control unit		—	Voltage
Connector	Terminal		
M38	1	Ground	Battery voltage
M37	3		Approx. 0 V

Is the inspection result normal?

YES >> GO TO 3.

NO >> Repair or replace malfunctioning components.

### 3.CHECK EPS CONTROL UNIT GROUND CIRCUIT

1. Check continuity between EPS control unit harness connector terminal and ground.

EPS control unit		—	Continuity
Connector	Terminal		
M38	2	Ground	Existed

2. Connect EPS control unit harness connector.

Is the inspection result normal?

YES >> GO TO 4.

NO >> Repair open circuit or short to ground or short to power in harness or connectors.

### 4.CHECK DTC

Perform EPS control unit self-diagnosis.

Is "C1608 CONTROL UNIT" indicated in self-diagnosis display?

YES >> Replace EPS control unit. Refer to [STC-34. "Exploded View"](#).

NO >> INSPECTION END

## Special Repair Requirement

INFOID:000000001731529

### 1.AJUSTMENT OF STEERING ANGLE SENSOR NEUTRAL POSITION

Always perform the neutral position adjustment for the steering angle sensor, when replacing the steering column assembly. Refer to [BRC-76. "ADJUSTMENT OF STEERING ANGLE SENSOR NEUTRAL POSITION : Special Repair Requirement"](#). (VDC models)

>> END

# U1200 VEHICLE SPEED SIGNAL (ABS)

< COMPONENT DIAGNOSIS >

## U1200 VEHICLE SPEED SIGNAL (ABS)

### Description

INFOID:000000001731530

EPS control unit receives the vehicle speed signal from ABS actuator and electric unit (control unit) via CAN communication line.

### DTC Logic

INFOID:000000001731531

### DTC DETECTION LOGIC

DTC	Display item	Malfunction detected condition	Possible cause
U1200	CAN VHCL SPEED (ABS)	Abnormal vehicle speed signals received via CAN communication are detected.	<ul style="list-style-type: none"><li>• Harness or connector</li><li>• CAN communication line</li><li>• EPS control unit</li><li>• ABS malfunction</li><li>- Vehicle speed signal error</li></ul>

### DTC CONFIRMATION PROCEDURE

#### 1. CHECK SELF-DIAGNOSIS RESULTS

Check the self-diagnosis results.

Self-diagnosis results

CAN VHCL SPEED (ABS)

Is above displayed on the self-diagnosis display?

YES >> Proceed to diagnosis procedure. Refer to [STC-15, "Diagnosis Procedure"](#).

NO >> INSPECTION END

### Diagnosis Procedure

INFOID:000000001731532

#### 1. CHECK ABS ACTUATOR AND ELECTRIC UNIT (CONTROL UNIT) SYSTEM

Perform ABS actuator and electric unit (control unit) self-diagnosis. Repair or replace items indicated, then perform ABS actuator and electric unit (control unit) self-diagnosis again. Refer to [BRC-15, "CONSULT-III Function"](#) (ABS models), [BRC-94, "CONSULT-III Function"](#) (VDC models).

Is any item indicated on the self-diagnosis display?

YES >> Repair or replace malfunctioning components.

NO >> GO TO 2.

#### 2. CHECK CONNECTOR

1. Turn ignition switch OFF.
2. Disconnect EPS control unit harness connector.
3. Check terminal for deformation, disconnection, looseness, and so on. If any malfunction is found, repair or replace terminal.
4. Reconnect connectors and then perform the self-diagnosis.

Is any item indicated on the self-diagnosis display?

YES >> Replace EPS control unit. Refer to [STC-34, "Exploded View"](#).

NO >> Poor connection of connector terminal. Repair or replace connector.

### Special Repair Requirement

INFOID:000000001731533

#### 1. ADJUSTMENT OF STEERING ANGLE SENSOR NEUTRAL POSITION

Always perform the neutral position adjustment for the steering angle sensor, when replacing the steering column assembly. Refer to [BRC-76, "ADJUSTMENT OF STEERING ANGLE SENSOR NEUTRAL POSITION: Special Repair Requirement"](#). (VDC models)

>> END

# U14FF VEHICLE SPEED SIGNAL (METER)

< COMPONENT DIAGNOSIS >

## U14FF VEHICLE SPEED SIGNAL (METER)

### Description

INFOID:000000001731534

EPS control unit receives the vehicle speed signal from combination meter via CAN communication line.

### DTC Logic

INFOID:000000001731535

### DTC DETECTION LOGIC

DTC	Display item	Malfunction detected condition	Possible cause
U14FF	CAN VHCL SPEED (METER)	Abnormal vehicle speed signals received via CAN communication are detected.	<ul style="list-style-type: none"><li>• Harness or connector</li><li>• CAN communication line</li><li>• EPS control unit</li><li>• Combination meter malfunction</li><li>- Vehicle speed signal error</li></ul>

### DTC CONFIRMATION PROCEDURE

#### 1. CHECK SELF-DIAGNOSIS RESULTS

Check the self-diagnosis results.

Self-diagnosis results
CAN VHCL SPEED (METER)

Is above displayed on the self-diagnosis display?

- YES >> Proceed to diagnosis procedure. Refer to [STC-16, "Diagnosis Procedure"](#).  
NO >> INSPECTION END

### Diagnosis Procedure

INFOID:000000001731536

#### 1. CHECK COMBINATION METER SYSTEM

Perform combination meter self-diagnosis. Repair or replace items indicated, then perform combination meter self-diagnosis again. Refer to [MWI-33, "CONSULT-III Function \(METER/M&A\)"](#).

Is any item indicated on the self-diagnosis display?

- YES >> Repair or replace malfunctioning components.  
NO >> GO TO 2.

#### 2. CHECK CONNECTOR

1. Turn ignition switch OFF.
2. Disconnect EPS control unit harness connector.
3. Check terminal for deformation, disconnection, looseness, and so on. If any malfunction is found, repair or replace terminal.
4. Reconnect connectors and then perform the self-diagnosis.

Is any item indicated on the self-diagnosis display?

- YES >> Replace EPS control unit. Refer to [STC-34, "Exploded View"](#).  
NO >> Poor connection of connector terminal. Repair or replace connector.

### Special Repair Requirement

INFOID:000000001731537

#### 1. ADJUSTMENT OF STEERING ANGLE SENSOR NEUTRAL POSITION

Always perform the neutral position adjustment for the steering angle sensor, when replacing the steering column assembly. Refer to [BRC-76, "ADJUSTMENT OF STEERING ANGLE SENSOR NEUTRAL POSITION : Special Repair Requirement"](#). (VDC models)

>> END



# U1000 CAN COMM CIRCUIT

< COMPONENT DIAGNOSIS >

## U1000 CAN COMM CIRCUIT

### Description

INFOID:000000001731538

CAN (Controller Area Network) is a serial communication line for real time application. It is an on-vehicle multiplex communication line with high data communication speed and excellent error detection ability. Many electronic control units are equipped onto a vehicle, and each control unit shares information and links with other control units during operation (not independent). In CAN communication, control units are connected with 2 communication lines (CAN-H line, CAN-L line) allowing a high rate of information transmission with less wiring. Each control unit transmits/receives data but selectively reads required data only.

### DTC Logic

INFOID:000000001731539

### DTC DETECTION LOGIC

DTC	Display item	Malfunction detected condition	Possible cause
U1000	CAN COMM CIRCUIT	When EPS control unit is not transmitting or receiving CAN communication signal for 2 seconds or more.	<ul style="list-style-type: none"><li>• Harness or connector</li><li>• CAN communication line</li><li>• EPS control unit</li></ul>

### DTC CONFIRMATION PROCEDURE

#### 1.CHECK SELF-DIAGNOSIS RESULTS

STC

Check the self-diagnosis results.

Self-diagnosis results
CAN COMM CIRCUIT

Is above displayed on the self-diagnosis display?

- YES >> Proceed to diagnosis procedure. Refer to [STC-17. "Diagnosis Procedure"](#).  
NO >> INSPECTION END

### Diagnosis Procedure

INFOID:000000001731540

#### 1.CHECK CONNECTOR

1. Turn ignition switch OFF.
2. Disconnect EPS control unit harness connector.
3. Check terminal for deformation, disconnection, looseness, and so on. If any malfunction is found, repair or replace terminal.
4. Reconnect connector and perform self-diagnosis.

Is above displayed on the self-diagnosis display?

- YES >> Go to [LAN-14. "Trouble Diagnosis Flow Chart"](#).  
NO >> INSPECTION END

### Special Repair Requirement

INFOID:000000001731541

#### 1.AJUSTMENT OF STEERING ANGLE SENSOR NEUTRAL POSITION

Always perform the neutral position adjustment for the steering angle sensor, when replacing the steering column assembly. Refer to [BRC-76. "ADJUSTMENT OF STEERING ANGLE SENSOR NEUTRAL POSITION: Special Repair Requirement"](#). (VDC models)

>> END

# EPS CONTROL UNIT

< ECU DIAGNOSIS >

## ECU DIAGNOSIS

### EPS CONTROL UNIT

#### Reference Value

INFOID:000000001731542

#### VALUES ON THE DIAGNOSIS TOOL

#### CAUTION:

The output signal indicates the EPS control unit calculation data. The normal values will be displayed even in the event that the output circuit (harness) is open.

Monitor item	Content	Condition	Display value	
BATTERY VOLT	Power supply voltage for EPS control unit	Ignition switch: ON	Battery voltage	
TORQUE SENSOR	Steering wheel turning force	Engine running	Steering wheel: Not steering (There is no steering force)	Approx. 0 Nm
			Steering wheel: Right turn	Negative value (Nm)
			Steering wheel: Left turn	Positive value (Nm)
MOTOR SIG	Command current to EPS motor	Engine running	Steering wheel: Not steering (There is no steering force)	Approx. 0 A
			Steering wheel: Right turn	Positive value (A)
			Steering wheel: Left turn	Negative value (A)
MOTOR CURRENT	Consumption current of EPS motor	Engine running	Steering wheel: Not steering (There is no steering force)	Approx. 0 A
			Steering wheel: Right turn	Positive value (A)
			Steering wheel: Left turn	Negative value (A)
ASSIST TORQUE	Displays assist torque being output by the EPS.	Engine running	Steering wheel: Not steering (There is no steering force)	Approx. 0 Nm
			Steering wheel: Right turn	Positive value (Nm)
			Steering wheel: Left turn	Negative value (Nm)
C/U TEMP	Displays temperature of the EPS control unit.	Ignition switch ON or engine running	Displays temperature of inside of EPS control unit (°C)	
ASSIST LEVEL	Assist available level	Engine running	100 % *2	
VEHICLE SPEED	Vehicle speed	Vehicle stopped	0 km/h (0 mph)	
		While driving	Approximately equal to the indication on speedometer (inside of ±10%)*3	
MOTOR TEMP	Displays temperature of EPS motor.	Engine running	Displays temperature of inside of EPS motor (°C)	
VHCL SPD CALC	Displays vehicle speeds used for controlling EPS.	Vehicle stopped	0 km/h (0 mph)	
		While driving	Approximately equal to the indication on speedometer (inside of ±10%)*3	
WARNING LAMP	EPS warning lamp condition	EPS warning lamp: ON	On	
		EPS warning lamp: OFF	Off	
ENGINE STATUS	Engine status	Engine not running	STOP, STALL, CRANK	
		Engine running	RUN	

\*1: Almost in accordance with the value of MOTOR SIG. It is not a malfunction though these values are not accorded when steering quickly.

# EPS CONTROL UNIT

## < ECU DIAGNOSIS >

\*2: Normally displays 100%. In case of an excessive stationary steering, the assist curvature gradually falls. However, it returns to 100% when left standing.

\*3: It is not a malfunction, though it might not be corresponding just after ignition switch in turned ON.

## TERMINAL LAYOUT

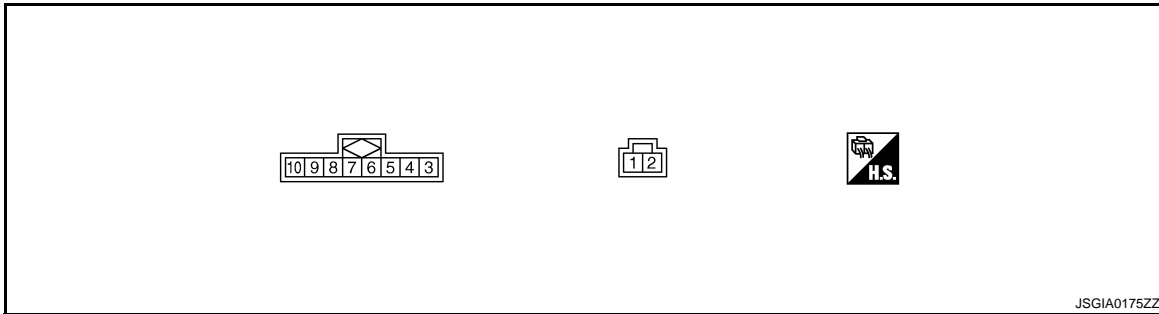

## PHYSICAL VALUES

Terminal No. (Wire Color)		Description		Condition	Value (Approx.)
+	-	Signal name	Input/Output		
1 (R)	Ground	Battery power supply	Input	Always	Battery voltage
2 (B)	Ground	Ground	Output	Always	0 V
3 (W)	Ground	Ignition power supply	Input	Ignition switch: ON	Battery voltage
				Ignition switch: OFF	0 V
5 (L)	Ground	CAN-H	Input/Output	—	—
7 (P)	Ground	CAN-L	Input/Output	—	—

# EPS CONTROL UNIT

< ECU DIAGNOSIS >

## Wiring Diagram - ELECTRONICALLY CONTROLLED POWER STEERING SYSTEM -

INFOID:000000001731543

### ELECTRONICALLY CONTROLLED POWER STEERING SYSTEM

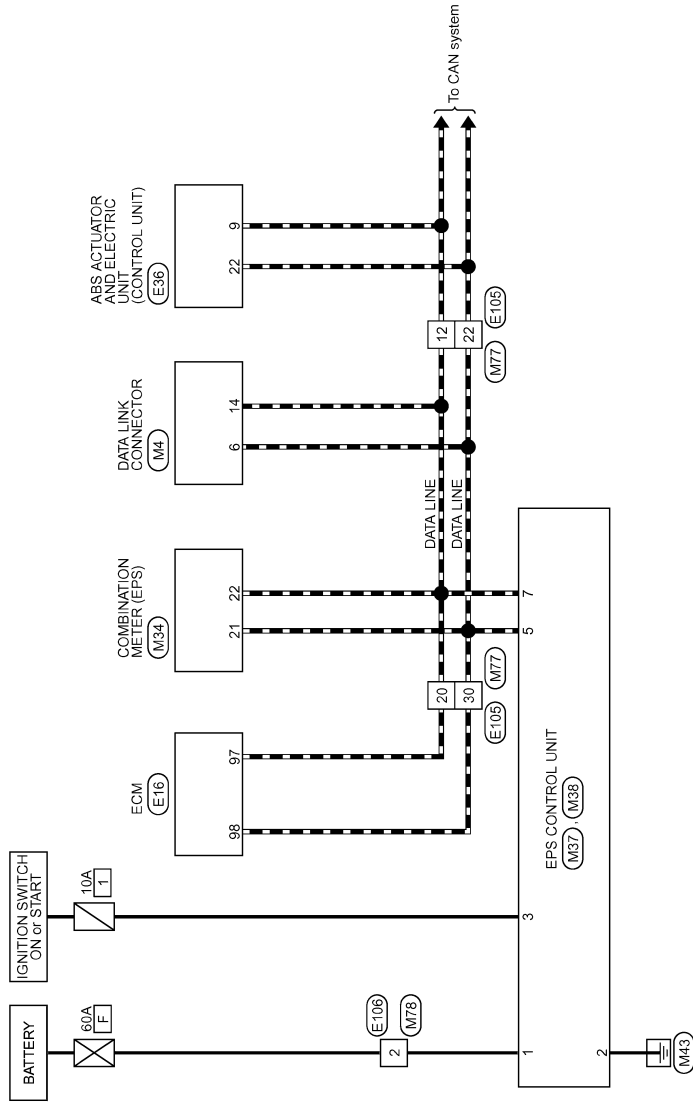

2007/07/13

JCGWM0061G

## ELECTRONICALLY CONTROLLED POWER STEERING SYSTEM

Connector No.	E16
Connector Name	ECM
Connector Type	MAA2FB-MEAS-RH

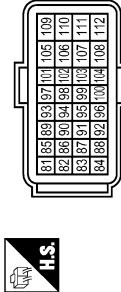

Terminal No.	Color of Wire	Signal Name [Specification]
97	P	VEHCAN-L
98	L	VEHCAN-H

Connector No.	E13
Connector Name	ABS ACTUATOR AND ELECTRIC UNIT (CONTROL UNIT)
Connector Type	RH28FB-TU04-DH

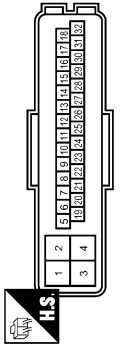

Terminal No.	Color of Wire	Signal Name [Specification]
9	P	CAN-L
22	L	CAN-H

Connector No.	E105
Connector Name	WIRE TO WIRE
Connector Type	TH60FW-C516-7M4

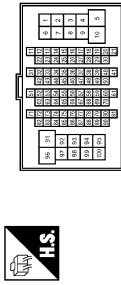

Terminal No.	Color of Wire	Signal Name [Specification]
12	P	-
20	P	-
22	L	-
30	L	-

Connector No.	E106
Connector Name	WIRE TO WIRE
Connector Type	L02FB-MC



Terminal No.	Color of Wire	Signal Name [Specification]
2	R	-

Connector No.	M4
Connector Name	DATA LINK CONNECTOR
Connector Type	BD18FW

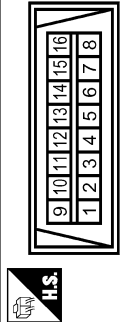

Terminal No.	Color of Wire	Signal Name [Specification]
6	L	-
14	P	-

Connector No.	M34
Connector Name	COMBINATION METER
Connector Type	SAB40FW

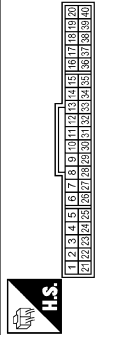

Terminal No.	Color of Wire	Signal Name [Specification]
21	L	CAN-H
22	P	CAN-L

Connector No.	M37
Connector Name	EPS CONTROL UNIT
Connector Type	Molex 98545-0001

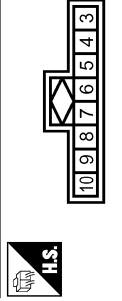

Terminal No.	Color of Wire	Signal Name [Specification]
3	W	-
5	L	-
7	P	-

Connector No.	M38
Connector Name	EPS CONTROL UNIT
Connector Type	ANA02FB

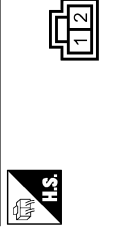

Terminal No.	Color of Wire	Signal Name [Specification]
1	R	-
2	B	-

A  
B  
C  
D  
E  
F  
STC  
H  
I  
J  
K  
L  
M  
N  
O  
P

# EPS CONTROL UNIT

## < ECU DIAGNOSIS >

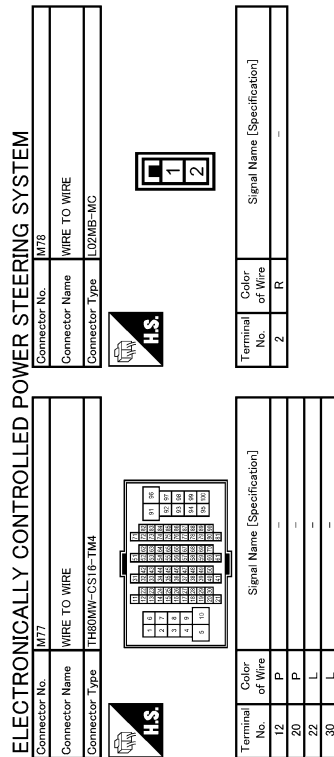

JCGWM0063G

INFOID:000000001731544

### Fail-Safe

- If any malfunction occurs in the system, and control unit detects the malfunction, EPS warning lamp on combination meter turns ON to indicate system malfunction.
- When EPS warning lamp is ON, enters into a manual steering state. (Control turning force steering wheel becomes heavy.)

# EPS CONTROL UNIT

< ECU DIAGNOSIS >

DTC No. Index

INFOID:000000001731545

DTC	Items (CONSULT screen terms)	Reference
C1601	BATTERY VOLT	<a href="#">STC-8, "DTC Logic"</a>
C1604	TORQUE SENSOR	<a href="#">STC-10, "DTC Logic"</a>
C1606	EPS MOTOR	<a href="#">STC-11, "DTC Logic"</a>
C1607	EEPROM	<a href="#">STC-12, "DTC Logic"</a>
C1608	CONTROL UNIT	<a href="#">STC-13, "DTC Logic"</a>
U1200	CAN VHCL SPEED (ABS)	<a href="#">STC-15, "DTC Logic"</a>
U14FF	CAN VHCL SPEED (METER)	<a href="#">STC-16, "DTC Logic"</a>
U1000	CAN COMM CIRCUIT	<a href="#">STC-17, "DTC Logic"</a>

A  
B  
C  
D  
E  
F  
H  
I  
J  
K  
L  
M  
N  
O  
P

**STC**

# EPS WARNING LAMP DOES NOT TURN ON

< SYMPTOM DIAGNOSIS >

---

## SYMPTOM DIAGNOSIS

### EPS WARNING LAMP DOES NOT TURN ON

#### Description

INFOID:000000003179397

- EPS warning lamp does not turn ON when turning ignition switch ON from OFF.

#### Diagnosis Procedure

INFOID:000000001731546

#### 1. CHECK SYSTEM FOR CAN COMMUNICATION LINE

---

Perform EPS control unit self-diagnosis.

Is the "CAN COMM CIRCUIT [U1000]" displayed?

- YES >> Perform trouble diagnosis for CAN communication line.
- NO >> GO TO 2.

#### 2. CHECK EPS CONTROL UNIT

---

Check EPS control unit input/output signal. Refer to [STC-18, "Reference Value"](#).

Is the inspection result normal?

- YES >> GO TO 3.
- NO >> Check EPS control unit pin terminals for damage or loose connection with harness connector. If any items are damaged, repair or replace damaged parts.

#### 3. CHECK COMBINATION METER SELF-DIAGNOSIS RESULTS

---

Perform combination meter self-diagnosis. Refer to [MWI-33, "CONSULT-III Function \(METER/M&A\)"](#).

is self-diagnosis results indicated?

- YES >> Repair or replace malfunctioning components.
- NO >> GO TO 4.

#### 4. SYMPTOM CHECK

---

Check again.

Is the inspection result normal?

- YES >> INSPECTION END
- NO >> Replace combination meter.



# EPS WARNING LAMP DOES NOT TURN OFF

< SYMPTOM DIAGNOSIS >

## EPS WARNING LAMP DOES NOT TURN OFF

### Description

INFOID:000000003179400

- EPS warning lamp does not turn OFF several seconds after engine started.

### Diagnosis Procedure

INFOID:000000001731547

#### 1. CHECK SELF-DIAGNOSIS RESULTS

Perform EPS control unit self-diagnosis.

Is any malfunction detected by self-diagnosis?

- YES >> Check the malfunctioning system.
- NO >> GO TO 2.

#### 2. CHECK EPS CONTROL UNIT POWER SUPPLY CIRCUIT

1. Turn ignition switch OFF.
2. Disconnect EPS control unit harness connector.
3. Turn ignition switch ON. (Do not start engine.)
4. Check voltage between EPS control unit harness connector terminals and ground.

EPS control unit		—	Voltage
Connector	Terminal		
M38	1	Ground	Battery voltage
M37	3		

5. Turn ignition switch OFF.
6. Check voltage between EPS control unit harness connector terminals and ground.

EPS control unit		—	Voltage
Connector	Terminal		
M38	1	Ground	Battery voltage
M37	3		Approx. 0 V

Is the inspection result normal?

- YES >> GO TO 3.
- NO >> Repair or replace malfunctioning components.

#### 3. CHECK EPS CONTROL UNIT GROUND CIRCUIT

1. Check continuity between EPS control unit harness connector terminal and ground.

EPS control unit		—	Continuity
Connector	Terminal		
M38	2	Ground	Existed

2. Connect EPS control unit harness connector.

Is the inspection result normal?

- YES >> GO TO 4.
- NO >> Repair open circuit or short to ground or short to power in harness or connectors.

#### 4. CHECK EPS CONTROL UNIT PIN TERMINAL

Check EPS control unit pin terminals for damage or loose connection with harness connector.

Is the inspection result normal?

- YES >> GO TO 5.
- NO >> Repair or replace damaged parts.

#### 5. CHECK COMBINATION METER SELF-DIAGNOSIS RESULTS

A  
B  
C  
D  
E  
F  
H  
I  
J  
K  
L  
M  
N  
O  
P

STC

# EPS WARNING LAMP DOES NOT TURN OFF

## < SYMPTOM DIAGNOSIS >

---

Perform combination meter self-diagnosis. Refer to [MWI-33, "CONSULT-III Function \(METER/M&A\)"](#).  
is self-diagnosis results indicated?

- YES >> Repair or replace malfunctioning components.  
NO >> GO TO 6.

## 6.CHECK VEHICLE SPEED SIGNAL FROM ABS ACTUATOR AND ELECTRIC UNIT (CONTROL UNIT)

---

Perform ABS actuator and electric unit (control unit) self-diagnosis.

- Without VDC: [BRC-15, "CONSULT-III Function"](#).
- With VDC: [BRC-94, "CONSULT-III Function"](#).

Is any malfunction detected by self-diagnosis?

- YES >> Check the malfunctioning system.  
NO >> GO TO 7.

## 7.CHECK ENGINE STATUS SIGNAL

---

Perform ECM self-diagnosis.

- For CALIFORNIA: [EC-105, "CONSULT-III Function"](#).
- For USA (FEDERAL) and CANADA: [EC-572, "CONSULT-III Function"](#).
- For MEXICO: [EC-996, "CONSULT-III Function"](#).

Is the malfunction detected by self-diagnosis?

- YES >> Check the malfunctioning system.  
NO >> GO TO 8.

## 8.SYMPTOM CHECK

---

Check again.

Is the inspection result normal?

- YES >> INSPECTION END  
NO >> Replace combination meter. Refer to [MWI-83, "Exploded View"](#).

# STEERING WHEEL TURNING FORCE IS HEAVY OR LIGHT

< SYMPTOM DIAGNOSIS >

## STEERING WHEEL TURNING FORCE IS HEAVY OR LIGHT

### Diagnosis Procedure

INFOID:000000001731548

#### 1. CHECK SYSTEM FOR CAN COMMUNICATION LINE

Perform EPS control unit self-diagnosis.

Is the "CAN COMM CIRCUIT [U1000]" displayed.

- YES >> Perform trouble diagnosis for CAN communication line. Refer to [STC-17, "Description"](#).
- NO >> GO TO 2.

#### 2. CHECK VEHICLE SPEED SIGNAL FROM ABS ACTUATOR AND ELECTRIC UNIT (CONTROL UNIT)

Perform ABS actuator and electric unit (control unit) self-diagnosis.

- Without VDC: [BRC-15, "CONSULT-III Function"](#).
- With VDC: [BRC-94, "CONSULT-III Function"](#).

Is any malfunction detected by self-diagnosis?

- YES >> Check the malfunctioning system.
- NO >> GO TO 3.

#### 3. CHECK COMBINATION METER SIGNAL

Perform combination meter self-diagnosis. Refer to [MWI-33, "CONSULT-III Function \(METER/M&A\)"](#).

Is the malfunction detected by self-diagnosis?

- YES >> Check the malfunctioning system.
- NO >> GO TO 4.

#### 4. CHECK ENGINE STATUS SIGNAL

Perform ECM self-diagnosis.

- For CALIFORNIA: [EC-105, "CONSULT-III Function"](#).
- For USA (FEDERAL) and CANADA: [EC-572, "CONSULT-III Function"](#).
- For MEXICO: [EC-996, "CONSULT-III Function"](#).

Is the malfunction detected by self-diagnosis?

- YES >> Check the malfunctioning system.
- NO >> GO TO 5.

#### 5. CHECK EPS CONTROL UNIT

Check EPS control unit input/output signal. Refer to [STC-18, "Reference Value"](#).

Is the inspection result normal?

- YES >> GO TO 6.
- NO >> Check EPS control unit pin terminals for damage or loose connection with harness connector. If any items are damaged, repair or replace damaged parts.

#### 6. CHECK STEERING WHEEL TURNING FORCE

Check steering wheel turning force. Refer to [ST-8, "Inspection"](#).

Is the inspection result normal?

- YES >> GO TO 7.
- NO >> Repair or replace malfunctioning components.

#### 7. SYMPTOM CHECK

Check again.

Is the inspection result normal?

- YES >> INSPECTION END
- NO >> Check the steering wheel turning force for mechanical malfunction. Refer to [ST-8, "Inspection"](#).

A  
B  
C  
D  
E  
F  
H  
I  
J  
K  
L  
M  
N  
O  
P

STC

# UNBALANCE STEERING WHEEL TURNING FORCE AND RETURN BETWEEN RIGHT AND LEFT

< SYMPTOM DIAGNOSIS >

## UNBALANCE STEERING WHEEL TURNING FORCE AND RETURN BETWEEN RIGHT AND LEFT

### Diagnosis Procedure

INFOID:000000001731549

#### 1.CHECK EPS WARNING LAMP

Confirm EPS warning lamp during engine running.

Does EPS warning lamp turn OFF?

YES >> GO TO 2.

NO >> Go to [STC-25, "Diagnosis Procedure"](#).

#### 2.CHECK WHEEL ALIGNMENT

Check wheel alignment. Refer to [FSU-8, "Inspection"](#).

Is the inspection result normal?

YES >> GO TO 3.

NO >> Adjust wheel alignment. Refer to [FSU-8, "Inspection"](#).

#### 3.CHECK EPS CONTROL UNIT

Check EPS control unit input/output signal. Refer to [STC-18, "Reference Value"](#).

Is the inspection result normal?

YES >> GO TO 4.

NO >> Check EPS control unit pin terminals for damage or loose connection with harness connector. If any items are damaged, repair or replace damaged parts.

#### 4.CHECK STEERING WHEEL TURNING FORCE

Check steering wheel turning force. Refer to [ST-8, "Inspection"](#).

Is the inspection result normal?

YES >> GO TO 5.

NO >> Repair or replace malfunctioning components.

#### 5.SYMPTOM CHECK

Check again.

Is the inspection result normal?

YES >> INSPECTION END

NO >> Check the steering wheel turning force for mechanical malfunction. Refer to [ST-8, "Inspection"](#).

# UNBALANCE STEERING WHEEL TURNING FORCE (TORQUE VARIATION)

< SYMPTOM DIAGNOSIS >

## UNBALANCE STEERING WHEEL TURNING FORCE (TORQUE VARIATION)

### Diagnosis Procedure

INFOID:000000001731550

#### 1. CHECK EPS WARNING LAMP

Confirm EPS warning lamp during engine running.

Does EPS warning lamp turn OFF?

YES >> GO TO 2.

NO >> Go to [STC-25, "Diagnosis Procedure"](#).

#### 2. CHECK STEERING COLUMN INTERMEDIATE SHAFT

Check the connection between intermediate shaft and the mounting part of steering column assembly and steering gear assembly. Refer to [ST-11, "Exploded View"](#).

Is the inspection result normal?

YES >> GO TO 3.

NO >> Repair or replace damaged parts.

#### 3. CHECK EPS CONTROL UNIT

Check EPS control unit input/output signal. Refer to [STC-18, "Reference Value"](#).

Is the inspection result normal?

YES >> GO TO 4.

NO >> Check EPS control unit pin terminals for damage or loose connection with harness connector. If any items are damaged, repair or replace damaged parts.

#### 4. SYMPTOM CHECK

Check again.

Is the inspection result normal?

YES >> INSPECTION END

NO >> Check the steering wheel turning force for mechanical malfunction. Refer to [ST-8, "Inspection"](#).

A  
B  
C  
D  
E  
F  
H  
I  
J  
K  
L  
M  
N  
O  
P

STC

# PRECAUTIONS

< PRECAUTION >

## PRECAUTION

### PRECAUTIONS

#### FOR USA AND CANADA

#### FOR USA AND CANADA : Precaution for Supplemental Restraint System (SRS) "AIR BAG" and "SEAT BELT PRE-TENSIONER"

INFOID:000000003248983

The Supplemental Restraint System such as "AIR BAG" and "SEAT BELT PRE-TENSIONER", used along with a front seat belt, helps to reduce the risk or severity of injury to the driver and front passenger for certain types of collision. This system includes seat belt switch inputs and dual stage front air bag modules. The SRS system uses the seat belt switches to determine the front air bag deployment, and may only deploy one front air bag, depending on the severity of a collision and whether the front occupants are belted or unbelted.

Information necessary to service the system safely is included in the "SRS AIRBAG" and "SEAT BELT" of this Service Manual.

#### **WARNING:**

- **To avoid rendering the SRS inoperative, which could increase the risk of personal injury or death in the event of a collision which would result in air bag inflation, all maintenance must be performed by an authorized NISSAN/INFINITI dealer.**
- **Improper maintenance, including incorrect removal and installation of the SRS, can lead to personal injury caused by unintentional activation of the system. For removal of Spiral Cable and Air Bag Module, see the "SRS AIRBAG".**
- **Do not use electrical test equipment on any circuit related to the SRS unless instructed to in this Service Manual. SRS wiring harnesses can be identified by yellow and/or orange harnesses or harness connectors.**

#### FOR USA AND CANADA : Precaution Necessary for Steering Wheel Rotation After Battery Disconnect

INFOID:000000003302795

#### **NOTE:**

- This Procedure is applied only to models with Intelligent Key system and NVIS/IVIS (NISSAN/INFINITI VEHICLE IMMOBILIZER SYSTEM - NATS).
- Remove and install all control units after disconnecting both battery cables with the ignition knob in the "LOCK" position.
- Always use CONSULT-III to perform self-diagnosis as a part of each function inspection after finishing work. If DTC is detected, perform trouble diagnosis according to self-diagnostic results.

For models equipped with the Intelligent Key system and NVIS/IVIS, an electrically controlled steering lock mechanism is adopted on the key cylinder.

For this reason, if the battery is disconnected or if the battery is discharged, the steering wheel will lock and steering wheel rotation will become impossible.

If steering wheel rotation is required when battery power is interrupted, follow the procedure below before starting the repair operation.

#### OPERATION PROCEDURE

1. Connect both battery cables.

#### **NOTE:**

Supply power using jumper cables if battery is discharged.

2. Use the Intelligent Key or mechanical key to turn the ignition switch to the "ACC" position. At this time, the steering lock will be released.
3. Disconnect both battery cables. The steering lock will remain released and the steering wheel can be rotated.
4. Perform the necessary repair operation.
5. When the repair work is completed, return the ignition switch to the "LOCK" position before connecting the battery cables. (At this time, the steering lock mechanism will engage.)
6. Perform a self-diagnosis check of all control units using CONSULT-III.

#### FOR USA AND CANADA : Service Notice or Precautions for EPS System

INFOID:000000001731553

#### **CAUTION:**

# PRECAUTIONS

## < PRECAUTION >

Check the following item when performing the trouble diagnosis.

- Check any possible causes by interviewing the symptom and it's condition from the customer if any malfunction, such as EPS warning lamp is turned ON, occurs.
- Check if air pressure and size of tires are proper, the specified part is used for the steering wheel, and control unit is genuine part.
- Check if the connection of steering column assembly and steering gear assembly is proper (there is no looseness of mounting bolts, damage of rods, boots or sealants, and leakage of grease, etc).
- Check if the wheel alignment is adjusted properly.
- Check if there is any damage or modification to suspension or body resulting in increased weight or altered ground clearance.
- Check if installation conditions of each link and suspension are proper.
- Check if the battery voltage is proper.
- Check connection conditions of each connector are proper.
- Before connecting or disconnecting the EPS control unit harness connector, turn ignition switch "OFF" and disconnect battery ground cable. Because battery voltage is applied to EPS control unit even if ignition switch is turned "OFF".

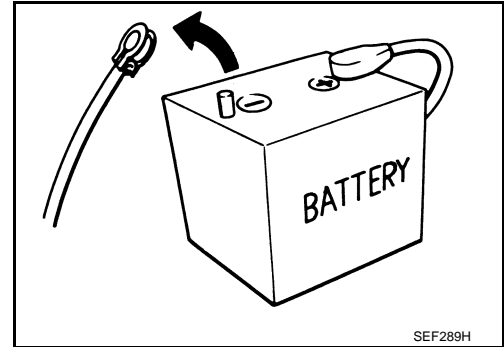

- When connecting or disconnecting pin connectors into or from EPS control unit, take care not to damage pin terminals (bend or break).  
When connecting pin connectors, make sure that there are no bends or breaks on EPS control unit pin terminal.

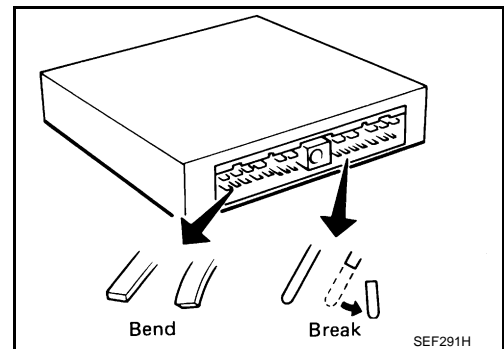

## EXCEPT FOR MEXICO

### EXCEPT FOR MEXICO : Precaution for Supplemental Restraint System (SRS) "AIR BAG" and "SEAT BELT PRE-TENSIONER"

INFOID:000000003248984

The Supplemental Restraint System such as "AIR BAG" and "SEAT BELT PRE-TENSIONER", used along with a front seat belt, helps to reduce the risk or severity of injury to the driver and front passenger for certain types of collision. Information necessary to service the system safely is included in the "SRS AIRBAG" and "SEAT BELT" of this Service Manual.

#### **WARNING:**

- To avoid rendering the SRS inoperative, which could increase the risk of personal injury or death in the event of a collision which would result in air bag inflation, all maintenance must be performed by an authorized NISSAN/INFINITI dealer.
- Improper maintenance, including incorrect removal and installation of the SRS, can lead to personal injury caused by unintentional activation of the system. For removal of Spiral Cable and Air Bag Module, see the "SRS AIRBAG".
- Do not use electrical test equipment on any circuit related to the SRS unless instructed to in this Service Manual. SRS wiring harnesses can be identified by yellow and/or orange harnesses or harness connectors.

### EXCEPT FOR MEXICO : Precaution Necessary for Steering Wheel Rotation After Bat-

# PRECAUTIONS

< PRECAUTION >

## Battery Disconnect

INFOID:000000003302796

### NOTE:

- This Procedure is applied only to models with Intelligent Key system and NVIS/IVIS (NISSAN/INFINITI VEHICLE IMMOBILIZER SYSTEM - NATS).
- Remove and install all control units after disconnecting both battery cables with the ignition knob in the "LOCK" position.
- Always use CONSULT-III to perform self-diagnosis as a part of each function inspection after finishing work. If DTC is detected, perform trouble diagnosis according to self-diagnostic results.

For models equipped with the Intelligent Key system and NVIS/IVIS, an electrically controlled steering lock mechanism is adopted on the key cylinder.

For this reason, if the battery is disconnected or if the battery is discharged, the steering wheel will lock and steering wheel rotation will become impossible.

If steering wheel rotation is required when battery power is interrupted, follow the procedure below before starting the repair operation.

### OPERATION PROCEDURE

1. Connect both battery cables.

#### NOTE:

Supply power using jumper cables if battery is discharged.

2. Use the Intelligent Key or mechanical key to turn the ignition switch to the "ACC" position. At this time, the steering lock will be released.
3. Disconnect both battery cables. The steering lock will remain released and the steering wheel can be rotated.
4. Perform the necessary repair operation.
5. When the repair work is completed, return the ignition switch to the "LOCK" position before connecting the battery cables. (At this time, the steering lock mechanism will engage.)
6. Perform a self-diagnosis check of all control units using CONSULT-III.

### EXCEPT FOR MEXICO : Service Notice or Precautions for EPS System

INFOID:000000003248982

### CAUTION:

Check the following item when performing the trouble diagnosis.

- Check any possible causes by interviewing the symptom and it's condition from the customer if any malfunction, such as EPS warning lamp is turned ON, occurs.
- Check if air pressure and size of tires are proper, the specified part is used for the steering wheel, and control unit is genuine part.
- Check if the connection of steering column assembly and steering gear assembly is proper (there is no looseness of mounting bolts, damage of rods, boots or sealants, and leakage of grease, etc).
- Check if the wheel alignment is adjusted properly.
- Check if there is any damage or modification to suspension or body resulting in increased weight or altered ground clearance.
- Check if installation conditions of each link and suspension are proper.
- Check if the battery voltage is proper.
- Check connection conditions of each connector are proper.
- Before connecting or disconnecting the EPS control unit harness connector, turn ignition switch "OFF" and disconnect battery ground cable. Because battery voltage is applied to EPS control unit even if ignition switch is turned "OFF".

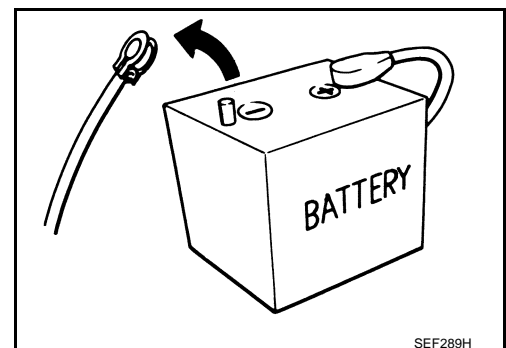

SEF289H



# PRECAUTIONS

## < PRECAUTION >

- When connecting or disconnecting pin connectors into or from EPS control unit, take care not to damage pin terminals (bend or break).  
When connecting pin connectors, make sure that there are no bends or breaks on EPS control unit pin terminal.

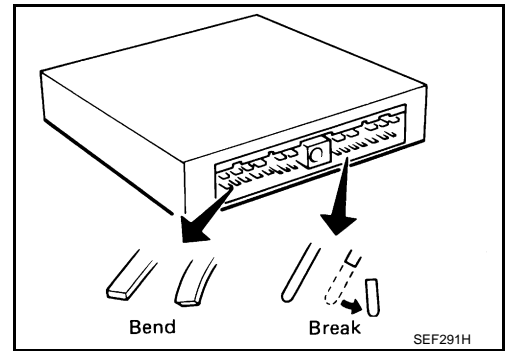

A  
B  
C  
D  
E  
F  
H  
I  
J  
K  
L  
M  
N  
O  
P

STC

# EPS CONTROL UNIT

< ON-VEHICLE REPAIR >

## ON-VEHICLE REPAIR

### EPS CONTROL UNIT

#### Exploded View

INFOID:000000003142943

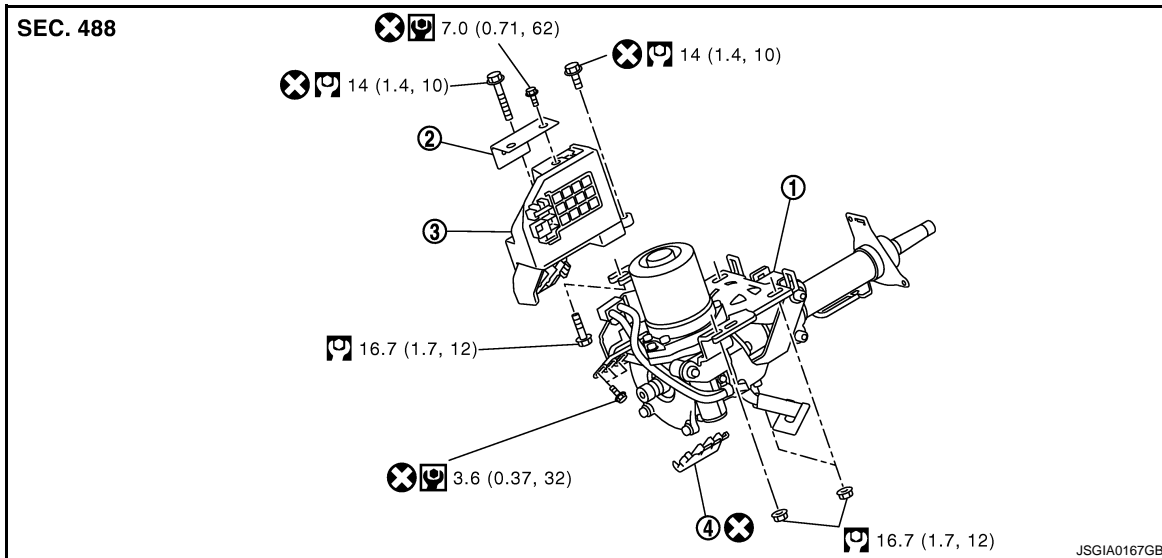

1. Steering column assembly
2. Harness bracket
3. EPS control unit
4. Harness cover

Refer to [GI-4, "Components"](#) for symbols in the figure.

#### Removal and Installation

INFOID:000000003142944

##### REMOVAL

###### CAUTION:

- Disconnect battery negative terminal before starting operations.
- Never shock EPS control unit, e.g. drop or hit.
- Never get EPS control unit wet with water or other liquid. Also, do not give EPS control unit a radical temperature change to avoid getting water drops.
- Never disassemble or remodel EPS control unit, EPS motor, torque sensor, harness and connectors.

1. Remove steering column assembly. Refer to [ST-11, "Exploded View"](#).
2. Remove harness bracket.
3. Disconnect EPS motor and torque sensor connectors.

###### CAUTION:

Hold and pull the connector housing, not pulling harness, when disconnecting connectors. Also, do not grip, collapse or apply excessive force to the connector.

4. Remove harness cover.
5. Disconnect EPS control unit connectors.
6. Remove EPS control unit.

##### INSTALLATION

Note the following, and install in the reverse order of removal.

## EPS CONTROL UNIT

### < ON-VEHICLE REPAIR >

- Check the order of cable colors, red (A), black (B) and white (C), when connecting harness terminals.
- Check that harness is not damaged when installing EPS control unit. Also, check that EPS control unit is installed without trapping harness or foreign materials.
- Repeat the following operations three times without touching steering wheels (input torque = 0) after replacing EPS control unit:  
Turn the key switch ON and wait for 3 seconds ⇒ Turn the key switch OFF and wait for 3 seconds.

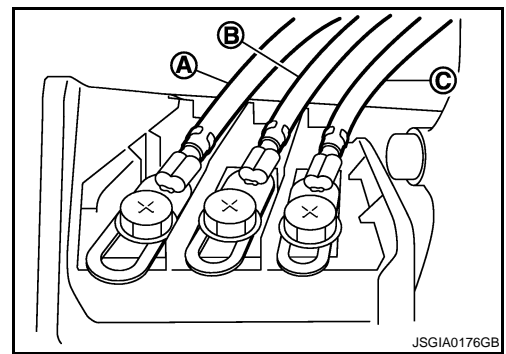

A

B

C

D

E

F

STC

H

I

J

K

L

M

N

O

P