

SECTION **SBC**

SEAT BELT CONTROL SYSTEM

A
B
C
D
E
F
G
SBC
I
J
K
L
M
N
O
P

CONTENTS

<p>BASIC INSPECTION 3</p> <p>DIAGNOSIS AND REPAIR WORKFLOW 3</p> <p style="padding-left: 20px;">Work Flow3</p> <p>FUNCTION DIAGNOSIS 6</p> <p>SEAT BELT TENSION REDUCER SYSTEM 6</p> <p style="padding-left: 20px;">System Diagram6</p> <p style="padding-left: 20px;">System Description6</p> <p style="padding-left: 20px;">Component Parts Location7</p> <p style="padding-left: 20px;">Component Description7</p> <p>PRE-CRASH SEAT BELT SYSTEM 8</p> <p style="padding-left: 20px;">System Diagram8</p> <p style="padding-left: 20px;">System Description8</p> <p style="padding-left: 20px;">Component Parts Location10</p> <p style="padding-left: 20px;">Component Description10</p> <p>ON BOARD DIAGNOSTIC (OBD) SYSTEM11</p> <p style="padding-left: 20px;">Diagnosis Description11</p> <p style="padding-left: 20px;">CONSULT-III Function11</p> <p>COMPONENT DIAGNOSIS13</p> <p>U1000 CAN COMM CIRCUIT13</p> <p style="padding-left: 20px;">Description13</p> <p style="padding-left: 20px;">DTC Logic13</p> <p>B2451 SB MOTOR RH CIRC14</p> <p style="padding-left: 20px;">Description14</p> <p style="padding-left: 20px;">DTC Logic14</p> <p style="padding-left: 20px;">Diagnosis Procedure14</p> <p style="padding-left: 20px;">Component Inspection14</p> <p>B2452 SB MOTOR LH CIRC16</p> <p style="padding-left: 20px;">Description16</p> <p style="padding-left: 20px;">DTC Logic16</p> <p style="padding-left: 20px;">Diagnosis Procedure16</p> <p style="padding-left: 20px;">Component Inspection16</p> <p>B2453 BR STROK SEN CIRC18</p>	<p style="padding-left: 20px;">Description18</p> <p style="padding-left: 20px;">DTC Logic18</p> <p style="padding-left: 20px;">Diagnosis Procedure18</p> <p style="padding-left: 20px;">Component Inspection19</p> <p>B2454 MOTOR PWR SUP CIRC20</p> <p style="padding-left: 20px;">Description20</p> <p style="padding-left: 20px;">DTC Logic20</p> <p style="padding-left: 20px;">Diagnosis Procedure20</p> <p>B2455 PSB C/U INT CIRCUIT21</p> <p style="padding-left: 20px;">Description21</p> <p style="padding-left: 20px;">DTC Logic21</p> <p>BRAKE PEDAL STROKE SENSOR SHIELD WIRE CIRCUIT CHECK22</p> <p style="padding-left: 20px;">Description22</p> <p style="padding-left: 20px;">Component Function Check22</p> <p>SEAT BELT BUCKLE SWITCH (DRIVER SIDE) CIRCUIT CHECK23</p> <p style="padding-left: 20px;">Description23</p> <p style="padding-left: 20px;">Component Function Check23</p> <p style="padding-left: 20px;">Component Inspection (Driver seat belt buckle switch)23</p> <p style="padding-left: 20px;">Component Inspection (Driver seat belt buckle switch ground circuit)24</p> <p>SEAT BELT BUCKLE SWITCH (PASSENGER SIDE) CIRCUIT CHECK25</p> <p style="padding-left: 20px;">Description25</p> <p style="padding-left: 20px;">Component Function Check25</p> <p style="padding-left: 20px;">Component Inspection (Passenger seat belt buckle switch)25</p> <p style="padding-left: 20px;">Component Inspection (Passenger seat belt side buckle switch ground circuit)26</p> <p>IGNITION POWER SUPPLY CIRCUIT CHECK27</p> <p style="padding-left: 20px;">Description27</p> <p style="padding-left: 20px;">Component Function Check27</p>
--	--

PRE-CRASH SEAT BELT CONTROL UNIT		PRECAUTION	37
GROUND CIRCUIT CHECK	28	PRECAUTIONS	37
Description	28	Precaution for Supplemental Restraint System (SRS) "AIR BAG" and "SEAT BELT PRE-TENSIONER"	37
Component Function Check	28	Precaution for Seat Belt Service	37
ECU DIAGNOSIS	29	Precaution for Battery Service	38
PRE-CRASH SEAT BELT CONTROL UNIT	29	ON-VEHICLE MAINTENANCE	39
Reference Value	29	BRAKE PEDAL STROKE SENSOR	39
Fail Safe	30	Exploded View	39
DTC Index	30	Removal and Installation	39
Wiring Diagram - SEAT BELT CONTROL SYSTEM -	31	PRE-CRASH SEAT BELT CONTROL UNIT	40
SYMPTOM DIAGNOSIS	36	Exploded View	40
PRE-CRASH SEAT BELT SYSTEM	36	Removal and Installation	40
Description	36		
Symptom Table	36		

DIAGNOSIS AND REPAIR WORKFLOW

< BASIC INSPECTION >

BASIC INSPECTION

DIAGNOSIS AND REPAIR WORKFLOW

Work Flow

INFOID:000000001711963

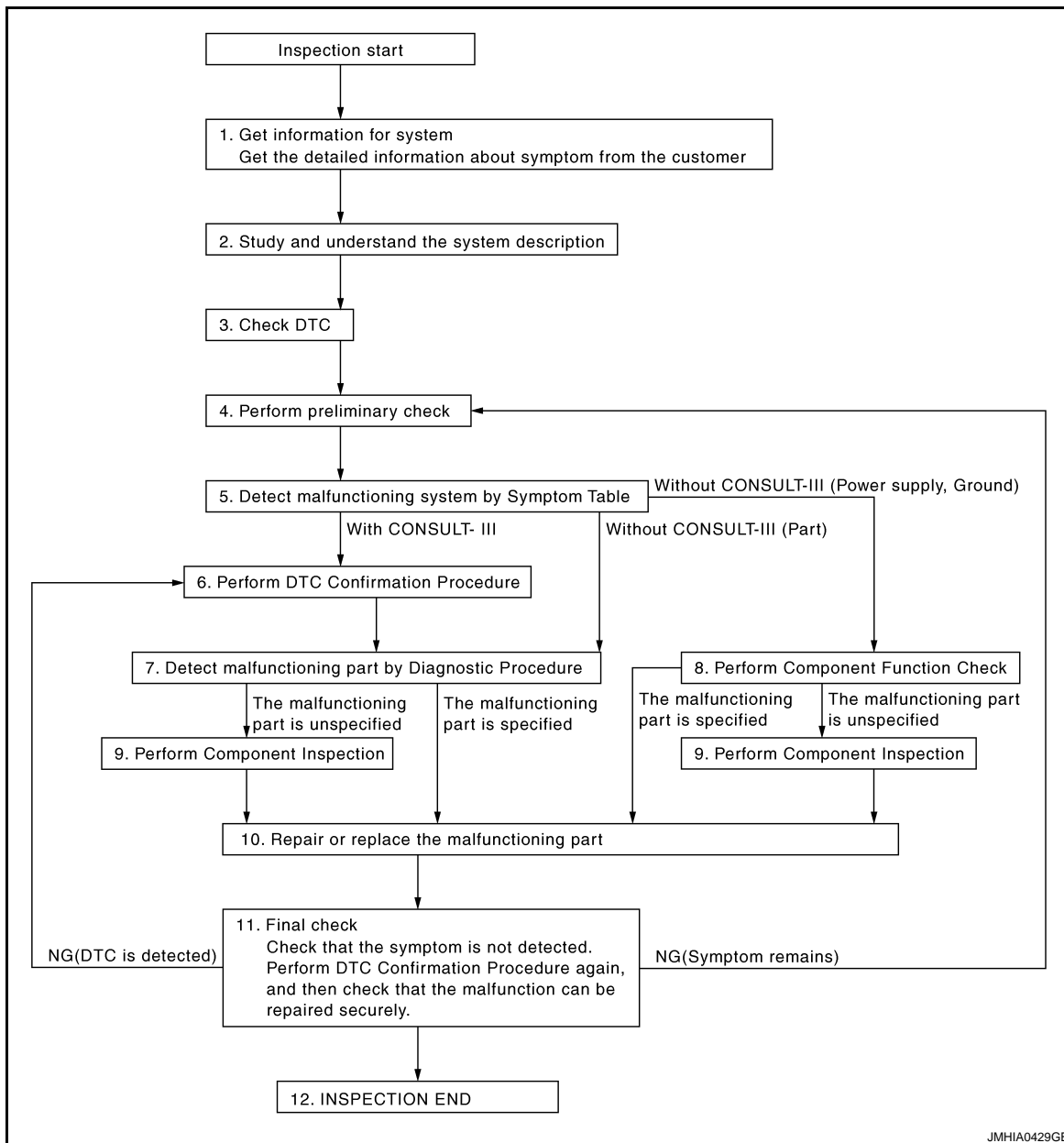

1.GET INFORMATION FOR SYSTEM

Interview the customer to obtain the malfunction information (conditions and environment when the malfunction occurred) as much as possible when the customer brings the vehicles in.

>> GO TO 2.

2.STUDY AND UNDERSTAND THE SYSTEM DESCRIPTION

Understand the operation condition or non-operation condition of pre-crash seat belt. Refer to [SBC-8. "System Description"](#).

>> GO TO 3.

DIAGNOSIS AND REPAIR WORKFLOW

< BASIC INSPECTION >

3. CHECK DTC

Perform "Self-diagnosis procedure" of appropriate DTC to check if DTC is detected again.

At this time, always connect CONSULT-III to the vehicle, and then check the diagnosis results in real time on "DATA MONITOR (AUTO RECORD)".

There is no priority for each DTC. Record them based on the following rules.

Current malfunction: Record all DTCs detected.

Past malfunction: Record up to 5 DTCs. When the 6th DTC is detected, it is overwritten to the last recorded DTC.

Is DTC detected?

YES >> GO TO 4.

NO >> Follow the diagnosis simulation test to check. Refer to [GI-38, "Intermittent Incident"](#).

4. PERFORM PRELIMINARY CHECK

Perform Pre-Diagnosis Inspection. Refer to [SBC-36, "Description"](#).

>> GO TO 5.

5. DETECT MALFUNCTIONING SYSTEM BY SYMPTOM TABLE

Identify the malfunctioning system with "Diagnosis Chart by Symptom". Refer to [SBC-36, "Description"](#).

With CONSULT-III >> GO TO 6.

Without CONSULT-III >> GO TO 7 (Parts system).

Without CONSULT-III >> GO TO 8 (Power supply, ground system).

6. PERFORM DTC CONFIRMATION PROCEDURE

Perform the inspection with "DTC REPRODUCTION PROCEDURE" of the applicable system.

>> GO TO 7.

7. DETECT MALFUNCTIONING PART BY DIAGNOSTIC PROCEDURE

Identify the malfunctioning part with "Diagnosis Procedure".

Are malfunctioning parts detected?

YES >> GO TO 10.

NO >> GO TO 9.

8. PERFORM COMPONENT FUNCTION CHECK

Identify the malfunctioning part with "Component Parts Function Inspection".

Are malfunctioning parts detected?

YES >> GO TO 10.

NO >> GO TO 9.

9. PERFORM COMPONENT INSPECTION

Perform the inspection with "Component Parts Inspection".

>> GO TO 10.

10. REPAIR OR REPLACE THE MALFUNCTIONING PART

Repair or replace the specified malfunctioning parts.

After repairing or replacing, reconnect parts or connector disconnected in "Diagnosis Procedure", and then erase DTC if necessary. Refer to [SBC-11, "Diagnosis Description"](#).

>> GO TO 11.

11. FINAL CHECK

Perform "CONSULT-III function" again to check that the repair is performed correctly.

DIAGNOSIS AND REPAIR WORKFLOW

< BASIC INSPECTION >

Check that malfunctions are not reproduced when obtaining the malfunction information from the customer, referring to the symptom inspection result in step 4.

Are all malfunctions corrected?

YES >> • Before delivering the vehicle to the customer, check that that DTC is erased.

• **INSPECTION END.**

NO >> DTC is reproduced: GO TO 6.

A

B

C

D

E

F

G

SBC

I

J

K

L

M

N

O

P

SEAT BELT TENSION REDUCER SYSTEM

< FUNCTION DIAGNOSIS >

FUNCTION DIAGNOSIS

SEAT BELT TENSION REDUCER SYSTEM

System Diagram

INFOID:000000001711964

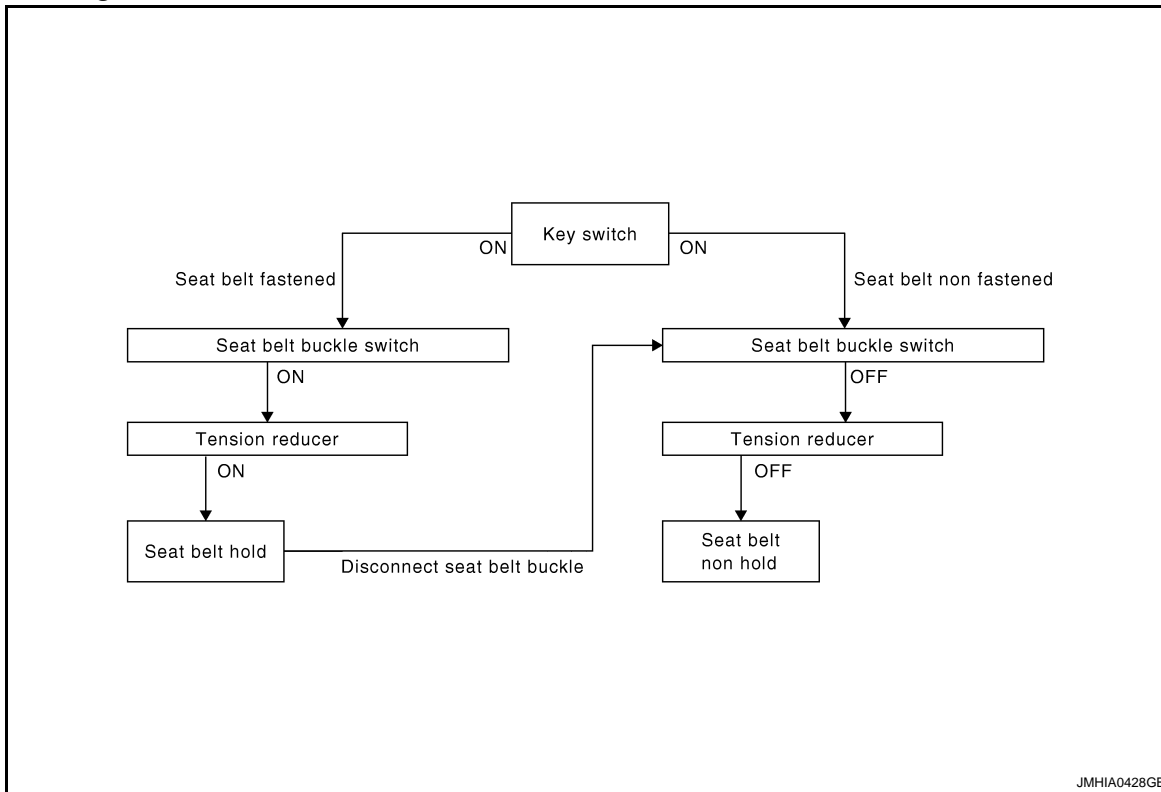

JMHIA0428GB

System Description

INFOID:000000001711965

- The seat belt tension reducer is adopted as the standard for front seat of all models.
- During seat belt tension reducer operation, the tension reducer reduces the retracting force of the spring in the seat belt to decrease the feeling of pressure.

OPERATION DESCRIPTION

- When turning the ignition switch to ON, the power is supplied to the front seat tension reducer terminal 1.
- When fastening the seat belt (turning the seat belt buckle switch to ON) with ignition switch ON, the power is grounded from front seat tension reducer terminal 2 to front seat belt buckle switch terminal 3, and seat belt buckle switch terminal 2 via seat belt buckle switch. Then, the tension reducer is turned to ON to hold the belt.
- When releasing the seat belt (turning the seat belt buckle switch to OFF), the circuit is not grounded. The tension reducer is turned to OFF, and then the belt is not held.

SEAT BELT TENSION REDUCER SYSTEM

< FUNCTION DIAGNOSIS >

Component Parts Location

INFOID:000000001711966

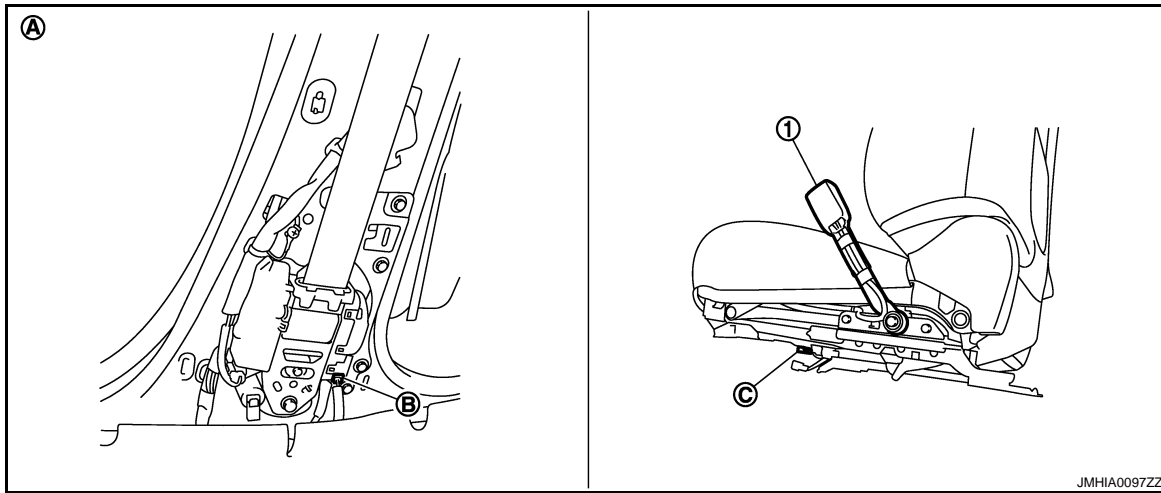

1. Seat belt buckle
 A. Back of center pillar lower garnish B. Tension reducer connector C. Seat belt buckle switch connector

Component Description

INFOID:000000001711967

Component	Function
Seat belt buckle switch	Perform the control of tension reducer according to the seat belt buckle switch ON/OFF in the seat belt buckle.
Tension reducer	When the seat belt buckle switch is turned ON, the tension reducer in the tension reducer seat belt is turned ON. It reduces the retracting force for seat belt.

SBC

I
J
K
L
M
N
O
P

PRE-CRASH SEAT BELT SYSTEM

< FUNCTION DIAGNOSIS >

PRE-CRASH SEAT BELT SYSTEM

System Diagram

INFOID:000000001711968

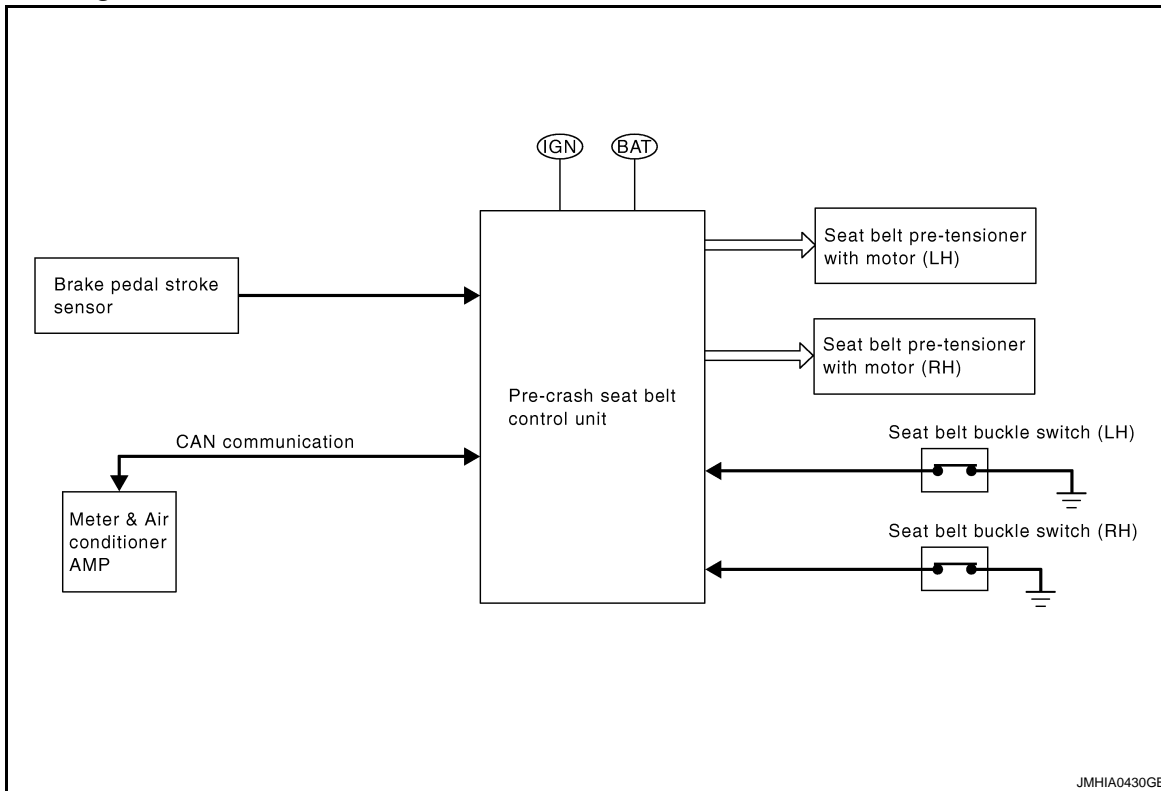

System Description

INFOID:000000001711969

- Pre-crash seat belt has been adopted to RH/LH seat belts.
- When the pre-crash seat belt control unit judges the emergency braking operation, the motor built into the pre-crash seat belt retract the shoulder belt to protect the passenger in case of collision, also give a sense of security.

FUNCTION DESCRIPTION

Operation Condition

- Pre-crash seat belt operates under the following conditions.

Condition	<ul style="list-style-type: none"> • During emergency brake operation • When operation prohibition condition is not satisfied
-----------	---

Operation Prohibition Condition

- Pre-crash seat belt does not operate under the following conditions.

Condition	<ul style="list-style-type: none"> • When seat belt is not fastened (Only the seat belt that is not fastened does not operate) • When the vehicle speed is 15 km/h or less • When pre-crash seat belt continuously operates 3 times or more *1 • At fail-safe condition *2
-----------	--

*1: When pre-crash seat belt does not operate after it continuously operates 3 times or more, operation can be performed again by stopping operation for approximately 7 minutes.

*2: Refer to [SBC-30. "Fail Safe"](#) for details of fail-safe mode.

PRE-CRASH SEAT BELT SYSTEM

< FUNCTION DIAGNOSIS >

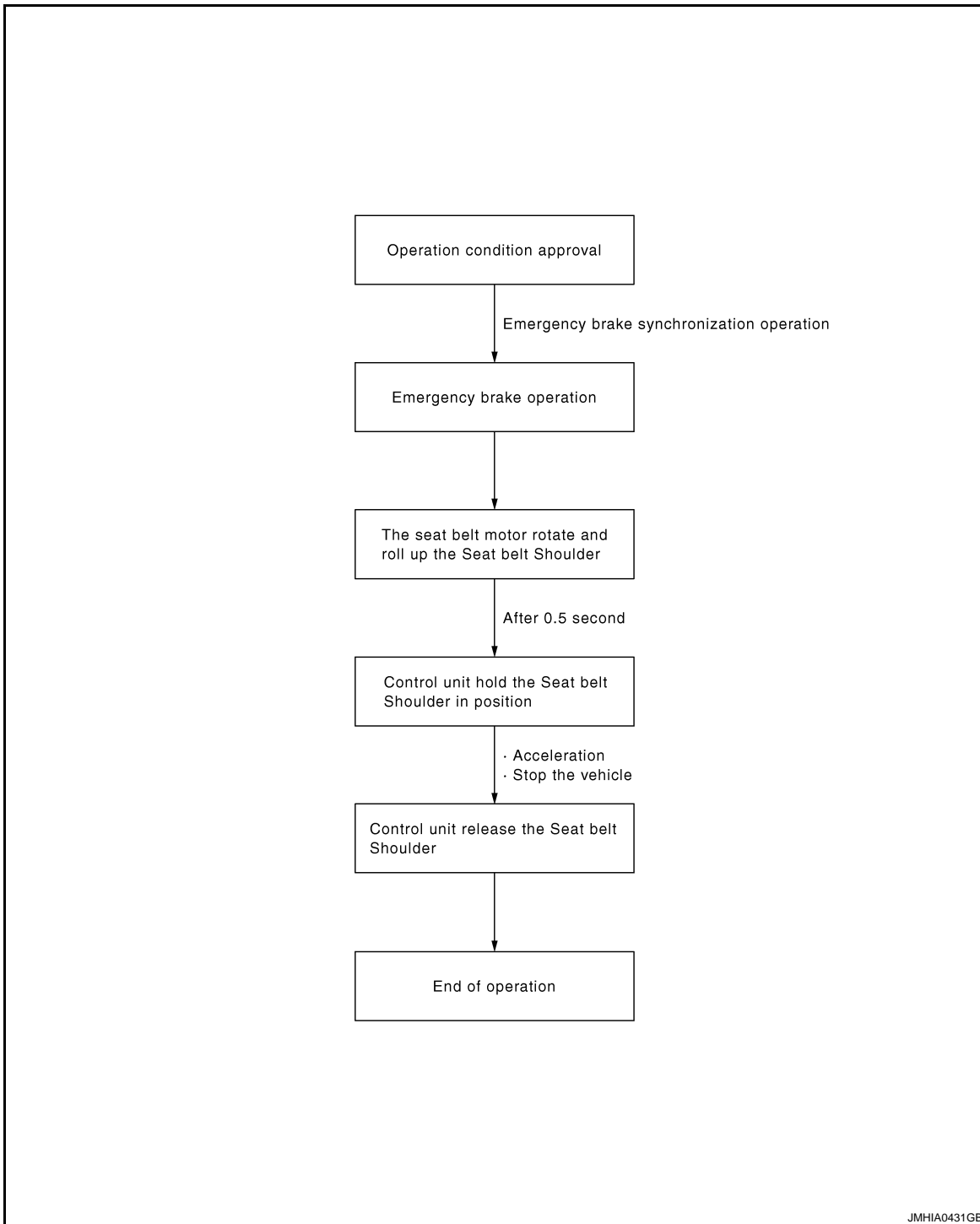

Refer to [SBC-8. "System Description"](#) for details of operation condition.

A
B
C
D
E
F
G
SBC
I
J
K
L
M
N
O
P

PRE-CRASH SEAT BELT SYSTEM

< FUNCTION DIAGNOSIS >

Component Parts Location

INFOID:000000001711970

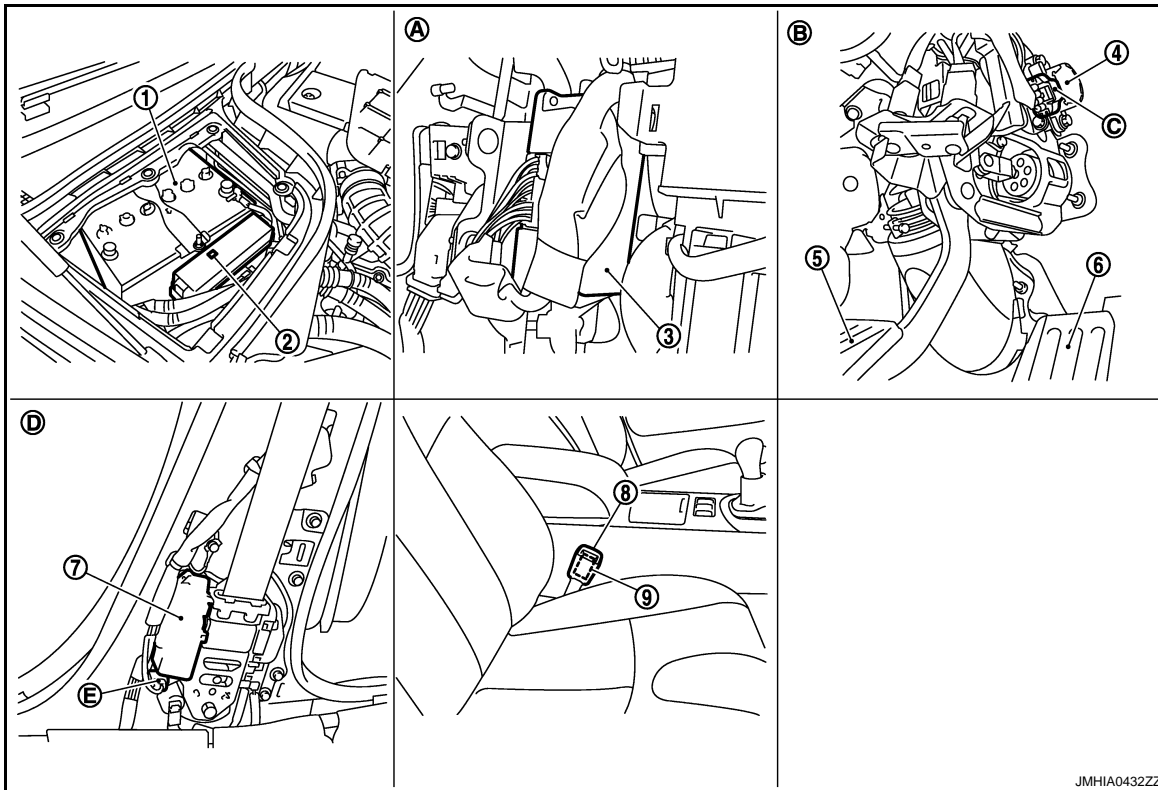

JMHIA043ZZZ

- | | | |
|--|--|--|
| 1. Battery | 2. 30A (F/L-G) | 3. Pre-crash seat belt control unit |
| 4. Brake pedal stroke sensor | 5. Brake pedal | 6. Accelerator pedal |
| 7. Seat belt pre-tensioner | 8. Seat belt buckle | 9. Seat belt buckle switch |
| A. Back side of glove box | B. Back of driver instrument panel (lower) | C. Brake pedal stroke sensor connector |
| D. Back of center pillar lower garnish | E. Seat belt pre-tensioner connector | |

Component Description

INFOID:000000001711971

Component	Function
Pre-crash seat belt control unit	It controls pre-crash seat belt motor according to input signal.
Pre-crash seat belt motor (Seat belt motor [RH/LH])	It is built into seat belt retractor, and it pulls, returns, and maintains according to the motor rotation.
Brake pedal stroke sensor	<ul style="list-style-type: none"> It changes voltage according to brake pedal depressed amount and sends the signal to pre-crash seat belt control unit. There are 2 signals (brake pedal stroke sensor 1 and 2) sent from the brake pedal stroke sensor. Pre-crash seat belt control unit will judge the stroke amount and the speed of the brake pedal according to the voltage of the signal sent by each side.
Seat belt buckle switch	It is arranged in the seat belt buckle and judges whether the seat belt is fastened or not fastened.
CAN system: Unified meter and A/C amp	It transmits the vehicle status to pre-crash seat belt control unit using the CAN communication system.

ON BOARD DIAGNOSTIC (OBD) SYSTEM

< FUNCTION DIAGNOSIS >

ON BOARD DIAGNOSTIC (OBD) SYSTEM

Diagnosis Description

INFOID:000000001711972

HOW TO DIAGNOSE

- Diagnosis for pre-crash seat belt system can be performed using CONSULT-III electronic diagnostic tester.
- Diagnosis allows technicians to detect and analyze circuits that return errors.
- Diagnostic modes of CONSULT-III are.

	Self-diagnosis mode	Inspection
SELF-DIAGNOSIS RESULTS	×	×
DATA MONITOR	×	×

DIAGNOSIS PROCEDURE

Follow the diagnosis procedure to check. Refer to [SBC-3. "Work Flow"](#).

DIAGNOSIS ITEM

- Communication
- LH/RH seat belt motor
- Brake pedal sensor
- Motor power supply
- Pre-crash seat belt control unit

ERASING SELF-DIAGNOSIS RESULTS

- SELF-DIAGNOSIS RESULTS
Current "SELF-DIAG RESULTS" are displayed. (If all suspect circuits have been repaired, "NO DTC" is displayed.)
- SELF-DIAG RESULTS [MEMORY]
Resume trouble diagnosis item selection screen, confirm "SELF-DIAG RESULTS", and then touch ERASE MEMORY.

CONSULT-III Function

INFOID:000000001711973

"SELF-DIAG RESULTS", "DATA MONITOR", "CAN DIAG SUPPORT MNTR", "C/U PART NO" of pre-crash seat belt system can be checked by combining communications between CONSULT-III (data reception and command transmission).

Part to be diagnosed	Inspection Item, Diagnosis Mode	Description	Refer to
Pre-crash seat belt	SELF-DIAGNOSIS RESULTS	<ul style="list-style-type: none">• Displays names of freeze frame data and basic inspection stored in ECM.• Displays data recorded when a malfunction is detected.• Can print out the display.• Erases DTCs recorded in memory.	SBC-11
	DATA MONITOR	<ul style="list-style-type: none">• Displays input data for pre-crash seat belt control unit in real time.	SBC-11
	CAN DIAG SUPPORT MNTR	<ul style="list-style-type: none">• Monitors communication status of CAN communication.	LAN-13
	ECU PART NUMBER	<ul style="list-style-type: none">• Displays pre-crash seat belt control unit part number.	—

SELF-DIAGNOSIS RESULTS

Check self-diagnosis results.

CAUTION:

When malfunctions are detected in several systems, including the CAN communication [U1000], troubleshoot the CAN communication [U1000].

ON BOARD DIAGNOSTIC (OBD) SYSTEM

< FUNCTION DIAGNOSIS >

Diagnostic item	Malfunction judgement criteria	Refer to
CAN COMM CIRC [U1000]	CAN communication is malfunctioning.	SBC-13
Seat belt motor system RH [B2451]	Circuit of seat belt motor (RH) is open or shorted.	SBC-14
Seat belt motor system LH [B2452]	Circuit of seat belt motor (LH) is open or shorted.	SBC-16
B-pedal sensor system [B2453]	Circuit of brake pedal stroke sensor is open or shorted.	SBC-18
Motor power supply circuit system [B2454]	Circuit of motor power supply is open or shorted. CAUTION: Malfunction is judged when 30A (F/L-G) fusible link blows out even if motor power supply circuit is not malfunctioning.	SBC-20

NOTE:

Timing display judges the status of self-diagnosis results judged from each input signal.

- When malfunction is found in the past and it is normal now, "MEMORY" is displayed.
- When malfunction is found at present or found immediately after the self-diagnosis, "CURRENT" is displayed.
- When malfunction is not found in the past and it is normal now, nothing is displayed.

CAUTION:

Some malfunctions are displayed at low battery voltage (when keeping 7 to 8 V for 2 seconds) even if the system is not malfunctioning. Erase DTC memory and do not replace any parts after making sure that the system is normal especially if the malfunctions are displayed after replacing battery.

DATA MONITOR

- Check DATA MONITOR

Monitor item	[Operation or unit]	Display item
B-pedal sensor SIG1	[V]	Brake pedal stroke sensor 1 signal voltage is displayed.
B-pedal sensor SIG2	[V]	Brake pedal stroke sensor 2 signal voltage is displayed.
BUCKLE SW RH	[ON/OFF]	ON/OFF status of RH seat belt switch signal is displayed.
BUCKLE SW LH	[ON/OFF]	ON/OFF status of LH seat belt switch signal is displayed.
Vehicle speed sensor	[km/h]	Vehicle speed signal is displayed.

U1000 CAN COMM CIRCUIT

< COMPONENT DIAGNOSIS >

COMPONENT DIAGNOSIS

U1000 CAN COMM CIRCUIT

Description

INFOID:000000001711974

- CAN (Controller Area Network) is a serial communication line for real time applications. It is an on board multiplex communication line with high data communication speed and excellent error detection ability. A modern vehicle is equipped with many ECMs, and each control unit shares information and links with other control units during operation (not independent). In CAN communication, two control units are connected with two communication lines (CAN H-line, CAN L-line) allowing a high rate of information transmission with less wiring. Each control unit transmits/receives data but selectively reads required data only.
- It transmits the vehicle status to pre-crash seat belt control unit using the CAN communication system.
- It consists of CAN system (unified meter and A/C amp).
- Refer to [LAN-25. "CAN System Specification Chart"](#) in LAN section for CAN communication unit (2WD).

DTC Logic

INFOID:000000001711975

DTC DETECTION LOGIC

DTC No.	Self-diagnosis item	DTC Detection Condition	Possible causes
U1000	CAN communication circuit	Pre-crash seat belt control unit cannot transmit and receive CAN communication system for 2 seconds or more.	CAN message reception malfunction

DTC CONFIRMATION PROCEDURE

1. SELF-DIAGNOSIS WITH PRE-CRASH SEAT BELT CONTROL UNIT

Check "SELF-DIAG RESULT" of CONSULT-III.

Is any DTC detected?

- YES >> Refer to [LAN-25. "CAN System Specification Chart"](#) in LAN section for CAN communication or CAN system.
- NO >> CAN communication system is normal.

B2451 SB MOTOR RH CIRC

< COMPONENT DIAGNOSIS >

B2451 SB MOTOR RH CIRC

Description

INFOID:000000001711976

- It pulls, returns, and maintains according to the motor rotation.
- It is built into the seat belt retractor.
- It is installed to back of RH center pillar garnish.

DTC Logic

INFOID:000000001711977

DTC DETECTION LOGIC

DTC No.	Self-diagnosis item	DTC Detection Condition	Possible causes
B2451	Seat belt motor system RH	Circuit of seat belt motor (RH) is open or shorted	<ul style="list-style-type: none">• Open circuit, short circuit to battery, and short circuit to ground in seat belt motor (RH) harness• ECU internal malfunction

DTC CONFIRMATION PROCEDURE

1. CHECK RH PRE-CRASH SEAT BELT MOTOR CIRCUIT

Check "SELF-DIAG RESULT" of CONSULT-III.

Is any DTC detected?

- YES >> Refer to [SBC-14, "Diagnosis Procedure"](#).
NO >> RH pre-crash seat belt motor system is normal.

Diagnosis Procedure

INFOID:000000001711978

1. CHECK RH PRE-CRASH SEAT BELT MOTOR HARNESS

1. Turn the ignition switch OFF.
2. Disconnect pre-crash seat belt control unit and RH pre-crash seat belt motor connector.
3. Does continuity between pre-crash seat belt control unit harness connector terminals 1, 3 and RH pre-crash seat belt motor harness connector terminals 1, 2 exist?

1 - 1 Existed

2 - 3 Existed

4. Does continuity between pre-crash seat belt control unit harness connector terminals 1, 3 and ground exist?

1 - Ground Not existed

3 - Ground Not existed

Is the inspection result normal?

- YES >> Refer to [SBC-14, "Component Inspection"](#).
NO >> Repair or replace harness between pre-crash seat belt control unit and RH pre-crash seat belt motor.

Component Inspection

INFOID:000000001711979

COMPONENT PARTS INSPECTION

1. CHECK RH PRE-CRASH SEAT BELT MOTOR

Does continuity between RH pre-crash seat belt motor terminals 1 and 2 exist?

1 - 2 Existed

Is the inspection result normal?

B2451 SB MOTOR RH CIRC

< COMPONENT DIAGNOSIS >

YES >> Replace pre-crash seat belt control unit.
NO >> Replace RH pre-crash seat belt motor.

A

B

C

D

E

F

G

SBC

I

J

K

L

M

N

O

P

B2452 SB MOTOR LH CIRC

< COMPONENT DIAGNOSIS >

B2452 SB MOTOR LH CIRC

Description

INFOID:000000001711980

- It pulls, returns, and maintains according to the motor rotation.
- It is built into the seat belt retractor.
- It is installed to the back of LH center pillar garnish.

DTC Logic

INFOID:000000001711981

DTC DETECTION LOGIC

DTC No.	Self-diagnosis item	DTC Detection Condition	Possible causes
B2452	Seat belt motor system LH	Circuit of seat belt motor (LH) is open or shorted	<ul style="list-style-type: none">• Open circuit, short circuit to battery, and short circuit to ground in seat belt motor (LH) harness• ECU internal malfunction

DTC REPRODUCTION PROCEDURE

1. CHECK LH PRE-CRASH SEAT BELT MOTOR CIRCUIT

Check "SELF-DIAG RESULT" of CONSULT-III.

Is any DTC detected?

- YES >> Refer to [SBC-16, "Diagnosis Procedure"](#).
NO >> LH pre-crash seat belt motor system is normal.

Diagnosis Procedure

INFOID:000000001711982

1. CHECK LH PRE-CRASH SEAT BELT MOTOR HARNESS

1. Turn the ignition switch OFF.
2. Disconnect pre-crash seat belt control unit and LH pre-crash seat belt motor connector.
3. Does continuity between pre-crash seat belt control unit harness connector terminals 4, 6 and LH pre-crash seat belt motor harness connector terminals 1, 2 exist?

1 - 6 Existed

2 - 4 Existed

4. Does continuity between pre-crash seat belt control unit harness connector terminals 4, 6 and ground exist?

4 - Ground Not existed

6 - Ground Not existed

Is the inspection result normal?

- YES >> Refer to [SBC-16, "Component Inspection"](#).
NO >> Repair or replace harness between pre-crash seat belt control unit and LH pre-crash seat belt motor.

Component Inspection

INFOID:000000001711983

COMPONENT PARTS INSPECTION

1. CHECK LH PRE-CRASH SEAT BELT MOTOR

Does continuity between LH seat belt terminals 1 and 2 exist?

1 - 2 Existed

Is the inspection result normal?

B2452 SB MOTOR LH CIRC

< COMPONENT DIAGNOSIS >

YES >> Replace pre-crash seat belt control unit.
NO >> Replace LH pre-crash seat belt motor.

A

B

C

D

E

F

G

SBC

I

J

K

L

M

N

O

P

B2453 BR STROK SEN CIRC

< COMPONENT DIAGNOSIS >

B2453 BR STROK SEN CIRC

Description

INFOID:000000001711984

- It changes voltage according to brake pedal depressed amount and sends the signal to pre-crash seat belt control unit.
- There are 2 signals (brake pedal stroke sensor 1 and 2) sent from the brake pedal stroke sensor. Pre-crash seat belt control unit will judge the stroke amount and the speed of the brake pedal according to the voltage of the signal sent by each side.
- It is installed to back of driver instrument panel (lower).

DTC Logic

INFOID:000000001711985

DTC DETECTION LOGIC

DTC No.	Self-diagnosis item	DTC Detection Condition	Possible causes
B2453	B-pedal sensor system	Circuit of brake pedal stroke sensor output is open or shorted	<ul style="list-style-type: none">• Open circuit, short circuit to battery, and short circuit to ground in brake pedal stroke sensor harness• ECU internal malfunction

DTC CONFIRMATION PROCEDURE

1. CHECK LH PRE-CRASH SEAT BELT MOTOR CIRCUIT

Check "SELF-DIAG RESULT" of CONSULT-III.

Is any DTC detected?

- YES >> Refer to Check 2 of [SBC-18. "Diagnosis Procedure"](#).
NO >> Refer to Check 1 of [SBC-18. "Diagnosis Procedure"](#).

Diagnosis Procedure

INFOID:000000001711986

1. CHECK PRE-CRASH SEAT BELT CONTROL UNIT INPUT SIGNAL

Select "B-pedal sensor SIG1" and "B-pedal sensor SIG2", and then check that the voltage changes are synchronized with brake pedal operation.

B-pedal sensor SIG1

Brake released → depressed Approx. 1 → 4V

B-pedal sensor SIG2

Brake released → depressed Approx. 4 → 1V

Is the inspection result normal?

- YES >> Brake pedal stroke sensor system is normal.
NO >> GO TO 2.

2. CHECK BRAKE PEDAL STROKE SENSOR HARNESS

1. Turn the ignition switch OFF.
2. Disconnect pre-crash seat belt control unit and brake pedal stroke sensor connector.
3. Does continuity between pre-crash seat belt control unit harness connector terminals 16, 18, 20, 21 and brake pedal stroke sensor harness connector terminals 1, 2, 3, 4 exist?

16 - 1 Existed

18 - 2 Existed

20 - 3 Existed

21 - 4 Existed

4. Does continuity between pre-crash seat belt control unit harness connector terminals 16, 18, 20, 21 and ground exist?

B2453 BR STROK SEN CIRC

< COMPONENT DIAGNOSIS >

16 - Ground	Not existed
18 - Ground	Not existed
20 - Ground	Not existed
21 - Ground	Not existed

Is the inspection result normal?

YES >> GO TO 3.

NO >> Repair or replace harness between pre-crash seat belt control unit and brake pedal stroke sensor.

3. CHECK BRAKE PEDAL STROKE SENSOR POWER SUPPLY

1. Connect pre-crash seat belt control unit connector.
2. Turn the ignition switch ON.
3. Check that voltage between pre-crash seat belt control unit harness connector terminal 18 and ground is normal.

18 - Ground Approx. 5V

Is the inspection result normal?

YES >> Refer to [SBC-19, "Component Inspection"](#).

NO >> Replace pre-crash seat belt control unit.

Component Inspection

INFOID:000000001711987

COMPONENT PARTS INSPECTION

1. CHECK BRAKE PEDAL STROKE SENSOR

Check that continuity between brake pedal stroke sensor terminal 2 and terminals 1 and 3 is normal when performing the brake operation.

Terminal	Measuring condition	Resistance (K Ω)
2	1 Brake released \rightarrow depressed	Approx. 1.0 \rightarrow 0.2
	3 Brake released \rightarrow depressed	Approx. 0.2 \rightarrow 1.0

Is the inspection result normal?

YES >> Brake pedal stroke sensor system is normal.

NO >> Replace brake pedal stroke sensor.

A
B
C
D
E
F
G
I
J
K
L
M
N
O
P

SBC

B2454 MOTOR PWR SUP CIRC

< COMPONENT DIAGNOSIS >

B2454 MOTOR PWR SUP CIRC

Description

INFOID:000000001711988

- When the control unit judges the emergency braking operation, it retracts the shoulder belt with the electric motor and reduces the looseness of the belt.
- When the ignition switch is turned ON, the current is flowing to the seat belt motor. It stops when the ignition switch is turned OFF.
- It is installed to back of center pillar garnish.

DTC Logic

INFOID:000000001711989

DTC DETECTION LOGIC

DTC No.	Self-diagnosis item	DTC Detection Condition	Possible causes
B2454	Motor power supply circuit system	Motor power supply circuit is open or shorted CAUTION: Malfunction is judged when 30A (F/L-G) fusible link blows out even if motor power supply circuit is not malfunctioning.	<ul style="list-style-type: none">• Open circuit and short circuit to ground in drive circuit power supply harness• ECU internal malfunction

DTC CONFIRMATION PROCEDURE

1. CHECK MOTOR POWER SUPPLY CIRCUIT

Check "SELF-DIAG RESULT" of CONSULT-III.

Is any DTC detected?

- YES >> Refer to [SBC-20, "Diagnosis Procedure"](#).
NO >> Inspection End.

Diagnosis Procedure

INFOID:000000001711990

1. CHECK MOTOR POWER SUPPLY CIRCUIT

1. Disconnect the pre-crash seat belt control unit connector.
2. Check that voltage between pre-crash seat belt control unit harness connector terminal 2 and ground is 12V.

2 - Ground

Approx. 12V

Is the inspection result normal?

- YES >> Inspection End.
NO >> Repair or replace pre-crash seat belt control unit power supply circuit harness.

B2455 PSB C/U INT CIRCUIT

< COMPONENT DIAGNOSIS >

B2455 PSB C/U INT CIRCUIT

Description

INFOID:000000001711991

- It controls pre-crash seat belt motor according to input signal.
- It consists of pre-crash seat belt control unit.
- It is installed on the back of the glove box.

DTC Logic

INFOID:000000001711992

DTC DETECTION LOGIC

DTC No.	Self-diagnosis item	DTC Detection Condition	Possible causes
B2455	C/U internal circuit system	Pre-crash seat belt control unit internal circuit malfunction	ECU internal malfunction

DTC CONFIRMATION PROCEDURE

1. SELF-DIAGNOSIS WITH PRE-CRASH SEAT BELT CONTROL UNIT

Check "SELF-DIAG RESULT" of CONSULT-III.

Is any DTC detected?

- YES >> Replace pre-crash seat belt control unit.
NO >> Pre-crash seat belt control unit is normal.

A
B
C
D
E
F
G
I
J
K
L
M
N
O
P

SBC

BRAKE PEDAL STROKE SENSOR SHIELD WIRE CIRCUIT CHECK

< COMPONENT DIAGNOSIS >

BRAKE PEDAL STROKE SENSOR SHIELD WIRE CIRCUIT CHECK

Description

INFOID:000000001711993

- It changes voltage according to brake pedal depressed amount and sends the signal to pre-crash seat belt control unit.
- There are two signals (brake pedal stroke sensor 1 and 2) sent from the brake pedal stroke sensor. Pre-crash seat belt control unit will judge the stroke amount and the speed of the brake pedal according to the voltage of the signal sent by each side.
- It is installed to back of driver instrument panel (lower).

Component Function Check

INFOID:000000001711994

1. CHECK PRE-CRASH SEAT BELT CONTROL UNIT INPUT SIGNAL

With CONSULT-III

When checking "B-pedal sensor SIG1" and "2" on DATA MONITOR screen, check that the voltage does not change if brake pedal is not operated.

NOTE:

Diagnosis should be performed with engine running, audio and air conditioner operating.

B-pedal sensor SIG1

Brake released There is no change in the voltage value, and it is almost constant

B-pedal sensor SIG2

Brake released There is no change in the voltage value, and it is almost constant

Without CONSULT-III

1. Start the engine.
2. Check that voltage between pre-crash seat belt harness connector and ground without brake pedal operation is normal.

Terminal		Measuring condition	Voltage
(+)	(-)		
16	Ground	Brake released When engine is started and audio and air conditioner are operating	There is no change in the voltage value, and it is almost constant.
20			

Is the inspection result normal?

- YES >> Brake pedal stroke sensor shield ground system is normal.
NO >> Check shield wire for damage. Repair or replace if necessary.

SEAT BELT BUCKLE SWITCH (DRIVER SIDE) CIRCUIT CHECK

< COMPONENT DIAGNOSIS >

SEAT BELT BUCKLE SWITCH (DRIVER SIDE) CIRCUIT CHECK

Description

INFOID:000000001711999

- Perform the control of tension reducer according to the seat belt buckle switch ON/OFF.
- If the seat belt is not fastened when the ignition switch is turned ON, it detects whether the seat belt is fastened or not so as to turn on the seat belt warning lamp of combination meter.
- The seat belt buckle switch is installed in the seat belt buckle.

Component Function Check

INFOID:000000001712000

1. CHECK PRE-CRASH SEAT BELT CONTROL UNIT INPUT SIGNAL

With CONSULT-III

When checking "BUCKLE SW LH" on DATA MONITOR screen, check that ON/OFF display changes synchronized with the insertion operation to the seat belt buckle.

BUCKLE SW LH

When LH seat belt is not fastened OFF

When LH seat belt is fastened ON

Without CONSULT-III

1. Turn the ignition switch ON.
2. Check that voltage between LH seat belt buckle switch harness connector terminal 1 and ground is normal.

Terminal		Measuring condition	Voltage (V)
(+)	(-)		
1	Ground	When seat belt is not fastened	Approx. 0
		When seat belt is fastened	Approx. 12

Is the inspection result normal?

YES >> LH seat belt buckle switch system is normal.

NO >> GO TO 2.

2. CHECK LH SEAT BELT BUCKLE SWITCH HARNESS

1. Turn the ignition switch OFF.
2. Disconnect pre-crash seat belt control unit connector and LH seat belt buckle switch connector.
3. Does continuity between pre-crash seat belt control unit harness connector terminal 10 and LH seat belt buckle switch harness connector terminal 1 exist?

10 - 1 Existed

4. Does continuity between pre-crash seat belt control unit harness connector terminal 10 and ground exist?

10 - Ground Not existed

Is the inspection result normal?

YES >> Refer to [SBC-23, "Component Inspection \(Driver seat belt buckle switch\)"](#).

NO >> Repair or replace harness between pre-crash seat belt control unit and LH seat belt buckle switch.

Component Inspection (Driver seat belt buckle switch)

INFOID:000000001712001

1. CHECK LH SEAT BELT BUCKLE SWITCH

Check that continuity between LH seat belt buckle switch terminals 1 and 2 is normal when performing the insertion operation to the seat belt buckle.

SEAT BELT BUCKLE SWITCH (DRIVER SIDE) CIRCUIT CHECK

< COMPONENT DIAGNOSIS >

Terminal		Measuring condition	Continuity
1	2	When seat belt is not fastened	Existed
		When seat belt is fastened	Not existed

Is the inspection result normal?

- YES >> Refer to [SBC-24, "Component Inspection \(Driver seat belt buckle switch ground circuit\)".](#)
NO >> Replace LH seat belt buckle.

Component Inspection (Driver seat belt buckle switch ground circuit)

INFOID:000000001712002

1. CHECK LH SEAT BELT BUCKLE SWITCH GROUND CIRCUIT HARNESS

Does continuity between LH seat belt buckle switch harness connector terminal 2 and ground exist?

2 - Ground **Existed**

Is the inspection result normal?

- YES >> LH seat belt buckle switch system is normal.
NO >> Repair or replace harness between LH seat belt buckle switch and ground.

SEAT BELT BUCKLE SWITCH (PASSENGER SIDE) CIRCUIT CHECK

< COMPONENT DIAGNOSIS >

SEAT BELT BUCKLE SWITCH (PASSENGER SIDE) CIRCUIT CHECK

Description

INFOID:000000001711995

- Perform the control of tension reducer according to the seat belt buckle switch ON/OFF.
- If the seat belt is not fastened when the ignition switch is turned ON, it detects whether the seat belt is fastened or not so as to turn on the seat belt warning lamp of combination meter.
- The seat belt buckle switch is installed in the seat belt buckle.

Component Function Check

INFOID:000000001711996

1. CHECK PRE-CRASH SEAT BELT CONTROL UNIT INPUT SIGNAL

With CONSULT-III

When checking "BUCKLE SW RH" on DATA MONITOR screen, check that ON/OFF display changes are synchronized with the insertion operation to the seat belt buckle.

BUCKLE SW RH

When RH seat belt is not fastened OFF

When RH seat belt is fastened ON

Without CONSULT-III

1. Turn the ignition switch ON.
2. Check that voltage between RH seat belt buckle switch harness connector terminal 1 and ground is normal.

Terminal		Measuring condition	Voltage (V)
(+)	(-)		
1	Ground	When seat belt is not fastened	Approx. 0
		When seat belt is fastened	Approx. 5

Is the inspection result normal?

- YES >> RH seat belt buckle switch system is normal.
NO >> GO TO 2.

2. CHECK RH SEAT BELT BUCKLE SWITCH HARNESS

1. Turn the ignition switch OFF.
2. Disconnect pre-crash seat belt control unit connector and RH seat belt buckle switch connector.
3. Does continuity between pre-crash seat belt control unit harness connector terminal 8 and RH seat belt buckle switch harness connector terminal 1 exist?

8 - 1 Existed

4. Does continuity between pre-crash seat belt control unit harness connector terminal 8 and ground exist?

8 - Ground Not existed

Is the inspection result normal?

- YES >> Refer to [SBC-25, "Component Inspection \(Passenger seat belt buckle switch\)"](#).
NO >> Repair or replace harness between pre-crash seat belt control unit and RH seat belt buckle switch.

Component Inspection (Passenger seat belt buckle switch)

INFOID:000000001711997

1. CHECK RH SEAT BELT BUCKLE SWITCH

Check that continuity between RH seat belt buckle switch terminals 1 and 2 is normal when performing the insertion operation to the seat belt buckle.

SEAT BELT BUCKLE SWITCH (PASSENGER SIDE) CIRCUIT CHECK

< COMPONENT DIAGNOSIS >

Terminal		Measuring condition	Continuity
1	2	When seat belt is not fastened	Existed
		When seat belt is fastened	Not existed

Is the inspection result normal?

- YES >> Refer to [SBC-26. "Component Inspection \(Passenger seat belt side buckle switch ground circuit\)".](#)
NO >> Replace RH seat belt buckle.

Component Inspection (Passenger seat belt side buckle switch ground circuit)

INFOID:000000001711998

1. CHECK RH SEAT BELT BUCKLE SWITCH GROUND CIRCUIT HARNESS

Does continuity between RH seat belt buckle switch harness connector terminal 2 and ground exist?

2 - Ground

Existed

Is the inspection result normal?

- YES >> RH seat belt buckle switch system is normal.
NO >> Repair or replace harness between RH seat belt buckle switch and ground.

IGNITION POWER SUPPLY CIRCUIT CHECK

< COMPONENT DIAGNOSIS >

IGNITION POWER SUPPLY CIRCUIT CHECK

Description

INFOID:000000001712003

- It is the power supply system when turning the ignition switch to IGN ON/OFF.
- The ignition switch is installed to the right side of the steering column.

Component Function Check

INFOID:000000001712004

1. CHECK FUSES

1. Turn the ignition switch OFF.
2. Check that the fuses are not blown.

CAUTION:

Refer to [GI-41, "Circuit Inspection"](#) for fuse number.

Is the inspection result normal?

YES >> GO TO 2.

NO >> If a fuse is blown, determine the possible cause, repair the affected circuit, and replace the blown fuse.

2. CHECK IGNITION POWER SUPPLY CIRCUIT

1. Disconnect the pre-crash seat belt control unit connector.
2. Turn the ignition switch ON.
3. Check that voltage between pre-crash seat belt control unit harness connector terminal 13 and ground is normal.

13 - Ground

Approx. 12V

Is the inspection result normal?

YES >> Ignition power supply system is normal.

NO >> Repair or replace pre-crash seat belt control unit ignition power supply circuit harness.

A
B
C
D
E
F
G
I
J
K
L
M
N
O
P

SBC

PRE-CRASH SEAT BELT CONTROL UNIT GROUND CIRCUIT CHECK

< COMPONENT DIAGNOSIS >

PRE-CRASH SEAT BELT CONTROL UNIT GROUND CIRCUIT CHECK

Description

INFOID:000000001712005

- The pre-crash seat belt control unit controls the pre-crash seat belt motor according to the input signal.
- When the control unit judges the emergency braking operation and the intelligent brake assistance operating status, it gives the sense of security by the motor built into the pre-crash seat belt motor retracting the shoulder belt and suppressing the crew's posture change. Or, it eases the damage of the collision.
- It is installed on the back of the glove box.

Component Function Check

INFOID:000000001712006

1.CHECK PRE-CRASH SEAT BELT CONTROL UNIT GROUND CIRCUIT

-
1. Turn the ignition switch OFF.
 2. Disconnect the pre-crash seat belt control unit connector.
 3. Check that continuity between pre-crash seat belt control unit harness connector terminals 5, 26 and ground is normal.

5 - Ground

Existed

26 - Ground

Existed

Is the inspection result normal?

YES >> Ground system is normal.

NO >> Repair or replace harness between pre-crash seat belt control unit and ground.

PRE-CRASH SEAT BELT CONTROL UNIT

< ECU DIAGNOSIS >

ECU DIAGNOSIS

PRE-CRASH SEAT BELT CONTROL UNIT

Reference Value

INFOID:000000001712010

VALUES ON THE DIAGNOSIS TOOL
CONSULT-III MONITOR ITEM

Monitor item	Condition	Value/Status (Approx)
B PEDAL SENS SIG1 B PEDAL SENS SIG2	Brake released Brake released	(1V) (4V)
B PEDAL SENS SIG1 B PEDAL SENS SIG2	Brake released → depressed Brake released → depressed	(1V→4V) (4V→1V)
RH BUCKLE SW	RH seat belt is not fastened RH seat belt is fastened	OFF ON
LH BUCKLE SW	LH seat belt is not fastened LH seat belt is fastened	OFF ON

TERMINAL LAYOUT

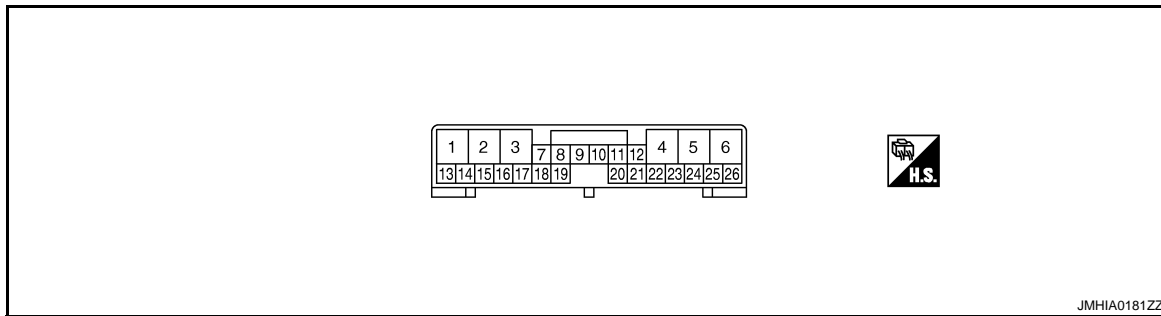

PHYSICAL VALUES

Terminal No.		Wire color	Description		Condition	Value (*1) (Approx)
+	-		Signal name	Input/Output		
1	GND	G/R	RH seat belt motor release signal	Output	—	—
2	GND	W	Drive circuit power supply (+BAT)	Input	Seat belt motor non-operational	BAT
3	GND	G/Y	RH seat belt motor forward (retract) signal	Output	—	—
4	GND	GR/W	LH seat belt motor forward (retract) signal	Output	—	—
5	GND	W	Drive circuit ground	—	Always	GND
6	GND	LY	LH seat belt motor release signal	Output	—	—
7	GND	G	Indicator (seat belt warning lamp)	Output	LH seat belt is not fastened	GND
					LH seat belt is fastened	BAT
					LH seat belt is fastened or malfunction of system	BAT←→GND (0.5sec)
8	GND	LG	RH seat belt buckle switch signal	Input	RH seat belt is fastened	BAT
					RH seat belt is not fastened	GND
10	GND	SB	LH seat belt buckle switch signal	Input	LH seat belt is fastened	OPEN
					LH seat belt is not fastened	GND

PRE-CRASH SEAT BELT CONTROL UNIT

< ECU DIAGNOSIS >

Terminal No.		Wire color	Description		Condition	Value (*1) (Approx)
+	-		Signal name	Input/ Output		
13	GND	W	Control circuit power supply (IGN)	Input	IGN ON	BAT
					IGN OFF	GND
16	GND	W	Brake pedal stroke sensor signal1	Input	IGN ON	(1→4V) *2
					IGN OFF	0V
18	GND	R	Brake pedal stroke sensor power circuit	Output	IGN ON	5V
					IGN OFF	0V
20	GND	G	Brake pedal stroke sensor signal2	Input	IGN ON	(4→1V) *2
					IGN OFF	0V
21	GND	B	Brake pedal stroke sensor ground circuit	—	Always	GND
22	GND	P	CAN communication signal (CAN L-line)	Input/ Output	—	—
24	GND	L	CAN communication signal (CAN H-line)	Input/ Output	—	—
25	GND	SHIELD	Shield ground	—	Always	GND
26	GND	B	Control circuit ground	—	Always	GND

*1: Perform the measurement while connecting the control unit and the harness.

*2: The value may be changed according to the brake pedal depressed amount.

Fail Safe

INFOID:000000001712011

When a malfunction occurs in the following system, the pre-crash seat belt function is controlled according to the malfunctioning parts.

Display contents of CONSULT-III	Fail-safe	Cancellation
B2451: SB MOTOR RH CIRC	Deactivate the RH pre-crash seat belt function	Erase DTC
B2452: SB MOTOR LH CIRC	Deactivate the LH pre-crash seat belt function	Erase DTC
B2453: BR STROK SEN CIRC	Deactivate the interlock function during emergency brake operation	Erase DTC
B2454: MOTOR PWR SUP CIRC	Deactivate the pre-crash seat belt function	Erase DTC

DTC Index

INFOID:000000001712012

DISPLAY ITEM LIST (PRE-CRASH SEAT BELT)

DTC	Trouble diagnosis name (CONSULT-III display)	DTC detection condition	Reference
—	—	No malfunction is detected	—
U1000	CAN COMM CIRCUIT	Pre-crash seat belt control unit cannot transmit and receive CAN communication signal for 2 seconds or more	SBC-13
B2451	SB MOTOR RH CIRC	RH seat belt motor circuit is shorted or open	SBC-14
B2452	SB MOTOR LH CIRC	LH seat belt motor circuit is shorted or open	SBC-16
B2453	BR STROK SEN CIRC	Brake pedal stroke sensor circuit is shorted or open	SBC-18
B2454	MOTOR PWR SUP CIRC	Motor power supply circuit is shorted or open CAUTION: Malfunction is judged when 30A (F/L-G) fusible link blows out even if motor power supply circuit is not malfunctioning.	SBC-20
B2455	PSB C/U INT CIRCUIT	Internal breakdown in pre-crash seat belt control unit	SBC-21

PRE-CRASH SEAT BELT CONTROL UNIT

< ECU DIAGNOSIS >

PRE-CRASH SEAT BELT SYSTEM

Connector No.	B1
Connector Name	WIRE TO WIRE
Connector Type	TH80FW-GS16-TM4

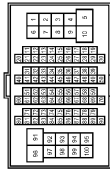

Terminal No.	Color of Wire	Signal Name [Specification]
72	G	-
91	G/R	-
92	SHIELD	-
96	G/Y	-

Connector No.	B13
Connector Name	SEAT BELT BUCKLE SWITCH (DRIVER SIDE)
Connector Type	A03FW

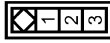

Terminal No.	Color of Wire	Signal Name [Specification]
1	G	-
2	B	-

Connector No.	B28
Connector Name	PRE-CRASH SEAT BELT MOTOR LH
Connector Type	TB02FW-ZV



Terminal No.	Color of Wire	Signal Name [Specification]
1	G/Y	-
2	G/R	-

Connector No.	B201
Connector Name	WIRE TO WIRE
Connector Type	TH80FW-GS16-TM4

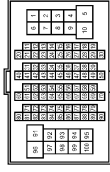

Terminal No.	Color of Wire	Signal Name [Specification]
5	G/R	-
8	LG	-
9	SHIELD	-
10	G/Y	-

Connector No.	B213
Connector Name	SEAT BELT BUCKLE SWITCH (PASSENGER SIDE)
Connector Type	A03FW

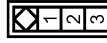

Terminal No.	Color of Wire	Signal Name [Specification]
1	LG	-
2	B	-

Connector No.	B228
Connector Name	PRE-CRASH SEAT BELT MOTOR RH
Connector Type	TB02FW-ZV



Terminal No.	Color of Wire	Signal Name [Specification]
1	G/R	-
2	G/Y	-

Connector No.	E67
Connector Name	ICC SENSOR INTEGRATED UNIT
Connector Type	RS08FB-PR



Terminal No.	Color of Wire	Signal Name [Specification]
3	L	CAN-H
6	P	CAN-L

Connector No.	E106
Connector Name	WIRE TO WIRE
Connector Type	TH80FW-GS16-TM4

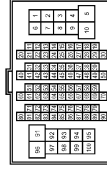

Terminal No.	Color of Wire	Signal Name [Specification]
1	G	-
2	W	-
3	R	-
4	SHIELD	-
5	W	-
6	SHIELD	-
7	B	-
8	P	-
9	L	-

JCHWA0097GE

PRE-CRASH SEAT BELT CONTROL UNIT

< ECU DIAGNOSIS >

PRE-CRASH SEAT BELT SYSTEM

Connector No.	E116
Connector Name	BRAKE PEDAL STROKE SENSOR
Connector Type	HS04FB



Terminal No.	Color of Wire	Signal Name [Specification]
1	W	S1
2	R	VCC
3	G	SZ
4	B	GND

Connector No.	F51
Connector Name	A/T ASSEMBLY
Connector Type	RK10FG-DGY



Terminal No.	Color of Wire	Signal Name [Specification]
3	L	-
8	P	-

Connector No.	F103
Connector Name	WIRE TO WIRE
Connector Type	TK38FW-HS10

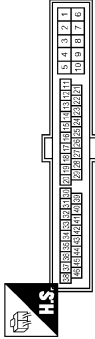

Terminal No.	Color of Wire	Signal Name [Specification]
43	P	-
44	L	-

Connector No.	F151
Connector Name	TOM (TRANSMISSION CONTROL MODULE)
Connector Type	SPI08EGY

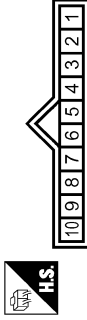

Terminal No.	Color of Wire	Signal Name [Specification]
1	BR	CAN-H
2	L/Y	CAN-L

Connector No.	M1
Connector Name	FUSE BLOCK (J/B)
Connector Type	NS06FW-M2



Terminal No.	Color of Wire	Signal Name [Specification]
2A	G	-

Connector No.	M2
Connector Name	FUSE BLOCK (J/B)
Connector Type	NS10FW-CS



Terminal No.	Color of Wire	Signal Name [Specification]
6B	Y	-

Connector No.	M3
Connector Name	FUSE BLOCK (J/B)
Connector Type	NS12FW-CS



Terminal No.	Color of Wire	Signal Name [Specification]
8C	W	-
12C	R	-

Connector No.	M6
Connector Name	WIRE TO WIRE
Connector Type	TH80MW-S16-TM4

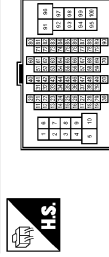

Terminal No.	Color of Wire	Signal Name [Specification]
1	G	-
2	W	-
3	R	-
4	SHIELD	-
5	W	-
6	SHIELD	-
7	B	-
8	P	-
9	L	-

A
B
C
D
E
F
G
SBC
I
J
K
L
M
N
O
P

PRE-CRASH SEAT BELT CONTROL UNIT

< ECU DIAGNOSIS >

PRE-CRASH SEAT BELT SYSTEM

Connector No.	M7
Connector Name	WIRE TO WIRE
Connector Type	TH80MW-CS16-TM4

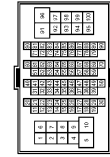

Terminal No.	Color of Wire	Signal Name [Specification]
72	L	- [With A/T]
72	LG	- [With M/T]
91	GR/W	-
92	SHIELD	-
96	L/Y	-

Connector No.	M24
Connector Name	DATA LINK CONNECTOR
Connector Type	BD16FW

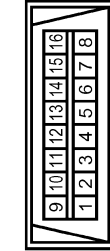

Terminal No.	Color of Wire	Signal Name [Specification]
6	L	-
14	P	-

Connector No.	M63
Connector Name	COMBINATION METER
Connector Type	SAB48FW

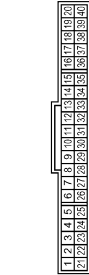

Terminal No.	Color of Wire	Signal Name [Specification]
2	LG	COMM (METER->AMP.)
3	GR	COMM (AMP->METER)
21	R	IGN
24	BR	COMM (LCD->AMP.)
25	Y	COMM (AMP->LCD)
29	L	SEAT BELT BUCKLE SW (DRIVER SIDE) [With A/T]
29	LG	SEAT BELT BUCKLE SW (DRIVER SIDE) [With M/T]
30	G	SEAT BELT

Connector No.	M66
Connector Name	UNIFIED METER AND A/C AMP.
Connector Type	TH48FW-NH

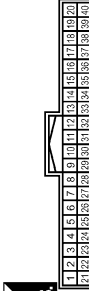

Terminal No.	Color of Wire	Signal Name [Specification]
7	GR	COMM (AMP->METER)
14	BR	COMM (LCD->AMP.)
27	LG	COMM (METER->AMP.)
34	Y	COMM (AMP->LCD)

Connector No.	M67
Connector Name	UNIFIED METER AND A/C AMP.
Connector Type	TH52FW-NH



Terminal No.	Color of Wire	Signal Name [Specification]
53	W	IGN
54	Y	BAT
55	B	GND
56	L	CAN-H
71	GR	GND
72	P	CAN-L

Connector No.	M110
Connector Name	PRE-CRASH SEAT BELT CONTROL UNIT
Connector Type	TH20FW-TB6

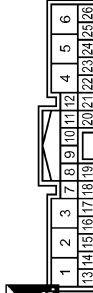

Terminal No.	Color of Wire	Signal Name [Specification]
1	G/R	MOTIOR (RH) (RELEASE)
2	W	-B
3	G/Y	MOTOR (RH) (FASTEN)
4	GR/W	MOTIOR (LH) (FASTEN)
5	W	GND (DRIVE)
6	L/Y	MOTIOR (LH) (RELEASE)
7	G	INDICATOR
8	LG	BUCKLE SW (RH)
10	SB	BUCKLE SW (LH)
13	W	IGN
16	W	SENS OUTPUT I

18	R	SENS POWER
20	G	SENS OUTPUT Z
21	B	SENS GND
22	P	CAN-L
24	L	CAN-H
25	SHIELD	SHIELD GND
26	B	GND (CONT)

Connector No.	M116
Connector Name	WIRE TO WIRE
Connector Type	TK38MW-NS10

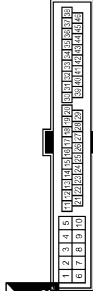

Terminal No.	Color of Wire	Signal Name [Specification]
43	P	-
44	L	-

PRE-CRASH SEAT BELT CONTROL UNIT

< ECU DIAGNOSIS >

A
B
C
D
E
F
G
SBC
I
J
K
L
M
N
O
P

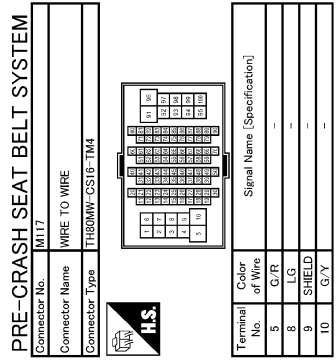

JCHWA0100GE

PRE-CRASH SEAT BELT SYSTEM

< SYMPTOM DIAGNOSIS >

SYMPTOM DIAGNOSIS

PRE-CRASH SEAT BELT SYSTEM

Description

INFOID:000000001712014

WARNING:

- The following tests should be performed in a safe, open place that is free of traffic and obstacles.
 - The tests should be performed on a dry, paved road. Do not attempt to perform the tests on a wet or unpaved road, open road, or highway. (This may cause an accident or personal injury.)
 - Driver and passenger should assume seat belt will not operate and prepare themselves accordingly.
1. Tighten driver and passenger seat belts.
 2. Drive at approximately 25 km/h.
 3. Notify passenger of a sudden stop. Driver and passenger prepare themselves for the possibility of system not operating. Then, driver fully depresses the brake pedal to stop suddenly.
 4. Check that the shoulder of the seat belt is pulled while braking.

Symptom Table

INFOID:000000001712015

Symptom	Suspect Systems	Refer to
Pre-crash seat belt system does not operate. (Neither RH nor LH operate.)	Ignition power supply system inspection	SBC-27
	Check motor power supply system	SBC-20
	Ground system inspection	SBC-28
	CAN communication system inspection	SBC-13
	When the above is normal, check connector housing for damage, looseness and poor connection. Replace pre-crash seat belt control unit if it is normal.	SBC-40
RH pre-crash seat belt system does not operate.	Check RH seat belt buckle switch system	SBC-25
	Check RH pre-crash seat belt motor system	SBC-14
	When the above is normal, check connector housing for damage, looseness and poor connection. Replace pre-crash seat belt control unit if it is normal.	SBC-40
LH pre-crash seat belt system does not operate.	Check LH seat belt buckle switch system	SBC-23
	Check LH pre-crash seat belt motor system	SBC-16
	When the above is normal, check connector housing for damage, looseness and poor connection. Replace pre-crash seat belt control unit if it is normal.	SBC-40
Pre-crash seat belt system does not operate during emergency brake operation.	CAN communication system inspection	SBC-13
	Check brake pedal stroke sensor system	SBC-18
	Check brake pedal stroke sensor shield ground system	SBC-22
	When the above is normal, check connector housing for damage, looseness and poor connection. Replace pre-crash seat belt control unit if it is normal.	SBC-40

PRECAUTIONS

< PRECAUTION >

PRECAUTION

PRECAUTIONS

Precaution for Supplemental Restraint System (SRS) "AIR BAG" and "SEAT BELT PRE-TENSIONER"

INFOID:000000001712090

The Supplemental Restraint System such as "AIR BAG" and "SEAT BELT PRE-TENSIONER", used along with a front seat belt, helps to reduce the risk or severity of injury to the driver and front passenger for certain types of collision. This system includes seat belt switch inputs and dual stage front air bag modules. The SRS system uses the seat belt switches to determine the front air bag deployment, and may only deploy one front air bag, depending on the severity of a collision and whether the front occupants are belted or unbelted. Information necessary to service the system safely is included in the "SRS AIRBAG" and "SEAT BELT" of this Service Manual.

WARNING:

- To avoid rendering the SRS inoperative, which could increase the risk of personal injury or death in the event of a collision which would result in air bag inflation, all maintenance must be performed by an authorized NISSAN/INFINITI dealer.
- Improper maintenance, including incorrect removal and installation of the SRS, can lead to personal injury caused by unintentional activation of the system. For removal of Spiral Cable and Air Bag Module, see the "SRS AIRBAG".
- Do not use electrical test equipment on any circuit related to the SRS unless instructed to in this Service Manual. SRS wiring harnesses can be identified by yellow and/or orange harnesses or harness connectors.

Precaution for Seat Belt Service

INFOID:000000001713405

CAUTION:

- Before removing the seat belt pre-tensioner assembly, turn the ignition switch off, disconnect the both battery cables and wait at least 3 minutes.
- Do not use electrical test equipment for seat belt pre-tensioner connector.
- After replacing or reinstalling seat belt pre-tensioner assembly, or reconnecting front seat belt pre-tensioner connector, check the system function. Refer to [SRC-15, "Diagnosis Description"](#).
- Do not use disassemble buckle or seat belt assembly.
- Replace anchor bolts if they are deformed or worn out.
- Never oil tongue and buckle.
- If any component of seat belt assembly is questionable, do not repair. Replace the whole seat belt assembly.
- If webbing is cut, frayed, or damaged, replace seat belt assembly.
- When replacing seat belt assembly, use a genuine NISSAN seat belt assembly.

AFTER A COLLISION

WARNING:

Inspect all seat belt assemblies including retractors and attaching hardware after any collision. NISSAN recommends that all seat belt assemblies in use during a collision be replaced unless the collision was minor and the belts show no damage and continue to operate properly. Failure to do so could result in serious personal injury in an accident. Seat belt assemblies not in use during a collision should also be replaced if either damage or improper operation is noted. Seat belt pre-tensioner should be replaced even if the seat belts are not in use during a frontal collision in which the air bags are deployed.

Replace any seat belt assembly (including anchor bolts) if:

- The seat belt was in use at the time of a collision (except for minor collisions and the belts, retractors and buckles show no damage and continue to operate properly).
- The seat belt was damaged in an accident. (i.e. torn webbing, bent retractor or guide).
- The seat belt attaching point was damaged in an accident. Inspect the seat belt attaching area for damage or distortion and repair as necessary before installing a new seat belt assembly.
- Anchor bolts are deformed or worn out.
- The seat belt pre-tensioner should be replaced even if the seat belts are not in use during the collision in which the air bags are deployed.

PRECAUTIONS

< PRECAUTION >

Precaution for Battery Service

INFOID:000000002912445

Before disconnecting the battery, lower both the driver and passenger windows. This will prevent any interference between the window edge and the vehicle when the door is opened/closed. During normal operation, the window slightly raises and lowers automatically to prevent any window to vehicle interference. The automatic window function will not work with the battery disconnected.

BRAKE PEDAL STROKE SENSOR

< ON-VEHICLE MAINTENANCE >

ON-VEHICLE MAINTENANCE

BRAKE PEDAL STROKE SENSOR

Exploded View

INFOID:000000001712019

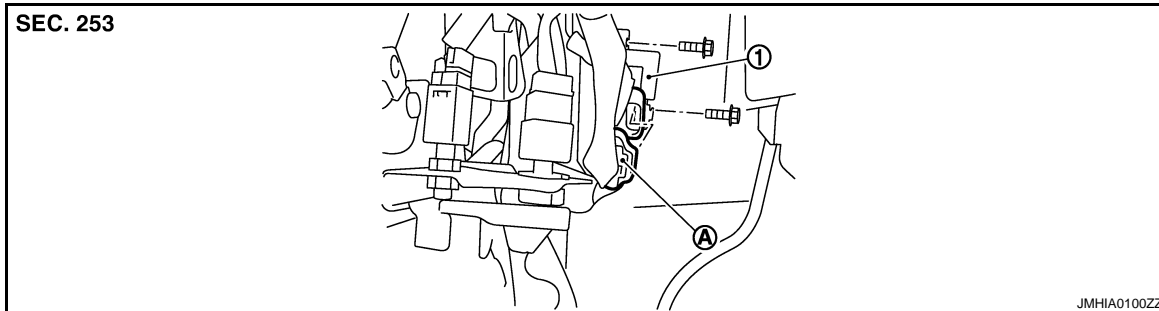

1. Brake pedal stroke sensor

A. Brake pedal stroke sensor connector

Removal and Installation

INFOID:000000001712020

REMOVAL

1. Remove the driver instrument panel (lower). Refer to [IP-12, "Removal and Installation"](#).
2. Disconnect the brake pedal stroke sensor connector (A).
3. Remove the screws.
4. Remove the brake pedal stroke sensor (1).

INSTALLATION

Install in the reverse order of removal.

A
B
C
D
E
F
G
I
J
K
L
M
N
O
P

SBC

PRE-CRASH SEAT BELT CONTROL UNIT

< ON-VEHICLE MAINTENANCE >

PRE-CRASH SEAT BELT CONTROL UNIT

Exploded View

INFOID:000000001712021

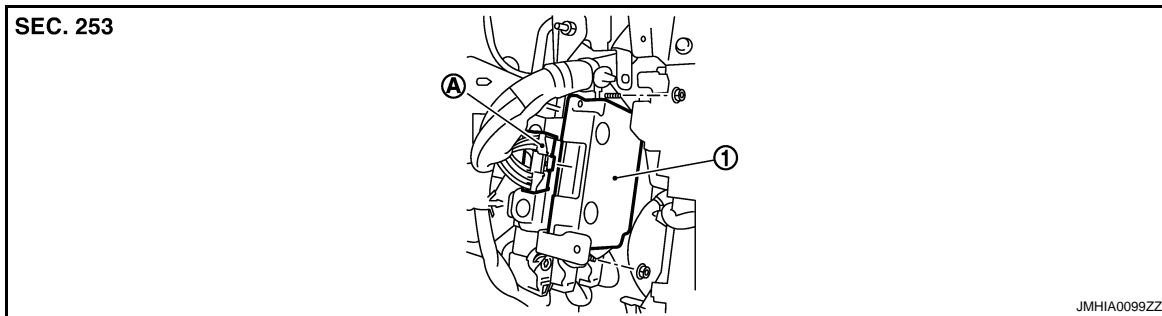

1. Pre-crash seat belt control unit A. Pre-crash seat belt control unit connector

Removal and Installation

INFOID:000000001712022

REMOVAL

1. Remove the glove box. Refer to [IP-12. "Removal and Installation"](#).
2. Disconnect the pre-crash seat belt control unit connector (A).
3. Remove the screws.
4. Remove the pre-crash seat belt control unit (1).

INSTALLATION

Install in the reverse order of removal.