

SECTION **RF**
ROOF

A

B

C

D

E

CONTENTS

<p>BASIC INSPECTION 3</p> <p>DIAGNOSIS AND REPAIR WORKFLOW 3</p> <p style="padding-left: 20px;">WorkFlow3</p> <p>INSPECTION AND ADJUSTMENT 4</p> <p>ADDITIONAL SERVICE WHEN REPLACING CONTROL UNIT4</p> <p style="padding-left: 20px;">ADDITIONAL SERVICE WHEN REPLACING CONTROL UNIT : Description4</p> <p style="padding-left: 20px;">ADDITIONAL SERVICE WHEN REPLACING CONTROL UNIT : Special Repair Requirement4</p> <p>FUNCTION DIAGNOSIS 5</p> <p>SUNROOF SYSTEM 5</p> <p style="padding-left: 20px;">System Diagram5</p> <p style="padding-left: 20px;">System Description5</p> <p style="padding-left: 20px;">Component Parts Location6</p> <p style="padding-left: 20px;">Component Description6</p> <p>DIAGNOSIS SYSTEM (BCM) 7</p> <p>COMMON ITEM7</p> <p style="padding-left: 20px;">COMMON ITEM : CONSULT-III Function (BCM - COMMON ITEM)7</p> <p>RETAINED PWR8</p> <p style="padding-left: 20px;">RETAINED PWR : CONSULT-III Function (BCM - RETAINED PWR)8</p> <p>COMPONENT DIAGNOSIS 9</p> <p>POWER SUPPLY AND GROUND CIRCUIT 9</p> <p>BCM (BODY CONTROL MODULE)9</p> <p style="padding-left: 20px;">BCM (BODY CONTROL MODULE) : Diagnosis Procedure9</p> <p>SUNROOF MOTOR ASSEMBLY9</p> <p style="padding-left: 20px;">SUNROOF MOTOR ASSEMBLY : Description9</p>	<p>SUNROOF MOTOR ASSEMBLY : Diagnosis Procedure 9</p> <p>SUNROOF SWITCH11</p> <p style="padding-left: 20px;">Description11</p> <p style="padding-left: 20px;">Component Function Check11</p> <p style="padding-left: 20px;">Diagnosis Procedure11</p> <p style="padding-left: 20px;">Component Inspection12</p> <p>DOOR SWITCH13</p> <p style="padding-left: 20px;">Description13</p> <p style="padding-left: 20px;">Component Function Check13</p> <p style="padding-left: 20px;">Diagnosis Procedure13</p> <p style="padding-left: 20px;">Component Inspection14</p> <p>SUNROOF15</p> <p style="padding-left: 20px;">Wiring Diagram - SUNROOF -15</p> <p>ECU DIAGNOSIS19</p> <p>BCM (BODY CONTROL MODULE)19</p> <p style="padding-left: 20px;">Reference Value19</p> <p style="padding-left: 20px;">Wiring Diagram - BCM -43</p> <p style="padding-left: 20px;">Fail-safe49</p> <p style="padding-left: 20px;">DTC Inspection Priority Chart51</p> <p style="padding-left: 20px;">DTC Index53</p> <p>SUNROOF SYSTEM55</p> <p>SUNROOF MOTOR ASSEMBLY55</p> <p style="padding-left: 20px;">SUNROOF MOTOR ASSEMBLY : Reference Value55</p> <p style="padding-left: 20px;">SUNROOF MOTOR ASSEMBLY : Wiring Diagram - SUNROOF -56</p> <p>SYMPTOM DIAGNOSIS60</p> <p>SUNROOF DOES NOT OPERATE PROPERLY60</p> <p style="padding-left: 20px;">Diagnosis Procedure60</p> <p>AUTO OPERATION DOES NOT OPERATE61</p> <p style="padding-left: 20px;">Diagnosis Procedure61</p>
---	--

F

G

H

I

J

RF

L

M

N

O

P

DOES NOT STOP FULLY-OPEN OR FULLY-CLOSED POSITION	62	PREPARATION	72
Diagnosis Procedure	62	Special Service Tool	72
POWER WINDOW RETAINED POWER OPERATION DOES NOT OPERATE PROPERLY	63	Commercial Service Tool	72
Diagnosis Procedure	63	ON-VEHICLE REPAIR	73
SUNROOF DOES NOT OPERATE ANTI-PINCH FUNCTION	64	GLASS LID	73
Diagnosis Procedure	64	Exploded View	73
SQUEAK AND RATTLE TROUBLE DIAGNOSES	65	Removal and Installation	73
Work Flow	65	Adjustment	74
Inspection Procedure	67	SUNROOF MOTOR ASSEMBLY	75
Diagnostic Worksheet	69	Exploded View	75
PRECAUTION	71	Removal and Installation	75
PRECAUTIONS	71	SUNROOF UNIT ASSEMBLY	77
Precaution for Supplemental Restraint System (SRS) "AIR BAG" and "SEAT BELT PRE-TENSIONER"	71	Exploded View	77
Precaution Necessary for Steering Wheel Rotation after Battery Disconnect	71	Removal and Installation	78
PREPARATION	72	Disassembly and Assembly	79
		SUNSHADE	80
		Exploded View	80
		Removal and Installation	80
		WIND DEFLECTOR	82
		Exploded View	82
		Removal and Installation	82
		SUNROOF SWITCH	83
		Exploded View	83
		Removal and Installation	83

DIAGNOSIS AND REPAIR WORKFLOW

< BASIC INSPECTION >

BASIC INSPECTION

DIAGNOSIS AND REPAIR WORKFLOW

WorkFlow

INFOID:000000003136999

DETAILED FLOW

1.OBTAIN INFORMATION ABOUT SYMPTOM

Interview the customer to obtain the malfunction information (conditions and environment when the malfunction occurred) as much as possible when the customer brings the vehicle in.

>> GO TO 2.

2.REPRODUCE THE MALFUNCTION INFORMATION

Check the malfunction on the vehicle that the customer describes.
Inspect the relation of the symptoms and the condition when the symptoms occur.

>> GO TO 3.

3.IDENTIFY THE MALFUNCTIONING SYSTEM WITH "SYMPTOM DIAGNOSIS"

Use "Symptom diagnosis" from the symptom inspection result in step 2 and then identify where to start performing the diagnosis based on possible causes and symptoms.

>> GO TO 4.

4.IDENTIFY THE MALFUNCTIONING PARTS WITH "COMPONENT DIAGNOSIS"

Perform the diagnosis with "Component diagnosis" of the applicable system.

>> GO TO 5.

5.REPAIR OR REPLACE THE MALFUNCTIONING PARTS

Repair or replace the specified malfunctioning parts.

>> GO TO 6.

6.FINAL CHECK

Check that malfunctions are not reproduced when obtaining the malfunction information from the customer, referring to the symptom inspection result in step 2.

Are the malfunctions corrected?

YES >> INSPECTION END

NO >> GO TO 3.

A
B
C
D
E
F
G
H
I
J
RF
L
M
N
O
P

INSPECTION AND ADJUSTMENT

< BASIC INSPECTION >

INSPECTION AND ADJUSTMENT

ADDITIONAL SERVICE WHEN REPLACING CONTROL UNIT

ADDITIONAL SERVICE WHEN REPLACING CONTROL UNIT : Description

INFOID:000000003738640

MEMORY RESET PROCEDURE

1. Please observe the following instructions at confirming the sunroof operation.

NOTE:

Do not disconnect the electronic power while the sunroof is operating or within after the sunroof stops (to wipe-out the memory of lid position and operating friction).

2. Initialization of system should be conducted after the following conditions.
 - When the sunroof motor is changed.
 - When the sunroof does not operate normally. (Incomplete initialization conditions)

ADDITIONAL SERVICE WHEN REPLACING CONTROL UNIT : Special Repair Requirement

INFOID:000000003738641

INITIALIZATION PROCEDURE

If the sunroof does not close or open automatically, use the following procedure to return sunroof operation to normal.

1. Press the tilt up switch and start the tilt up operation.
2. Release the tilt up switch once, press the tilt up switch again, press and hold the switch until lid pops up.
3. The glass lid moves slight toward tilt up direction then stop. (Press and hold the switch during this operation)
4. Release the switch again, and press the tilt up switch within the first 10 seconds. (Press and hold the switch)
5. After 4 seconds, the glass lid will be automatically operated in sequence of tilt down, slide open and slide close.
6. After the glass lid stops, release the switch 0.5 second later. (Press and hold the switch during this operation)
7. If slide switch operates normally, this initialization is done.

ANTI-PINCH FUNCTION

1. Full open the sunroof.
2. Place a wooden piece (wooden hammer handle, etc.) at near fully closed position.
3. Close the sunroof completely with auto-slide close.

Check that sunroof lowers for approximately 150 mm (5.91in) or 2 seconds with out pinching a wooden piece and stops.

CAUTION:

- Do not check with hands and other part of body because they may be pinched. Do not get pinched.
- Depending on environment and driving conditions, if a similar impact or load is applied to the sunroof it may lower.
- Check that auto-slide operation before inspection when system initialization is performed.
- Perform initial setting when auto-slide operation or anti-pinch function does not operate normally.

SUNROOF SYSTEM

< FUNCTION DIAGNOSIS >

FUNCTION DIAGNOSIS

SUNROOF SYSTEM

System Diagram

INFOID:000000003137002

SUNROOF

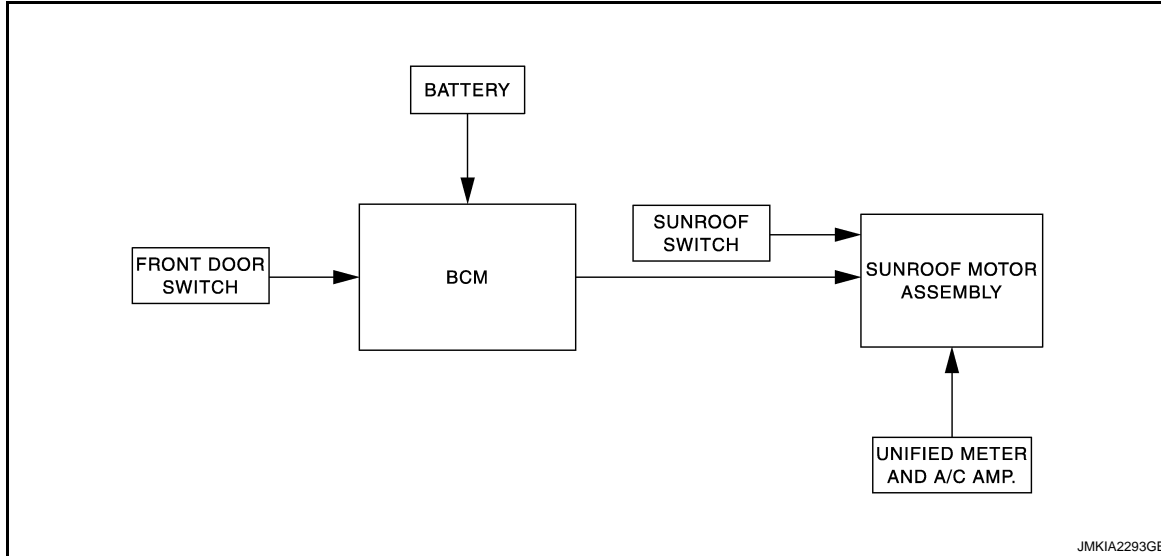

System Description

INFOID:000000003137003

SUNROOF SYSTEM

INPUT/OUTPUT SIGNAL CHART

Item	Input signal to sunroof motor assembly	Sunroof motor function	Actuator
Sunroof switch	Sunroof switch signal (tilt down or slide open)	Sunroof control	Sunroof motor
	Sunroof switch signal (tilt up or slide close)		
Unified meter and A/C amp.	Vehicle speed signal		
BCM	Retained power signal		

SUNROOF OPERATION

- Sunroof motor assembly operates with the power supply that is output from BCM while ignition switch is ON or retained power is operating.
- Tilt up/down & slide open/close signals from sunroof switch enables operate sunroof motor to move arbitrarily.
- Sunroof motor assembly receives a vehicle speed signal from unified meter and A/C amp. and controls the sunroof motor torque of tilt-down at the time of high speed operation.

AUTO OPERATION

Sunroof AUTO feature makes it possible to slide open and slide close or tilt up and tilt down the sunroof without holding the sunroof switch in the slide open/tilt down or slide close/tilt up position.

RETAINED POWER OPERATION

- Retained power operation is an additional power supply function that enables sunroof system to operate during 45 seconds even when ignition switch is turned OFF.

RETAINED POWER FUNCTION CANCEL CONDITIONS

- Front door CLOSE (door switch OFF)→OPEN (door switch ON).
- When ignition switch is ON again.

SUNROOF SYSTEM

< FUNCTION DIAGNOSIS >

- When timer time passes. (45 seconds)

ANTI-PINCH FUNCTION

The CPU of sunroof motor assembly monitors the sunroof motor operation and the sunroof position (fully-closed or other) by the signals from sunroof motor.

When sunroof motor detects an interruption during the following slide close and tilt down operation, sunroof switch controls the motor for open and the sunroof will operate until full up position (when tilt down operate) or 150 mm (5.91 in) or more in an open direction (when slide close operate):

- close operation and tilt down when ignition switch is in the "ON" position

Component Parts Location

INFOID:000000003137004

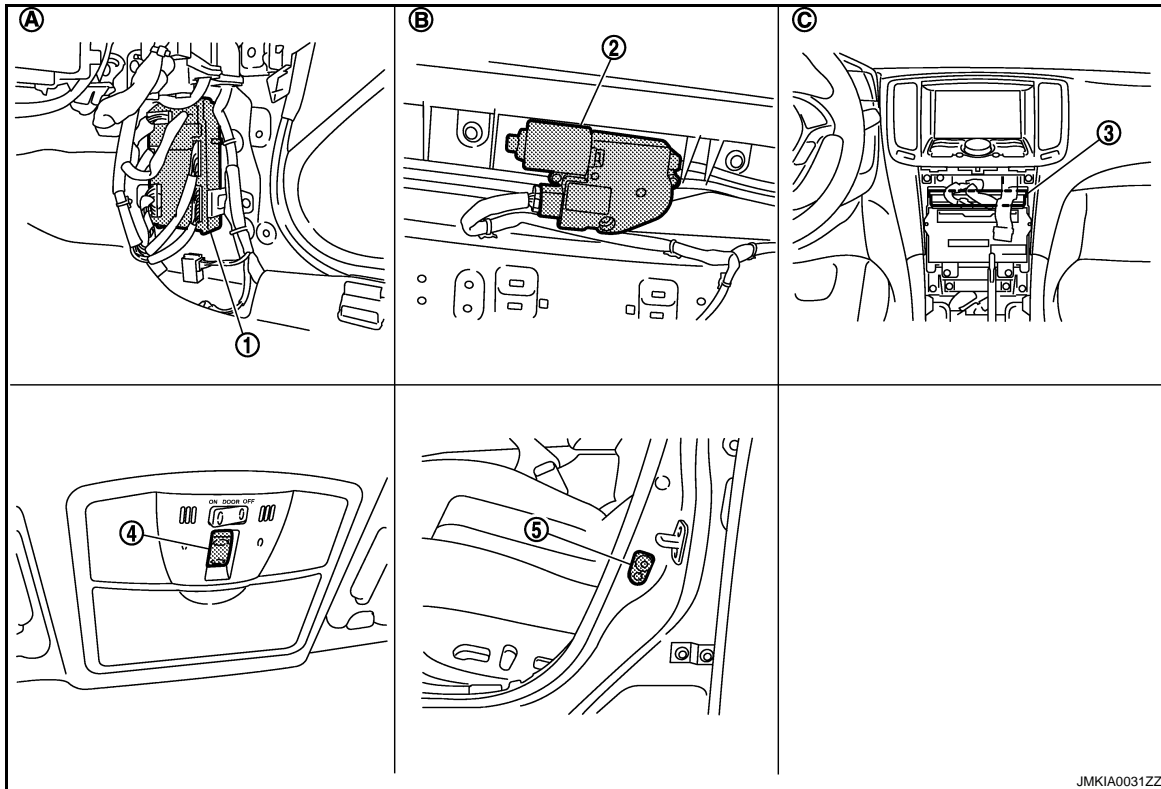

- | | | |
|-------------------------|--|-----------------------------------|
| 1. BCM M118, M119, M123 | 2. Sunroof motor assembly R4 | 3. Unified meter and A/C amp. M66 |
| 4. Sunroof switch R16 | 5. Front door switch (driver side) B16 | |

- | | | |
|-------------------------------------|---------------------------------|-------------------------|
| A. Dash side lower (passenger side) | B. View with headlining removed | C. Behind cluster lid C |
|-------------------------------------|---------------------------------|-------------------------|

Component Description

INFOID:000000003137005

Component	Function
BCM	Supplies the power supply to sunroof motor assembly. Controls retained power.
Sunroof switch	Transmits tilt up/down & slides open/close operation signal to sunroof motor assembly.
Sunroof motor assembly	It is sunroof motor and CPU integrated type that enables tilt up/down & slide open/close by sunroof switch operation
Front door switch	Detects door open/close condition and transmits to BCM.
Unified meter and A/C amp.	Transmits vehicle speed signal to sunroof motor assembly.

DIAGNOSIS SYSTEM (BCM)

< FUNCTION DIAGNOSIS >

DIAGNOSIS SYSTEM (BCM)

COMMON ITEM

COMMON ITEM : CONSULT-III Function (BCM - COMMON ITEM)

INFOID:000000003703355

APPLICATION ITEM

CONSULT-III performs the following functions via CAN communication with BCM.

Diagnosis mode	Function Description
Work Support	Changes the setting for each system function.
Self Diagnostic Result	Displays the diagnosis results judged by BCM.
CAN Diag Support Monitor	Monitors the reception status of CAN communication viewed from BCM. Refer to CONSULT-III operation manual.
Data Monitor	The BCM input/output signals are displayed.
Active Test	The signals used to activate each device are forcibly supplied from BCM.
Ecu Identification	The BCM part number is displayed.
Configuration	<ul style="list-style-type: none"> Read and save the vehicle specification. Write the vehicle specification when replacing BCM.

SYSTEM APPLICATION

BCM can perform the following functions for each system.

NOTE:

It can perform the diagnosis modes except the following for all sub system selection items.

×: Applicable item

System	Sub system selection item	Diagnosis mode		
		Work Support	Data Monitor	Active Test
Door lock	DOOR LOCK	×	×	×
Rear window defogger	REAR DEFOGGER		×	×
Warning chime	BUZZER		×	×
Interior room lamp timer	INT LAMP	×	×	×
Exterior lamp	HEAD LAMP	×	×	×
Wiper and washer	WIPER		×	×
Turn signal and hazard warning lamps	FLASHER	×	×	×
—	AIR CONDITONER*			
<ul style="list-style-type: none"> Intelligent Key system Engine start system 	INTELLIGENT KEY	×	×	×
Combination switch	COMB SW		×	
Body control system	BCM	×		
IVIS - NATS	IMMU		×	×
Interior room lamp battery saver	BATTERY SAVER	×	×	×
—	TRUNK*		×	×
Vehicle security system	THEFT ALM	×	×	×
RAP system	RETAINED PWR		×	
Signal buffer system	SIGNAL BUFFER		×	×
TPMS	TPMS (AIR PRESSURE MONITOR)	×	×	×

NOTE:

*: This item is displayed, but is not used.

FREEZE FRAME DATA (FFD) AND IGN COUNTER

Freeze Frame Data

DIAGNOSIS SYSTEM (BCM)

< FUNCTION DIAGNOSIS >

The BCM records the following condition at the moment a particular DTC is detected.

- Vehicle Speed
- Odd Trip Meter
- Vehicle Condition (BCM detected condition)

CONSULT screen terms	Description
SLEEP>LOCK	While turning BCM status from low power consumption mode to normal mode (Power supply position is "LOCK")
SLEEP>OFF	While turning BCM status from low power consumption mode to normal mode (Power supply position is "OFF".)
LOCK>ACC	While turning power supply position from "LOCK" to "ACC"
ACC>ON	While turning power supply position from "ACC" to "IGN"
RUN>ACC	While turning power supply position from "RUN" to "ACC" (Vehicle is stopping and selector lever is except P position.)
CRANK>RUN	While turning power supply position from "CRANKING" to "RUN" (From cranking up the engine to run it)
RUN>URGENT	While turning power supply position from "RUN" to "ACC" (Emergency stop operation)
ACC>OFF	While turning power supply position from "ACC" to "OFF"
OFF>LOCK	While turning power supply position from "OFF" to "LOCK"
OFF>ACC	While turning power supply position from "OFF" to "ACC"
ON>CRANK	While turning power supply position from "IGN" to "CRANKING"
OFF>SLEEP	While turning BCM status from normal mode (Power supply position is "OFF".) to low power consumption mode
LOCK>SLEEP	While turning BCM status from normal mode (Power supply position is "LOCK".) to low power consumption mode
LOCK	Power supply position is "LOCK" (Ignition switch OFF with steering is locked.)
OFF	Power supply position is "OFF" (Ignition switch OFF with steering is unlocked.)
ACC	Power supply position is "ACC" (Ignition switch ACC)
ON	Power supply position is "IGN" (Ignition switch ON with engine stopped)
ENGINE RUN	Power supply position is "RUN" (Ignition switch ON with engine running)
CRANKING	Power supply position is "CRANKING" (At engine cranking)

IGN Counter

IGN counter indicates the number of times that ignition switch is turned ON after DTC is detected.

- The number is 0 when a malfunction is detected now.
- The number increases like 1 → 2 → 3...38 → 39 after returning to the normal condition whenever ignition switch OFF → ON.
- The number is fixed to 39 until the self-diagnosis results are erased if it is over 39.

RETAINED PWR

RETAINED PWR : CONSULT-III Function (BCM - RETAINED PWR)

INFOID:000000003137007

Data monitor

Monitor Item	Description
DOOR SW-DR	Indicates [ON/OFF] condition of driver side door switch.
DOOR SW-AS	Indicates [ON/OFF] condition of passenger side door switch.

POWER SUPPLY AND GROUND CIRCUIT

< COMPONENT DIAGNOSIS >

COMPONENT DIAGNOSIS

POWER SUPPLY AND GROUND CIRCUIT

BCM (BODY CONTROL MODULE)

BCM (BODY CONTROL MODULE) : Diagnosis Procedure

INFOID:000000003703350

1. CHECK FUSE AND FUSIBLE LINK

1. Turn ignition switch OFF.
2. Check that the following fuse and fusible link are not blown.

Terminal No.	Signal name	Fuse and fusible link No.
1	Battery power supply	K (40A)
11		10 (10A)

Is the fuse fusing?

- YES >> Replace the blown fuse or fusible link after repairing the affected circuit if a fuse or fusible link is blown.
NO >> GO TO 2.

2. CHECK POWER SUPPLY CIRCUIT

1. Disconnect BCM connectors.
2. Check voltage between BCM harness connector and ground.

(+)		(-)	Voltage (Approx.)
BCM			
Connector	Terminal	Ground	Battery voltage
M118	1		
M119	11		

Is the inspection result normal?

- YES >> GO TO 3.
NO >> Repair or replace harness or connector.

3. CHECK GROUND CIRCUIT

Check continuity between BCM harness connector and ground.

BCM		Ground	Continuity
Connector	Terminal		
M119	13		Existed

Is the inspection result normal?

- YES >> INSPECTION END
NO >> Repair or replace harness or connector.

SUNROOF MOTOR ASSEMBLY

SUNROOF MOTOR ASSEMBLY : Description

INFOID:000000003601788

- BCM supplies power.
- It is sunroof motor and CPU integrated type.
- Tilt up/down & slide open/close by sunroof switch operation.

SUNROOF MOTOR ASSEMBLY : Diagnosis Procedure

INFOID:000000003601789

SUNROOF MOTOR ASSEMBLY

1. CHECK POWER SUPPLY CIRCUIT

A
B
C
D
E
F
G
H
I
J
RF
L
M
N
O
P

POWER SUPPLY AND GROUND CIRCUIT

< COMPONENT DIAGNOSIS >

1. Turn ignition switch OFF.
2. Disconnect sunroof motor assembly connector.
3. Turn ignition switch ON.
4. Check voltage between sunroof motor assembly harness connector and ground.

(+)		(-)	Voltage (V) (Approx.)
Sunroof motor assembly			
Connector	Terminal	Ground	Battery voltage
R4	9		
	7		

Is the inspection result normal?

YES >> GO TO 2.

NO >> GO TO 3.

2. CHECK GROUND CIRCUIT

1. Turn ignition switch OFF.
2. Check continuity between sunroof motor assembly harness connector and ground.

Sunroof motor assembly		Ground	Continuity
Connector	Terminal		
R4	10		Exists

Is the inspection result normal?

YES >> INSPECTION END

NO >> Repair or replace harness or connector.

3. CHECK SUNROOF MOTOR CIRCUIT

1. Turn ignition switch OFF.
2. Disconnect BCM connector.
3. Check continuity between BCM harness connector and sunroof motor assembly harness connector.

BCM		Sunroof motor assembly		Continuity
Connector	Terminal	Connector	Terminal	
M118	2	R4	7	Exists
	3		9	

4. Check continuity between BCM harness connector and ground.

BCM		Ground	Continuity
Connector	Terminal		
M118	2		Not exist
	3		

Is the inspection result normal?

YES >> Replace BCM. Refer to [BCS-84. "Removal and Installation"](#).

NO >> Repair or replace harness or connector.

SUNROOF SWITCH

< COMPONENT DIAGNOSIS >

SUNROOF SWITCH

Description

INFOID:000000003601790

Tilt up/down & slide open/close by sunroof switch operation.

Component Function Check

INFOID:000000003601791

1.CHECK SUNROOF MOTOR OPERATION

Check tilt up/down & slide open/close operations with sunroof switch.

Is the inspection result normal?

- YES >> Sunroof switch is OK.
NO >> Refer to [RF-11, "Diagnosis Procedure"](#).

Diagnosis Procedure

INFOID:000000003601792

SUNROOF SWITCH

1.CHECK SUNROOF SWITCH POWER SUPPLY CIRCUIT

1. Turn ignition switch OFF.
2. Disconnect sunroof switch connector.
3. Turn ignition switch ON.
4. Check voltage between sunroof switch harness connector and ground.

(+)		(-)	Voltage (V) (Approx.)
Sunroof switch			
Connector	Terminal	Ground	Battery voltage
R16	1		
	3		

Is the inspection result normal?

- YES >> GO TO 2.
NO >> GO TO 4.

2.CHECK GROUND CIRCUIT

1. Turn ignition switch OFF.
2. Check continuity between sunroof switch harness connector and ground.

Sunroof switch		Ground	Continuity
Connector	Terminal		Exist
R16	2		

Is the inspection result normal?

- YES >> GO TO 3.
NO >> Repair or replace harness or connector.

3.CHECK SUNROOF SWITCH

Check sunroof switch.

Refer to [RF-12, "Component Inspection"](#).

Is the inspection result normal?

- YES >> GO TO 5.
NO >> Replace sunroof switch (built in map lamp assembly). Refer to [RF-83, "Removal and Installation"](#).

4.CHECK SUNROOF SWITCH CIRCUIT

1. Turn ignition switch OFF.
2. Disconnect sunroof motor assembly connector.
3. Check continuity between sunroof switch assembly harness connector and sunroof switch harness connector.

SUNROOF SWITCH

< COMPONENT DIAGNOSIS >

Sunroof switch		Sunroof motor assembly		Continuity
Connector	Terminal	Connector	Terminal	
R16	1	R4	5	Exist
	3		1	

4. Check continuity between sunroof switch assembly harness connector and ground.

Sunroof motor assembly		Ground	Continuity
Connector	Terminal		
R4	5		Not exist
	1		

Is the inspection result normal?

YES >> Replace sunroof motor assembly. [RF-75. "Removal and Installation"](#)

NO >> Repair or replace harness or connector.

5. CHECK INTERMITTENT INCIDENT

Refer to [GI-38. "Intermittent Incident"](#).

>> INSPECTION END

Component Inspection

INFOID:000000003601793

SUNROOF SWITCH

1. CHECK SUNROOF SWITCH

1. Turn ignition switch OFF.
2. Disconnect sunroof switch connector.
3. Check continuity sunroof switch terminals.

Terminals		Condition	Continuity
1	2	Sunroof switch is operated TILT DOWN or SLIDE OPEN	Exists
		Other than above	Not exist
3		Sunroof switch is operated TILT UP or SLIDE CLOSE	Exists
		Other than above	Not exist

Is the inspection result normal?

YES >> INSPECTION END

NO >> Replace sunroof switch (built in map lamp assembly). Refer to [RF-83. "Removal and Installation"](#).

DOOR SWITCH

< COMPONENT DIAGNOSIS >

DOOR SWITCH

Description

INFOID:000000003703351

Detects door open/closed condition.

Component Function Check

INFOID:000000003703352

1.CHECK FUNCTION

Check door switches ("DOOR SW-DR", "DOOR SW-AS") in "Data Monitor" mode with CONSULT-III.

Monitor item	Door condition	Display
DOOR SW-DR	CLOSE → OPEN	OFF → ON
DOOR SW-AS		

Is the inspection result normal?

- YES >> Door switch is OK.
 NO >> Refer to [RF-13, "Diagnosis Procedure"](#).

Diagnosis Procedure

INFOID:000000003703353

1.CHECK FRONT DOOR SWITCH INPUT SIGNAL

- Turn ignition switch OFF.
- Disconnect malfunction front door switch connector.
- Check signal between malfunction front door switch harness connector and ground with oscilloscope.

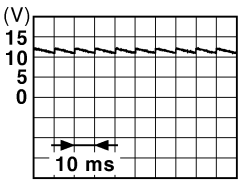
(+)		Terminal	(-)	Voltage (V) (Approx.)
Front door switch				
Connector				
Driver side	B16	2	Ground	
Passenger side	B216			

JPMA0011GB

Is the inspection result normal?

- YES >> GO TO 3.
 NO >> GO TO 2.

2.CHECK DOOR SWITCH CIRCUIT

- Disconnect BCM connector.
- Check continuity between BCM harness connector and malfunction door switch harness connector.

BCM		Front door switch		Continuity
Connector	Terminal	Connector	Terminal	
M123	124	B216	2	Exists
	150	B16		

- Check continuity between BCM harness connector and ground.

BCM		Ground	Continuity
Connector	Terminal		
M123	124		Not exist
	150		

DOOR SWITCH

< COMPONENT DIAGNOSIS >

Is the inspection result normal?

YES >> Replace BCM. Refer to [BCS-84, "Removal and Installation"](#).

NO >> Repair or replace harness.

3.CHECK FRONT DOOR SWITCH

Check front door switch.

Refer to [PWC-27, "Component Inspection"](#).

Is the inspection result normal?

YES >> GO TO 4.

NO >> Replace malfunction front door switch. Refer to [DLK-257, "Removal and Installation"](#).

4.CHECK INTERMITTENT INCIDENT

Refer to [GI-38, "Intermittent Incident"](#).

>> INSPECTION END

Component Inspection

INFOID:000000003703354

1.CHECK FRONT DOOR SWITCH

1. Turn ignition switch OFF.
2. Disconnect malfunction front door switch connector.
3. Check malfunction front door switch.

(+)			(-)	Condition	Continuity		
Front door switch							
Connector		Terminal	Ground part of door switch				
Driver side	B16	2				Door switch pressed	Not exist
						Door switch released	Exists
Passenger side	B216	2				Door switch pressed	Not exist
			Door switch released	Exists			

Is the inspection result normal?

YES >> Front door switch is OK.

NO >> Replace malfunction front door switch. Refer to [DLK-257, "Removal and Installation"](#).

SUNROOF

< COMPONENT DIAGNOSIS >

SUNROOF

Wiring Diagram - SUNROOF -

INFOID:000000003757458

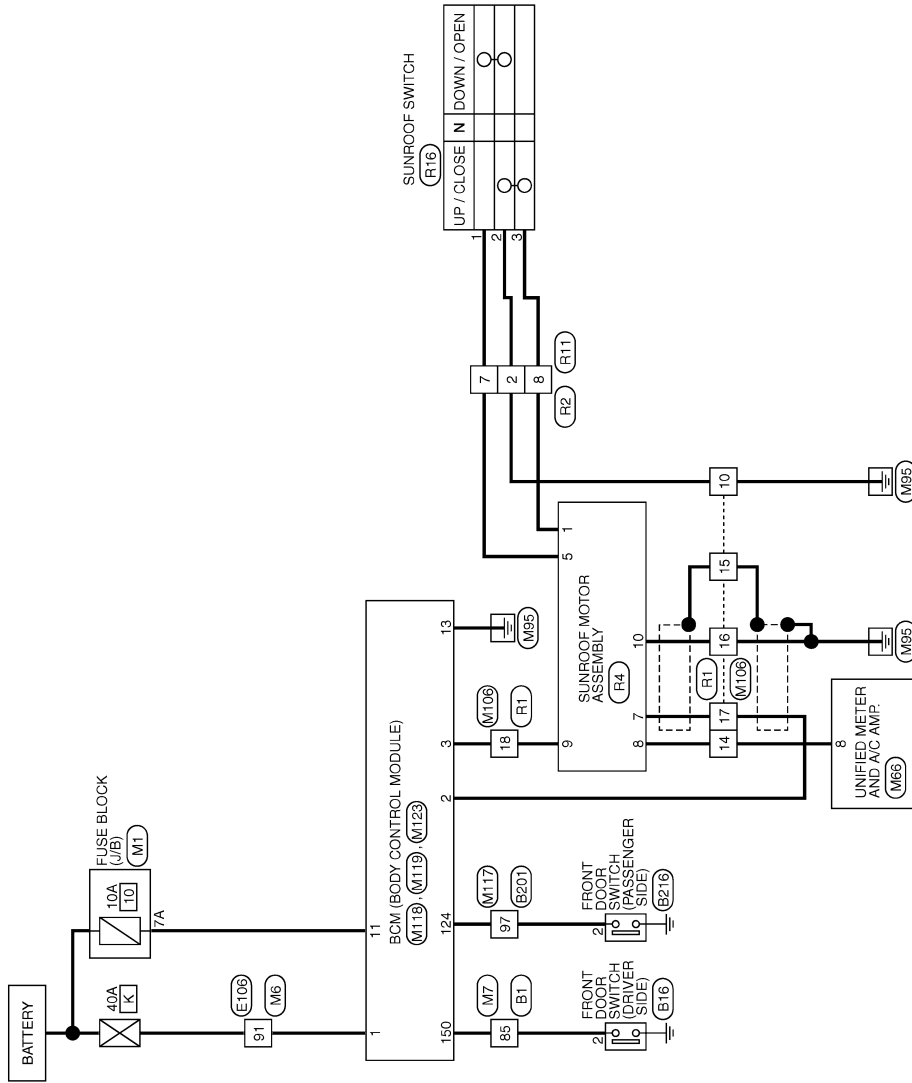

SUNROOF

2007/10/26



JCKWM1099GI

A
B
C
D
E
F
G
H
I
J
RF
L
M
N
O
P

SUNROOF

< COMPONENT DIAGNOSIS >

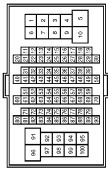
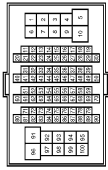
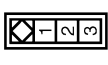
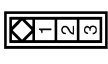
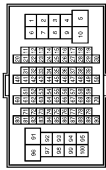
SUNROOF

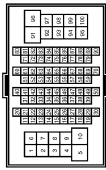
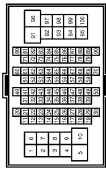
Connector No. B1	Connector Name WIRE TO WIRE	Connector Type TH80FW-CS16-TM4		Terminal No. 85	Color of Wire V	Signal Name [Specification]
Connector No. B201	Connector Name WIRE TO WIRE	Connector Type TH80FW-CS16-TM4		Terminal No. 97	Color of Wire GR	Signal Name [Specification]
Connector No. B16	Connector Name FRONT DOOR SWITCH (DRIVER SIDE)	Connector Type AG3FW		Terminal No. 2	Color of Wire V	Signal Name [Specification]
Connector No. B216	Connector Name FRONT DOOR SWITCH (PASSENGER SIDE)	Connector Type AG3FW		Terminal No. 2	Color of Wire GR	Signal Name [Specification]
Connector No. E108	Connector Name WIRE TO WIRE	Connector Type TH80FW-CS16-TM4		Terminal No. 91	Color of Wire W	Signal Name [Specification]
Connector No. M1	Connector Name FUSE BLOCK (J/B)	Connector Type NS00FW-M2		Terminal No. 7A	Color of Wire R	Signal Name [Specification]
Connector No. M6	Connector Name WIRE TO WIRE	Connector Type TH80MW-CS16-TM4		Terminal No. 91	Color of Wire W	Signal Name [Specification]
Connector No. M7	Connector Name WIRE TO WIRE	Connector Type TH80MW-CS16-TM4		Terminal No. 85	Color of Wire LG	Signal Name [Specification]

JCKWM1100GI

SUNROOF

< COMPONENT DIAGNOSIS >

SUNROOF

Connector No. M66	UNIFIED METER AND A/C AMP.	TH46FW-NH		Terminal No. 8	Color of Wire L	Signal Name [Specification] VEHICLE SPEED (2-PULSE)
Connector No. M106	WIRE TO WIRE	TK10MP-NS8		Terminal No. 10	B	
Connector No. M117	WIRE TO WIRE	TH82MP-CS16-TM4		Terminal No. 97	LG	
Connector No. M118	BCM (BODY CONTROL MODULE)	MD3FB-LC		Terminal No. 1	W	Signal Name [Specification] BAT (F/L)
				2	Y	POWER WINDOW POWER SUPPLY(BAT)
				3	O	POWER WINDOW POWER SUPPLY(RAP)
Connector No. M119	BCM (BODY CONTROL MODULE)	NS16FW-CS		Connector No. M123	BCM (BODY CONTROL MODULE)	TH46FG-NH
Connector No. M19	BCM (BODY CONTROL MODULE)	NS16FW-CS		Connector No. M123	BCM (BODY CONTROL MODULE)	TH46FG-NH
Connector No. R2	WIRE TO WIRE	TH12FW-NH		Connector No. R1	WIRE TO WIRE	TK10FW-NS8
Connector No. R2	WIRE TO WIRE	TH12FW-NH		Connector No. R1	WIRE TO WIRE	TK10FW-NS8
Terminal No. 11	R	BAT (FUSE)		Terminal No. 10	B	
13	B	GND		14	L	
				15	SHIELD	
				16	G	
				17	BR	
				18	Y	
Terminal No. 124	LG	PASSENGER DOOR SW		Terminal No. 14	L	
150	LG	DRIVER DOOR SW		15	SHIELD	
				16	B	
				17	Y	
				18		

JCKWM1101G1

A
B
C
D
E
F
G
H
I
J
RF
L
M
N
O
P

SUNROOF

Connector No.	R4
Connector Name	SUNROOF MOTOR ASSEMBLY
Connector Type	YEA10GY



Terminal No.	Color of Wire	Signal Name [Specification]
1	GR	SW-BIT1
5	P	SW-BIT0
7	W	4B
8	L	SPEED SENSOR(2P)
9	Y	TIMER(IGN)
10	B	GND

Connector No.	R11
Connector Name	WIRE TO WIRE
Connector Type	TH12MPF-BH

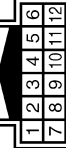

Terminal No.	Color of Wire	Signal Name [Specification]
2	B	
7	P	
8	BR	

Connector No.	R16
Connector Name	SUNROOF SWITCH
Connector Type	TKG9FW



Terminal No.	Color of Wire	Signal Name [Specification]
1	P	
2	B	
3	BR	

JCKWM1102GI

BCM (BODY CONTROL MODULE)

< ECU DIAGNOSIS >

ECU DIAGNOSIS

BCM (BODY CONTROL MODULE)

Reference Value

INFOID:000000003773250

VALUES ON THE DIAGNOSIS TOOL

CONSULT-III MONITOR ITEM

Monitor Item	Condition	Value/Status
FR WIPER HI	Other than front wiper switch HI	Off
	Front wiper switch HI	On
FR WIPER LOW	Other than front wiper switch LO	Off
	Front wiper switch LO	On
FR WASHER SW	Front washer switch OFF	Off
	Front washer switch ON	On
FR WIPER INT	Other than front wiper switch INT	Off
	Front wiper switch INT	On
FR WIPER STOP	Front wiper is not in STOP position	Off
	Front wiper is in STOP position	On
INT VOLUME	Wiper intermittent dial is in a dial position 1 - 7	Wiper intermittent dial position
RR WIPER ON	Other than rear wiper switch ON	Off
	Rear wiper switch ON	On
RR WIPER INT	Other than rear wiper switch INT	Off
	Rear wiper switch INT	On
RR WASHER SW	Rear washer switch OFF	Off
	Rear washer switch ON	On
RR WIPER STOP	Rear wiper is in STOP position	Off
	Rear wiper is not in STOP position	On
TURN SIGNAL R	Other than turn signal switch RH	Off
	Turn signal switch RH	On
TURN SIGNAL L	Other than turn signal switch LH	Off
	Turn signal switch LH	On
TAIL LAMP SW	Other than lighting switch 1ST and 2ND	Off
	Lighting switch 1ST or 2ND	On
HI BEAM SW	Other than lighting switch HI	Off
	Lighting switch HI	On
HEAD LAMP SW 1	Other than lighting switch 2ND	Off
	Lighting switch 2ND	On
HEAD LAMP SW 2	Other than lighting switch 2ND	Off
	Lighting switch 2ND	On
PASSING SW	Other than lighting switch PASS	Off
	Lighting switch PASS	On
AUTO LIGHT SW	Other than lighting switch AUTO	Off
	Lighting switch AUTO	On
FR FOG SW	Front fog lamp switch OFF	Off
	Front fog lamp switch ON	On

BCM (BODY CONTROL MODULE)

< ECU DIAGNOSIS >

Monitor Item	Condition	Value/Status
RR FOG SW	NOTE: The item is indicated, but not monitored.	Off
DOOR SW-DR	Driver door closed	Off
	Driver door opened	On
DOOR SW-AS	Passenger door closed	Off
	Passenger door opened	On
DOOR SW-RR	Rear RH door closed	Off
	Rear RH door opened	On
DOOR SW-RL	Rear LH door closed	Off
	Rear LH door opened	On
DOOR SW-BK	Back door closed	Off
	Back door opened	On
CDL LOCK SW	Other than power door lock switch LOCK	Off
	Power door lock switch LOCK	On
CDL UNLOCK SW	Other than power door lock switch UNLOCK	Off
	Power door lock switch UNLOCK	On
KEY CYL LK-SW	Other than driver door key cylinder LOCK position	Off
	Driver door key cylinder LOCK position	On
KEY CYL UN-SW	Other than driver door key cylinder UNLOCK position	Off
	Driver door key cylinder UNLOCK position	On
KEY CYL SW-TR	NOTE: The item is indicated, but not monitored.	Off
HAZARD SW	Hazard switch is OFF	Off
	Hazard switch is ON	On
REAR DEF SW	NOTE: The item is indicated, but not monitored.	Off
TR CANCEL SW	NOTE: The item is indicated, but not monitored.	Off
TR/BD OPEN SW	Back door opener switch OFF	Off
	While the back door opener switch is turned ON	On
TRNK/HAT MNTR	NOTE: The item is indicated, but not monitored.	Off
RKE-LOCK	LOCK button of the key is not pressed	Off
	LOCK button of the key is pressed	On
RKE-UNLOCK	UNLOCK button of the key is not pressed	Off
	UNLOCK button of the key is pressed	On
RKE-TR/BD	NOTE: The item is indicated, but not monitored.	Off
RKE-PANIC	PANIC button of the key is not pressed	Off
	PANIC button of the key is pressed	On
RKE-P/W OPEN	UNLOCK button of the key is not pressed	Off
	UNLOCK button of the key is pressed and held	On
RKE-MODE CHG	LOCK/UNLOCK button of the key is not pressed and held simultaneously	Off
	LOCK/UNLOCK button of the key is pressed and held simultaneously	On

BCM (BODY CONTROL MODULE)

< ECU DIAGNOSIS >

Monitor Item	Condition	Value/Status	
OPTICAL SENSOR	Bright outside of the vehicle	Close to 5 V	A
	Dark outside of the vehicle	Close to 0 V	
REQ SW -DR	Driver door request switch is not pressed	Off	B
	Driver door request switch is pressed	On	
REQ SW -AS	Passenger door request switch is not pressed	Off	C
	Passenger door request switch is pressed	On	
REQ SW -RR	NOTE: The item is indicated, but not monitored.	Off	D
REQ SW -RL	NOTE: The item is indicated, but not monitored.	Off	D
REQ SW -BD/TR	Back door request switch is not pressed	Off	E
	Back door request switch is pressed	On	
PUSH SW	Push-button ignition switch (push switch) is not pressed	Off	F
	Push-button ignition switch (push switch) is pressed	On	
IGN RLY2 -F/B	Ignition switch in OFF or ACC position	Off	G
	Ignition switch in ON position	On	
CLUCH SW	NOTE: The item is indicated, but not monitored.	Off	G
BRAKE SW 1	The brake pedal is not depressed	On	H
	The brake pedal is depressed	Off	
DETE/CANCL SW	Selector lever in P position	Off	I
	Selector lever in any position other than P	On	
SFT PN/N SW	Selector lever in any position other than P and N	Off	J
	Selector lever in P or N position	On	
S/L -LOCK	Steering is locked	Off	
	Steering is unlocked	On	
S/L -UNLOCK	Steering is unlocked	Off	RF
	Steering is locked	On	
S/L RELAY-F/B	Ignition switch in OFF or ACC position	Off	L
	Ignition switch in ON position	On	
UNLK SEN -DR	Driver door is unlocked	Off	M
	Driver door is locked	On	
PUSH SW -IPDM	Push-button ignition switch (push-switch) is not pressed	Off	N
	Push-button ignition switch (push-switch) is pressed	On	
IGN RLY1 -F/B	Ignition switch in OFF or ACC position	Off	O
	Ignition switch in ON position	On	
DETE SW -IPDM	Selector lever in P position	Off	P
	Selector lever in any position other than P	On	
SFT PN -IPDM	Selector lever in any position other than P and N	Off	
	Selector lever in P or N position	On	
SFT P -MET	Selector lever in any position other than P	Off	
	Selector lever in P position	On	
SFT N -MET	Selector lever in any position other than N	Off	
	Selector lever in N position	On	

BCM (BODY CONTROL MODULE)

< ECU DIAGNOSIS >

Monitor Item	Condition	Value/Status
ENGINE STATE	Engine stopped	Stop
	While the engine stalls	Stall
	At engine cranking	Crank
	Engine running	Run
S/L LOCK-IPDM	Steering is locked	Off
	Steering is unlocked	On
S/L UNLK-IPDM	Steering is unlocked	Off
	Steering is locked	On
S/L RELAY-REQ	Ignition switch in OFF or ACC position	Off
	Ignition switch in ON position	On
VEH SPEED 1	While driving	Equivalent to speedometer reading
VEH SPEED 2	While driving	Equivalent to speedometer reading
DOOR STAT-DR	Driver door is locked	LOCK
	Wait with selective UNLOCK operation (5 seconds)	READY
	Driver door is unlocked	UNLOCK
DOOR STAT-AS	Passenger door is locked	LOCK
	Wait with selective UNLOCK operation (5 seconds)	READY
	Passenger door is unlocked	UNLOCK
ID OK FLAG	Ignition switch in ACC or ON position	Reset
	Ignition switch in OFF position	Set
PRMT ENG STRT	The engine start is prohibited	Reset
	The engine start is permitted	Set
PRMT RKE STRT	NOTE: The item is indicated, but not monitored.	Reset
KEY SW -SLOT	The key is not inserted into key slot	Off
	The key is inserted into key slot	On
RKE OPE COUN1	During the operation of the key	Operation frequency of the key
RKE OPE COUN2	NOTE: The item is indicated, but not monitored.	—
CONFIRM ID ALL	The key ID that the key slot receives does not accord with any key ID registered to BCM.	Yet
	The key ID that the key slot receives accords with any key ID registered to BCM.	DONE
CONFIRM ID4	The key ID that the key slot receives does not accord with the fourth key ID registered to BCM.	Yet
	The key ID that the key slot receives accords with the fourth key ID registered to BCM.	DONE
CONFIRM ID3	The key ID that the key slot receives does not accord with the third key ID registered to BCM.	Yet
	The key ID that the key slot receives accords with the third key ID registered to BCM.	DONE
CONFIRM ID2	The key ID that the key slot receives does not accord with the second key ID registered to BCM.	Yet
	The key ID that the key slot receives accords with the second key ID registered to BCM.	DONE

BCM (BODY CONTROL MODULE)

< ECU DIAGNOSIS >

Monitor Item	Condition	Value/Status	
CONFIRM ID1	The key ID that the key slot receives does not accord with the first key ID registered to BCM.	Yet	A
	The key ID that the key slot receives accords with the first key ID registered to BCM.	DONE	B
TP 4	The ID of fourth key is not registered to BCM	Yet	C
	The ID of fourth key is registered to BCM	DONE	
TP 3	The ID of third key is not registered to BCM	Yet	D
	The ID of third key is registered to BCM	DONE	
TP 2	The ID of second key is not registered to BCM	Yet	E
	The ID of second key is registered to BCM	DONE	
TP 1	The ID of first key is not registered to BCM	Yet	F
	The ID of first key is registered to BCM	DONE	
AIR PRESS FL	Ignition switch ON (Only when the signal from the transmitter is received)	Air pressure of front LH tire	G
AIR PRESS FR	Ignition switch ON (Only when the signal from the transmitter is received)	Air pressure of front RH tire	H
AIR PRESS RR	Ignition switch ON (Only when the signal from the transmitter is received)	Air pressure of rear RH tire	I
AIR PRESS RL	Ignition switch ON (Only when the signal from the transmitter is received)	Air pressure of rear LH tire	J
ID REGST FL1	ID of front LH tire transmitter is registered	DONE	K
	ID of front LH tire transmitter is not registered	Yet	
ID REGST FR1	ID of front RH tire transmitter is registered	DONE	L
	ID of front RH tire transmitter is not registered	Yet	
ID REGST RR1	ID of rear RH tire transmitter is registered	DONE	M
	ID of rear RH tire transmitter is not registered	Yet	
ID REGST RL1	ID of rear LH tire transmitter is registered	DONE	N
	ID of rear LH tire transmitter is not registered	Yet	
WARNING LAMP	Tire pressure indicator OFF	Off	O
	Tire pressure indicator ON	On	
BUZZER	Tire pressure warning alarm is not sounding	Off	P
	Tire pressure warning alarm is sounding	On	

RF

BCM (BODY CONTROL MODULE)

< ECU DIAGNOSIS >
 TERMINAL LAYOUT

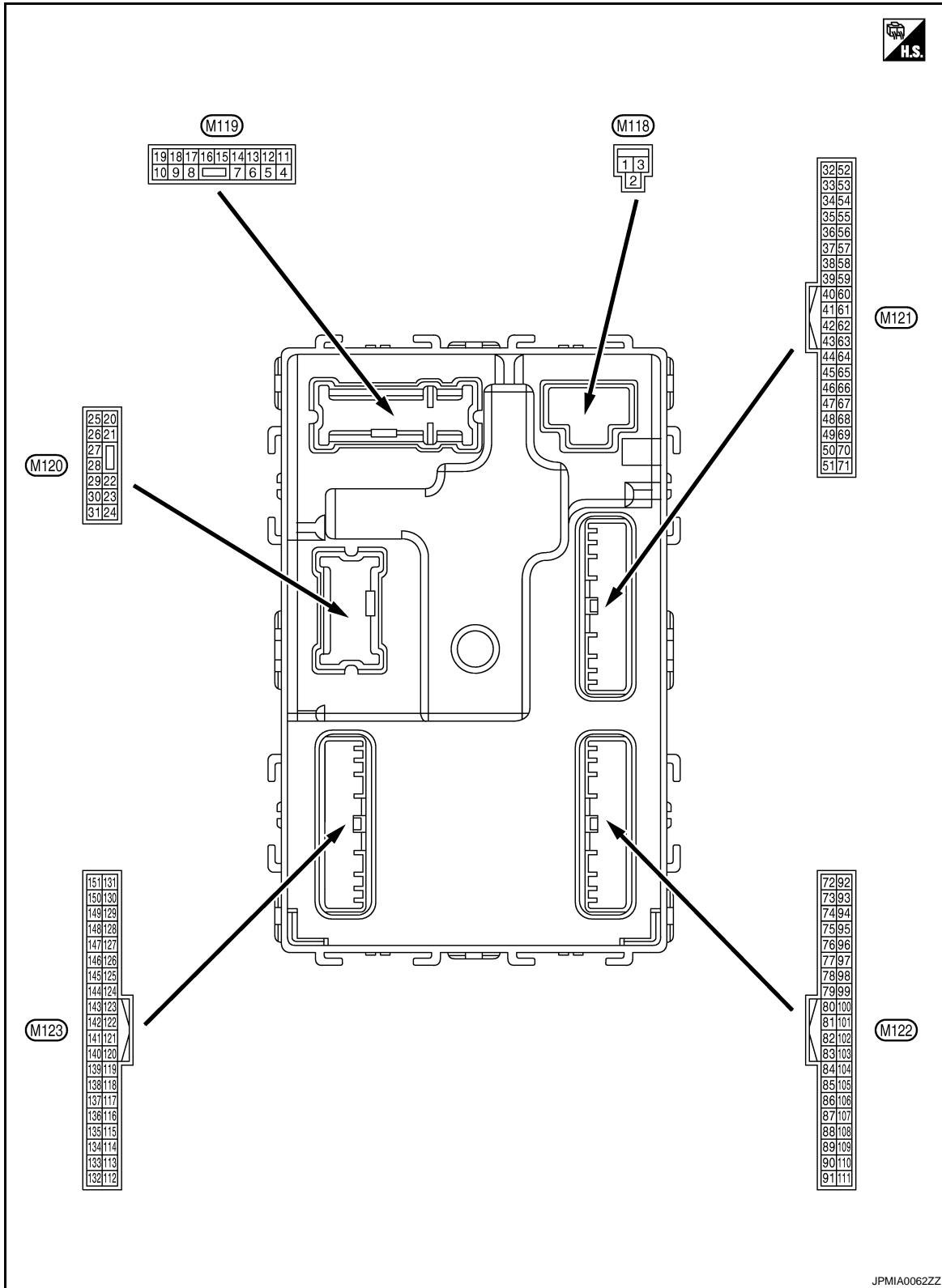

PHYSICAL VALUES

BCM (BODY CONTROL MODULE)

< ECU DIAGNOSIS >

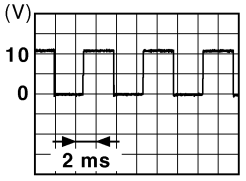
Terminal No. (Wire color)		Description		Condition		Value (Approx.)
		Signal name	Input/ Output			
+	-					
1 (W)	Ground	Battery power supply	Input	Ignition switch OFF		Battery voltage
2 (Y)	Ground	P/W power supply (BAT)	Output	Ignition switch OFF		Battery voltage
3 (O)	Ground	P/W power supply (RAP)	Output	Ignition switch ON		Battery voltage
4 (LG)	Ground	Interior room lamp power supply	Output	Interior room lamp battery saver is activated. (Cuts the interior room lamp power supply)		0 V
				Interior room lamp battery saver is not activated. (Outputs the interior room lamp power supply)		Battery voltage
5 (L)	Ground	Passenger door UN- LOCK	Output	Passenger door	UNLOCK (Actuator is activated)	Battery voltage
					Other than UNLOCK (Actuator is not activated)	0 V
7 (Y)	Ground	Step lamp	Output	Step lamp	ON	0 V
						OFF
8 (V)	Ground	All doors, fuel lid LOCK	Output	All doors	LOCK (Actuator is activated)	Battery voltage
						Other than LOCK (Actuator is not activated)
9 (G)	Ground	Driver door, fuel lid UNLOCK	Output	Driver door	UNLOCK (Actuator is activated)	Battery voltage
						Other than UNLOCK (Actuator is not activated)
10 (BR)	Ground	Rear RH door and rear LH door UN- LOCK	Output	Rear RH door and rear LH door	UNLOCK (Actuator is activated)	Battery voltage
						Other than UNLOCK (Actuator is not activated)
11 (R)	Ground	Battery power supply	Input	Ignition switch OFF		Battery voltage
13 (B)	Ground	Ground	—	Ignition switch ON		0 V
14 (W)	Ground	Push-button ignition switch illumination ground	Output	Tail lamp	OFF	0 V
					ON	NOTE: When the illumination brightening/dimming level is in the neutral position 
15 (Y)	Ground	ACC indicator lamp	Output	Ignition switch	OFF or ON	Battery voltage
					ACC	0 V

A
B
C
D
E
F
G
H
I
J
RF
L
M
N
O
P

BCM (BODY CONTROL MODULE)

< ECU DIAGNOSIS >

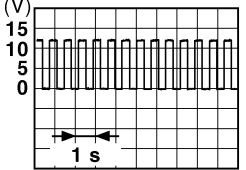
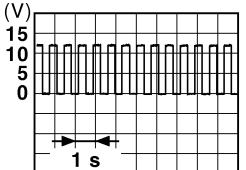
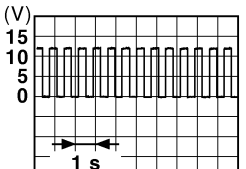
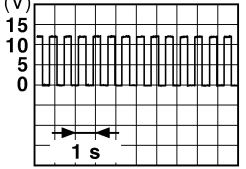
Terminal No. (Wire color)		Description		Condition	Value (Approx.)
+	-	Signal name	Input/ Output		
17 (W)	Ground	Turn signal RH (Front)	Output	Ignition switch ON	Turn signal switch OFF
				Turn signal switch RH	0 V
					 <p style="text-align: right;">PKID0926E</p>
					6.5 V
18 (O)	Ground	Turn signal LH (Front)	Output	Ignition switch ON	Turn signal switch OFF
				Turn signal switch LH	0 V
					 <p style="text-align: right;">PKID0926E</p>
					6.5 V
19 (V)	Ground	Room lamp timer control	Output	Interior room lamp	OFF
					ON
20 (V)	Ground	Turn signal RH (Rear)	Output	Ignition switch ON	Turn signal switch OFF
				Turn signal switch RH	0 V
					 <p style="text-align: right;">PKID0926E</p>
					6.5 V
23 (G)	Ground	Back door opening	Output	Back door	OPEN (Back door opener actuator is activated)
					Other than OPEN (Back door opener actuator is not activated)
					0 V
25 (G)	Ground	Turn signal LH (Rear)	Output	Ignition switch ON	Turn signal switch OFF
				Turn signal switch LH	0 V
					 <p style="text-align: right;">PKID0926E</p>
					6.5 V
26 (G)	Ground	Rear wiper	Output	Rear wiper	OFF (Stopped)
					ON (Operated)

BCM (BODY CONTROL MODULE)

< ECU DIAGNOSIS >

Terminal No. (Wire color)		Description		Condition	Value (Approx.)
+	-	Signal name	Input/ Output		
34 (SB)	Ground	Luggage room antenna 1 (-)	Output	Ignition switch OFF	<p>JMKIA0062GB</p>
				When Intelligent Key is not in the passenger compartment	<p>JMKIA0063GB</p>
35 (V)	Ground	Luggage room antenna 1 (+)	Output	Ignition switch OFF	<p>JMKIA0062GB</p>
				When Intelligent Key is not in the passenger compartment	<p>JMKIA0063GB</p>
38 (B)	Ground	Rear bumper antenna (-)	Output	When the back door request switch is operated with ignition switch OFF	<p>JMKIA0062GB</p>
				When Intelligent Key is not in the antenna detection area	<p>JMKIA0063GB</p>

A
B
C
D
E
F
G
H
I
J
L
M
N
O
P

RF

BCM (BODY CONTROL MODULE)

< ECU DIAGNOSIS >

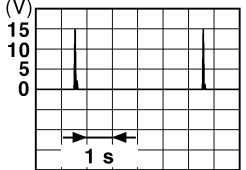
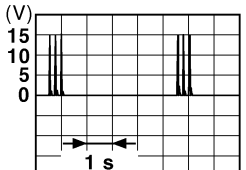
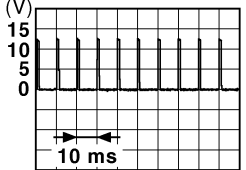
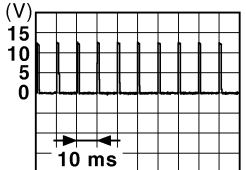
Terminal No. (Wire color)		Description		Condition		Value (Approx.)
+	-	Signal name	Input/ Output			
39 (W)	Ground	Rear bumper antenna (+)	Output	When the back door request switch is operated with ignition switch OFF	When Intelligent Key is in the antenna detection area	 <small>JMKIA0062GB</small>
					When Intelligent Key is not in the antenna detection area	 <small>JMKIA0063GB</small>
47 (Y)	Ground	Ignition relay (IPDM E/R) control	Output	Ignition switch	OFF or ACC	Battery voltage
					ON	0 V
52 (SB)	Ground	Starter relay control	Output	Ignition switch ON	When selector lever is in P or N position	Battery voltage
					When selector lever is not in P or N position	0 V
61 (W)	Ground	Back door opener request switch	Input	Back door request switch	ON (Pressed)	0 V
					OFF (Not pressed)	 <small>JPMIA0016GB</small> 1.0 V
64 (V)	Ground	Request switch buzzer	Output	Request switch buzzer	Sounding	0 V
					Not sounding	Battery voltage
65 (O)	Ground	Rear wiper stop position	Input	Rear wiper	In stop position	 <small>JPMIA0016GB</small> 1.0 V
					Not in stop position	0 V

BCM (BODY CONTROL MODULE)

< ECU DIAGNOSIS >

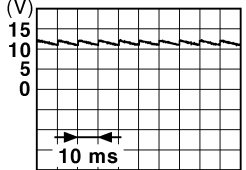
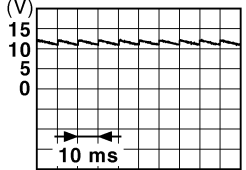
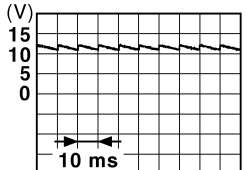
Terminal No. (Wire color)		Description		Condition	Value (Approx.)
		Signal name	Input/ Output		
+	-				
66 (R)	Ground	Back door switch	Input	Back door switch	OFF (Door close)  <small>JPMIA0011GB</small> 11.8 V
					ON (Door open)
67 (GR)	Ground	Back door opener switch	Input	Back door opener switch	Pressed 0 V
					Not pressed
68 (BR)	Ground	Rear RH door switch	Input	Rear RH door switch	OFF (Door close)  <small>JPMIA0011GB</small> 11.8 V
					ON (Door open)
69 (R)	Ground	Rear LH door switch	Input	Rear LH door switch	OFF (Door close)  <small>JPMIA0011GB</small> 11.8 V
					ON (Door open)

A
B
C
D
E
F
G
H
I
J
RF
L
M
N
O
P

BCM (BODY CONTROL MODULE)

< ECU DIAGNOSIS >

Terminal No. (Wire color)		Description		Condition	Value (Approx.)
		Signal name	Input/ Output		
+	-				
72 (R)	Ground	Room antenna 2 (-) (Center console)	Output	Ignition switch OFF	<p style="text-align: right; font-size: small;">JMKIA0062GB</p>
				When Intelligent Key is not in the passenger compart- ment	<p style="text-align: right; font-size: small;">JMKIA0063GB</p>
73 (G)	Ground	Room antenna 2 (+) (Center console)	Output	Ignition switch OFF	<p style="text-align: right; font-size: small;">JMKIA0062GB</p>
				When Intelligent Key is not in the passenger compart- ment	<p style="text-align: right; font-size: small;">JMKIA0063GB</p>
74 (SB)	Ground	Passenger door an- tenna (-)	Output	When the pas- senger door re- quest switch is operated with ig- nition switch OFF	<p style="text-align: right; font-size: small;">JMKIA0062GB</p>
				When Intelligent Key is not in the antenna detection area	<p style="text-align: right; font-size: small;">JMKIA0063GB</p>

BCM (BODY CONTROL MODULE)

< ECU DIAGNOSIS >

Terminal No. (Wire color)		Description		Condition	Value (Approx.)
		Signal name	Input/ Output		
+	-				
75 (GR)	Ground	Passenger door antenna (+)	Output	When Intelligent Key is in the antenna detection area	
				When the passenger door request switch is operated with ignition switch OFF	
76 (V)	Ground	Driver door antenna (-)	Output	When Intelligent Key is in the antenna detection area	
				When the driver door request switch is operated with ignition switch OFF	
77 (LG)	Ground	Driver door antenna (+)	Output	When Intelligent Key is in the antenna detection area	
				When the driver door request switch is operated with ignition switch OFF	

A
B
C
D
E
F
G
H
I
J
L
M
N
O
P

RF

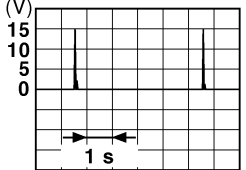
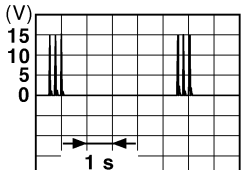
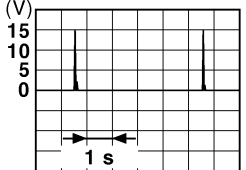
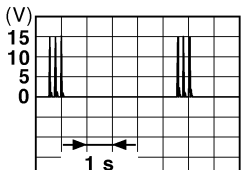

BCM (BODY CONTROL MODULE)

< ECU DIAGNOSIS >

Terminal No. (Wire color)		Description		Condition	Value (Approx.)
+	-	Signal name	Input/ Output		
78 (Y)	Ground	Room antenna (-) (Instrument panel)	Output	Ignition switch OFF	When Intelligent Key is in the passenger compart- ment  JMkia0062GB
					When Intelligent Key is not in the passenger compart- ment  JMkia0063GB
79 (BR)	Ground	Room antenna (+) (Instrument panel)	Output	Ignition switch OFF	When Intelligent Key is in the passenger compart- ment  JMkia0062GB
					When Intelligent Key is not in the passenger compart- ment  JMkia0063GB
80 (GR)	Ground	NATS antenna amp (Built in key slot)	Input/ Output	During waiting	Ignition switch is pressed while inserting the key into the key slot. Just after pressing ignition switch. Pointer of tester should move.
81 (W)	Ground	NATS antenna amp (Built in key slot)	Input/ Output	During waiting	Ignition switch is pressed while inserting the key into the key slot. Just after pressing ignition switch. Pointer of tester should move.
82 (R)	Ground	Ignition relay [Fuse block (J/B)] control	Output	Ignition switch	OFF or ACC 0 V
				ON	Battery voltage

BCM (BODY CONTROL MODULE)

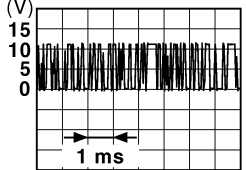
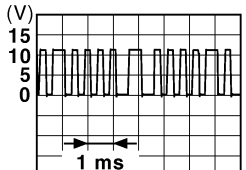
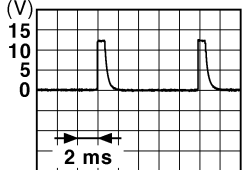
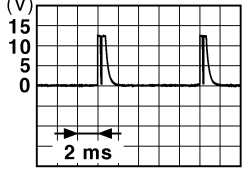
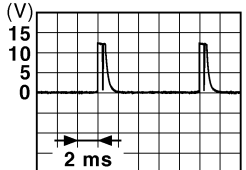
< ECU DIAGNOSIS >



Terminal No. (Wire color)		Description		Condition	Value (Approx.)	
		Signal name	Input/ Output			
+	-					
83 (Y)	Ground	Remote keyless entry receiver signal	Input/ Output	During waiting	 <p style="text-align: right; font-size: small;">JMKIA0064GB</p>	
				When operating either button on the key	 <p style="text-align: right; font-size: small;">JMKIA0065GB</p>	
87 (BR)	Ground	Combination switch INPUT 5	Input	Combination switch	All switch OFF (Wiper intermittent dial 4)	 <p style="text-align: right; font-size: small;">JPMIA0041GB</p> <p style="text-align: center;">1.4 V</p>
					Front fog lamp switch ON (Wiper intermittent dial 4)	 <p style="text-align: right; font-size: small;">JPMIA0037GB</p> <p style="text-align: center;">1.3 V</p>
					Rear wiper switch ON (Wiper intermittent dial 4)	 <p style="text-align: right; font-size: small;">JPMIA0039GB</p> <p style="text-align: center;">1.3 V</p>
					Any of the conditions below with all switch OFF	 <p style="text-align: right; font-size: small;">JPMIA0040GB</p> <p style="text-align: center;">1.3 V</p>

A
B
C
D
E
F
G
H
I
J
L
M
N
O
P

RF

BCM (BODY CONTROL MODULE)

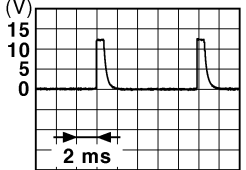
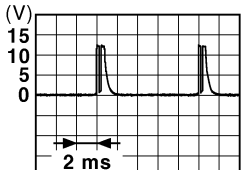
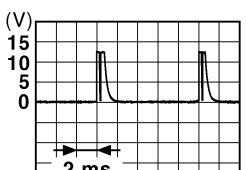
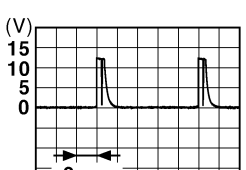
< ECU DIAGNOSIS >

Terminal No. (Wire color)		Description		Condition	Value (Approx.)	
+	-	Signal name	Input/ Output			
88 (V)	Ground	Combination switch INPUT 3	Input	Combination switch	All switch OFF (Wiper intermittent dial 4)	 <p style="text-align: right; font-size: small;">JPMIA0041GB</p> <p style="text-align: center;">1.4 V</p>
					Lighting switch HI (Wiper intermittent dial 4)	 <p style="text-align: right; font-size: small;">JPMIA0036GB</p> <p style="text-align: center;">1.3 V</p>
					Lighting switch 2ND (Wiper intermittent dial 4)	 <p style="text-align: right; font-size: small;">JPMIA0037GB</p> <p style="text-align: center;">1.3 V</p>
					Rear washer switch ON (Wiper intermittent dial 4)	 <p style="text-align: right; font-size: small;">JPMIA0039GB</p> <p style="text-align: center;">1.3 V</p>
					Any of the conditions below with all switch OFF	<ul style="list-style-type: none"> • Wiper intermittent dial 1 • Wiper intermittent dial 2 • Wiper intermittent dial 3  <p style="text-align: right; font-size: small;">JPMIA0040GB</p> <p style="text-align: center;">1.3 V</p>
89 (BR)	Ground	Push-button ignition switch (Push switch)	Input	Push-button igni- tion switch (push switch)	Pressed	0 V
					Not pressed	Battery voltage
90 (P)	Ground	CAN-L	Input/ Output	—	—	
91 (L)	Ground	CAN-H	Input/ Output	—	—	

BCM (BODY CONTROL MODULE)

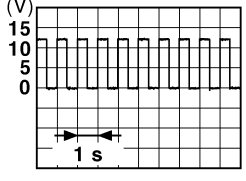
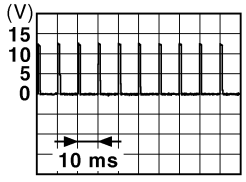
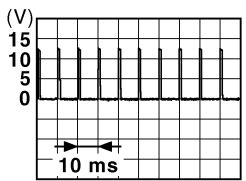

< ECU DIAGNOSIS >

Terminal No. (Wire color)		Description		Condition	Value (Approx.)	
+	-	Signal name	Input/ Output			
92 (LG)	Ground	Key slot illumination	Output	Key slot illumination	OFF	Battery voltage
					Blinking	 <p style="text-align: center;">6.5 V</p> <p style="text-align: right; font-size: small;">JPMIA0015GB</p>
93 (V)	Ground	ON indicator lamp	Output	Ignition switch	OFF or ACC	Battery voltage
					ON	0 V
94 (Y)	Ground	Puddle lamp control	Output	Puddle lamp	OFF	Battery voltage
					ON	0 V
95 (O)	Ground	ACC relay control	Output	Ignition switch	OFF	0 V
					ACC or ON	Battery voltage
96 (GR)	Ground	Control device (Detention switch) power supply	Output	—	Battery voltage	
97 (L)	Ground	Steering lock condition No. 1	Input	Steering lock	LOCK status	0 V
					UNLOCK status	Battery voltage
98 (P)	Ground	Steering lock condition No. 2	Input	Steering lock	LOCK status	Battery voltage
					UNLOCK status	0 V
99 (R)	Ground	Selector lever P position switch	Input	Selector lever	P position	0 V
					Any position other than P	Battery voltage
100 (G)	Ground	Passenger door request switch	Input	Passenger door request switch	ON (Pressed)	0 V
					OFF (Not pressed)	 <p style="text-align: center;">1.0 V</p> <p style="text-align: right; font-size: small;">JPMIA0016GB</p>
101 (SB)	Ground	Driver door request switch	Input	Driver door request switch	ON (Pressed)	0 V
					OFF (Not pressed)	 <p style="text-align: center;">1.0 V</p> <p style="text-align: right; font-size: small;">JPMIA0016GB</p>
102 (O)	Ground	Blower fan motor relay control	Output	Ignition switch	OFF or ACC	0 V
					ON	Battery voltage

A
B
C
D
E
F
G
H
I
J
RF
L
M
N
O
P



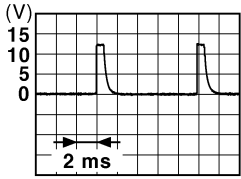
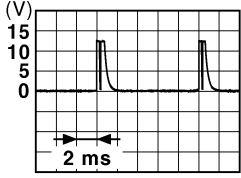
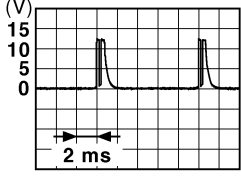
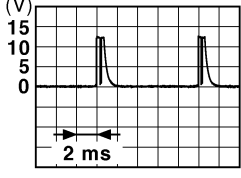

BCM (BODY CONTROL MODULE)

< ECU DIAGNOSIS >

Terminal No. (Wire color)		Description		Condition		Value (Approx.)
+	-	Signal name	Input/ Output			
103 (LG)	Ground	Remote keyless entry receiver power supply	Output	Ignition switch OFF		Battery voltage
106 (W)	Ground	Steering wheel lock unit power supply	Output	Ignition switch	OFF or ACC	Battery voltage
					ON	0 V
107 (LG)	Ground	Combination switch INPUT 1	Input	Combination switch (Wiper intermittent dial 4)	All switch OFF	 <p style="text-align: right; margin-right: 20px;">1.4 V</p>
					Turn signal switch LH	 <p style="text-align: right; margin-right: 20px;">1.3 V</p>
					Turn signal switch RH	 <p style="text-align: right; margin-right: 20px;">1.3 V</p>
					Front wiper switch LO	 <p style="text-align: right; margin-right: 20px;">1.3 V</p>
					Front washer switch ON	 <p style="text-align: right; margin-right: 20px;">1.3 V</p>

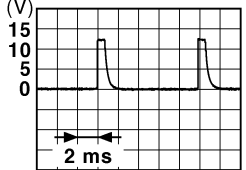
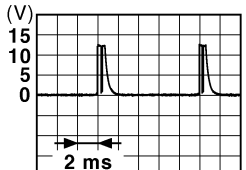
BCM (BODY CONTROL MODULE)

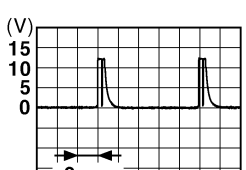

< ECU DIAGNOSIS >

Terminal No. (Wire color)		Description		Condition	Value (Approx.)	
		Signal name	Input/ Output			
+	-					
108 (R)	Ground	Combination switch INPUT 4	Input	Combination switch	All switch OFF (Wiper intermittent dial 4)	 <small>JPMIA0041GB</small> 1.4 V
					Lighting switch AUTO (Wiper intermittent dial 4)	 <small>JPMIA0038GB</small> 1.3 V
					Lighting switch 1ST (Wiper intermittent dial 4)	 <small>JPMIA0036GB</small> 1.3 V
					Rear wiper switch INT (Wiper intermittent dial 4)	 <small>JPMIA0040GB</small> 1.3 V
					Any of the conditions below with all switch OFF • Wiper intermittent dial 1 • Wiper intermittent dial 5 • Wiper intermittent dial 6	 <small>JPMIA0039GB</small> 1.3 V

A
B
C
D
E
F
G
H
I
J
RF
L
M
N
O
P

BCM (BODY CONTROL MODULE)

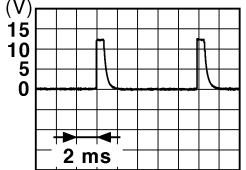
< ECU DIAGNOSIS >

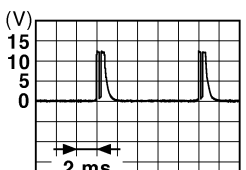
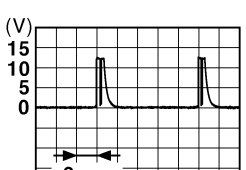
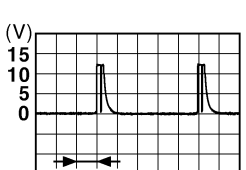
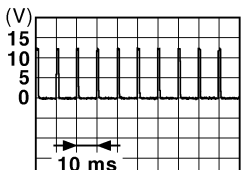
Terminal No. (Wire color)		Description		Condition	Value (Approx.)	
+	-	Signal name	Input/ Output			
109 (Y)	Ground	Combination switch INPUT 2	Input	Combination switch (Wiper intermittent dial 4)	All switch OFF	 <p style="text-align: right;">1.4 V</p>
					Lighting switch PASS	 <p style="text-align: right;">1.3 V</p>
					Lighting switch 2ND	 <p style="text-align: right;">1.3 V</p>
					Front wiper switch INT	 <p style="text-align: right;">1.3 V</p>
					Front wiper switch HI	 <p style="text-align: right;">1.3 V</p>
					ON	0 V
110 (G)	Ground	Hazard switch	Input	Hazard switch	OFF	 <p style="text-align: right;">1.1 V</p>

BCM (BODY CONTROL MODULE)

< ECU DIAGNOSIS >

Terminal No. (Wire color)		Description		Condition	Value (Approx.)	
+	-	Signal name	Input/ Output			
111 (Y)	Ground	Steering lock unit communication	Input/ Output	Steering lock	LOCK status	Battery voltage
					LOCK or UNLOCK	<p style="text-align: right; font-size: small;">JMKIA0066GB</p>
					For 15 seconds after UN- LOCK	Battery voltage
					15 seconds or later after UNLOCK	0 V
113* (P)	Ground	Optical sensor signal	Input	Ignition switch ON	When bright outside of the vehicle	Close to 5 V
				When dark outside of the vehicle	Close to 0 V	
116 (SB)	Ground	Fuse check [Stop lamp switch, ICC brake hold relay (With ICC)]	Input	—	Battery voltage	
118 (P)	Ground	Stop lamp switch (Without ICC)	Input	Stop lamp switch	OFF (Brake pedal is not depressed)	0 V
					ON (Brake pedal is de- pressed)	Battery voltage
		Stop lamp switch and ICC brake hold relay (With ICC)		Stop lamp switch OFF (Brake pedal is not de- pressed) and ICC brake hold relay OFF	0 V	
				Stop lamp switch ON (Brake pedal is de- pressed) or ICC brake hold relay ON	Battery voltage	
119 (SB)	Ground	Front door lock as- sembly driver side (unlock sensor)	Input	Driver door	LOCK status (Unlock sensor switch OFF)	<p style="text-align: right; font-size: small;">JPMIA0012GB</p>
					UNLOCK status (Unlock switch sensor ON)	0 V
					1.1 V	
121 (BR)	Ground	Key slot switch	Input	When the key is inserted into key slot	Battery voltage	
				When the key is not inserted into key slot	0 V	
122 (V)	Ground	ACC feedback signal	Input	Ignition switch	OFF	0 V
				ACC or ON	Battery voltage	
123 (W)	Ground	IGN feedback signal	Input	Ignition switch	OFF or ACC	0 V
				ON	Battery voltage	

A
B
C
D
E
F
G
H
I
J
RF
L
M
N
O
P

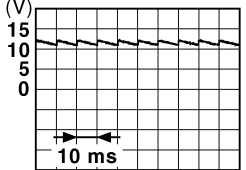
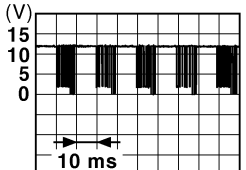
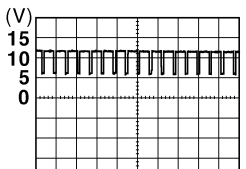

BCM (BODY CONTROL MODULE)

< ECU DIAGNOSIS >

Terminal No. (Wire color)		Description		Condition		Value (Approx.)
+	-	Signal name	Input/ Output			
124 (LG)	Ground	Passenger door switch	Input	Passenger door switch	OFF (Door close)	 <p style="text-align: right; font-size: small;">JPMIA0011GB</p> <p style="text-align: center;">11.8 V</p>
					ON (Door open)	0 V
132 (V)	Ground	Power window switch communication	Input/ Output	Ignition switch ON	 <p style="text-align: right; font-size: small;">JPMIA0013GB</p> <p style="text-align: center;">10.2 V</p>	
					Ignition switch OFF or ACC	Battery voltage
133 (W)	Ground	Push-button ignition switch illumination	Output	Push-button igni- tion switch illumina- tion	ON (Tail lamps OFF)	9.5 V
					ON (Tail lamps ON)	<p>NOTE: The pulse width of this wave is varied by the illumination bright- ening/dimming level.</p>  <p style="text-align: right; font-size: small;">JPMIA0159GB</p>
134 (GR)	Ground	LOCK indicator lamp	Output	LOCK indicator lamp	OFF	Battery voltage
					ON	0 V
137 (O)	Ground	Receiver and sensor ground	Input	Ignition switch ON	0 V	
138 (Y)	Ground	Sensor power supply	Output	Ignition switch	OFF	0 V
					ACC or ON	5.0 V

BCM (BODY CONTROL MODULE)

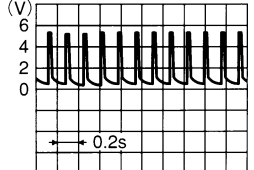
< ECU DIAGNOSIS >

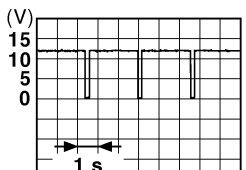
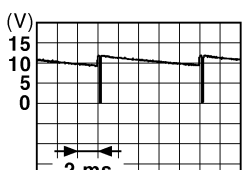
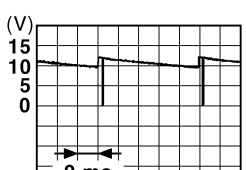
Terminal No. (Wire color)		Description		Condition	Value (Approx.)
+	-	Signal name	Input/ Output		
139 (L)	Ground	Tire pressure receiver signal	Input/ Output	Ignition switch ON	Standby state  OCC3881D
				When receiving the signal from the transmitter  OCC3880D	
140 (GR)	Ground	Selector lever P/N position signal	Input	Selector lever	P or N position Battery voltage
				Except P and N positions	0 V
141 (G)	Ground	Security indicator signal	Output	Security indicator	ON 0 V
				Blinking  JPMIA0014GB 11.3 V	
				OFF	Battery voltage
142 (O)	Ground	Combination switch OUTPUT 5	Output	Combination switch (Wiper intermittent dial 4)	All switch OFF 0 V
				Lighting switch 1ST	 JPMIA0031GB 10.7 V
				Lighting switch HI	
				Lighting switch 2ND	
Turn signal switch RH					
143 (P)	Ground	Combination switch OUTPUT 1	Output	Combination switch	All switch OFF (Wiper intermittent dial 4) 0 V
				Front wiper switch HI (Wiper intermittent dial 4)	 JPMIA0032GB 10.7 V
				Rear wiper switch INT (Wiper intermittent dial 4)	
				Any of the conditions below with all switch OFF <ul style="list-style-type: none"> • Wiper intermittent dial 1 • Wiper intermittent dial 2 • Wiper intermittent dial 3 • Wiper intermittent dial 6 • Wiper intermittent dial 7 	

A
B
C
D
E
F
G
H
I
J
RF
L
M
N
O
P

BCM (BODY CONTROL MODULE)

< ECU DIAGNOSIS >

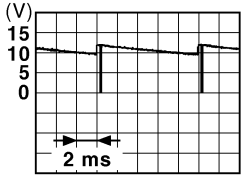
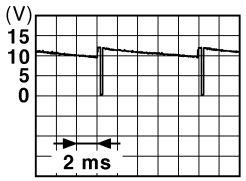
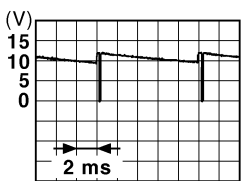
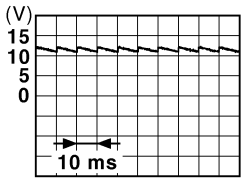
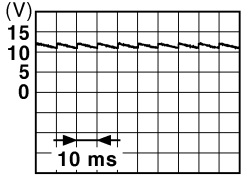
Terminal No. (Wire color)		Description		Condition	Value (Approx.)		
+	-	Signal name	Input/ Output				
144 (G)	Ground	Combination switch OUTPUT 2	Output	Combination switch	All switch OFF (Wiper intermittent dial 4)	0 V	
					Front washer switch ON (Wiper intermittent dial 4)		
					Rear wiper switch ON (Wiper intermittent dial 4)		
					Rear washer switch ON (Wiper intermittent dial 4)		
					Any of the conditions below with all switch OFF <ul style="list-style-type: none"> • Wiper intermittent dial 1 • Wiper intermittent dial 5 • Wiper intermittent dial 6 		
145 (L)	Ground	Combination switch OUTPUT 3	Output	Combination switch (Wiper intermit- tent dial 4)	All switch OFF	0 V	
					Front wiper switch INT		
					Front wiper switch LO		
					Lighting switch AUTO		
146 (SB)	Ground	Combination switch OUTPUT 4	Output	Combination switch (Wiper intermit- tent dial 4)	All switch OFF	0 V	
					Front fog lamp switch ON		
					Lighting switch 2ND		
					Lighting switch PASS		
					Turn signal switch LH		
149 (W)	Ground	Tire pressure warn- ing check switch	Input	Ignition switch ON		11.8 V	
150 (LG)	Ground	Driver door switch	Input	Driver door switch	OFF (Door close)		11.8 V
					ON (Door open)	0 V	
151 (G)	Ground	Rear window defog- ger relay	Output	Rear window de- fogger	Active	0 V	
					Not activated	Battery voltage	

BCM (BODY CONTROL MODULE)

< ECU DIAGNOSIS >

NOTE:

*: With auto light system

Wiring Diagram - BCM -

INFOID:000000003773251

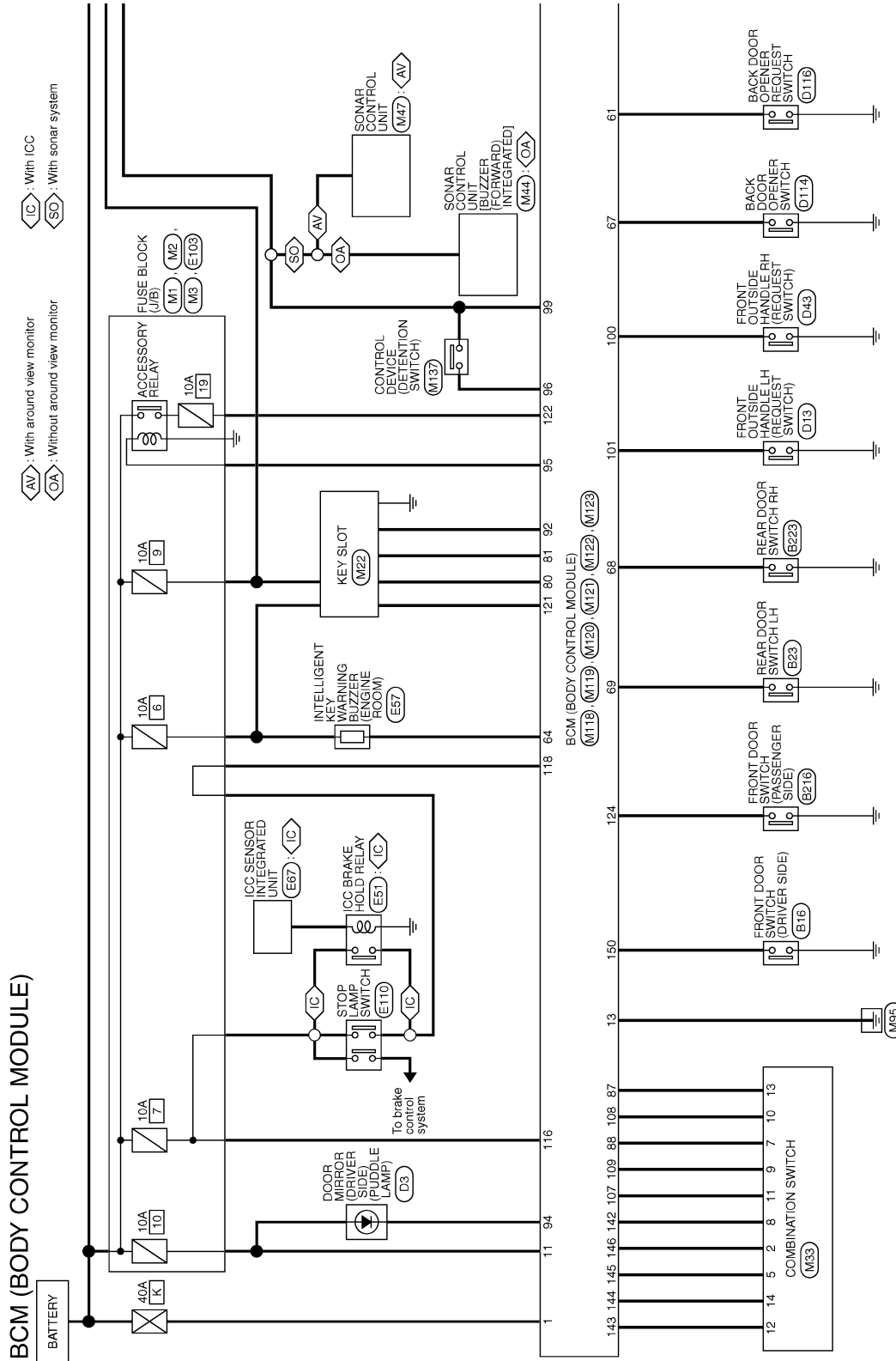

A
B
C
D
E
F
G
H
I
J
RF
L
M
N
O
P

BCM (BODY CONTROL MODULE)

< ECU DIAGNOSIS >

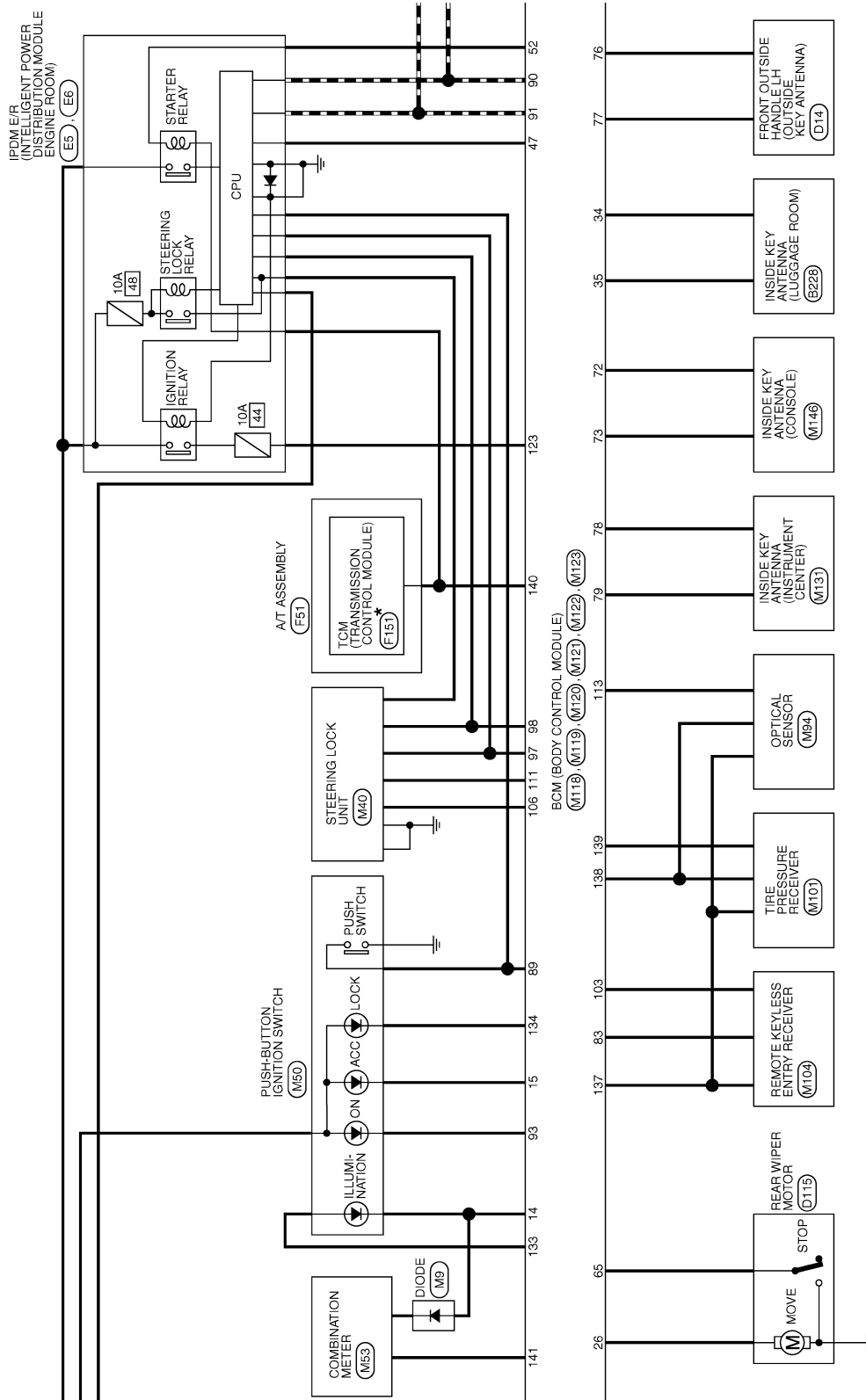

*: This connector is not shown in "Harness Layout".

JCMWM1399G

BCM (BODY CONTROL MODULE)

< ECU DIAGNOSIS >

- ◀NV▶ : With NAVI
- ◀ON▶ : Without NAVI
- ◀RF▶ : With sunroof
- ◀PM▶ : With automatic drive positioner
- ◀OP▶ : Without automatic drive positioner

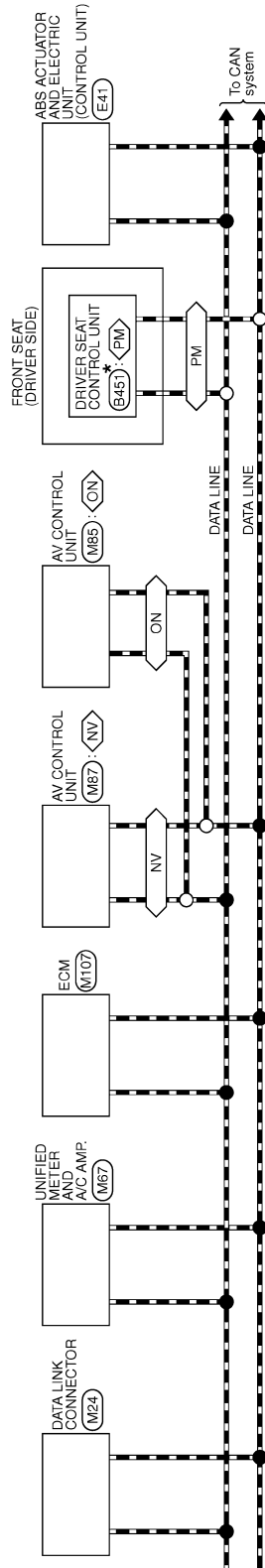

BCM (BODY CONTROL MODULE)

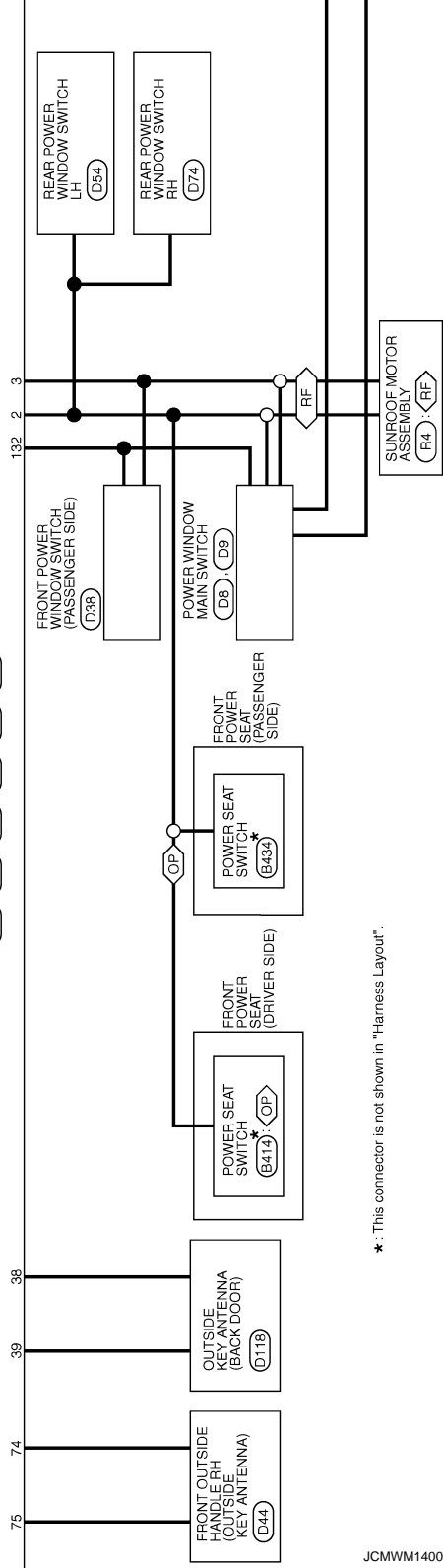

* : This connector is not shown in "Harness Layout".

JCMWM1400G1

A
B
C
D
E
F
G
H
I
J
RF
L
M
N
O
P

BCM (BODY CONTROL MODULE)

< ECU DIAGNOSIS >

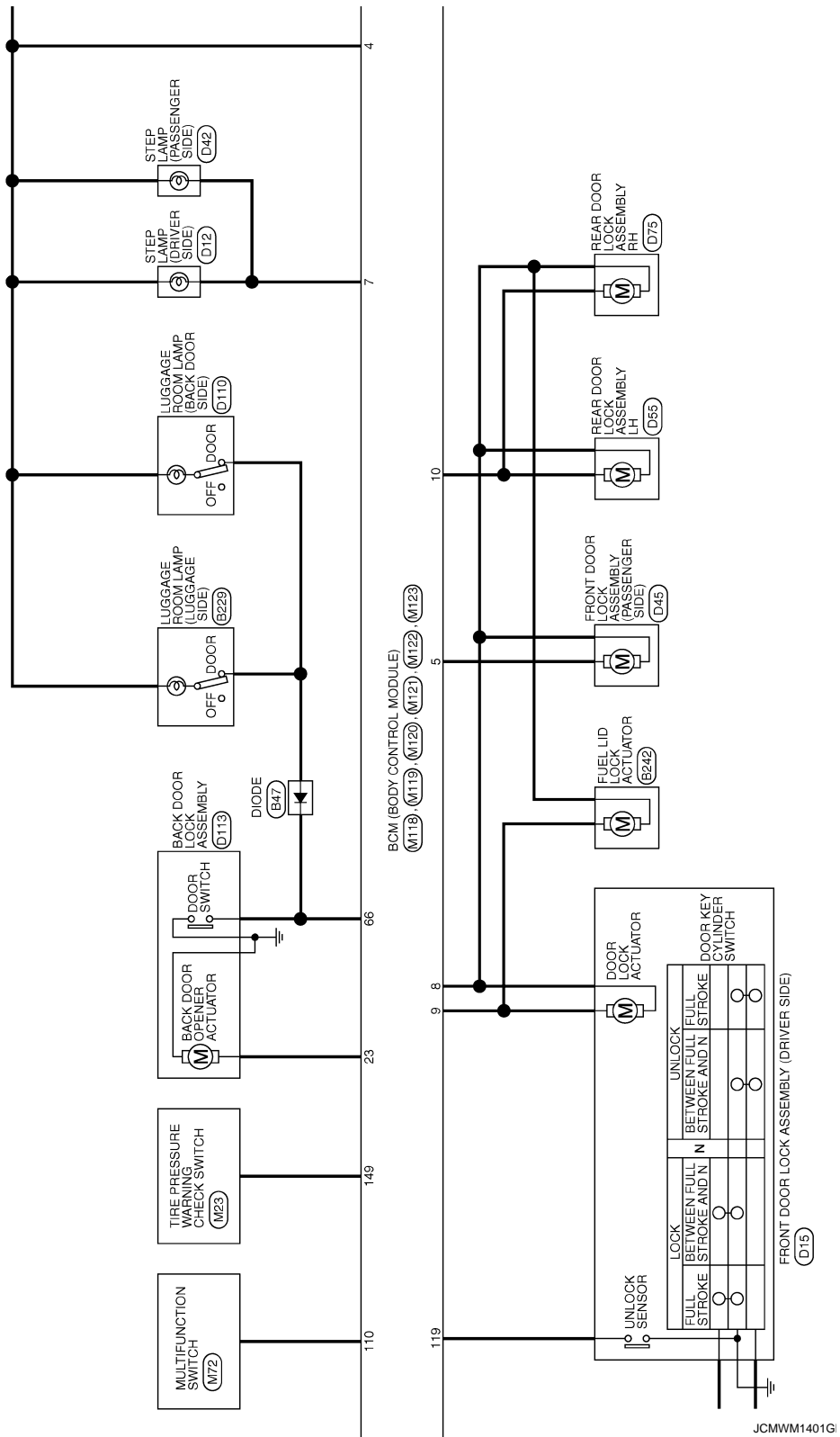

BCM (BODY CONTROL MODULE)

< ECU DIAGNOSIS >

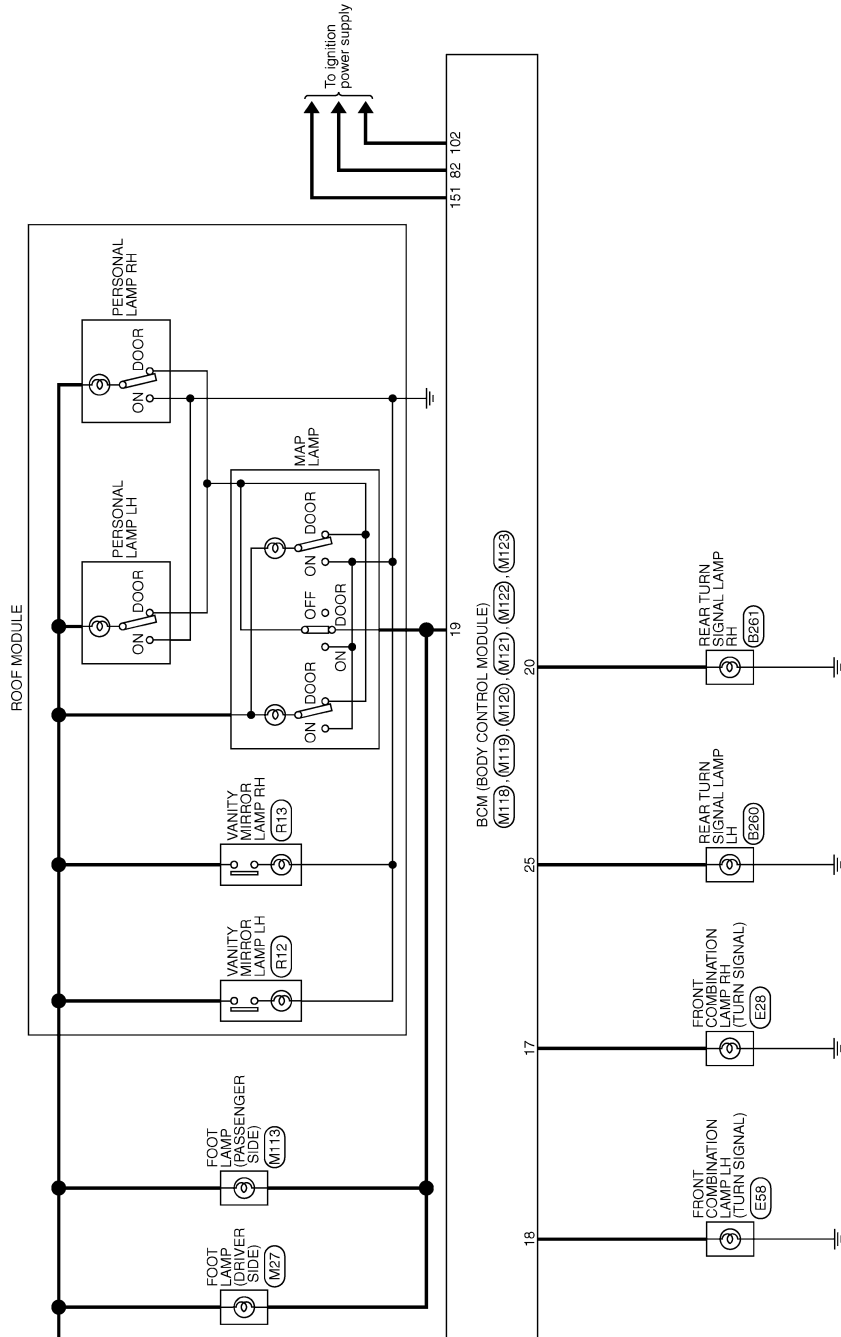

JCMWM1402GI

A
B
C
D
E
F
G
H
I
J
RF
L
M
N
O
P

BCM (BODY CONTROL MODULE)

< ECU DIAGNOSIS >

BCM (BODY CONTROL MODULE)

Connector No.	M33
Connector Name	COMBINATION SWITCH
Connector Type	TH16FW-NH

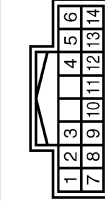

Terminal No.	Color of Wire	Signal Name [Specification]
2	SB	OUTPUT 4
5	L	OUTPUT 3
7	V	INPUT 3
8	O	OUTPUT 5
9	Y	INPUT 2
10	R	INPUT 4
11	LG	INPUT 1
12	P	OUTPUT 1
13	BR	INPUT 5
14	G	OUTPUT 2

Connector No.	M120
Connector Name	BCM (BODY CONTROL MODULE)
Connector Type	NS12FW-CS



Terminal No.	Color of Wire	Signal Name [Specification]
20	V	TURN SIGNAL RH (REAR)
23	G	BACK DOOR OPEN OUTPUT
25	G	TURN SIGNAL LH (REAR)
26	G	REAR WIPER OUTPUT

Connector No.	M118
Connector Name	BCM (BODY CONTROL MODULE)
Connector Type	M03FB-LC



Terminal No.	Color of Wire	Signal Name [Specification]
1	W	BAT (F/L)
2	Y	POWER WINDOW POWER SUPPLY(BAT)
3	O	POWER WINDOW POWER SUPPLY(TRAP)

Connector No.	M121
Connector Name	BCM (BODY CONTROL MODULE)
Connector Type	TH40FGY-NH



Terminal No.	Color of Wire	Signal Name [Specification]
34	SB	LUGGAGE ROOM ANTI-
35	V	LUGGAGE ROOM ANTI+
38	B	REAR BUMPER ANTI-
39	W	REAR BUMPER ANTI+
47	Y	IGN RELAY IPDM E/R CONT
52	SB	STARTER RELAY CONT
61	W	BACK DOOR OPENER REQUEST SW
64	V	REQUEST SW BUZZER
65	O	REAR WIPER STOP POSITION
66	R	BACK DOOR SW
67	GR	BACK DOOR OPENER SW

Connector No.	M119
Connector Name	BCM (BODY CONTROL MODULE)
Connector Type	NS16FW-CS

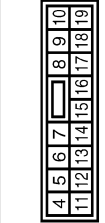

Terminal No.	Color of Wire	Signal Name [Specification]
4	LG	INTERIOR ROOM LAMP POWER SUPPLY
5	L	PASSANGER DOOR UNLOCK OUTPUT
7	Y	STEP LAMP OUTPUT
8	V	ALL DOOR FUEL LID LOCK OUTPUT
9	G	DRIVER DOOR UNLOCK OUTPUT
10	BR	REAR DOOR UNLOCK OUTPUT
11	R	BAT (R/USE)
13	B	GND
14	W	PUSH-BUTTON IGNITION SW ILL GND
15	Y	ACC IND
17	W	TURN SIGNAL RH (FRONT)

68	BR	REAR RH DOOR SW
69	R	REAR LH DOOR SW

18	O	TURN SIGNAL LH (FRONT)
19	V	ROOM LAMP TIMER CONTROL

JCMWM1403G

BCM (BODY CONTROL MODULE)

< ECU DIAGNOSIS >

BCM (BODY CONTROL MODULE)

Connector No.	M122
Connector Name	BCM (BODY CONTROL MODULE)
Connector Type	TH40FB-NH

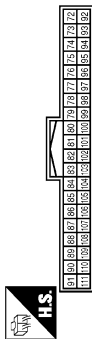

Terminal No.	Color of Wire	Signal Name [Specification]
72	R	ROOM ANT2-
73	G	ROOM ANT2+
74	SB	PASSENGER DOOR ANT-
75	GR	PASSENGER DOOR ANT+
76	V	DRIVER DOOR ANT-
77	LG	DRIVER DOOR ANT+
78	Y	ROOM ANTI-
79	BR	ROOM ANTI+
80	GR	IMMOBI ANTENNA CONTROL
81	W	IMMOBI ANTENNA SIGNAL
82	R	IGN RELAY (F/B) CONT

83	Y	KEYLESS TIMER SIGNAL
87	BR	COMBI SW INPUT 5
88	V	COMBI SW INPUT 3
89	BR	PUSH SW
90	P	CAN-L
91	L	CAN-H
92	LG	KEY SLOT ILL
93	Y	ON IND
94	Y	PUDDLE LAMP CONT
95	O	ACC RELAY CONT
96	GR	A-T DEVICE POWER SUPPLY
97	L	S/L CONDITION 1
98	P	S/L CONDITION 2
99	R	SHIFT P
100	G	PASSENGER DOOR REQUEST SW
101	SB	DRIVER DOOR REQUEST SW
102	O	BLOWER FAN MOTOR RELAY CONT
103	LG	KEYLESS ENTRY RECEIVER POWER SUPPLY
106	W	S/L POWER SUPPLY
107	LG	COMBI SW INPUT 1
108	R	IGN F/B
109	Y	COMBI SW INPUT 4
110	G	COMBI SW INPUT 2
111	Y	HAZARD SW
		S/L COMM

Connector No.	M123
Connector Name	BCM (BODY CONTROL MODULE)
Connector Type	TH40FG-NH

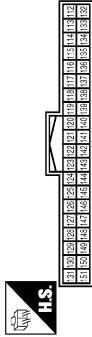

Terminal No.	Color of Wire	Signal Name [Specification]
113	P	OPICAL SENSOR
116	SB	FUSE CHECK
118	P	STOP LAMP SW
119	SB	DR DOOR UNLOCK SENSOR
121	BR	KEY SLOT SW
122	V	ACC F/B
123	W	IGN F/B
124	LG	PASSENGER DOOR SW
132	V	POWER WINDOW SW COMM
133	W	PUSH-BUTTON IGNITION SW ILL POWER
134	GR	LOCK IND

137	O	RECEIVER SENSOR GND
138	Y	RECEIVER SENSOR POWER SUPPLY
139	L	TIRE PRESS RECEIVER SIGNAL
140	GR	SHIFT N/P
141	G	SECURITY INDICATOR OUTPUT
142	O	COMBI SW OUTPUT 5
143	P	COMBI SW OUTPUT 1
144	G	COMBI SW OUTPUT 2
145	L	COMBI SW OUTPUT 3
146	SB	COMBI SW OUTPUT 4
149	W	TIRE PRESS WARNING CHECK SW
150	LG	DRIVER DOOR SW
151	G	REAR WINDOW DEFOGGER RELAY

A
B
C
D
E
F
G
H
I
J
RF
L
M
N
O
P

Fail-safe

FAIL-SAFE CONTROL BY DTC

BCM performs fail-safe control when any DTC is detected.

JCMWM1404G

INFOID:000000003773252

BCM (BODY CONTROL MODULE)

< ECU DIAGNOSIS >

Display contents of CONSULT	Fail-safe	Cancellation
B2013: ID DISCORD BCM-S/L	Inhibit engine cranking	Erase DTC
B2014: CHAIN OF S/L-BCM	Inhibit engine cranking	Erase DTC
B2190: NATS ANTENNA AMP	Inhibit engine cranking	Erase DTC
B2191: DIFFERENCE OF KEY	Inhibit engine cranking	Erase DTC
B2192: ID DISCORD BCM-ECM	Inhibit engine cranking	Erase DTC
B2193: CHAIN OF BCM-ECM	Inhibit engine cranking	Erase DTC
B2557: VEHICLE SPEED	Inhibit steering lock	When normal vehicle speed signals have been received from ABS actuator and electric unit (control unit) for 500 ms
B2560: STARTER CONT RELAY	Inhibit engine cranking	500 ms after the following CAN signal communication status has become consistent <ul style="list-style-type: none"> • Starter control relay signal • Starter relay status signal
B2601: SHIFT POSITION	Inhibit steering lock	500 ms after the following signal reception status becomes consistent <ul style="list-style-type: none"> • Selector lever P position switch signal • P range signal (CAN)
B2602: SHIFT POSITION	Inhibit steering lock	5 seconds after the following BCM recognition conditions are fulfilled <ul style="list-style-type: none"> • Ignition switch is in the ON position • Selector lever P position switch signal: Except P position (battery voltage) • Vehicle speed: 4 km/h (2.5 MPH) or more
B2603: SHIFT POSI STATUS	Inhibit steering lock	500 ms after the following BCM recognition conditions are fulfilled <ul style="list-style-type: none"> • Ignition switch is in the ON position • Selector lever P position switch signal: Except P position (battery voltage) • Selector lever P/N position signal: Except P and N positions (0 V)
B2604: PNP SW	Inhibit steering lock	500 ms after any of the following BCM recognition conditions is fulfilled <ul style="list-style-type: none"> • Status 1 <ul style="list-style-type: none"> - Ignition switch is in the ON position - Selector lever P/N position signal: P and N position (battery voltage) - P range signal or N range signal (CAN): ON • Status 2 <ul style="list-style-type: none"> - Ignition switch is in the ON position - Selector lever P/N position signal: Except P and N positions (0 V) - P range signal and N range signal (CAN): OFF
B2605: PNP SW	Inhibit steering lock	500 ms after any of the following BCM recognition conditions is fulfilled <ul style="list-style-type: none"> • Ignition switch is in the ON position <ul style="list-style-type: none"> - Power position: IGN - Selector lever P/N position signal: Except P and N positions (0 V) - Interlock/PNP switch signal (CAN): OFF • Status 2 <ul style="list-style-type: none"> - Ignition switch is in the ON position - Selector lever P/N position signal: P or N position (battery voltage) - PNP switch signal (CAN): ON
B2606: S/L RELAY	Inhibit engine cranking	500 ms after the following CAN signal communication status has become consistent <ul style="list-style-type: none"> • Steering lock relay signal (Request signal) • Steering lock relay signal (Condition signal)
B2607: S/L RELAY	Inhibit engine cranking	500 ms after the following CAN signal communication status has become consistent <ul style="list-style-type: none"> • Steering lock relay signal (Request signal) • Steering lock relay signal (Condition signal)

BCM (BODY CONTROL MODULE)

< ECU DIAGNOSIS >

Display contents of CONSULT	Fail-safe	Cancellation
B2608: STARTER RELAY	Inhibit engine cranking	500 ms after the following signal communication status becomes consistent <ul style="list-style-type: none"> • Starter motor relay control signal • Starter relay status signal (CAN)
B2609: S/L STATUS	<ul style="list-style-type: none"> • Inhibit engine cranking • Inhibit steering lock 	When the following steering lock conditions agree <ul style="list-style-type: none"> • BCM steering lock control status • Steering lock condition No. 1 signal status • Steering lock condition No. 2 signal status
B260A: IGNITION RELAY	Inhibit engine cranking	500 ms after the following conditions are fulfilled <ul style="list-style-type: none"> • IGN relay (IPDM E/R) control signal: OFF (Battery voltage) • Ignition ON signal (CAN to IPDM E/R): OFF (Request signal) • Ignition ON signal (CAN from IPDM E/R): OFF (Condition signal)
B260F: ENG STATE SIG LOST	Maintains the power supply position attained at the time of DTC detection	When any of the following conditions is fulfilled <ul style="list-style-type: none"> • Power position changes to ACC • Receives engine status signal (CAN)
B2612: S/L STATUS	<ul style="list-style-type: none"> • Inhibit engine cranking • Inhibit steering lock 	When any of the following conditions is fulfilled <ul style="list-style-type: none"> • Steering lock unit status signal (CAN) is received normally • The BCM steering lock control status matches the steering lock status recognized by the steering lock unit status signal (CAN from IPDM E/R)
B2617: STARTER RELAY CIRC	Inhibit engine cranking	1 second after the starter motor relay control inside BCM becomes normal
B2618: BCM	Inhibit engine cranking	1 second after the ignition relay (IPDM E/R) control inside BCM becomes normal
B2619: BCM	Inhibit engine cranking	1 second after the steering lock unit power supply output control inside BCM becomes normal
B261E: VEHICLE TYPE	Inhibit engine cranking	BCM initialization
B26E1: ENG STATE NO RECIV	Inhibit engine cranking	When any of the following conditions is fulfilled <ul style="list-style-type: none"> • Power position changes to ACC • Receives engine status signal (CAN)
B26E9: S/L STATUS	<ul style="list-style-type: none"> • Inhibit engine cranking • Inhibit steering lock 	When BCM transmits the LOCK request signal to steering lock unit, and receives LOCK response signal from steering lock unit, the following conditions is fulfilled <ul style="list-style-type: none"> • Steering condition No. 1 signal: LOCK (0V) • Steering condition No. 2 signal: LOCK (Battery voltage)

HIGH FLASHER OPERATION

BCM detects the turn signal lamp circuit status by the current value.

BCM increases the turn signal lamp blinking speed if the bulb or harness open is detected with the turn signal lamp operating.

NOTE:

The blinking speed is normal while activating the hazard warning lamp.

DTC Inspection Priority Chart

INFOID:000000003773253

If some DTCs are displayed at the same time, perform inspections one by one based on the following priority chart.

Priority	DTC
1	B2562: LOW VOLTAGE
2	<ul style="list-style-type: none"> • U1000: CAN COMM CIRCUIT • U1010: CONTROL UNIT (CAN)
3	<ul style="list-style-type: none"> • B2190: NATS ANTENNA AMP • B2191: DIFFERENCE OF KEY • B2192: ID DISCORD BCM-ECM • B2193: CHAIN OF BCM-ECM

BCM (BODY CONTROL MODULE)

< ECU DIAGNOSIS >

Priority	DTC
4	<ul style="list-style-type: none"> • B2013: ID DISCORD BCM-S/L • B2014: CHAIN OF S/L-BCM • B2553: IGNITION RELAY • B2555: STOP LAMP • B2556: PUSH-BTN IGN SW • B2557: VEHICLE SPEED • B2560: STARTER CONT RELAY • B2601: SHIFT POSITION • B2602: SHIFT POSITION • B2603: SHIFT POSI STATUS • B2604: PNP SW • B2605: PNP SW • B2606: S/L RELAY • B2607: S/L RELAY • B2608: STARTER RELAY • B2609: S/L STATUS • B260A: IGNITION RELAY • B260B: STEERING LOCK UNIT • B260C: STEERING LOCK UNIT • B260D: STEERING LOCK UNIT • B260F: ENG STATE SIG LOST • B2612: S/L STATUS • B2614: ACC RELAY CIRC • B2615: BLOWER RELAY CIRC • B2616: IGN RELAY CIRC • B2617: STARTER RELAY CIRC • B2618: BCM • B2619: BCM • B261A: PUSH-BTN IGN SW • B261E: VEHICLE TYPE • B26E1: ENG STATE NO RECIV • B26E9: S/L STATUS • B26EA: KEY REGISTRATION • C1729: VHCL SPEED SIG ERR • U0415: VEHICLE SPEED SIG
5	<ul style="list-style-type: none"> • C1704: LOW PRESSURE FL • C1705: LOW PRESSURE FR • C1706: LOW PRESSURE RR • C1707: LOW PRESSURE RL • C1708: [NO DATA] FL • C1709: [NO DATA] FR • C1710: [NO DATA] RR • C1711: [NO DATA] RL • C1712: [CHECKSUM ERR] FL • C1713: [CHECKSUM ERR] FR • C1714: [CHECKSUM ERR] RR • C1715: [CHECKSUM ERR] RL • C1716: [PRESSDATA ERR] FL • C1717: [PRESSDATA ERR] FR • C1718: [PRESSDATA ERR] RR • C1719: [PRESSDATA ERR] RL • C1720: [CODE ERR] FL • C1721: [CODE ERR] FR • C1722: [CODE ERR] RR • C1723: [CODE ERR] RL • C1724: [BATT VOLT LOW] FL • C1725: [BATT VOLT LOW] FR • C1726: [BATT VOLT LOW] RR • C1727: [BATT VOLT LOW] RL • C1734: CONTROL UNIT
6	<ul style="list-style-type: none"> • B2621: INSIDE ANTENNA • B2622: INSIDE ANTENNA • B2623: INSIDE ANTENNA

BCM (BODY CONTROL MODULE)

< ECU DIAGNOSIS >

DTC Index

INFOID:000000003773254

NOTE:

The details of time display are as follows.

- CRNT: A malfunction is detected now.
- PAST: A malfunction was detected in the past.

IGN counter is displayed on Freeze Frame Data. For details of Freeze Frame Data and IGN Counter, refer to [BCS-16, "COMMON ITEM : CONSULT-III Function \(BCM - COMMON ITEM\)"](#).

CONSULT display	Fail-safe	Freeze Frame Data	Intelligent Key warning lamp ON	Tire pressure monitor warning lamp ON	Reference page
No DTC is detected. further testing may be required.	—	—	—	—	—
U1000: CAN COMM CIRCUIT	—	—	—	—	BCS-37
U1010: CONTROL UNIT (CAN)	—	—	—	—	BCS-38
U0415: VEHICLE SPEED SIG	—	—	—	—	BCS-39
B2013: ID DISCORD BCM-S/L	×	×	—	—	SEC-48
B2014: CHAIN OF S/L-BCM	×	×	—	—	SEC-49
B2190: NATS ANTENNA AMP	×	—	—	—	SEC-42
B2191: DIFFERENCE OF KEY	×	—	—	—	SEC-45
B2192: ID DISCORD BCM-ECM	×	—	—	—	SEC-46
B2193: CHAIN OF BCM-ECM	×	—	—	—	SEC-47
B2553: IGNITION RELAY	—	×	—	—	PCS-49
B2555: STOP LAMP	—	×	—	—	SEC-52
B2556: PUSH-BTN IGN SW	—	×	×	—	SEC-54
B2557: VEHICLE SPEED	×	×	×	—	SEC-56
B2560: STARTER CONT RELAY	×	×	×	—	SEC-57
B2562: LOW VOLTAGE	—	×	—	—	BCS-40
B2601: SHIFT POSITION	×	×	×	—	SEC-58
B2602: SHIFT POSITION	×	×	×	—	SEC-61
B2603: SHIFT POSI STATUS	×	×	×	—	SEC-63
B2604: PNP SW	×	×	×	—	SEC-66
B2605: PNP SW	×	×	×	—	SEC-68
B2606: S/L RELAY	×	×	×	—	SEC-70
B2607: S/L RELAY	×	×	×	—	SEC-71
B2608: STARTER RELAY	×	×	×	—	SEC-73
B2609: S/L STATUS	×	×	×	—	SEC-75
B260A: IGNITION RELAY	×	×	×	—	PCS-51
B260B: STEERING LOCK UNIT	—	×	×	—	SEC-79
B260C: STEERING LOCK UNIT	—	×	×	—	SEC-80
B260D: STEERING LOCK UNIT	—	×	×	—	SEC-81
B260F: ENG STATE SIG LOST	×	×	×	—	SEC-82
B2612: S/L STATUS	×	×	×	—	SEC-86
B2614: ACC RELAY CIRC	—	×	×	—	PCS-53
B2615: BLOWER RELAY CIRC	—	×	×	—	PCS-57
B2616: IGN RELAY CIRC	—	×	×	—	PCS-59
B2617: STARTER RELAY CIRC	×	×	×	—	SEC-90

BCM (BODY CONTROL MODULE)

< ECU DIAGNOSIS >

CONSULT display	Fail-safe	Freeze Frame Data	Intelligent Key warning lamp ON	Tire pressure monitor warning lamp ON	Reference page
B2618: BCM	×	×	×	—	PCS-61
B2619: BCM	×	×	×	—	SEC-92
B261A: PUSH-BTN IGN SW	—	×	×	—	SEC-93
B261E: VEHICLE TYPE	×	×	× (Turn ON for 15 seconds)	—	SEC-96
B2621: INSIDE ANTENNA	—	×	—	—	DLK-56
B2622: INSIDE ANTENNA	—	×	—	—	DLK-58
B2623: INSIDE ANTENNA	—	×	—	—	DLK-60
B26E1: ENG STATE NO RES	×	×	×	—	SEC-83
B26E9: S/L STATUS	×	×	× (Turn ON for 15 seconds)	—	SEC-84
B26EA: KEY REGISTRATION	—	×	× (Turn ON for 15 seconds)	—	SEC-85
C1704: LOW PRESSURE FL	—	—	—	×	WT-16
C1705: LOW PRESSURE FR	—	—	—	×	
C1706: LOW PRESSURE RR	—	—	—	×	
C1707: LOW PRESSURE RL	—	—	—	×	
C1708: [NO DATA] FL	—	—	—	×	WT-18
C1709: [NO DATA] FR	—	—	—	×	
C1710: [NO DATA] RR	—	—	—	×	
C1711: [NO DATA] RL	—	—	—	×	
C1712: [CHECKSUM ERR] FL	—	—	—	×	WT-21
C1713: [CHECKSUM ERR] FR	—	—	—	×	
C1714: [CHECKSUM ERR] RR	—	—	—	×	
C1715: [CHECKSUM ERR] RL	—	—	—	×	
C1716: [PRESSDATA ERR] FL	—	—	—	×	WT-24
C1717: [PRESSDATA ERR] FR	—	—	—	×	
C1718: [PRESSDATA ERR] RR	—	—	—	×	
C1719: [PRESSDATA ERR] RL	—	—	—	×	
C1720: [CODE ERR] FL	—	—	—	×	WT-26
C1721: [CODE ERR] FR	—	—	—	×	
C1722: [CODE ERR] RR	—	—	—	×	
C1723: [CODE ERR] RL	—	—	—	×	
C1724: [BATT VOLT LOW] FL	—	—	—	×	WT-29
C1725: [BATT VOLT LOW] FR	—	—	—	×	
C1726: [BATT VOLT LOW] RR	—	—	—	×	
C1727: [BATT VOLT LOW] RL	—	—	—	×	
C1729: VHCL SPEED SIG ERR	—	—	—	×	WT-32
C1734: CONTROL UNIT	—	—	—	×	WT-33

SUNROOF SYSTEM

< ECU DIAGNOSIS >

SUNROOF SYSTEM SUNROOF MOTOR ASSEMBLY

SUNROOF MOTOR ASSEMBLY : Reference Value

INFOID:000000003137022

TERMINAL LAYOUT

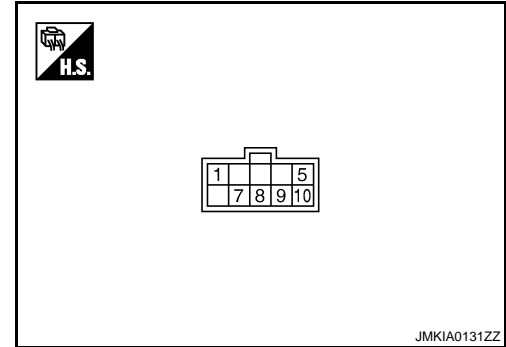

PHYSICAL VALUES

Terminal No. (Wire color)		Description		Condition	Voltage (V) (Approx.)
+	-	Signal name	Input/ Out- put		
1 (GR)	Ground	Sunroof close switch (BIT 1) signal	Input	Sunroof switch in following position • TILT UP • SLIDE CLOSE	0
				Other than above	Battery voltage
5 (P)	Ground	Sunroof open switch (BIT 0) signal	Input	Sunroof switch in following position • TILT DOWN • SLIDE OPEN	0
				Other than above	Battery voltage
7 (W)	Ground	Sunroof power supply	Input	—	Battery voltage
8 (L)	Ground	Vehicle speed signal (2-pulse)	Input	Speedometer operated [When vehicle speed is approx. 40km/ h (25MPH)]	
9 (Y)	Ground	RAP signal	Input	Ignition switch ON	Battery voltage
				Within 45 second after ignition switch is turned to OFF.	Battery voltage
				When driver side or passenger side door is opened during retained power operation.	0
10 (B)	Ground	Ground	—	—	0

SUNROOF SYSTEM

< ECU DIAGNOSIS >

SUNROOF MOTOR ASSEMBLY : Wiring Diagram - SUNROOF -

INFOID:000000003751306

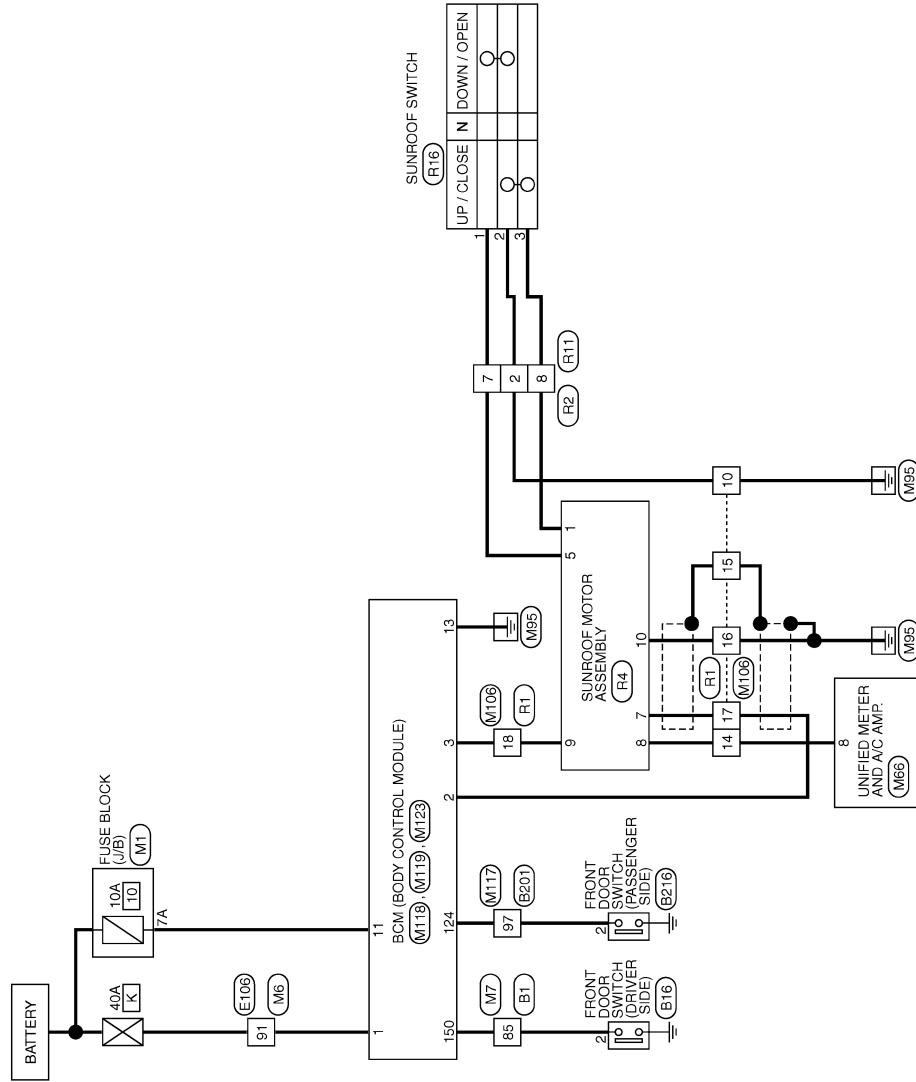

SUNROOF

2007/10/26

JCKWM1099GI

SUNROOF SYSTEM

< ECU DIAGNOSIS >

SUNROOF

Connector No. B1	WIRE TO WIRE TH80FW-CS16-TM4		Terminal No. 85	Color of Wire V	Signal Name [Specification]	—
Connector No. B201	WIRE TO WIRE TH80FW-CS16-TM4		Terminal No. 97	Color of Wire GR	Signal Name [Specification]	—
Connector No. B16	FRONT DOOR SWITCH (DRIVER SIDE) A03FW		Terminal No. 2	Color of Wire V	Signal Name [Specification]	—
Connector No. E108	WIRE TO WIRE TH80FW-CS16-TM4		Terminal No. 91	Color of Wire W	Signal Name [Specification]	—
Connector No. B216	FRONT DOOR SWITCH (PASSENGER SIDE) A03FW		Terminal No. 2	Color of Wire GR	Signal Name [Specification]	—
Connector No. M1	FUSE BLOCK (J/B) NS00FW-M2		Terminal No. 7A	Color of Wire R	Signal Name [Specification]	—
Connector No. M7	WIRE TO WIRE TH80MW-CS16-TM4		Terminal No. 85	Color of Wire LG	Signal Name [Specification]	—
Connector No. M6	WIRE TO WIRE TH80MW-CS16-TM4		Terminal No. 91	Color of Wire W	Signal Name [Specification]	—

A
B
C
D
E
F
G
H
I
J
RF
L
M
N
O
P

JCKWM1100G1

SUNROOF SYSTEM

< ECU DIAGNOSIS >

SUNROOF

Connector No.	M66
Connector Name	UNIFIED METER AND A/C AMP.
Connector Type	TH4DFV-NH

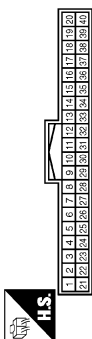

Terminal No.	Color of Wire	Signal Name [Specification]
8	L	VEHICLE SPEED (2-PULSE)

Connector No.	M106
Connector Name	WIRE TO WIRE
Connector Type	TK10MPF-NS8



Terminal No.	Color of Wire	Signal Name [Specification]
10	B	-
14	L	-
15	SHIELD	-
16	G	-
17	BR	-
18	Y	-

Connector No.	M117
Connector Name	WIRE TO WIRE
Connector Type	TH2DMW-CS18-TM4

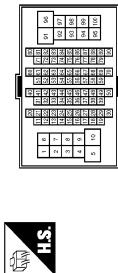

Terminal No.	Color of Wire	Signal Name [Specification]
97	LG	-

Connector No.	M118
Connector Name	BCM (BODY CONTROL MODULE)
Connector Type	IM03FB-LC

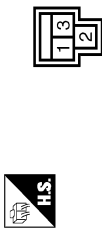

Terminal No.	Color of Wire	Signal Name [Specification]
1	W	BAT (F/L)
2	Y	POWER WINDOW POWER SUPPLY(BAT)
3	O	POWER WINDOW POWER SUPPLY(TRAP)

Connector No.	M119
Connector Name	BCM (BODY CONTROL MODULE)
Connector Type	NS16FW-CS

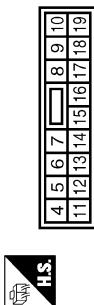

Terminal No.	Color of Wire	Signal Name [Specification]
11	R	BAT (FUSE)
13	B	GND

Connector No.	M123
Connector Name	BCM (BODY CONTROL MODULE)
Connector Type	TH4DFG-NH

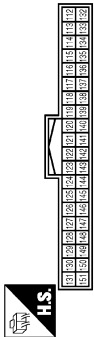

Terminal No.	Color of Wire	Signal Name [Specification]
124	LG	PASSENGER DOOR SW
150	LG	DRIVER DOOR SW

Connector No.	R1
Connector Name	WIRE TO WIRE
Connector Type	TK10FW-NS8



Terminal No.	Color of Wire	Signal Name [Specification]
10	B	-
14	L	-
15	SHIELD	-
16	B	-
17	W	-
18	Y	-

Connector No.	FZ
Connector Name	WIRE TO WIRE
Connector Type	TH1ZFW-NH





Terminal No.	Color of Wire	Signal Name [Specification]
2	B	-
7	P	-
8	GR	-

JCKW1101G1

SUNROOF SYSTEM

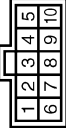
< ECU DIAGNOSIS >

SUNROOF		
Connector No.	R4	R18
Connector Name	SUNROOF MOTOR ASSEMBLY	SUNROOF SWITCH
Connector Type	TEA10PGY	TKG3FW
 		
Terminal No.	Color of Wire	Signal Name [Specification]
1	GR	
5	P	SW-BIT1
7	W	SW-BIT0
8	L	-R
9	Y	SPEED SENSOR(2P)
10	B	TIMER(LGN)
		GND

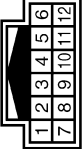
Connector No.	R11	R18
Connector Name	WIRE TO WIRE	SUNROOF SWITCH
Connector Type	TH12MPH-NH	TKG3FW
 		
Terminal No.	Color of Wire	Signal Name [Specification]
2	B	
7	P	
8	BR	

Terminal No.	Color of Wire	Signal Name [Specification]
1	P	
2	B	
3	BR	

JCKWM1102GI

A
B
C
D
E
F
G
H
I
J
RF
L
M
N
O
P

SUNROOF DOES NOT OPERATE PROPERLY

< SYMPTOM DIAGNOSIS >

SYMPTOM DIAGNOSIS

SUNROOF DOES NOT OPERATE PROPERLY

Diagnosis Procedure

INFOID:000000003624718

1. CHECK BCM POWER SUPPLY AND GROUND CIRCUIT

Check BCM power supply and ground circuit.

Refer to [RF-9, "BCM \(BODY CONTROL MODULE\) : Diagnosis Procedure"](#).

Is the inspection result normal?

YES >> GO TO 2.

NO >> Repair or replace the malfunctioning parts.

2. CHECK SUNROOF MOTOR ASSEMBLY POWER SUPPLY AND GROUND CIRCUIT

Check sunroof motor assembly power supply and ground circuit.

Refer to [RF-9, "SUNROOF MOTOR ASSEMBLY : Diagnosis Procedure"](#).

Is the inspection result normal?

YES >> GO TO 3.

NO >> Repair or replace the malfunctioning parts.

3. CHECK SUNROOF SWITCH

Check sunroof switch.

Refer to [RF-11, "Component Function Check"](#).

Is the inspection result normal?

YES >> GO TO 4.

NO >> Repair or replace sunroof switch.

4. CONFIRM THE OPERATION

Confirm the operation again.

Is the result normal?

YES >> Check intermittent incident. Refer to [GI-38, "Intermittent Incident"](#).

NO >> GO TO 1.

AUTO OPERATION DOES NOT OPERATE

< SYMPTOM DIAGNOSIS >

AUTO OPERATION DOES NOT OPERATE

Diagnosis Procedure

INFOID:000000003624719

1. PERFORM INITIALIZATION PROCEDURE

Perform initialization procedure.

Refer to [RF-4, "ADDITIONAL SERVICE WHEN REPLACING CONTROL UNIT : Special Repair Requirement"](#).

Is the inspection result normal?

YES >> INSPECTION END

NO >> Replace sunroof motor assembly.

A
B
C
D
E
F
G
H
I
J
RF
L
M
N
O
P

DOES NOT STOP FULLY-OPEN OR FULLY-CLOSED POSITION

< SYMPTOM DIAGNOSIS >

DOES NOT STOP FULLY-OPEN OR FULLY-CLOSED POSITION

Diagnosis Procedure

INFOID:000000003624720

1. PERFORM INITIALIZATION PROCEDURE

Perform initialization procedure.

Refer to [RF-4, "ADDITIONAL SERVICE WHEN REPLACING CONTROL UNIT : Special Repair Requirement"](#).

Is the inspection result normal?

YES >> INSPECTION END

NO >> Replace sunroof motor assembly.

POWER WINDOW RETAINED POWER OPERATION DOES NOT OPERATE PROPERLY

< SYMPTOM DIAGNOSIS >

POWER WINDOW RETAINED POWER OPERATION DOES NOT OPERATE PROPERLY

Diagnosis Procedure

INFOID:000000003624721

1. CHECK DOOR SWITCH

Check door switch.

Refer to [RF-13, "Component Function Check"](#).

Is the inspection result normal?

YES >> GO TO 2.

NO >> Repair or replace the malfunctioning parts.

2. CONFIRM THE OPERATION

Confirm the operation again.

Is the result normal?

YES >> Check intermittent incident. Refer to [GI-38, "Intermittent Incident"](#).

NO >> GO TO 1.

A
B
C
D
E
F
G
H
I
J
L
M
N
O
P

RF

SUNROOF DOES NOT OPERATE ANTI-PINCH FUNCTION

< SYMPTOM DIAGNOSIS >

SUNROOF DOES NOT OPERATE ANTI-PINCH FUNCTION

Diagnosis Procedure

INFOID:000000003624722

1. PERFORM INITIALIZATION PROCEDURE

Perform initialization procedure.

Refer to [RF-4, "ADDITIONAL SERVICE WHEN REPLACING CONTROL UNIT : Special Repair Requirement"](#).

Is the inspection result normal?

YES >> INSPECTION END

NO >> Replace sunroof motor assembly.

SQUEAK AND RATTLE TROUBLE DIAGNOSES

< SYMPTOM DIAGNOSIS >

SQUEAK AND RATTLE TROUBLE DIAGNOSES

Work Flow

INFOID:000000003137029

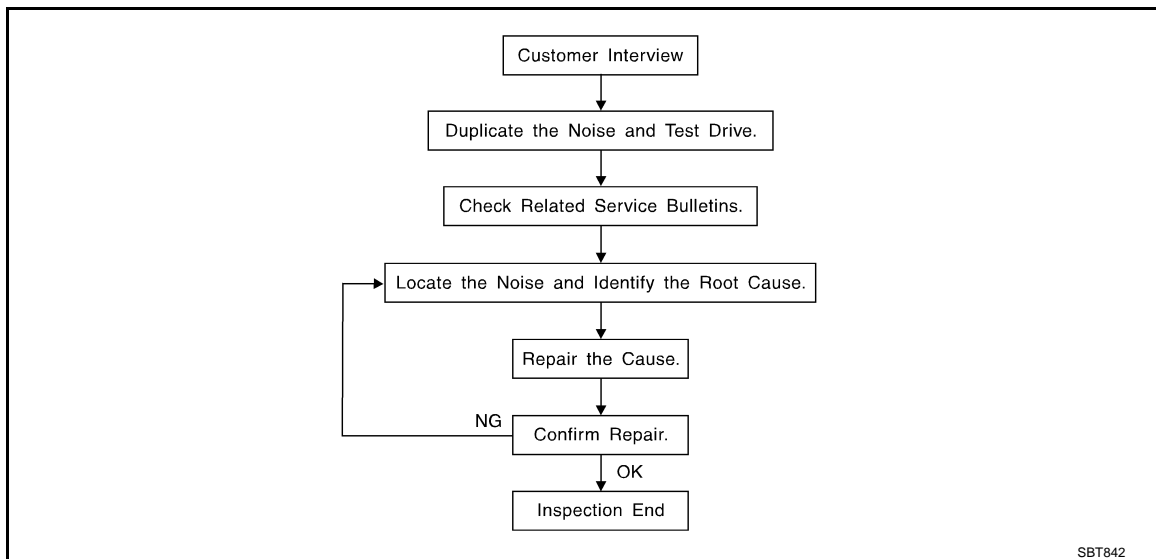

CUSTOMER INTERVIEW

Interview the customer if possible, to determine the conditions that exist when the noise occurs. Use the Diagnostic Worksheet during the interview to document the facts and conditions when the noise occurs and any of customer's comments; refer to [RF-69, "Diagnostic Worksheet"](#). This information is necessary to duplicate the conditions that exist when the noise occurs.

- The customer may not be able to provide a detailed description or the location of the noise. Attempt to obtain all the facts and conditions that exist when the noise occurs (or does not occur).
- If there is more than one noise in the vehicle, perform a diagnosis and repair the noise that the customer is concerned about. This can be accomplished by performing a cruise test on the vehicle with the customer.
- After identifying the type of noise, isolate the noise in terms of its characteristics. The noise characteristics are provided so the customer, service adviser and technician are all speaking the same language when defining the noise.
- Squeak – (Like tennis shoes on a clean floor)
Squeak characteristics include the light contact/fast movement/brought on by road conditions/hard surfaces = higher pitch noise/softer surfaces = lower pitch noises/edge to surface = chirping
- Creak – (Like walking on an old wooden floor)
Creak characteristics include firm contact/slow movement/twisting with a rotational movement/pitch dependent on materials/often brought on by activity.
- Rattle – (Like shaking a baby rattle)
Rattle characteristics include the fast repeated contact/vibration or similar movement/loose parts/missing clip or fastener/incorrect clearance.
- Knock – (Like a knock on a door)
Knock characteristics include hollow sounding/sometimes repeating/often brought on by driver action.
- Tick – (Like a clock second hand)
Tick characteristics include gentle contacting of light materials/loose components/can be caused by driver action or road conditions.
- Thump – (Heavy, muffled knock noise)
Thump characteristics include softer knock/dead sound often brought on by activity.
- Buzz – (Like a bumblebee)
Buzz characteristics include high frequency rattle/firm contact.
- Often the degree of acceptable noise level will vary depending up on the person. A noise that you may judge as acceptable may be very irritating to the customer.
- Weather conditions, especially humidity and temperature, may have a great effect on noise level.

DUPLICATE THE NOISE AND TEST DRIVE

If possible, drive the vehicle with the customer until the noise is duplicated. Note any additional information on the Diagnostic Worksheet regarding the conditions or location of the noise. This information can be used to duplicate the same conditions when you confirm the repair.

SQUEAK AND RATTLE TROUBLE DIAGNOSES

< SYMPTOM DIAGNOSIS >

If the noise can be duplicated easily during the test drive, to help identify the source of the noise, try to duplicate the noise with the vehicle stopped by doing one or all of the following:

- 1) Close a door.
 - 2) Tap or push/pull around the area where the noise appears to be coming from.
 - 3) Rev the engine.
 - 4) Use a floor jack to recreate vehicle "twist".
 - 5) At idle, apply engine load (electrical load, half-clutch on M/T models, drive position on A/T models).
 - 6) Raise the vehicle on a hoist and hit a tire with a rubber hammer.
- Drive the vehicle and attempt to duplicate the conditions the customer states exist when the noise occurs.
 - If it is difficult to duplicate the noise, drive the vehicle slowly on an undulating or rough road to stress the vehicle body.

CHECK RELATED SERVICE BULLETINS

After verifying the customer concern or symptom, check ASIST for Technical Service Bulletins (TSBs) related to that concern or symptom.

If a TSB relates to the symptom, follow the procedure to repair the noise.

LOCATE THE NOISE AND IDENTIFY THE ROOT CAUSE

1. Narrow down the noise to a general area. To help pinpoint the source of the noise, use a listening tool (Chassis Ear: J-39570, Engine Ear and mechanics stethoscope).
2. Narrow down the noise to a more specific area and identify the cause of the noise by:
 - Removing the components in the area that you suspect the noise is coming from.
Do not use too much force when removing clips and fasteners, otherwise clips and fastener can be broken or lost during the repair, resulting in the creation of new noise.
 - Tapping or pushing/pulling the component that you suspect is causing the noise.
Do not tap or push/pull the component with excessive force, otherwise the noise will be eliminated only temporarily.
 - Feeling for a vibration with your hand by touching the component(s) that you suspect is (are) causing the noise.
 - Placing a piece of paper between components that you suspect are causing the noise.
 - Looking for loose components and contact marks.
Refer to [RF-67, "Inspection Procedure"](#).

REPAIR THE CAUSE

- If the cause is a loose component, tighten the component securely.
- If the cause is insufficient clearance between components:
 - Separate components by repositioning or loosening and retightening the component, if possible.
 - Insulate components with a suitable insulator such as urethane pads, foam blocks, felt cloth tape or urethane tape. A Nissan Squeak and Rattle Kit (J-43980) is available through your authorized Nissan Parts Department.

CAUTION:

Do not use excessive force as many components are constructed of plastic and may be damaged.

NOTE:

Always check with the Parts Department for the latest parts information.

The following materials are contained in the Nissan Squeak and Rattle Kit (J-43980). Each item can be ordered separately as needed.

URETHANE PADS [1.5 mm (0.059 in) thick]

Insulates connectors, harness, etc.

76268-9E005: 100 × 135 mm (3.94 × 5.31 in)/76884-71L01: 60 × 85 mm (2.36 × 3.35 in)/76884-71L02: 15 × 25 mm (0.59 × 0.98 in)

INSULATOR (Foam blocks)

Insulates components from contact. Can be used to fill space behind a panel.

73982-9E000: 45 mm (1.77 in) thick, 50 × 50 mm (1.97 × 1.97 in)/73982-

50Y00: 10 mm (0.39 in) thick, 50 × 50 mm (1.97 × 1.97 in)

INSULATOR (Light foam block)

80845-71L00: 30 mm (1.18 in) thick, 30 × 50 mm (1.18 × 1.97in)

FELT CLOTHTAPE

Used to insulate where movement does not occur. Ideal for instrument panel applications.

68370-4B000: 15 × 25 mm (0.59 × 0.98 in) pad/68239-13E00: 5 mm (0.20 in) wide tape roll

The following materials, not found in the kit, can also be used to repair squeaks and rattles.

UHMW (TEFLON) TAPE

SQUEAK AND RATTLE TROUBLE DIAGNOSES

< SYMPTOM DIAGNOSIS >

Insulates where slight movement is present. Ideal for instrument panel applications.

SILICONE GREASE

Used in place of UHMW tape that will be visible or not fit. Will only last a few months.

SILICONE SPRAY

Use when grease cannot be applied.

DUCT TAPE

Use to eliminate movement.

CONFIRM THE REPAIR

Confirm that the cause of a noise is repaired by test driving the vehicle. Operate the vehicle under the same conditions as when the noise originally occurred. Refer to the notes on the Diagnostic Worksheet.

Inspection Procedure

INFOID:000000003137030

Refer to Table of Contents for specific component removal and installation information.

INSTRUMENT PANEL

Most incidents are caused by contact and movement between:

1. The cluster lid A and instrument panel
2. Acrylic lens and combination meter housing
3. Instrument panel to front pillar garnish
4. Instrument panel to windshield
5. Instrument panel mounting pins
6. Wiring harnesses behind the combination meter
7. A/C defroster duct and duct joint

These incidents can usually be located by tapping or moving the components to duplicate the noise or by pressing on the components while driving to stop the noise. Most of these incidents can be repaired by applying felt cloth tape or silicon spray (in hard to reach areas). Urethane pads can be used to insulate wiring harness.

CAUTION:

Do not use silicone spray to isolate a squeak or rattle. If you saturate the area with silicone, you will not be able to recheck the repair.

CENTER CONSOLE

Components to pay attention to include:

1. Shifter assembly cover to finisher
2. A/C control unit and cluster lid C
3. Wiring harnesses behind audio and A/C control unit

The instrument panel repair and isolation procedures also apply to the center console.

DOORS

Pay attention to the:

1. Finisher and inner panel making a slapping noise
2. Inside handle escutcheon to door finisher
3. Wiring harnesses tapping
4. Door striker out of alignment causing a popping noise on starts and stops

Tapping or moving the components or pressing on them while driving to duplicate the conditions can isolate many of these incidents. You can usually insulate the areas with felt cloth tape or insulator foam blocks from the Nissan Squeak and Rattle Kit (J-43980) to repair the noise.

TRUNK

Trunk noises are often caused by a loose jack or loose items put into the trunk by the owner.

In addition look for:

1. Trunk lid dumpers out of adjustment
2. Trunk lid striker out of adjustment
3. The trunk lid torsion bars knocking together
4. A loose license plate or bracket

A

B

C

D

E

F

G

H

I

J

RF

L

M

N

O

P

SQUEAK AND RATTLE TROUBLE DIAGNOSES

< SYMPTOM DIAGNOSIS >

Most of these incidents can be repaired by adjusting, securing or insulating the item(s) or component(s) causing the noise.

SUNROOF/HEADLINING

Noises in the sunroof/headlining area can often be traced to one of the following:

1. Sunroof lid, rail, linkage or seals making a rattle or light knocking noise
2. Sunvisor shaft shaking in the holder
3. Front or rear windshield touching headlining and squeaking

Again, pressing on the components to stop the noise while duplicating the conditions can isolate most of these incidents. Repairs usually consist of insulating with felt cloth tape.

SEATS

When isolating seat noise it's important to note the position the seat is in and the load placed on the seat when the noise is present. These conditions should be duplicated when verifying and isolating the cause of the noise.

Cause of seat noise include:

1. Headrest rods and holder
2. A squeak between the seat pad cushion and frame
3. The rear seatback lock and bracket

These noises can be isolated by moving or pressing on the suspected components while duplicating the conditions under which the noise occurs. Most of these incidents can be repaired by repositioning the component or applying urethane tape to the contact area.

UNDERHOOD

Some interior noise may be caused by components under the hood or on the engine wall. The noise is then transmitted into the passenger compartment.

Causes of transmitted under hood noise include:

1. Any component mounted to the engine wall
2. Components that pass through the engine wall
3. Engine wall mounts and connectors
4. Loose radiator mounting pins
5. Hood bumpers out of adjustment
6. Hood striker out of adjustment

These noises can be difficult to isolate since they cannot be reached from the interior of the vehicle. The best method is to secure, move or insulate one component at a time and test drive the vehicle. Also, engine RPM or load can be changed to isolate the noise. Repairs can usually be made by moving, adjusting, securing, or insulating the component causing the noise.

SQUEAK AND RATTLE TROUBLE DIAGNOSES

< SYMPTOM DIAGNOSIS >

Diagnostic Worksheet

INFOID:000000003137031



SQUEAK & RATTLE DIAGNOSTIC WORKSHEET

Dear Infiniti Customer:

We are concerned about your satisfaction with your Infiniti vehicle. Repairing a squeak or rattle sometimes can be very difficult. To help us fix your Infiniti right the first time, please take a moment to note the area of the vehicle where the squeak or rattle occurs and under what conditions. You may be asked to take a test drive with a service consultant or technician to ensure we confirm the noise you are hearing.

I. WHERE DOES THE NOISE COME FROM? (circle the area of the vehicle)

The illustrations are for reference only, and may not reflect the actual configuration of your vehicle.

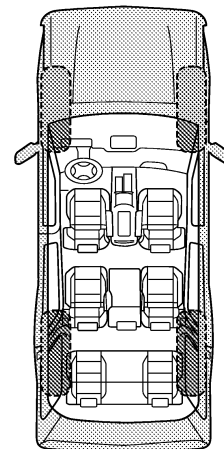
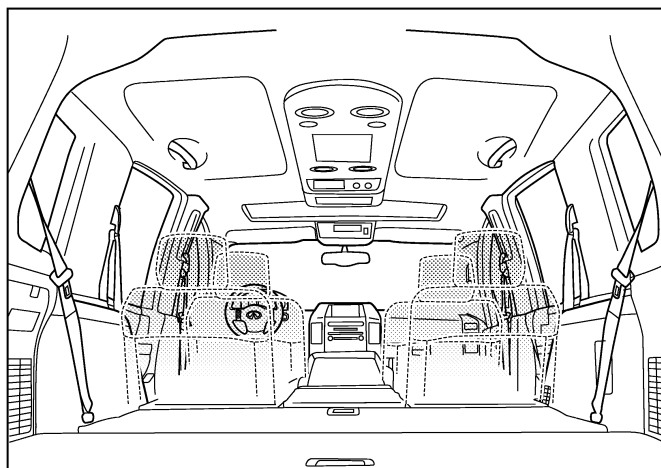
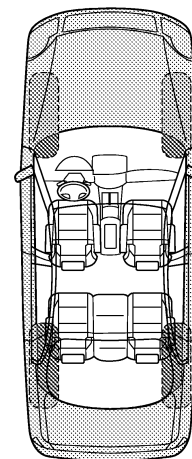
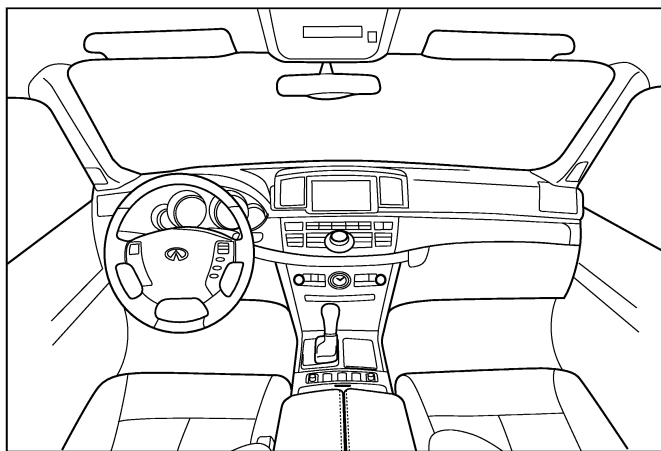

Continue to page 2 of the worksheet and briefly describe the location of the noise or rattle. In addition, please indicate the conditions which are present when the noise occurs.

PIIB8741E

A
B
C
D
E
F
G
H
I
J
RF
L
M
N
O
P

SQUEAK AND RATTLE TROUBLE DIAGNOSES

< SYMPTOM DIAGNOSIS >

SQUEAK & RATTLE DIAGNOSTIC WORKSHEET - page 2

Briefly describe the location where the noise occurs:

II. WHEN DOES IT OCCUR? (please check the boxes that apply)

- | | |
|---|--|
| <input type="checkbox"/> anytime | <input type="checkbox"/> after sitting out in the rain |
| <input type="checkbox"/> 1st time in the morning | <input type="checkbox"/> when it is raining or wet |
| <input type="checkbox"/> only when it is cold outside | <input type="checkbox"/> dry or dusty conditions |
| <input type="checkbox"/> only when it is hot outside | <input type="checkbox"/> other: |

III. WHEN DRIVING:

- through driveways
- over rough roads
- over speed bumps
- only about ____ mph
- on acceleration
- coming to a stop
- on turns: left, right or either (circle)
- with passengers or cargo
- other: _____
- after driving ____ miles or ____ minutes

IV. WHAT TYPE OF NOISE

- squeak (like tennis shoes on a clean floor)
- creak (like walking on an old wooden floor)
- rattle (like shaking a baby rattle)
- knock (like a knock at the door)
- tick (like a clock second hand)
- thump (heavy, muffled knock noise)
- buzz (like a bumble bee)

TO BE COMPLETED BY DEALERSHIP PERSONNEL

Test Drive Notes:

	YES	NO	Initials of person performing
Vehicle test driven with customer	<input type="checkbox"/>	<input type="checkbox"/>	_____
- Noise verified on test drive	<input type="checkbox"/>	<input type="checkbox"/>	_____
- Noise source located and repaired	<input type="checkbox"/>	<input type="checkbox"/>	_____
- Follow up test drive performed to confirm repair	<input type="checkbox"/>	<input type="checkbox"/>	_____

VIN: _____ Customer Name: _____
W.O.# _____ Date: _____

This form must be attached to Work Order

PIIB8742E

PRECAUTIONS

< PRECAUTION >

PRECAUTION

PRECAUTIONS

Precaution for Supplemental Restraint System (SRS) "AIR BAG" and "SEAT BELT PRE-TENSIONER"

INFOID:000000003751413

The Supplemental Restraint System such as "AIR BAG" and "SEAT BELT PRE-TENSIONER", used along with a front seat belt, helps to reduce the risk or severity of injury to the driver and front passenger for certain types of collision. This system includes seat belt switch inputs and dual stage front air bag modules. The SRS system uses the seat belt switches to determine the front air bag deployment, and may only deploy one front air bag, depending on the severity of a collision and whether the front occupants are belted or unbelted. Information necessary to service the system safely is included in the "SRS AIRBAG" and "SEAT BELT" of this Service Manual.

WARNING:

- To avoid rendering the SRS inoperative, which could increase the risk of personal injury or death in the event of a collision which would result in air bag inflation, all maintenance must be performed by an authorized NISSAN/INFINITI dealer.
- Improper maintenance, including incorrect removal and installation of the SRS, can lead to personal injury caused by unintentional activation of the system. For removal of Spiral Cable and Air Bag Module, see the "SRS AIRBAG".
- Do not use electrical test equipment on any circuit related to the SRS unless instructed to in this Service Manual. SRS wiring harnesses can be identified by yellow and/or orange harnesses or harness connectors.

Precaution Necessary for Steering Wheel Rotation after Battery Disconnect

INFOID:000000003751412

NOTE:

- Before removing and installing any control units, first turn the push-button ignition switch to the LOCK position, then disconnect both battery cables.
- After finishing work, confirm that all control unit connectors are connected properly, then re-connect both battery cables.
- Always use CONSULT-III to perform self-diagnosis as a part of each function inspection after finishing work. If a DTC is detected, perform trouble diagnosis according to self-diagnosis results.

This vehicle is equipped with a push-button ignition switch and a steering lock unit.

If the battery is disconnected or discharged, the steering wheel will lock and cannot be turned.

If turning the steering wheel is required with the battery disconnected or discharged, follow the procedure below before starting the repair operation.

OPERATION PROCEDURE

1. Connect both battery cables.

NOTE:

Supply power using jumper cables if battery is discharged.

2. Turn the push-button ignition switch to ACC position.
(At this time, the steering lock will be released.)
3. Disconnect both battery cables. The steering lock will remain released with both battery cables disconnected and the steering wheel can be turned.
4. Perform the necessary repair operation.
5. When the repair work is completed, re-connect both battery cables. With the brake pedal released, turn the push-button ignition switch from ACC position to ON position, then to LOCK position. (The steering wheel will lock when the push-button ignition switch is turned to LOCK position.)
6. Perform self-diagnosis check of all control units using CONSULT-III.

PREPARATION

< PREPARATION >



PREPARATION

PREPARATION

Special Service Tool

INFOID:000000003137035

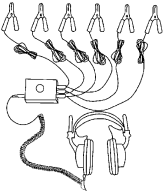
The actual shapes of Kent-Moore tools may differ from those of special service tools illustrated here.

Tool number (Kent-Moore No.) Tool name	Description
(J39570) Chassis ear  SIIA0993E	Locating the noise
(J43980) NISSAN Squeak and Rattle Kit  SIIA0994E	Repairing the cause of noise

Commercial Service Tool

INFOID:000000003137036

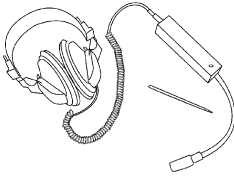
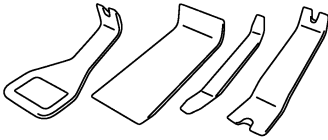
Tool name	Description
Engine ear  SIIA0995E	Locating the noise
Remover tool  PIIB7923J	Remove the clips, pawls and metal clips

GLASS LID

< ON-VEHICLE REPAIR >

ON-VEHICLE REPAIR

GLASS LID

Exploded View

INFOID:000000003545364

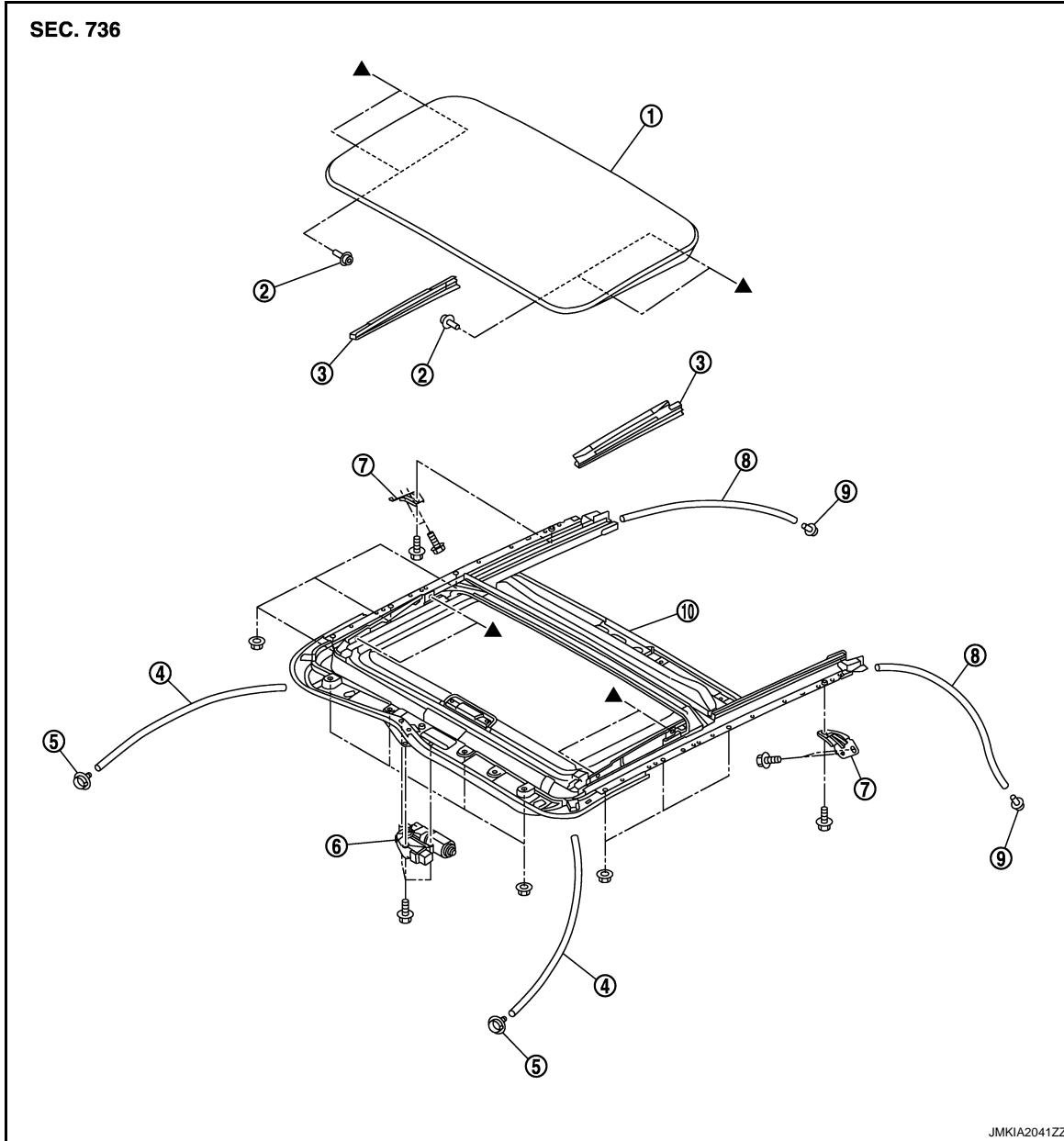

- | | | |
|----------------------------|----------------------------|---------------------------|
| 1. Glass lid | 2. TORX bolt | 3. Inner blind (LH/RH) |
| 4. Drain hose (front) | 5. Drain connector (front) | 6. Sunroof motor assembly |
| 7. Sunroof bracket (LH/RH) | 8. Drain hose (rear) | 9. Drain connector (rear) |
| 10. Sunroof unit assembly | | |

Removal and Installation

INFOID:000000003545365

REMOVAL

CAUTION:

Always work with a helper.

1. Remove the inner blind upper side, and then fold the inner blind so that the TORX bolts can be seen.

A
B
C
D
E
F
G
H
I
J
RF
L
M
N
O
P

GLASS LID

< ON-VEHICLE REPAIR >

- Remove the TORX bolts (A), and then remove the glass lid.

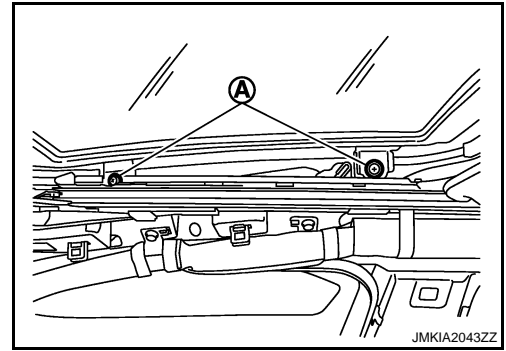

- Remove the glass lid from the vehicle.

INSTALLATION

CAUTION:

After installing the glass lid, perform the leak test and check that there is no malfunction.

NOTE:

After installation perform fitting adjustment. Refer to [RF-74, "Adjustment"](#).
Install in the reverse order of removal.

Adjustment

INFOID:000000003545366

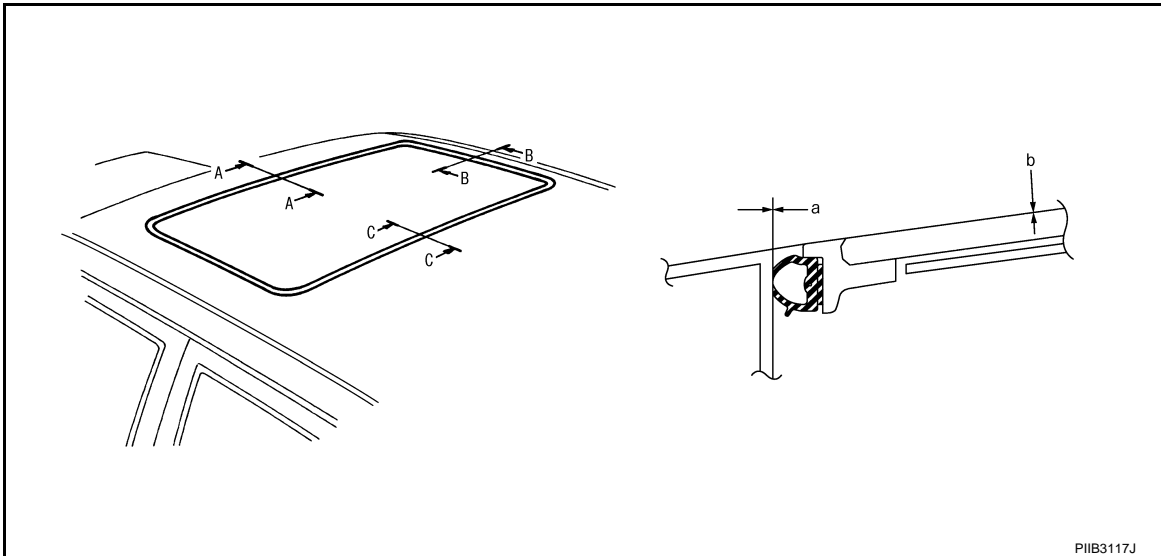

PIIB3117J

LID WEATHER-STRIP OVERLAP ADJUSTMENT AND SURFACE MISMATCH ADJUSTMENT

- Remove the side trim upper side, and then fold the side trim so that the TORX bolts can be seen.
- After loosening glass lid from TORX bolts (left and right), tilt down glass lid.
- Adjust glass lid from outside of vehicle so it resembles "A – A" "B – B" "C – C" as shown in the figure.

	a	b
A – A	0.6 – 2.2 mm (0.024 – 0.087 in)	–1.5 – 1.5 mm (–0.059 – 0.059 in)
B – B	0.6 – 2.2 mm (0.024 – 0.087 in)	–1.5 – 1.5 mm (–0.059 – 0.059 in)
C – C	0.6 – 2.2 mm (0.024 – 0.087 in)	–1.5 – 1.5 mm (–0.059 – 0.059 in)

- To prevent glass lid from moving after adjustment, first tighten the TORX bolts of front left, and then tighten the TORX bolts of rear right.
- Tighten remaining TORX bolts, being careful to prevent glass lid from moving.
- Tilt glass lid up and down several times to check that it moves smoothly.

NOTE:

After adjustment the sunroof unit assembly, perform additional service. Refer to [RF-4, "ADDITIONAL SERVICE WHEN REPLACING CONTROL UNIT : Special Repair Requirement"](#).

SUNROOF MOTOR ASSEMBLY

< ON-VEHICLE REPAIR >

SUNROOF MOTOR ASSEMBLY

Exploded View

INFOID:000000003547905

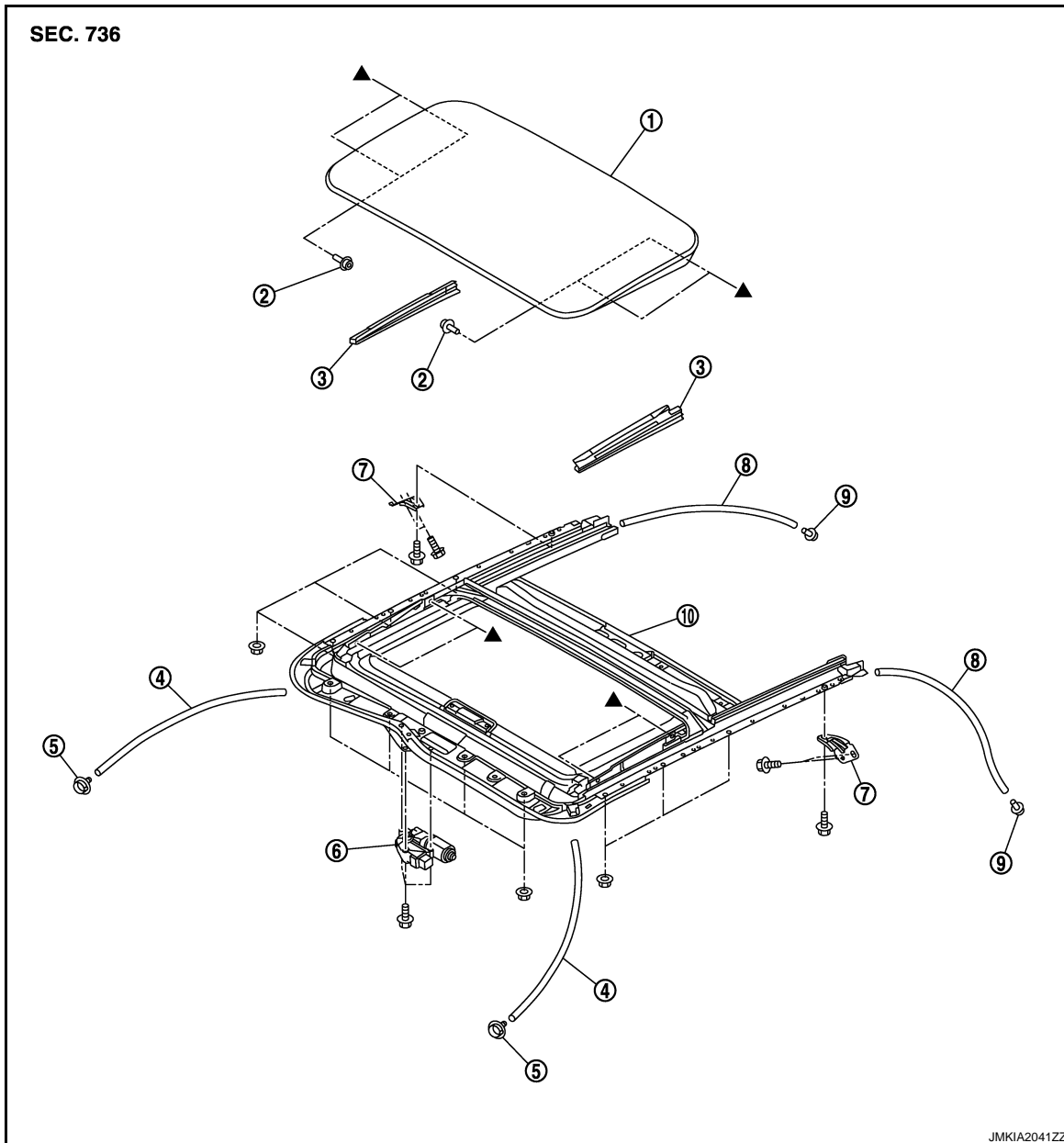

- | | | |
|----------------------------|----------------------------|---------------------------|
| 1. Glass lid | 2. TORX bolt | 3. Inner blind (LH/RH) |
| 4. Drain hose (front) | 5. Drain connector (front) | 6. Sunroof motor assembly |
| 7. Sunroof bracket (LH/RH) | 8. Drain hose (rear) | 9. Drain connector (rear) |
| 10. Sunroof unit assembly | | |

Removal and Installation

INFOID:000000003545368

REMOVAL

CAUTION:

- Before removing sunroof motor, check that glass lid is fully closed.
- After removing sunroof motor, do not attempt to rotate sunroof motor assembly as a single unit.

1. Remove the headlining. Refer to [INT-30. "SUNROOF : Removal and Installation"](#).

A
B
C
D
E
F
G
H
I
J
RF
L
M
N
O
P

SUNROOF MOTOR ASSEMBLY

< ON-VEHICLE REPAIR >

2. Disconnect connector (A) and from sunroof motor assembly (1). Remove sunroof motor assembly mounting bolts (B), and then remove sunroof motor assembly.

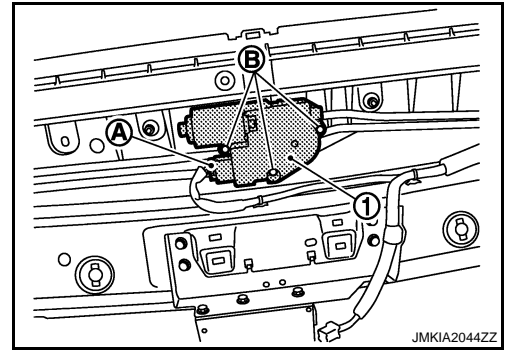

INSTALLATION

CAUTION:

Before installing the sunroof motor assembly, be sure to place the link and wire assembly in the symmetrical and fully closed position.

1. Move the sunroof motor assembly laterally by little so that the gear is completely engaged into the wire on the sunroof unit assembly and mounting surface becomes parallel. Then tighten the sunroof motor assembly with bolts.
2. Install the headlining. Refer to [INT-30, "SUNROOF : Removal and Installation"](#).

SUNROOF UNIT ASSEMBLY

< ON-VEHICLE REPAIR >

SUNROOF UNIT ASSEMBLY

Exploded View

INFOID:000000003545369

REMOVAL

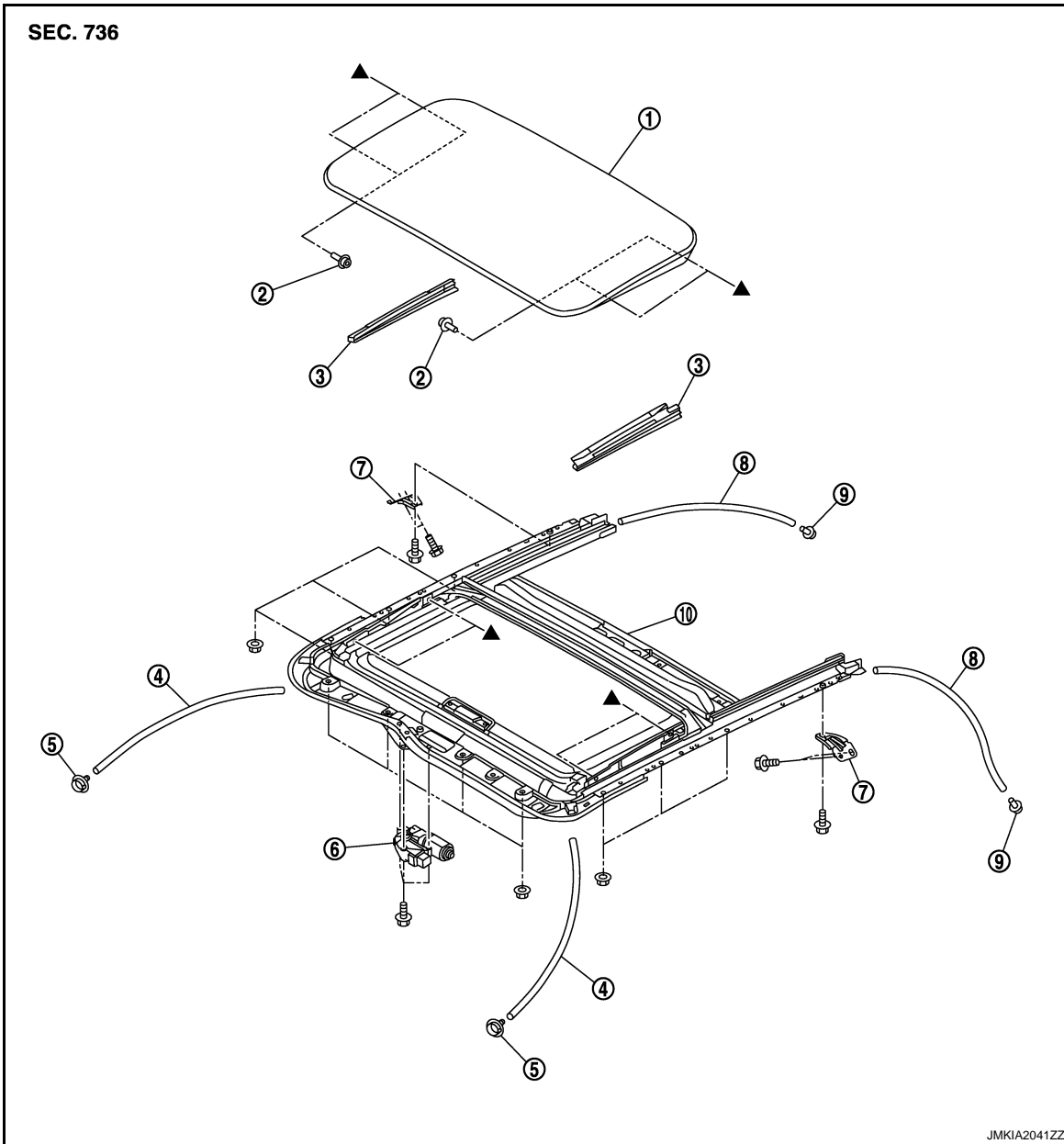

- | | | |
|----------------------------|----------------------------|---------------------------|
| 1. Glass lid | 2. TORX bolt | 3. Inner blind (LH/RH) |
| 4. Drain hose (front) | 5. Drain connector (front) | 6. Sunroof motor assembly |
| 7. Sunroof bracket (LH/RH) | 8. Drain hose (rear) | 9. Drain connector (rear) |
| 10. Sunroof unit assembly | | |

DISASSEMBLY

A
B
C
D
E
F
G
H
I
J
RF
L
M
N
O
P

SUNROOF UNIT ASSEMBLY

< ON-VEHICLE REPAIR >

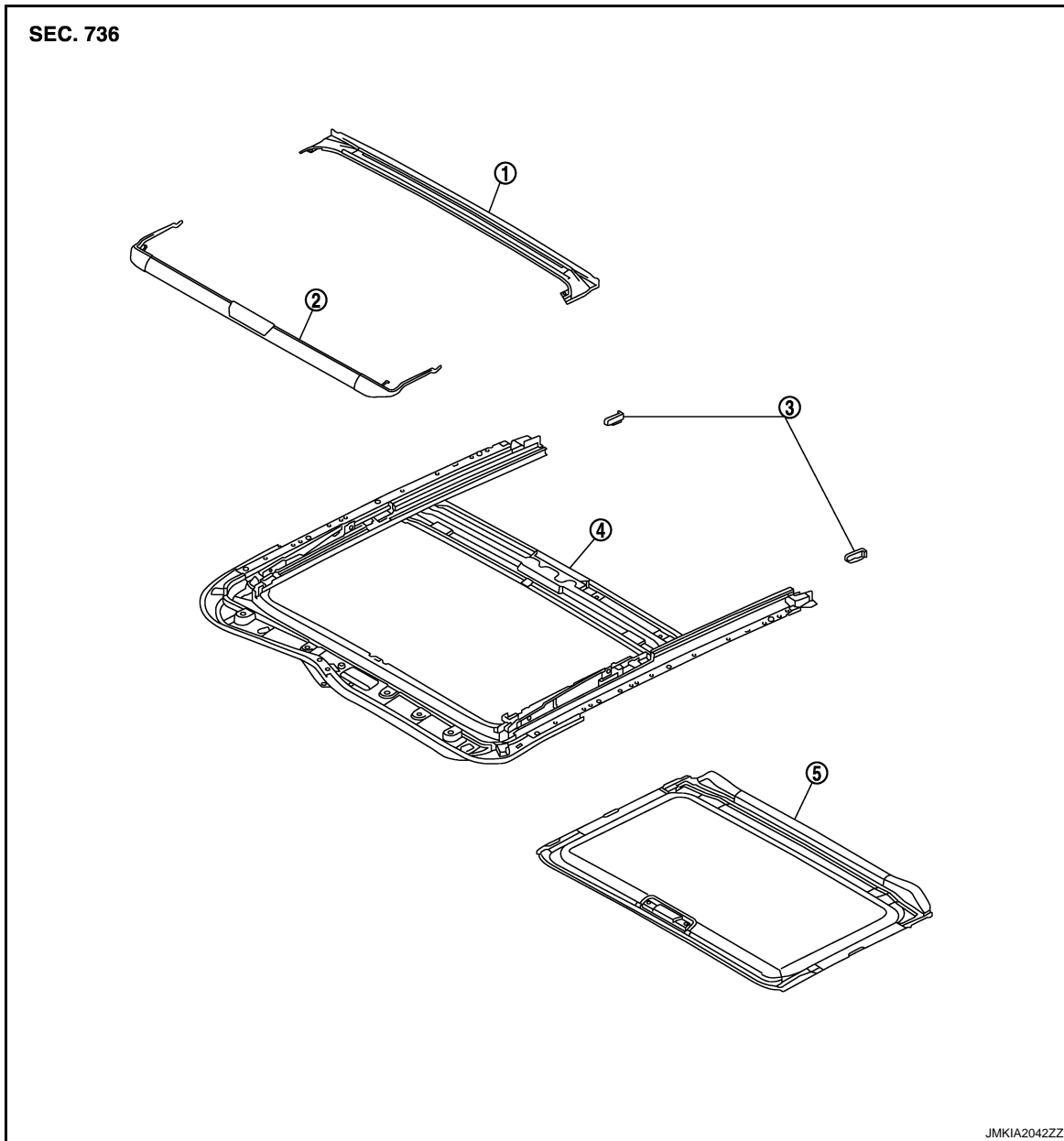

- | | | |
|------------------|-------------------|-----------------------------|
| 1. Rear drain | 2. Wind deflector | 3. Sunshade stopper (LH/RH) |
| 4. Sunroof frame | 5. Sunshade | |

Removal and Installation

INFOID:000000003545370

REMOVAL

CAUTION:

- Always work with a helper.
- Fully close the glass lid, before removal, then do not operate sunroof motor assembly after removal.
- When taking sunroof unit assembly out, use cloths to protect the seats and trim from damage.

1. Remove the headlining. Refer to [INT-30, "SUNROOF : Removal and Installation"](#).
2. Remove the glass lid. Refer to [RF-73, "Removal and Installation"](#).
3. Remove the sunroof motor assembly. Refer to [RF-75, "Removal and Installation"](#).
4. Disconnect drain hoses.
5. Remove the assistance grip brackets.
6. Remove the sunroof brackets (LH/RH).

SUNROOF UNIT ASSEMBLY

< ON-VEHICLE REPAIR >

7. Remove nuts from the front end and side rail, and then remove sunroof unit assembly from roof panel.
8. Remove sunroof unit assembly through the back door while being careful not to damage the seats and trim.

INSTALLATION

CAUTION:

After installing the sunroof unit assembly and glass lid, perform the leak test and check that there is no malfunction.

1. Bring sunroof unit into back door.
2. Temporarily tighten the mounting nuts to the side rail of sunroof unit assembly.
3. Temporarily tighten the mounting nuts to the front end of sunroof unit assembly.
4. Temporarily tighten the mounting bolts to the sunroof brackets (LH/RH)
5. Tighten the installation points diagonally excluding the installation points of the sunroof brackets around the roof opening.
6. Tighten the mounting nuts to the front end and side rail.
7. Tighten the sunroof bracket bolts of the vehicle side, and then tighten the bolt of the rail side.
8. Install the assistance grip bracket.
9. Install the sunroof motor assembly. Refer to [RF-75, "Removal and Installation"](#).
10. Install the glass lid. Refer to [RF-73, "Removal and Installation"](#).

NOTE:

After installation, perform fitting adjustment. Refer to [RF-74, "Adjustment"](#).

11. Connect drain hoses.
12. Install the headlining. Refer to [INT-30, "SUNROOF : Removal and Installation"](#).

Disassembly and Assembly

INFOID:000000003545371

DISASSEMBLY

1. Remove the screw, and then rear drain.
2. Remove sunshade. Refer to [RF-80, "Removal and Installation"](#).

ASSEMBLY

Assemble in the reverse order of disassembly.

A
B
C
D
E
F
G
H
I
J
L
M
N
O
P

RF

SUNSHADE

< ON-VEHICLE REPAIR >

SUNSHADE

Exploded View

INFOID:000000003545372

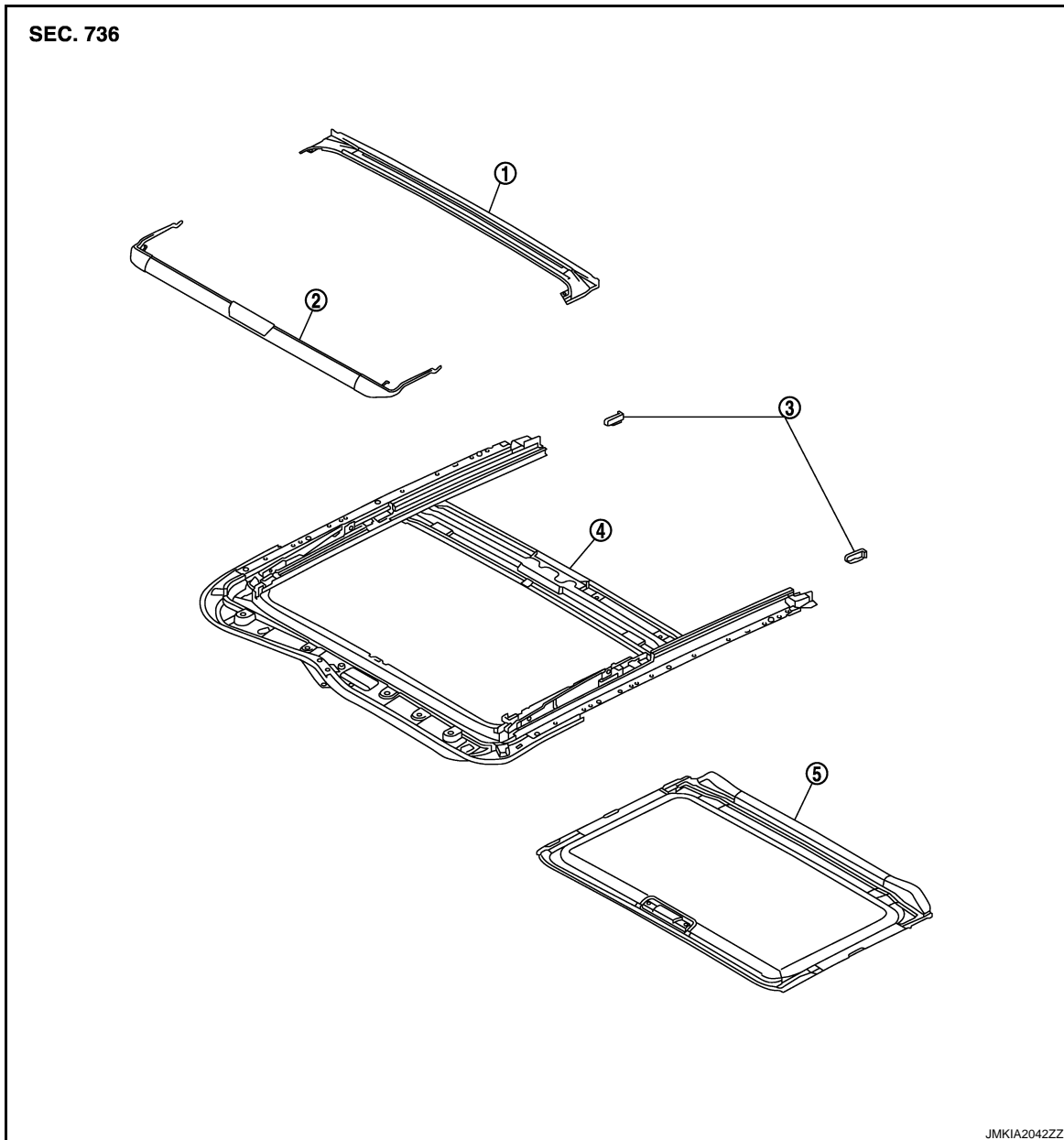

- | | | |
|------------------|-------------------|-----------------------------|
| 1. Rear drain | 2. Wind deflector | 3. Sunshade stopper (LH/RH) |
| 4. Sunroof frame | 5. Sunshade | |

Removal and Installation

INFOID:000000003545373

REMOVAL

1. Remove the headlining. Refer to [INT-30, "SUNROOF : Removal and Installation"](#).

SUNSHADE

< ON-VEHICLE REPAIR >

2. Remove the sunshade stopper (LH/RH) (1) from the sunroof frame end.

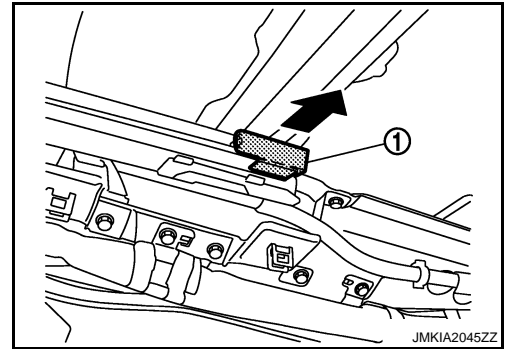

3. Remove the sunshade from the rear end of sunroof frame.

INSTALLATION

Install in the reverse order of removal.

A
B
C
D
E
F
G
H
I
J
RF
L
M
N
O
P

WIND DEFLECTOR

< ON-VEHICLE REPAIR >

WIND DEFLECTOR

Exploded View

INFOID:000000003547906

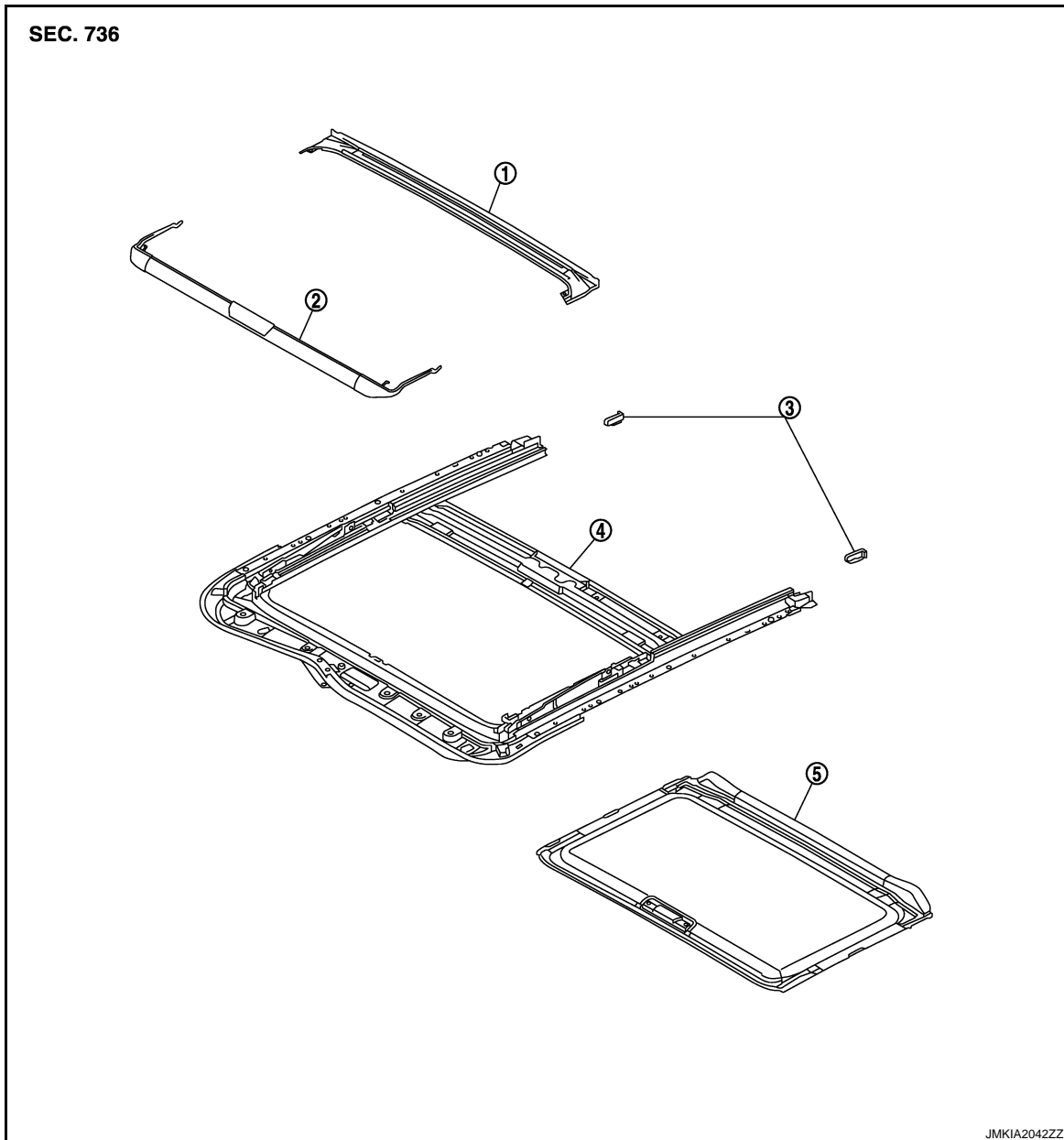

- | | | |
|------------------|-------------------|-----------------------------|
| 1. Rear drain | 2. Wind deflector | 3. Sunshade stopper (LH/RH) |
| 4. Sunroof frame | 5. Sunshade | |

Removal and Installation

INFOID:000000003545375

Removal

1. Open the glass lid to see the wind deflector installation point on the sun roof slide rail.
2. Remove the wind deflector.
 - Remove the spring from sunroof frame groove.
 - Turn the wind deflector and remove it from sunroof frame.

Installation

Install in the reverse order of removal.

SUNROOF SWITCH

< ON-VEHICLE REPAIR >

SUNROOF SWITCH

Exploded View

INFOID:000000003624723

Refer to [JNL-100, "Exploded View"](#).

Removal and Installation

INFOID:000000003624724

Removal

Remove the sunroof switch. Refer to [JNL-100, "Removal and Installation"](#).

Installation

Install in the reverse order of removal.

A

B

C

D

E

F

G

H

I

J

RF

L

M

N

O

P