

# SECTION PCS

## POWER CONTROL SYSTEM

A  
B  
C  
D  
E  
F  
G  
H  
I  
J  
K  
L  
N  
O  
P

### CONTENTS

<p><b>IPDM E/R</b></p> <p><b>FUNCTION DIAGNOSIS</b> ..... 4</p> <p><b>RELAY CONTROL SYSTEM</b> ..... 4</p> <p>    System Diagram .....4</p> <p>    System Description .....4</p> <p>    Component Parts Location .....6</p> <p><b>POWER CONTROL SYSTEM</b> ..... 7</p> <p>    System Diagram .....7</p> <p>    System Description .....7</p> <p>    Component Parts Location .....7</p> <p><b>SIGNAL BUFFER SYSTEM</b> ..... 8</p> <p>    System Diagram .....8</p> <p>    System Description .....8</p> <p>    Component Parts Location .....8</p> <p><b>POWER CONSUMPTION CONTROL SYSTEM</b> ..... 9</p> <p>    System Diagram .....9</p> <p>    System Description .....9</p> <p>    Component Parts Location ..... 10</p> <p><b>DIAGNOSIS SYSTEM (IPDM E/R)</b> .....11</p> <p>    Diagnosis Description ..... 11</p> <p>    CONSULT-III Function (IPDM E/R) ..... 13</p> <p><b>COMPONENT DIAGNOSIS</b> ..... 16</p> <p><b>U1000 CAN COMM CIRCUIT</b> ..... 16</p> <p>    Description ..... 16</p> <p>    DTC Logic ..... 16</p> <p>    Diagnosis Procedure ..... 16</p> <p><b>B2098 IGNITION RELAY ON STUCK</b> .....17</p> <p>    Description ..... 17</p> <p>    DTC Logic ..... 17</p> <p>    Diagnosis Procedure ..... 17</p> <p><b>B2099 IGNITION RELAY OFF STUCK</b> .....18</p>	<p>    Description .....18</p> <p>    DTC Logic .....18</p> <p>    Diagnosis Procedure .....18</p> <p><b>POWER SUPPLY AND GROUND CIRCUIT</b> ....19</p> <p>    Diagnosis Procedure .....19</p> <p><b>ECU DIAGNOSIS</b> .....20</p> <p><b>IPDM E/R (INTELLIGENT POWER DISTRIBUTION MODULE ENGINE ROOM)</b> .....20</p> <p>    Reference Value .....20</p> <p>    Wiring Diagram - IPDM E/R - .....27</p> <p>    Fail-safe .....30</p> <p>    DTC Index .....32</p> <p><b>PRECAUTION</b> .....33</p> <p><b>PRECAUTIONS</b> .....33</p> <p>    Precaution for Procedure without Cowl Top Cover...33</p> <p><b>ON-VEHICLE REPAIR</b> .....34</p> <p><b>IPDM E/R (INTELLIGENT POWER DISTRIBUTION MODULE ENGINE ROOM)</b> .....34</p> <p>    Exploded View .....34</p> <p>    Removal and Installation .....34</p> <p><b>POWER DISTRIBUTION SYSTEM</b></p> <p><b>BASIC INSPECTION</b> .....36</p> <p><b>DIAGNOSIS AND REPAIR WORKFLOW</b> .....36</p> <p>    Work Flow .....36</p> <p><b>FUNCTION DIAGNOSIS</b> .....39</p> <p><b>POWER DISTRIBUTION SYSTEM</b> .....39</p> <p>    System Description .....39</p> <p>    Component Parts Location .....41</p> <p>    Component Description .....41</p> <p><b>DIAGNOSIS SYSTEM (BCM)</b> .....42</p>
---	---

PCS

<b>COMMON ITEM</b> .....	42	Diagnosis Procedure .....	62
COMMON ITEM : CONSULT-III Function (BCM - COMMON ITEM) .....	42	<b>POWER SUPPLY AND GROUND CIRCUIT</b> ....	64
<b>INTELLIGENT KEY</b> .....	43	<b>BCM</b> .....	64
INTELLIGENT KEY : CONSULT-III Function (BCM - INTELLIGENT KEY) .....	43	BCM : Diagnosis Procedure .....	64
<b>COMPONENT DIAGNOSIS</b> .....	47	<b>PUSH-BUTTON IGNITION SWITCH</b> .....	65
<b>U1000 CAN COMM CIRCUIT</b> .....	47	Description .....	65
Description .....	47	Component Function Check .....	65
DTC Logic .....	47	Diagnosis Procedure .....	65
Diagnosis Procedure .....	47	Component Inspection .....	66
<b>U1010 CONTROL UNIT (CAN)</b> .....	48	<b>PUSH-BUTTON IGNITION SWITCH POSI- TION INDICATOR</b> .....	67
DTC Logic .....	48	Description .....	67
Diagnosis Procedure .....	48	Component Function Check .....	67
Special Repair Requirement .....	48	Diagnosis Procedure .....	67
<b>B2553 IGNITION RELAY</b> .....	49	Component Inspection .....	68
Description .....	49	<b>POWER DISTRIBUTION SYSTEM</b> .....	69
DTC Logic .....	49	Wiring Diagram - PDS (POWER DISTRIBUTION SYSTEM) - .....	69
Diagnosis Procedure .....	49	<b>ECU DIAGNOSIS</b> .....	75
<b>B260A IGNITION RELAY</b> .....	51	<b>BCM (BODY CONTROL MODULE)</b> .....	75
Description .....	51	Reference Value .....	75
DTC Logic .....	51	Wiring Diagram - BCM - .....	99
Diagnosis Procedure .....	51	Fail-safe .....	105
<b>B2614 ACC RELAY</b> .....	53	DTC Inspection Priority Chart .....	107
Description .....	53	DTC Index .....	109
DTC Logic .....	53	<b>IPDM E/R (INTELLIGENT POWER DISTRI- BUTION MODULE ENGINE ROOM)</b> .....	111
Diagnosis Procedure .....	53	Reference Value .....	111
Component Inspection .....	54	Wiring Diagram - IPDM E/R - .....	118
<b>B2614 ACC RELAY</b> .....	55	Fail-safe .....	121
Description .....	55	DTC Index .....	123
DTC Logic .....	55	<b>PRECAUTION</b> .....	124
Diagnosis Procedure .....	55	<b>PRECAUTIONS</b> .....	124
Component Inspection .....	56	Precaution for Supplemental Restraint System (SRS) "AIR BAG" and "SEAT BELT PRE-TEN- SIONER" .....	124
<b>B2615 BLOWER RELAY CIRCUIT</b> .....	57	Precaution Necessary for Steering Wheel Rota- tion after Battery Disconnect .....	124
Description .....	57	Precaution for Procedure without Cowl Top Cover. 125	125
DTC Logic .....	57	<b>SYMPTOM DIAGNOSIS</b> .....	126
Diagnosis Procedure .....	57	<b>POWER DISTRIBUTION SYSTEM</b> .....	126
Component Inspection .....	58	Symptom Table .....	126
<b>B2616 IGNITION RELAY CIRCUIT</b> .....	59	<b>PUSH-BUTTON IGNITION SWITCH DOES NOT OPERATE</b> .....	128
Description .....	59	Description .....	128
DTC Logic .....	59	Diagnosis Procedure .....	128
Diagnosis Procedure .....	59	<b>PUSH-BUTTON IGNITION SWITCH POSI- TION INDICATOR DOES NOT ILLUMINATE</b> ..	129
Component Inspection .....	60		
<b>B2618 BCM</b> .....	61		
Description .....	61		
DTC Logic .....	61		
Diagnosis Procedure .....	61		
<b>B261A PUSH-BUTTON IGNITION SWITCH</b> ....	62		
Description .....	62		
DTC Logic .....	62		

Description .....	129	Exploded View .....	130	
Diagnosis Procedure .....	129	Removal and Installation .....	130	A
<b>ON-VEHICLE REPAIR .....</b>	<b>130</b>	<b>PUSH BUTTON IGNITION SWITCH .....</b>	<b>131</b>	
<b>BCM (BODY CONTROL MODULE) .....</b>	<b>130</b>	Removal and Installation .....	131	B

C

D

E

F

G

H

I

J

K

L

PCS

N

O

P

## FUNCTION DIAGNOSIS

### RELAY CONTROL SYSTEM

#### System Diagram

INFOID:000000003131982

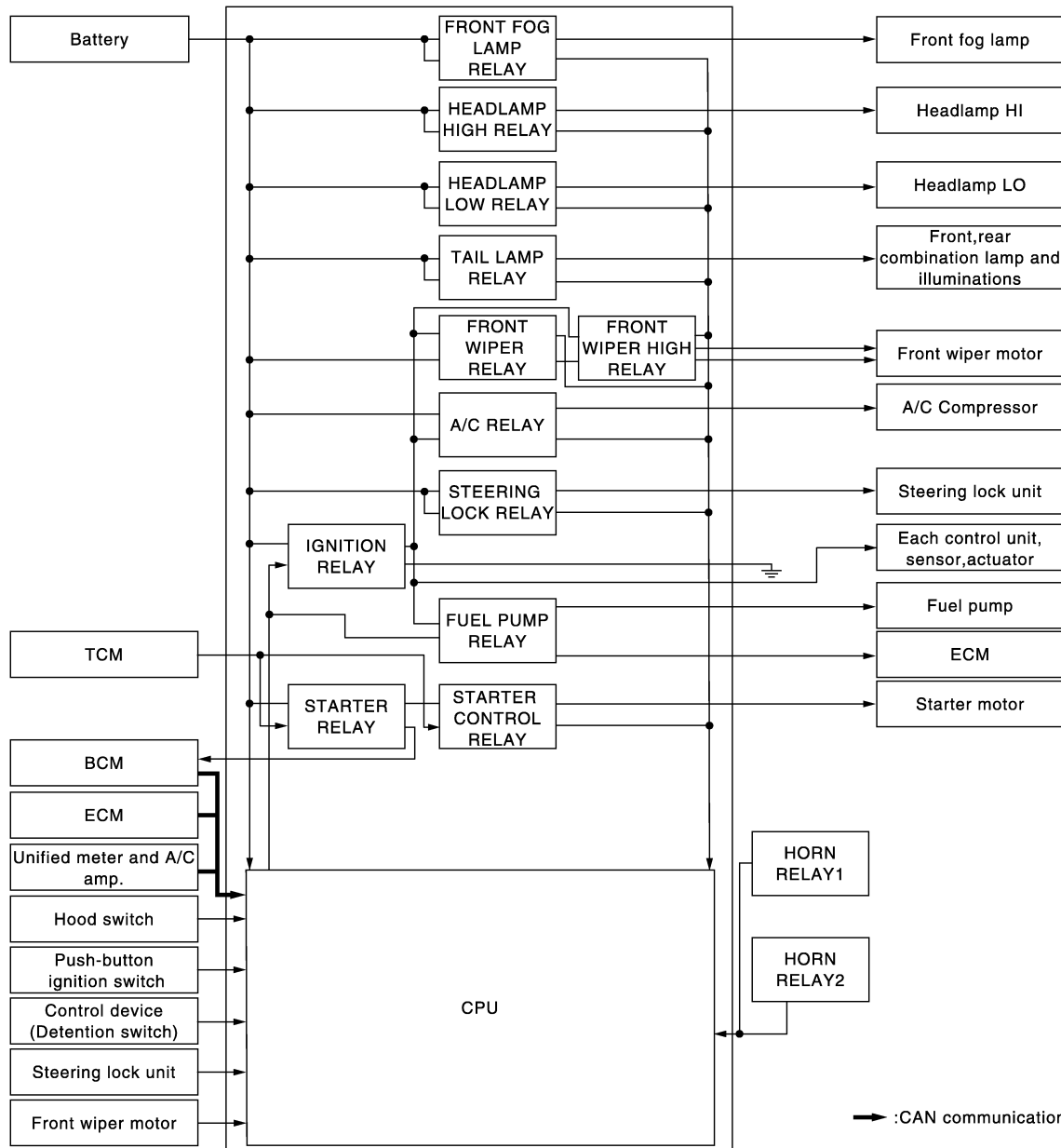

JPMIA0975GB

#### System Description

INFOID:000000003131983

IPDM E/R activates the internal control circuit to perform the relay ON-OFF control according to the input signals from various sensors and the request signals received from control units via CAN communication.

**CAUTION:**

**IPDM E/R integrated relays cannot be removed.**

# RELAY CONTROL SYSTEM

< FUNCTION DIAGNOSIS >

[IPDM E/R]

Control relay	Input/output	Transmit unit	Control part	Reference page	
<ul style="list-style-type: none"> <li>Headlamp low relay</li> <li>Headlamp high relay</li> </ul>	<ul style="list-style-type: none"> <li>Low beam request signal</li> <li>High beam request signal</li> </ul>	BCM (CAN)	<ul style="list-style-type: none"> <li>Headlamp low</li> <li>Headlamp high</li> </ul>	<ul style="list-style-type: none"> <li><a href="#">EXL-11</a> (Xenon headlamp)</li> <li><a href="#">EXL-212</a> (Halogen headlamp)</li> </ul>	A
					B
Front fog lamp relay	Front fog light request signal	BCM (CAN)	Front fog lamp	<ul style="list-style-type: none"> <li><a href="#">EXL-24</a> (Xenon headlamp)</li> <li><a href="#">EXL-212</a> (Halogen headlamp)</li> </ul>	C
Tail lamp relay	Position light request signal	BCM (CAN)	<ul style="list-style-type: none"> <li>Parking lamp</li> <li>Side marker lamp</li> <li>License plate lamp</li> <li>Tail lamp</li> </ul>	<ul style="list-style-type: none"> <li><a href="#">EXL-28</a> (Xenon headlamp)</li> <li><a href="#">EXL-225</a> (Halogen headlamp)</li> </ul>	D
			Illuminations	<a href="#">INL-12</a>	E
<ul style="list-style-type: none"> <li>Front wiper relay</li> <li>Front wiper high relay</li> </ul>	Front wiper request signal	BCM (CAN)	Front wiper	<a href="#">WW-5</a>	F
	Front wiper auto stop signal	Front wiper motor			
<ul style="list-style-type: none"> <li>Horn relay 1</li> <li>Horn relay 2</li> </ul>	<ul style="list-style-type: none"> <li>Theft warning horn request signal</li> <li>Horn reminder signal</li> </ul>	BCM (CAN)	<ul style="list-style-type: none"> <li>Horn (low)</li> <li>Horn (high)</li> </ul>	<a href="#">SEC-20</a>	G
Steering lock unit condition signal	Steering lock unit				
Starter relay control signal	TCM				
Steering lock relay	Steering lock relay signal	BCM (CAN)	Steering lock unit	<a href="#">SEC-97</a>	I
	Steering lock unit condition signal	Steering lock unit			
	Control device (Detention switch) signal	Control device (Detention switch)			
A/C relay	A/C compressor request signal	ECM (CAN)	A/C compressor (magnet clutch)	<a href="#">HAC-55</a>	J
Ignition relay	Ignition switch ON signal	BCM (CAN)	Ignition relay	<a href="#">PCS-17</a>	K
	Vehicle speed signal	Unified meter and A/C amp. (CAN)			
	Push-button ignition switch signal	Push-button ignition switch			

**NOTE:**

BCM controls the starter relay.

PCS

N

O

P

# RELAY CONTROL SYSTEM

< FUNCTION DIAGNOSIS >

[IPDM E/R]

## Component Parts Location

INFOID:000000003131984

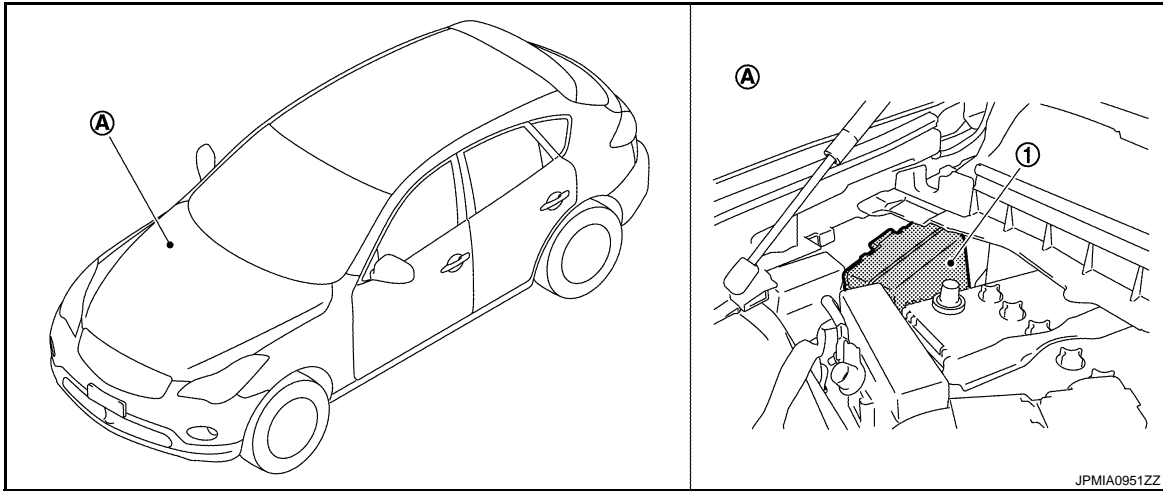

- 1. IPDM E/R
- A. Engine room dash panel (RH)

## POWER CONTROL SYSTEM

### System Diagram

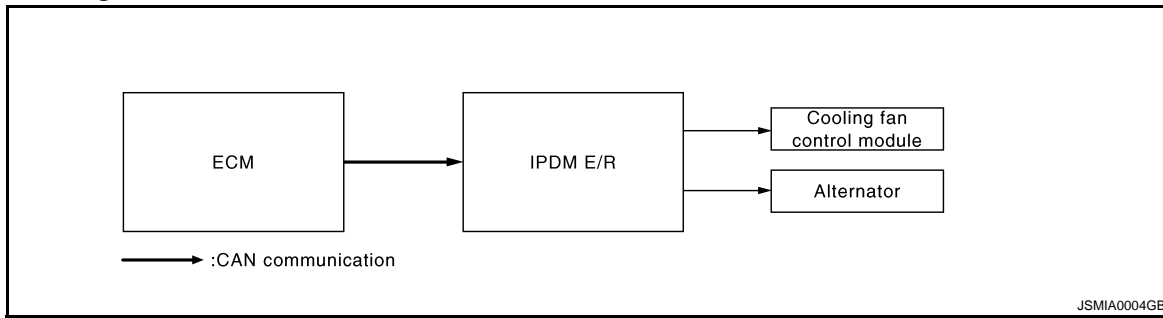

### System Description

INFOID:000000003131986

#### COOLING FAN CONTROL

IPDM E/R outputs pulse duty signal (PWM signal) to the cooling fan control module according to the status of the cooling fan speed request signal received from ECM via CAN communication. Refer to [EC-66, "System Diagram"](#).

#### ALTERNATOR CONTROL

IPDM E/R outputs power generation command signal (PWM signal) to the alternator according to the status of the power generation command value signal received from ECM via CAN communication. Refer to [CHG-8, "System Diagram"](#).

### Component Parts Location

INFOID:000000003673975

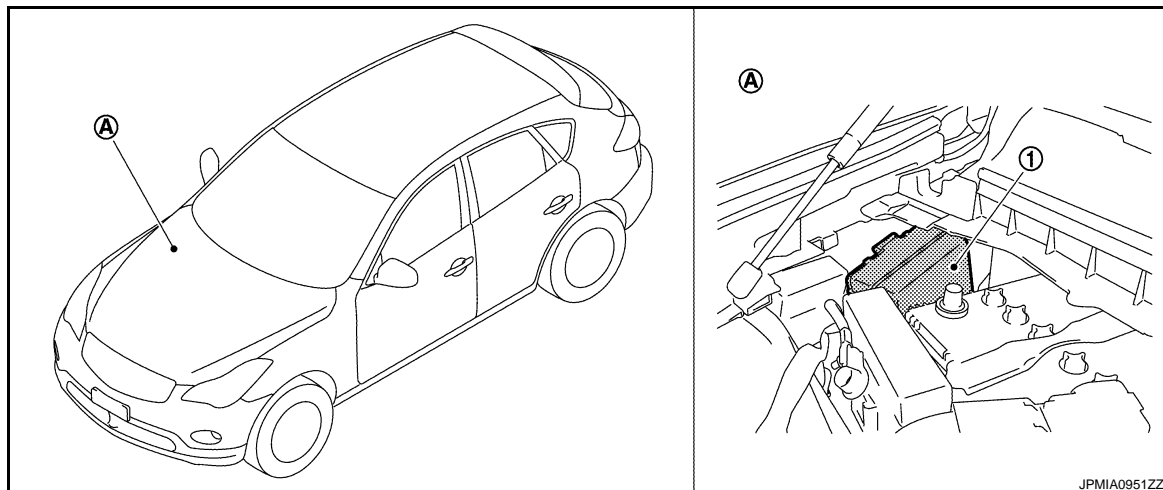

- 1. IPDM E/R
- A. Engine room dash panel (RH)

# SIGNAL BUFFER SYSTEM

< FUNCTION DIAGNOSIS >

[IPDM E/R]

## SIGNAL BUFFER SYSTEM

### System Diagram

INFOID:000000003131988

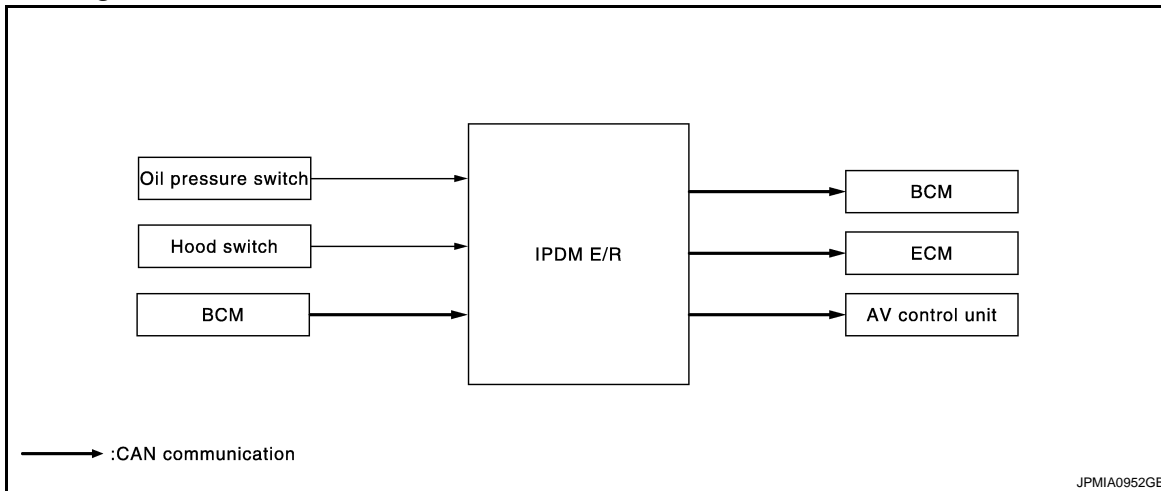

### System Description

INFOID:000000003131989

- IPDM E/R reads the status of the oil pressure switch and transmits the oil pressure switch signal to BCM via CAN communication. Refer to [MWI-24, "WARNING LAMPS/INDICATOR LAMPS : System Diagram"](#).
- IPDM E/R reads the status of the hood switch and transmits the hood switch signal to BCM via CAN communication. Refer to [SEC-114, "Description"](#).
- IPDM E/R receives the rear window defogger control signal from BCM via CAN communication and transmits it to ECM and AV control unit via CAN communication. Refer to [DEF-4, "System Diagram"](#).

### Component Parts Location

INFOID:000000003674193

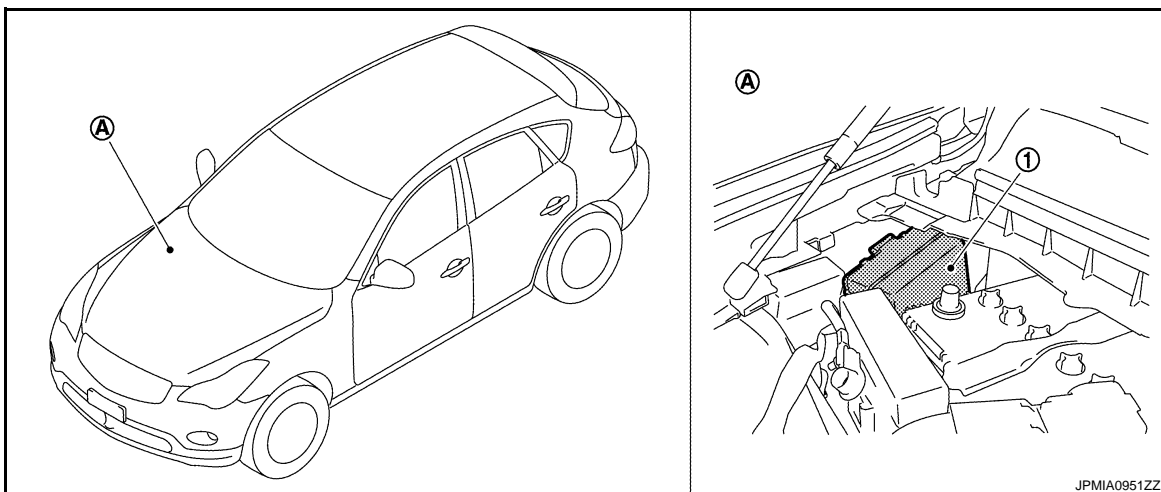

1. IPDM E/R
- A. Engine room dash panel (RH)



POWER CONSUMPTION CONTROL SYSTEM

System Diagram

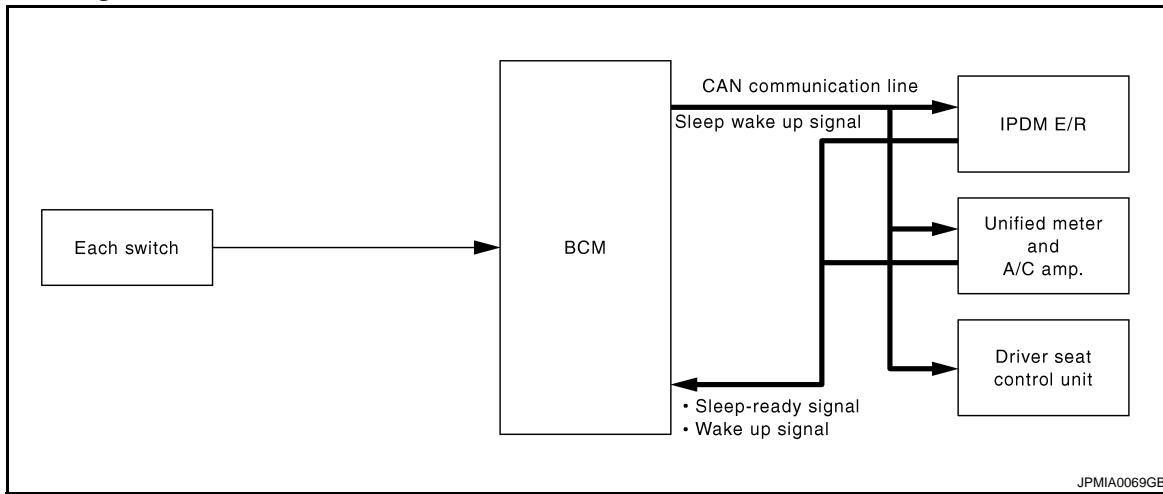

System Description

INFOID:000000003131992

OUTLINE

- IPDM E/R incorporates a power consumption control function that reduces the power consumption according to the vehicle status.
- IPDM E/R changes its status (control mode) with the sleep wake up signal received from BCM via CAN communication.

Normal mode (wake-up)

- CAN communication is normally performed with other control units.
- Individual unit control by IPDM E/R is normally performed.

Low power consumption mode (sleep)

- Low power consumption control is active.
- CAN transmission is stopped.

SLEEP MODE ACTIVATION

- IPDM E/R judges that the sleep-ready conditions are fulfilled when the ignition switch is OFF and none of the conditions below are present. Then it transmits a sleep-ready signal (ready) to BCM via CAN communication.
  - Outputting signals to actuators
  - Switches or relays operating
  - Hood switch status is kept 50 ms or less.
  - Output requests are being received from control units via CAN communication.
- IPDM E/R stops CAN communication and enters the low power consumption mode when it receives a sleep wake up signal (sleep) from BCM and the sleep-ready conditions are fulfilled.

WAKE-UP OPERATION

- IPDM E/R changes from the low power consumption mode to the normal mode when it receives a sleep wake-up signal (wake up) from BCM or any of the following conditions is fulfilled. In addition, it transmits a sleep-ready signal (not-ready) to BCM via CAN communication to report the CAN communication start.
  - Ignition switch ON
  - The hood switch status changes.
  - An output request is received from a control unit via CAN communication.

A  
B  
C  
D  
E  
F  
G  
H  
I  
J  
K  
L  
N  
O  
P

PCS

# POWER CONSUMPTION CONTROL SYSTEM

< FUNCTION DIAGNOSIS >

[IPDM E/R]

## Component Parts Location

INFOID:000000003674195

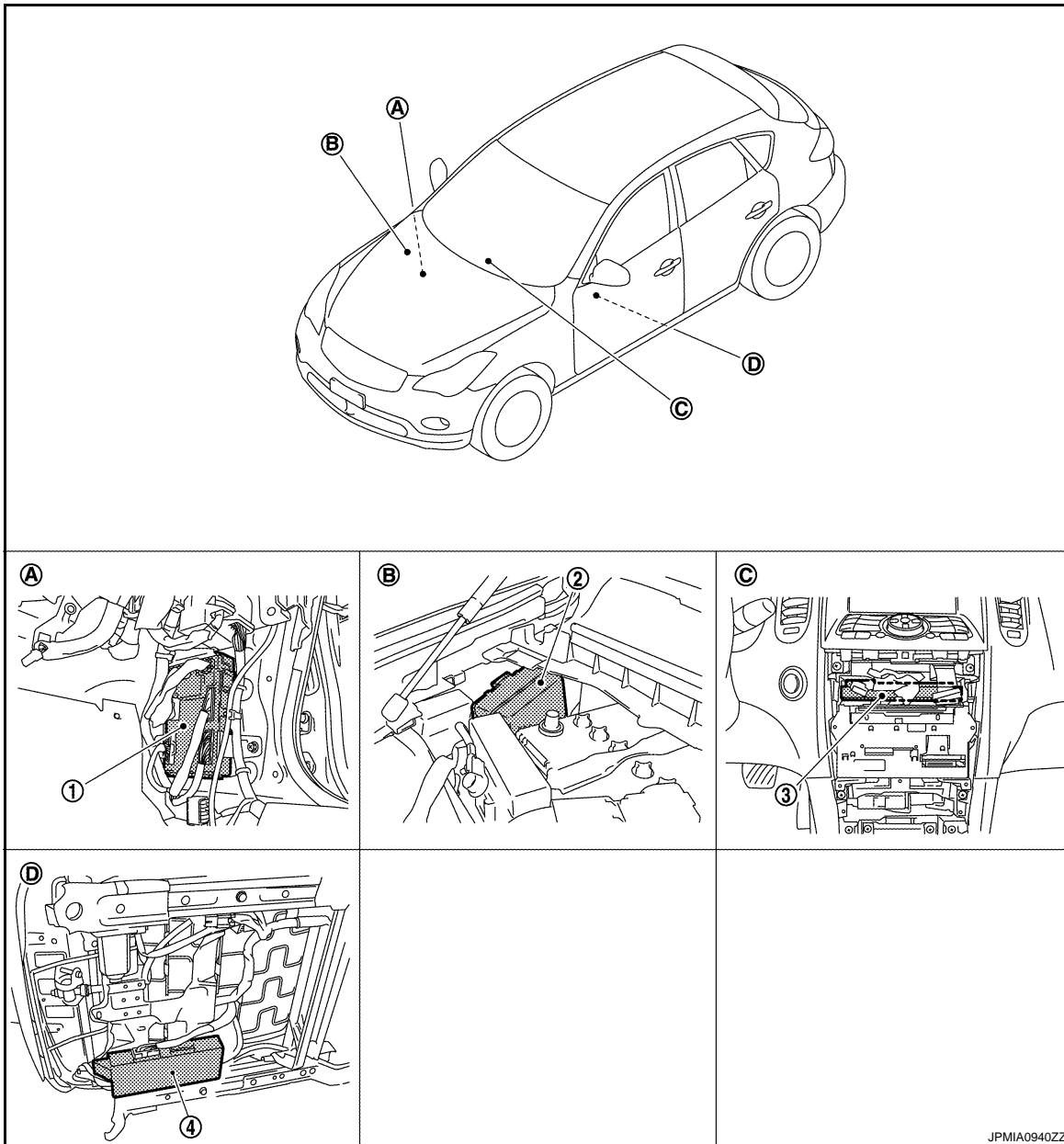

JPMIA0940ZZ

- |   |                                |                               |
|---|--------------------------------|-------------------------------|
| 1. BCM  | 2. IPDM E/R                    | 3. Unified meter and A/C amp. |
| 4. Driver seat control unit                   |                                |                               |
| A. Dash side lower (passenger side)           | B. Engine room dash panel (RH) | C. Behind cluster lid C       |
| D. Backside of the seat cushion (driver seat) |                                |                               |

## DIAGNOSIS SYSTEM (IPDM E/R)

### Diagnosis Description

INFOID:000000003131994

#### AUTO ACTIVE TEST

##### Description

In auto active test mode, the IPDM E/R sends a drive signal to the following systems to check their operation.

- Oil pressure warning lamp
- Front wiper (LO, HI)
- Parking lamps
- License plate lamps
- Side marker lamps
- Tail lamps
- Front fog lamps
- Headlamps (LO, HI)
- A/C compressor (magnet clutch)
- Cooling fan (cooling fan control module)

##### Operation Procedure

1. Close the hood and lift the wiper arms from the windshield. (Prevent windshield damage due to wiper operation)  
**NOTE:**  
 When auto active test is performed with hood opened, sprinkle water on windshield beforehand.
2. Turn ignition switch OFF.
3. Turn the ignition switch ON, and within 20 seconds, press the driver door switch 10 times. Then turn the ignition switch OFF.  
**CAUTION:**  
**Close passenger door.**
4. Turn the ignition switch ON within 10 seconds. After that the horn sounds once and the auto active test starts.
5. The oil pressure warning lamp starts blinking when the auto active test starts.
6. After a series of the following operations is repeated 3 times, auto active test is completed.

##### NOTE:

When auto active test mode has to be cancelled halfway through test, turn ignition switch OFF.

##### CAUTION:

- If auto active test mode cannot be actuated, check door switch system. Refer to [DLK-63, "Component Function Check"](#).
- Do not start the engine.

##### Inspection in Auto Active Test Mode

When auto active test mode is actuated, the following 5 steps are repeated 3 times.

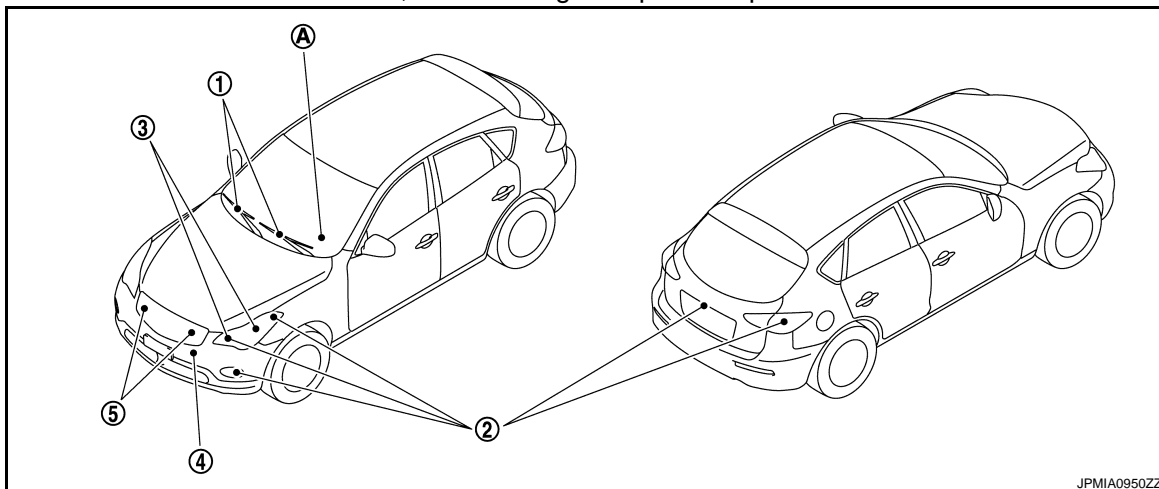

JPMIA0950ZZ

A  
B  
C  
D  
E  
F  
G  
H  
I  
J  
K  
L

PCS

N  
O  
P

# DIAGNOSIS SYSTEM (IPDM E/R)

< FUNCTION DIAGNOSIS >

[IPDM E/R]

Operation sequence	Inspection location	Operation
A	Oil pressure warning lamp	Blinks continuously during operation of auto active test
1	Front wiper	LO for 5 seconds → HI for 5 seconds
2	<ul style="list-style-type: none"> <li>• Parking lamps</li> <li>• License plate lamps</li> <li>• Side maker lamps</li> <li>• Tail lamps</li> <li>• Front fog lamps</li> </ul>	10 seconds
3	Headlamps	<ul style="list-style-type: none"> <li>• LO 10 seconds</li> <li>• HI ON ↔ OFF 5 times</li> </ul>
4	A/C compressor (magnet clutch)	ON ↔ OFF 5 times
5*	Cooling fan	MID for 5 seconds → HI for 5 seconds

\*: Outputs duty ratio of 50% for 5 seconds → duty ratio of 100% for 5 seconds on the cooling fan control module.

### Concept of auto active test

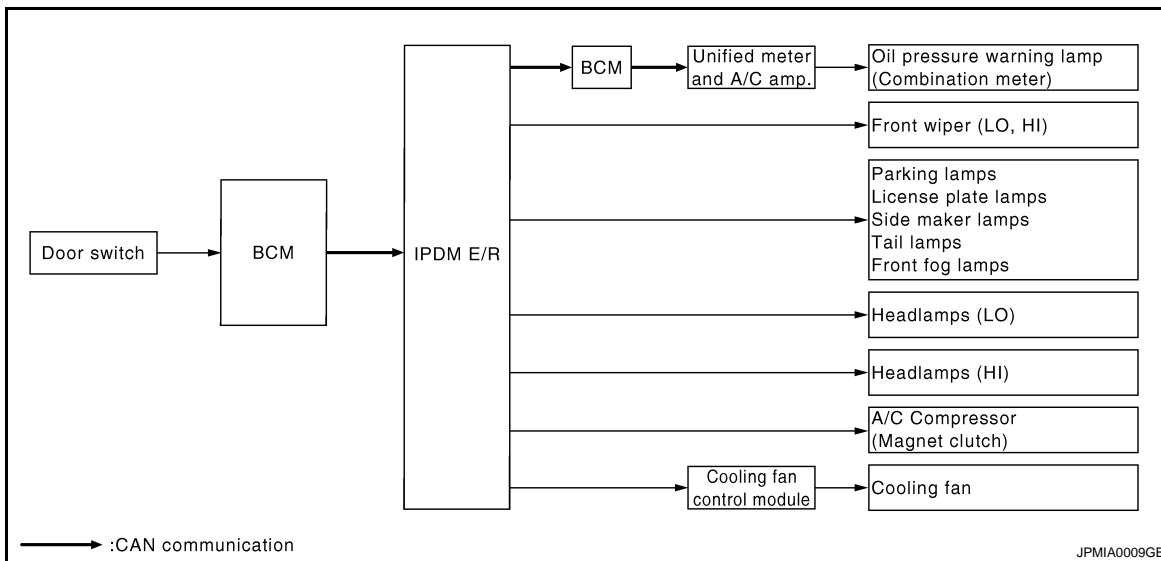

- IPDM E/R starts the auto active test with the door switch signals transmitted by BCM via CAN communication. Therefore, the CAN communication line between IPDM E/R and BCM is considered normal if the auto active test starts successfully.
- The auto active test facilitates troubleshooting if any systems controlled by IPDM E/R cannot be operated.

### Diagnosis chart in auto active test mode

Symptom	Inspection contents		Possible cause
Any of the following components do not operate <ul style="list-style-type: none"> <li>• Parking lamps</li> <li>• License plate lamps</li> <li>• Side maker lamps</li> <li>• Tail lamps</li> <li>• Front fog lamps</li> <li>• Headlamp (HI, LO)</li> <li>• Front wiper</li> </ul>	Perform auto active test. Does the applicable system operate?	YES	BCM signal input circuit
		NO	<ul style="list-style-type: none"> <li>• Lamp or motor</li> <li>• Lamp or motor ground circuit</li> <li>• Harness or connector between IPDM E/R and applicable system</li> <li>• IPDM E/R</li> </ul>

# DIAGNOSIS SYSTEM (IPDM E/R)

< FUNCTION DIAGNOSIS >

[IPDM E/R]

Symptom	Inspection contents		Possible cause
A/C compressor does not operate	Perform auto active test. Does the magnet clutch operate?	YES	<ul style="list-style-type: none"> <li>• Unified meter and A/C amp. signal input circuit</li> <li>• CAN communication signal between unified meter and A/C amp. and ECM</li> <li>• CAN communication signal between ECM and IPDM E/R</li> </ul>
		NO	<ul style="list-style-type: none"> <li>• Magnet clutch</li> <li>• Harness or connector between IPDM E/R and magnet clutch</li> <li>• IPDM E/R</li> </ul>
Oil pressure warning lamp does not operate	Perform auto active test. Does the oil pressure warning lamp blink?	YES	<ul style="list-style-type: none"> <li>• Harness or connector between IPDM E/R and oil pressure switch</li> <li>• Oil pressure switch</li> <li>• IPDM E/R</li> </ul>
		NO	<ul style="list-style-type: none"> <li>• CAN communication signal between IPDM E/R and BCM</li> <li>• CAN communication signal between BCM and unified meter and A/C amp.</li> <li>• Combination meter</li> </ul>
Cooling fan does not operate	Perform auto active test. Does the cooling fan operate?	YES	<ul style="list-style-type: none"> <li>• ECM signal input circuit</li> <li>• CAN communication signal between ECM and IPDM E/R</li> </ul>
		NO	<ul style="list-style-type: none"> <li>• Cooling fan</li> <li>• Harness or connector between cooling fan and cooling fan control module</li> <li>• Cooling fan control module</li> <li>• Harness or connector between IPDM E/R and cooling fan control module</li> <li>• Cooling fan relay</li> <li>• Harness or connector between IPDM E/R and cooling fan relay</li> <li>• IPDM E/R</li> </ul>

A  
B  
C  
D  
E  
F  
G  
H  
I  
J  
K  
L

## CONSULT-III Function (IPDM E/R)

INFOID:000000003131995

PCS

### APPLICATION ITEM

CONSULT-III performs the following functions via CAN communication with IPDM E/R.

Diagnosis mode	Description
Ecu Identification	Allows confirmation of IPDM E/R part number.
Self Diagnostic Result	Displays the diagnosis results judged by IPDM E/R.
Data Monitor	Displays the real-time input/output data from IPDM E/R input/output data.
Active Test	IPDM E/R can provide a drive signal to electronic components to check their operations.
CAN Diag Support Monitor	The results of transmit/receive diagnosis of CAN communication can be read.

N  
O  
P

### SELF DIAGNOSTIC RESULT

Refer to [PCS-32. "DTC Index"](#).

### DATA MONITOR

# DIAGNOSIS SYSTEM (IPDM E/R)

< FUNCTION DIAGNOSIS >

[IPDM E/R]

Monitor item

Monitor Item [Unit]	MAIN SIG- NALS	Description
RAD FAN REQ [%]	×	Displays the value of the cooling fan speed signal received from ECM via CAN communication.
AC COMP REQ [Off/On]	×	Displays the status of the A/C compressor request signal received from ECM via CAN communication.
TAIL&CLR REQ [Off/On]	×	Displays the status of the position light request signal received from BCM via CAN communication.
HL LO REQ [Off/On]	×	Displays the status of the low beam request signal received from BCM via CAN communication.
HL HI REQ [Off/On]	×	Displays the status of the high beam request signal received from BCM via CAN communication.
FR FOG REQ [Off/On]	×	Displays the status of the front fog light request signal received from BCM via CAN communication.
FR WIP REQ [Stop/1LOW/Low/Hi]	×	Displays the status of the front wiper request signal received from BCM via CAN communication.
WIP AUTO STOP [STOP P/ACT P]	×	Displays the status of the front wiper auto stop signal judged by IPDM E/R.
WIP PROT [Off/BLOCK]	×	Displays the status of the front wiper fail-safe operation judged by IPDM E/R.
IGN RLY1 -REQ [Off/On]		Displays the status of the ignition switch ON signal received from BCM via CAN communication.
IGN RLY [Off/On]	×	Displays the status of the ignition relay judged by IPDM E/R.
PUSH SW [Off/On]		Displays the status of the push-button ignition switch judged by IPDM E/R.
INTER/NP SW [Off/On]		Displays the status of the shift position judged by IPDM E/R.
ST RLY CONT [Off/On]		Displays the status of the starter relay status signal received from BCM via CAN communication.
IHBT RLY -REQ [Off/On]		Displays the status of the starter control relay signal received from BCM via CAN communication.
ST/INH RLY [Off/ ST /INH/UNKWN]		Displays the status of the starter relay and starter control relay judged by IPDM E/R.
DETENT SW [Off/On]		Displays the status of the control device (detention switch) judged by IPDM E/R.
S/L RLY -REQ [Off/On]		Displays the status of the steering lock relay request received from BCM via CAN communication.
S/L STATE [LOCK/UNLOCK/UNKWN]		Displays the status of the steering lock judged by IPDM E/R.
DTRL REQ [Off]		<b>NOTE:</b> The item is indicated, but not monitored.
OIL P SW [Open/Close]		Displays the status of the oil pressure switch judged by IPDM E/R.
HOOD SW [Off/On]		Displays the status of the hood switch judged by IPDM E/R.
HL WASHER REQ [Off]		<b>NOTE:</b> The item is indicated, but not monitored.
THFT HRN REQ [Off/On]		Displays the status of the theft warning horn request signal received from BCM via CAN communication.

# DIAGNOSIS SYSTEM (IPDM E/R)

< FUNCTION DIAGNOSIS >

[IPDM E/R]

Monitor Item [Unit]	MAIN SIG- NALS	Description
HORN CHIRP [Off/On]		Displays the status of the horn reminder signal received from BCM via CAN communication.
CRNRNG LMP REQ [Off]		<b>NOTE:</b> The item is indicated, but not monitored.

## ACTIVE TEST

Test item

Test item	Operation	Description
CORNERING LAMP	Off	<b>NOTE:</b> The item is indicated, but cannot be tested.
	LH	
	RH	
HORN	On	Operates horn relay 1 and horn relay 2 for 20 ms.
FRONT WIPER	Off	OFF
	Lo	Operates the front wiper relay.
	Hi	Operates the front wiper relay and front wiper high relay.
MOTOR FAN	1	OFF
	2	Outputs 50% pulse duty signal (PWM signal) to the cooling fan control module.
	3	Outputs 80% pulse duty signal (PWM signal) to the cooling fan control module.
	4	Outputs 100% pulse duty signal (PWM signal) to the cooling fan control module.
HEAD LAMP WASHER	On	<b>NOTE:</b> The item is indicated, but cannot be tested.
EXTERNAL LAMPS	Off	OFF
	TAIL	Operates the tail lamp relay.
	Lo	Operates the headlamp low relay.
	Hi	Operates the headlamp low relay and ON/OFF the headlamp high relay at 1 second intervals.
	Fog	Operates the front fog lamp relay.

A  
B  
C  
D  
E  
F  
G  
H  
I  
J  
K  
L  
N  
O  
P

PCS

## COMPONENT DIAGNOSIS

### U1000 CAN COMM CIRCUIT

#### Description

INFOID:000000003131996

CAN (Controller Area Network) is a serial communication line for real time applications. It is an on-vehicle multiplex communication line with high data communication speed and excellent error detection ability. Modern vehicle is equipped with many electronic control unit, and each control unit shares information and links with other control units during operation (not independent). In CAN communication, control units are connected with 2 communication lines (CAN-H line, CAN-L line) allowing a high rate of information transmission with less wiring. Each control unit transmits/receives data but selectively reads required data only.  
 CAN Communication Signal Chart. Refer to [LAN-27, "CAN Communication Signal Chart"](#).

#### DTC Logic

INFOID:000000003131997

#### DTC DETECTION LOGIC

DTC	CONSULT-III display description	DTC Detection Condition	Possible cause
U1000	CAN COMM CIRCUIT	When IPDM E/R cannot communicate CAN communication signal continuously for 2 seconds or more	CAN communication system

#### DTC CONFIRMATION PROCEDURE

#### Diagnosis Procedure

INFOID:000000003131998

#### 1. PERFORM SELF DIAGNOSTIC

1. Turn ignition switch ON and wait for 2 seconds or more.
2. Check "Self Diagnostic Result" of IPDM E/R.

Is "CAN COMM CIRCUIT" displayed?

- YES >> Refer to [LAN-18, "Trouble Diagnosis Flow Chart"](#).  
 NO >> Refer to [GI-38, "Intermittent Incident"](#).



# B2098 IGNITION RELAY ON STUCK

< COMPONENT DIAGNOSIS >

[IPDM E/R]

## B2098 IGNITION RELAY ON STUCK

### Description

INFOID:000000003131999

- IPDM E/R operates the ignition relay when it receives an ignition switch ON signal from BCM via CAN communication.
- Turn the ignition relay OFF by pressing the push-button ignition switch once when the vehicle speed is 4 km/h (2.5 MPH) or less.
- Turn the ignition relay OFF with the following operation when the vehicle speed is more than 4 km/h (2.5 MPH) or when an abnormal condition occurs in CAN communication from the unified meter and A/C amp.(Emergency OFF)
  - Press and hold the push-button ignition switch for 2 seconds or more.
  - Press the push-button ignition switch 3 times within 1.5 seconds.

#### NOTE:

The ignition relay does not turn ON for 3 seconds after emergency OFF even if the push-button ignition switch is pressed.

### DTC Logic

INFOID:000000003132000

#### DTC DETECTION LOGIC

DTC	CONSULT-III display description	DTC Detection Condition	Possible causes
B2098	IGN RELAY ON	The ignition relay ON is detected for 1 second at ignition switch OFF (CPU monitors the status at the contact and excitation coil circuits of the ignition relay inside it)	Ignition relay malfunction

### Diagnosis Procedure

INFOID:000000003132001

#### 1.PERFORM SELF DIAGNOSIS

1. Turn the ignition switch ON.
2. Erase "Self Diagnostic Result" of IPDM E/R.
3. Turn ignition switch OFF, and wait for 1 second or more.
4. Turn the ignition switch ON. Check "Self Diagnostic Result" again.

Is "IGN RELAY ON" displayed?

- YES >> Replace IPDM E/R.  
 NO >> Refer to [GI-38, "Intermittent Incident"](#).

A  
B  
C  
D  
E  
F  
G  
H  
I  
J  
K  
L  
N  
O  
P

PCS

# B2099 IGNITION RELAY OFF STUCK

< COMPONENT DIAGNOSIS >

[IPDM E/R]

## B2099 IGNITION RELAY OFF STUCK

### Description

INFOID:000000003132002

- IPDM E/R operates the ignition relay when it receives an ignition switch ON signal from BCM via CAN communication.
- Turn the ignition relay OFF by pressing the push-button ignition switch once when the vehicle speed is 4 km/h (2.5 MPH) or less.
- Turn the ignition relay OFF with the following operation when the vehicle speed is more than 4 km/h (2.5 MPH) or when an abnormal condition occurs in CAN communication from the unified meter and A/C amp.(Emergency OFF)
  - Press and hold the push-button ignition switch for 2 seconds or more.
  - Press the push-button ignition switch 3 times within 1.5 seconds.

#### NOTE:

The ignition relay does not turn ON for 3 seconds after emergency OFF even if the push-button ignition switch is pressed.

### DTC Logic

INFOID:000000003132003

#### DTC DETECTION LOGIC

DTC	CONSULT-III display description	DTC Detection Condition	Possible causes
B2099	IGN RELAY OFF	The ignition relay OFF is detected for 1 second at ignition switch ON (CPU monitors the status at the contact and excitation coil circuits of the ignition relay inside it)	Ignition relay malfunction

#### NOTE:

When IPDM E/R power supply voltage is low (Approx. 7 - 8 V for about 1 second), the "DTC: B2099" may be detected.

### Diagnosis Procedure

INFOID:000000003132004

#### 1. PERFORM SELF DIAGNOSIS

1. Turn the ignition switch ON.
2. Erase "Self Diagnostic Result".
3. Turn ignition switch OFF.
4. Turn the ignition switch ON. Check "Self Diagnostic Result" again.

Is "IGN RELAY OFF" displayed?

- YES >> Replace IPDM E/R.  
NO >> Refer to [GI-38, "Intermittent Incident"](#).

# POWER SUPPLY AND GROUND CIRCUIT

< COMPONENT DIAGNOSIS >

[IPDM E/R]

## POWER SUPPLY AND GROUND CIRCUIT

### Diagnosis Procedure

INFOID:000000003132005

#### 1. CHECK FUSES AND FUSIBLE LINK

Check that the following IPDM E/R fuses or fusible links are not blown.

Signal name	Fuses and fusible link No.
Battery power supply	C
	50
	51

#### Is the fuse fusing?

YES >> Replace the blown fuse or fusible link after repairing the affected circuit if a fuse or fusible link is blown.

NO >> GO TO 2.

#### 2. CHECK POWER SUPPLY CIRCUIT

1. Turn ignition switch OFF.
2. Disconnect IPDM E/R connector.
3. Check voltage between IPDM E/R harness connector and ground.

Terminals		Voltage (Approx.)
(+)	(-)	
IPDM E/R		Battery voltage
Connector	Terminal	
E4	1	

#### Is the measurement value normal?

YES >> GO TO 3.

NO >> Repair harness or connector.

#### 3. CHECK GROUND CIRCUIT

Check continuity between IPDM E/R harness connectors and ground.

IPDM E/R		Ground	Continuity
Connector	Terminal		
E5	12		Existed
E6	41		

#### Does continuity exist?

YES >> INSPECTION END

NO >> Repair harness or connector.

A  
B  
C  
D  
E  
F  
G  
H  
I  
J  
K  
L  
N  
O  
P

PCS

# IPDM E/R (INTELLIGENT POWER DISTRIBUTION MODULE ENGINE ROOM)

< ECU DIAGNOSIS >

[IPDM E/R]

## ECU DIAGNOSIS

### IPDM E/R (INTELLIGENT POWER DISTRIBUTION MODULE ENGINE ROOM)

Reference Value

INFOID:000000003132006

#### VALUES ON THE DIAGNOSIS TOOL

Monitor Item	Condition		Value/Status
RAD FAN REQ	Engine idle speed	Changes depending on engine coolant temperature, air conditioner operation status, vehicle speed, etc.	0 – 100 %
AC COMP REQ	Engine running	A/C switch OFF	Off
		A/C switch ON (Compressor is operating)	On
TAIL&CLR REQ	Lighting switch OFF		Off
	Lighting switch 1ST, 2ND, HI or AUTO (Light is illuminated)		On
HL LO REQ	Lighting switch OFF		Off
	Lighting switch 2ND HI or AUTO (Light is illuminated)		On
HL HI REQ	Lighting switch OFF		Off
	Lighting switch HI		On
FR FOG REQ	Lighting switch 2ND or AUTO (Light is illuminated)	Front fog lamp switch OFF	Off
		<ul style="list-style-type: none"> <li>• Front fog lamp switch ON</li> <li>• Daytime running light activated (Only for Canada)</li> </ul>	On
FR WIP REQ	Ignition switch ON	Front wiper switch OFF	Stop
		Front wiper switch INT	1LOW
		Front wiper switch LO	Low
		Front wiper switch HI	Hi
WIP AUTO STOP	Ignition switch ON	Front wiper stop position	STOP P
		Any position other than front wiper stop position	ACT P
WIP PROT	Ignition switch ON	Front wiper operates normally	Off
		Front wiper stops at fail-safe operation	BLOCK
IGN RLY1 -REQ	Ignition switch OFF or ACC		Off
	Ignition switch ON		On
IGN RLY	Ignition switch OFF or ACC		Off
	Ignition switch ON		On
PUSH SW	Release the push-button ignition switch		Off
	Press the push-button ignition switch		On
INTER/NP SW	Ignition switch ON	Selector lever in any position other than P or N	Off
		Selector lever in P or N position	On
ST RLY CONT	Ignition switch ON		Off
	At engine cranking		On
IHBT RLY -REQ	Ignition switch ON		Off
	At engine cranking		On

# IPDM E/R (INTELLIGENT POWER DISTRIBUTION MODULE ENGINE ROOM)

< ECU DIAGNOSIS >

[IPDM E/R]

Monitor Item	Condition	Value/Status
ST/INHI RLY	Ignition switch ON	Off
	At engine cranking	INHI → ST
	The status of starter relay or starter control relay cannot be recognized by the battery voltage malfunction, etc. when the starter relay is ON and the starter control relay is OFF	UNKWN
DETENT SW	Ignition switch ON	Off
	Release the selector button with selector lever in P position	On
S/L RLY -REQ	None of the conditions below are present	Off
	<ul style="list-style-type: none"> <li>Open the driver door after the ignition switch is turned OFF (for a few seconds)</li> <li>Press the push-button ignition switch when the steering lock is activated</li> </ul>	On
S/L STATE	Steering lock is activated	LOCK
	Steering lock is deactivated	UNLOCK
	[DTC: B210A] is detected	UNKWN
DTRL REQ	<b>NOTE:</b> The item is indicated, but not monitored.	Off
OIL P SW	Ignition switch OFF, ACC or engine running	Open
	Ignition switch ON	Close
HOOD SW	Close the hood	Off
	Open the hood	On
HL WASHER REQ	<b>NOTE:</b> The item is indicated, but not monitored.	Off
THFT HRN REQ	Not operation	Off
	<ul style="list-style-type: none"> <li>Panic alarm is activated</li> <li>Horn is activated with VEHICLE SECURITY (THEFT WARNING) SYSTEM</li> </ul>	On
HORN CHIRP	Not operating	Off
	Door locking with Intelligent Key (horn chirp mode)	On
CRNRNG LMP REQ	<b>NOTE:</b> The item is indicated, but not monitored.	Off

A  
B  
C  
D  
E  
F  
G  
H  
I  
J  
K  
L

PCS

# IPDM E/R (INTELLIGENT POWER DISTRIBUTION MODULE ENGINE ROOM)

< ECU DIAGNOSIS >

[IPDM E/R]

## TERMINAL LAYOUT

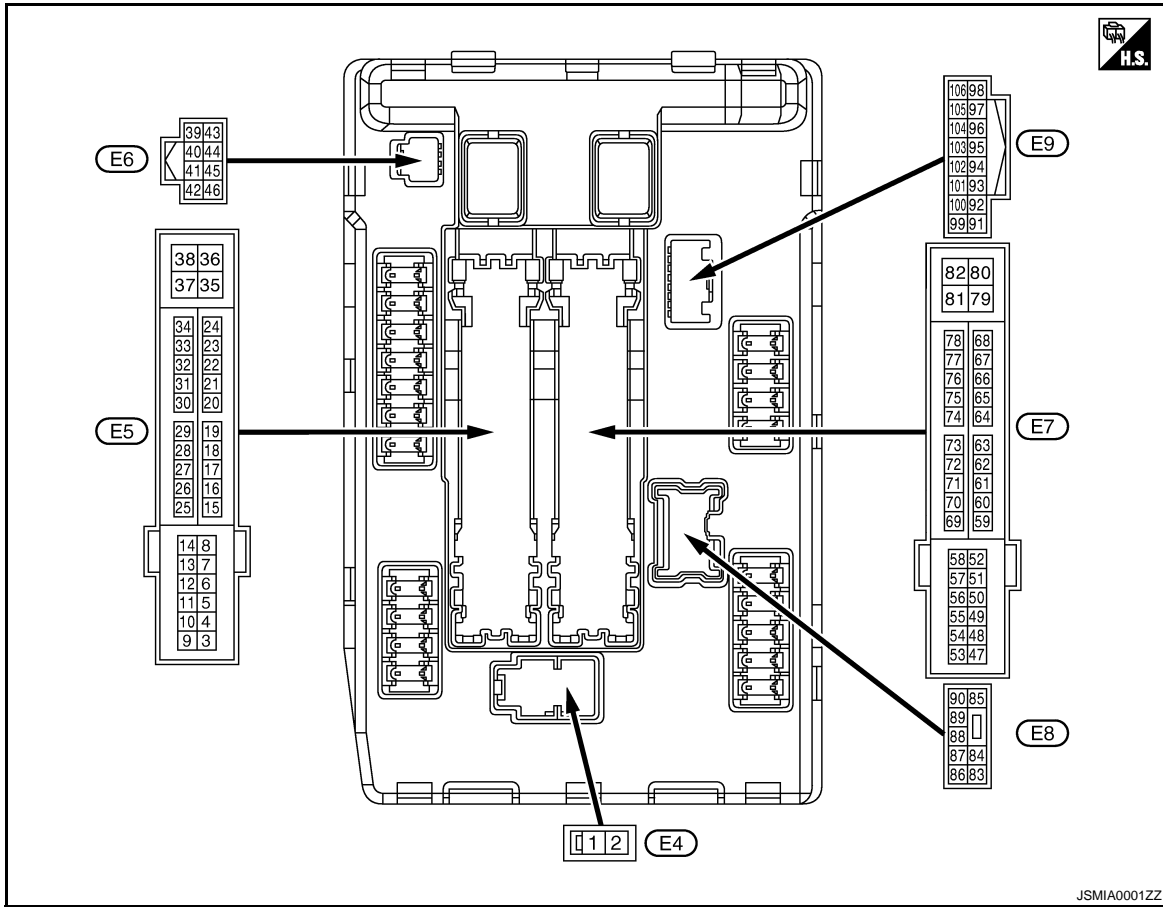

## PHYSICAL VALUES

Terminal No. (Wire color)		Description		Condition		Value (Approx.)
+	-	Signal name	Input/ Output			
1 (W)	Ground	Battery power supply	Input	Ignition switch OFF		Battery voltage
2 (L)	Ground	Battery power supply	Input	Ignition switch OFF		Battery voltage
4 (V)	Ground	Front wiper LO	Output	Ignition switch OFF	Front wiper switch OFF	0 V
				Ignition switch ON	Front wiper switch LO	Battery voltage
5 (L)	Ground	Front wiper HI	Output	Ignition switch OFF	Front wiper switch OFF	0 V
				Ignition switch ON	Front wiper switch HI	Battery voltage
7 (R)	Ground	Tail, license plate lamps & interior lamps	Output	Ignition switch OFF	Lighting switch OFF	0 V
				Ignition switch ON	Lighting switch 1ST	Battery voltage
11 (BR)	Ground	Steering lock unit power supply	Output	Ignition switch OFF	A few seconds after opening the driver door	Battery voltage
				Ignition switch LOCK	Press the push-button ignition switch	Battery voltage
				Ignition switch ACC or ON		0 V
12 (B/W)	Ground	Ground	—	Ignition switch ON		0 V

# IPDM E/R (INTELLIGENT POWER DISTRIBUTION MODULE ENGINE ROOM)

< ECU DIAGNOSIS >

[IPDM E/R]

Terminal No. (Wire color)		Description		Condition		Value (Approx.)	
13 (SB)	Ground	Fuel pump power supply	Output	Approximately 1 second or more after turning the ignition switch ON		0 V	A
				<ul style="list-style-type: none"> <li>• Approximately 1 second after turning the ignition switch ON</li> <li>• Engine running</li> </ul>		Battery voltage	B
16 (LG)	Ground	Front wiper auto stop	Input	Ignition switch ON	Front wiper stop position	0 V	C
					Any position other than front wiper stop position	Battery voltage	D
19 (W)	Ground	Ignition relay power supply	Output	Ignition switch OFF		0 V	E
				Ignition switch ON		Battery voltage	
25 (G)	Ground	Ignition relay power supply	Output	Ignition switch OFF		0 V	
				Ignition switch ON		Battery voltage	
26* (R)	Ground	Ignition relay power supply	Output	Ignition switch OFF		0 V	F
				Ignition switch ON		Battery voltage	
27 (O)	Ground	Ignition relay monitor	Input	Ignition switch OFF or ACC		Battery voltage	
				Ignition switch ON		0 V	G
28 (L)	Ground	Push-button ignition switch	Input	Press the push-button ignition switch		0 V	
				Release the push-button ignition switch		Battery voltage	H
30 (GR)	Ground	Starter relay control	Input	Ignition switch ON	Selector lever in any position other than P or N	0 V	I
					Selector lever P or N	Battery voltage	
32 (L)	Ground	Steering lock unit condition-1	Input	Steering lock is activated		0 V	
				Steering lock is deactivated		Battery voltage	J
33 (P)	Ground	Steering lock unit condition-2	Input	Steering lock is activated		Battery voltage	
				Steering lock is deactivated		0 V	K
36 (G)	Ground	Battery power supply	Input	Ignition switch OFF		Battery voltage	
39 (P)	—	CAN-L	Input/ Output	—		—	L
40 (L)	—	CAN-H	Input/ Output	—		—	
41 (B/W)	Ground	Ground	—	Ignition switch ON		0 V	PCS
42 (Y)	Ground	Cooling fan relay control	Input	Ignition switch OFF or ACC		0 V	
				Ignition switch ON		0.7 V	N
43 (SB)	Ground	Control device (Detention switch)	Input	Ignition switch ON	<ul style="list-style-type: none"> <li>• Press the selector button (Selector lever P)</li> <li>• Selector lever in any position other than P</li> </ul>	Battery voltage	O
					Release the selector button (selector lever P)	0 V	
44 (W)	Ground	Horn relay control	Input	The horn is deactivated		Battery voltage	
				The horn is activated		0 V	P
45 (G)	Ground	Anti theft horn relay control	Input	The horn is deactivated		Battery voltage	
				The horn is activated		0 V	

# IPDM E/R (INTELLIGENT POWER DISTRIBUTION MODULE ENGINE ROOM)

< ECU DIAGNOSIS >

[IPDM E/R]

Terminal No. (Wire color)		Description		Condition		Value (Approx.)
+	-	Signal name	Input/ Output			
46 (R)	Ground	Starter relay control	Input	Ignition switch ON	Selector lever in any position other than P or N	0 V
					Selector lever P or N	Battery voltage
48 (L)	Ground	A/C relay power supply	Output	Engine running	A/C switch OFF	0 V
						A/C switch ON (A/C compressor is operating)
49 (R)	Ground	ECM relay power supply	Output	Ignition switch OFF (More than a few seconds after turning ignition switch OFF)		0 V
				<ul style="list-style-type: none"> <li>• Ignition switch ON</li> <li>• Ignition switch OFF (For a few seconds after turning ignition switch OFF)</li> </ul>		Battery voltage
51 (G)	Ground	Ignition relay power supply	Output	Ignition switch OFF		0 V
				Ignition switch ON		Battery voltage
53 (W)	Ground	ECM relay power supply	Output	Ignition switch OFF (More than a few seconds after turning ignition switch OFF)		0 V
				<ul style="list-style-type: none"> <li>• Ignition switch ON</li> <li>• Ignition switch OFF (For a few seconds after turning ignition switch OFF)</li> </ul>		Battery voltage
54 (LG)	Ground	Throttle control motor relay power supply	Output	Ignition switch OFF (More than a few seconds after turning ignition switch OFF)		0 V
				<ul style="list-style-type: none"> <li>• Ignition switch ON</li> <li>• Ignition switch OFF (For a few seconds after turning ignition switch OFF)</li> </ul>		Battery voltage
55 (BR)	Ground	ECM power supply	Output	Ignition switch OFF		Battery voltage
56 (V)	Ground	Ignition relay power supply	Output	Ignition switch OFF		0 V
				Ignition switch ON		Battery voltage
57 (SB)	Ground	Ignition relay power supply	Output	Ignition switch OFF		0 V
				Ignition switch ON		Battery voltage
58 (P)	Ground	Ignition relay power supply	Output	Ignition switch OFF		0 V
				Ignition switch ON		Battery voltage
69 (W)	Ground	ECM relay control	Output	Ignition switch OFF (More than a few seconds after turning ignition switch OFF)		Battery voltage
				<ul style="list-style-type: none"> <li>• Ignition switch ON</li> <li>• Ignition switch OFF (For a few seconds after turning ignition switch OFF)</li> </ul>		0 – 1.5 V
70 (O)	Ground	Throttle control motor relay control	Output	Ignition switch ON → OFF		0 – 1.0 V ↓ Battery voltage ↓ 0 V
				Ignition switch ON		0 – 1.0 V



# IPDM E/R (INTELLIGENT POWER DISTRIBUTION MODULE ENGINE ROOM)

< ECU DIAGNOSIS >

[IPDM E/R]

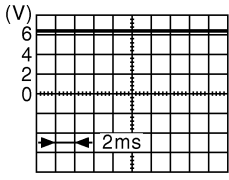
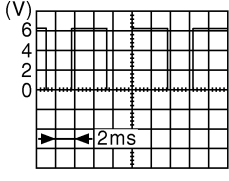
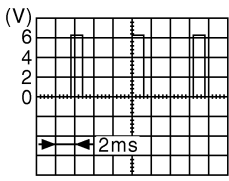
Terminal No. (Wire color)		Description		Condition		Value (Approx.)
		Signal name	Input/ Output			
+	-					
74 (P)	Ground	Ignition relay power supply	Output	Ignition switch OFF		0 V
				Ignition switch ON		Battery voltage
75 (Y)	Ground	Oil pressure switch	Input	Ignition switch ON	Engine stopped	0 V
					Engine running	Battery voltage
76 (V)	Ground	Power generation command signal	Output	Ignition switch ON		 <p style="text-align: right; margin-right: 50px;">JPMIA0001GB</p> <p style="text-align: center;">6.3 V</p>
				40% is set on "ACTIVE TEST", "ALTERNATOR DUTY" of "ENGINE"		 <p style="text-align: right; margin-right: 50px;">JPMIA0002GB</p> <p style="text-align: center;">3.8 V</p>
				80% is set on "ACTIVE TEST", "ALTERNATOR DUTY" of "ENGINE"		 <p style="text-align: right; margin-right: 50px;">JPMIA0003GB</p> <p style="text-align: center;">1.4 V</p>
77 (L)	Ground	Fuel pump relay control	Output	<ul style="list-style-type: none"> <li>• Approximately 1 second after turning the ignition switch ON</li> <li>• Engine running</li> </ul>		0 – 1.0 V
				Approximately 1 second or more after turning the ignition switch ON		Battery voltage
80 (W)	Ground	Starter motor	Output	At engine cranking		Battery voltage
83 (O)	Ground	Headlamp LO (RH)	Output	Ignition switch ON	Lighting switch OFF	0 V
					Lighting switch 2ND	Battery voltage
84 (V)	Ground	Headlamp LO (LH)	Output	Ignition switch ON	Lighting switch OFF	0 V
					Lighting switch 2ND	Battery voltage
86 (W)	Ground	Front fog lamp (RH)	Output	Lighting switch 2ND	<ul style="list-style-type: none"> <li>• Front fog lamp switch ON</li> <li>• Daytime running light activated (Only for Canada)</li> </ul>	Battery voltage
					Front fog lamp switch OFF	0 V

A  
B  
C  
D  
E  
F  
G  
H  
I  
J  
K  
L  
N  
O  
P

PCS

# IPDM E/R (INTELLIGENT POWER DISTRIBUTION MODULE ENGINE ROOM)

< ECU DIAGNOSIS >

[IPDM E/R]

Terminal No. (Wire color)		Description		Condition		Value (Approx.)
+	-	Signal name	Input/ Output			
87 (L)	Ground	Front fog lamp (LH)	Output	Lighting switch 2ND	<ul style="list-style-type: none"> <li>• Front fog lamp switch ON</li> <li>• Daytime running light activated (Only for Canada)</li> </ul>	Battery voltage
					Front fog lamp switch OFF	0 V
88 (GR)	Ground	Washer pump power supply	Output	Ignition switch ON		Battery voltage
89 (BR)	Ground	Headlamp HI (RH)	Output	Ignition switch ON	<ul style="list-style-type: none"> <li>• Lighting switch HI</li> <li>• Lighting switch PASS</li> </ul>	Battery voltage
					Lighting switch OFF	0 V
90 (P)	Ground	Headlamp HI (LH)	Output	Ignition switch ON	<ul style="list-style-type: none"> <li>• Lighting switch HI</li> <li>• Lighting switch PASS</li> </ul>	Battery voltage
					Lighting switch OFF	0 V
91 (P)	Ground	Parking lamp (RH)	Output	Ignition switch ON	Lighting switch 1ST	Battery voltage
					Lighting switch OFF	0 V
92 (O)	Ground	Parking lamp (LH)	Output	Ignition switch ON	Lighting switch 1ST	Battery voltage
					Lighting switch OFF	0 V
97 (V)	Ground	Cooling fan control	Output	Engine idling		0 – 5 V
104 (LG)	Ground	Hood switch	Input	Close the hood		Battery voltage
				Open the hood		0 V

\*: Only for the models with ICC system

# IPDM E/R (INTELLIGENT POWER DISTRIBUTION MODULE ENGINE ROOM)

< ECU DIAGNOSIS >

[IPDM E/R]

## Wiring Diagram - IPDM E/R -

INFOID:000000003132007

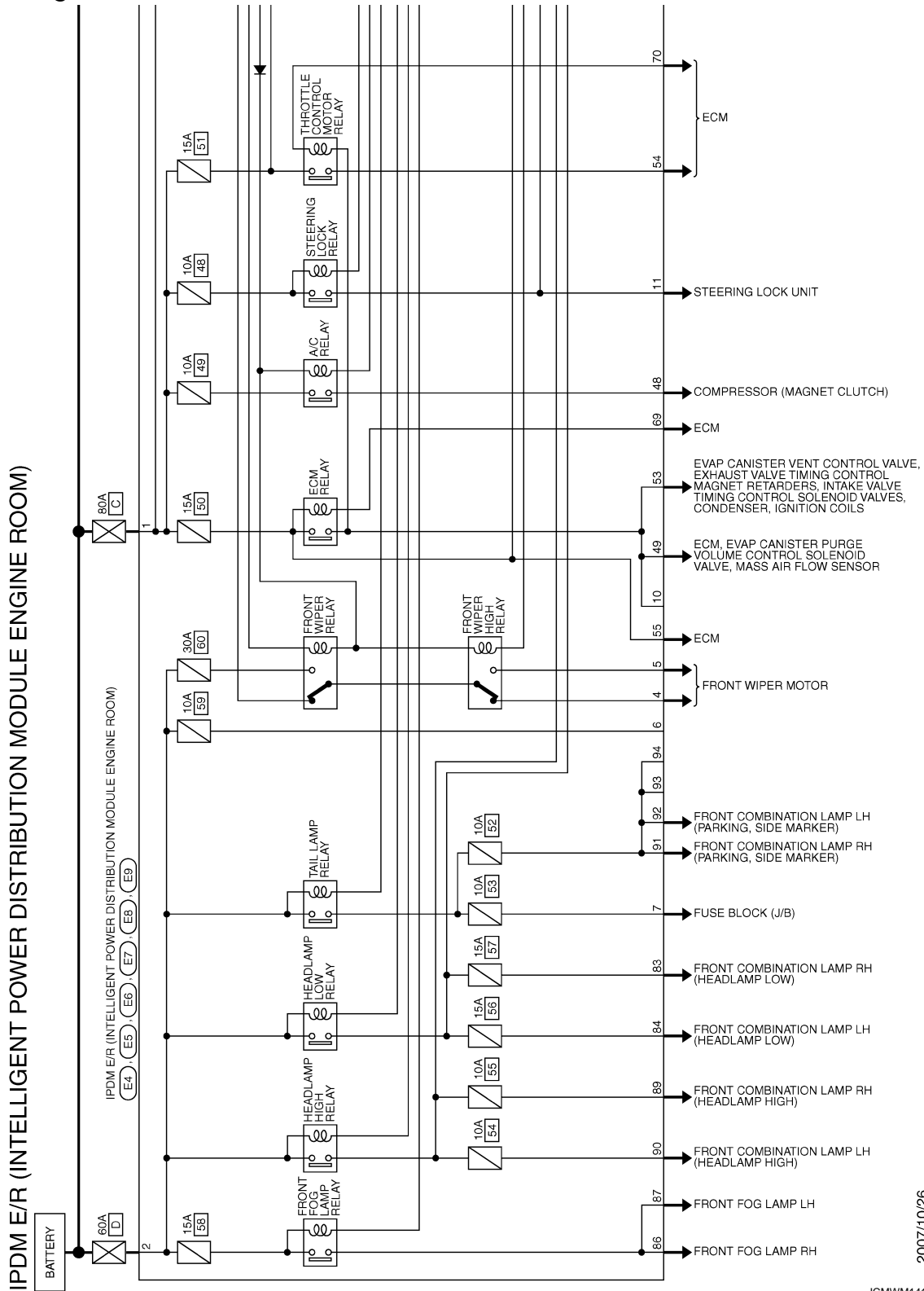

A  
B  
C  
D  
E  
F  
G  
H  
I  
J  
K  
L  
PCS  
N  
O  
P

2007/10/26

JCMWM1411GI

# IPDM E/R (INTELLIGENT POWER DISTRIBUTION MODULE ENGINE ROOM)

< ECU DIAGNOSIS >

[IPDM E/R]

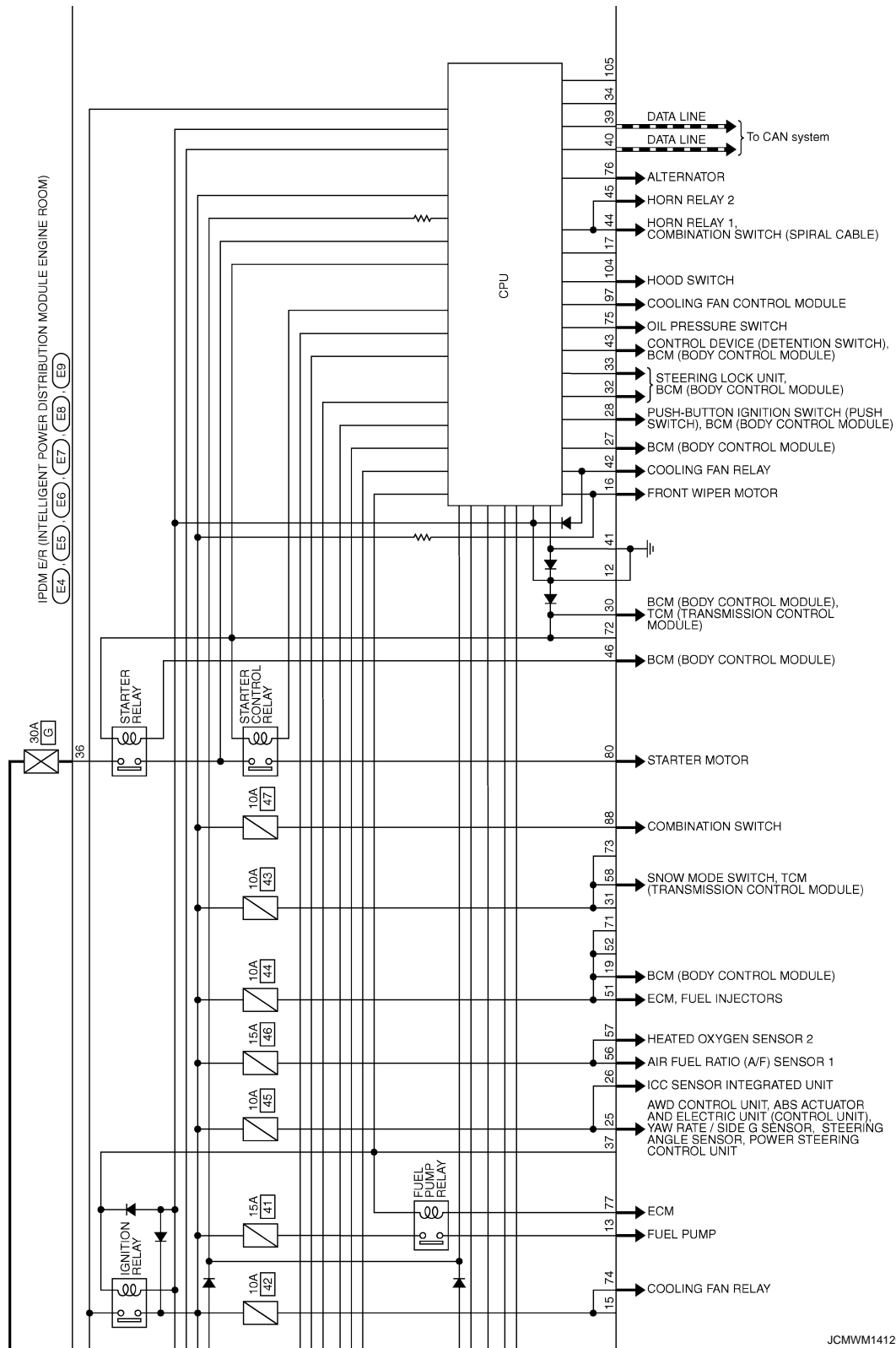

JCMWM1412G

A  
 B  
 C  
 D  
 E  
 F  
 G  
 H  
 I  
 J  
 K  
 L  
 N  
 O  
 P

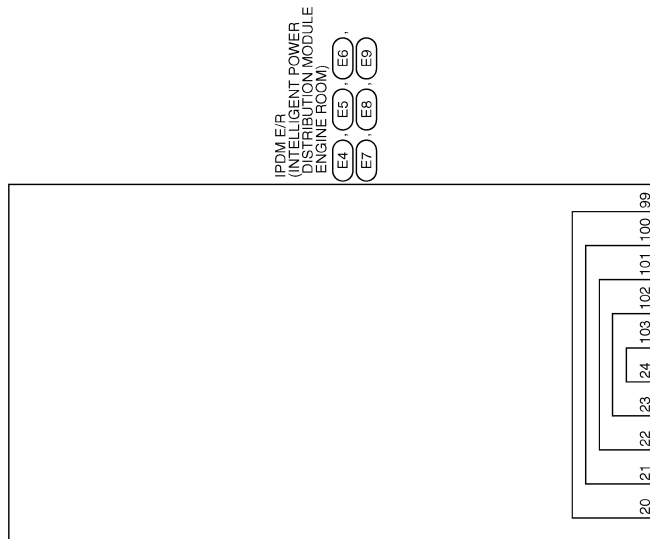

PCS

JCMWM1413G1



# IPDM E/R (INTELLIGENT POWER DISTRIBUTION MODULE ENGINE ROOM)

< ECU DIAGNOSIS >

[IPDM E/R]

**IPDM E/R (INTELLIGENT POWER DISTRIBUTION MODULE ENGINE ROOM)**



Connector No.	E6
Connector Name	IPDM E/R (INTELLIGENT POWER DISTRIBUTION MODULE ENGINE ROOM)
Connector Type	TH18FW-NH

Terminal No.	Color of Wire	Signal Name [Specification]
39	P	-
40	L	-
41	B/W	-
42	Y	-
43	SB	-
44	W	-
45	G	-
46	R	-

**IPDM E/R (INTELLIGENT POWER DISTRIBUTION MODULE ENGINE ROOM)**

Connector No.	E9
Connector Name	IPDM E/R (INTELLIGENT POWER DISTRIBUTION MODULE ENGINE ROOM)
Connector Type	TH18FW-NH





Terminal No.	Color of Wire	Signal Name [Specification]
91	P	-
92	O	-
97	V	-
104	LG	-

28	L	-
30	GR	-
32	B	-
33	P	-
36	G	-

**IPDM E/R (INTELLIGENT POWER DISTRIBUTION MODULE ENGINE ROOM)**



Connector No.	E8
Connector Name	IPDM E/R (INTELLIGENT POWER DISTRIBUTION MODULE ENGINE ROOM)
Connector Type	NS08FW-CS

Terminal No.	Color of Wire	Signal Name [Specification]
83	O	-
84	V	-
86	W	-
87	L	-
88	GR	-
89	BR	-
90	P	-

**IPDM E/R (INTELLIGENT POWER DISTRIBUTION MODULE ENGINE ROOM)**

Connector No.	E5
Connector Name	IPDM E/R (INTELLIGENT POWER DISTRIBUTION MODULE ENGINE ROOM)
Connector Type	TH20FW-CS12-M4-1V





Terminal No.	Color of Wire	Signal Name [Specification]
4	V	-
5	L	-
7	R	-
11	BR	-
12	B/W	-
13	SB	-
16	LG	-
19	W	-
25	G	-
26	R	-
27	O	-

74	P	-
75	Y	-
76	V	-
77	L	-
80	W	-

**IPDM E/R (INTELLIGENT POWER DISTRIBUTION MODULE ENGINE ROOM)**



Connector No.	E4
Connector Name	IPDM E/R (INTELLIGENT POWER DISTRIBUTION MODULE ENGINE ROOM)
Connector Type	LO2FB-MC

Terminal No.	Color of Wire	Signal Name [Specification]
1	W	-
2	L	-

**IPDM E/R (INTELLIGENT POWER DISTRIBUTION MODULE ENGINE ROOM)**

Connector No.	E7
Connector Name	IPDM E/R (INTELLIGENT POWER DISTRIBUTION MODULE ENGINE ROOM)
Connector Type	TH20FW-CS12-M4

Terminal No.	Color of Wire	Signal Name [Specification]
48	L	-
49	R	-
51	G	-
53	W	-
54	LG	-
55	BR	-
56	V	-
57	SB	-
58	P	-
68	W	-
70	O	-

## Fail-safe

### CAN COMMUNICATION CONTROL

When CAN communication with ECM and BCM is impossible, IPDM E/R performs fail-safe control. After CAN communication recovers normally, it also returns to normal control.

If No CAN Communication Is Available With ECM

JCMWM1414G

INFOID:000000003132008

# IPDM E/R (INTELLIGENT POWER DISTRIBUTION MODULE ENGINE ROOM)

< ECU DIAGNOSIS >

[IPDM E/R]

Control part	Fail-safe operation
Cooling fan	<ul style="list-style-type: none"> <li>• Outputs the pulse duty signal (PWM signal) 100% when the ignition switch is turned ON</li> <li>• Outputs the pulse duty signal (PWM signal) 0% when the ignition switch is turned OFF</li> </ul>
A/C compressor	A/C relay OFF
Alternator	Outputs the power generation command signal (PWM signal) 0%

If No CAN Communication Is Available With BCM

Control part	Fail-safe operation
Headlamp	<ul style="list-style-type: none"> <li>• Turns ON the headlamp low relay when the ignition switch is turned ON</li> <li>• Turns OFF the headlamp low relay when the ignition switch is turned OFF</li> <li>• Headlamp high relay OFF</li> </ul>
<ul style="list-style-type: none"> <li>• Parking lamps</li> <li>• License plate lamps</li> <li>• Side maker lamps</li> <li>• Illuminations</li> <li>• Tail lamps</li> </ul>	<ul style="list-style-type: none"> <li>• Turns ON the tail lamp relay when the ignition switch is turned ON</li> <li>• Turns OFF the tail lamp relay when the ignition switch is turned OFF</li> </ul>
Front wiper	<ul style="list-style-type: none"> <li>• The status just before activation of fail-safe control is maintained until the ignition switch is turned OFF while the front wiper is operating at LO or HI speed.</li> <li>• The wiper is operated at LO speed until the ignition switch is turned OFF if the fail-safe control is activated while the front wiper is set in the INT mode and the front wiper motor is operating.</li> </ul>
Front fog lamps	Front fog lamp relay OFF
Horn	Horn OFF
Ignition relay	The status just before activation of fail-safe is maintained.
Starter motor	Starter control relay OFF
Steering lock unit	Steering lock relay OFF

## IGNITION RELAY MALFUNCTION DETECTION FUNCTION

- IPDM E/R monitors the voltage at the contact circuit and excitation coil circuit of the ignition relay inside it.
- IPDM E/R judges the ignition relay error if the voltage differs between the contact circuit and the excitation coil circuit.
- If the ignition relay cannot turn OFF due to contact seizure, it activates the tail lamp relay for 10 minutes to alert the user to the ignition relay malfunction when the ignition switch is turned OFF.

Voltage judgment		IPDM E/R judgment	Operation
Ignition relay contact side	Ignition relay excitation coil side		
ON	ON	Ignition relay ON normal	—
OFF	OFF	Ignition relay OFF normal	—
ON	OFF	Ignition relay ON stuck	<ul style="list-style-type: none"> <li>• Detects DTC "B2098: IGN RELAY ON"</li> <li>• Turns ON the tail lamp relay for 10 minutes</li> </ul>
OFF	ON	Ignition relay OFF stuck	Detects DTC "B2099: IGN RELAY OFF"

## FRONT WIPER CONTROL

IPDM E/R detects front wiper stop position by a front wiper auto stop signal.

When a front wiper auto stop signal is in the conditions listed below, IPDM E/R stops power supply to wiper after repeating a front wiper 10 seconds activation and 20 seconds stop five times.

# IPDM E/R (INTELLIGENT POWER DISTRIBUTION MODULE ENGINE ROOM)

< ECU DIAGNOSIS >

[IPDM E/R]

Ignition switch	Front wiper switch	Front wiper auto stop signal
ON	OFF	The front wiper auto stop signal (stop position) cannot be input for 10 seconds.
	ON	The front wiper auto stop signal does not change for 10 seconds.

**NOTE:**

This operation status can be confirmed on the IPDM E/R “Data Monitor” that displays “BLOCK” for the item “WIP PROT” while the wiper is stopped.

**STARTER MOTOR PROTECTION FUNCTION**

IPDM E/R turns OFF the starter control relay to protect the starter motor when the starter control relay remains active for 90 seconds.

**DTC Index**

INFOID:000000003132009

**NOTE:**

- The details of time display are as follows.
  - CRNT: A malfunction is detected now
  - PAST: A malfunction was detected in the past.
- IGN counter is displayed on FFD (Freeze Frame data).
  - The number is 0 when is detected now
  - The number increases like 1 → 2 ... 38 → 39 after returning to the normal condition whenever IGN OFF → ON.
  - The number is fixed to 39 until the self-diagnosis results are erased if it is over 39.

×: Applicable

CONSULT display	Fail-safe	Reference
No DTC is detected. further testing may be required.	—	—
U1000: CAN COMM CIRCUIT	×	<a href="#">PCS-16</a>
B2098: IGN RELAY ON	×	<a href="#">PCS-17</a>
B2099: IGN RELAY OFF	—	<a href="#">PCS-18</a>
B2108: STRG LCK RELAY ON	—	<a href="#">SEC-97</a>
B2109: STRG LCK RELAY OFF	—	<a href="#">SEC-98</a>
B210A: STRG LCK STATE SW	—	<a href="#">SEC-99</a>
B210B: START CONT RLY ON	—	<a href="#">SEC-103</a>
B210C: START CONT RLY OFF	—	<a href="#">SEC-104</a>
B210D: STARTER RELAY ON	—	<a href="#">SEC-105</a>
B210E: STARTER RELAY OFF	—	<a href="#">SEC-106</a>
B210F: INTRLCK/PNP SW ON	—	<a href="#">SEC-108</a>
B2110: INTRLCK/PNP SW OFF	—	<a href="#">SEC-110</a>



# PRECAUTION

## PRECAUTIONS

### Precaution for Procedure without Cowl Top Cover

INFOID:000000003737083

When performing the procedure after removing cowl top cover, cover the lower end of windshield with urethane, etc.

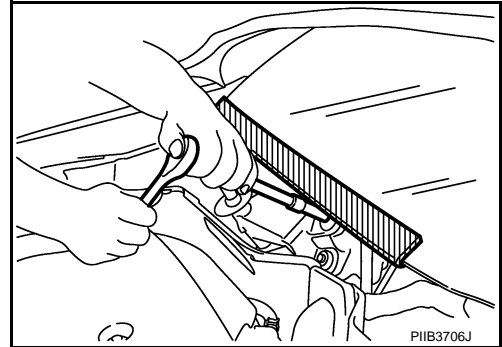

A  
B  
C  
D  
E  
F  
G  
H  
I  
J  
K  
L

PCS

N  
O  
P

## ON-VEHICLE REPAIR

### IPDM E/R (INTELLIGENT POWER DISTRIBUTION MODULE ENGINE ROOM)

#### Exploded View

INFOID:000000003132011

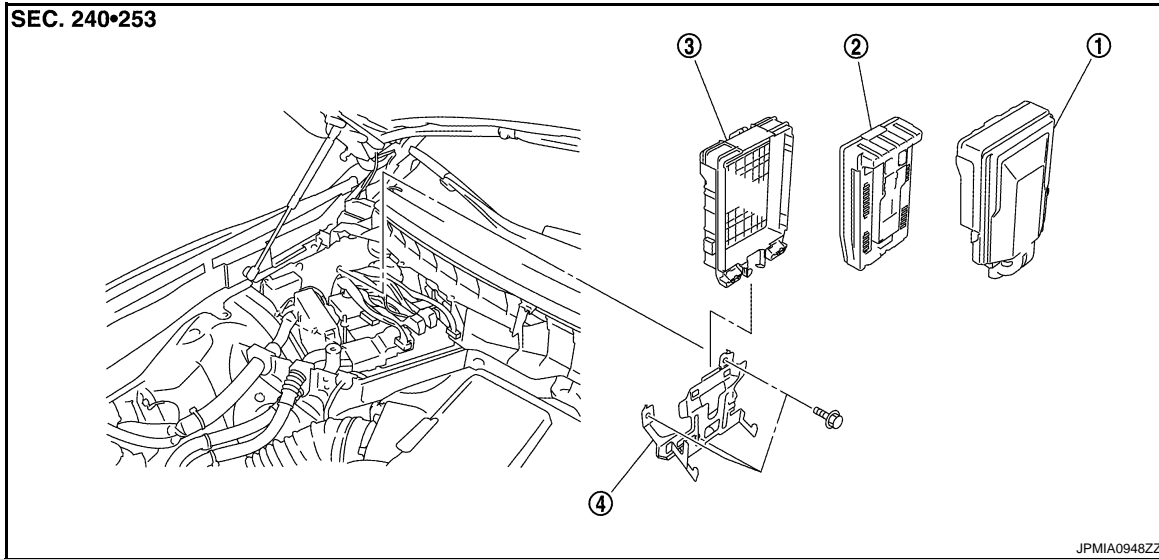

1. IPDM E/R cover A

2. IPDM E/R

3. IPDM E/R cover B

4. Bracket

#### Removal and Installation

INFOID:000000003132012

#### **CAUTION:**

**IPDM E/R integrated relays are not serviceable parts, and must not be removed from the unit.**

#### REMOVAL

1. Disconnect the battery cable from the negative terminal.
2. Remove cowl top cover (RH). Refer to [EXT-22, "Exploded View"](#).
3. Pull up the IPDM E/R assembly while pressing the pawl (A) on the back of the IPDM E/R cover B (1).

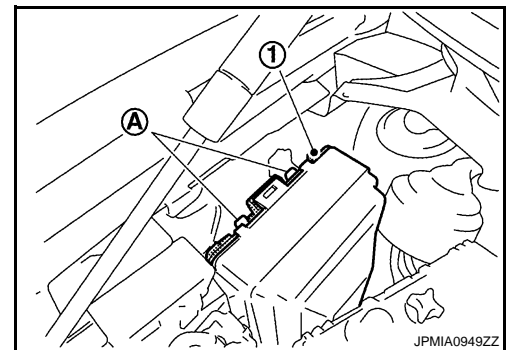

# IPDM E/R (INTELLIGENT POWER DISTRIBUTION MODULE ENGINE ROOM)

[IPDM E/R]

## < ON-VEHICLE REPAIR >

4. Remove the IPDM E/R cover A while pressing the pawl (A) at the lower end of the IPDM E/R cover A (1).
5. Disconnect the harness connector and remove IPDM E/R (2).

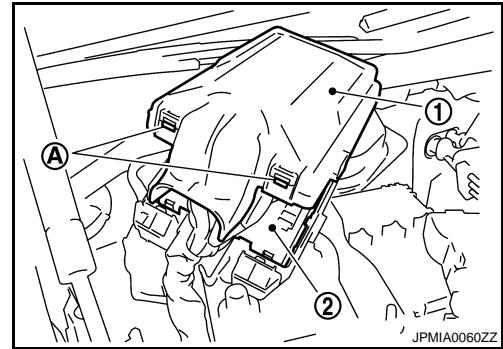

6. Remove the bolt (A) and remove the bracket (1) from the vehicle.

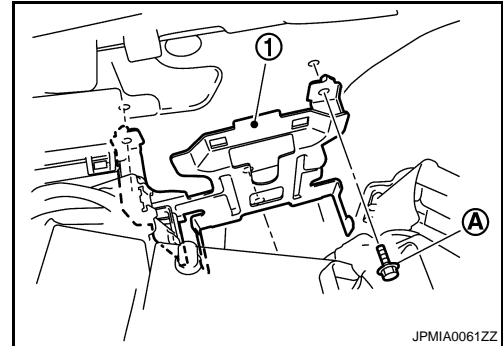

## INSTALLATION

Install in the reverse order of removal.

A  
B  
C  
D  
E  
F  
G  
H  
I  
J  
K  
L

PCS

N  
O  
P

# DIAGNOSIS AND REPAIR WORKFLOW

< BASIC INSPECTION >

[POWER DISTRIBUTION SYSTEM]

## BASIC INSPECTION

### DIAGNOSIS AND REPAIR WORKFLOW

Work Flow

INFOID:000000003132013

OVERALL SEQUENCE

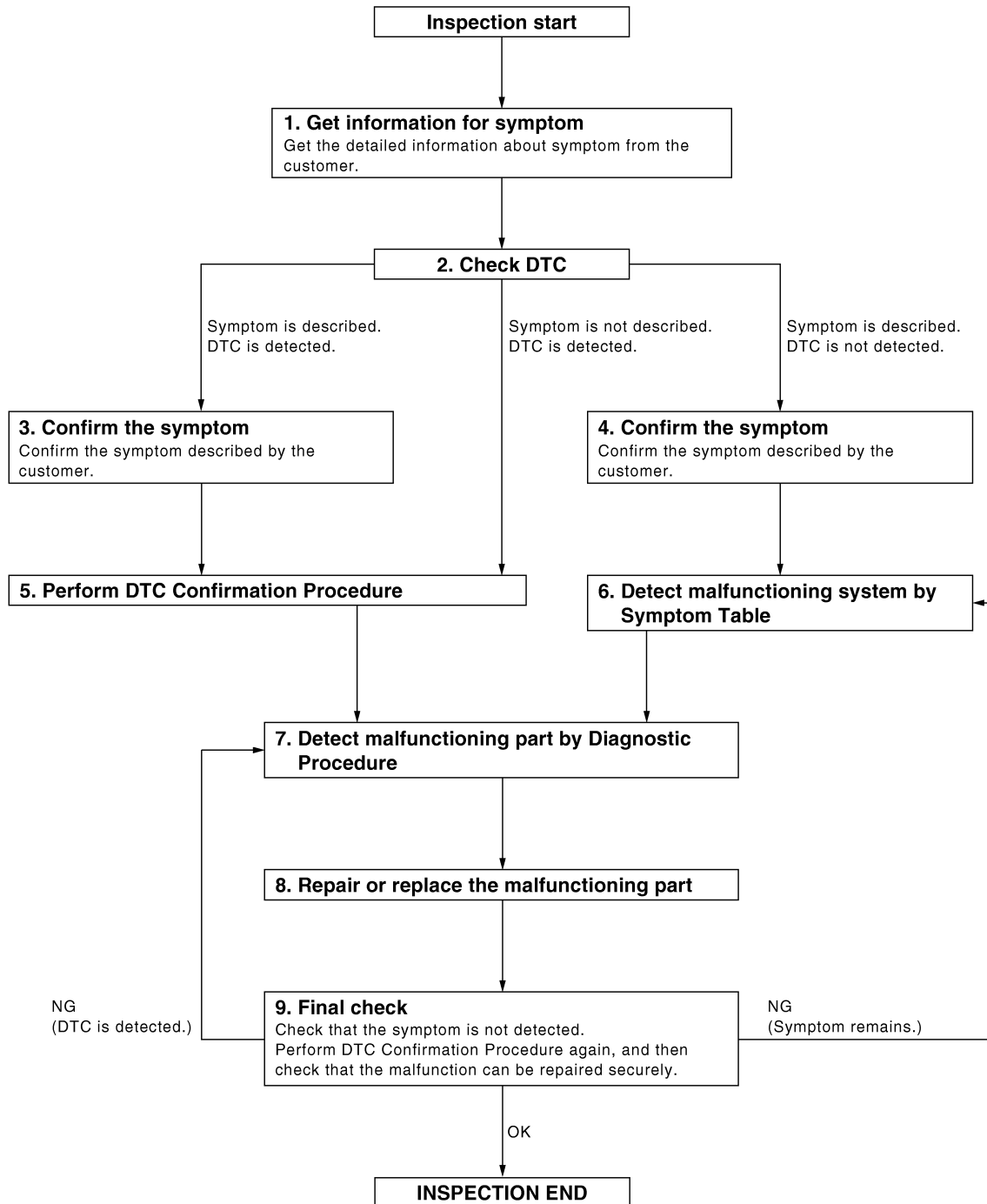

DETAILED FLOW

JMKIA0676GB

# DIAGNOSIS AND REPAIR WORKFLOW

< BASIC INSPECTION >

[POWER DISTRIBUTION SYSTEM]

## 1.GET INFORMATION FOR SYMPTOM

Get the detailed information from the customer about the symptom (the condition and the environment when the incident/malfunction occurred).

>> GO TO 2.

## 2.CHECK DTC

1. Check DTC for BCM and IPDM E/R.
2. Perform the following procedure if DTC is detected.
  - Record DTC and freeze frame data (Print them out with CONSULT-III.)
  - Erase DTC.
  - Study the relationship between the cause detected by DTC and the symptom described by the customer.
3. Check related service bulletins for information.

Is any symptom described and any DTC detected?

Symptom is described, DTC is detected>>GO TO 3.

Symptom is described, DTC is not detected>>GO TO 4.

Symptom is not described, DTC is detected>>GO TO 5.

## 3.CONFIRM THE SYMPTOM

Confirm the symptom described by the customer.

Connect CONSULT-III to the vehicle in "DATA MONITOR" mode and check real time diagnosis results.

Verify relation between the symptom and the condition when the symptom is detected.

>> GO TO 5.

## 4.CONFIRM THE SYMPTOM

Confirm the symptom described by the customer.

Connect CONSULT-III to the vehicle in "DATA MONITOR" mode and check real time diagnosis results.

Verify relation between the symptom and the condition when the symptom is detected.

>> GO TO 6.

## 5.PERFORM DTC CONFIRMATION PROCEDURE

Perform DTC Confirmation Procedure for the detected DTC, and then check that DTC is detected again.

At this time, always connect CONSULT-III to the vehicle, and check diagnostic results in real time.

If two or more DTCs are detected, refer to [PCS-107. "DTC Inspection Priority Chart"](#), and determine trouble diagnosis order.

### NOTE:

Perform Component Function Check if DTC Confirmation Procedure is not included in Service Manual. This simplified check procedure is an effective alternative though DTC cannot be detected during this check.

If the result of Component Function Check is NG, it is the same as the detection of DTC by DTC Confirmation Procedure.

Is DTC detected?

YES >> GO TO 7.

NO >> Refer to [GI-38. "Intermittent Incident"](#).

## 6.DETECT MALFUNCTIONING SYSTEM BY SYMPTOM TABLE

Detect malfunctioning system according to [PCS-126. "Symptom Table"](#) based on the confirmed symptom in step 4, and determine the trouble diagnosis order based on possible causes and symptom.

>> GO TO 7.

## 7.DETECT MALFUNCTIONING PART BY DIAGNOSTIC PROCEDURE

Inspect according to Diagnostic Procedure of the system.

### NOTE:

The Diagnostic Procedure described based on open circuit inspection. A short circuit inspection is also required for the circuit check in the Diagnostic Procedure.

A  
B  
C  
D  
E  
F  
G  
H  
I  
J  
K  
L  
N  
O  
P

## DIAGNOSIS AND REPAIR WORKFLOW

< BASIC INSPECTION >

[POWER DISTRIBUTION SYSTEM]

---

Is malfunctioning part detected?

YES >> GO TO 8.

NO >> Check voltage of related BCM terminals using CONSULT-III.

### 8. REPAIR OR REPLACE THE MALFUNCTIONING PART

---

1. Repair or replace the malfunctioning part.
2. Reconnect parts or connectors disconnected during Diagnostic Procedure again after repair and replacement.
3. Check DTC. If DTC is detected, erase it.

>> GO TO 9.

### 9. FINAL CHECK

---

When DTC was detected in step 2, perform DTC Confirmation Procedure or Component Function Check again, and then check that the malfunction has been repaired securely.

When symptom was described from the customer, refer to confirmed symptom in step 3 or 4, and check that the symptom is not detected.

Does the symptom reappear?

YES (DTC is detected)>>GO TO 7.

YES (Symptom remains)>>GO TO 6.

NO >> **INSPECTION END**

FUNCTION DIAGNOSIS

POWER DISTRIBUTION SYSTEM

System Description

INFOID:000000003586701

INPUT/OUTPUT SIGNAL CHART

Switch	Input Signal to BCM	BCM system	Actuator
Push-button ignition switch	Push switch	Power distribution system	<ul style="list-style-type: none"> <li>• Ignition relay (IPDM E/R)</li> <li>• Ignition relay (fuse block)</li> <li>• ACC relay</li> <li>• Blower relay</li> </ul>
Control device	P range		
PNP switch	N, P range		
Stop lamp switch	Brake ON/OFF		

SYSTEM DESCRIPTION

- PDS (POWER DISTRIBUTION SYSTEM) is the system that BCM controls with the operation of the push-button ignition switch and performs the power distribution to each power circuit. This system is used instead of the mechanical power supply changing mechanism with the operation of the conventional key cylinder.
- The push-button ignition switch can be operated when Intelligent Key is in the following condition. Refer to Engine Start Function for details.
  - Intelligent Key is in the detection area of the inside key antenna
  - Insert Intelligent Key into the key slot
- The push-button ignition switch operation is input to BCM as a signal. BCM changes the power supply position according to the status and operates the following relays to supply power to each power circuit.
  - Ignition relay (built into IPDM E/R)
  - Ignition relay (inserted into fuse block)
  - ACC relay
  - Blower fan relay

**NOTE:**

- The engine switch operation changes due to the conditions of brake pedal, selector lever and vehicle speed.
- The power supply position can be confirmed with the lighting of the indicators around the push-button ignition switch.

BATTERY SAVER SYSTEM

When all the following conditions are met for 60 minutes, the battery saver system will cut off the power supply to prevent battery discharge.

- The ignition switch is in the ACC position
- All doors are closed
- Selector lever is in the P position

Reset Condition of Battery Saver System

In order to prevent the battery from discharging, the battery saver system will cut off the power supply when all doors are closed, the selector lever is on P position and the ignition switch is left on ACC position for 60 minutes. If any of the following conditions are met the battery saver system is released and the steering will change automatically to lock position from OFF position.

- Opening any door
- Operating with door key cylinder on door lock
- Operating with request switch on door lock
- Operating with Intelligent Key on door lock

Press push-button ignition switch and ignition switch will change to ACC position from OFF position.

STEERING LOCK OPERATION

Steering is locked by steering lock unit when ignition switch is in the OFF position, selector lever is in the P position and any of the following conditions are met.

- Opening door
- Closing door
- Door is locked with request switch
- Door is locked with Intelligent Key

PUSH-BUTTON IGNITION SWITCH OPERATION PROCEDURE

The power supply position changing operation can be performed with the following operations.

A

B

C

D

E

F

G

H

I

J

K

L

PCS

N

O

P

# POWER DISTRIBUTION SYSTEM

< FUNCTION DIAGNOSIS >

[POWER DISTRIBUTION SYSTEM]

## Operation Enable Condition

- When an Intelligent Key is within the detection area of inside key antenna and when it is inserted into the key slot, it is equivalent to the operations below.
- When starting the engine, the BCM monitors under the engine start conditions,
  - Brake pedal operating condition
  - Selector lever position
  - Vehicle speed
- Unless each start condition is fulfilled, the engine will not respond regardless of how many times the engine switch is pressed. At that time, illumination repeats the position in the order of LOCK→ACC→ON→OFF.

## Operation Condition

Power supply position	Engine start/stop condition		Push-button ignition switch operation frequency
	Brake pedal	Selector lever position	
LOCK → ACC	Not depressed	Any position	1
LOCK → ACC → ON	Not depressed	Any position	2
LOCK → ACC → ON → OFF	Not depressed	Any position	3
LOCK → START ACC → START ON → START (Engine start)	Depressed	P or N position (*1)	1 [If the switch is pressed once, the engine starts from any power supply position (LOCK, ACC, and ON)]
Engine is running → OFF (Engine stop)	—	P position	1
Engine is running → ACC (Engine stop)	—	Any position other than P (*2)	1
Engine stall return operation while driving	—	N position	1

\*1: When the selector lever position is N position, the engine start condition is different according to the vehicle speed.

- At vehicle speed of less than 4 km/h (2.5MPH), the engine can start only when the brake pedal is depressed.
- At vehicle speed of 4 km/h (2.5MPH) or more, the engine can start even if the brake pedal is not depressed. (It is the same as “Engine stall return operation while driving”.)

\*2: When the selector lever position is in any position other than P position and when the vehicle speed is 5 km/h (3.1MPH) or more, the engine stop condition is different.

- Press and hold the push-button ignition switch for 2 seconds or more. (When the push-button ignition switch is pressed for too short a time, the operation may be invalid, so properly press and hold to prevent an incorrect operation.)
- Press the push-button ignition switch 3 times or more within 1.5 seconds. (Emergency stop operation)



# POWER DISTRIBUTION SYSTEM

< FUNCTION DIAGNOSIS >

[POWER DISTRIBUTION SYSTEM]

## Component Parts Location

INFOID:000000003586702

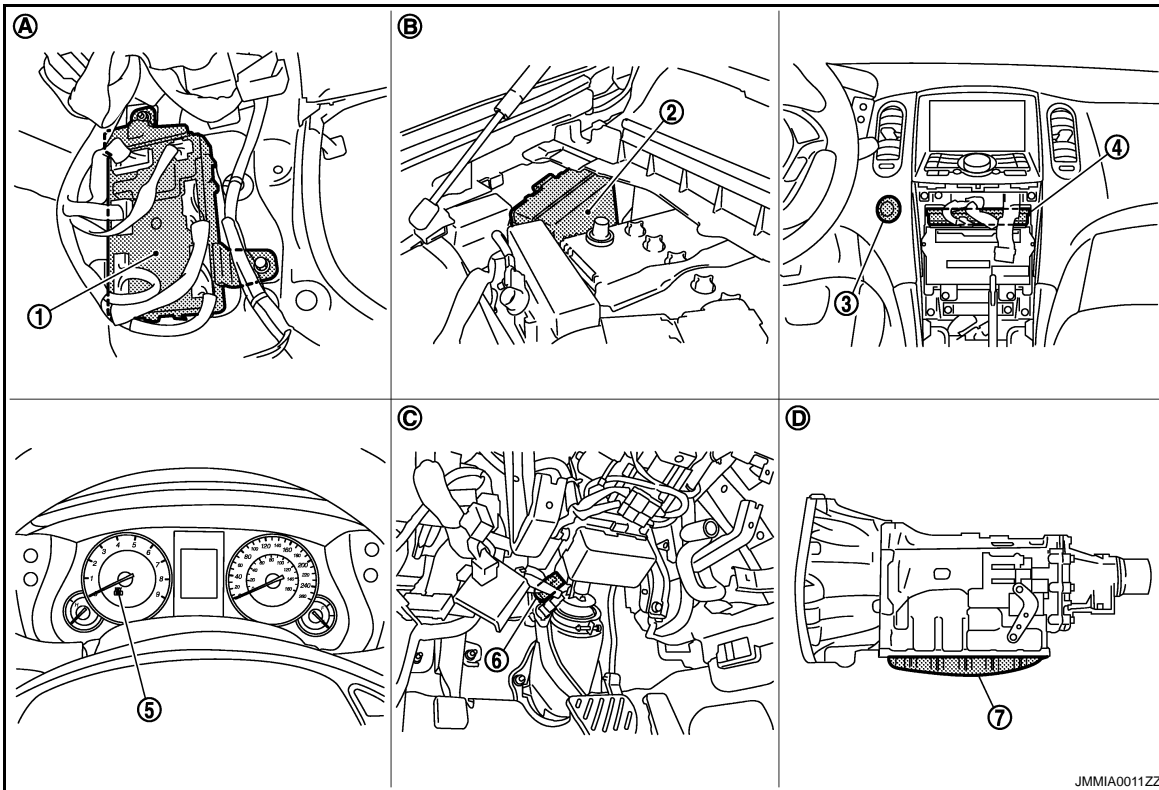

- |  |   |   |
|--|---|---|
| 1. BCM M118, M119, M121, M122, M123    | 2. IPDM E/R E5, E6, E7                      | 3. Push-button ignition switch M50          |
| 4. Unified meter and A/C amp. M66, M67 | 5. Combination meter (Key warning lamp) M53 | 6. Stop lamp switch E110                    |
| 7. TCM F151 (built into A/T assembly)  |   |   |
| A. Dash side lower (passenger side)    | B. Engine room dash panel (RH)              | C. Behind the instrument driver lower panel |
| D. A/T assembly                        |   |   |

## Component Description

INFOID:000000003586703

Component	Reference
IPDM E/R	<a href="#">PCS-7</a>
Ignition relay (Built-in IPDM E/R)	<a href="#">PCS-18</a>
Ignition relay (Built-in fuse block)	<a href="#">PCS-49</a>
Accessory relay	<a href="#">PCS-53</a>
Blower relay	<a href="#">PCS-57</a>
Stop lamp switch	<a href="#">SEC-52</a>
Park/neutral position switch	<a href="#">SEC-66</a>
Push-button ignition switch	<a href="#">PCS-65</a>

A  
B  
C  
D  
E  
F  
G  
H  
I  
J  
K  
L  
N  
O  
P

PCS

# DIAGNOSIS SYSTEM (BCM)

< FUNCTION DIAGNOSIS >

[POWER DISTRIBUTION SYSTEM]

## DIAGNOSIS SYSTEM (BCM)

### COMMON ITEM

#### COMMON ITEM : CONSULT-III Function (BCM - COMMON ITEM)

INFOID:000000003728540

#### APPLICATION ITEM

CONSULT-III performs the following functions via CAN communication with BCM.

Diagnosis mode	Function Description
Work Support	Changes the setting for each system function.
Self Diagnostic Result	Displays the diagnosis results judged by BCM.
CAN Diag Support Monitor	Monitors the reception status of CAN communication viewed from BCM. Refer to CONSULT-III operation manual.
Data Monitor	The BCM input/output signals are displayed.
Active Test	The signals used to activate each device are forcibly supplied from BCM.
Ecu Identification	The BCM part number is displayed.
Configuration	<ul style="list-style-type: none"> <li>Read and save the vehicle specification.</li> <li>Write the vehicle specification when replacing BCM.</li> </ul>

#### SYSTEM APPLICATION

BCM can perform the following functions for each system.

#### NOTE:

It can perform the diagnosis modes except the following for all sub system selection items.

×: Applicable item

System	Sub system selection item	Diagnosis mode		
		Work Support	Data Monitor	Active Test
Door lock	DOOR LOCK	×	×	×
Rear window defogger	REAR DEFOGGER		×	×
Warning chime	BUZZER		×	×
Interior room lamp timer	INT LAMP	×	×	×
Exterior lamp	HEAD LAMP	×	×	×
Wiper and washer	WIPER		×	×
Turn signal and hazard warning lamps	FLASHER	×	×	×
—	AIR CONDITONER*			
<ul style="list-style-type: none"> <li>Intelligent Key system</li> <li>Engine start system</li> </ul>	INTELLIGENT KEY	×	×	×
Combination switch	COMB SW		×	
Body control system	BCM	×		
IVIS - NATS	IMMU		×	×
Interior room lamp battery saver	BATTERY SAVER	×	×	×
—	TRUNK*		×	×
Vehicle security system	THEFT ALM	×	×	×
RAP system	RETAINED PWR		×	
Signal buffer system	SIGNAL BUFFER		×	×
TPMS	TPMS (AIR PRESSURE MONITOR)	×	×	×

#### NOTE:

\*: This item is displayed, but is not used.

#### FREEZE FRAME DATA (FFD) AND IGN COUNTER

##### Freeze Frame Data

# DIAGNOSIS SYSTEM (BCM)

## [POWER DISTRIBUTION SYSTEM]

### < FUNCTION DIAGNOSIS >

The BCM records the following condition at the moment a particular DTC is detected.

- Vehicle Speed
- Odd Trip Meter
- Vehicle Condition (BCM detected condition)

CONSULT screen terms	Description
SLEEP>LOCK	While turning BCM status from low power consumption mode to normal mode (Power supply position is "LOCK")
SLEEP>OFF	While turning BCM status from low power consumption mode to normal mode (Power supply position is "OFF".)
LOCK>ACC	While turning power supply position from "LOCK" to "ACC"
ACC>ON	While turning power supply position from "ACC" to "IGN"
RUN>ACC	While turning power supply position from "RUN" to "ACC" (Vehicle is stopping and selector lever is except P position.)
CRANK>RUN	While turning power supply position from "CRANKING" to "RUN" (From cranking up the engine to run it)
RUN>URGENT	While turning power supply position from "RUN" to "ACC" (Emergency stop operation)
ACC>OFF	While turning power supply position from "ACC" to "OFF"
OFF>LOCK	While turning power supply position from "OFF" to "LOCK"
OFF>ACC	While turning power supply position from "OFF" to "ACC"
ON>CRANK	While turning power supply position from "IGN" to "CRANKING"
OFF>SLEEP	While turning BCM status from normal mode (Power supply position is "OFF".) to low power consumption mode
LOCK>SLEEP	While turning BCM status from normal mode (Power supply position is "LOCK".) to low power consumption mode
LOCK	Power supply position is "LOCK" (Ignition switch OFF with steering is locked.)
OFF	Power supply position is "OFF" (Ignition switch OFF with steering is unlocked.)
ACC	Power supply position is "ACC" (Ignition switch ACC)
ON	Power supply position is "IGN" (Ignition switch ON with engine stopped)
ENGINE RUN	Power supply position is "RUN" (Ignition switch ON with engine running)
CRANKING	Power supply position is "CRANKING" (At engine cranking)

### IGN Counter

IGN counter indicates the number of times that ignition switch is turned ON after DTC is detected.

- The number is 0 when a malfunction is detected now.
- The number increases like 1 → 2 → 3...38 → 39 after returning to the normal condition whenever ignition switch OFF → ON.
- The number is fixed to 39 until the self-diagnosis results are erased if it is over 39.

### INTELLIGENT KEY

### INTELLIGENT KEY : CONSULT-III Function (BCM - INTELLIGENT KEY)

INFOID:000000003743933

### BCM CONSULT-III FUNCTION

CONSULT-III performs the following functions via CAN communication with BCM.

Diagnosis mode	Function Description
WORK SUPPORT	Changes the setting for each system function.
SELF-DIAG RESULTS	Displays the diagnosis results judged by BCM.
DATA MONITOR	The BCM input/output signals are displayed.
ACTIVE TEST	The signals used to activate each device are forcibly supplied from BCM.

### WORK SUPPORT

# DIAGNOSIS SYSTEM (BCM)

< FUNCTION DIAGNOSIS >

[POWER DISTRIBUTION SYSTEM]

Monitor item	Description
REMO CONT ID CONFIR	It can be checked whether Intelligent Key ID code is registered or not in this mode.
AUTO LOCK SET	Auto door lock time can be changed in this mode. <ul style="list-style-type: none"> <li>• MODE 1: 1 minute</li> <li>• MODE 2: 5 minutes</li> <li>• MODE 3: 30 seconds</li> <li>• MODE 4: 2 minutes</li> </ul>
LOCK/UNLOCK BY I-KEY	Door lock/unlock function by door request switch (driver side, passenger side and back door) mode can be changed to operate (ON) or not operate (OFF) in this mode.
ENGINE START BY I-KEY	Engine start function mode can be changed to operate (ON) or not operate (OFF) with this mode.
TRUNK/GLASS HATCH OPEN	Buzzer reminder function mode by back door request switch can be changed to operate (ON) or not operate (OFF) with this mode.
PANIC ALARM SET	Panic alarm button pressing time on Intelligent Key remote control button can be selected from the following with this mode. <ul style="list-style-type: none"> <li>• MODE 1: 0.5 sec.</li> <li>• MODE 2: Non-operation</li> <li>• MODE 3: 1.5 sec.</li> </ul>
PW DOWN SET	Unlock button pressing time on Intelligent Key button can be selected from the following with this mode. <ul style="list-style-type: none"> <li>• MODE 1: 3 sec.</li> <li>• MODE 2: Non-operation</li> <li>• MODE 3: 5 sec.</li> </ul>
TRUNK OPEN DELAY	<b>NOTE:</b> This item is displayed, but cannot be supported.
LO- BATT OF KEY FOB WARN	Intelligent Key low battery warning mode can be changed to operate (ON) or not operate (OFF) with this mode.
ANTI KEY LOCK IN FUNCTI	Key reminder function mode can be changed to operate (ON) or not operate (OFF) with this mode.
HAZARD ANSWER BACK	Hazard reminder function mode can be selected from the following with this mode. <ul style="list-style-type: none"> <li>• LOCK ONLY: Door lock operation only</li> <li>• UNLOCK ONLY: Door unlock operation only</li> <li>• LOCK/UNLOCK: Lock/unlock operation</li> <li>• OFF: Non-operation</li> </ul>
ANS BACK I-KEY LOCK	Buzzer reminder function (lock operation) mode by door request switch (driver side and passenger side) can be selected from the following with this mode. <ul style="list-style-type: none"> <li>• Horn chirp: Sound horn</li> <li>• Buzzer: Sound Intelligent Key warning buzzer</li> <li>• OFF: Non-operation</li> </ul>
ANS BACK I-KEY UNLOCK	Buzzer reminder function (unlock operation) mode by door request switch can be changed to operate (ON) or not operate (OFF) with this mode.
SHORT CRANKING OUTPUT	Starter motor can operate during the times below. <ul style="list-style-type: none"> <li>• 70 msec</li> <li>• 100 msec</li> <li>• 200 msec</li> </ul>
INSIDE ANT DIAGNOSIS	This function allows inside key antenna self-diagnosis.
HORN WITH KEYLESS LOCK	Horn reminder function mode by Intelligent Key button can be changed to operate (ON) or not operate (OFF) with this mode.

## SELF-DIAG RESULT

Refer to [PCS-109, "DTC Index"](#).

## DATA MONITOR

Monitor Item	Condition
REQ SW -DR	Indicates [ON/OFF] condition of door request switch (driver side).
REQ SW -AS	Indicates [ON/OFF] condition of door request switch (passenger side).
REQ SW -RR	<b>NOTE:</b> This item is displayed, but cannot be monitored.

# DIAGNOSIS SYSTEM (BCM)

## < FUNCTION DIAGNOSIS >

## [POWER DISTRIBUTION SYSTEM]

Monitor Item	Condition	
REQ SW -RL	<b>NOTE:</b> This item is displayed, but cannot be monitored.	A
REQ SW -BD/TR	Indicates [ON/OFF] condition of back door request switch.	B
PUSH SW	Indicates [ON/OFF] condition of push-button ignition switch.	
IGN RLY2 -F/B	Indicates [ON/OFF] condition of ignition relay 2.	
CLUCH SW	<b>NOTE:</b> This item is displayed, but cannot be monitored.	C
BRAKE SW 1	Indicates [ON/OFF] condition of brake switch.	
DETE/CANCL SW	Indicates [ON/OFF] condition of P position.	D
SFT PN/N SW	Indicates [ON/OFF] condition of P or N position.	
S/L -LOCK	Indicates [ON/OFF] condition of steering lock unit (LOCK).	E
S/L -UNLOCK	Indicates [ON/OFF] condition of steering lock unit (UNLOCK).	
S/L RELAY -F/B	Indicates [ON/OFF] condition of ignition switch.	
UNLK SEN -DR	Indicates [ON/OFF] condition of driver door UNLOCK status.	F
PUSH SW -IPDM	Indicates [ON/OFF] condition of push-button ignition switch.	
IGN RLY1 -F/B	Indicates [ON/OFF] condition of ignition relay 1.	
DETE SW -IPDM	Indicates [ON/OFF] condition of P position.	G
SFT PN -IPDM	Indicates [ON/OFF] condition of P or N position.	
SFT P -MET	Indicates [ON/OFF] condition of P position.	H
SFT N -MET	Indicates [ON/OFF] condition of N position.	
ENGINE STATE	Indicates [STOP/START/CRANK/RUN] condition of engine states.	
S/L LOCK-IPDM	Indicates [ON/OFF] condition of steering lock unit (LOCK).	I
S/L UNLK-IPDM	Indicates [ON/OFF] condition of steering lock unit (UNLOCK).	
S/L RELAY-REQ	Indicates [ON/OFF] condition of steering lock relay.	J
VEH SPEED 1	Display the vehicle speed signal received from combination meter by numerical value [Km/h].	
VEH SPEED 2	Display the vehicle speed signal received from ABS or VDC or CVT by numerical value [Km/h].	
DOOR STAT-DR	Indicates [LOCK/READY/UNLOCK] condition of driver side door status.	K
DOOR STAT-AS	Indicates [LOCK/READY/UNLOCK] condition of passenger side door status.	
ID OK FLAG	Indicates [SET/RESET] condition of key ID.	L
PRMT ENG STRT	Indicates [SET/RESET] condition of engine start possibility.	
PRMT RKE STRT	<b>NOTE:</b> This item is displayed, but cannot be monitored.	PCS
KEY SW -SLOT	Indicates [ON/OFF] condition of key slot.	
TRNK/HAT MNTR	<b>NOTE:</b> This item is displayed, but cannot be monitored.	N
RKE-LOCK	Indicates [ON/OFF] condition of LOCK signal from Intelligent Key.	
RKE-UNLOCK	Indicates [ON/OFF] condition of UNLOCK signal from Intelligent Key.	O
RKE-TR/BD	<b>NOTE:</b> This item is displayed, but cannot be monitored.	
RKE-PANIC	Indicates [ON/OFF] condition of PANIC button of Intelligent Key.	P
RKE-P/W OPEN	Indicates [ON/OFF] condition of P/W DOWN signal from Intelligent Key.	
RKE-MODE CHG	Indicates [ON/OFF] condition of MODE CHANGE signal from Intelligent Key.	
RKE OPE COUN1	When remote keyless entry receiver receives the signal transmitted while operating on Intelligent Key, the numerical value start changing.	
RKE OPE COUN2	<b>NOTE:</b> This item is displayed, but cannot be monitored.	

# DIAGNOSIS SYSTEM (BCM)

[POWER DISTRIBUTION SYSTEM]

< FUNCTION DIAGNOSIS >

## ACTIVE TEST

Test item	Description
BATTERY SAVER	This test is able to check interior room lamp operation. The interior room lamp will be activated after "ON" on CONSULT-III screen is touched.
PW REMOTO DOWN SET	This test is able to check power window down operation. The power window down will be activated after "ON" on CONSULT-III screen is touched.
INSIDE BUZZER	This test is able to check warning chime in combination meter operation. <ul style="list-style-type: none"> <li>• Take away warning chime sounds when "TAKE OUT" on CONSULT-III screen is touched.</li> <li>• Key warning chime sounds when "KEY WARN" on CONSULT-III screen is touched.</li> <li>• P position warning chime sounds when "P RNG WARN" on CONSULT-III screen is touched.</li> <li>• ACC warning chime sounds when "ACC WARN" on CONSULT-III screen is touched.</li> </ul>
OUTSIDE BUZZER	This test is able to check Intelligent Key warning buzzer operation. The Intelligent Key warning buzzer will be activated after "ON" on CONSULT-III screen is touched.
INDICATOR	This test is able to check warning lamp operation. <ul style="list-style-type: none"> <li>• "KEY" Warning lamp illuminates when "RED ON" on CONSULT-III screen is touched.</li> <li>• "KEY" Warning lamp flashes when "RED IND" on CONSULT-III screen is touched.</li> </ul>
INT LAMP	This test is able to check interior room lamp operation. The interior room lamp will be activated after "ON" on CONSULT-III screen is touched.
LCD	This test is able to check meter display information <ul style="list-style-type: none"> <li>• Engine start information displays when "B&amp;P N" on CONSULT-III screen is touched.</li> <li>• Engine start information displays when "B&amp;P I" on CONSULT-III screen is touched.</li> <li>• Key ID warning displays when "ID NG" on CONSULT-III screen is touched.</li> <li>• Steering lock information displays when "ROTAT" on CONSULT-III screen is touched.</li> <li>• P position warning displays when "SFT P" on CONSULT-III screen is touched.</li> <li>• Intelligent Key insert information displays when "INSRT" on CONSULT-III screen is touched.</li> <li>• Intelligent Key low battery warning displays when "BATT" on CONSULT-III screen is touched.</li> <li>• Take away through window warning displays when "NO KY" on CONSULT-III screen is touched.</li> <li>• Take away warning display when "OUTKY" on CONSULT-III screen is touched.</li> <li>• OFF position warning display when "LK WN" on CONSULT-III screen is touched.</li> </ul>
TRUNK/GLASS HATCH	This test is able to check back door opener actuator open operation. This actuator opens when "ON" on CONSULT-III screen is touched.
FLASHER	This test is able to check security hazard lamp operation. The hazard lamps will be activated after "ON" on CONSULT-III screen is touched.
HORN	This test is able to check horn operation. The horn will be activated after "ON" on CONSULT-III screen is touched.
IGN CONT2	This test is able to check ignition relay operation. The ignition relay will be activated after "ON" on CONSULT-III screen is touched.
P RANGE	This test is able to check control device power supply Control device power is supplied when "ON" on CONSULT-III screen is touched.
ENGINE SW ILLUMI	This test is able to check push-ignition switch illumination operation. Push-ignition switch illumination illuminates when "ON" on CONSULT-III screen is touched.
LOCK INDICATOR	This test is able to check LOCK indicator in push-ignition switch operation. LOCK indicator in push-ignition switch illuminates when "ON" on CONSULT-III screen is touched.
ACC INDICATOR	This test is able to check ACC indicator in push-ignition switch operation. ACC indicator in push-ignition switch illuminates when "ON" on CONSULT-III screen is touched.
IGNITION ON IND	This test is able to check ON indicator in push-ignition switch operation. ON Indicator in push-ignition switch illuminates when "ON" on CONSULT-III screen is touched.
KEY SLOT ILLUMI	This test is able to check key slot illumination operation. Key slot illumination flash when "ON" on CONSULT-III screen is touched.
AUTOMATIC BACK DOOR	<b>NOTE:</b> This item is displayed, but cannot be tested.
AUTOMATIC SLIDING DOOR	<b>NOTE:</b> This item is displayed, but cannot be tested.

# COMPONENT DIAGNOSIS

## U1000 CAN COMM CIRCUIT

### Description

INFOID:000000003657653

CAN (Controller Area Network) is a serial communication line for real time applications. It is an on-vehicle multiplex communication line with high data communication speed and excellent error detection ability. Modern vehicle is equipped with many electronic control unit, and each control unit shares information and links with other control units during operation (not independent). In CAN communication, control units are connected with 2 communication lines (CAN H-line, CAN L-line) allowing a high rate of information transmission with less wiring. Each control unit transmits/receives data but selectively reads required data only.  
 CAN Communication Signal Chart. Refer to [LAN-27, "CAN Communication Signal Chart"](#).

### DTC Logic

INFOID:000000003657654

### DTC DETECTION LOGIC

DTC	CONSULT-III display description	DTC Detection Condition	Possible cause
U1000	CAN COMM CIRCUIT	When BCM cannot communicate CAN communication signal continuously for 2 seconds or more.	CAN communication system

### Diagnosis Procedure

INFOID:000000003657655

#### 1.PERFORM SELF DIAGNOSTIC

1. Turn ignition switch ON and wait for 2 seconds or more.
2. Check "Self Diagnostic Result".

Is "U1000: CAN COMM CIRCUIT" displayed?

- YES >> Refer to [LAN-18, "Trouble Diagnosis Flow Chart"](#).
- NO >> Refer to [GI-38, "Intermittent Incident"](#).

A  
B  
C  
D  
E  
F  
G  
H  
I  
J  
K  
L  
N  
O  
P

PCS

# U1010 CONTROL UNIT (CAN)

< COMPONENT DIAGNOSIS >

[POWER DISTRIBUTION SYSTEM]

## U1010 CONTROL UNIT (CAN)

### DTC Logic

INFOID:000000003657656

### DTC DETECTION LOGIC

DTC	CONSULT-III display description	DTC Detection Condition	Possible cause
U1010	CONTROL UNIT (CAN)	BCM detected internal CAN communication circuit malfunction.	BCM

### Diagnosis Procedure

INFOID:000000003657657

#### 1.REPLACE BCM

When DTC "U1010: CONTROL UNIT (CAN)" is detected, replace BCM.

>> Replace BCM. Refer to [BCS-84. "Exploded View"](#).

### Special Repair Requirement

INFOID:000000003657658

#### 1.REQUIRED WORK WHEN REPLACING BCM

Initialize control unit. Refer to CONSULT-III operation manual NATS-IVIS/NVIS.

>> Work end.



# B2553 IGNITION RELAY

< COMPONENT DIAGNOSIS >

[POWER DISTRIBUTION SYSTEM]

## B2553 IGNITION RELAY

### Description

INFOID:000000003657659

BCM turns ON the following relays to ignition power supply to each ECU when the ignition switch is turned ON.

- Ignition relay (inserted into fuse block)
- Ignition relay (built into IPDM E/R)
- Blower relay

BCM checks any ignition relay ON request for consistency with the actual ignition relay operation status.

### DTC Logic

INFOID:000000003657660

### DTC DETECTION LOGIC

DTC No.	Trouble diagnosis name	DTC detecting condition	Possible cause
B2553	IGNITION RELAY	BCM detects a difference of signal for 2 seconds or more between the following information. <ul style="list-style-type: none"> <li>• Ignition relay (fuse block) ON/OFF operation</li> <li>• Ignition relay (fuse block) feedback.</li> </ul>	<ul style="list-style-type: none"> <li>• Harness or connectors (ignition relay feedback circuit is open or short)</li> <li>• IPDM E/R</li> </ul>

### DTC CONFIRMATION PROCEDURE

#### 1. PERFORM DTC CONFIRMATION PROCEDURE

1. Turn ignition switch ON under the following conditions (start the engine), and wait for at least 2 seconds.
  - Selector lever is in the P or N position.
  - Do not depress brake pedal.
2. Check "Self diagnostic result" with CONSULT-III.

#### Is DTC detected?

- YES >> Go to [PCS-49, "Diagnosis Procedure"](#).  
 NO >> INSPECTION END

### Diagnosis Procedure

INFOID:000000003657661

#### 1. CHECK DTC WITH IPDM E/R

Check "Self diagnostic result" with CONSULT-III. Refer to [PCS-123, "DTC Index"](#).

#### Is the inspection result normal?

- YES >> GO TO 2.  
 NO >> Repair or replace malfunctioning parts.

#### 2. CHECK IGNITION RELAY FEEDBACK INPUT SIGNAL

1. Turn ignition switch OFF.
2. Disconnect BCM connector.
3. Check voltage between BCM harness connector and ground.

(+)		(-)	Condition	Voltage (V) (Approx.)	
BCM					
Connector	Terminal				
M123	123	Ground	Ignition switch	OFF	0
				ON	Battery voltage

#### Is the inspection result normal?

- YES >> GO TO 4.  
 NO >> GO TO 3.

#### 3. CHECK IGNITION RELAY FEEDBACK CIRCUIT

1. Disconnect IPDM E/R connector.

## B2553 IGNITION RELAY

< COMPONENT DIAGNOSIS >

[POWER DISTRIBUTION SYSTEM]

2. Check continuity between BCM harness connector and IPDM E/R harness connector.

BCM		IPDM E/R		Continuity
Connector	Terminal	Connector	Terminal	
M123	123	E5	19	Existed

3. Check continuity between BCM harness connector and ground.

BCM		Ground	Continuity
Connector	Terminal		
M123	123		Not existed

Is the inspection result normal?

YES >> Replace IPDM E/R. Refer to [PCS-34, "Removal and Installation"](#).

NO >> Repair or replace harness or connector.

### 4. CHECK INTERMITTENT INCIDENT

Refer to [GI-38, "Intermittent Incident"](#).

>> INSPECTION END

# B260A IGNITION RELAY

< COMPONENT DIAGNOSIS >

[POWER DISTRIBUTION SYSTEM]

## B260A IGNITION RELAY

### Description

INFOID:000000003657662

BCM turns ON the following relays to ignition power supply to each ECU when the ignition switch is turned ON.

- Ignition relay (inserted into fuse block)
- Ignition relay (built into IPDM E/R)
- Blower fan motor relay

BCM checks any ignition relay ON request for consistency with the actual ignition relay operation status.

### DTC Logic

INFOID:000000003657663

### DTC DETECTION LOGIC

#### NOTE:

- If DTC B260A is displayed with DTC U1000, first perform the trouble diagnosis for DTC U1000. Refer to [PCS-47, "DTC Logic"](#).
- If DTC B260A is displayed with DTC U1010, first perform the trouble diagnosis for DTC U1010. Refer to [PCS-48, "DTC Logic"](#).
- If DTC B260A is displayed with DTC B261A, first perform the trouble diagnosis for DTC B261A. Refer to [PCS-62, "DTC Logic"](#).

DTC No.	Trouble diagnosis name	DTC detecting condition	Possible cause
B260A	IGNITION RELAY	BCM detects a difference of signal for 2 second or more between the following information. <ul style="list-style-type: none"> <li>• Ignition relay (IPDM E/R) operation request</li> <li>• Ignition relay feedback from IPDM E/R (CAN).</li> </ul>	<ul style="list-style-type: none"> <li>• Harness or connectors (Ignition relay operation circuit is open or shorted.)</li> <li>• IPDM E/R</li> </ul>

### DTC CONFIRMATION PROCEDURE

#### 1. PERFORM DTC CONFIRMATION PROCEDURE

1. Turn ignition switch ON under the following conditions, and wait for at least 2 seconds.
  - Selector lever is in the P or N position.
  - Do not depress brake pedal.
2. Check "Self diagnostic result" with CONSULT-III.

#### Is DTC detected?

- YES >> Go to [PCS-51, "Diagnosis Procedure"](#).  
 NO >> INSPECTION END

### Diagnosis Procedure

INFOID:000000003657664

#### 1. CHECK DTC WITH IPDM E/R

Check "Self diagnostic result" with CONSULT-III. Refer to [PCS-123, "DTC Index"](#).

#### Is DTC detected?

- YES >> Repair or replace the malfunctioning parts.  
 NO >> GO TO 2.

#### 2. CHECK IGNITION RELAY INPUT SIGNAL

1. Turn ignition switch OFF.
2. Disconnect BCM connector.
3. Check voltage between BCM harness connector and ground.

(+)		(-)	Voltage (V) (Approx.)
BCM			
Connector	Terminal		
M121	47	Ground	Battery voltage

Is the inspection result normal?

# B260A IGNITION RELAY

< COMPONENT DIAGNOSIS >

[POWER DISTRIBUTION SYSTEM]

- YES >> GO TO 4.  
NO >> GO TO 3.

## 3. CHECK IGNITION RELAY (IPDM E/R) CIRCUIT

1. Disconnect IPDM E/R connector.
2. Check continuity between IPDM E/R harness connector and BCM harness connector.

IPDM E/R		BCM		Continuity
Connector	Terminal	Connector	Terminal	
E5	27	M121	47	Existed

3. Check continuity between IPDM E/R harness connector and ground.

IPDM E/R		Ground	Continuity
Connector	Terminal		
E5	27		Not existed

Is the inspection result normal?

- YES >> Replace IPDM E/R. Refer to [PCS-34. "Removal and Installation"](#).  
NO >> Repair or replace harness or connector.

## 4. CHECK INTERMITTENT INCIDENT

Refer to [GI-38. "Intermittent Incident"](#).

>> INSPECTION END

# B2614 ACC RELAY

< COMPONENT DIAGNOSIS >

[POWER DISTRIBUTION SYSTEM]

## B2614 ACC RELAY

### Description

INFOID:000000003739081

BCM controls the various electrical components and simultaneously supplies power according to the power supply position.  
BCM checks the power supply position internally.

### DTC Logic

INFOID:000000003739082

### DTC DETECTION LOGIC

DTC No.	Trouble diagnosis name	DTC detecting condition	Possible cause
B2614	ACC relay	An immediate operation of ACC relay is requested by BCM, but there is no response for more than 1 second.	<ul style="list-style-type: none"> <li>Harness or connectors (ACC relay circuit is open or shorted)</li> <li>ACC relay</li> </ul>

### DTC CONFIRMATION PROCEDURE

#### 1. PERFORM DTC CONFIRMATION PROCEDURE

- Turn the power supply position to ACC under the following conditions, and wait for at least 1 second.
  - Selector lever is in the P or N position.
  - Do not depress brake pedal.
- Check "Self diagnostic result" with CONSULT-III.

#### Is DTC detected?

- YES >> Go to [PCS-53, "Diagnosis Procedure"](#).  
NO >> INSPECTION END

### Diagnosis Procedure

INFOID:000000003739083

#### 1. CHECK ACCESSORY RELAY POWER SUPPLY

- Turn ignition switch OFF.
- Disconnect accessory relay.
- Check voltage between accessory relay harness connector and ground.

(+)	(-)	Condition	Voltage (V) (Approx.)
Accessory relay Terminal			
1	Ground	Ignition switch	0
			Battery voltage

#### Is the inspection result normal?

- YES >> GO TO 3.  
NO >> GO TO 2.

#### 2. CHECK ACCESSORY RELAY POWER SUPPLY CIRCUIT

- Turn ignition switch OFF.
- Disconnect BCM connector.
- Check continuity between accessory relay harness connector and BCM harness connector.

Accessory relay Terminal	BCM		Continuity
	Connector	Terminal	
1	M122	95	Existed

- Check continuity between accessory relay harness connector and ground.

# B2614 ACC RELAY

< COMPONENT DIAGNOSIS >

[POWER DISTRIBUTION SYSTEM]

Accessory relay	Ground	Continuity
Terminal		
1		Not existed

Is the inspection result normal?

YES >> Replace BCM. Refer to [PCS-130, "Removal and Installation"](#).

NO >> Repair or replace harness or connector.

## 3.CHECK ACCESSORY RELAY GROUND CIRCUIT

Check continuity between accessory relay harness connector and ground.

Accessory relay	Ground	Continuity
Terminal		
2		Existed

Is the inspection result normal?

YES >> GO TO 4.

NO >> Repair accessory relay ground circuit.

## 4.CHECK ACCESSORY RELAY

Refer to [PCS-54, "Component Inspection"](#).

Is the inspection result normal?

YES >> GO TO 5.

NO >> Replace accessory relay.

## 5.CHECK INTERMITTENT INCIDENT

Refer to [GI-38, "Intermittent Incident"](#).

>> INSPECTION END

## Component Inspection

INFOID:000000003739084

## 1.CHECK ACCESSORY RELAY

1. Turn ignition switch OFF.
2. Remove accessory relay.
3. Check the continuity between accessory relay terminals.

Terminals	Condition	Continuity
3 and 5	12 V direct current supply between terminals 1 and 2	Existed
	No current supply	Not existed

Is the inspection result normal?

YES >> INSPECTION END

NO >> Replace accessory relay.

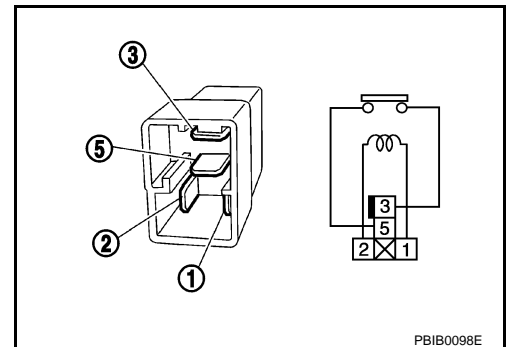

PBIB0098E

# B2614 ACC RELAY

< COMPONENT DIAGNOSIS >

[POWER DISTRIBUTION SYSTEM]

## B2614 ACC RELAY

### Description

INFOID:000000003739314

BCM controls the various electrical components and simultaneously supplies power according to the power supply position.  
BCM checks the power supply position internally.

### DTC Logic

INFOID:000000003739315

### DTC DETECTION LOGIC

DTC No.	Trouble diagnosis name	DTC detecting condition	Possible cause
B2614	ACC relay	An immediate operation of ACC relay is requested by BCM, but there is no response for more than 1 second.	<ul style="list-style-type: none"> <li>Harness or connectors (ACC relay circuit is open or shorted)</li> <li>ACC relay</li> </ul>

### DTC CONFIRMATION PROCEDURE

#### 1. PERFORM DTC CONFIRMATION PROCEDURE

- Turn the power supply position to ACC under the following conditions, and wait for at least 1 second.
  - Selector lever is in the P or N position.
  - Do not depress brake pedal.
- Check "Self diagnostic result" with CONSULT-III.

#### Is DTC detected?

- YES >> Go to [PCS-55, "Diagnosis Procedure"](#).  
NO >> INSPECTION END

### Diagnosis Procedure

INFOID:000000003739316

#### 1. CHECK ACCESSORY RELAY POWER SUPPLY

- Turn ignition switch OFF.
- Disconnect accessory relay.
- Check voltage between accessory relay harness connector and ground.

(+)	(-)	Condition	Voltage (V) (Approx.)
Accessory relay Terminal			
1	Ground	Ignition switch	0
			Battery voltage

#### Is the inspection result normal?

- YES >> GO TO 3.  
NO >> GO TO 2.

#### 2. CHECK ACCESSORY RELAY POWER SUPPLY CIRCUIT

- Turn ignition switch OFF.
- Disconnect BCM connector.
- Check continuity between accessory relay harness connector and BCM harness connector.

Accessory relay Terminal	BCM		Continuity
	Connector	Terminal	
1	M122	95	Existed

- Check continuity between accessory relay harness connector and ground.

# B2614 ACC RELAY

< COMPONENT DIAGNOSIS >

[POWER DISTRIBUTION SYSTEM]

Accessory relay	Ground	Continuity
Terminal		
1		Not existed

Is the inspection result normal?

- YES >> Replace BCM. Refer to [PCS-130, "Removal and Installation"](#).
- NO >> Repair or replace harness or connector.

## 3.CHECK ACCESSORY RELAY GROUND CIRCUIT

Check continuity between accessory relay harness connector and ground.

Accessory relay	Ground	Continuity
Terminal		
2		Existed

Is the inspection result normal?

- YES >> GO TO 4.
- NO >> Repair accessory relay ground circuit.

## 4.CHECK ACCESSORY RELAY

Refer to [PCS-56, "Component Inspection"](#).

Is the inspection result normal?

- YES >> GO TO 5.
- NO >> Replace accessory relay.

## 5.CHECK INTERMITTENT INCIDENT

Refer to [GI-38, "Intermittent Incident"](#).

>> INSPECTION END

## Component Inspection

INFOID:000000003739317

### 1.CHECK ACCESSORY RELAY

1. Turn ignition switch OFF.
2. Remove accessory relay.
3. Check the continuity between accessory relay terminals.

Terminals	Condition	Continuity
3 and 5	12 V direct current supply between terminals 1 and 2	Existed
	No current supply	Not existed

Is the inspection result normal?

- YES >> INSPECTION END
- NO >> Replace accessory relay.

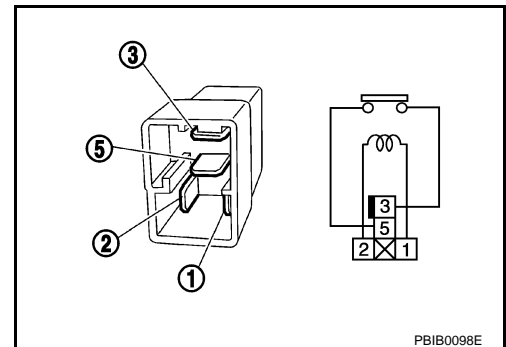

PBIB0098E



# B2615 BLOWER RELAY CIRCUIT

< COMPONENT DIAGNOSIS >

[POWER DISTRIBUTION SYSTEM]

## B2615 BLOWER RELAY CIRCUIT

### Description

INFOID:000000003739318

BCM controls the various electrical components and simultaneously supplies power according to the power supply position.  
BCM checks the power supply position internally.

### DTC Logic

INFOID:000000003739319

### DTC DETECTION LOGIC

DTC No.	Trouble diagnosis name	DTC detecting condition	Possible cause
B2615	Blower relay circuit	BCM detects a difference of signal for 1 second or more between the following information. <ul style="list-style-type: none"><li>• Blower relay ON/OFF request</li><li>• Blower relay feedback</li></ul>	<ul style="list-style-type: none"><li>• Harness or connectors (Blower relay circuit is open or shorted)</li><li>• Blower relay</li></ul>

### DTC CONFIRMATION PROCEDURE

#### 1. PERFORM DTC CONFIRMATION PROCEDURE

1. Turn ignition switch ON under the following conditions, and wait for at least 1 second.
  - Selector lever is in the P or N position
  - Do not depress brake pedal
2. Check "Self diagnostic result" with CONSULT-III.

#### Is DTC detected?

- YES >> Go to [PCS-57, "Diagnosis Procedure"](#).  
NO >> INSPECTION END

### Diagnosis Procedure

INFOID:000000003739320

#### 1. CHECK BLOWER RELAY POWER SUPPLY

1. Turn ignition switch OFF.
2. Disconnect blower relay.
3. Check voltage between blower relay harness connector and ground.

(+)	(-)	Condition	Voltage (V) (Approx.)
Blower relay Terminal			
1	Ground	Ignition switch	0
		OFF or ACC ON	Battery voltage

#### Is the inspection result normal?

- YES >> GO TO 3.  
NO >> GO TO 2.

#### 2. CHECK BLOWER RELAY POWER SUPPLY CIRCUIT

1. Turn ignition switch OFF.
2. Disconnect BCM connector.
3. Check continuity between blower relay harness connector and BCM harness connector.

Blower relay Terminal	BCM		Continuity
	Connector	Terminal	
1	M122	102	Existed

4. Check continuity between blower relay harness connector and ground.

# B2615 BLOWER RELAY CIRCUIT

< COMPONENT DIAGNOSIS >

[POWER DISTRIBUTION SYSTEM]

Blower relay	Ground	Continuity
Terminal		
1		Not existed

Is the inspection result normal?

YES >> Replace BCM. Refer to [BCS-84, "Removal and Installation"](#).

NO >> Repair or replace harness or connector.

## 3.CHECK BLOWER RELAY GROUND CIRCUIT

1. Turn ignition switch OFF.
2. Check continuity between blower relay harness connector and ground.

Blower relay	Ground	Continuity
Terminal		
2		Existed

Is the inspection result normal?

YES >> GO TO 4.

NO >> Repair blower relay ground circuit.

## 4.CHECK BLOWER RELAY

Refer to [PCS-58, "Component Inspection"](#).

Is the inspection result normal?

YES >> GO TO 5.

NO >> Replace blower relay.

## 5.CHECK INTERMITTENT INCIDENT

Refer to [GI-38, "Intermittent Incident"](#).

>> INSPECTION END

## Component Inspection

INFOID:000000003739321

## 1.CHECK BLOWER RELAY

1. Turn ignition switch OFF.
2. Remove blower relay.
3. Check the continuity between blower relay terminals.

Terminals	Condition	Continuity
3 and 5	12 V direct current supply between terminals 1 and 2	Existed
	No current supply	Not existed

Is the inspection result normal?

YES >> INSPECTION END

NO >> Replace blower relay

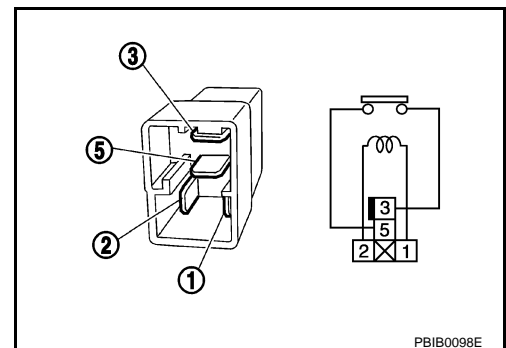

# B2616 IGNITION RELAY CIRCUIT

< COMPONENT DIAGNOSIS >

[POWER DISTRIBUTION SYSTEM]

## B2616 IGNITION RELAY CIRCUIT

### Description

INFOID:000000003739322

BCM controls the various electrical components and simultaneously supplies power according to the power supply position.  
BCM checks the power supply position internally.

### DTC Logic

INFOID:000000003739323

### DTC DETECTION LOGIC

DTC No.	Trouble diagnosis name	DTC detecting condition	Possible cause
B2616	Ignition relay circuit	An immediate operation of ignition relay (fuse block) is requested by BCM, but there is no response for more than 1 second	<ul style="list-style-type: none"><li>• Harness or connectors (Ignition relay circuit is open or shorted)</li><li>• Ignition relay (Fuse block)</li></ul>

### DTC CONFIRMATION PROCEDURE

#### 1. PERFORM DTC CONFIRMATION PROCEDURE

1. Turn ignition switch ON under the following conditions, and wait for at least 1 second.
  - Selector lever is in the P or N position.
  - Do not depress brake pedal.
2. Check "Self diagnostic result" with CONSULT-III.

#### Is DTC detected?

- YES >> Go to [PCS-59, "Diagnosis Procedure"](#).  
NO >> INSPECTION END

### Diagnosis Procedure

INFOID:000000003739324

#### 1. CHECK IGNITION RELAY POWER SUPPLY

1. Turn ignition switch OFF.
2. Disconnect ignition relay.
3. Check voltage between ignition relay harness connector and ground.

(+)	(-)	Condition	Voltage (V) (Approx.)
Ignition relay Terminal			
1	Ground	Ignition switch	0
		OFF or ACC ON	Battery voltage

#### Is the inspection result normal?

- YES >> GO TO 3.  
NO >> GO TO 2.

#### 2. CHECK IGNITION RELAY POWER SUPPLY CIRCUIT

1. Turn ignition switch OFF.
2. Disconnect BCM connector.
3. Check continuity between ignition relay harness connector and BCM harness connector.

Ignition relay Terminal	BCM		Continuity
	Connector	Terminal	
1	M122	82	Existed

4. Check continuity between ignition relay harness connector and ground.

# B2616 IGNITION RELAY CIRCUIT

< COMPONENT DIAGNOSIS >

[POWER DISTRIBUTION SYSTEM]

Ignition relay	Ground	Continuity
Terminal		
1		Not existed

Is the inspection result normal?

- YES >> Replace BCM. Refer to [BCS-84, "Removal and Installation"](#).  
 NO >> Repair or replace harness or connector.

## 3.CHECK IGNITION RELAY GROUND CIRCUIT

- Turn ignition switch OFF.
- Check continuity between ignition relay harness connector and ground.

Ignition relay	Ground	Continuity
Terminal		
2		Existed

Is the inspection result normal?

- YES >> GO TO 4.  
 NO >> Repair ignition relay ground circuit.

## 4.CHECK IGNITION RELAY

Refer to [PCS-60, "Component Inspection"](#).

Is the inspection result normal?

- YES >> GO TO 5.  
 NO >> Replace ignition relay.

## 5.CHECK INTERMITTENT INCIDENT

Refer to [GI-38, "Intermittent Incident"](#).

>> INSPECTION END

## Component Inspection

INFOID:000000003739325

## 1.CHECK IGNITION RELAY

- Turn ignition switch OFF.
- Remove ignition relay.
- Check the continuity between ignition relay terminals.

Terminals	Condition	Continuity
3 and 5	12 V direct current supply between terminals 1 and 2	Existed
	No current supply	Not existed

Is the inspection result normal?

- YES >> INSPECTION END  
 NO >> Replace Ignition relay

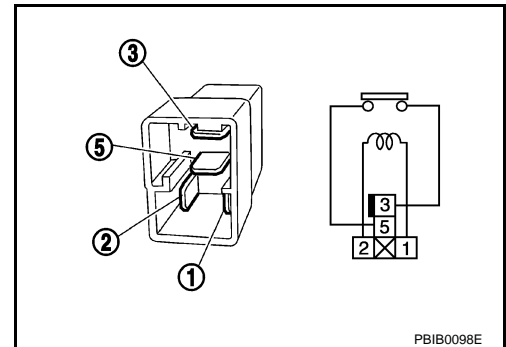

PBIB0098E

B2618 BCM

Description

INFOID:000000003657677

BCM controls the various electrical components and simultaneously supplies power according to the power supply position.  
 BCM checks the power supply position internally.

DTC Logic

INFOID:000000003657678

DTC DETECTION LOGIC

NOTE:

- If DTC B2618 is displayed with DTC U1000, first perform the trouble diagnosis for DTC U1000. Refer to [PCS-47, "DTC Logic"](#).
- If DTC B2618 is displayed with DTC U1010, first perform the trouble diagnosis for DTC U1010. Refer to [PCS-48, "DTC Logic"](#).

DTC No.	Trouble diagnosis name	DTC detecting condition	Possible cause
B2618	BCM	An immediate operation of ignition relay (IPDM E/R) is requested by BCM, but there is no response for more than 1 second	BCM

DTC CONFIRMATION PROCEDURE

1. PERFORM DTC CONFIRMATION PROCEDURE

1. Turn ignition switch ON under the following conditions, and wait for at least 1 second.
  - Selector lever is in the P or N position.
  - Do not depress brake pedal.
2. Check "Self diagnostic result" with CONSULT-III.

Is DTC detected?

- YES >> Go to [PCS-61, "Diagnosis Procedure"](#).
- NO >> INSPECTION END

Diagnosis Procedure

INFOID:000000003657679

1. INSPECTION START

1. Turn ignition switch ON.
2. Select "Self diagnostic result" mode with CONSULT-III.
3. Touch "ERASE".
4. **Perform DTC Confirmation Procedure.**  
 See [PCS-61, "DTC Logic"](#).

Is the 1st trip DTC B2618 displayed again?

- YES >> Replace BCM. Refer to [BCS-84, "Removal and Installation"](#)
- NO >> INSPECTION END

A  
B  
C  
D  
E  
F  
G  
H  
I  
J  
K  
L  
N  
O  
P

PCS

# B261A PUSH-BUTTON IGNITION SWITCH

< COMPONENT DIAGNOSIS >

[POWER DISTRIBUTION SYSTEM]

## B261A PUSH-BUTTON IGNITION SWITCH

### Description

INFOID:000000003657680

BCM transmits the change in the power supply position with the push-button ignition switch to IPDM E/R via the CAN communication line. IPDM E/R transmits the power supply position status via CAN communication line to BCM.

### DTC Logic

INFOID:000000003657681

### DTC DETECTION LOGIC

DTC No.	Trouble diagnosis name	DTC detecting condition	Possible cause
B261A	PUSH-BUTTON IGNITION SWITCH	BCM detects a difference of signal for 1 second or more between the following information. <ul style="list-style-type: none"><li>Power supply position by push-button ignition switch</li><li>Power supply position from IPDM E/R (CAN)</li></ul>	<ul style="list-style-type: none"><li>Harness or connectors (Push-button ignition switch circuit is open or shorted.)</li></ul>

### DTC CONFIRMATION PROCEDURE

#### 1.PERFORM DTC CONFIRMATION PROCEDURE

- Press the push-button ignition switch under the following conditions, and wait for at least 1 second.
  - Selector lever is in the P or N position.
  - Do not depress brake pedal.
- Check "Self diagnostic result" with CONSULT-III.

#### Is DTC detected?

- YES >> Go to [PCS-62, "Diagnosis Procedure"](#).  
NO >> INSPECTION END

### Diagnosis Procedure

INFOID:000000003657682

#### 1.CHECK PUSH-BUTTON IGNITION SWITCH OPERATION

Press push-button ignition switch and check if it turns to ON.

#### Does ignition switch turn to ON?

- YES >> GO TO 2.  
NO >> GO TO 4.

#### 2.CHECK IGNITION SWITCH OUTPUT SIGNAL (IPDM E/R)

- Disconnect push-button ignition switch connector.
- Check voltage between IPDM E/R harness connector and ground.

(+)		(-)	Voltage (V) (Approx.)
IPDM E/R			
Connector	Terminal		
E5	28	Ground	Battery voltage

#### Is the inspection result normal?

- YES >> GO TO 3.  
NO >> Replace IPDM E/R. Refer to [PCS-34, "Removal and Installation"](#).

#### 3.CHECK PUSH-BUTTON IGNITION SWITCH CIRCUIT (IPDM E/R)

- Disconnect IPDM E/R connector and BCM connector.
- Check continuity between IPDM E/R harness connector and push-button ignition switch harness connector.

# B261A PUSH-BUTTON IGNITION SWITCH

< COMPONENT DIAGNOSIS >

[POWER DISTRIBUTION SYSTEM]

IPDM E/R		Push-button ignition switch		Continuity
Connector	Terminal	Connector	Terminal	
E5	28	M50	4	Existed

3. Check continuity between IPDM E/R harness connector and ground.

IPDM E/R		Ground	Continuity
Connector	Terminal		
E5	28		Not existed

Is the inspection result normal?

YES >> GO TO 6.

NO >> Repair or replace harness or connector.

## 4.CHECK IGNITION SWITCH OUTPUT SIGNAL (BCM)

1. Disconnect push-button ignition switch connector.
2. Check voltage between BCM harness connector and ground.

(+)		(-)	Voltage (V) (Approx.)
BCM			
Connector	Terminal		
M122	89	Ground	Battery voltage

Is the inspection result normal?

YES >> GO TO 5.

NO >> Replace BCM. Refer to [PCS-130. "Removal and Installation"](#).

## 5.CHECK PUSH-BUTTON IGNITION SWITCH CIRCUIT (BCM)

1. Disconnect BCM connector and IPDM E/R connector.
2. Check continuity between BCM harness connector and push-button ignition switch harness connector.

BCM		Push-button ignition switch		Continuity
Connector	Terminal	Connector	Terminal	
M122	89	M50	4	Existed

3. Check continuity between BCM harness connector and ground.

BCM		Ground	Continuity
Connector	Terminal		
M122	89		Not existed

Is the inspection result normal?

YES >> GO TO 6.

NO >> Repair or replace harness or connector.

## 6.CHECK INTERMITTENT INCIDENT

Refer to [GI-38. "Intermittent Incident"](#).

>> INSPECTION END

A  
B  
C  
D  
E  
F  
G  
H  
I  
J  
K  
L  
N  
O  
P

PCS

# POWER SUPPLY AND GROUND CIRCUIT

< COMPONENT DIAGNOSIS >

[POWER DISTRIBUTION SYSTEM]

## POWER SUPPLY AND GROUND CIRCUIT

### BCM

#### BCM : Diagnosis Procedure

INFOID:000000003657683

#### 1. CHECK FUSE AND FUSIBLE LINK

Check that the following fuse and fusible link are not blown.

Signal name	Fuse and fusible link No.
Battery power supply	K
	10

#### Is the fuse fusing?

- YES >> Replace the blown fuse or fusible link after repairing the affected circuit if a fuse or fusible link is blown.  
NO >> GO TO 2.

#### 2. CHECK POWER SUPPLY CIRCUIT

1. Turn ignition switch OFF.
2. Disconnect BCM connectors.
3. Check voltage between BCM harness connector and ground.

(+)		(-)	Voltage (V) (Approx.)
BCM			
Connector	Terminal	Ground	Battery voltage
M118	1		
M119	11		

#### Is the measurement value normal?

- YES >> GO TO 3.  
NO >> Repair or replace harness or connector.

#### 3. CHECK GROUND CIRCUIT

Check continuity between BCM harness connector and ground.

BCM		Ground	Continuity
Connector	Terminal		
M119	13		Existed

#### Does continuity exist?

- YES >> INSPECTION END  
NO >> Repair or replace harness or connector.



# PUSH-BUTTON IGNITION SWITCH

< COMPONENT DIAGNOSIS >

[POWER DISTRIBUTION SYSTEM]

## PUSH-BUTTON IGNITION SWITCH

### Description

INFOID:000000003657684

BCM transmits the change in the power supply position with the push-button ignition switch to IPDM E/R via the CAN communication line. IPDM E/R transmits the power supply position status via CAN communication line to BCM.

### Component Function Check

INFOID:000000003657685

#### 1. CHECK FUNCTION

1. Select "PUSH SW" in "Data Monitor" mode with CONSULT-III.
2. Check the push-button ignition switch signal under the following condition.

Test item	Condition	Status
PUSH SW	Push-button ignition switch is pressed	ON
	Push-button ignition switch is not pressed	OFF

Is the indication normal?

- YES >> INSPECTION END  
NO >> Go to [PCS-65, "Diagnosis Procedure"](#).

### Diagnosis Procedure

INFOID:000000003657686

#### 1. CHECK PUSH-BUTTON IGNITION SWITCH OPERATION

Press push-button ignition switch and check if it turns to ON.

Does ignition switch turn to ON?

- YES >> GO TO 2.  
NO >> GO TO 4.

#### 2. CHECK IGNITION SWITCH OUTPUT SIGNAL (IPDM E/R)

1. Disconnect push-button ignition switch connector.
2. Check voltage between IPDM E/R harness connector and ground.

(+)		(-)	Voltage (V) (Approx.)
IPDM E/R			
Connector	Terminal	Ground	Battery voltage
E5	28		

Is the inspection result normal?

- YES >> GO TO 3.  
NO >> Replace IPDM E/R. Refer to [PCS-34, "Removal and Installation"](#).

#### 3. CHECK PUSH-BUTTON IGNITION SWITCH CIRCUIT (IPDM E/R)

1. Disconnect IPDM E/R connector and BCM connector.
2. Check continuity between IPDM E/R harness connector and push-button ignition switch harness connector.

IPDM E/R		Push-button ignition switch		Continuity
Connector	Terminal	Connector	Terminal	
E5	28	M50	4	Existed

3. Check continuity between IPDM E/R harness connector and ground.

IPDM E/R		Ground	Continuity
Connector	Terminal		
E5	28		Not existed

A  
B  
C  
D  
E  
F  
G  
H  
I  
J  
K  
L

PCS

N  
O  
P

# PUSH-BUTTON IGNITION SWITCH

[POWER DISTRIBUTION SYSTEM]

## < COMPONENT DIAGNOSIS >

Is the inspection result normal?

YES >> GO TO 6.

NO >> Repair or replace harness or connector.

### 4.CHECK IGNITION SWITCH OUTPUT SIGNAL (BCM)

1. Disconnect push-button ignition switch connector.
2. Check voltage between BCM harness connector and ground.

(+)		(-)	Voltage (V) (Approx.)
BCM			
Connector	Terminal	Ground	Battery voltage
M122	89		

Is the inspection result normal?

YES >> GO TO 5.

NO >> Replace BCM. Refer to [PCS-130, "Removal and Installation"](#).

### 5.CHECK PUSH-BUTTON IGNITION SWITCH CIRCUIT (BCM)

1. Disconnect BCM connector and IPDM E/R connector.
2. Check continuity between BCM harness connector and push-button ignition switch harness connector.

BCM		Push-button ignition switch		Continuity
Connector	Terminal	Connector	Terminal	
M122	89	M50	4	Existed

3. Check continuity between BCM harness connector and ground.

BCM		Ground	Continuity
Connector	Terminal		
M122	89		Not existed

Is the inspection result normal?

YES >> GO TO 6.

NO >> Repair or replace harness or connector.

### 6.CHECK INTERMITTENT INCIDENT

Refer to [GI-38, "Intermittent Incident"](#).

>> INSPECTION END

## Component Inspection

INFOID:000000003657687

### 1.CHECK PUSH-BUTTON IGNITION SWITCH

1. Turn ignition switch OFF.
2. Disconnect push-button ignition switch connector.
3. Check continuity between push-button ignition switch terminals.

Push-button ignition switch		Condition	Continuity
Terminal			
1	4	Push-button ignition switch	Pressed Existed
			Not pressed Not existed

Is the inspection result normal?

YES >> INSPECTION END.

NO >> Replace push-button ignition switch. Refer to [PCS-131, "Removal and Installation"](#).

# PUSH-BUTTON IGNITION SWITCH POSITION INDICATOR

< COMPONENT DIAGNOSIS >

[POWER DISTRIBUTION SYSTEM]

## PUSH-BUTTON IGNITION SWITCH POSITION INDICATOR

### Description

INFOID:000000003657688

The switch that changes the power supply position.

BCM maintains the power supply position status.

BCM changes the power supply position with the operation of the push-button ignition switch.

### Component Function Check

INFOID:000000003657689

#### 1. CHECK FUNCTION

Check push-button ignition switch ("LOCK INDICATOR", "ACC INDICATOR" and "IGNITION ON IND") in Active Test Mode with CONSULT-III.

Test item		Description	
LOCK INDICATOR ACC INDICATOR IGNITION ON IND	ON	Position indicator	Illuminate
	OFF		Not illuminate

Is the inspection result normal?

YES >> INSPECTION END

NO >> Refer to [PCS-67, "Diagnosis Procedure"](#).

### Diagnosis Procedure

INFOID:000000003657690

#### 1. CHECK PUSH-BUTTON IGNITION SWITCH INPUT SIGNAL

1. Turn ignition switch OFF.
2. Disconnect push-button ignition switch connector.
3. Check voltage between push-button ignition switch harness connector and ground.

(+)		(-)	Voltage (V) (Approx.)
Push-button ignition switch			
Connector	Terminal	Ground	Battery voltage
M50	8		

Is the inspection result normal?

YES >> GO TO 2.

NO >> Check the following.

- 10A fuse [No.9, located in fuse block (J/B)]
- Harness for open or short between push-button ignition switch and fuse

#### 2. CHECK PUSH-BUTTON IGNITION SWITCH CIRCUIT

1. Disconnect BCM connector and push button ignition switch connector.
2. Check continuity between BCM harness connector and push-button ignition switch harness connector.

Indicator	BCM		Push-button ignition switch		Continuity
	Connector	Terminal	Connector	Terminal	
LOCK position	M123	134	M50	5	Existed
ACC position	M119	15		6	
ON position	M122	93		7	

3. Check continuity between BCM harness connector and ground.

A  
B  
C  
D  
E  
F  
G  
H  
I  
J  
K  
L  
N  
O  
P

PCS

# PUSH-BUTTON IGNITION SWITCH POSITION INDICATOR

< COMPONENT DIAGNOSIS >

[POWER DISTRIBUTION SYSTEM]

Indicator	BCM		Ground	Continuity
	Connector	Terminal		
LOCK position	M123	134	Ground	Not existed
ACC position	M119	15		
ON position	M122	93		

Is the inspection result normal?

YES >> GO TO 3.

NO >> Repair or replace harness or connector.

## 3.CHECK PUSH-BUTTON IGNITION SWITCH

Refer to [PCS-68, "Component Inspection"](#).

Is the inspection result normal?

YES >> GO TO 4.

NO >> Replace push-button ignition switch. Refer to [PCS-131, "Removal and Installation"](#).

## 4.CHECK INTERMITTENT INCIDENT

Refer to [GI-38, "Intermittent Incident"](#).

>> INSPECTION END

## Component Inspection

INFOID:000000003657691

## 1.CHECK PUSH-BUTTON IGNITION SWITCH

1. Turn ignition switch OFF.
2. Disconnect push-button ignition switch connector.
3. Check continuity between push-button ignition switch terminals.

Terminal		Condition		Continuity
Push-button ignition switch				
8	5	Push-button ignition switch position	LOCK	Existed
	6		ACC	
	7		ON	

Is the inspection result normal?

YES >> INSPECTION END

NO >> Replace push-button ignition switch. Refer to [PCS-131, "Removal and Installation"](#).

# POWER DISTRIBUTION SYSTEM

< COMPONENT DIAGNOSIS >

[POWER DISTRIBUTION SYSTEM]

## POWER DISTRIBUTION SYSTEM

Wiring Diagram - PDS (POWER DISTRIBUTION SYSTEM) -

INFOID:000000003132062

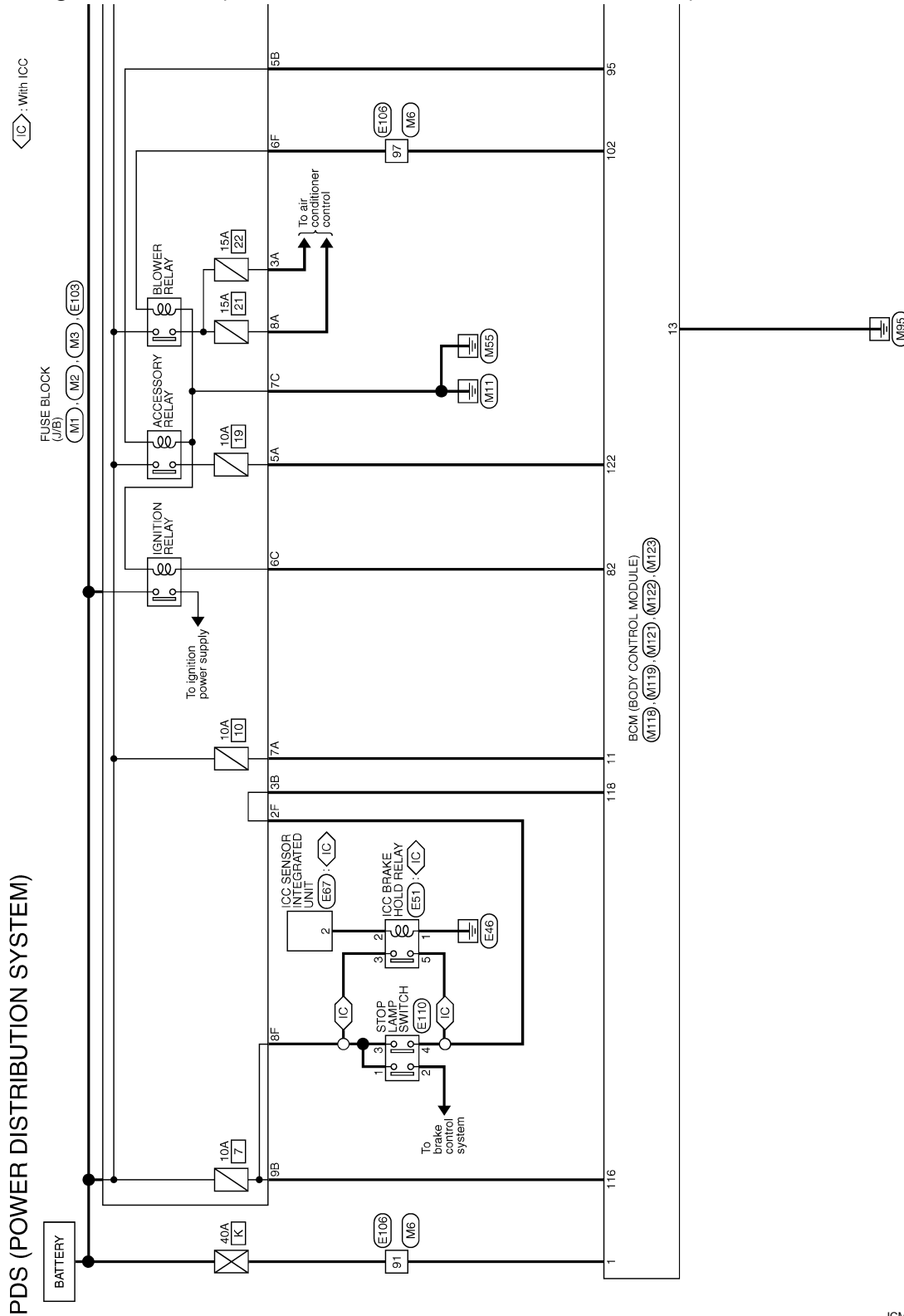

2007/10/26

JCMWM1415G1

A  
B  
C  
D  
E  
F  
G  
H  
I  
J  
K  
L  
M  
N  
O  
P

PCS

# POWER DISTRIBUTION SYSTEM

< COMPONENT DIAGNOSIS >

[POWER DISTRIBUTION SYSTEM]

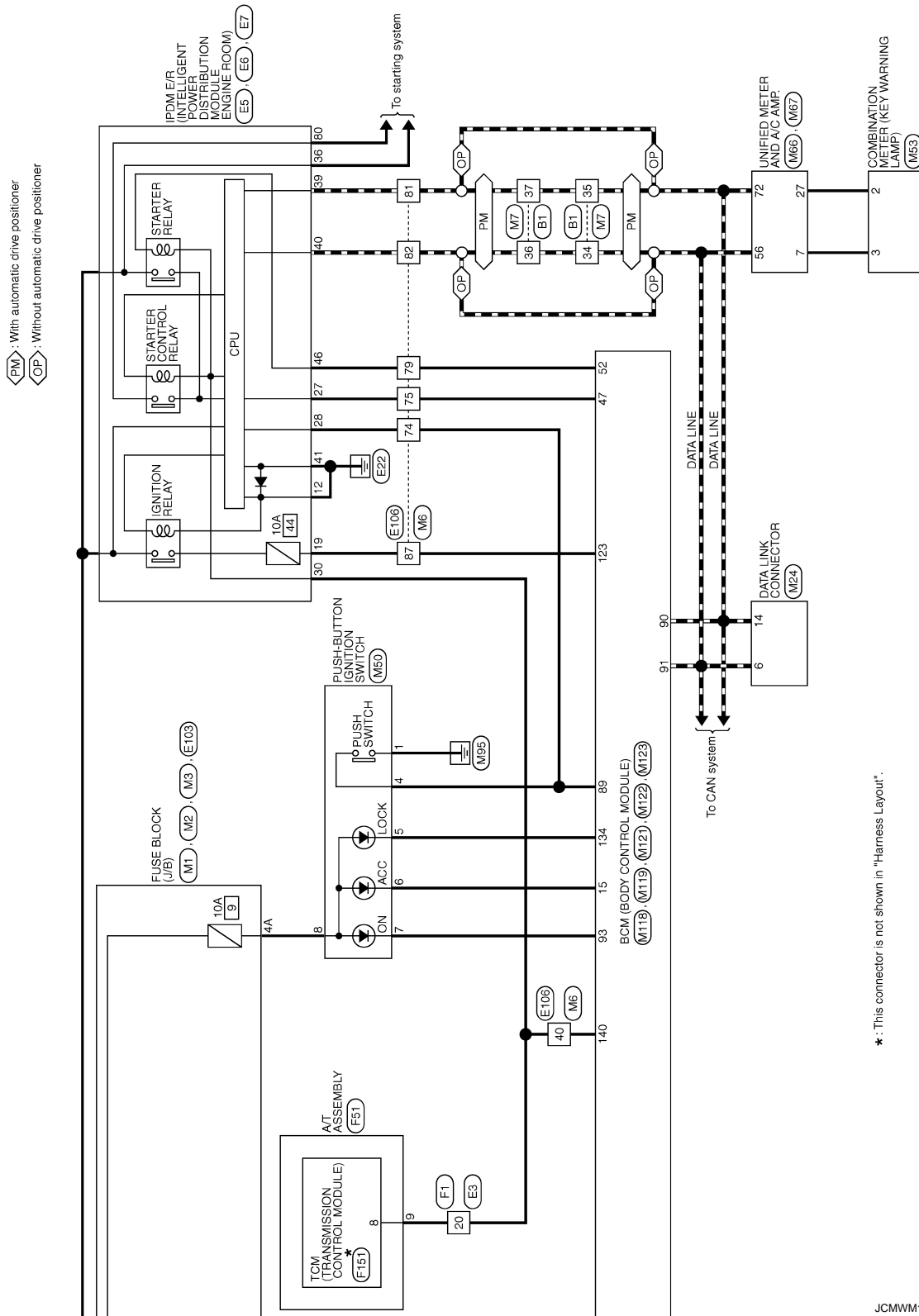

\*: This connector is not shown in "Harness Layout".







JCMWM1416G

# POWER DISTRIBUTION SYSTEM

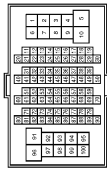
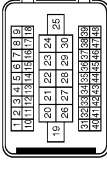
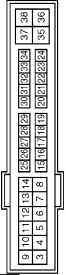
< COMPONENT DIAGNOSIS >

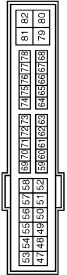
[POWER DISTRIBUTION SYSTEM]

## PDS (POWER DISTRIBUTION SYSTEM)

Connector No. B1 Connector Name WIRE TO WIRE Connector Type TH20FW-CS16-TM4 	Connector No. E3 Connector Name WIRE TO WIRE Connector Type SAA38MB-RS10-SJZZ 	Connector No. E5 Connector Name IPDM E/R (INTELLIGENT POWER DISTRIBUTION MODULE ENGINE ROOM) Connector Type TH20FW-CS12-M4-IV 	Connector No. E6 Connector Name IPDM E/R (INTELLIGENT POWER DISTRIBUTION MODULE ENGINE ROOM) Connector Type TH20FW-NH 
Terminal No. 34 Color of Wire L Signal Name [Specification] Terminal No. 35 Color of Wire P Signal Name [Specification] Terminal No. 36 Color of Wire L Signal Name [Specification] Terminal No. 37 Color of Wire P Signal Name [Specification]	Terminal No. 20 Color of Wire GR Signal Name [Specification]	Terminal No. 12 Color of Wire B/W Signal Name [Specification] Terminal No. 19 Color of Wire W Signal Name [Specification] Terminal No. 27 Color of Wire L Signal Name [Specification] Terminal No. 28 Color of Wire L Signal Name [Specification] Terminal No. 30 Color of Wire GR Signal Name [Specification] Terminal No. 38 Color of Wire G Signal Name [Specification]	Terminal No. 39 Color of Wire P Signal Name [Specification] Terminal No. 40 Color of Wire L Signal Name [Specification] Terminal No. 41 Color of Wire B/W Signal Name [Specification] Terminal No. 46 Color of Wire R Signal Name [Specification]
Connector No. E7 Connector Name IPDM E/R (INTELLIGENT POWER DISTRIBUTION MODULE ENGINE ROOM) Connector Type TH20FW-CS12-M4 	Connector No. E81 Connector Name ICC BRAKE HOLD RELAY Connector Type MS02FL-M2 	Connector No. E87 Connector Name ICC SENSOR INTEGRATED UNIT Connector Type RS08FB-PR 	Connector No. E103 Connector Name FUSE BLOCK (J/B) Connector Type NS16FW-CS 
Terminal No. 80 Color of Wire W Signal Name [Specification]	Terminal No. 1 Color of Wire B Signal Name [Specification] Terminal No. 2 Color of Wire V Signal Name [Specification] Terminal No. 3 Color of Wire O Signal Name [Specification] Terminal No. 5 Color of Wire P Signal Name [Specification]	Terminal No. 2 Color of Wire V Signal Name [Specification] BRK LMP RLY	Terminal No. 2F Color of Wire W Signal Name [Specification] Terminal No. 6F Color of Wire BR Signal Name [Specification] Terminal No. 8F Color of Wire L Signal Name [Specification]

A  
B  
C  
D  
E  
F  
G  
H  
I  
J  
K  
L  
PCS  
N  
O  
P

JCMWM1417G1

# POWER DISTRIBUTION SYSTEM

< COMPONENT DIAGNOSIS >

[POWER DISTRIBUTION SYSTEM]

## PDS (POWER DISTRIBUTION SYSTEM)

Connector No.	E106
Connector Name	WIRE TO WIRE
Connector Type	TH80FW-CS16-TM4

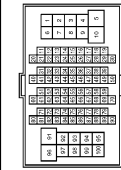

Terminal No.	Color of Wire	Signal Name [Specification]
40	GR	-
74	L	-
75	O	-
76	R	-
81	P	-
82	L	-
87	W	-
91	W	-
97	BR	-

Connector No.	E110
Connector Name	STOP LAMP SWITCH
Connector Type	MD4FW-LC



Terminal No.	Color of Wire	Signal Name [Specification]
1	L	-
2	SB	-
3	L	-
4	W	-

Connector No.	F1
Connector Name	WIRE TO WIRE
Connector Type	SAA38FB-RS1P-SJ22

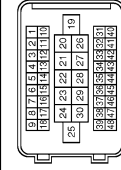

Terminal No.	Color of Wire	Signal Name [Specification]
20	GR	-

Connector No.	F51
Connector Name	A/T ASSEMBLY
Connector Type	RK10FG-DGY



Terminal No.	Color of Wire	Signal Name [Specification]
9	GR	-

Connector No.	F151
Connector Name	TOM (TRANSMISSION CONTROL MODULE)
Connector Type	SP10FBGY

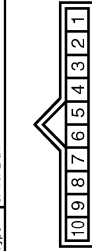

Terminal No.	Color of Wire	Signal Name [Specification]
8	G	START RLY

Connector No.	M1
Connector Name	FUSE BLOCK (J/B)
Connector Type	NS00FW-M2

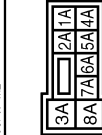

Terminal No.	Color of Wire	Signal Name [Specification]
3A	L	-
4A	P	-
5A	V	-
7A	R	-
8A	L	-

Connector No.	M2
Connector Name	FUSE BLOCK (J/B)
Connector Type	NS10FW-CS

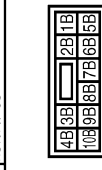

Terminal No.	Color of Wire	Signal Name [Specification]
3B	P	-
5B	O	-
9B	SB	-

Connector No.	M3
Connector Name	FUSE BLOCK (J/B)
Connector Type	NS12FW-CS

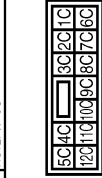

Terminal No.	Color of Wire	Signal Name [Specification]
6C	R	-
7C	B	-



# POWER DISTRIBUTION SYSTEM

< COMPONENT DIAGNOSIS >

[POWER DISTRIBUTION SYSTEM]

## PDS (POWER DISTRIBUTION SYSTEM)

Connector No.	M60
Connector Name	PUSH-BUTTON IGNITION SWITCH
Connector Type	TK03FBR



Terminal No.	Color of Wire	Signal Name [Specification]
1	B	-
4	BR	-
5	GR	-
6	Y	-
7	V	-
8	P	-

Connector No.	M24
Connector Name	DATA LINK CONNECTOR
Connector Type	BD16FW

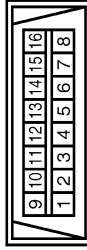

Terminal No.	Color of Wire	Signal Name [Specification]
6	L	-
14	P	-

Connector No.	M7
Connector Name	WIRE TO WIRE
Connector Type	TH80MF-CS16-TM4

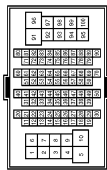

Terminal No.	Color of Wire	Signal Name [Specification]
34	L	-
35	P	-
36	L	-
37	P	-

Connector No.	M6
Connector Name	WIRE TO WIRE
Connector Type	TH80MF-CS16-TM4

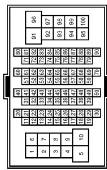

Terminal No.	Color of Wire	Signal Name [Specification]
40	GR	-
74	BR	-
75	Y	-
76	SB	-
81	P	-
82	L	-
87	W	-
91	W	-
97	O	-

Connector No.	MT18
Connector Name	ECM (BODY CONTROL MODULE)
Connector Type	MD3FB-LC



Connector No.	M67
Connector Name	UNIFIED METER AND A/C AMP.
Connector Type	TH32FW-NH

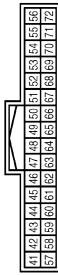

Connector No.	M66
Connector Name	UNIFIED METER AND A/C AMP.
Connector Type	TH40FW-NH



Connector No.	M53
Connector Name	COMBINATION METER
Connector Type	TH40FW-NH



Terminal No.	Color of Wire	Signal Name [Specification]
1	W	BAT (F/L)

Terminal No.	Color of Wire	Signal Name [Specification]
56	L	CAN-H
72	P	CAN-L

Terminal No.	Color of Wire	Signal Name [Specification]
7	GR	COMM (AMP->METER)
27	LG	COMM (METER->AMP.)

Terminal No.	Color of Wire	Signal Name [Specification]
2	LG	COMM (METER->AMP.)
3	GR	COMM (AMP->METER)

A  
B  
C  
D  
E  
F  
G  
H  
I  
J  
K  
L  
PCS  
N  
O  
P

# POWER DISTRIBUTION SYSTEM

< COMPONENT DIAGNOSIS >

[POWER DISTRIBUTION SYSTEM]

## PDS (POWER DISTRIBUTION SYSTEM)

Connector No.	M119
Connector Name	BCM (BODY CONTROL MODULE)
Connector Type	HS16FY-CS



Terminal No.	Color of Wire	Signal Name [Specification]
11	R	BAT (FUSE)
13	B	GND
15	Y	ACC IND

Connector No.	M121
Connector Name	BCM (BODY CONTROL MODULE)
Connector Type	TH40FY-NH



Terminal No.	Color of Wire	Signal Name [Specification]
47	Y	IGN RELAY (PDM)/R CONT
52	SB	STARTER RELAY CONT

Connector No.	M122
Connector Name	BCM (BODY CONTROL MODULE)
Connector Type	TH40FB-NH



Terminal No.	Color of Wire	Signal Name [Specification]
82	R	IGN RELAY (F/B) CONT
89	BR	PUSH SW
90	P	CAN-L
91	L	CAN-H
93	V	ON IND
95	O	ACC RELAY CONT
102	O	BLOWER FAN MOTOR RELAY CONT

Connector No.	M123
Connector Name	BCM (BODY CONTROL MODULE)
Connector Type	TH40FG-NH



Terminal No.	Color of Wire	Signal Name [Specification]
116	SB	FUSE CHECK
118	P	STOP LAMP SW
122	V	ACC F/B
123	W	IGN F/B
134	GR	LOCK IND
140	GR	SHIFT N/P

JCMWM1420G

# BCM (BODY CONTROL MODULE)

< ECU DIAGNOSIS >

[POWER DISTRIBUTION SYSTEM]

## ECU DIAGNOSIS

### BCM (BODY CONTROL MODULE)

Reference Value

INFOID:000000003786301

#### VALUES ON THE DIAGNOSIS TOOL

CONSULT-III MONITOR ITEM

Monitor Item	Condition	Value/Status
FR WIPER HI	Other than front wiper switch HI	Off
	Front wiper switch HI	On
FR WIPER LOW	Other than front wiper switch LO	Off
	Front wiper switch LO	On
FR WASHER SW	Front washer switch OFF	Off
	Front washer switch ON	On
FR WIPER INT	Other than front wiper switch INT	Off
	Front wiper switch INT	On
FR WIPER STOP	Front wiper is not in STOP position	Off
	Front wiper is in STOP position	On
INT VOLUME	Wiper intermittent dial is in a dial position 1 - 7	Wiper intermittent dial position
RR WIPER ON	Other than rear wiper switch ON	Off
	Rear wiper switch ON	On
RR WIPER INT	Other than rear wiper switch INT	Off
	Rear wiper switch INT	On
RR WASHER SW	Rear washer switch OFF	Off
	Rear washer switch ON	On
RR WIPER STOP	Rear wiper is in STOP position	Off
	Rear wiper is not in STOP position	On
TURN SIGNAL R	Other than turn signal switch RH	Off
	Turn signal switch RH	On
TURN SIGNAL L	Other than turn signal switch LH	Off
	Turn signal switch LH	On
TAIL LAMP SW	Other than lighting switch 1ST and 2ND	Off
	Lighting switch 1ST or 2ND	On
HI BEAM SW	Other than lighting switch HI	Off
	Lighting switch HI	On
HEAD LAMP SW 1	Other than lighting switch 2ND	Off
	Lighting switch 2ND	On
HEAD LAMP SW 2	Other than lighting switch 2ND	Off
	Lighting switch 2ND	On
PASSING SW	Other than lighting switch PASS	Off
	Lighting switch PASS	On
AUTO LIGHT SW	Other than lighting switch AUTO	Off
	Lighting switch AUTO	On
FR FOG SW	Front fog lamp switch OFF	Off
	Front fog lamp switch ON	On

# BCM (BODY CONTROL MODULE)

< ECU DIAGNOSIS >

[POWER DISTRIBUTION SYSTEM]

Monitor Item	Condition	Value/Status
RR FOG SW	<b>NOTE:</b> The item is indicated, but not monitored.	Off
DOOR SW-DR	Driver door closed	Off
	Driver door opened	On
DOOR SW-AS	Passenger door closed	Off
	Passenger door opened	On
DOOR SW-RR	Rear RH door closed	Off
	Rear RH door opened	On
DOOR SW-RL	Rear LH door closed	Off
	Rear LH door opened	On
DOOR SW-BK	Back door closed	Off
	Back door opened	On
CDL LOCK SW	Other than power door lock switch LOCK	Off
	Power door lock switch LOCK	On
CDL UNLOCK SW	Other than power door lock switch UNLOCK	Off
	Power door lock switch UNLOCK	On
KEY CYL LK-SW	Other than driver door key cylinder LOCK position	Off
	Driver door key cylinder LOCK position	On
KEY CYL UN-SW	Other than driver door key cylinder UNLOCK position	Off
	Driver door key cylinder UNLOCK position	On
KEY CYL SW-TR	<b>NOTE:</b> The item is indicated, but not monitored.	Off
HAZARD SW	Hazard switch is OFF	Off
	Hazard switch is ON	On
REAR DEF SW	<b>NOTE:</b> The item is indicated, but not monitored.	Off
TR CANCEL SW	<b>NOTE:</b> The item is indicated, but not monitored.	Off
TR/BD OPEN SW	Back door opener switch OFF	Off
	While the back door opener switch is turned ON	On
TRNK/HAT MNTR	<b>NOTE:</b> The item is indicated, but not monitored.	Off
RKE-LOCK	LOCK button of the key is not pressed	Off
	LOCK button of the key is pressed	On
RKE-UNLOCK	UNLOCK button of the key is not pressed	Off
	UNLOCK button of the key is pressed	On
RKE-TR/BD	<b>NOTE:</b> The item is indicated, but not monitored.	Off
RKE-PANIC	PANIC button of the key is not pressed	Off
	PANIC button of the key is pressed	On
RKE-P/W OPEN	UNLOCK button of the key is not pressed	Off
	UNLOCK button of the key is pressed and held	On
RKE-MODE CHG	LOCK/UNLOCK button of the key is not pressed and held simultaneously	Off
	LOCK/UNLOCK button of the key is pressed and held simultaneously	On

# BCM (BODY CONTROL MODULE)

< ECU DIAGNOSIS >

[POWER DISTRIBUTION SYSTEM]

Monitor Item	Condition	Value/Status
OPTICAL SENSOR	Bright outside of the vehicle	Close to 5 V
	Dark outside of the vehicle	Close to 0 V
REQ SW -DR	Driver door request switch is not pressed	Off
	Driver door request switch is pressed	On
REQ SW -AS	Passenger door request switch is not pressed	Off
	Passenger door request switch is pressed	On
REQ SW -RR	<b>NOTE:</b> The item is indicated, but not monitored.	Off
REQ SW -RL	<b>NOTE:</b> The item is indicated, but not monitored.	Off
REQ SW -BD/TR	Back door request switch is not pressed	Off
	Back door request switch is pressed	On
PUSH SW	Push-button ignition switch (push switch) is not pressed	Off
	Push-button ignition switch (push switch) is pressed	On
IGN RLY2 -F/B	Ignition switch in OFF or ACC position	Off
	Ignition switch in ON position	On
CLUCH SW	<b>NOTE:</b> The item is indicated, but not monitored.	Off
BRAKE SW 1	The brake pedal is not depressed	On
	The brake pedal is depressed	Off
DETE/CANCL SW	Selector lever in P position	Off
	Selector lever in any position other than P	On
SFT PN/N SW	Selector lever in any position other than P and N	Off
	Selector lever in P or N position	On
S/L -LOCK	Steering is locked	Off
	Steering is unlocked	On
S/L -UNLOCK	Steering is unlocked	Off
	Steering is locked	On
S/L RELAY-F/B	Ignition switch in OFF or ACC position	Off
	Ignition switch in ON position	On
UNLK SEN -DR	Driver door is unlocked	Off
	Driver door is locked	On
PUSH SW -IPDM	Push-button ignition switch (push-switch) is not pressed	Off
	Push-button ignition switch (push-switch) is pressed	On
IGN RLY1 -F/B	Ignition switch in OFF or ACC position	Off
	Ignition switch in ON position	On
DETE SW -IPDM	Selector lever in P position	Off
	Selector lever in any position other than P	On
SFT PN -IPDM	Selector lever in any position other than P and N	Off
	Selector lever in P or N position	On
SFT P -MET	Selector lever in any position other than P	Off
	Selector lever in P position	On
SFT N -MET	Selector lever in any position other than N	Off
	Selector lever in N position	On

A  
B  
C  
D  
E  
F  
G  
H  
I  
J  
K  
L  
PCS  
N  
O  
P

# BCM (BODY CONTROL MODULE)

< ECU DIAGNOSIS >

[POWER DISTRIBUTION SYSTEM]

Monitor Item	Condition	Value/Status
ENGINE STATE	Engine stopped	Stop
	While the engine stalls	Stall
	At engine cranking	Crank
	Engine running	Run
S/L LOCK-IPDM	Steering is locked	Off
	Steering is unlocked	On
S/L UNLK-IPDM	Steering is unlocked	Off
	Steering is locked	On
S/L RELAY-REQ	Ignition switch in OFF or ACC position	Off
	Ignition switch in ON position	On
VEH SPEED 1	While driving	Equivalent to speedometer reading
VEH SPEED 2	While driving	Equivalent to speedometer reading
DOOR STAT-DR	Driver door is locked	LOCK
	Wait with selective UNLOCK operation (5 seconds)	READY
	Driver door is unlocked	UNLOCK
DOOR STAT-AS	Passenger door is locked	LOCK
	Wait with selective UNLOCK operation (5 seconds)	READY
	Passenger door is unlocked	UNLOCK
ID OK FLAG	Ignition switch in ACC or ON position	Reset
	Ignition switch in OFF position	Set
PRMT ENG STRT	The engine start is prohibited	Reset
	The engine start is permitted	Set
PRMT RKE STRT	<b>NOTE:</b> The item is indicated, but not monitored.	Reset
KEY SW -SLOT	The key is not inserted into key slot	Off
	The key is inserted into key slot	On
RKE OPE COUN1	During the operation of the key	Operation frequency of the key
RKE OPE COUN2	<b>NOTE:</b> The item is indicated, but not monitored.	—
CONFIRM ID ALL	The key ID that the key slot receives does not accord with any key ID registered to BCM.	Yet
	The key ID that the key slot receives accords with any key ID registered to BCM.	DONE
CONFIRM ID4	The key ID that the key slot receives does not accord with the fourth key ID registered to BCM.	Yet
	The key ID that the key slot receives accords with the fourth key ID registered to BCM.	DONE
CONFIRM ID3	The key ID that the key slot receives does not accord with the third key ID registered to BCM.	Yet
	The key ID that the key slot receives accords with the third key ID registered to BCM.	DONE
CONFIRM ID2	The key ID that the key slot receives does not accord with the second key ID registered to BCM.	Yet
	The key ID that the key slot receives accords with the second key ID registered to BCM.	DONE

# BCM (BODY CONTROL MODULE)

< ECU DIAGNOSIS >

[POWER DISTRIBUTION SYSTEM]

Monitor Item	Condition	Value/Status
CONFIRM ID1	The key ID that the key slot receives does not accord with the first key ID registered to BCM.	Yet
	The key ID that the key slot receives accords with the first key ID registered to BCM.	DONE
TP 4	The ID of fourth key is not registered to BCM	Yet
	The ID of fourth key is registered to BCM	DONE
TP 3	The ID of third key is not registered to BCM	Yet
	The ID of third key is registered to BCM	DONE
TP 2	The ID of second key is not registered to BCM	Yet
	The ID of second key is registered to BCM	DONE
TP 1	The ID of first key is not registered to BCM	Yet
	The ID of first key is registered to BCM	DONE
AIR PRESS FL	Ignition switch ON (Only when the signal from the transmitter is received)	Air pressure of front LH tire
AIR PRESS FR	Ignition switch ON (Only when the signal from the transmitter is received)	Air pressure of front RH tire
AIR PRESS RR	Ignition switch ON (Only when the signal from the transmitter is received)	Air pressure of rear RH tire
AIR PRESS RL	Ignition switch ON (Only when the signal from the transmitter is received)	Air pressure of rear LH tire
ID REGST FL1	ID of front LH tire transmitter is registered	DONE
	ID of front LH tire transmitter is not registered	Yet
ID REGST FR1	ID of front RH tire transmitter is registered	DONE
	ID of front RH tire transmitter is not registered	Yet
ID REGST RR1	ID of rear RH tire transmitter is registered	DONE
	ID of rear RH tire transmitter is not registered	Yet
ID REGST RL1	ID of rear LH tire transmitter is registered	DONE
	ID of rear LH tire transmitter is not registered	Yet
WARNING LAMP	Tire pressure indicator OFF	Off
	Tire pressure indicator ON	On
BUZZER	Tire pressure warning alarm is not sounding	Off
	Tire pressure warning alarm is sounding	On

A  
B  
C  
D  
E  
F  
G  
H  
I  
J  
K  
L  
N  
O  
P

PCS

# BCM (BODY CONTROL MODULE)

[POWER DISTRIBUTION SYSTEM]

< ECU DIAGNOSIS >

## TERMINAL LAYOUT

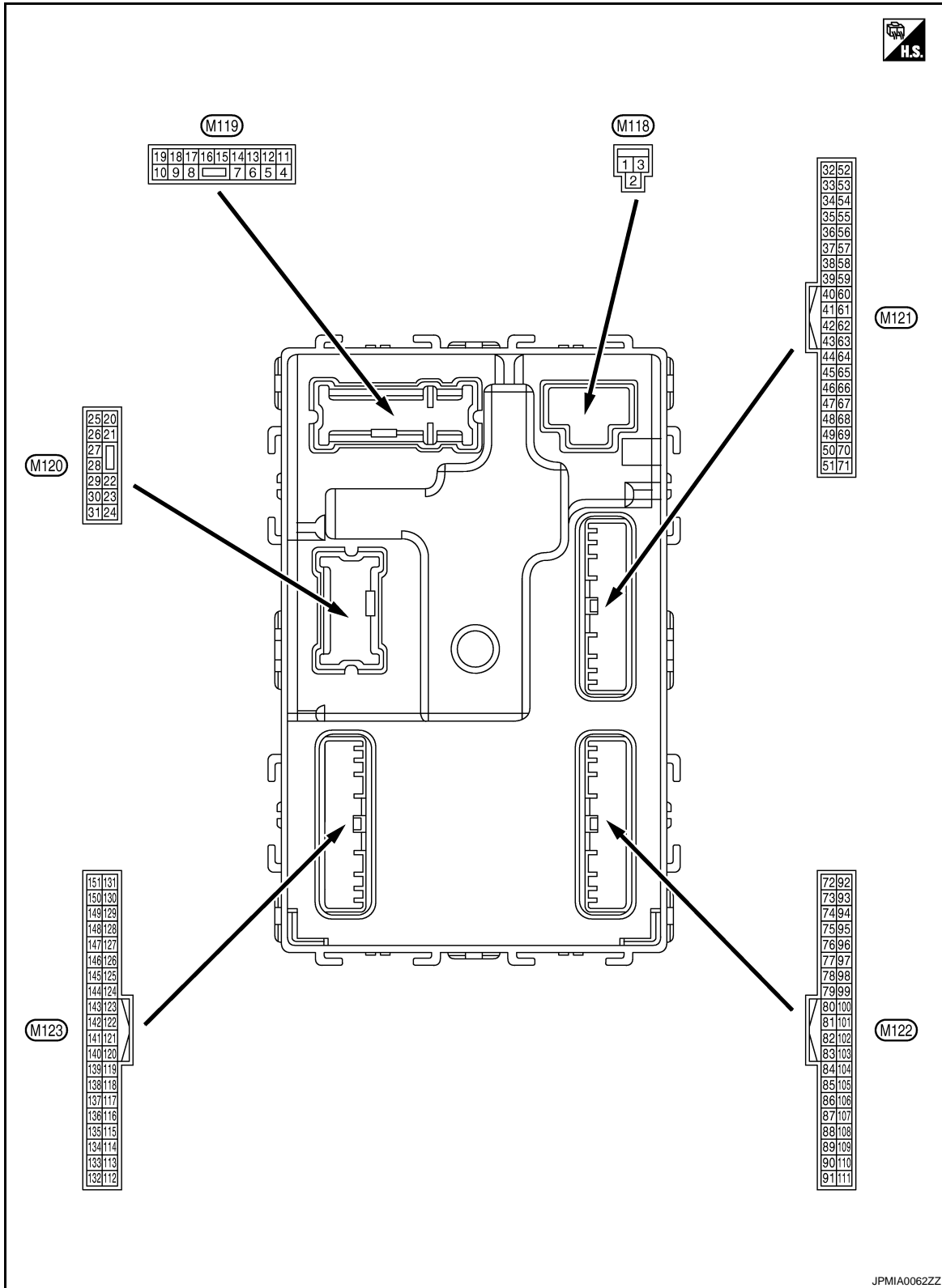

## PHYSICAL VALUES



# BCM (BODY CONTROL MODULE)

< ECU DIAGNOSIS >

[POWER DISTRIBUTION SYSTEM]

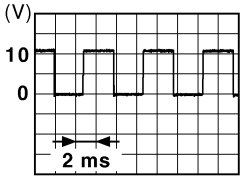
Terminal No. (Wire color)		Description		Condition		Value (Approx.)
+	-					
1 (W)	Ground	Battery power supply	Input	Ignition switch OFF		Battery voltage
2 (Y)	Ground	P/W power supply (BAT)	Output	Ignition switch OFF		Battery voltage
3 (O)	Ground	P/W power supply (RAP)	Output	Ignition switch ON		Battery voltage
4 (LG)	Ground	Interior room lamp power supply	Output	Interior room lamp battery saver is activated. (Cuts the interior room lamp power supply)		0 V
				Interior room lamp battery saver is not activated. (Outputs the interior room lamp power supply)		Battery voltage
5 (L)	Ground	Passenger door UN- LOCK	Output	Passenger door	UNLOCK (Actuator is activated)	Battery voltage
					Other than UNLOCK (Actuator is not activated)	0 V
7 (Y)	Ground	Step lamp	Output	Step lamp	ON	0 V
						OFF
8 (V)	Ground	All doors, fuel lid LOCK	Output	All doors	LOCK (Actuator is activated)	Battery voltage
						Other than LOCK (Actuator is not activated)
9 (G)	Ground	Driver door, fuel lid UNLOCK	Output	Driver door	UNLOCK (Actuator is activated)	Battery voltage
						Other than UNLOCK (Actuator is not activated)
10 (BR)	Ground	Rear RH door and rear LH door UN- LOCK	Output	Rear RH door and rear LH door	UNLOCK (Actuator is activated)	Battery voltage
						Other than UNLOCK (Actuator is not activated)
11 (R)	Ground	Battery power supply	Input	Ignition switch OFF		Battery voltage
13 (B)	Ground	Ground	—	Ignition switch ON		0 V
14 (W)	Ground	Push-button ignition switch illumination ground	Output	Tail lamp	OFF	0 V
					ON	<p><b>NOTE:</b> When the illumination brightening/dimming level is in the neutral position</p>  <p style="text-align: right; font-size: small;">JSNIA0010GB</p>
15 (Y)	Ground	ACC indicator lamp	Output	Ignition switch	OFF or ON	Battery voltage
					ACC	0 V

A  
B  
C  
D  
E  
F  
G  
H  
I  
J  
K  
L  
PCS  
N  
O  
P

# BCM (BODY CONTROL MODULE)

## [POWER DISTRIBUTION SYSTEM]

### < ECU DIAGNOSIS >

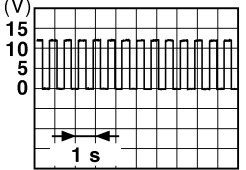
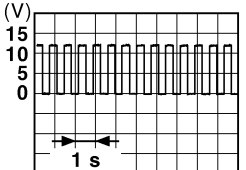
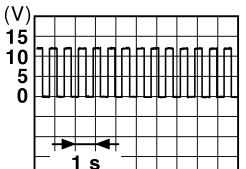
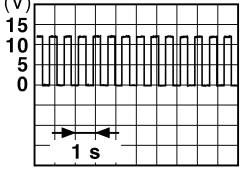
Terminal No. (Wire color)		Description		Condition	Value (Approx.)	
		Signal name	Input/ Output			
+	-					
17 (W)	Ground	Turn signal RH (Front)	Output	Ignition switch ON	Turn signal switch OFF	0 V
					Turn signal switch RH	 <p style="text-align: right; margin-right: 50px;">PKID0926E</p> <p style="text-align: center;">6.5 V</p>
18 (O)	Ground	Turn signal LH (Front)	Output	Ignition switch ON	Turn signal switch OFF	0 V
					Turn signal switch LH	 <p style="text-align: right; margin-right: 50px;">PKID0926E</p> <p style="text-align: center;">6.5 V</p>
19 (V)	Ground	Room lamp timer control	Output	Interior room lamp	OFF	Battery voltage
					ON	0 V
20 (V)	Ground	Turn signal RH (Rear)	Output	Ignition switch ON	Turn signal switch OFF	0 V
					Turn signal switch RH	 <p style="text-align: right; margin-right: 50px;">PKID0926E</p> <p style="text-align: center;">6.5 V</p>
23 (G)	Ground	Back door opening	Output	Back door	OPEN (Back door opener actuator is activated)	Battery voltage
					Other than OPEN (Back door opener actuator is not activated)	0 V
25 (G)	Ground	Turn signal LH (Rear)	Output	Ignition switch ON	Turn signal switch OFF	0 V
					Turn signal switch LH	 <p style="text-align: right; margin-right: 50px;">PKID0926E</p> <p style="text-align: center;">6.5 V</p>
26 (G)	Ground	Rear wiper	Output	Rear wiper	OFF (Stopped)	0 V
					ON (Operated)	Battery voltage

# BCM (BODY CONTROL MODULE)

## [POWER DISTRIBUTION SYSTEM]

< ECU DIAGNOSIS >

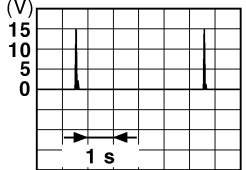
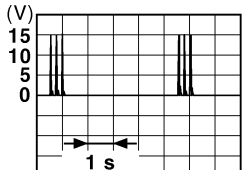
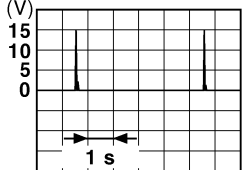
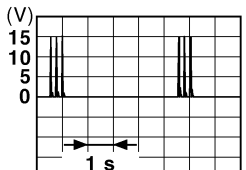
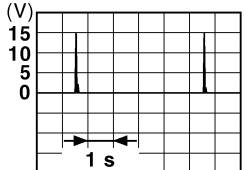
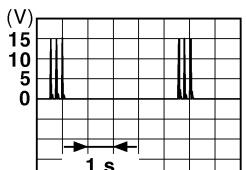
Terminal No. (Wire color)		Description		Condition	Value (Approx.)
		Signal name	Input/ Output		
+	-				
34 (SB)	Ground	Luggage room antenna 1 (-)	Output	Ignition switch OFF	 <p style="text-align: right; font-size: small;">JMKIA0062GB</p>
				When Intelligent Key is not in the passenger compartment	 <p style="text-align: right; font-size: small;">JMKIA0063GB</p>
35 (V)	Ground	Luggage room antenna 1 (+)	Output	Ignition switch OFF	 <p style="text-align: right; font-size: small;">JMKIA0062GB</p>
				When Intelligent Key is not in the passenger compartment	 <p style="text-align: right; font-size: small;">JMKIA0063GB</p>
38 (B)	Ground	Rear bumper antenna (-)	Output	When the back door request switch is operated with ignition switch OFF	 <p style="text-align: right; font-size: small;">JMKIA0062GB</p>
				When Intelligent Key is not in the antenna detection area	 <p style="text-align: right; font-size: small;">JMKIA0063GB</p>

A  
B  
C  
D  
E  
F  
G  
H  
I  
J  
K  
L  
N  
O  
P

PCS

# BCM (BODY CONTROL MODULE)

## [POWER DISTRIBUTION SYSTEM]

### < ECU DIAGNOSIS >

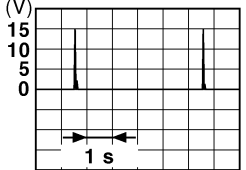
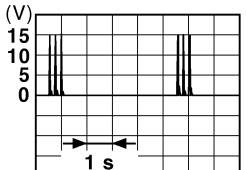
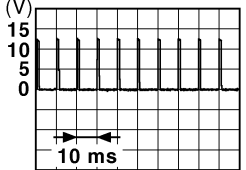
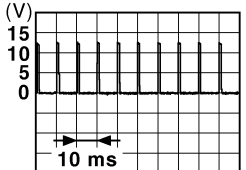
Terminal No. (Wire color)		Description		Condition		Value (Approx.)
+	-	Signal name	Input/ Output			
39 (W)	Ground	Rear bumper antenna (+)	Output	When the back door request switch is operated with ignition switch OFF	When Intelligent Key is in the antenna detection area	 <small>JMKIA0062GB</small>
					When Intelligent Key is not in the antenna detection area	 <small>JMKIA0063GB</small>
47 (Y)	Ground	Ignition relay (IPDM E/R) control	Output	Ignition switch	OFF or ACC	Battery voltage
					ON	0 V
52 (SB)	Ground	Starter relay control	Output	Ignition switch ON	When selector lever is in P or N position	Battery voltage
					When selector lever is not in P or N position	0 V
61 (W)	Ground	Back door opener request switch	Input	Back door request switch	ON (Pressed)	0 V
					OFF (Not pressed)	 <small>JPMIA0016GB</small> 1.0 V
64 (V)	Ground	Request switch buzzer	Output	Request switch buzzer	Sounding	0 V
					Not sounding	Battery voltage
65 (O)	Ground	Rear wiper stop position	Input	Rear wiper	In stop position	 <small>JPMIA0016GB</small> 1.0 V
					Not in stop position	0 V

# BCM (BODY CONTROL MODULE)

## [POWER DISTRIBUTION SYSTEM]

< ECU DIAGNOSIS >

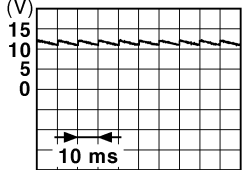
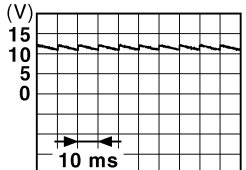
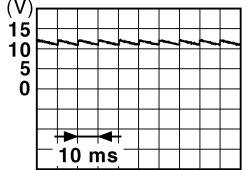
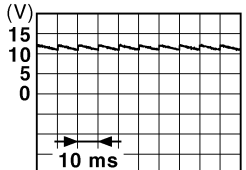
Terminal No. (Wire color)		Description		Condition	Value (Approx.)	
		Signal name	Input/ Output			
+	-					
66 (R)	Ground	Back door switch	Input	Back door switch	OFF (Door close)	 11.8 V
					ON (Door open)	0 V
67 (GR)	Ground	Back door opener switch	Input	Back door opener switch	Pressed	0 V
					Not pressed	 11.8 V
68 (BR)	Ground	Rear RH door switch	Input	Rear RH door switch	OFF (Door close)	 11.8 V
					ON (Door open)	0 V
69 (R)	Ground	Rear LH door switch	Input	Rear LH door switch	OFF (Door close)	 11.8 V
					ON (Door open)	0 V

A  
B  
C  
D  
E  
F  
G  
H  
I  
J  
K  
L  
N  
O  
P

PCS

# BCM (BODY CONTROL MODULE)

## [POWER DISTRIBUTION SYSTEM]

< ECU DIAGNOSIS >

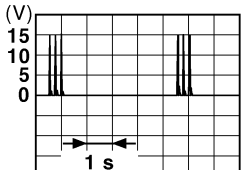
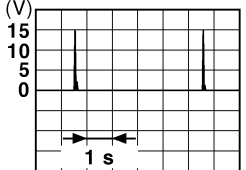
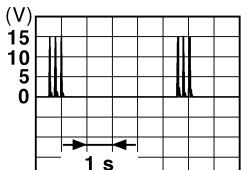
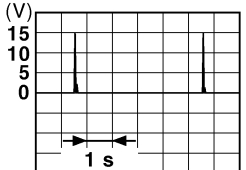
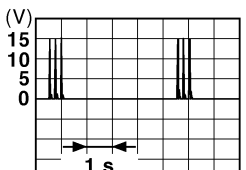
Terminal No. (Wire color)		Description		Condition	Value (Approx.)
+	-	Signal name	Input/ Output		
72 (R)	Ground	Room antenna 2 (-) (Center console)	Output		
				Ignition switch OFF	 <p style="text-align: right; font-size: small;">JMKIA0063GB</p>
73 (G)	Ground	Room antenna 2 (+) (Center console)	Output	Ignition switch OFF	 <p style="text-align: right; font-size: small;">JMKIA0062GB</p>
				Ignition switch OFF	 <p style="text-align: right; font-size: small;">JMKIA0063GB</p>
74 (SB)	Ground	Passenger door an- tenna (-)	Output	When the pas- senger door re- quest switch is operated with ig- nition switch OFF	 <p style="text-align: right; font-size: small;">JMKIA0062GB</p>
				Ignition switch OFF	 <p style="text-align: right; font-size: small;">JMKIA0063GB</p>

# BCM (BODY CONTROL MODULE)

## [POWER DISTRIBUTION SYSTEM]

### < ECU DIAGNOSIS >

Terminal No. (Wire color)		Description		Condition	Value (Approx.)
+	-	Signal name	Input/ Output		
75 (GR)	Ground	Passenger door antenna (+)	Output	When Intelligent Key is in the antenna detection area	<p>JMKIA0062GB</p>
				When the passenger door request switch is operated with ignition switch OFF	<p>JMKIA0063GB</p>
76 (V)	Ground	Driver door antenna (-)	Output	When Intelligent Key is in the antenna detection area	<p>JMKIA0062GB</p>
				When the driver door request switch is operated with ignition switch OFF	<p>JMKIA0063GB</p>
77 (LG)	Ground	Driver door antenna (+)	Output	When Intelligent Key is in the antenna detection area	<p>JMKIA0062GB</p>
				When the driver door request switch is operated with ignition switch OFF	<p>JMKIA0063GB</p>

A  
B  
C  
D  
E  
F  
G  
H  
I  
J  
K  
L  
N  
O  
P

PCS

# BCM (BODY CONTROL MODULE)

< ECU DIAGNOSIS >

[POWER DISTRIBUTION SYSTEM]

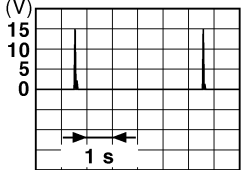
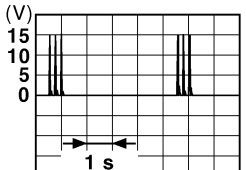
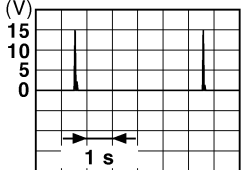
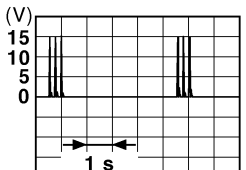

Terminal No. (Wire color)		Description		Condition	Value (Approx.)	
+	-	Signal name	Input/ Output			
78 (Y)	Ground	Room antenna (-) (Instrument panel)	Output	Ignition switch OFF	 <p style="text-align: right; font-size: small;">JMKIA0062GB</p>	
				When Intelligent Key is not in the passenger compart- ment	 <p style="text-align: right; font-size: small;">JMKIA0063GB</p>	
79 (BR)	Ground	Room antenna (+) (Instrument panel)	Output	Ignition switch OFF	 <p style="text-align: right; font-size: small;">JMKIA0062GB</p>	
				When Intelligent Key is not in the passenger compart- ment	 <p style="text-align: right; font-size: small;">JMKIA0063GB</p>	
80 (GR)	Ground	NATS antenna amp (Built in key slot)	Input/ Output	During waiting	Ignition switch is pressed while inserting the key into the key slot.	Just after pressing ignition switch. Pointer of tester should move.
81 (W)	Ground	NATS antenna amp (Built in key slot)	Input/ Output	During waiting	Ignition switch is pressed while inserting the key into the key slot.	Just after pressing ignition switch. Pointer of tester should move.
82 (R)	Ground	Ignition relay [Fuse block (J/B)] control	Output	Ignition switch	OFF or ACC	0 V
				ON	Battery voltage	



# BCM (BODY CONTROL MODULE)

## [POWER DISTRIBUTION SYSTEM]

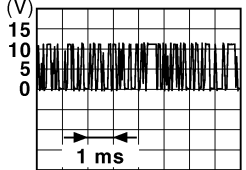
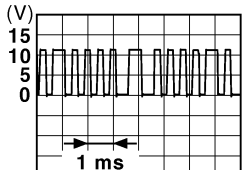
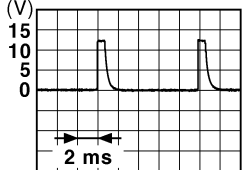
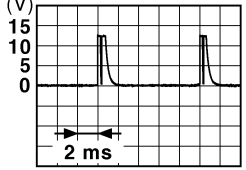
< ECU DIAGNOSIS >

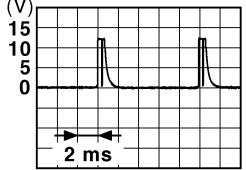
Terminal No. (Wire color)		Description		Condition	Value (Approx.)	
		Signal name	Input/ Output			
+	-					
83 (Y)	Ground	Remote keyless entry receiver signal	Input/ Output	During waiting	 <small>JMKIA0064GB</small>	
				When operating either button on the key	 <small>JMKIA0065GB</small>	
87 (BR)	Ground	Combination switch INPUT 5	Input	Combination switch	All switch OFF (Wiper intermittent dial 4)	 <small>JPMIA0041GB</small> 1.4 V
					Front fog lamp switch ON (Wiper intermittent dial 4)	 <small>JPMIA0037GB</small> 1.3 V
					Rear wiper switch ON (Wiper intermittent dial 4)	 <small>JPMIA0039GB</small> 1.3 V
					Any of the conditions below with all switch OFF <ul style="list-style-type: none"> <li>• Wiper intermittent dial 1</li> <li>• Wiper intermittent dial 2</li> <li>• Wiper intermittent dial 6</li> <li>• Wiper intermittent dial 7</li> </ul>	 <small>JPMIA0040GB</small> 1.3 V

A  
B  
C  
D  
E  
F  
G  
H  
I  
J  
K  
L  
N  
O  
P

PCS

# BCM (BODY CONTROL MODULE)

## [POWER DISTRIBUTION SYSTEM]

< ECU DIAGNOSIS >

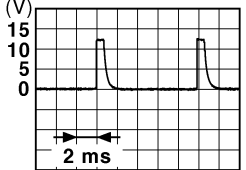
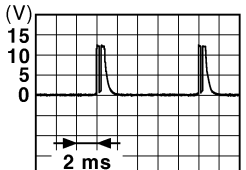
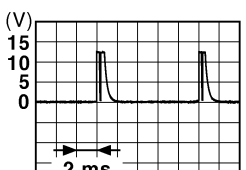
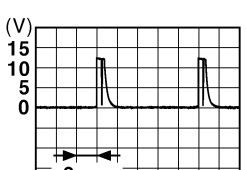
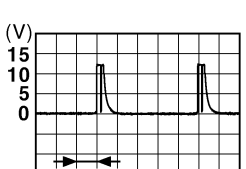
Terminal No. (Wire color)		Description		Condition	Value (Approx.)	
+	-	Signal name	Input/ Output			
88 (V)	Ground	Combination switch INPUT 3	Input	Combination switch	All switch OFF (Wiper intermittent dial 4)	 <p style="text-align: right; font-size: small;">JPMIA0041GB</p> <p style="text-align: center;">1.4 V</p>
					Lighting switch HI (Wiper intermittent dial 4)	 <p style="text-align: right; font-size: small;">JPMIA0036GB</p> <p style="text-align: center;">1.3 V</p>
					Lighting switch 2ND (Wiper intermittent dial 4)	 <p style="text-align: right; font-size: small;">JPMIA0037GB</p> <p style="text-align: center;">1.3 V</p>
					Rear washer switch ON (Wiper intermittent dial 4)	 <p style="text-align: right; font-size: small;">JPMIA0039GB</p> <p style="text-align: center;">1.3 V</p>
					Any of the conditions below with all switch OFF	 <p style="text-align: right; font-size: small;">JPMIA0040GB</p> <p style="text-align: center;">1.3 V</p>
89 (BR)	Ground	Push-button ignition switch (Push switch)	Input	Push-button igni- tion switch (push switch)	Pressed	0 V
					Not pressed	Battery voltage
90 (P)	Ground	CAN-L	Input/ Output	—	—	
91 (L)	Ground	CAN-H	Input/ Output	—	—	

# BCM (BODY CONTROL MODULE)

## [POWER DISTRIBUTION SYSTEM]

< ECU DIAGNOSIS >

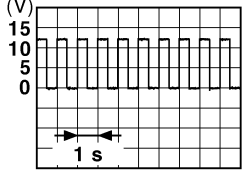
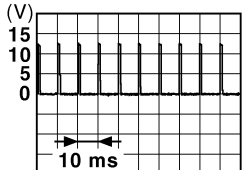
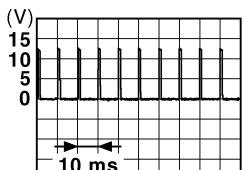
Terminal No. (Wire color)		Description		Condition	Value (Approx.)	
		Signal name	Input/ Output			
+	-					
92 (LG)	Ground	Key slot illumination	Output	Key slot illumination	OFF	Battery voltage
					Blinking	 <p style="text-align: center;">6.5 V</p>
93 (V)	Ground	ON indicator lamp	Output	Ignition switch	OFF or ACC	Battery voltage
					ON	0 V
94 (Y)	Ground	Puddle lamp control	Output	Puddle lamp	OFF	Battery voltage
					ON	0 V
95 (O)	Ground	ACC relay control	Output	Ignition switch	OFF	0 V
					ACC or ON	Battery voltage
96 (GR)	Ground	Control device (Detention switch) power supply	Output	—	Battery voltage	
97 (L)	Ground	Steering lock condition No. 1	Input	Steering lock	LOCK status	0 V
					UNLOCK status	Battery voltage
98 (P)	Ground	Steering lock condition No. 2	Input	Steering lock	LOCK status	Battery voltage
					UNLOCK status	0 V
99 (R)	Ground	Selector lever P position switch	Input	Selector lever	P position	0 V
					Any position other than P	Battery voltage
100 (G)	Ground	Passenger door request switch	Input	Passenger door request switch	ON (Pressed)	0 V
					OFF (Not pressed)	 <p style="text-align: center;">1.0 V</p>
101 (SB)	Ground	Driver door request switch	Input	Driver door request switch	ON (Pressed)	0 V
					OFF (Not pressed)	 <p style="text-align: center;">1.0 V</p>
102 (O)	Ground	Blower fan motor relay control	Output	Ignition switch	OFF or ACC	0 V
					ON	Battery voltage



A  
B  
C  
D  
E  
F  
G  
H  
I  
J  
K  
L  
N  
O  
P

PCS

# BCM (BODY CONTROL MODULE)

## [POWER DISTRIBUTION SYSTEM]

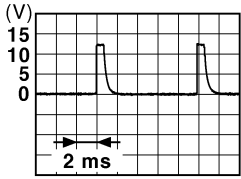
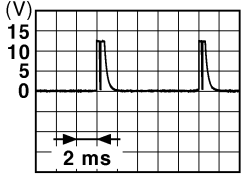
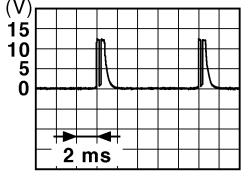
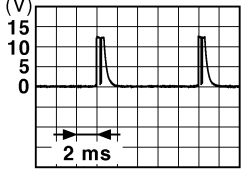

< ECU DIAGNOSIS >

Terminal No. (Wire color)		Description		Condition		Value (Approx.)
+	-	Signal name	Input/ Output			
103 (LG)	Ground	Remote keyless entry receiver power supply	Output	Ignition switch OFF		Battery voltage
106 (W)	Ground	Steering wheel lock unit power supply	Output	Ignition switch	OFF or ACC	Battery voltage
					ON	0 V
107 (LG)	Ground	Combination switch INPUT 1	Input	Combination switch (Wiper intermittent dial 4)	All switch OFF	 <p style="text-align: right; font-size: small;">JPMIA0041GB</p> <p style="text-align: center;">1.4 V</p>
					Turn signal switch LH	 <p style="text-align: right; font-size: small;">JPMIA0037GB</p> <p style="text-align: center;">1.3 V</p>
					Turn signal switch RH	 <p style="text-align: right; font-size: small;">JPMIA0036GB</p> <p style="text-align: center;">1.3 V</p>
					Front wiper switch LO	 <p style="text-align: right; font-size: small;">JPMIA0038GB</p> <p style="text-align: center;">1.3 V</p>
					Front washer switch ON	 <p style="text-align: right; font-size: small;">JPMIA0039GB</p> <p style="text-align: center;">1.3 V</p>

# BCM (BODY CONTROL MODULE)

## [POWER DISTRIBUTION SYSTEM]

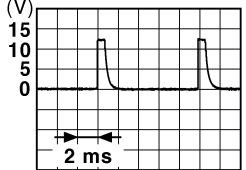
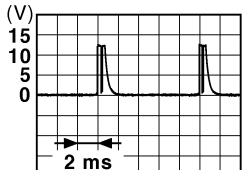
< ECU DIAGNOSIS >

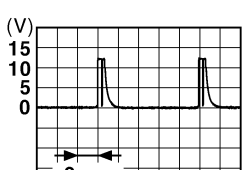
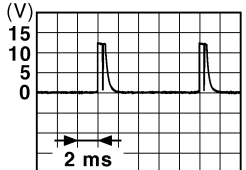

Terminal No. (Wire color)		Description		Condition	Value (Approx.)	
+	-	Signal name	Input/ Output			
108 (R)	Ground	Combination switch INPUT 4	Input	Combination switch	All switch OFF (Wiper intermittent dial 4)	 <p>1.4 V</p>
					Lighting switch AUTO (Wiper intermittent dial 4)	 <p>1.3 V</p>
					Lighting switch 1ST (Wiper intermittent dial 4)	 <p>1.3 V</p>
					Rear wiper switch INT (Wiper intermittent dial 4)	 <p>1.3 V</p>
					Any of the conditions below with all switch OFF	<ul style="list-style-type: none"> <li>• Wiper intermittent dial 1</li> <li>• Wiper intermittent dial 5</li> <li>• Wiper intermittent dial 6</li> </ul>  <p>1.3 V</p>

A  
B  
C  
D  
E  
F  
G  
H  
I  
J  
K  
L  
PCS  
N  
O  
P

# BCM (BODY CONTROL MODULE)

## [POWER DISTRIBUTION SYSTEM]

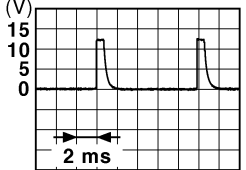
< ECU DIAGNOSIS >

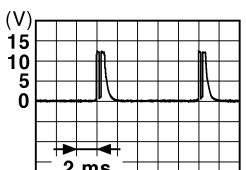
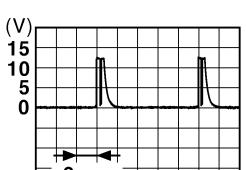
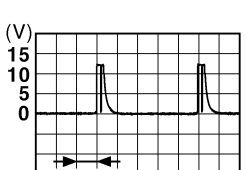
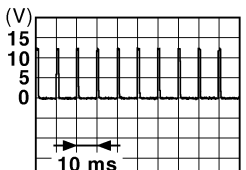
Terminal No. (Wire color)		Description		Condition	Value (Approx.)	
		Signal name	Input/ Output			
+	-					
109 (Y)	Ground	Combination switch INPUT 2	Input	Combination switch (Wiper intermittent dial 4)	All switch OFF	 1.4 V
					Lighting switch PASS	 1.3 V
					Lighting switch 2ND	 1.3 V
					Front wiper switch INT	 1.3 V
					Front wiper switch HI	 1.3 V
					ON	0 V
110 (G)	Ground	Hazard switch	Input	Hazard switch	OFF	 1.1 V
				ON	0 V	

# BCM (BODY CONTROL MODULE)

< ECU DIAGNOSIS >

[POWER DISTRIBUTION SYSTEM]

Terminal No. (Wire color)		Description		Condition	Value (Approx.)	
		Signal name	Input/ Output			
+	-					
111 (Y)	Ground	Steering lock unit communication	Input/ Output	Steering lock	LOCK status	Battery voltage
					LOCK or UNLOCK	<p style="text-align: right; font-size: small;">JMKIA0066GB</p>
					For 15 seconds after UNLOCK	Battery voltage
					15 seconds or later after UNLOCK	0 V
113* (P)	Ground	Optical sensor signal	Input	Ignition switch ON	When bright outside of the vehicle	Close to 5 V
				When dark outside of the vehicle	Close to 0 V	
116 (SB)	Ground	Fuse check [Stop lamp switch, ICC brake hold relay (With ICC)]	Input	—	Battery voltage	
118 (P)	Ground	Stop lamp switch (Without ICC)	Input	Stop lamp switch	OFF (Brake pedal is not depressed)	0 V
					ON (Brake pedal is depressed)	Battery voltage
		Stop lamp switch and ICC brake hold relay (With ICC)		Stop lamp switch OFF (Brake pedal is not depressed) and ICC brake hold relay OFF	0 V	
				Stop lamp switch ON (Brake pedal is depressed) or ICC brake hold relay ON	Battery voltage	
119 (SB)	Ground	Front door lock assembly driver side (unlock sensor)	Input	Driver door	LOCK status (Unlock sensor switch OFF)	<p style="text-align: right; font-size: small;">JPMIA0012GB</p>
					UNLOCK status (Unlock switch sensor ON)	0 V
					1.1 V	
121 (BR)	Ground	Key slot switch	Input	When the key is inserted into key slot	Battery voltage	
				When the key is not inserted into key slot	0 V	
122 (V)	Ground	ACC feedback signal	Input	Ignition switch	OFF	0 V
				ACC or ON	Battery voltage	
123 (W)	Ground	IGN feedback signal	Input	Ignition switch	OFF or ACC	0 V
				ON	Battery voltage	

A  
B  
C  
D  
E  
F  
G  
H  
I  
J  
K  
L  
N  
O  
P

PCS

# BCM (BODY CONTROL MODULE)

< ECU DIAGNOSIS >

[POWER DISTRIBUTION SYSTEM]

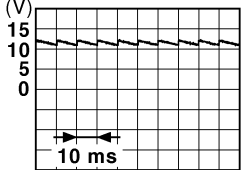
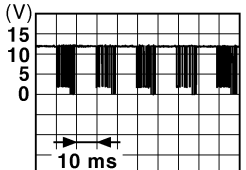
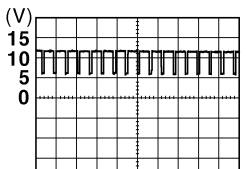
Terminal No. (Wire color)		Description		Condition		Value (Approx.)
		Signal name	Input/ Output			
+	-					
124 (LG)	Ground	Passenger door switch	Input	Passenger door switch	OFF (Door close)	 <small>JPMIA0011GB</small> 11.8 V
					ON (Door open)	0 V
132 (V)	Ground	Power window switch communication	Input/ Output	Ignition switch ON	 <small>JPMIA0013GB</small> 10.2 V	
				Ignition switch OFF or ACC	Battery voltage	
133 (W)	Ground	Push-button ignition switch illumination	Output	ON (Tail lamps OFF)	9.5 V	
				ON (Tail lamps ON)	<p><b>NOTE:</b> The pulse width of this wave is varied by the illumination brightening/dimming level.</p>  <small>JPMIA0159GB</small>	
134 (GR)	Ground	LOCK indicator lamp	Output	LOCK indicator lamp	OFF	Battery voltage
				ON	0 V	
137 (O)	Ground	Receiver and sensor ground	Input	Ignition switch ON	0 V	
138 (Y)	Ground	Sensor power supply	Output	Ignition switch	OFF	0 V
				ACC or ON	5.0 V	



# BCM (BODY CONTROL MODULE)

## [POWER DISTRIBUTION SYSTEM]

< ECU DIAGNOSIS >

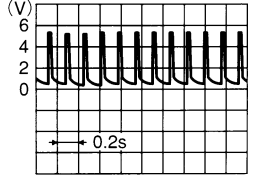
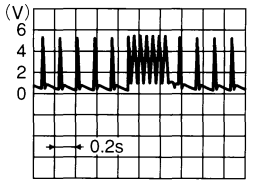
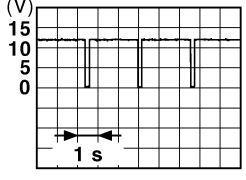
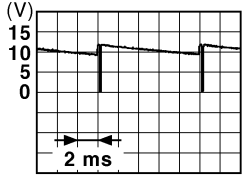
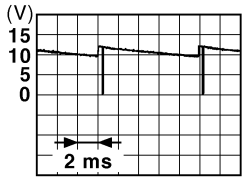
Terminal No. (Wire color)		Description		Condition	Value (Approx.)
		Signal name	Input/ Output		
+	-				
139 (L)	Ground	Tire pressure receiver signal	Input/ Output	Ignition switch ON	Standby state  OCC3881D
					When receiving the signal from the transmitter  OCC3880D
140 (GR)	Ground	Selector lever P/N position signal	Input	Selector lever	P or N position Battery voltage
					Except P and N positions 0 V
141 (G)	Ground	Security indicator signal	Output	Security indicator	ON 0 V
					Blinking  11.3 V JPMIA0014GB
					OFF Battery voltage
142 (O)	Ground	Combination switch OUTPUT 5	Output	Combination switch (Wiper intermittent dial 4)	All switch OFF 0 V
					Lighting switch 1ST  10.7 V JPMIA0031GB
					Lighting switch HI
					Lighting switch 2ND
					Turn signal switch RH
143 (P)	Ground	Combination switch OUTPUT 1	Output	Combination switch	All switch OFF (Wiper intermittent dial 4) 0 V
					Front wiper switch HI (Wiper intermittent dial 4)  10.7 V JPMIA0032GB
					Rear wiper switch INT (Wiper intermittent dial 4)
					Any of the conditions below with all switch OFF • Wiper intermittent dial 1 • Wiper intermittent dial 2 • Wiper intermittent dial 3 • Wiper intermittent dial 6 • Wiper intermittent dial 7

A  
B  
C  
D  
E  
F  
G  
H  
I  
J  
K  
L  
N  
O  
P

PCS

# BCM (BODY CONTROL MODULE)

< ECU DIAGNOSIS >

[POWER DISTRIBUTION SYSTEM]

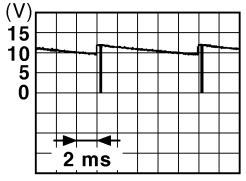
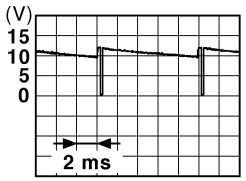
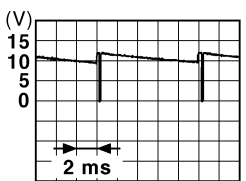
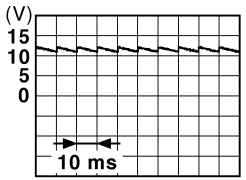
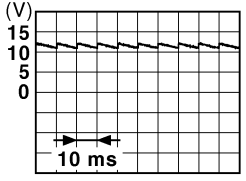
Terminal No. (Wire color)		Description		Condition	Value (Approx.)		
		Signal name	Input/ Output				
+	-						
144 (G)	Ground	Combination switch OUTPUT 2	Output	Combination switch	All switch OFF (Wiper intermittent dial 4)	0 V	
					Front washer switch ON (Wiper intermittent dial 4)		
					Rear wiper switch ON (Wiper intermittent dial 4)		
					Rear washer switch ON (Wiper intermittent dial 4)		
					Any of the conditions below with all switch OFF <ul style="list-style-type: none"> <li>• Wiper intermittent dial 1</li> <li>• Wiper intermittent dial 5</li> <li>• Wiper intermittent dial 6</li> </ul>		
					10.7 V		
145 (L)	Ground	Combination switch OUTPUT 3	Output	Combination switch (Wiper intermit- tent dial 4)	All switch OFF	0 V	
					Front wiper switch INT		
					Front wiper switch LO		
					Lighting switch AUTO		
					10.7 V		
146 (SB)	Ground	Combination switch OUTPUT 4	Output	Combination switch (Wiper intermit- tent dial 4)	All switch OFF	0 V	
					Front fog lamp switch ON		
					Lighting switch 2ND		
					Lighting switch PASS		
					Turn signal switch LH		
					10.7 V		
149 (W)	Ground	Tire pressure warn- ing check switch	Input	Ignition switch ON		11.8 V	
150 (LG)	Ground	Driver door switch	Input	Driver door switch	OFF (Door close)		11.8 V
					ON (Door open)	0 V	
151 (G)	Ground	Rear window defog- ger relay	Output	Rear window de- fogger	Active	0 V	
					Not activated	Battery voltage	

# BCM (BODY CONTROL MODULE)

## [POWER DISTRIBUTION SYSTEM]

< ECU DIAGNOSIS >

NOTE:

\*: With auto light system

### Wiring Diagram - BCM -

INFOID:000000003786302

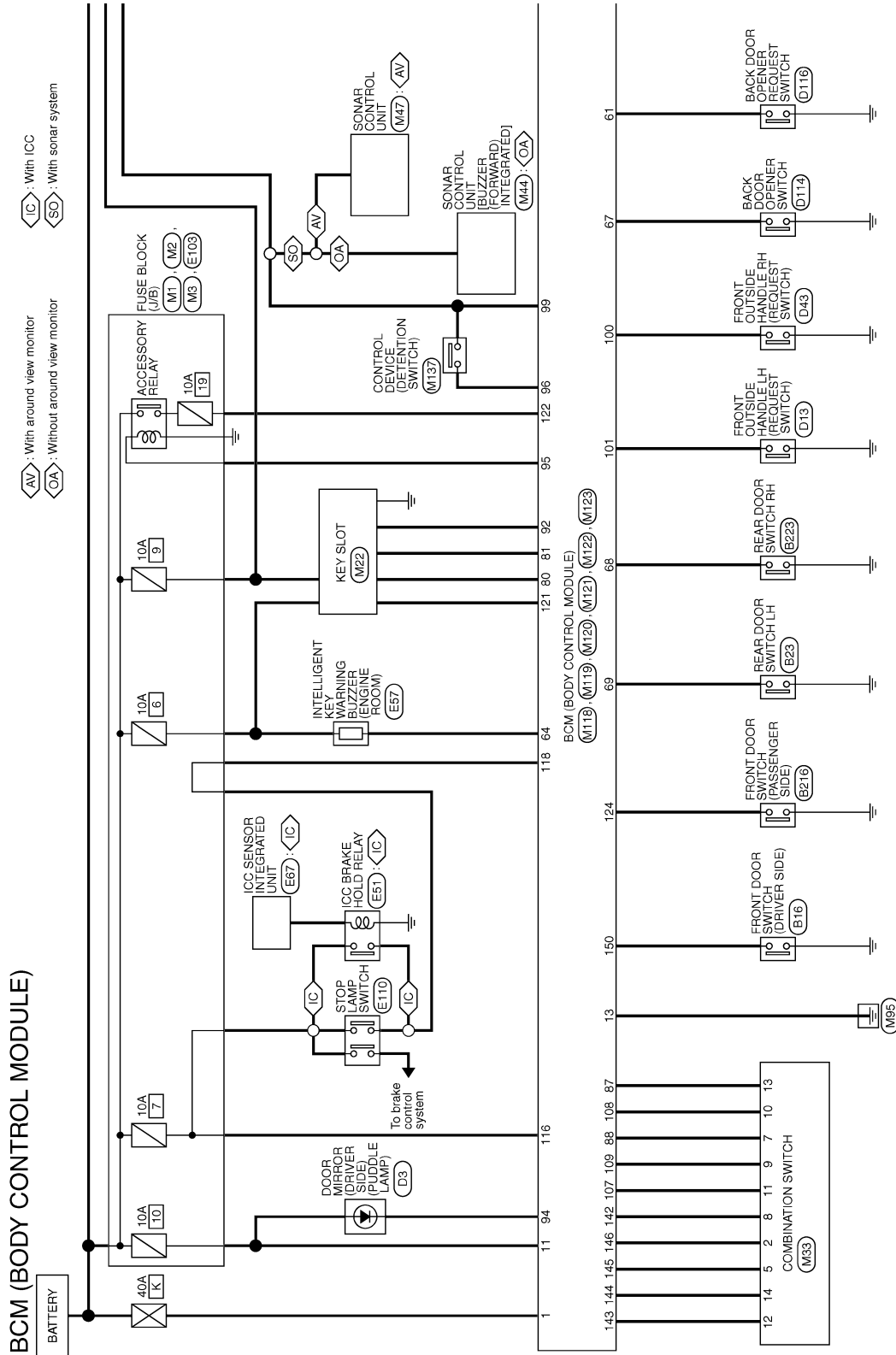

A  
B  
C  
D  
E  
F  
G  
H  
I  
J  
K  
L  
N  
O  
P

PCS

# BCM (BODY CONTROL MODULE)

## [POWER DISTRIBUTION SYSTEM]

< ECU DIAGNOSIS >

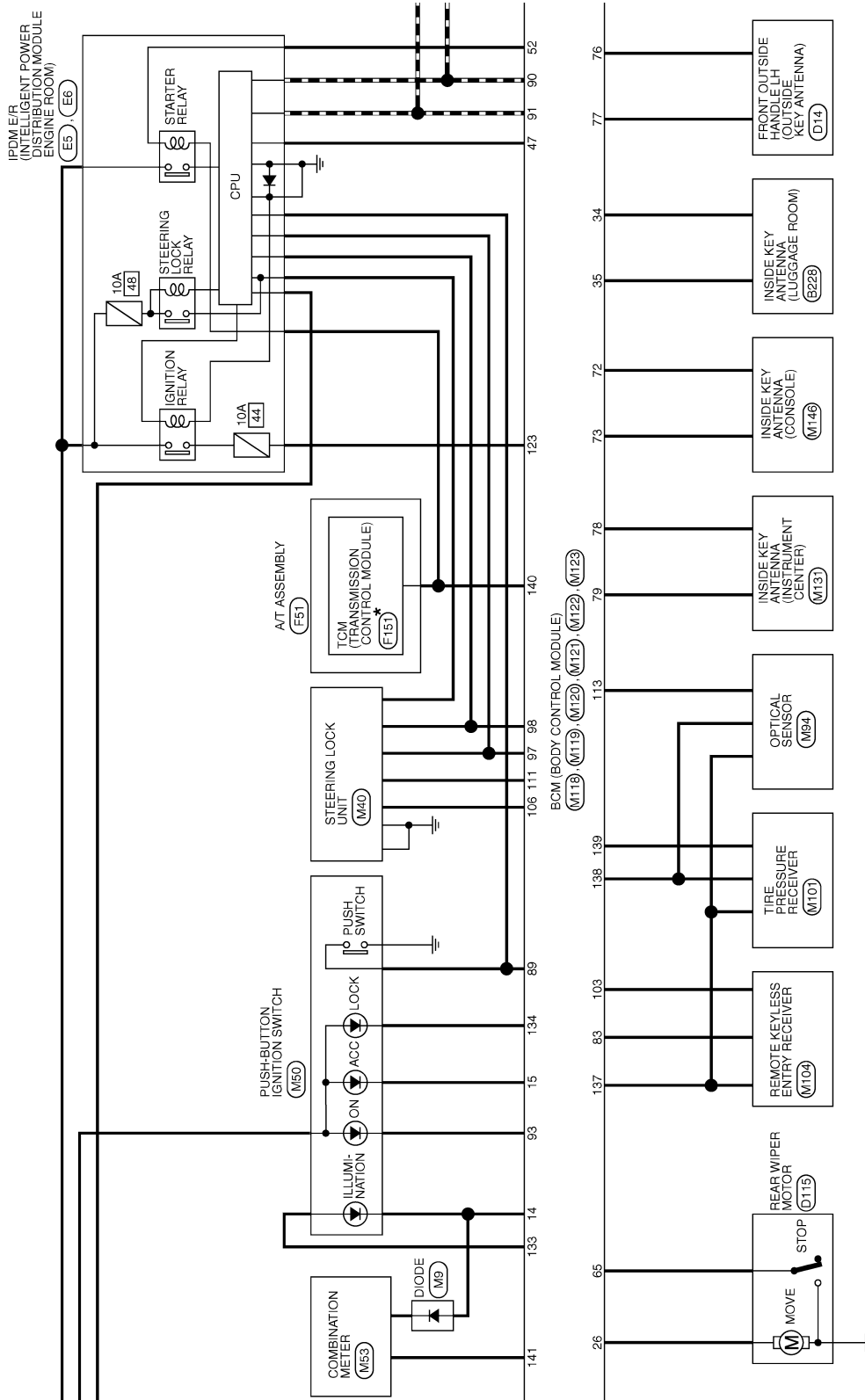

\*: This connector is not shown in "Harness Layout".

JCMWM1399G

# BCM (BODY CONTROL MODULE)

## [POWER DISTRIBUTION SYSTEM]

< ECU DIAGNOSIS >

- ◀NV▶ : With NAVI
- ◀ON▶ : Without NAVI
- ◀RF▶ : With sunroof
- ◀PM▶ : With automatic drive positioner
- ◀OP▶ : Without automatic drive positioner

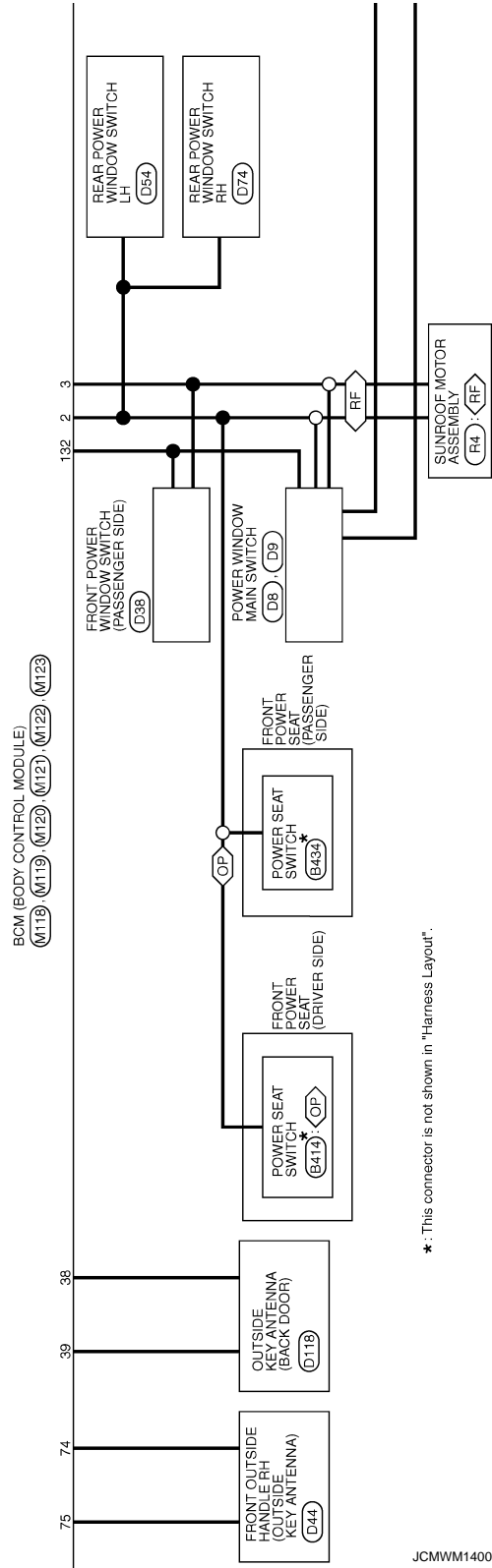
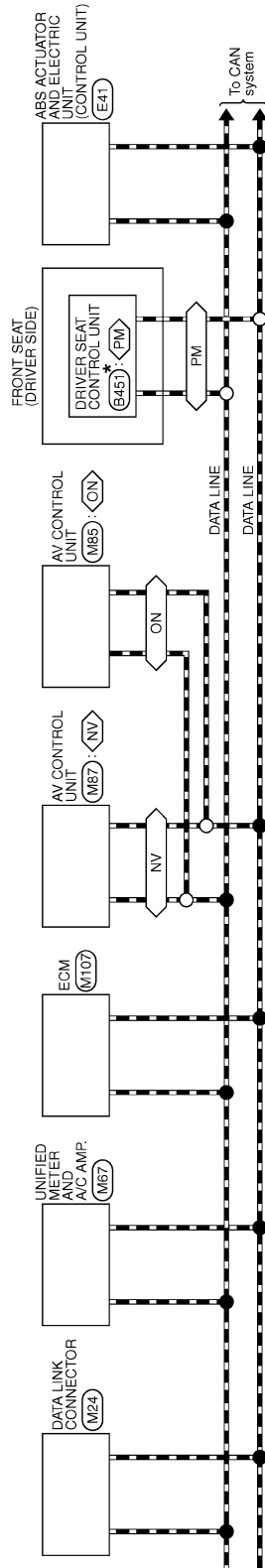

\* : This connector is not shown in "Harness Layout".

JCMWM1400G1

A  
B  
C  
D  
E  
F  
G  
H  
I  
J  
K  
L  
N  
O  
P

PCS

# BCM (BODY CONTROL MODULE)

## [POWER DISTRIBUTION SYSTEM]

< ECU DIAGNOSIS >

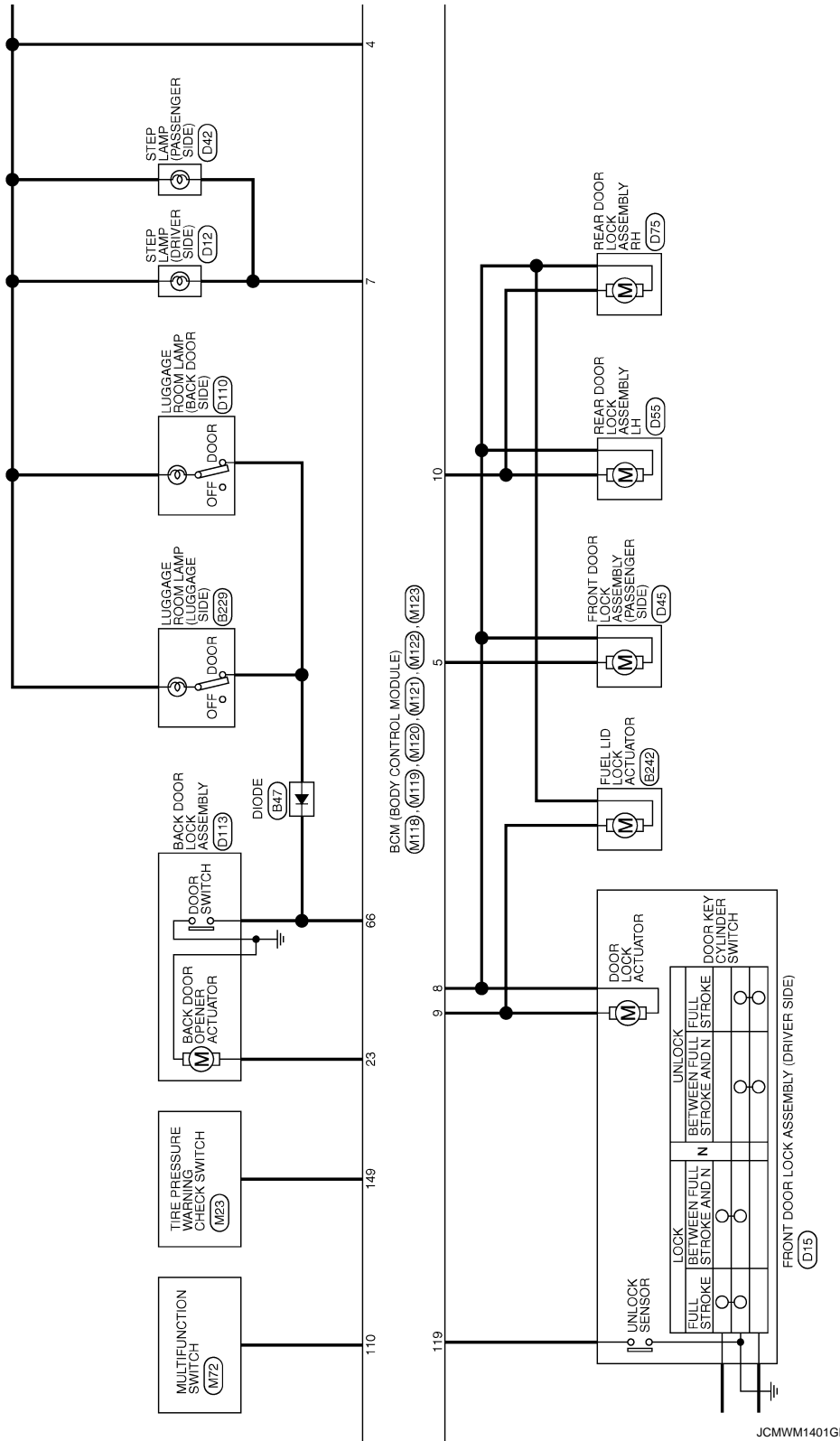

# BCM (BODY CONTROL MODULE)

## [POWER DISTRIBUTION SYSTEM]

< ECU DIAGNOSIS >

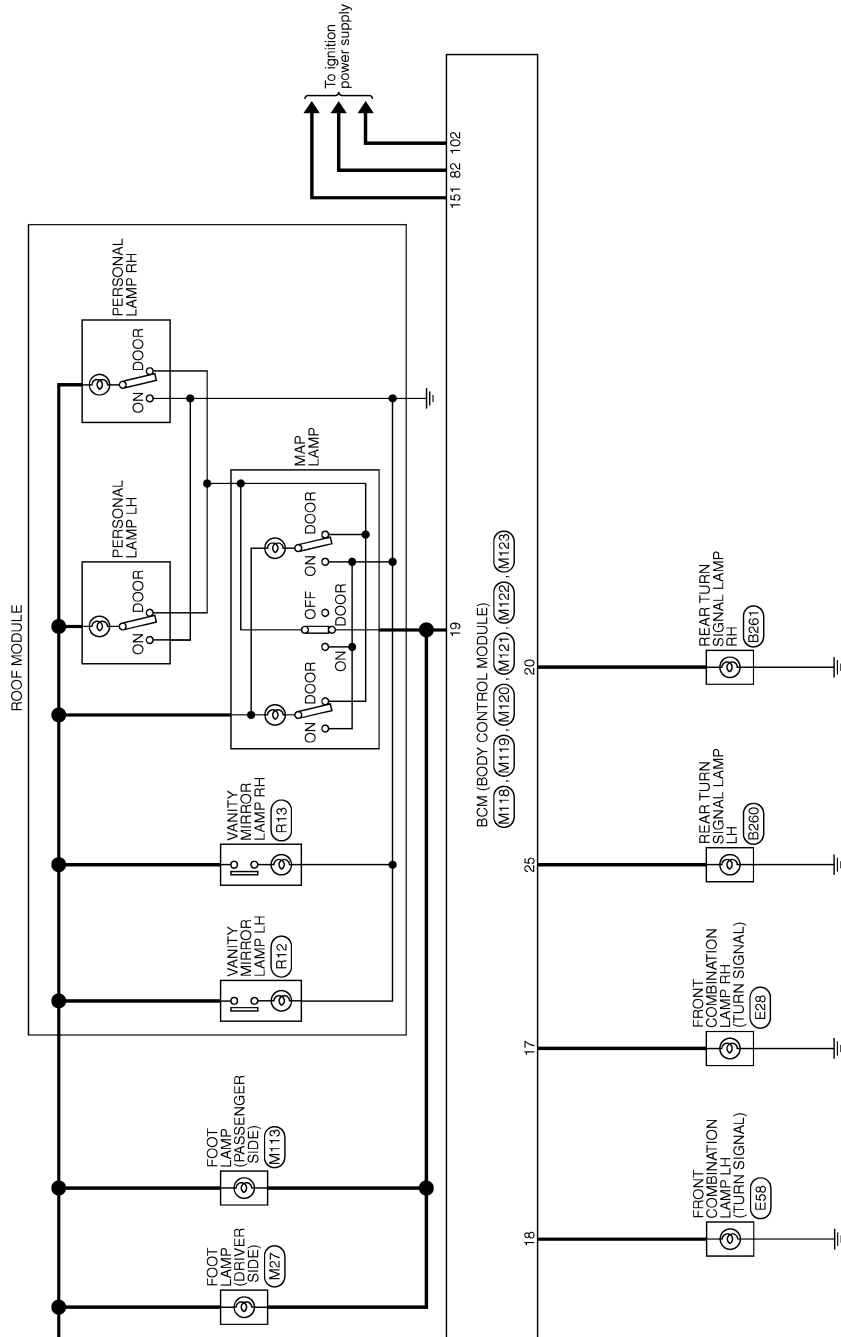

JCMWM1402GI

A  
B  
C  
D  
E  
F  
G  
H  
I  
J  
K  
L  
PCS  
N  
O  
P

# BCM (BODY CONTROL MODULE)

## [POWER DISTRIBUTION SYSTEM]

< ECU DIAGNOSIS >

**BCM (BODY CONTROL MODULE)**

Connector No.	M33
Connector Name	COMBINATION SWITCH
Connector Type	TH16FW-RH

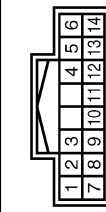

Terminal No.	Color of Wire	Signal Name [Specification]
2	SB	OUTPUT 4
5	L	OUTPUT 3
7	V	INPUT 3
8	O	OUTPUT 5
9	Y	INPUT 2
10	R	INPUT 4
11	LG	INPUT 1
12	P	OUTPUT 1
13	BR	INPUT 5
14	G	OUTPUT 2

Connector No.	M120
Connector Name	BCM (BODY CONTROL MODULE)
Connector Type	NS12FW-CS



Terminal No.	Color of Wire	Signal Name [Specification]
20	V	TURN SIGNAL RH (REAR)
23	G	BACK DOOR OPEN OUTPUT
25	G	TURN SIGNAL LH (REAR)
26	G	REAR WIPER OUTPUT

Connector No.	M118
Connector Name	BCM (BODY CONTROL MODULE)
Connector Type	M03FB-LC



Terminal No.	Color of Wire	Signal Name [Specification]
1	W	BAT (F/L)
2	Y	POWER WINDOW POWER SUPPLY(BAT)
3	O	POWER WINDOW POWER SUPPLY(TRAP)

Connector No.	M121
Connector Name	BCM (BODY CONTROL MODULE)
Connector Type	TH40FGY-NH



Terminal No.	Color of Wire	Signal Name [Specification]
34	SB	LUGGAGE ROOM ANTI-
35	V	LUGGAGE ROOM ANTI+
38	B	REAR BUMPER ANTI-
39	W	REAR BUMPER ANTI+
47	Y	IGN RELAY IPDM E/R CONT
52	SB	STARTER RELAY CONT
61	W	BACK DOOR OPENER REQUEST SW
64	V	REQUEST SW BUZZER
65	O	REAR WIPER STOP POSITION
66	R	BACK DOOR SW
67	GR	BACK DOOR OPENER SW

Connector No.	M119
Connector Name	BCM (BODY CONTROL MODULE)
Connector Type	NS16FW-CS

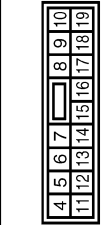

Terminal No.	Color of Wire	Signal Name [Specification]
4	LG	INTERIOR ROOM LAMP POWER SUPPLY
5	L	PASSSENGER DOOR UNLOCK OUTPUT
7	Y	STEP LAMP OUTPUT
8	V	ALL DOOR FUEL LID LOCK OUTPUT
9	G	DRIVER DOOR UNLOCK OUTPUT
10	BR	REAR DOOR UNLOCK OUTPUT
11	R	BAT (R/USE)
13	B	GND
14	W	PUSH-BUTTON IGNITION SW ILL GND
15	Y	ACC IND
17	W	TURN SIGNAL RH (FRONT)

68	BR	REAR RH DOOR SW
69	R	REAR LH DOOR SW

18	O	TURN SIGNAL LH (FRONT)
19	V	ROOM LAMP TIMER CONTROL

JCMWM1403G



# BCM (BODY CONTROL MODULE)

[POWER DISTRIBUTION SYSTEM]

< ECU DIAGNOSIS >

## BCM (BODY CONTROL MODULE)

Connector No.	M122
Connector Name	BCM (BODY CONTROL MODULE)
Connector Type	TH40FB-NH

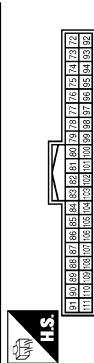

Terminal No.	Color of Wire	Signal Name [Specification]
72	R	ROOM ANT2-
73	G	ROOM ANT2+
74	SB	PASSENGER DOOR ANT-
75	GR	PASSENGER DOOR ANT+
76	V	DRIVER DOOR ANT-
77	LG	DRIVER DOOR ANT+
78	Y	ROOM ANTI-
79	BR	ROOM ANTI+
80	GR	IMMOBI ANTENNA CONTROL
81	W	IMMOBI ANTENNA SIGNAL
82	R	IGN RELAY (F/B) CONT

83	Y	KEYLESS TIMER SIGNAL
87	BR	COMBI SW INPUT 5
88	V	COMBI SW INPUT 3
89	BR	PUSH SW
90	P	CAN-L
91	L	CAN-H
92	LG	KEY SLOT ILL
93	Y	ON IND
94	Y	PUDDLE LAMP CONT
95	O	ACC RELAY CONT
96	GR	A-T DEVICE POWER SUPPLY
97	L	S/L CONDITION 1
98	P	S/L CONDITION 2
99	R	SHIFT P
100	G	PASSENGER DOOR REQUEST SW
101	SB	DRIVER DOOR REQUEST SW
102	O	BLOWER FAN MOTOR RELAY CONT
103	LG	KEYLESS ENTRY RECEIVER POWER SUPPLY
106	W	S/L POWER SUPPLY
107	LG	COMBI SW INPUT 1
108	R	COMBI SW INPUT 4
109	Y	COMBI SW INPUT 2
110	G	HAZARD SW
111	Y	S/L COMM

Connector No.	M123
Connector Name	BCM (BODY CONTROL MODULE)
Connector Type	TH40FG-NH

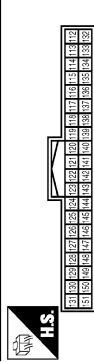

Terminal No.	Color of Wire	Signal Name [Specification]
113	P	OPICAL SENSOR
116	SB	FUSE CHECK
118	P	STOP LAMP SW
119	SB	DR DOOR UNLOCK SENSOR
121	BR	KEY S I O T SW
122	V	ACC F/B
123	W	IGN F/B
124	LG	PASSENGER DOOR SW
132	V	POWER WINDOW SW COMM
133	W	PUSH-BUTTON IGNITION SW ILL POWER
134	GR	LOCK IND

137	O	RECEIVER SENSOR GND
138	Y	RECEIVER SENSOR POWER SUPPLY
139	L	TIRE PRESS RECEIVER SIGNAL
140	GR	SHIFT N/P
141	G	SECURITY INDICATOR OUTPUT
142	O	COMBI SW OUTPUT 5
143	P	COMBI SW OUTPUT 1
144	G	COMBI SW OUTPUT 2
145	L	COMBI SW OUTPUT 3
146	SB	COMBI SW OUTPUT 4
149	W	TIRE PRESS WARNING CHECK SW
150	LG	DRIVER DOOR SW
151	G	REAR WINDOW DEFOGGER RELAY

A  
B  
C  
D  
E  
F  
G  
H  
I  
J  
K  
L  
N  
O  
P

PCS

### Fail-safe

**FAIL-SAFE CONTROL BY DTC**  
BCM performs fail-safe control when any DTC is detected.

# BCM (BODY CONTROL MODULE)

## [POWER DISTRIBUTION SYSTEM]

< ECU DIAGNOSIS >

Display contents of CONSULT	Fail-safe	Cancellation
B2013: ID DISCORD BCM-S/L	Inhibit engine cranking	Erase DTC
B2014: CHAIN OF S/L-BCM	Inhibit engine cranking	Erase DTC
B2190: NATS ANTENNA AMP	Inhibit engine cranking	Erase DTC
B2191: DIFFERENCE OF KEY	Inhibit engine cranking	Erase DTC
B2192: ID DISCORD BCM-ECM	Inhibit engine cranking	Erase DTC
B2193: CHAIN OF BCM-ECM	Inhibit engine cranking	Erase DTC
B2557: VEHICLE SPEED	Inhibit steering lock	When normal vehicle speed signals have been received from ABS actuator and electric unit (control unit) for 500 ms
B2560: STARTER CONT RELAY	Inhibit engine cranking	500 ms after the following CAN signal communication status has become consistent <ul style="list-style-type: none"> <li>• Starter control relay signal</li> <li>• Starter relay status signal</li> </ul>
B2601: SHIFT POSITION	Inhibit steering lock	500 ms after the following signal reception status becomes consistent <ul style="list-style-type: none"> <li>• Selector lever P position switch signal</li> <li>• P range signal (CAN)</li> </ul>
B2602: SHIFT POSITION	Inhibit steering lock	5 seconds after the following BCM recognition conditions are fulfilled <ul style="list-style-type: none"> <li>• Ignition switch is in the ON position</li> <li>• Selector lever P position switch signal: Except P position (battery voltage)</li> <li>• Vehicle speed: 4 km/h (2.5 MPH) or more</li> </ul>
B2603: SHIFT POSI STATUS	Inhibit steering lock	500 ms after the following BCM recognition conditions are fulfilled <ul style="list-style-type: none"> <li>• Ignition switch is in the ON position</li> <li>• Selector lever P position switch signal: Except P position (battery voltage)</li> <li>• Selector lever P/N position signal: Except P and N positions (0 V)</li> </ul>
B2604: PNP SW	Inhibit steering lock	500 ms after any of the following BCM recognition conditions is fulfilled <ul style="list-style-type: none"> <li>• Status 1               <ul style="list-style-type: none"> <li>- Ignition switch is in the ON position</li> <li>- Selector lever P/N position signal: P and N position (battery voltage)</li> <li>- P range signal or N range signal (CAN): ON</li> </ul> </li> <li>• Status 2               <ul style="list-style-type: none"> <li>- Ignition switch is in the ON position</li> <li>- Selector lever P/N position signal: Except P and N positions (0 V)</li> <li>- P range signal and N range signal (CAN): OFF</li> </ul> </li> </ul>
B2605: PNP SW	Inhibit steering lock	500 ms after any of the following BCM recognition conditions is fulfilled <ul style="list-style-type: none"> <li>• Ignition switch is in the ON position               <ul style="list-style-type: none"> <li>- Power position: IGN</li> <li>- Selector lever P/N position signal: Except P and N positions (0 V)</li> <li>- Interlock/PNP switch signal (CAN): OFF</li> </ul> </li> <li>• Status 2               <ul style="list-style-type: none"> <li>- Ignition switch is in the ON position</li> <li>- Selector lever P/N position signal: P or N position (battery voltage)</li> <li>- PNP switch signal (CAN): ON</li> </ul> </li> </ul>
B2606: S/L RELAY	Inhibit engine cranking	500 ms after the following CAN signal communication status has become consistent <ul style="list-style-type: none"> <li>• Steering lock relay signal (Request signal)</li> <li>• Steering lock relay signal (Condition signal)</li> </ul>
B2607: S/L RELAY	Inhibit engine cranking	500 ms after the following CAN signal communication status has become consistent <ul style="list-style-type: none"> <li>• Steering lock relay signal (Request signal)</li> <li>• Steering lock relay signal (Condition signal)</li> </ul>

# BCM (BODY CONTROL MODULE)

## [POWER DISTRIBUTION SYSTEM]

< ECU DIAGNOSIS >

Display contents of CONSULT	Fail-safe	Cancellation
B2608: STARTER RELAY	Inhibit engine cranking	500 ms after the following signal communication status becomes consistent <ul style="list-style-type: none"> <li>• Starter motor relay control signal</li> <li>• Starter relay status signal (CAN)</li> </ul>
B2609: S/L STATUS	<ul style="list-style-type: none"> <li>• Inhibit engine cranking</li> <li>• Inhibit steering lock</li> </ul>	When the following steering lock conditions agree <ul style="list-style-type: none"> <li>• BCM steering lock control status</li> <li>• Steering lock condition No. 1 signal status</li> <li>• Steering lock condition No. 2 signal status</li> </ul>
B260A: IGNITION RELAY	Inhibit engine cranking	500 ms after the following conditions are fulfilled <ul style="list-style-type: none"> <li>• IGN relay (IPDM E/R) control signal: OFF (Battery voltage)</li> <li>• Ignition ON signal (CAN to IPDM E/R): OFF (Request signal)</li> <li>• Ignition ON signal (CAN from IPDM E/R): OFF (Condition signal)</li> </ul>
B260F: ENG STATE SIG LOST	Maintains the power supply position attained at the time of DTC detection	When any of the following conditions is fulfilled <ul style="list-style-type: none"> <li>• Power position changes to ACC</li> <li>• Receives engine status signal (CAN)</li> </ul>
B2612: S/L STATUS	<ul style="list-style-type: none"> <li>• Inhibit engine cranking</li> <li>• Inhibit steering lock</li> </ul>	When any of the following conditions is fulfilled <ul style="list-style-type: none"> <li>• Steering lock unit status signal (CAN) is received normally</li> <li>• The BCM steering lock control status matches the steering lock status recognized by the steering lock unit status signal (CAN from IPDM E/R)</li> </ul>
B2617: STARTER RELAY CIRC	Inhibit engine cranking	1 second after the starter motor relay control inside BCM becomes normal
B2618: BCM	Inhibit engine cranking	1 second after the ignition relay (IPDM E/R) control inside BCM becomes normal
B2619: BCM	Inhibit engine cranking	1 second after the steering lock unit power supply output control inside BCM becomes normal
B261E: VEHICLE TYPE	Inhibit engine cranking	BCM initialization
B26E1: ENG STATE NO RECIV	Inhibit engine cranking	When any of the following conditions is fulfilled <ul style="list-style-type: none"> <li>• Power position changes to ACC</li> <li>• Receives engine status signal (CAN)</li> </ul>
B26E9: S/L STATUS	<ul style="list-style-type: none"> <li>• Inhibit engine cranking</li> <li>• Inhibit steering lock</li> </ul>	When BCM transmits the LOCK request signal to steering lock unit, and receives LOCK response signal from steering lock unit, the following conditions is fulfilled <ul style="list-style-type: none"> <li>• Steering condition No. 1 signal: LOCK (0V)</li> <li>• Steering condition No. 2 signal: LOCK (Battery voltage)</li> </ul>

### HIGH FLASHER OPERATION

BCM detects the turn signal lamp circuit status by the current value.

BCM increases the turn signal lamp blinking speed if the bulb or harness open is detected with the turn signal lamp operating.

#### NOTE:

The blinking speed is normal while activating the hazard warning lamp.

### DTC Inspection Priority Chart

INFOID:000000003786304

If some DTCs are displayed at the same time, perform inspections one by one based on the following priority chart.

Priority	DTC
1	B2562: LOW VOLTAGE
2	<ul style="list-style-type: none"> <li>• U1000: CAN COMM CIRCUIT</li> <li>• U1010: CONTROL UNIT (CAN)</li> </ul>
3	<ul style="list-style-type: none"> <li>• B2190: NATS ANTENNA AMP</li> <li>• B2191: DIFFERENCE OF KEY</li> <li>• B2192: ID DISCORD BCM-ECM</li> <li>• B2193: CHAIN OF BCM-ECM</li> </ul>

# BCM (BODY CONTROL MODULE)

< ECU DIAGNOSIS >

[POWER DISTRIBUTION SYSTEM]

Priority	DTC
4	<ul style="list-style-type: none"> <li>• B2013: ID DISCORD BCM-S/L</li> <li>• B2014: CHAIN OF S/L-BCM</li> <li>• B2553: IGNITION RELAY</li> <li>• B2555: STOP LAMP</li> <li>• B2556: PUSH-BTN IGN SW</li> <li>• B2557: VEHICLE SPEED</li> <li>• B2560: STARTER CONT RELAY</li> <li>• B2601: SHIFT POSITION</li> <li>• B2602: SHIFT POSITION</li> <li>• B2603: SHIFT POSI STATUS</li> <li>• B2604: PNP SW</li> <li>• B2605: PNP SW</li> <li>• B2606: S/L RELAY</li> <li>• B2607: S/L RELAY</li> <li>• B2608: STARTER RELAY</li> <li>• B2609: S/L STATUS</li> <li>• B260A: IGNITION RELAY</li> <li>• B260B: STEERING LOCK UNIT</li> <li>• B260C: STEERING LOCK UNIT</li> <li>• B260D: STEERING LOCK UNIT</li> <li>• B260F: ENG STATE SIG LOST</li> <li>• B2612: S/L STATUS</li> <li>• B2614: ACC RELAY CIRC</li> <li>• B2615: BLOWER RELAY CIRC</li> <li>• B2616: IGN RELAY CIRC</li> <li>• B2617: STARTER RELAY CIRC</li> <li>• B2618: BCM</li> <li>• B2619: BCM</li> <li>• B261A: PUSH-BTN IGN SW</li> <li>• B261E: VEHICLE TYPE</li> <li>• B26E1: ENG STATE NO RECIV</li> <li>• B26E9: S/L STATUS</li> <li>• B26EA: KEY REGISTRATION</li> <li>• C1729: VHCL SPEED SIG ERR</li> <li>• U0415: VEHICLE SPEED SIG</li> </ul>
5	<ul style="list-style-type: none"> <li>• C1704: LOW PRESSURE FL</li> <li>• C1705: LOW PRESSURE FR</li> <li>• C1706: LOW PRESSURE RR</li> <li>• C1707: LOW PRESSURE RL</li> <li>• C1708: [NO DATA] FL</li> <li>• C1709: [NO DATA] FR</li> <li>• C1710: [NO DATA] RR</li> <li>• C1711: [NO DATA] RL</li> <li>• C1712: [CHECKSUM ERR] FL</li> <li>• C1713: [CHECKSUM ERR] FR</li> <li>• C1714: [CHECKSUM ERR] RR</li> <li>• C1715: [CHECKSUM ERR] RL</li> <li>• C1716: [PRESSDATA ERR] FL</li> <li>• C1717: [PRESSDATA ERR] FR</li> <li>• C1718: [PRESSDATA ERR] RR</li> <li>• C1719: [PRESSDATA ERR] RL</li> <li>• C1720: [CODE ERR] FL</li> <li>• C1721: [CODE ERR] FR</li> <li>• C1722: [CODE ERR] RR</li> <li>• C1723: [CODE ERR] RL</li> <li>• C1724: [BATT VOLT LOW] FL</li> <li>• C1725: [BATT VOLT LOW] FR</li> <li>• C1726: [BATT VOLT LOW] RR</li> <li>• C1727: [BATT VOLT LOW] RL</li> <li>• C1734: CONTROL UNIT</li> </ul>
6	<ul style="list-style-type: none"> <li>• B2621: INSIDE ANTENNA</li> <li>• B2622: INSIDE ANTENNA</li> <li>• B2623: INSIDE ANTENNA</li> </ul>

# BCM (BODY CONTROL MODULE)

[POWER DISTRIBUTION SYSTEM]

< ECU DIAGNOSIS >

## DTC Index

INFOID:000000003786305

### NOTE:

The details of time display are as follows.

- CRNT: A malfunction is detected now.
- PAST: A malfunction was detected in the past.

IGN counter is displayed on Freeze Frame Data. For details of Freeze Frame Data and IGN Counter, refer to [BCS-16, "COMMON ITEM : CONSULT-III Function \(BCM - COMMON ITEM\)"](#).

CONSULT display	Fail-safe	Freeze Frame Data	Intelligent Key warning lamp ON	Tire pressure monitor warning lamp ON	Reference page
No DTC is detected. further testing may be required.	—	—	—	—	—
U1000: CAN COMM CIRCUIT	—	—	—	—	<a href="#">BCS-37</a>
U1010: CONTROL UNIT (CAN)	—	—	—	—	<a href="#">BCS-38</a>
U0415: VEHICLE SPEED SIG	—	—	—	—	<a href="#">BCS-39</a>
B2013: ID DISCORD BCM-S/L	×	×	—	—	<a href="#">SEC-48</a>
B2014: CHAIN OF S/L-BCM	×	×	—	—	<a href="#">SEC-49</a>
B2190: NATS ANTENNA AMP	×	—	—	—	<a href="#">SEC-42</a>
B2191: DIFFERENCE OF KEY	×	—	—	—	<a href="#">SEC-45</a>
B2192: ID DISCORD BCM-ECM	×	—	—	—	<a href="#">SEC-46</a>
B2193: CHAIN OF BCM-ECM	×	—	—	—	<a href="#">SEC-47</a>
B2553: IGNITION RELAY	—	×	—	—	<a href="#">PCS-49</a>
B2555: STOP LAMP	—	×	—	—	<a href="#">SEC-52</a>
B2556: PUSH-BTN IGN SW	—	×	×	—	<a href="#">SEC-54</a>
B2557: VEHICLE SPEED	×	×	×	—	<a href="#">SEC-56</a>
B2560: STARTER CONT RELAY	×	×	×	—	<a href="#">SEC-57</a>
B2562: LOW VOLTAGE	—	×	—	—	<a href="#">BCS-40</a>
B2601: SHIFT POSITION	×	×	×	—	<a href="#">SEC-58</a>
B2602: SHIFT POSITION	×	×	×	—	<a href="#">SEC-61</a>
B2603: SHIFT POSI STATUS	×	×	×	—	<a href="#">SEC-63</a>
B2604: PNP SW	×	×	×	—	<a href="#">SEC-66</a>
B2605: PNP SW	×	×	×	—	<a href="#">SEC-68</a>
B2606: S/L RELAY	×	×	×	—	<a href="#">SEC-70</a>
B2607: S/L RELAY	×	×	×	—	<a href="#">SEC-71</a>
B2608: STARTER RELAY	×	×	×	—	<a href="#">SEC-73</a>
B2609: S/L STATUS	×	×	×	—	<a href="#">SEC-75</a>
B260A: IGNITION RELAY	×	×	×	—	<a href="#">PCS-51</a>
B260B: STEERING LOCK UNIT	—	×	×	—	<a href="#">SEC-79</a>
B260C: STEERING LOCK UNIT	—	×	×	—	<a href="#">SEC-80</a>
B260D: STEERING LOCK UNIT	—	×	×	—	<a href="#">SEC-81</a>
B260F: ENG STATE SIG LOST	×	×	×	—	<a href="#">SEC-82</a>
B2612: S/L STATUS	×	×	×	—	<a href="#">SEC-86</a>
B2614: ACC RELAY CIRC	—	×	×	—	<a href="#">PCS-53</a>
B2615: BLOWER RELAY CIRC	—	×	×	—	<a href="#">PCS-57</a>
B2616: IGN RELAY CIRC	—	×	×	—	<a href="#">PCS-59</a>
B2617: STARTER RELAY CIRC	×	×	×	—	<a href="#">SEC-90</a>

# BCM (BODY CONTROL MODULE)

< ECU DIAGNOSIS >

[POWER DISTRIBUTION SYSTEM]

CONSULT display	Fail-safe	Freeze Frame Data	Intelligent Key warning lamp ON	Tire pressure monitor warning lamp ON	Reference page
B2618: BCM	×	×	×	—	<a href="#">PCS-61</a>
B2619: BCM	×	×	×	—	<a href="#">SEC-92</a>
B261A: PUSH-BTN IGN SW	—	×	×	—	<a href="#">SEC-93</a>
B261E: VEHICLE TYPE	×	×	× (Turn ON for 15 seconds)	—	<a href="#">SEC-96</a>
B2621: INSIDE ANTENNA	—	×	—	—	<a href="#">DLK-56</a>
B2622: INSIDE ANTENNA	—	×	—	—	<a href="#">DLK-58</a>
B2623: INSIDE ANTENNA	—	×	—	—	<a href="#">DLK-60</a>
B26E1: ENG STATE NO RES	×	×	×	—	<a href="#">SEC-83</a>
B26E9: S/L STATUS	×	×	× (Turn ON for 15 seconds)	—	<a href="#">SEC-84</a>
B26EA: KEY REGISTRATION	—	×	× (Turn ON for 15 seconds)	—	<a href="#">SEC-85</a>
C1704: LOW PRESSURE FL	—	—	—	×	<a href="#">WT-16</a>
C1705: LOW PRESSURE FR	—	—	—	×	
C1706: LOW PRESSURE RR	—	—	—	×	
C1707: LOW PRESSURE RL	—	—	—	×	
C1708: [NO DATA] FL	—	—	—	×	<a href="#">WT-18</a>
C1709: [NO DATA] FR	—	—	—	×	
C1710: [NO DATA] RR	—	—	—	×	
C1711: [NO DATA] RL	—	—	—	×	
C1712: [CHECKSUM ERR] FL	—	—	—	×	<a href="#">WT-21</a>
C1713: [CHECKSUM ERR] FR	—	—	—	×	
C1714: [CHECKSUM ERR] RR	—	—	—	×	
C1715: [CHECKSUM ERR] RL	—	—	—	×	
C1716: [PRESSDATA ERR] FL	—	—	—	×	<a href="#">WT-24</a>
C1717: [PRESSDATA ERR] FR	—	—	—	×	
C1718: [PRESSDATA ERR] RR	—	—	—	×	
C1719: [PRESSDATA ERR] RL	—	—	—	×	
C1720: [CODE ERR] FL	—	—	—	×	<a href="#">WT-26</a>
C1721: [CODE ERR] FR	—	—	—	×	
C1722: [CODE ERR] RR	—	—	—	×	
C1723: [CODE ERR] RL	—	—	—	×	
C1724: [BATT VOLT LOW] FL	—	—	—	×	<a href="#">WT-29</a>
C1725: [BATT VOLT LOW] FR	—	—	—	×	
C1726: [BATT VOLT LOW] RR	—	—	—	×	
C1727: [BATT VOLT LOW] RL	—	—	—	×	
C1729: VHCL SPEED SIG ERR	—	—	—	×	<a href="#">WT-32</a>
C1734: CONTROL UNIT	—	—	—	×	<a href="#">WT-33</a>

# IPDM E/R (INTELLIGENT POWER DISTRIBUTION MODULE ENGINE ROOM)

< ECU DIAGNOSIS >

[POWER DISTRIBUTION SYSTEM]

## IPDM E/R (INTELLIGENT POWER DISTRIBUTION MODULE ENGINE ROOM)

Reference Value

INFOID:000000003728605

### VALUES ON THE DIAGNOSIS TOOL

Monitor Item	Condition		Value/Status
RAD FAN REQ	Engine idle speed	Changes depending on engine coolant temperature, air conditioner operation status, vehicle speed, etc.	0 – 100 %
AC COMP REQ	Engine running	A/C switch OFF	Off
		A/C switch ON (Compressor is operating)	On
TAIL&CLR REQ	Lighting switch OFF		Off
	Lighting switch 1ST, 2ND, HI or AUTO (Light is illuminated)		On
HL LO REQ	Lighting switch OFF		Off
	Lighting switch 2ND HI or AUTO (Light is illuminated)		On
HL HI REQ	Lighting switch OFF		Off
	Lighting switch HI		On
FR FOG REQ	Lighting switch 2ND or AUTO (Light is illuminated)	Front fog lamp switch OFF	Off
		<ul style="list-style-type: none"> <li>• Front fog lamp switch ON</li> <li>• Daytime running light activated (Only for Canada)</li> </ul>	On
FR WIP REQ	Ignition switch ON	Front wiper switch OFF	Stop
		Front wiper switch INT	1LOW
		Front wiper switch LO	Low
		Front wiper switch HI	Hi
WIP AUTO STOP	Ignition switch ON	Front wiper stop position	STOP P
		Any position other than front wiper stop position	ACT P
WIP PROT	Ignition switch ON	Front wiper operates normally	Off
		Front wiper stops at fail-safe operation	BLOCK
IGN RLY1 -REQ	Ignition switch OFF or ACC		Off
	Ignition switch ON		On
IGN RLY	Ignition switch OFF or ACC		Off
	Ignition switch ON		On
PUSH SW	Release the push-button ignition switch		Off
	Press the push-button ignition switch		On
INTER/NP SW	Ignition switch ON	Selector lever in any position other than P or N	Off
		Selector lever in P or N position	On
ST RLY CONT	Ignition switch ON		Off
	At engine cranking		On
IHBT RLY -REQ	Ignition switch ON		Off
	At engine cranking		On

# IPDM E/R (INTELLIGENT POWER DISTRIBUTION MODULE ENGINE ROOM)

< ECU DIAGNOSIS >

[POWER DISTRIBUTION SYSTEM]

Monitor Item	Condition	Value/Status
ST/INHI RLY	Ignition switch ON	Off
	At engine cranking	INHI → ST
	The status of starter relay or starter control relay cannot be recognized by the battery voltage malfunction, etc. when the starter relay is ON and the starter control relay is OFF	UNKWN
DETENT SW	Ignition switch ON <ul style="list-style-type: none"> <li>• Press the selector button with selector lever in P position</li> <li>• Selector lever in any position other than P</li> </ul>	Off
	Release the selector button with selector lever in P position	On
S/L RLY -REQ	None of the conditions below are present	Off
	<ul style="list-style-type: none"> <li>• Open the driver door after the ignition switch is turned OFF (for a few seconds)</li> <li>• Press the push-button ignition switch when the steering lock is activated</li> </ul>	On
S/L STATE	Steering lock is activated	LOCK
	Steering lock is deactivated	UNLOCK
	[DTC: B210A] is detected	UNKWN
DTRL REQ	<b>NOTE:</b> The item is indicated, but not monitored.	Off
OIL P SW	Ignition switch OFF, ACC or engine running	Open
	Ignition switch ON	Close
HOOD SW	Close the hood	Off
	Open the hood	On
HL WASHER REQ	<b>NOTE:</b> The item is indicated, but not monitored.	Off
THFT HRN REQ	Not operation	Off
	<ul style="list-style-type: none"> <li>• Panic alarm is activated</li> <li>• Horn is activated with VEHICLE SECURITY (THEFT WARNING) SYSTEM</li> </ul>	On
HORN CHIRP	Not operating	Off
	Door locking with Intelligent Key (horn chirp mode)	On
CRNRNG LMP REQ	<b>NOTE:</b> The item is indicated, but not monitored.	Off



# IPDM E/R (INTELLIGENT POWER DISTRIBUTION MODULE ENGINE ROOM)

< ECU DIAGNOSIS >

[POWER DISTRIBUTION SYSTEM]

## TERMINAL LAYOUT

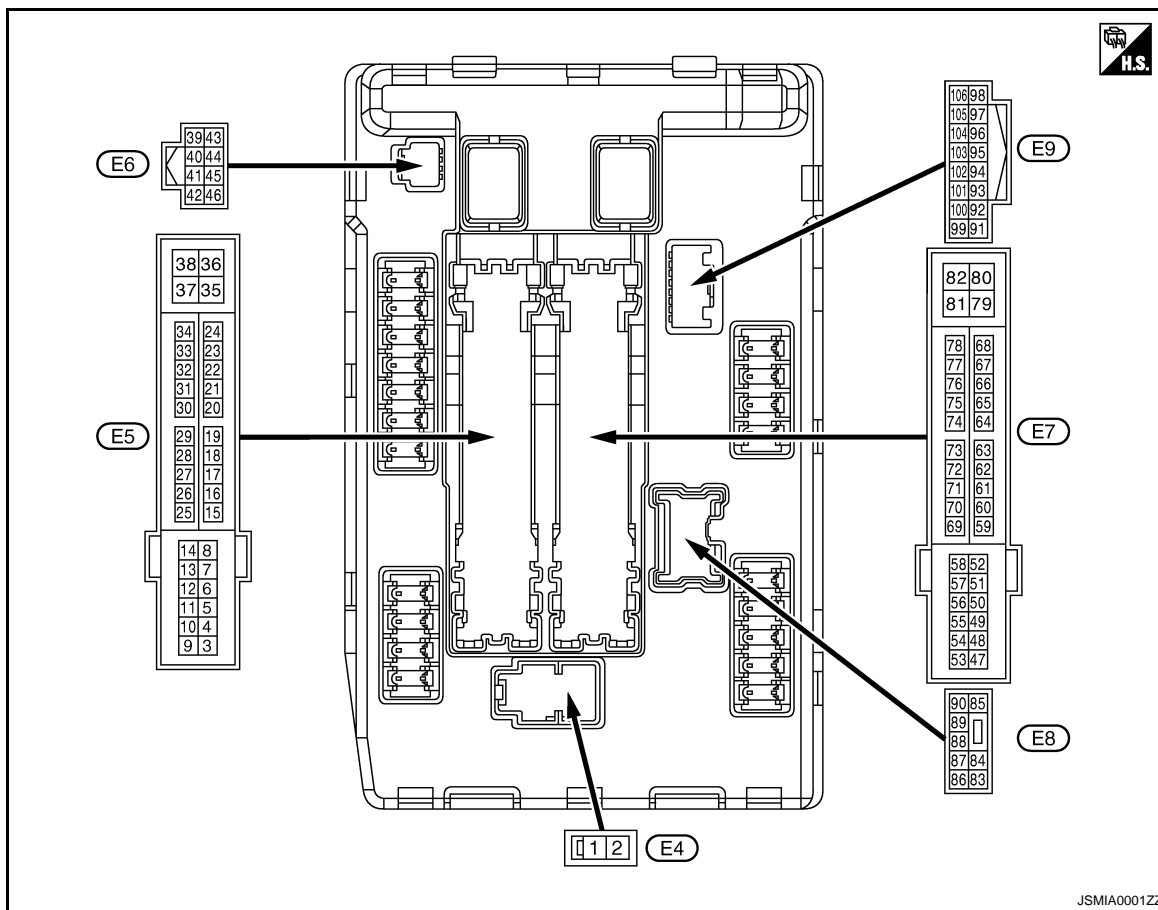

## PHYSICAL VALUES

Terminal No. (Wire color)		Description		Condition		Value (Approx.)
+	-	Signal name	Input/ Output			
1 (W)	Ground	Battery power supply	Input	Ignition switch OFF		Battery voltage
2 (L)	Ground	Battery power supply	Input	Ignition switch OFF		Battery voltage
4 (V)	Ground	Front wiper LO	Output	Ignition switch OFF	Front wiper switch OFF	0 V
				Ignition switch ON	Front wiper switch LO	Battery voltage
5 (L)	Ground	Front wiper HI	Output	Ignition switch OFF	Front wiper switch OFF	0 V
				Ignition switch ON	Front wiper switch HI	Battery voltage
7 (R)	Ground	Tail, license plate lamps & interior lamps	Output	Ignition switch OFF	Lighting switch OFF	0 V
				Ignition switch ON	Lighting switch 1ST	Battery voltage
11 (BR)	Ground	Steering lock unit power supply	Output	Ignition switch OFF	A few seconds after open- ing the driver door	Battery voltage
				Ignition switch LOCK	Press the push-button ig- nition switch	Battery voltage
				Ignition switch ACC or ON		0 V
12 (B/W)	Ground	Ground	—	Ignition switch ON		0 V

A  
B  
C  
D  
E  
F  
G  
H  
I  
J  
K  
L  
N  
O  
P

PCS

# IPDM E/R (INTELLIGENT POWER DISTRIBUTION MODULE ENGINE ROOM)

< ECU DIAGNOSIS >

[POWER DISTRIBUTION SYSTEM]

Terminal No. (Wire color)		Description		Condition		Value (Approx.)
+	-	Signal name	Input/ Output			
13 (SB)	Ground	Fuel pump power supply	Output	Approximately 1 second or more after turning the ignition switch ON		0 V
				<ul style="list-style-type: none"> <li>• Approximately 1 second after turning the ignition switch ON</li> <li>• Engine running</li> </ul>		Battery voltage
16 (LG)	Ground	Front wiper auto stop	Input	Ignition switch ON	Front wiper stop position	0 V
					Any position other than front wiper stop position	Battery voltage
19 (W)	Ground	Ignition relay power supply	Output	Ignition switch OFF		0 V
				Ignition switch ON		Battery voltage
25 (G)	Ground	Ignition relay power supply	Output	Ignition switch OFF		0 V
				Ignition switch ON		Battery voltage
26* (R)	Ground	Ignition relay power supply	Output	Ignition switch OFF		0 V
				Ignition switch ON		Battery voltage
27 (O)	Ground	Ignition relay monitor	Input	Ignition switch OFF or ACC		Battery voltage
				Ignition switch ON		0 V
28 (L)	Ground	Push-button ignition switch	Input	Press the push-button ignition switch		0 V
				Release the push-button ignition switch		Battery voltage
30 (GR)	Ground	Starter relay control	Input	Ignition switch ON	Selector lever in any position other than P or N	0 V
					Selector lever P or N	Battery voltage
32 (L)	Ground	Steering lock unit condition-1	Input	Steering lock is activated		0 V
				Steering lock is deactivated		Battery voltage
33 (P)	Ground	Steering lock unit condition-2	Input	Steering lock is activated		Battery voltage
				Steering lock is deactivated		0 V
36 (G)	Ground	Battery power supply	Input	Ignition switch OFF		Battery voltage
39 (P)	—	CAN-L	Input/ Output	—		—
40 (L)	—	CAN-H	Input/ Output	—		—
41 (B/W)	Ground	Ground	—	Ignition switch ON		0 V
42 (Y)	Ground	Cooling fan relay control	Input	Ignition switch OFF or ACC		0 V
				Ignition switch ON		0.7 V
43 (SB)	Ground	Control device (Detention switch)	Input	Ignition switch ON	<ul style="list-style-type: none"> <li>• Press the selector button (Selector lever P)</li> <li>• Selector lever in any position other than P</li> </ul>	Battery voltage
					Release the selector button (selector lever P)	0 V
44 (W)	Ground	Horn relay control	Input	The horn is deactivated		Battery voltage
				The horn is activated		0 V
45 (G)	Ground	Anti theft horn relay control	Input	The horn is deactivated		Battery voltage
				The horn is activated		0 V

# IPDM E/R (INTELLIGENT POWER DISTRIBUTION MODULE ENGINE ROOM)

< ECU DIAGNOSIS >

[POWER DISTRIBUTION SYSTEM]

Terminal No. (Wire color)		Description		Condition		Value (Approx.)	
46 (R)	Ground	Starter relay control	Input	Ignition switch ON	Selector lever in any position other than P or N	0 V	A
					Selector lever P or N	Battery voltage	B
48 (L)	Ground	A/C relay power supply	Output	Engine running	A/C switch OFF	0 V	C
					A/C switch ON (A/C compressor is operating)	Battery voltage	D
49 (R)	Ground	ECM relay power supply	Output		Ignition switch OFF (More than a few seconds after turning ignition switch OFF)	0 V	E
					<ul style="list-style-type: none"> <li>• Ignition switch ON</li> <li>• Ignition switch OFF (For a few seconds after turning ignition switch OFF)</li> </ul>	Battery voltage	F
51 (G)	Ground	Ignition relay power supply	Output		Ignition switch OFF	0 V	G
					Ignition switch ON	Battery voltage	H
53 (W)	Ground	ECM relay power supply	Output		Ignition switch OFF (More than a few seconds after turning ignition switch OFF)	0 V	I
					<ul style="list-style-type: none"> <li>• Ignition switch ON</li> <li>• Ignition switch OFF (For a few seconds after turning ignition switch OFF)</li> </ul>	Battery voltage	J
54 (LG)	Ground	Throttle control motor relay power supply	Output		Ignition switch OFF (More than a few seconds after turning ignition switch OFF)	0 V	K
					<ul style="list-style-type: none"> <li>• Ignition switch ON</li> <li>• Ignition switch OFF (For a few seconds after turning ignition switch OFF)</li> </ul>	Battery voltage	L
55 (BR)	Ground	ECM power supply	Output		Ignition switch OFF	Battery voltage	
56 (V)	Ground	Ignition relay power supply	Output		Ignition switch OFF	0 V	
					Ignition switch ON	Battery voltage	
57 (SB)	Ground	Ignition relay power supply	Output		Ignition switch OFF	0 V	
					Ignition switch ON	Battery voltage	PCS
58 (P)	Ground	Ignition relay power supply	Output		Ignition switch OFF	0 V	
					Ignition switch ON	Battery voltage	N
69 (W)	Ground	ECM relay control	Output		Ignition switch OFF (More than a few seconds after turning ignition switch OFF)	Battery voltage	
					<ul style="list-style-type: none"> <li>• Ignition switch ON</li> <li>• Ignition switch OFF (For a few seconds after turning ignition switch OFF)</li> </ul>	0 – 1.5 V	O
70 (O)	Ground	Throttle control motor relay control	Output		Ignition switch ON → OFF	0 – 1.0 V ↓ Battery voltage ↓ 0 V	
					Ignition switch ON	0 – 1.0 V	P

# IPDM E/R (INTELLIGENT POWER DISTRIBUTION MODULE ENGINE ROOM)

< ECU DIAGNOSIS >

[POWER DISTRIBUTION SYSTEM]

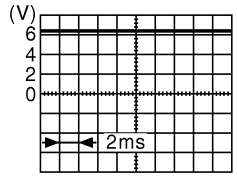
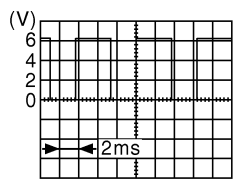
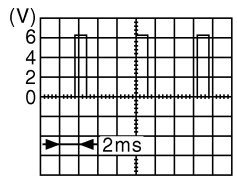
Terminal No. (Wire color)		Description		Condition		Value (Approx.)
+	-					
74 (P)	Ground	Ignition relay power supply	Output	Ignition switch OFF		0 V
				Ignition switch ON		Battery voltage
75 (Y)	Ground	Oil pressure switch	Input	Ignition switch ON	Engine stopped	0 V
					Engine running	Battery voltage
76 (V)	Ground	Power generation command signal	Output	Ignition switch ON		 <p style="text-align: center;">6.3 V</p>
				40% is set on "ACTIVE TEST", "ALTERNATOR DUTY" of "ENGINE"		 <p style="text-align: center;">3.8 V</p>
				80% is set on "ACTIVE TEST", "ALTERNATOR DUTY" of "ENGINE"		 <p style="text-align: center;">1.4 V</p>
77 (L)	Ground	Fuel pump relay control	Output	<ul style="list-style-type: none"> <li>Approximately 1 second after turning the ignition switch ON</li> <li>Engine running</li> </ul>		0 – 1.0 V
				Approximately 1 second or more after turning the ignition switch ON		Battery voltage
80 (W)	Ground	Starter motor	Output	At engine cranking		Battery voltage
83 (O)	Ground	Headlamp LO (RH)	Output	Ignition switch ON	Lighting switch OFF	0 V
					Lighting switch 2ND	Battery voltage
84 (V)	Ground	Headlamp LO (LH)	Output	Ignition switch ON	Lighting switch OFF	0 V
					Lighting switch 2ND	Battery voltage
86 (W)	Ground	Front fog lamp (RH)	Output	Lighting switch 2ND	<ul style="list-style-type: none"> <li>Front fog lamp switch ON</li> <li>Daytime running light activated (Only for Canada)</li> </ul>	Battery voltage
					Front fog lamp switch OFF	0 V

# IPDM E/R (INTELLIGENT POWER DISTRIBUTION MODULE ENGINE ROOM)

< ECU DIAGNOSIS >

[POWER DISTRIBUTION SYSTEM]

Terminal No. (Wire color)		Description		Condition		Value (Approx.)
+	-	Signal name	Input/ Output			
87 (L)	Ground	Front fog lamp (LH)	Output	Lighting switch 2ND	<ul style="list-style-type: none"> <li>• Front fog lamp switch ON</li> <li>• Daytime running light activated (Only for Canada)</li> </ul>	Battery voltage
				Front fog lamp switch OFF	0 V	
88 (GR)	Ground	Washer pump power supply	Output	Ignition switch ON		Battery voltage
89 (BR)	Ground	Headlamp HI (RH)	Output	Ignition switch ON	<ul style="list-style-type: none"> <li>• Lighting switch HI</li> <li>• Lighting switch PASS</li> </ul>	Battery voltage
				Lighting switch OFF	0 V	
90 (P)	Ground	Headlamp HI (LH)	Output	Ignition switch ON	<ul style="list-style-type: none"> <li>• Lighting switch HI</li> <li>• Lighting switch PASS</li> </ul>	Battery voltage
				Lighting switch OFF	0 V	
91 (P)	Ground	Parking lamp (RH)	Output	Ignition switch ON	Lighting switch 1ST	Battery voltage
				Lighting switch OFF	0 V	
92 (O)	Ground	Parking lamp (LH)	Output	Ignition switch ON	Lighting switch 1ST	Battery voltage
				Lighting switch OFF	0 V	
97 (V)	Ground	Cooling fan control	Output	Engine idling		0 – 5 V
104 (LG)	Ground	Hood switch	Input	Close the hood		Battery voltage
				Open the hood		0 V

\*: Only for the models with ICC system

A  
B  
C  
D  
E  
F  
G  
H  
I  
J  
K  
L  
N  
O  
P

PCS

# IPDM E/R (INTELLIGENT POWER DISTRIBUTION MODULE ENGINE ROOM)

< ECU DIAGNOSIS >

[POWER DISTRIBUTION SYSTEM]

## Wiring Diagram - IPDM E/R -

INFOID:000000003756961

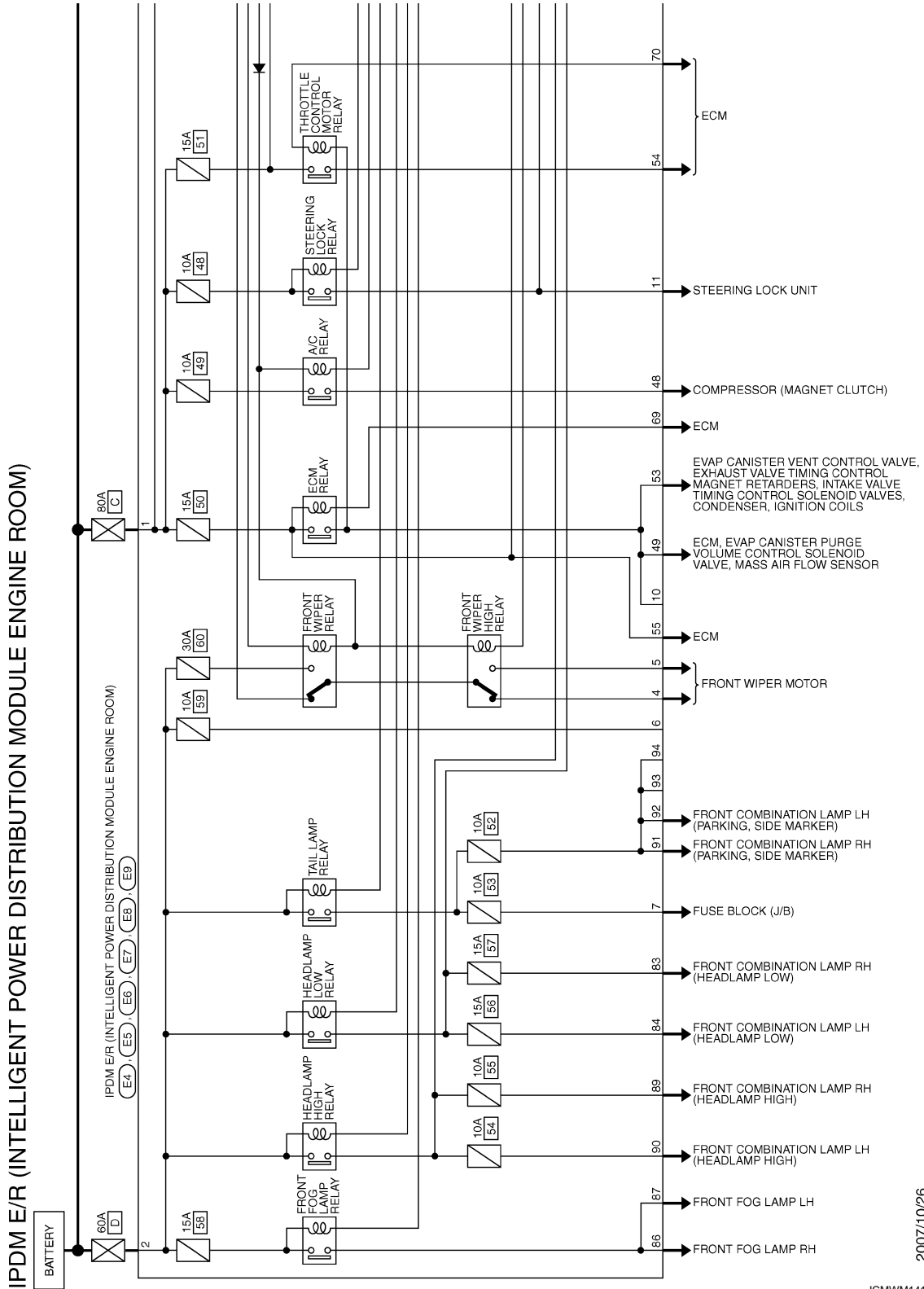

2007/10/26

JCMWM1411GI

# IPDM E/R (INTELLIGENT POWER DISTRIBUTION MODULE ENGINE ROOM)

< ECU DIAGNOSIS >

[POWER DISTRIBUTION SYSTEM]

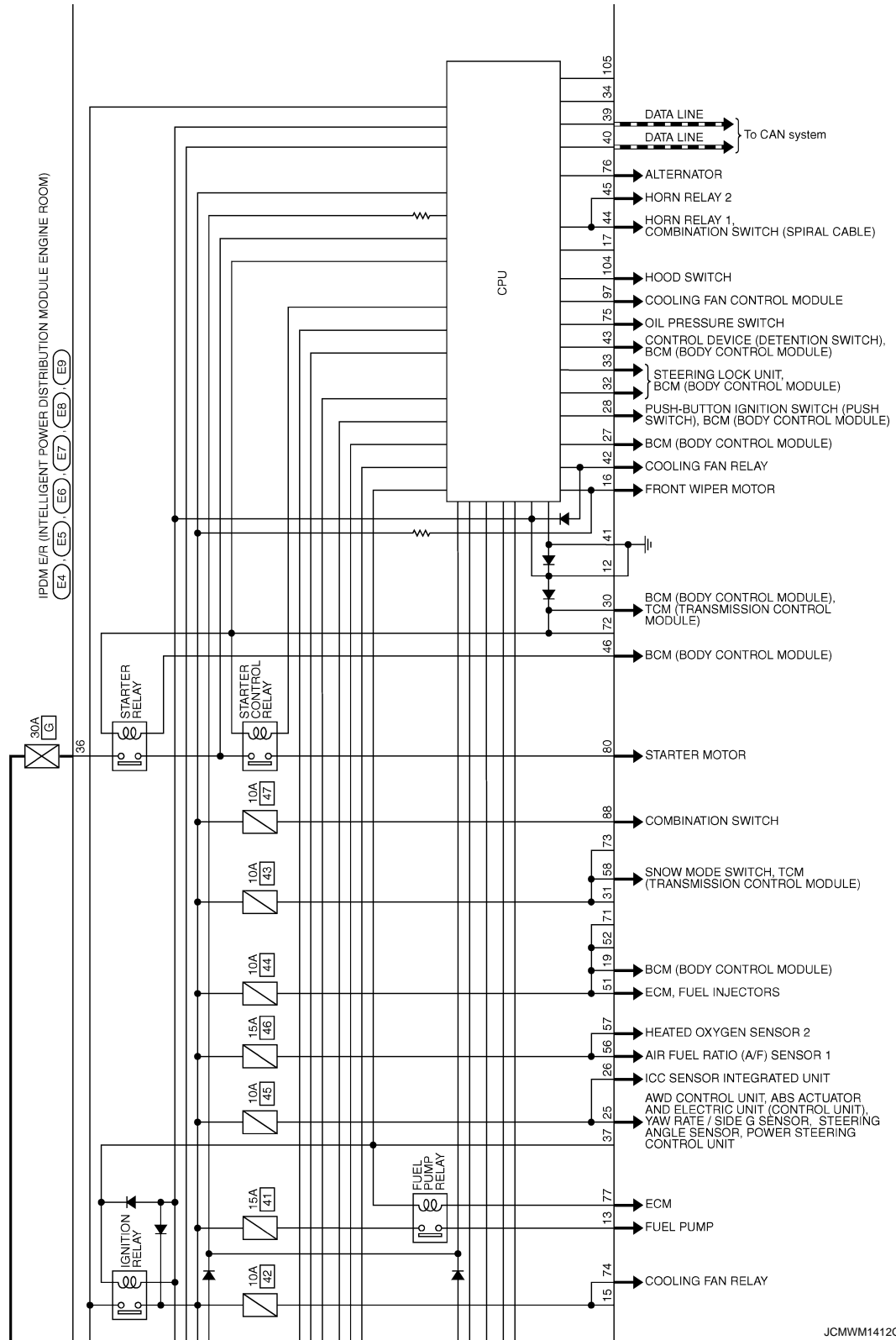

JCMWM1412G1

A  
B  
C  
D  
E  
F  
G  
H  
I  
J  
K  
L  
PCS  
N  
O  
P

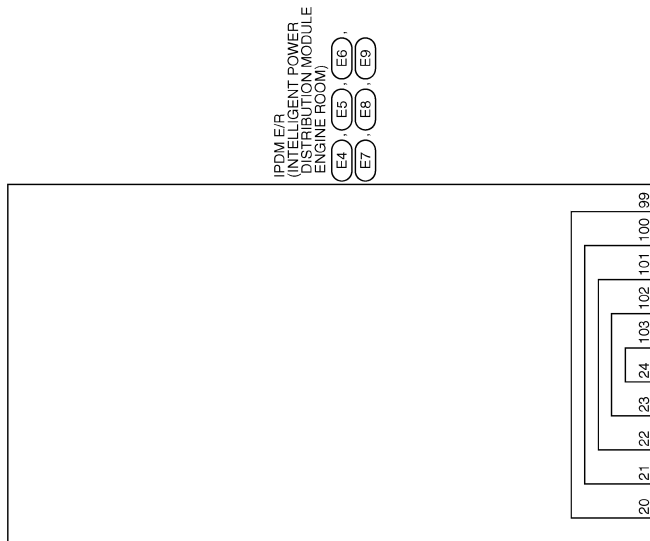

JCMWM1413G





# IPDM E/R (INTELLIGENT POWER DISTRIBUTION MODULE ENGINE ROOM)

< ECU DIAGNOSIS >

[POWER DISTRIBUTION SYSTEM]

**IPDM E/R (INTELLIGENT POWER DISTRIBUTION MODULE ENGINE ROOM)**



Connector No.	E6
Connector Name	IPDM E/R (INTELLIGENT POWER DISTRIBUTION MODULE ENGINE ROOM)
Connector Type	TH183FW-NH

Terminal No.	Color of Wire	Signal Name [Specification]
39	P	-
40	L	-
41	B/W	-
42	Y	-
43	SB	-
44	W	-
45	G	-
46	R	-

**IPDM E/R (INTELLIGENT POWER DISTRIBUTION MODULE ENGINE ROOM)**

Connector No.	E9
Connector Name	IPDM E/R (INTELLIGENT POWER DISTRIBUTION MODULE ENGINE ROOM)
Connector Type	TH183FW-NH





Terminal No.	Color of Wire	Signal Name [Specification]
91	P	-
92	O	-
97	V	-
104	LG	-

28	L	-
30	GR	-
32	L	-
33	P	-
36	G	-

**IPDM E/R (INTELLIGENT POWER DISTRIBUTION MODULE ENGINE ROOM)**

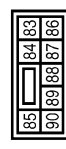

Connector No.	E8
Connector Name	IPDM E/R (INTELLIGENT POWER DISTRIBUTION MODULE ENGINE ROOM)
Connector Type	NS08FW-CS

Terminal No.	Color of Wire	Signal Name [Specification]
83	O	-
84	V	-
86	W	-
87	L	-
88	GR	-
89	BR	-
90	P	-

**IPDM E/R (INTELLIGENT POWER DISTRIBUTION MODULE ENGINE ROOM)**

Connector No.	E5
Connector Name	IPDM E/R (INTELLIGENT POWER DISTRIBUTION MODULE ENGINE ROOM)
Connector Type	TH20FW-CS12-M4-1V

Terminal No.	Color of Wire	Signal Name [Specification]
4	V	-
5	L	-
7	R	-
11	BR	-
12	B/W	-
13	SB	-
16	LG	-
19	W	-
25	G	-
26	R	-
27	O	-

74	P	-
75	Y	-
76	V	-
77	L	-
80	W	-

**IPDM E/R (INTELLIGENT POWER DISTRIBUTION MODULE ENGINE ROOM)**

Connector No.	E4
Connector Name	IPDM E/R (INTELLIGENT POWER DISTRIBUTION MODULE ENGINE ROOM)
Connector Type	LOPE-MC



Terminal No.	Color of Wire	Signal Name [Specification]
1	W	-
2	L	-

**IPDM E/R (INTELLIGENT POWER DISTRIBUTION MODULE ENGINE ROOM)**

Connector No.	E7
Connector Name	IPDM E/R (INTELLIGENT POWER DISTRIBUTION MODULE ENGINE ROOM)
Connector Type	TH20FW-CS12-M4

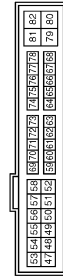
Terminal No.	Color of Wire	Signal Name [Specification]
48	L	-
49	R	-
51	G	-
53	W	-
54	LG	-
55	BR	-
56	V	-
57	SB	-
58	P	-
68	W	-
70	O	-

## Fail-safe

### CAN COMMUNICATION CONTROL

When CAN communication with ECM and BCM is impossible, IPDM E/R performs fail-safe control. After CAN communication recovers normally, it also returns to normal control.

If No CAN Communication Is Available With ECM

JCMWM1414G1

INFOID:000000003728642

A  
B  
C  
D  
E  
F  
G  
H  
I  
J  
K  
L  
N  
O  
P

PCS

# IPDM E/R (INTELLIGENT POWER DISTRIBUTION MODULE ENGINE ROOM)

< ECU DIAGNOSIS >

[POWER DISTRIBUTION SYSTEM]

Control part	Fail-safe operation
Cooling fan	<ul style="list-style-type: none"> <li>• Outputs the pulse duty signal (PWM signal) 100% when the ignition switch is turned ON</li> <li>• Outputs the pulse duty signal (PWM signal) 0% when the ignition switch is turned OFF</li> </ul>
A/C compressor	A/C relay OFF
Alternator	Outputs the power generation command signal (PWM signal) 0%

If No CAN Communication Is Available With BCM

Control part	Fail-safe operation
Headlamp	<ul style="list-style-type: none"> <li>• Turns ON the headlamp low relay when the ignition switch is turned ON</li> <li>• Turns OFF the headlamp low relay when the ignition switch is turned OFF</li> <li>• Headlamp high relay OFF</li> </ul>
<ul style="list-style-type: none"> <li>• Parking lamps</li> <li>• License plate lamps</li> <li>• Side maker lamps</li> <li>• Illuminations</li> <li>• Tail lamps</li> </ul>	<ul style="list-style-type: none"> <li>• Turns ON the tail lamp relay when the ignition switch is turned ON</li> <li>• Turns OFF the tail lamp relay when the ignition switch is turned OFF</li> </ul>
Front wiper	<ul style="list-style-type: none"> <li>• The status just before activation of fail-safe control is maintained until the ignition switch is turned OFF while the front wiper is operating at LO or HI speed.</li> <li>• The wiper is operated at LO speed until the ignition switch is turned OFF if the fail-safe control is activated while the front wiper is set in the INT mode and the front wiper motor is operating.</li> </ul>
Front fog lamps	Front fog lamp relay OFF
Horn	Horn OFF
Ignition relay	The status just before activation of fail-safe is maintained.
Starter motor	Starter control relay OFF
Steering lock unit	Steering lock relay OFF

## IGNITION RELAY MALFUNCTION DETECTION FUNCTION

- IPDM E/R monitors the voltage at the contact circuit and excitation coil circuit of the ignition relay inside it.
- IPDM E/R judges the ignition relay error if the voltage differs between the contact circuit and the excitation coil circuit.
- If the ignition relay cannot turn OFF due to contact seizure, it activates the tail lamp relay for 10 minutes to alert the user to the ignition relay malfunction when the ignition switch is turned OFF.

Voltage judgment		IPDM E/R judgment	Operation
Ignition relay contact side	Ignition relay excitation coil side		
ON	ON	Ignition relay ON normal	—
OFF	OFF	Ignition relay OFF normal	—
ON	OFF	Ignition relay ON stuck	<ul style="list-style-type: none"> <li>• Detects DTC "B2098: IGN RELAY ON"</li> <li>• Turns ON the tail lamp relay for 10 minutes</li> </ul>
OFF	ON	Ignition relay OFF stuck	Detects DTC "B2099: IGN RELAY OFF"

## FRONT WIPER CONTROL

IPDM E/R detects front wiper stop position by a front wiper auto stop signal.

When a front wiper auto stop signal is in the conditions listed below, IPDM E/R stops power supply to wiper after repeating a front wiper 10 seconds activation and 20 seconds stop five times.

# IPDM E/R (INTELLIGENT POWER DISTRIBUTION MODULE ENGINE ROOM)

< ECU DIAGNOSIS >

[POWER DISTRIBUTION SYSTEM]

Ignition switch	Front wiper switch	Front wiper auto stop signal
ON	OFF	The front wiper auto stop signal (stop position) cannot be input for 10 seconds.
	ON	The front wiper auto stop signal does not change for 10 seconds.

**NOTE:**

This operation status can be confirmed on the IPDM E/R “Data Monitor” that displays “BLOCK” for the item “WIP PROT” while the wiper is stopped.

**STARTER MOTOR PROTECTION FUNCTION**

IPDM E/R turns OFF the starter control relay to protect the starter motor when the starter control relay remains active for 90 seconds.

**DTC Index**

INFOID:000000003728643

**NOTE:**

- The details of time display are as follows.
  - CRNT: A malfunction is detected now
  - PAST: A malfunction was detected in the past.
- IGN counter is displayed on FFD (Freeze Frame data).
  - The number is 0 when is detected now
  - The number increases like 1 → 2 ... 38 → 39 after returning to the normal condition whenever IGN OFF → ON.
  - The number is fixed to 39 until the self-diagnosis results are erased if it is over 39.

CONSULT display	Fail-safe	Reference
No DTC is detected. further testing may be required.	—	—
U1000: CAN COMM CIRCUIT	×	<a href="#">PCS-16</a>
B2098: IGN RELAY ON	×	<a href="#">PCS-17</a>
B2099: IGN RELAY OFF	—	<a href="#">PCS-18</a>
B2108: STRG LCK RELAY ON	—	<a href="#">SEC-97</a>
B2109: STRG LCK RELAY OFF	—	<a href="#">SEC-98</a>
B210A: STRG LCK STATE SW	—	<a href="#">SEC-99</a>
B210B: START CONT RLY ON	—	<a href="#">SEC-103</a>
B210C: START CONT RLY OFF	—	<a href="#">SEC-104</a>
B210D: STARTER RELAY ON	—	<a href="#">SEC-105</a>
B210E: STARTER RELAY OFF	—	<a href="#">SEC-106</a>
B210F: INTRLCK/PNP SW ON	—	<a href="#">SEC-108</a>
B2110: INTRLCK/PNP SW OFF	—	<a href="#">SEC-110</a>

×: Applicable

PCS

## PRECAUTION

### PRECAUTIONS

#### Precaution for Supplemental Restraint System (SRS) "AIR BAG" and "SEAT BELT PRE-TENSIONER"

INFOID:000000003728816

The Supplemental Restraint System such as "AIR BAG" and "SEAT BELT PRE-TENSIONER", used along with a front seat belt, helps to reduce the risk or severity of injury to the driver and front passenger for certain types of collision. This system includes seat belt switch inputs and dual stage front air bag modules. The SRS system uses the seat belt switches to determine the front air bag deployment, and may only deploy one front air bag, depending on the severity of a collision and whether the front occupants are belted or unbelted. Information necessary to service the system safely is included in the "SRS AIRBAG" and "SEAT BELT" of this Service Manual.

**WARNING:**

- To avoid rendering the SRS inoperative, which could increase the risk of personal injury or death in the event of a collision which would result in air bag inflation, all maintenance must be performed by an authorized NISSAN/INFINITI dealer.
- Improper maintenance, including incorrect removal and installation of the SRS, can lead to personal injury caused by unintentional activation of the system. For removal of Spiral Cable and Air Bag Module, see the "SRS AIRBAG".
- Do not use electrical test equipment on any circuit related to the SRS unless instructed to in this Service Manual. SRS wiring harnesses can be identified by yellow and/or orange harnesses or harness connectors.

#### Precaution Necessary for Steering Wheel Rotation after Battery Disconnect

INFOID:000000003728817

**NOTE:**

- Before removing and installing any control units, first turn the push-button ignition switch to the LOCK position, then disconnect both battery cables.
- After finishing work, confirm that all control unit connectors are connected properly, then re-connect both battery cables.
- Always use CONSULT-III to perform self-diagnosis as a part of each function inspection after finishing work. If a DTC is detected, perform trouble diagnosis according to self-diagnosis results.

This vehicle is equipped with a push-button ignition switch and a steering lock unit.

If the battery is disconnected or discharged, the steering wheel will lock and cannot be turned.

If turning the steering wheel is required with the battery disconnected or discharged, follow the procedure below before starting the repair operation.

#### OPERATION PROCEDURE

1. Connect both battery cables.

**NOTE:**

Supply power using jumper cables if battery is discharged.

2. Turn the push-button ignition switch to ACC position.  
(At this time, the steering lock will be released.)
3. Disconnect both battery cables. The steering lock will remain released with both battery cables disconnected and the steering wheel can be turned.
4. Perform the necessary repair operation.
5. When the repair work is completed, re-connect both battery cables. With the brake pedal released, turn the push-button ignition switch from ACC position to ON position, then to LOCK position. (The steering wheel will lock when the push-button ignition switch is turned to LOCK position.)
6. Perform self-diagnosis check of all control units using CONSULT-III.

# PRECAUTIONS

< PRECAUTION >

[POWER DISTRIBUTION SYSTEM]

## Precaution for Procedure without Cowl Top Cover

INFOID:000000003728855

When performing the procedure after removing cowl top cover, cover the lower end of windshield with urethane, etc.

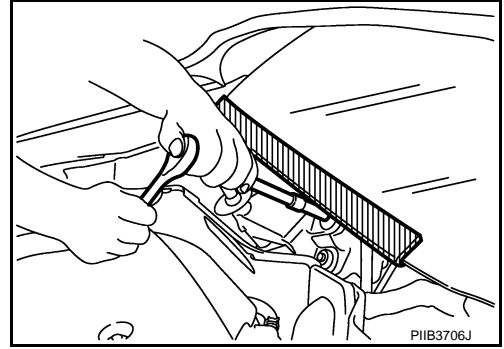

A  
B  
C  
D  
E  
F  
G  
H  
I  
J  
K  
L

PCS

N  
O  
P

# SYMPTOM DIAGNOSIS

## POWER DISTRIBUTION SYSTEM

### Symptom Table

INFOID:000000003586745

The engine start function, door lock function, power distribution system and NATS-IVIS/NVIS in the Intelligent Key system are closely related to each other regarding control. Narrow down the functional area in question by performing following table to identify which function is malfunctioning. The vehicle security function can operate only when the door lock and power distribution system are operating normally. Therefore, it is easy to identify any factor unique to the vehicle security system by performing following table.

Use the chart below to help you find the cause of the symptom. The numbers indicate the order of the inspection.

**NOTE:**

Before starting vehicle security system operation check, the following condition are met.

- Open front windows
- Turn ignition switch OFF
- Pull out Intelligent Key from key slot.

NO.	Function	Operation condition	Symptom	Diagnostic Item	Reference page
1	INTELLIGENT KEY SYSTEM/ DOOR LOCK FUNCTION	Lock/unlock door with door request switch. (Intelligent Key is into the outside key antenna detection area)	Door does not lock/unlock	—	<a href="#">DLK-169</a>
2	POWER DISTRIBUTION FUNCTION	Press push-button ignition switch under the following condition. • Selector lever position is in P or N position • Do not depress brake pedal	Push-button ignition switch is not operated	—	<a href="#">PCS-128</a>
3	INTELLIGENT KEY SYSTEM/ ENGINE START FUNCTION	Start engine with Intelligent Key into the vehicle (inside key antenna detection area)	Engine can not start with Intelligent Key	—	<a href="#">SEC-192</a>
4		Open the door after ignition switch turn ON to OFF	Steering is not locked	—	<a href="#">SEC-193</a>
5	NISSAN VEHICLE IMMOBILIZEER SYSTEM-NATS FUNCTION	Start engine with Intelligent Key into the key slot	Engine can not start	—	<a href="#">SEC-194</a>
6		Open the door after ignition switch turn ON to OFF	Steering is not locked	—	<a href="#">SEC-193</a>
7		Insert Intelligent Key into the key slot	Key slot indicator is not illuminate	—	<a href="#">SEC-201</a>

# POWER DISTRIBUTION SYSTEM

< SYMPTOM DIAGNOSIS >

[POWER DISTRIBUTION SYSTEM]

NO.	Function	Operation condition	Symptom	Diagnostic Item	Reference page
8	VEHICLE SECURITY SYSTEM	Lock all doors with Intelligent Key or door request switch	Vehicle security system can not be set	—	<a href="#">SEC-196</a>
		Lock all doors with door request switch		—	<a href="#">SEC-196</a>
		Lock all doors with door key cylinder		—	<a href="#">SEC-197</a>
		Lock all doors with Intelligent Key or door request switch	Security indicator does not turn ON	—	<a href="#">SEC-195</a>
		In the armed phase, open the door	Vehicle security alarm does not activate	Horn	<a href="#">SEC-198</a>
				Head lamp	
		When alarm sound, press Intelligent Key button	Vehicle security system can not be canceled	—	<a href="#">SEC-199</a>
		When alarm sound, press door request switch		—	<a href="#">SEC-199</a>
When alarm sound, operate door key cylinder	—	<a href="#">SEC-200</a>			
9	POWER DISTRIBUTION FUNCTION	Press push-button ignition switch under the following condition. <ul style="list-style-type: none"> <li>• Selector lever position is in P or N position</li> <li>• Do not depress brake pedal</li> </ul>	Push-button ignition switch position indicator does not illuminate	—	<a href="#">PCS-129</a>

A  
B  
C  
D  
E  
F  
G  
H  
I  
J  
K  
L

PCS

N  
O  
P

# PUSH-BUTTON IGNITION SWITCH DOES NOT OPERATE

< SYMPTOM DIAGNOSIS >

[POWER DISTRIBUTION SYSTEM]

---

## PUSH-BUTTON IGNITION SWITCH DOES NOT OPERATE

### Description

INFOID:000000003586746

- Before performing the diagnosis in the following table, check “Work Flow”. Refer to [PCS-36. "Work Flow"](#).
- Check that vehicle is under the condition shown in “Conditions of vehicle” before starting diagnosis, and check each symptom.

#### Conditions of Vehicle (Operating Conditions)

- “ENGINE START BY I-KEY” in “WORK SUPPORT” is ON when setting on CONSULT-III.
- One or more of Intelligent Keys with registered Intelligent Key ID is in the vehicle.

### Diagnosis Procedure

INFOID:000000003586747

#### 1. CHECK PUSH-BUTTON IGNITION SWITCH

---

Check push-button ignition switch.

Refer to [PCS-65. "Component Function Check"](#).

Is the inspection normal?

- YES >> GO TO 2.
- NO >> Repair or replace malfunctioning parts.

#### 2. CONFIRM THE OPERATION

---

Confirm the operation again.

Is the inspection normal?

- YES >> Check intermittent incident. Refer to [GI-38. "Intermittent Incident"](#).
- NO >> GO TO 1.



# PUSH-BUTTON IGNITION SWITCH POSITION INDICATOR DOES NOT ILLUMINATE

< SYMPTOM DIAGNOSIS >

[POWER DISTRIBUTION SYSTEM]

## PUSH-BUTTON IGNITION SWITCH POSITION INDICATOR DOES NOT ILLUMINATE

### Description

INFOID:000000003586748

- Before performing the diagnosis in the following table, check “Work Flow”. Refer to [PCS-36, "Work Flow"](#).
- Check that vehicle is under the condition shown in “Conditions of vehicle” before starting diagnosis, and check each symptom.

### Conditions of Vehicle (Operating Conditions)

- “ENGINE START BY I-KEY” in “WORK SUPPORT” is ON when setting on CONSULT-III.
- One or more of Intelligent Keys with registered Intelligent Key ID is in the vehicle.

### Diagnosis Procedure

INFOID:000000003586749

#### 1. CHECK PUSH-BUTTON IGNITION SWITCH INDICATOR

Check push-button ignition switch indicator.

Refer to [PCS-67, "Component Function Check"](#).

Is the inspection result normal?

YES >> GO TO 2.

NO >> Repair or replace the malfunctioning parts.

#### 2. CONFIRM THE OPERATION

Confirm the operation again.

Is the result normal?

YES >> Check intermittent incident. Refer to [GI-38, "Intermittent Incident"](#).

NO >> GO TO 1.

A  
B  
C  
D  
E  
F  
G  
H  
I  
J  
K  
L

PCS

N  
O  
P

# BCM (BODY CONTROL MODULE)

< ON-VEHICLE REPAIR >

[POWER DISTRIBUTION SYSTEM]

## ON-VEHICLE REPAIR

### BCM (BODY CONTROL MODULE)

Exploded View

INFOID:000000003728705

#### CAUTION:

Before replacing BCM, perform "READ CONFIGURATION" to save or print current vehicle specification. Refer to [BCS-3, "ADDITIONAL SERVICE WHEN REPLACING CONTROL UNIT \(BCM\) : Description"](#).

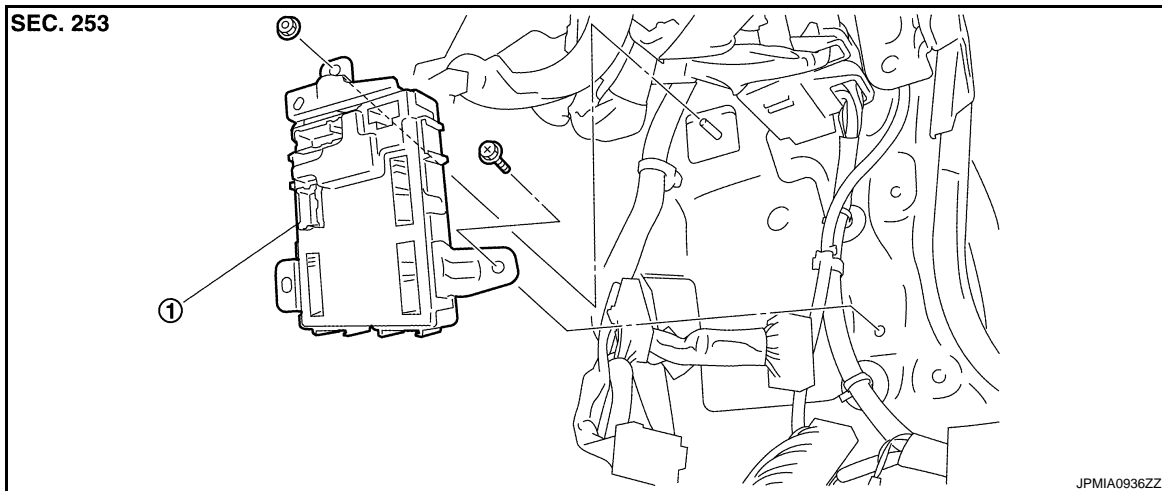

1. BCM

### Removal and Installation

INFOID:000000003728706

#### CAUTION:

Before replacing BCM, perform "READ CONFIGURATION" to save or print current vehicle specification. Refer to [BCS-3, "ADDITIONAL SERVICE WHEN REPLACING CONTROL UNIT \(BCM\) : Description"](#).

#### REMOVAL

1. Remove dash side finisher (passenger side). Refer to [IP-11, "Exploded View"](#).
2. Remove bolt and nut.
3. Remove BCM and disconnect the connector.

#### INSTALLATION

Install in the reverse order of removal.

#### CAUTION:

- Be sure to perform "WRITE CONFIGURATION" when replacing BCM.
- Be sure to perform the system initialization (NATS) when replacing BCM. Refer to [BCS-3, "ADDITIONAL SERVICE WHEN REPLACING CONTROL UNIT \(BCM\) : Special Repair Requirement"](#).

# PUSH BUTTON IGNITION SWITCH

< ON-VEHICLE REPAIR >

[POWER DISTRIBUTION SYSTEM]

## PUSH BUTTON IGNITION SWITCH

### Removal and Installation

INFOID:000000003132080

#### REMOVAL

Remove the push-button ignition switch fixing pawl using a remover tool (A), and then remove push-button ignition switch (1).

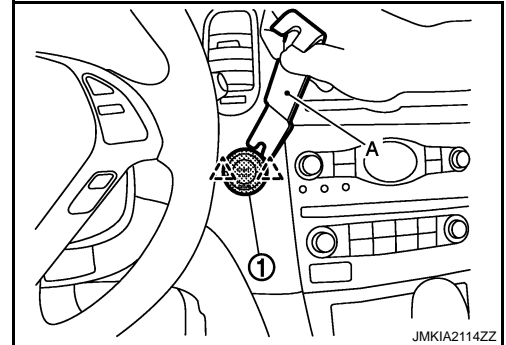

#### INSTALLATION

Install in the reverse order of removal.

A  
B  
C  
D  
E  
F  
G  
H  
I  
J  
K  
L  
N  
O  
P

PCS