

A
B
C

EXL

SECTION EXL

EXTERIOR LIGHTING SYSTEM

D
E

CONTENTS

XENON TYPE			
BASIC INSPECTION	7	Component Parts Location	15
DIAGNOSIS AND REPAIR WORKFLOW	7	Component Description	16
Work Flow	7	DAYTIME RUNNING LIGHT SYSTEM	17
INSPECTION AND ADJUSTMENT	9	System Diagram	17
ADDITIONAL SERVICE WHEN REPLACING CONTROL UNIT (AFS CONTROL UNIT)	9	System Description	17
ADDITIONAL SERVICE WHEN REPLACING CONTROL UNIT (AFS CONTROL UNIT) : Description	9	Component Parts Location	18
ADDITIONAL SERVICE WHEN REPLACING CONTROL UNIT (AFS CONTROL UNIT) : Special Repair Requirement	9	Component Description	18
ADDITIONAL SERVICE WHEN REPLACING CONTROL UNIT (HEIGHT SENSOR)	9	ACTIVE ADAPTIVE FRONT-LIGHTING SYSTEM	20
ADDITIONAL SERVICE WHEN REPLACING CONTROL UNIT (HEIGHT SENSOR) : Description	9	System Diagram	20
ADDITIONAL SERVICE WHEN REPLACING CONTROL UNIT (HEIGHT SENSOR) : Special Repair Requirement	9	System Description	20
LEVELIZER ADJUSTMENT	9	Component Parts Location	22
LEVELIZER ADJUSTMENT : Description	9	Component Description	22
LEVELIZER ADJUSTMENT : Special Repair Requirement	9	FRONT FOG LAMP SYSTEM	24
FUNCTION DIAGNOSIS	11	System Diagram	24
HEADLAMP SYSTEM	11	System Description	24
System Diagram	11	Component Parts Location	25
System Description	11	Component Description	25
Component Parts Location	12	TURN SIGNAL AND HAZARD WARNING LAMP SYSTEM	26
Component Description	13	System Diagram	26
AUTO LIGHT SYSTEM	14	System Description	26
System Diagram	14	Component Parts Location	27
System Description	14	Component Description	27
		PARKING, LICENSE PLATE AND TAIL LAMPS SYSTEM	28
		System Diagram	28
		System Description	28
		Component Parts Location	29
		Component Description	29
		EXTERIOR LAMP BATTERY SAVER SYSTEM	30
		System Diagram	30
		System Description	30
		Component Parts Location	31
		Component Description	31

EXL

DIAGNOSIS SYSTEM (BCM)	32	Description	60
COMMON ITEM	32	DTC Logic	60
COMMON ITEM : CONSULT-III Function (BCM - COMMON ITEM)	32	Diagnosis Procedure	60
HEADLAMP	33	U1000 CAN COMM CIRCUIT	61
HEADLAMP : CONSULT-III Function (BCM - HEAD LAMP)	33	Description	61
FLASHER	35	DTC Logic	61
FLASHER : CONSULT-III Function (BCM - FLASHER)	35	Diagnosis Procedure	61
DIAGNOSIS SYSTEM (IPDM E/R)	37	U1010 CONTROL UNIT (CAN)	62
Diagnosis Description	37	DTC Logic	62
CONSULT-III Function (IPDM E/R)	39	Diagnosis Procedure	62
DIAGNOSIS SYSTEM (AFS)	42	POWER SUPPLY AND GROUND CIRCUIT	63
CONSULT-III Function (ADAPTIVE LIGHT)	42	BCM (BODY CONTROL MODULE)	63
COMPONENT DIAGNOSIS	44	BCM (BODY CONTROL MODULE) : Diagnosis Procedure	63
B2503, B2504 SWIVEL ACTUATOR	44	IPDM E/R (INTELLIGENT POWER DISTRIBUTION MODULE ENGINE ROOM)	63
Description	44	IPDM E/R (INTELLIGENT POWER DISTRIBUTION MODULE ENGINE ROOM) : Diagnosis Pro- cedure	63
DTC Logic	44	AFS CONTROL UNIT	64
Diagnosis Procedure	45	AFS CONTROL UNIT : Diagnosis Procedure	64
Component Inspection	48	EXTERIOR LAMP FUSE	66
B2514 HEIGHT SENSOR UNUSUAL [RR]	50	Description	66
Description	50	Diagnosis Procedure	66
DTC Logic	50	HEADLAMP (HI) CIRCUIT	67
Diagnosis Procedure	50	Component Function Check	67
Component Inspection	52	Diagnosis Procedure	67
B2516 SHIFT SIGNAL [P, R]	53	HEADLAMP (LO) CIRCUIT	69
Description	53	Description	69
DTC Logic	53	Component Function Check	69
Diagnosis Procedure	53	Diagnosis Procedure	69
B2517 VEHICLE SPEED SIGNAL	54	XENON HEADLAMP	71
Description	54	Description	71
DTC Logic	54	Diagnosis Procedure	71
Diagnosis Procedure	54	HEADLAMP LEVELIZER CIRCUIT	73
B2519 LEVELIZER CALIBRATION	55	Description	73
Description	55	Component Function Check	73
DTC Logic	55	Diagnosis Procedure	73
Diagnosis Procedure	55	FRONT FOG LAMP CIRCUIT	75
B2521 ECU CIRCUIT	56	Component Function Check	75
Description	56	Diagnosis Procedure	75
DTC Logic	56	PARKING LAMP CIRCUIT	77
Diagnosis Procedure	56	Component Function Check	77
C0126 STEERING ANGLE SENSOR SIGNAL ..	59	Diagnosis Procedure	77
Description	59	TURN SIGNAL LAMP CIRCUIT	79
DTC Logic	59	Description	79
Diagnosis Procedure	59	Component Function Check	79
C0428 STEERING ANGLE SENSOR CALI- BRATION	60	Diagnosis Procedure	79

OPTICAL SENSOR	81	AFS CONTROL UNIT	168	
Description	81	Reference Value	168	A
Component Function Check	81	Wiring Diagram - ACTIVE AFS -	171	
Diagnosis Procedure	81	Fail-Safe	177	B
HAZARD SWITCH	84	DTC Inspection Priority Chart	177	
Description	84	DTC Index	178	
Component Function Check	84	SYMPTOM DIAGNOSIS	179	C
Diagnosis Procedure	84	EXTERIOR LIGHTING SYSTEM SYMPTOMS.	179	
TAIL LAMP CIRCUIT	86	Symptom Table	179	
Component Function Check	86	NORMAL OPERATING CONDITION	181	D
Diagnosis Procedure	86	Description	181	
LICENSE PLATE LAMP CIRCUIT	88	BOTH SIDE HEADLAMPS (HI) ARE NOT	TURNED ON	182
Component Function Check	88	Description	182	E
Diagnosis Procedure	88	Diagnosis Procedure	182	
HEADLAMP SYSTEM	89	BOTH SIDE HEADLAMPS (LO) ARE NOT	TURNED ON	183
Wiring Diagram - HEADLAMP -	89	Description	183	F
AUTO LIGHT SYSTEM	93	Diagnosis Procedure	183	
Wiring Diagram - AUTO LIGHT SYSTEM -	93	PARKING, LICENSE PLATE AND TAIL	LAMPS ARE NOT TURNED ON	184
DAYTIME RUNNING LIGHT SYSTEM	97	Description	184	
Wiring Diagram - DAYTIME LIGHT SYSTEM -	97	Diagnosis Procedure	184	
FRONT FOG LAMP SYSTEM	101	BOTH SIDE FRONT FOG LAMPS ARE NOT	TURNED ON	185
Wiring Diagram - FRONT FOG LAMP -	101	Description	185	J
TURN SIGNAL AND HAZARD WARNING		Diagnosis Procedure	185	
LAMP SYSTEM	104	PRECAUTION	186	K
Wiring Diagram - TURN AND HAZARD WARN-		PRECAUTIONS	186	
ING LAMPS -	104	Precaution for Supplemental Restraint System	(SRS) "AIR BAG" and "SEAT BELT PRE-TEN-	
PARKING, LICENSE PLATE AND TAIL		SIONER"	186	EXL
LAMPS SYSTEM	108	Precautions For Xenon Headlamp Service	186	
Wiring Diagram - PARKING, LICENSE PLATE		ON-VEHICLE MAINTENANCE	187	M
AND TAIL LAMPS -	108	HEADLAMP AIMING ADJUSTMENT	187	
STOP LAMP	113	Description	187	N
Wiring Diagram - STOP LAMP -	113	Aiming Adjustment Procedure	188	
BACK-UP LAMP	116	FRONT FOG LAMP AIMING ADJUSTMENT .	190	O
Wiring Diagram - BACK-UP LAMP -	116	Description	190	
ECU DIAGNOSIS	119	Aiming Adjustment Procedure	190	
BCM (BODY CONTROL MODULE)	119	ON-VEHICLE REPAIR	192	P
Reference Value	119	FRONT COMBINATION LAMP	192	
Wiring Diagram - BCM -	143	Exploded View	192	
Fail-safe	149	Removal and Installation	193	
DTC Inspection Priority Chart	151	Replacement	193	
DTC Index	153	Disassembly and Assembly	194	
IPDM E/R (INTELLIGENT POWER DISTRI-		FRONT FOG LAMP	195	
BUTION MODULE ENGINE ROOM)	155			
Reference Value	155			
Wiring Diagram - IPDM E/R -	162			
Fail-safe	165			
DTC Index	167			

Exploded View	195	DIAGNOSIS AND REPAIR WORKFLOW	210
Removal and Installation	195	Work Flow	210
Replacement	195	FUNCTION DIAGNOSIS	212
OPTICAL SENSOR	197	HEADLAMP SYSTEM	212
Exploded View	197	System Diagram	212
Removal and Installation	197	System Description	212
LIGHTING AND TURN SIGNAL SWITCH	198	Component Parts Location	213
Exploded View	198	Component Description	214
HAZARD SWITCH	199	AUTO LIGHT SYSTEM	215
Exploded View	199	System Diagram	215
AFS CONTROL UNIT	200	System Description	215
Exploded View	200	Component Parts Location	216
Removal and Installation	200	Component Description	217
STEERING ANGLE SENSOR	201	DAYTIME RUNNING LIGHT SYSTEM	218
Removal and Installation	201	System Diagram	218
AFS OFF SWITCH	202	System Description	218
Exploded View	202	Component Parts Location	219
Removal and Installation	202	Component Description	219
HEIGHT SENSOR	203	FRONT FOG LAMP SYSTEM	221
Exploded View	203	System Diagram	221
Removal and Installation	203	System Description	221
REAR COMBINATION LAMP	204	Component Parts Location	222
Exploded View	204	Component Description	222
Removal and Installation	204	TURN SIGNAL AND HAZARD WARNING	
REAR TURN SIGNAL LAMP	205	LAMP SYSTEM	223
Exploded View	205	System Diagram	223
Removal and Installation	205	System Description	223
Replacement	205	Component Parts Location	224
HIGH-MOUNTED STOP LAMP	206	Component Description	224
Exploded View	206	PARKING, LICENSE PLATE AND TAIL	
Removal and Installation	206	LAMPS SYSTEM	225
BACK-UP LAMP	207	System Diagram	225
Exploded View	207	System Description	225
Removal and Installation	207	Component Parts Location	226
Replacement	207	Component Description	226
LICENSE PLATE LAMP	208	EXTERIOR LAMP BATTERY SAVER SYS-	
Exploded View	208	TEM	227
Removal and Installation	208	System Diagram	227
Replacement	208	System Description	227
SERVICE DATA AND SPECIFICATIONS		Component Parts Location	228
(SDS)	209	Component Description	228
SERVICE DATA AND SPECIFICATIONS		DIAGNOSIS SYSTEM (BCM)	229
(SDS)	209	COMMON ITEM	229
Bulb Specifications	209	COMMON ITEM : CONSULT-III Function (BCM -	
HALOGEN TYPE		COMMON ITEM)	229
BASIC INSPECTION	210	HEADLAMP	230
		HEADLAMP : CONSULT-III Function (BCM -	
		HEAD LAMP)	230
		FLASHER	232

FLASHER : CONSULT-III Function (BCM - FLASHER)	232	HEADLAMP SYSTEM	260	A
		Wiring Diagram - HEADLAMP -	260	
DIAGNOSIS SYSTEM (IPDM E/R)	234	AUTO LIGHT SYSTEM	264	B
Diagnosis Description	234	Wiring Diagram - AUTO LIGHT SYSTEM -	264	
CONSULT-III Function (IPDM E/R)	236	DAYTIME RUNNING LIGHT SYSTEM	268	C
COMPONENT DIAGNOSIS	239	Wiring Diagram - DAYTIME LIGHT SYSTEM -	268	
POWER SUPPLY AND GROUND CIRCUIT ...	239	FRONT FOG LAMP SYSTEM	272	D
BCM (BODY CONTROL MODULE)	239	Wiring Diagram - FRONT FOG LAMP -	272	
BCM (BODY CONTROL MODULE) : Diagnosis Procedure	239	TURN SIGNAL AND HAZARD WARNING LAMP SYSTEM	275	E
IPDM E/R (INTELLIGENT POWER DISTRIBUTION MODULE ENGINE ROOM)	239	Wiring Diagram - TURN AND HAZARD WARN- ING LAMPS -	275	
IPDM E/R (INTELLIGENT POWER DISTRIBUTION MODULE ENGINE ROOM) : Diagnosis Pro- cedure	239	PARKING, LICENSE PLATE AND TAIL LAMPS SYSTEM	279	F
EXTERIOR LAMP FUSE	241	Wiring Diagram - PARKING, LICENSE PLATE AND TAIL LAMPS -	279	
Description	241	STOP LAMP	284	G
Diagnosis Procedure	241	Wiring Diagram - STOP LAMP -	284	
HEADLAMP (HI) CIRCUIT	242	BACK-UP LAMP	287	H
Component Function Check	242	Wiring Diagram - BACK-UP LAMP -	287	
Diagnosis Procedure	242	ECU DIAGNOSIS	290	I
HEADLAMP (LO) CIRCUIT	244	BCM (BODY CONTROL MODULE)	290	J
Component Function Check	244	Reference Value	290	
Diagnosis Procedure	244	Wiring Diagram - BCM -	314	
FRONT FOG LAMP CIRCUIT	246	Fail-safe	320	
Component Function Check	246	DTC Inspection Priority Chart	322	
Diagnosis Procedure	246	DTC Index	324	K
PARKING LAMP CIRCUIT	248	IPDM E/R (INTELLIGENT POWER DISTRI- BUTION MODULE ENGINE ROOM)	326	EXL
Component Function Check	248	Reference Value	326	
Diagnosis Procedure	248	Wiring Diagram - IPDM E/R -	333	
TURN SIGNAL LAMP CIRCUIT	250	Fail-safe	336	
Description	250	DTC Index	338	M
Component Function Check	250	SYMPTOM DIAGNOSIS	339	
Diagnosis Procedure	250	EXTERIOR LIGHTING SYSTEM SYMPTOMS.	339	N
OPTICAL SENSOR	252	Symptom Table	339	
Description	252	Symptom Table	340	
Component Function Check	252	NORMAL OPERATING CONDITION	341	O
Diagnosis Procedure	252	Description	341	
HAZARD SWITCH	255	BOTH SIDE HEADLAMPS (HI) ARE NOT TURNED ON	342	P
Description	255	Description	342	
Component Function Check	255	Diagnosis Procedure	342	
Diagnosis Procedure	255	BOTH SIDE HEADLAMPS (LO) ARE NOT TURNED ON	343	
TAIL LAMP CIRCUIT	257	Description	343	
Component Function Check	257	Diagnosis Procedure	343	
Diagnosis Procedure	257			
LICENSE PLATE LAMP CIRCUIT	259			
Component Function Check	259			
Diagnosis Procedure	259			

PARKING, LICENSE PLATE AND TAIL LAMPS ARE NOT TURNED ON	344	OPTICAL SENSOR	357
Description	344	Exploded View	357
Diagnosis Procedure	344	Removal and Installation	357
BOTH SIDE FRONT FOG LAMPS ARE NOT TURNED ON	345	LIGHTING AND TURN SIGNAL SWITCH	358
Description	345	Exploded View	358
Diagnosis Procedure	345	HAZARD SWITCH	359
PRECAUTION	346	Exploded View	359
PRECAUTIONS	346	REAR COMBINATION LAMP	360
Precaution for Supplemental Restraint System (SRS) "AIR BAG" and "SEAT BELT PRE-TENSIONER"	346	Exploded View	360
ON-VEHICLE MAINTENANCE	347	Removal and Installation	360
HEADLAMP AIMING ADJUSTMENT	347	REAR TURN SIGNAL LAMP	361
Description	347	Exploded View	361
Aiming Adjustment Procedure	348	Removal and Installation	361
FRONT FOG LAMP AIMING ADJUSTMENT .	350	Replacement	361
Description	350	HIGH-MOUNTED STOP LAMP	362
Aiming Adjustment Procedure	350	Exploded View	362
ON-VEHICLE REPAIR	352	Removal and Installation	362
FRONT COMBINATION LAMP	352	BACK-UP LAMP	363
Exploded View	352	Exploded View	363
Removal and Installation	352	Removal and Installation	363
Replacement	353	Replacement	363
Disassembly and Assembly	354	LICENSE PLATE LAMP	364
FRONT FOG LAMP	355	Exploded View	364
Exploded View	355	Removal and Installation	364
Removal and Installation	355	Replacement	364
Replacement	355	SERVICE DATA AND SPECIFICATIONS (SDS)	365
		SERVICE DATA AND SPECIFICATIONS (SDS)	365
		Bulb Specifications	365

BASIC INSPECTION

DIAGNOSIS AND REPAIR WORKFLOW

Work Flow

INFOID:000000003135251

OVERALL SEQUENCE

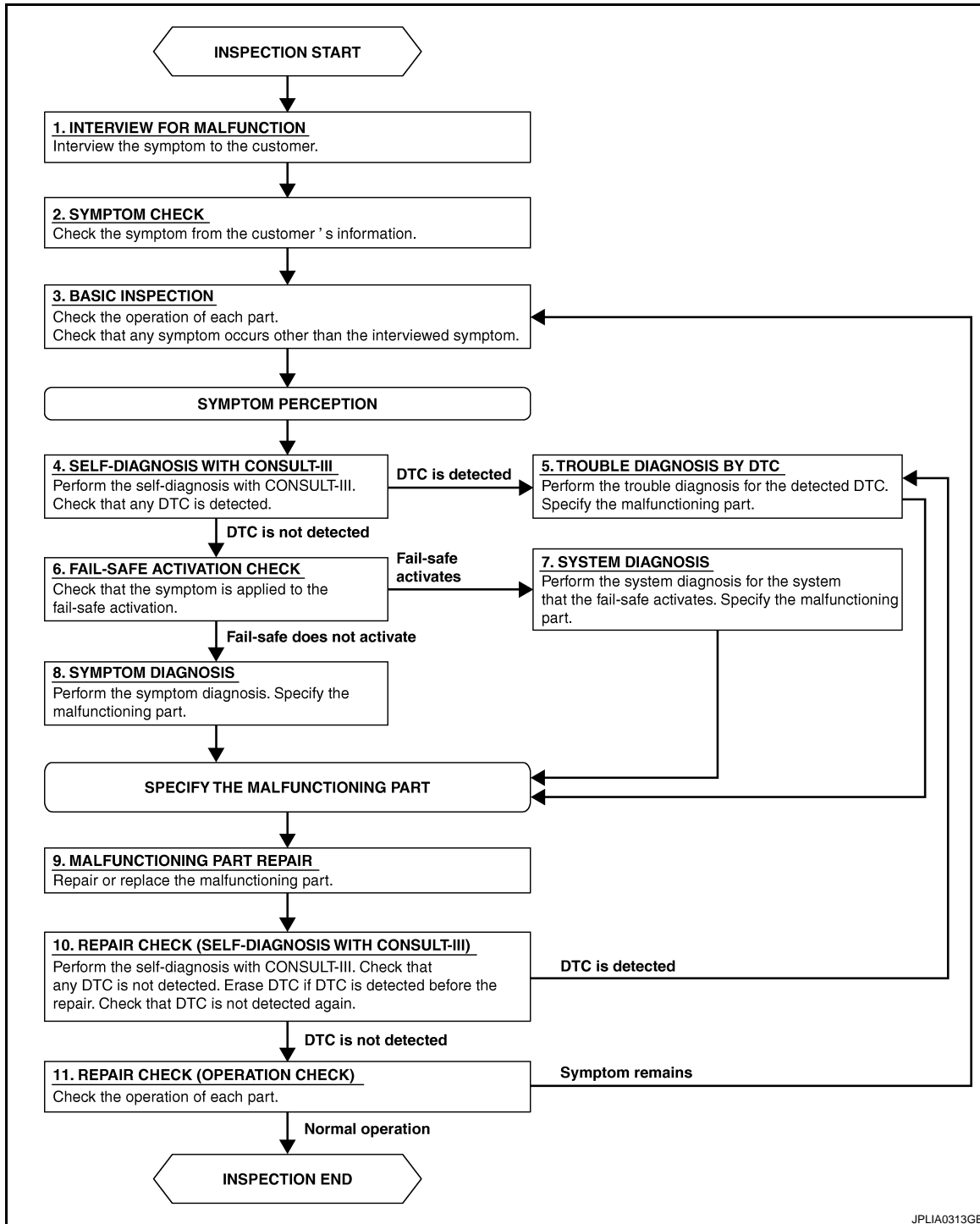

DETAILED FLOW

1. INTERVIEW FOR MALFUNCTION

Interview the symptom to the customer.

DIAGNOSIS AND REPAIR WORKFLOW

[XENON TYPE]

< BASIC INSPECTION >

>> GO TO 2.

2. SYMPTOM CHECK

Check the symptom from the customer's information.

>> GO TO 3.

3. BASIC INSPECTION

Check the operation of each part. Check that any symptom occurs other than the interviewed symptom.

>> GO TO 4.

4. SELF-DIAGNOSIS WITH CONSULT-III

Perform the self-diagnosis with CONSULT-III. Check that any DTC is detected.

Is any DTC detected?

YES >> GO TO 5.

NO >> GO TO 6.

5. TROUBLE DIAGNOSIS BY DTC

Perform the trouble diagnosis for the detected DTC. Specify the malfunctioning part.

>> GO TO 9.

6. FAIL-SAFE ACTIVATION CHECK

Check that the symptom is applied to the fail-safe activation.

Does the fail-safe activate?

YES >> GO TO 7.

NO >> GO TO 8.

7. SYSTEM DIAGNOSIS

Perform the system diagnosis for the system that the fail-safe activates. Specify the malfunctioning part.

>> GO TO 9.

8. SYMPTOM DIAGNOSIS

Perform the symptom diagnosis. Specify the malfunctioning part.

>> GO TO 9.

9. MALFUNCTION PART REPAIR

Repair or replace the malfunctioning part.

>> GO TO 10.

10. REPAIR CHECK (SELF-DIAGNOSIS WITH CONSULT-III)

Perform the self-diagnosis with CONSULT-III. Check that any DTC is not detected. Erase DTC if DTC is detected before the repair. Check that DTC is not detected again.

Is any DTC detected?

YES >> GO TO 5.

NO >> GO TO 11.

11. REPAIR CHECK (OPERATION CHECK)

Check the operation of each part.

Does it operate normally?

YES >> INSPECTION END

NO >> GO TO 3.

INSPECTION AND ADJUSTMENT

< BASIC INSPECTION >

[XENON TYPE]

INSPECTION AND ADJUSTMENT

ADDITIONAL SERVICE WHEN REPLACING CONTROL UNIT (AFS CONTROL UNIT)

ADDITIONAL SERVICE WHEN REPLACING CONTROL UNIT (AFS CONTROL UNIT) : Description

INFOID:000000003135252

Perform "LEVELIZER ADJUSTMENT" with CONSULT-III when replacing the AFS control unit.

ADDITIONAL SERVICE WHEN REPLACING CONTROL UNIT (AFS CONTROL UNIT) : Special Repair Requirement

INFOID:000000003135253

1.LEVELIZER ADJUSTMENT

Perform "LEVELIZER ADJUSTMENT".

>> Refer to [EXL-9, "LEVELIZER ADJUSTMENT : Special Repair Requirement"](#).

ADDITIONAL SERVICE WHEN REPLACING CONTROL UNIT (HEIGHT SENSOR)

ADDITIONAL SERVICE WHEN REPLACING CONTROL UNIT (HEIGHT SENSOR) : Description

INFOID:000000003596961

Perform "LEVELIZER ADJUSTMENT" with CONSULT-III when replacing the height sensor.

ADDITIONAL SERVICE WHEN REPLACING CONTROL UNIT (HEIGHT SENSOR) : Special Repair Requirement

INFOID:000000003596962

1.LEVELIZER ADJUSTMENT

Perform "LEVELIZER ADJUSTMENT".

>> Refer to [EXL-9, "LEVELIZER ADJUSTMENT : Special Repair Requirement"](#).

LEVELIZER ADJUSTMENT

LEVELIZER ADJUSTMENT : Description

INFOID:000000003135254

Perform "LEVELIZER ADJUSTMENT" when installing, removing, and replacing the height sensor and the suspension components.

LEVELIZER ADJUSTMENT : Special Repair Requirement

INFOID:000000003135255

1.CHECK VEHICLE CONDITION

1. Park the vehicle in the straight-forward position.
2. Unload the vehicle (no passenger aboard).

>> GO TO 2.

2.LEVELIZER ADJUSTMENT

CONSULT-III WORK SUPPORT

1. Select "LEVELIZER ADJUSTMENT" of ADAPTIVE LIGHT work support item.
2. Select "START".
3. When "ADJUSTMENT IS COMPLETED", select "END".

CAUTION:

If "CAN NOT BE TESTED" is indicated, AFS control unit detects that the height sensor signal changes. The levelizer adjustment is cancelled. In this case, turn the ignition switch OFF to prevent the vehicle from the height change. Perform the levelizer adjustment again.

INSPECTION AND ADJUSTMENT

[XENON TYPE]

< BASIC INSPECTION >

Is the levelizer adjustment completed?

YES >> GO TO 3.

NO >> Perform the levelizer adjustment again.

3.SELF-DIAGNOSIS RESULT CHECK

Perform self-diagnosis with CONSULT-III. Check that any DTC is not detected.

Is any DTC detected?

YES >> GO TO 2.

NO >> Levelizer adjustment completed

FUNCTION DIAGNOSIS

HEADLAMP SYSTEM

System Diagram

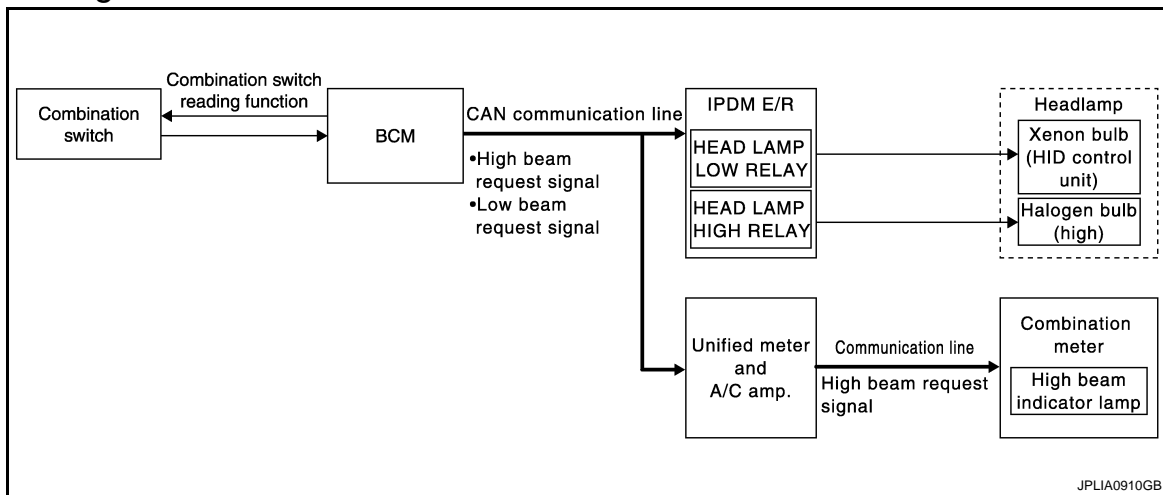

System Description

INFOID:000000003534166

OUTLINE

Headlamp is controlled by combination switch reading function and headlamp control function of BCM, and relay control function of IPDM E/R.

HEADLAMP (LO) OPERATION

- BCM detects the combination switch condition with the combination switch reading function.
- BCM transmits the low beam request signal to IPDM E/R with CAN communication according to the headlamp (LO) ON condition.

Headlamp (LO) ON condition

- Lighting switch 2ND

- IPDM E/R turns the integrated headlamp low relay ON, and turns the headlamp ON according to the low beam request signal.

HEADLAMP (HI) OPERATION

- BCM transmits the high beam request signal to IPDM E/R and the combination meter (through the unified meter and A/C amp.) with CAN communication according to the headlamp (HI) ON condition.

Headlamp (HI) ON condition

- Lighting switch HI with the lighting switch 2ND

- Lighting switch PASS

- Combination meter turns the high beam indicator lamp ON according to the high beam request signal.
- IPDM E/R turns the integrated headlamp high relay ON, and turns the headlamp ON according to the high beam request signal.

A
B
C
D
E
F
G
H
I
J
K
L
M
N
O
P

EXL

HEADLAMP SYSTEM

< FUNCTION DIAGNOSIS >

[XENON TYPE]

Component Parts Location

INFOID:000000003534167

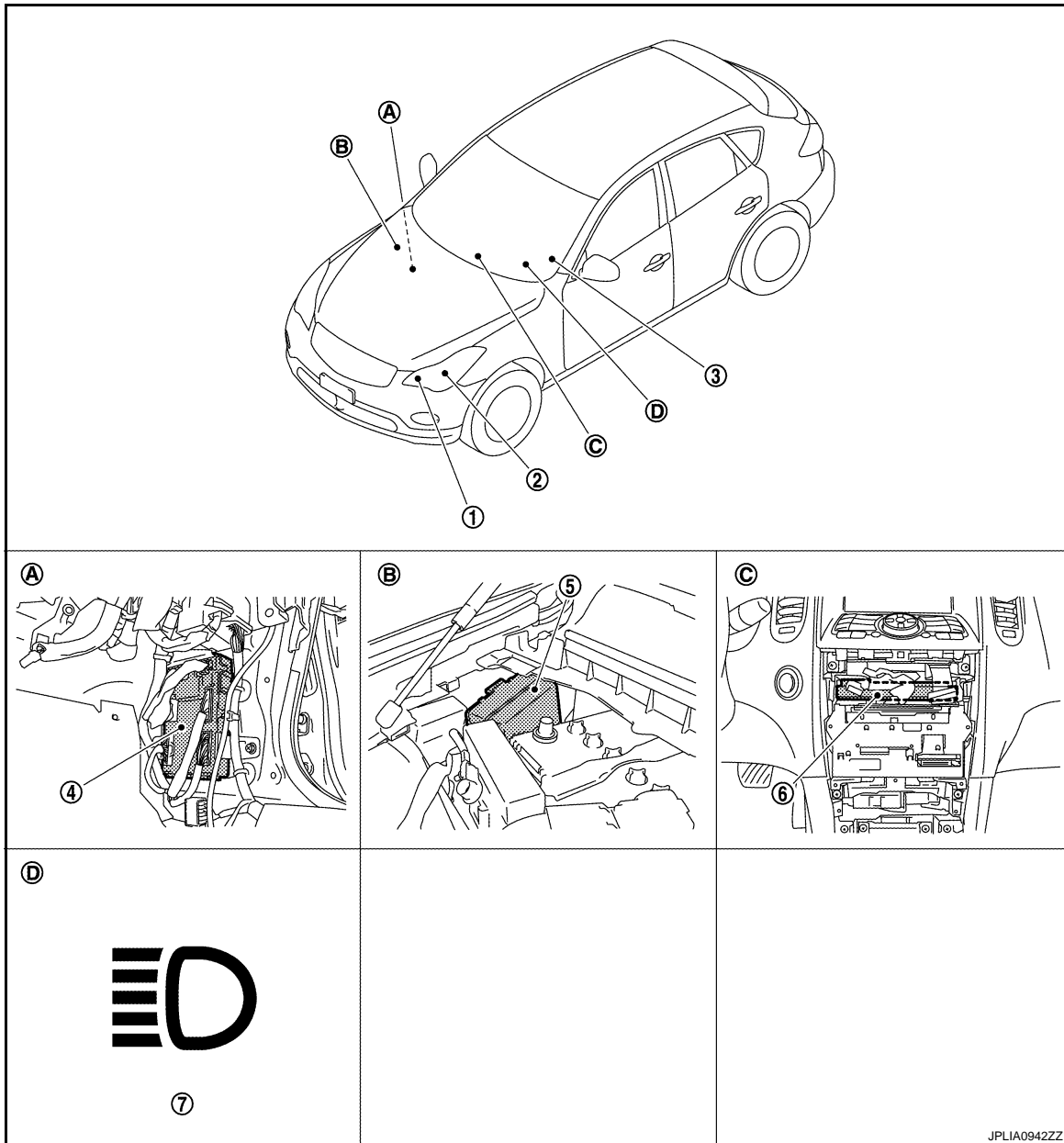

- | | | |
|-------------------------------------|--------------------------------|-------------------------------|
| 1. Headlamp (HI) | 2. Headlamp (LO) | 3. Combination switch |
| 4. BCM | 5. IPDM E/R | 6. Unified meter and A/C amp. |
| 7. High beam indicator lamp | | |
| A. Dash side lower (Passenger side) | B. Engine room dash panel (RH) | C. Behind the cluster lid C |
| D. On the combination meter | | |

JPLIA0942ZZ

HEADLAMP SYSTEM

< FUNCTION DIAGNOSIS >

[XENON TYPE]

Component Description

INFOID:000000003534168

Part	Description
BCM	<ul style="list-style-type: none"> • Detects each switch condition by the combination switch reading function. • Judges that the headlamp is turned ON according to the vehicle condition. - Requests the headlamp relay (HI/LO) ON to IPDM E/R (with CAN communication). - Requests the high beam indicator lamp ON to the combination meter [with CAN communication (through unified meter and A/C amp.)].
IPDM E/R	Controls the integrated relay, and supplies voltage to the load according to the request from BCM (with CAN communication).
Combination switch (Lighting & turn signal switch)	Refer to BCS-8, "System Diagram" .
Combination meter (High beam indicator lamp)	Turns the high beam indicator lamp ON according to the request from BCM [with CAN communication (through unified meter and A/C amp.)].
Front combination lamp assembly	<ul style="list-style-type: none"> • HID control unit • Xenon bulb Refer to EXL-71, "Description" .

A
B
C
D
E
F
G
H
I
J
K

EXL

M
N
O
P

AUTO LIGHT SYSTEM

System Diagram

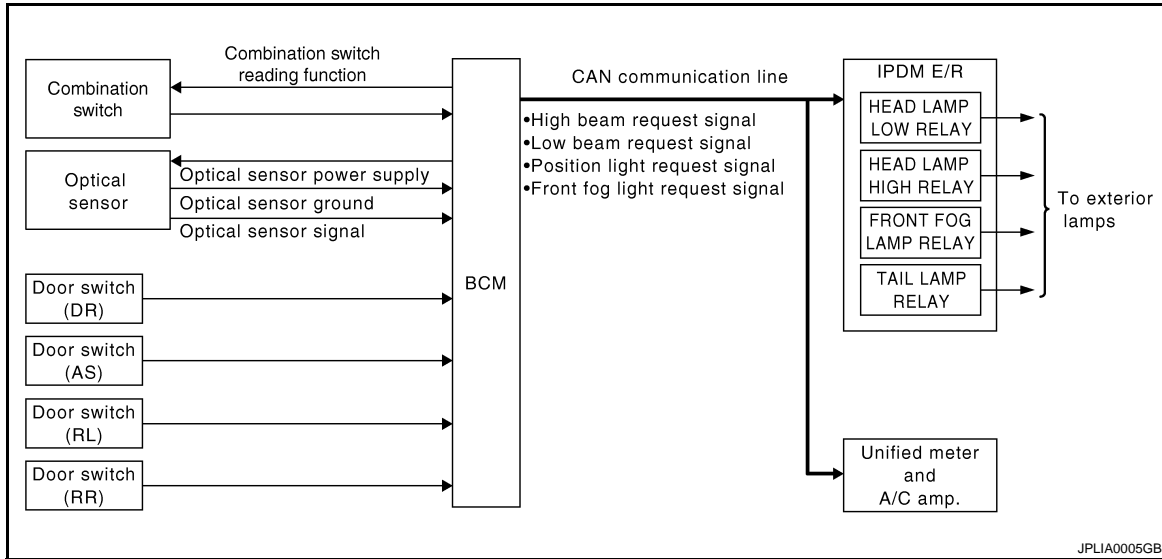

System Description

INFOID:000000003135261

OUTLINE

- Auto light system is controlled by each function of BCM and IPDM E/R.

Control by BCM

- Combination switch reading function
- Headlamp control function
- Auto light function
- Delay timer function

Control by IPDM E/R

- Relay control function
- Auto light system has the auto light function and the delay timer function.
- Auto light function turns the exterior lamps* and each illumination ON/OFF automatically according to the outside brightness.
- When auto light system turns the exterior lamps ON with the ignition switch OFF, delay timer function turns the exterior lamps OFF depending on the vehicle condition with the auto light function after a certain period of time.

*: Headlamp (LO/HI), parking lamp, tail lamp, and front fog lamp (Headlamp HI and front fog lamp depend on the combination switch condition.)

AUTO LIGHT FUNCTION

- BCM detects the combination switch condition with the combination switch reading function.
- BCM supplies voltage to optical sensor when the ignition switch is turned ON or ACC.
- Optical sensor converts outside brightness (lux) to voltage and transmits the optical sensor signal to BCM.
- BCM judges outside brightness from the optical sensor signal and judges ON/OFF condition of the exterior lamp and each illumination according to the outside brightness.
- BCM transmits each request signal to IPDM E/R with CAN communication according to ON/OFF condition by the auto light function.

NOTE:

ON/OFF timing differs based on the sensitivity from the setting. The setting can be set by CONSULT-III. Refer to [EXL-33, "HEADLAMP : CONSULT-III Function \(BCM - HEAD LAMP\)"](#).

DELAY TIMER FUNCTION

BCM turns the exterior lamp OFF depending on the vehicle condition with the auto light function when the ignition switch is turned OFF.

- Turns the exterior lamp OFF 5 minutes after detecting that any door opens (Door switch ON).
- Turns the exterior lamp OFF a certain period of time* after closing all doors (Door switch ON→OFF).

AUTO LIGHT SYSTEM

[XENON TYPE]

< FUNCTION DIAGNOSIS >

- Turns the exterior lamp OFF with the ignition switch ACC or the light switch OFF.
- *: The preset time is 45 seconds. The timer operating time can be set by CONSULT-III. Refer to [EXL-33](#), "[HEADLAMP : CONSULT-III Function \(BCM - HEAD LAMP\)](#)".

NOTE:

When any position other than the light switch AUTO is set, the auto light system function switches to the exterior lamp battery saver function.

Component Parts Location

INFOID:000000003135262

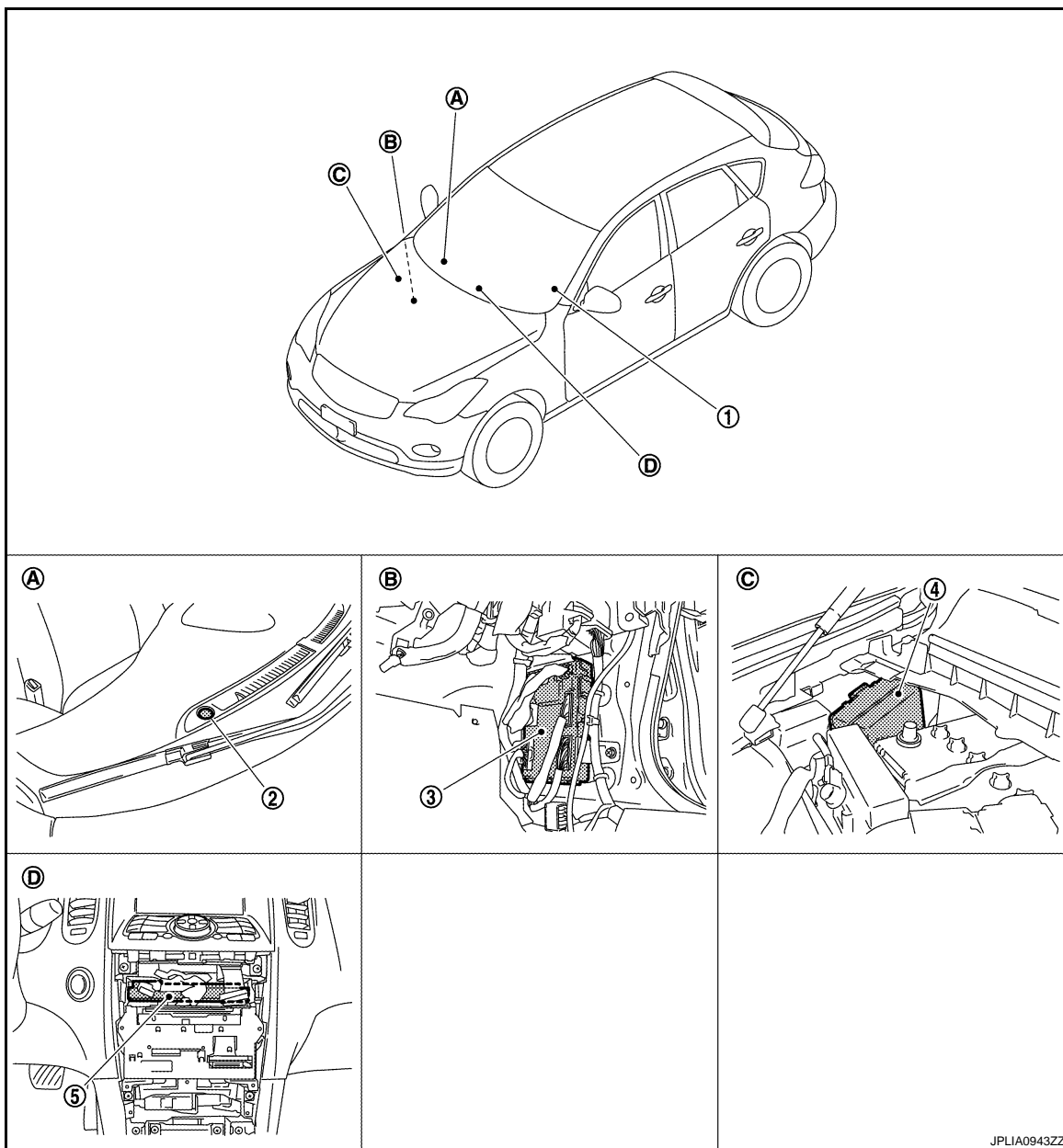

- | | | |
|--------------------------------|-------------------------------------|--------------------------------|
| 1. Combination switch | 2. Optical sensor | 3. BCM |
| 4. IPDM E/R | 5. Unified meter and A/C amp. | |
| A. Instrument upper panel (RH) | B. Dash side lower (Passenger side) | C. Engine room dash panel (RH) |
| D. Behind the cluster lid C | | |

AUTO LIGHT SYSTEM

< FUNCTION DIAGNOSIS >

[XENON TYPE]

Component Description

INFOID:000000003135263

Part	Description
BCM	<ul style="list-style-type: none">• Judges each switch condition by the combination switch reading function.• Judges the outside brightness from the optical sensor signal.• Judges the OFF timing according to the vehicle condition.• Judges the ON/OFF status of the exterior lamp and each illumination according to the outside brightness and the vehicle condition. Requests ON/OFF of each relay to IPDM E/R (with CAN communication).
IPDM E/R	Controls the integrated relay, and supplies voltage to the load according to the request from BCM (with CAN communication).
Combination switch (Lighting & turn signal switch)	Refer to BCS-8, "System Diagram" .
Optical sensor	Refer to EXL-81, "Description" .

DAYTIME RUNNING LIGHT SYSTEM

< FUNCTION DIAGNOSIS >

[XENON TYPE]

DAYTIME RUNNING LIGHT SYSTEM

System Diagram

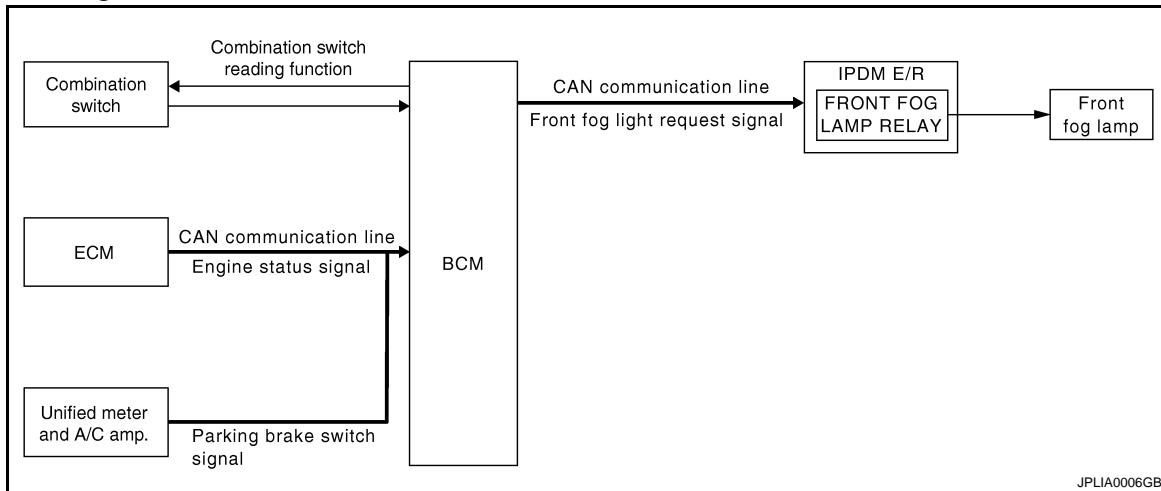

System Description

INFOID:000000003135265

OUTLINE

- Turns the front fog lamp ON as the daytime running light.
- Daytime running light is controlled by daytime running light control function and combination switch reading function of BCM, and relay control function of IPDM E/R.

DAYTIME RUNNING LIGHT OPERATION

- BCM detects the combination switch condition by the combination switch reading function.
- BCM detects the vehicle condition depending on the following signals.
 - Engine condition signal (received from ECM with CAN communication)
 - Parking brake switch signal (received from unified meter and A/C amp. with CAN communication)
- BCM transmits the front fog light request signal to IPDM E/R with CAN communication according to the daytime running light ON condition.

Daytime running light ON condition

- While the engine running with the parking brake released

Daytime running light OFF condition

- Engine stopped
- Headlamp ON (Passing included)
- IPDM E/R turns the integrated front fog lamp relay ON and turns the front fog lamp ON according to the front fog light request signal.

DAYTIME RUNNING LIGHT SYSTEM

< FUNCTION DIAGNOSIS >

[XENON TYPE]

Component Parts Location

INFOID:000000003135266

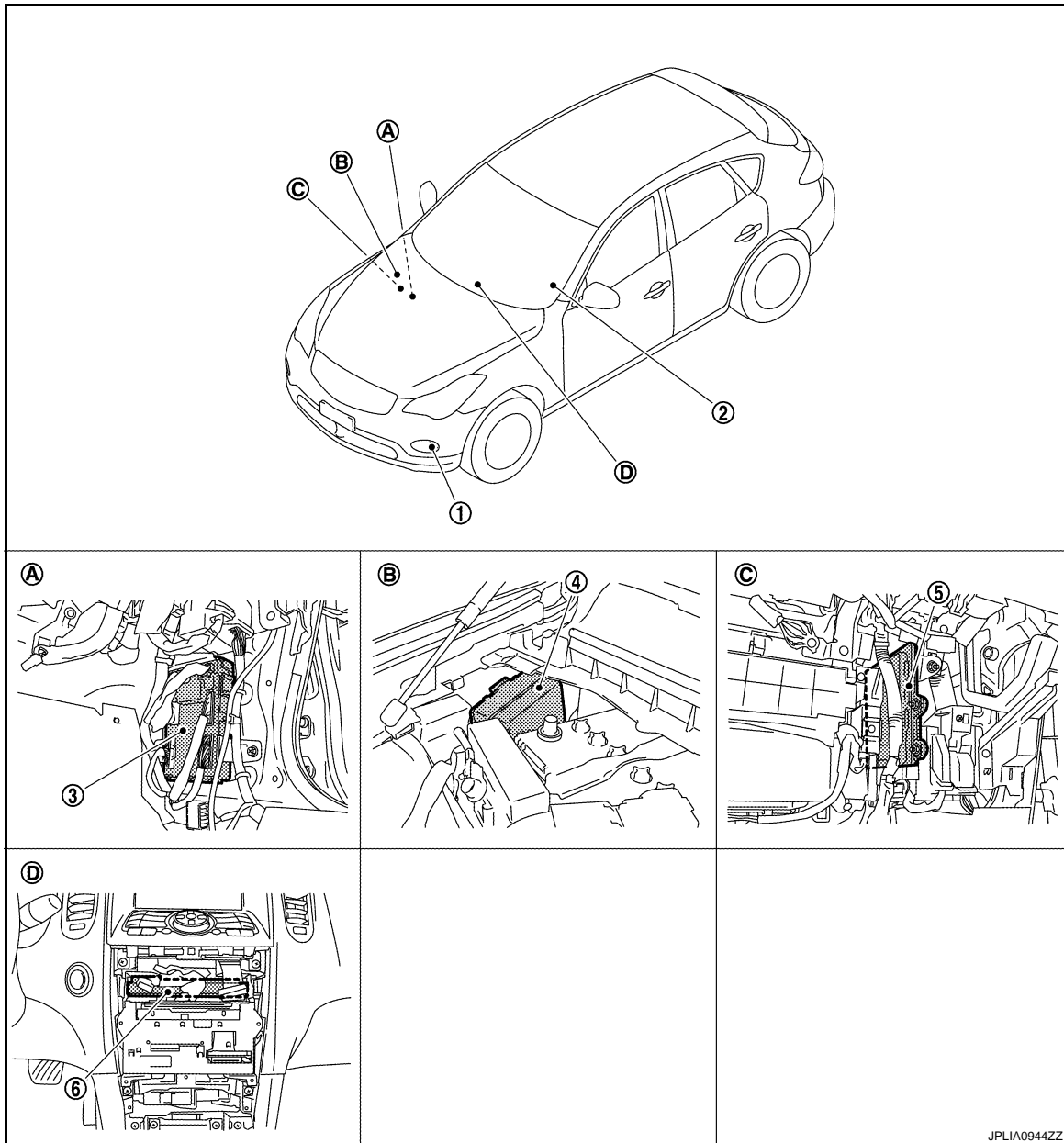

- | | | |
|--|--------------------------------|-------------------------------|
| 1. Daytime running light
(Front fog lamp) | 2. Combination switch | 3. BCM |
| 4. IPDM E/R | 5. ECM | 6. Unified meter and A/C amp. |
| A. Dash side lower (Passenger side) | B. Engine room dash panel (RH) | C. Behind the glove box |
| D. Behind the cluster lid C | | |

JPLIA0944ZZ

Component Description

INFOID:000000003135267

Part	Description
BCM	<ul style="list-style-type: none"> Judges each switch condition with the combination switch reading function. Judges the headlamp ON/OFF status according to the vehicle condition. Requests the front fog lamp relay ON to IPDM E/R (with CAN communication).
IPDM E/R	Controls the integrated relay and supplies voltage to the load according to the request from BCM (with CAN communication).

DAYTIME RUNNING LIGHT SYSTEM

< FUNCTION DIAGNOSIS >

[XENON TYPE]

Part	Description
Combination switch (Lighting & turn signal switch)	Refer to BCS-8, "System Diagram" .
ECM	Transmits the engine condition signal to BCM with CAN communication.
Unified meter and A/C amp.	Transmits the parking brake switch signal to BCM with CAN communication.

A

B

C

D

E

F

G

H

I

J

K

EXL

M

N

O

P

ACTIVE ADAPTIVE FRONT-LIGHTING SYSTEM

< FUNCTION DIAGNOSIS >

[XENON TYPE]

ACTIVE ADAPTIVE FRONT-LIGHTING SYSTEM

System Diagram

INFOID:000000003135268

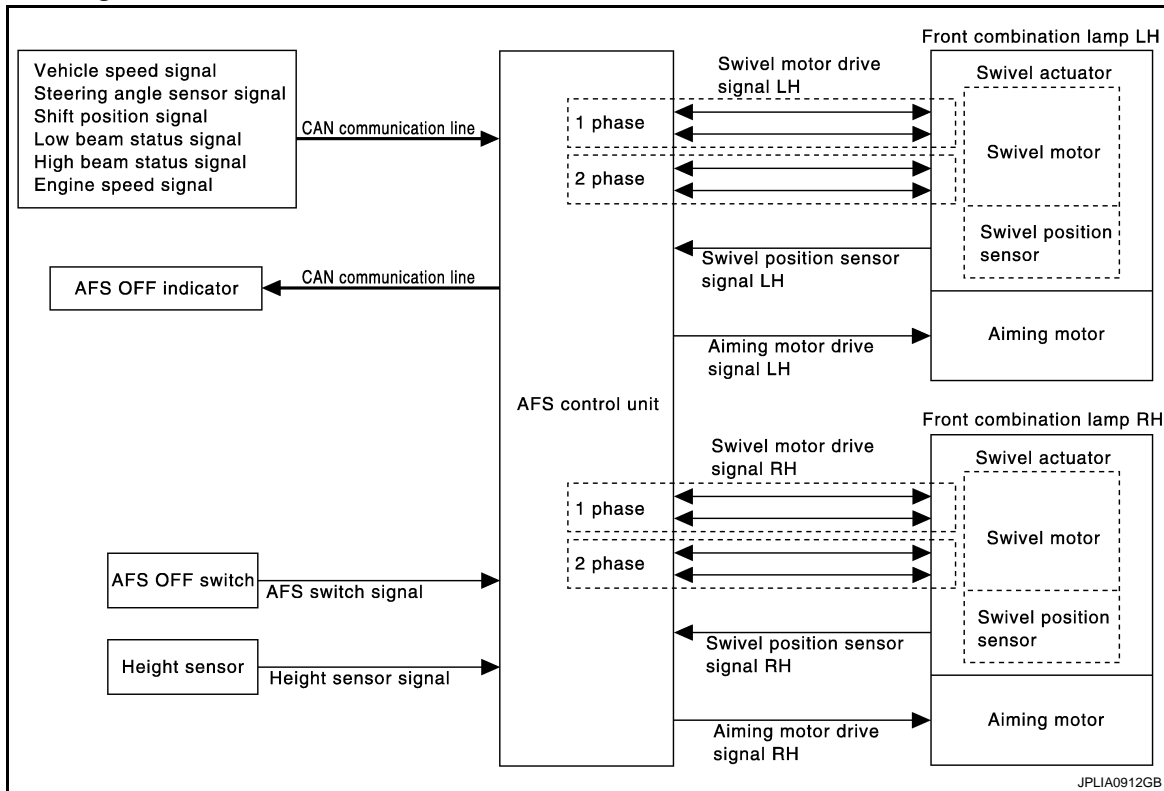

System Description

INFOID:000000003135269

OUTLINE

- AFS (ACTIVE ADAPTIVE FRONT-LIGHTING SYSTEM) is controlled by AFS control unit.
- AFS has AFS control (swivel control) and the headlamp auto aiming control.
 - AFS control swivels the headlamp to the steering direction.
 - Headlamp auto aiming control moves the headlamp light axis up/down according to the vehicle height.

AFS (ADAPTIVE FRONT-LIGHTING SYSTEM)

AFS Control Description

- AFS control controls the headlamp (right) only when the steering wheel is turned rightward, and the headlamp (left) only when the steering wheel is turned leftward.
- AFS control unit detects the vehicle condition necessary for AFS control with the following signals.
 - AFS switch signal
 - Steering angle sensor signal (received from steering angle sensor with CAN communication)
 - Engine speed signal (received from ECM with CAN communication)
 - Shift position signal (received from TCM with CAN communication)
 - Low beam status and high beam status (received from IPDM E/R with CAN communication)
 - Vehicle speed signal (received from unified meter and A/C amp. with CAN communication)
- When the operation conditions are satisfied, AFS control unit controls the swivel angle depending on the steering angle and the vehicle speed.

AFS operation condition

- Swivel actuator initialization completed
- AFS OFF switch OFF
- Headlamp ON
- While the engine running
- Selector lever position other than "P" or "R"
- Vehicle speed approximately 25 km/h (15.5 MPH) or more (left swivel only; Right swivel activates regardless of the vehicle speed.)

ACTIVE ADAPTIVE FRONT-LIGHTING SYSTEM

[XENON TYPE]

< FUNCTION DIAGNOSIS >

Swivel Actuator Initialization

- AFS control unit performs the swivel actuator initialization when detecting that the engine starts. A
- Swivels the headlamp to the vehicle-center side until it hits the stopper.
- Returns the swivel angle from the stopper. Completes the initialization with regarding the returned position as the swivel angle 0° (straight-forward position). B

Swivel Operation

- AFS control unit transmits the drive signal to the swivel actuator when activation conditions are satisfied. And swivels the headlamp. C
- The swivel starts after steering approximately 20° or more from straight-forward position.

NOTE:

- The steering angle differs between right turn and left turn.
- The swivel angle becomes the maximum angle toward the driving direction if the steering angle is approximately 90° or more depending on the vehicle speed. The swivel angle is maintained by shutting off the drive signal. D
- The swivel starts, and returns to the swivel angle 0° (straight-forward position) when the steering is returned to the straight-forward position. E
- AFS control unit returns the swivel angle to the straight-forward position, and stops the swivel regardless of the steering angle if the operation condition is not satisfied while the swivel angle is 0°. F

AFS OFF Indicator Lamp

- AFS control unit transmits AFS OFF indicator lamp signal to the combination meter (through the unified meter and A/C amp.) with CAN communication. G
- Combination meter turns AFS OFF indicator lamp ON/OFF/blinking according to AFS OFF indicator lamp signal.
- AFS OFF indicator lamp is turned ON for 1 second for the AFS OFF indicator lamp bulb check when the ignition switch is turned ON. AFS OFF indicator lamp is turned OFF within 1 second when the engine starts. H
- AFS OFF indicator lamp is turned OFF when AFS OFF switch is turned ON.
- AFS OFF indicator lamp blinks (1 second each) if AFS control unit detects a specific DTC.

NOTE:

Combination meter blinks AFS OFF indicator lamp (approximately 1 second each) if AFS OFF indicator lamp signal is not received from AFS control unit. I

HEADLAMP AUTO AIMING

Headlamp Auto Aiming Control Description

- Headlamp auto aiming control controls the headlamp light axis height appropriately according to the vehicle height. J
- AFS control unit detects the vehicle condition necessary for headlamp auto aiming control with the following signals. K
- Height sensor signal
- Engine speed signal (received from ECM with CAN communication)
- Low beam status signal and high beam status signal (received from IPDM E/R with CAN communication)
- Vehicle speed signal (received from unified meter and A/C amp. with CAN communication)
- When the operation conditions are satisfied, AFS control unit transmits the aiming motor drive signal for adjusting the headlamp axis height. M

Headlamp auto aiming operation condition

- Headlamp ON N
- While the engine running
- Vehicle speed (Control mode is switched according to the driving condition.)

Headlamp Auto Aiming Operation

- AFS control unit calculates the vehicle pitch angle from the height sensor signal. AFS control unit judges the angle for adjusting the axis gap from the preset position. O

CAUTION:

Adjusted axis position may differ from the preset position although the headlamp auto aiming activates properly if the suspension is replaced or worn. P

- AFS control unit controls the headlamp axis by changing the aiming motor drive signal output according to the vehicle-rearward height when detecting the following vehicle condition. Output is maintained if other condition than following is detected.
- Engine starts.
- Headlamp is turned ON.

EXL

ACTIVE ADAPTIVE FRONT-LIGHTING SYSTEM

[XENON TYPE]

< FUNCTION DIAGNOSIS >

- Vehicle posture becomes stable after changing the vehicle posture change is detected with the headlamp ON and the vehicle stopped.
- Vehicle speed is maintained with the headlamp ON and the vehicle driven.

Component Parts Location

INFOID:000000003135270

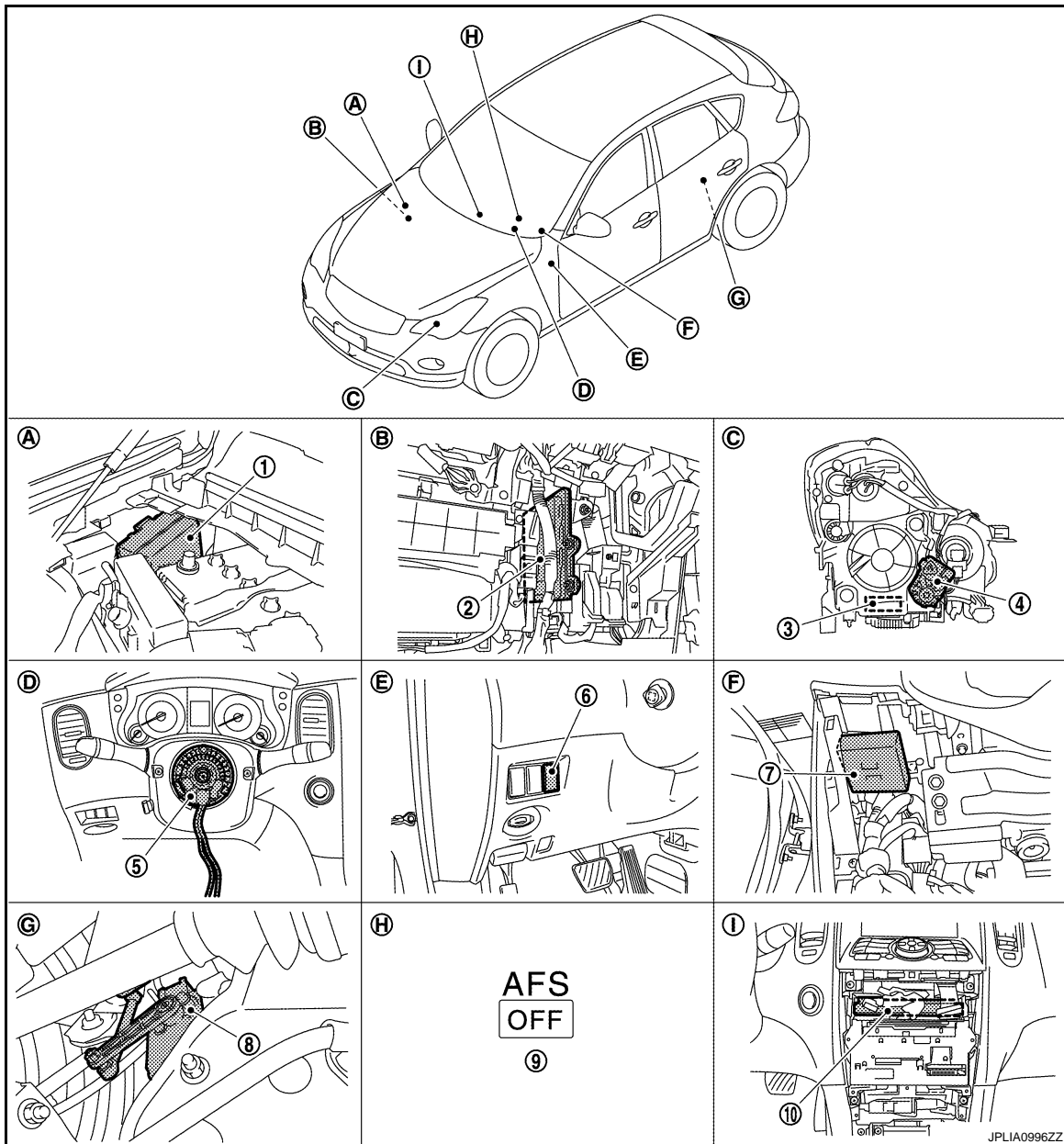

- | | | |
|-----------------------------------|----------------------------------|---|
| 1. IPDM E/R | 2. ECM | 3. Swivel actuator |
| 4. Aiming motor | 5. Steering angle sensor | 6. AFS OFF switch |
| 7. AFS control unit | 8. Height sensor | 9. AFS OFF indicator lamp |
| 10. Unified meter and A/C amp. | | |
| A. Engine room dash panel (RH) | B. Behind the glove box | C. Front combination lamp (back) |
| D. Steering column cover (inside) | E. Instrument driver lower panel | F. Behind the instrument driver lower panel |
| G. Rear suspension member (LH) | H. On the combination meter | I. Behind the cluster lid C |

Component Description

INFOID:000000003135271

ACTIVE ADAPTIVE FRONT-LIGHTING SYSTEM

< FUNCTION DIAGNOSIS >

[XENON TYPE]

Part	Description
AFS control unit	Refer to EXL-56, "Description" .
Swivel actuator	Refer to EXL-44, "Description" .
Aiming motor	Refer to EXL-73, "Description" .
AFS OFF switch	Inputs AFS OFF switch ON/OFF signal to AFS control unit.
Height sensor	Refer to EXL-50, "Description" .
Steering angle sensor	Refer to EXL-59, "Description" .
IPDM E/R	Transmits the headlamp (LO) ON signal and the headlamp (HI) ON signal to AFS control unit with CAN communication.
ECM	Transmits the engine speed signal to AFS control unit with CAN communication.
TCM	Refer to EXL-53, "Description" .
Unified meter and A/C amp.	Refer to EXL-54, "Description" .
Combination meter	Turns AFS OFF indicator lamp ON/OFF/blinking according to AFS control unit request [with CAN communication (through unified meter and A/C amp.)].

A
B
C
D
E
F
G
H
I
J
K
L
M
N
O
P

EXL

FRONT FOG LAMP SYSTEM

System Diagram

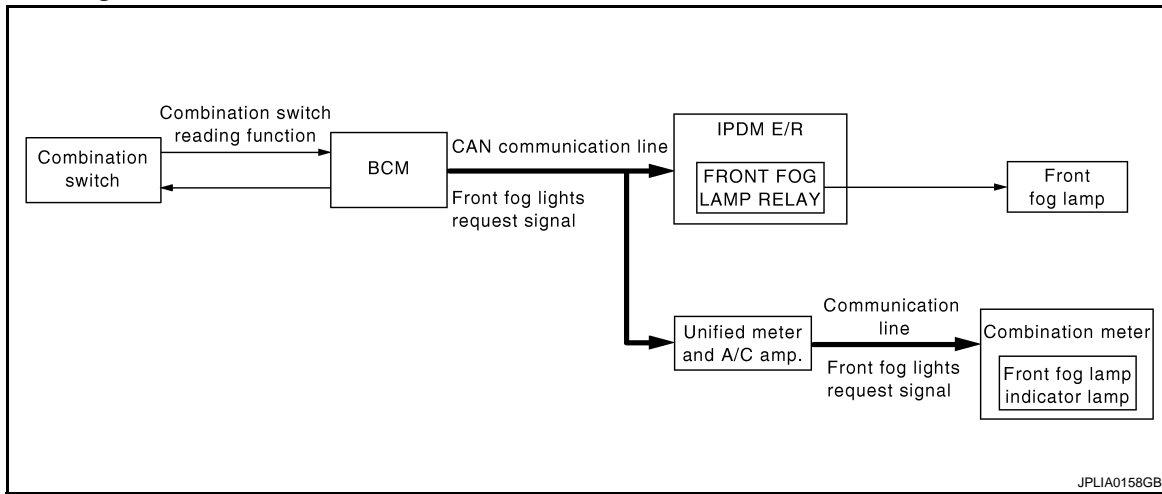

System Description

INFOID:000000003135273

OUTLINE

Front fog lamp is controlled by combination switch reading function and front fog lamp control function of BCM, and relay control function of IPDM E/R.

NOTE:

For Canada models, the front fog lamp is turned ON as the daytime running light. Refer to [EXL-30. "System Diagram"](#) for the detail.

FRONT FOG LAMP OPERATION

- BCM detects the combination switch condition by the combination switch reading function.
- BCM transmits the front fog light request signal to IPDM E/R and the combination meter (through the unified meter and A/C amp.) with CAN communication according to the front fog lamp ON condition.

Front fog lamp ON condition

- Front fog lamp switch ON with the headlamp ON (except for the high beam ON)
- IPDM E/R turns the integrated front fog lamp relay ON, and turns the front fog lamp ON according to the front fog light request signal.
- Combination meter turns the front fog lamp indicator lamp ON according to the front fog light request signal.

FRONT FOG LAMP SYSTEM

< FUNCTION DIAGNOSIS >

[XENON TYPE]

Component Parts Location

INFOID:000000003135274

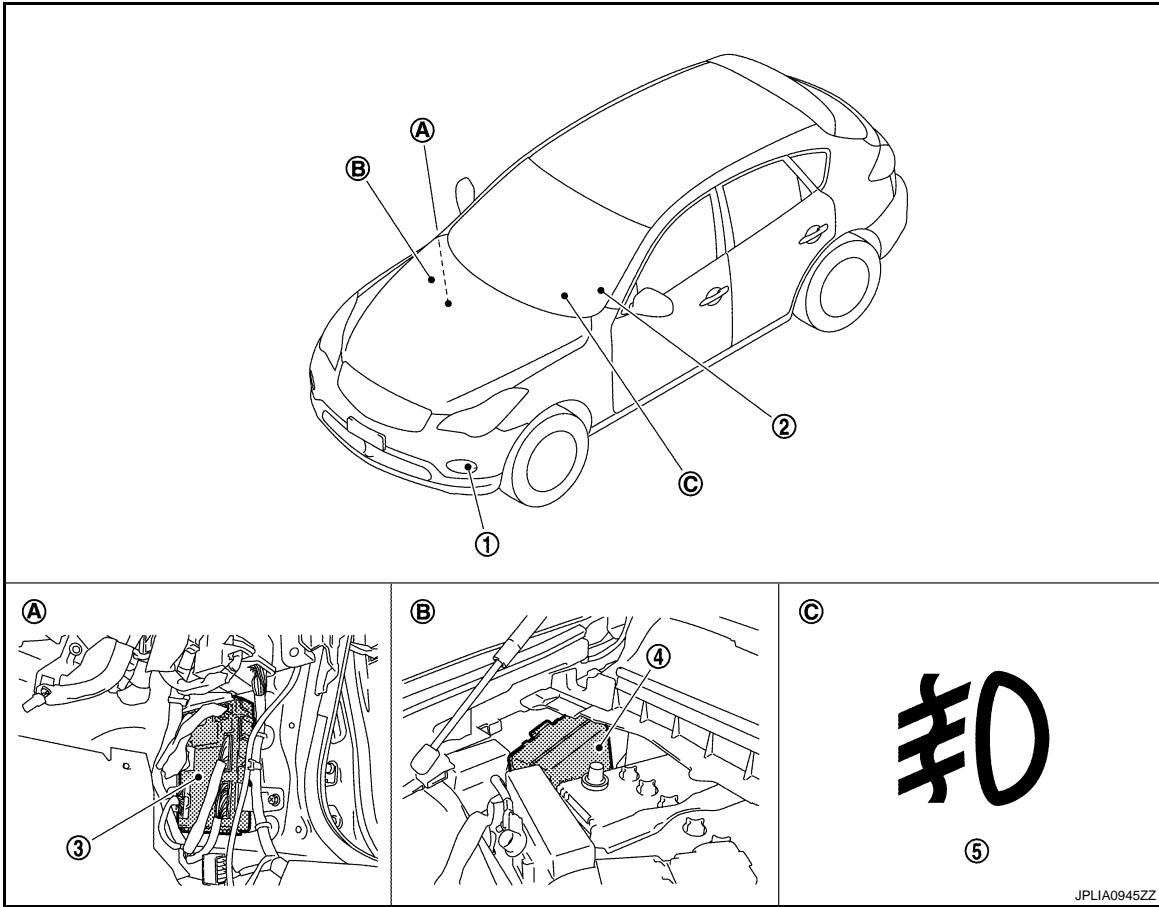

- | | | |
|-------------------------------------|----------------------------------|-----------------------------|
| 1. Front fog lamp | 2. Combination switch | 3. BCM |
| 4. IPDM E/R | 5. Front fog lamp indicator lamp | |
| A. Dash side lower (Passenger side) | B. Engine room dash panel (RH) | C. On the combination meter |

Component Description

INFOID:000000003135275

Part	Description
BCM	<ul style="list-style-type: none"> Judges each switch condition by the combination switch reading function. Judges the front fog lamp ON/OFF status according to the vehicle condition. Requests the front fog lamp relay ON to IPDM E/R (with CAN communication).
IPDM E/R	Controls the integrated relay and supplies voltage to the load according to the request from BCM (with CAN communication).
Combination switch (Lighting & turn signal switch)	Refer to BCS-8, "System Diagram" .
Combination meter (Front fog lamp indicator lamp)	Turns the front fog lamp indicator lamp ON according to the request from BCM [with CAN communication (through the unified meter and A/C amp.)].

TURN SIGNAL AND HAZARD WARNING LAMP SYSTEM

< FUNCTION DIAGNOSIS >

[XENON TYPE]

TURN SIGNAL AND HAZARD WARNING LAMP SYSTEM

System Diagram

INFOID:000000003135276

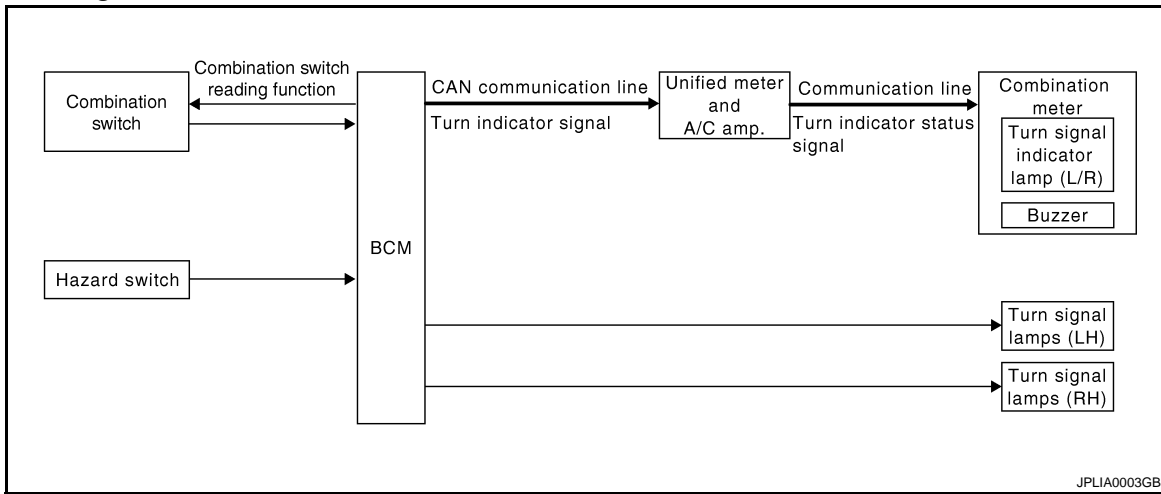

System Description

INFOID:000000003135277

OUTLINE

Turn signal and the hazard warning lamp is controlled by combination switch reading function and the flasher control function of BCM.

TURN SIGNAL LAMP OPERATION

- BCM detects the combination switch condition by the combination switch reading function.
- BCM supplies voltage to the right (left) turn signal lamp circuit when the ignition switch is turned ON and the turn signal switch is in the right (left) position. BCM blinks the turn signal lamp.

HAZARD WARNING LAMP OPERATION

BCM supplies voltage to both turn signal lamp circuit when the hazard switch is turned ON. BCM blinks the hazard warning lamp.

TURN SIGNAL INDICATOR LAMP AND TURN SIGNAL SOUND OPERATION

- BCM transmits the turn signal indicator lamp signal to the combination meter (through the unified meter and A/C amp.) with CAN communication while the turn signal lamp and the hazard warning lamp operating.
- Combination meter outputs the turn signal sound with the integrated buzzer while blinking the turn signal indicator lamp according to the turn signal indicator lamp signal.

HIGH FLASHER OPERATION (FAIL-SAFE)

- BCM detects the turn signal lamp circuit status from the current value.
- BCM increases the turn signal lamp blinking speed if the bulb or harness open is detected with the turn signal lamp operating.

NOTE:

The blinking speed is normal while operating the hazard warning lamp.

TURN SIGNAL AND HAZARD WARNING LAMP SYSTEM

< FUNCTION DIAGNOSIS >

[XENON TYPE]

Component Parts Location

INFOID:000000003135278

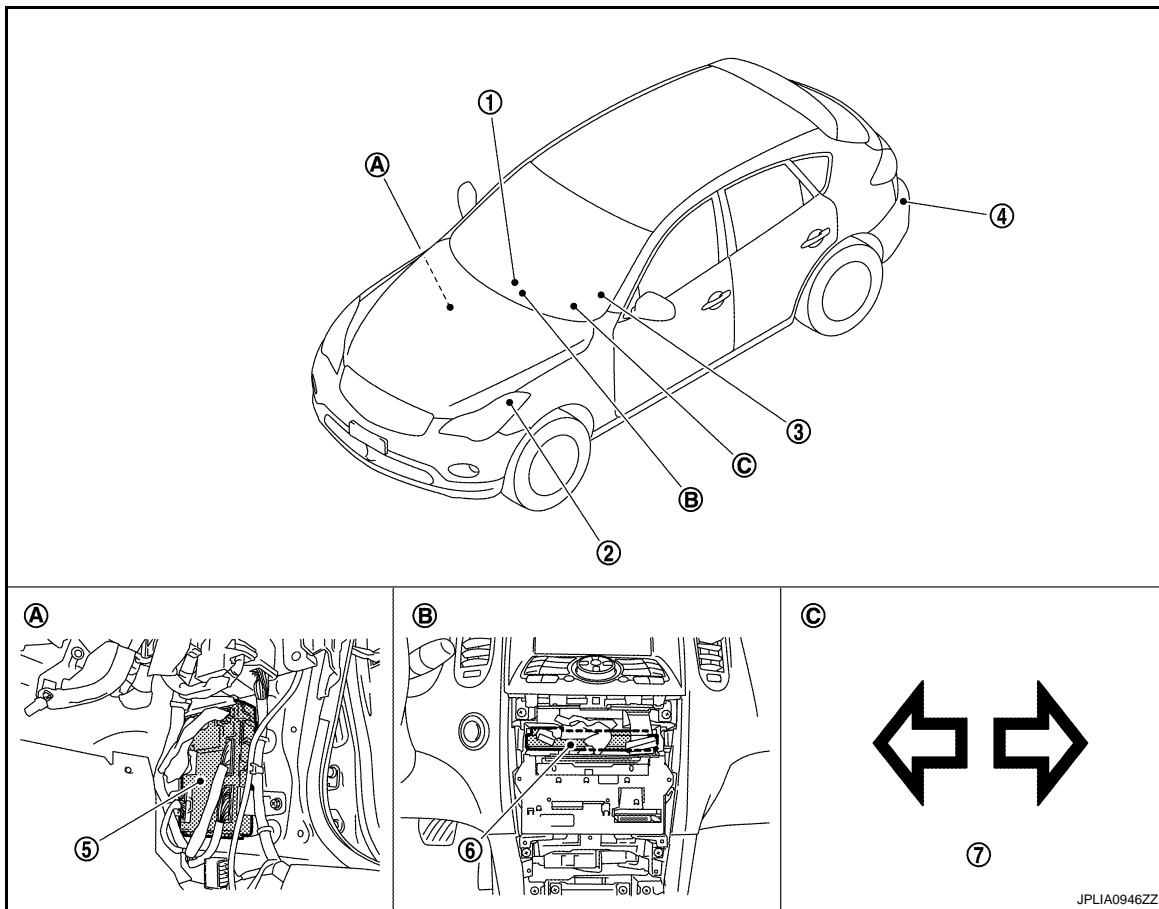

- | | | |
|-------------------------------------|-----------------------------|-------------------------------|
| 1. Hazard warning switch | 2. Front turn signal lamp | 3. Combination switch |
| 4. Rear turn signal lamp | 5. BCM | 6. Unified meter and A/C amp. |
| 7. Turn signal indicator lamp | | |
| A. Dash side lower (Passenger side) | B. Behind the cluster lid C | C. On the combination meter |

Component Description

INFOID:000000003135279

Part	Description
BCM	<ul style="list-style-type: none"> Judges each switch condition by the combination switch reading function. Judges the blinks of the turn signal lamp and the hazard warning lamp from each switch status. The applicable turn signal lamp blinks. Requests the turn signal indicator lamp blink to the combination meter (with CAN communication).
Combination switch (Lighting & turn signal switch)	Refer to BCS-8, "System Diagram" .
Hazard switch (Multifunction switch)	Refer to EXL-84, "Description" .
Combination meter (Turn signal indicator lamp & buzzer)	Blinks the turn signal indicator lamp and outputs the turn signal operating sound with integrated buzzer according to the request from BCM [with CAN communication (through unified meter and A/C amp.)].

PARKING, LICENSE PLATE AND TAIL LAMPS SYSTEM

< FUNCTION DIAGNOSIS >

[XENON TYPE]

PARKING, LICENSE PLATE AND TAIL LAMPS SYSTEM

System Diagram

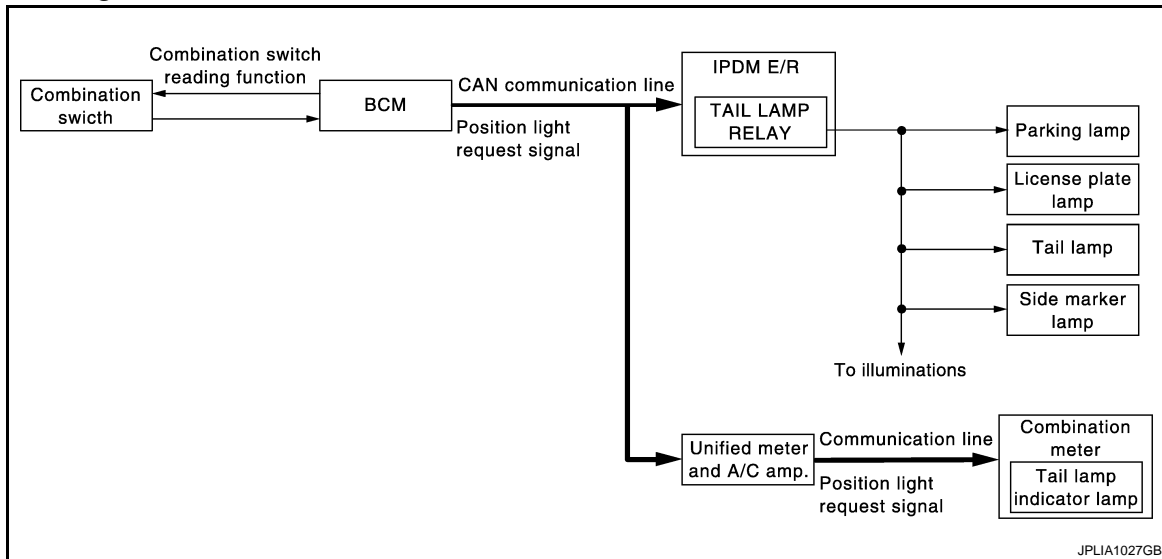

System Description

INFOID:000000003135281

OUTLINE

Parking, license plate, side marker and tail lamps are controlled by combination switch reading function and headlamp control function of BCM, and relay control function of IPDM E/R.

PARKING, LICENSE PLATE, SIDE MARKER AND TAIL LAMPS OPERATION

- BCM detects the combination switch condition by the combination switch reading function.
- BCM transmits the position light request signal to IPDM E/R with CAN communication according to the ON/OFF condition of the parking, license plate, side marker and tail lamps.

Parking, license plate, side marker and tail lamps ON condition

- Lighting switch 1ST
- Lighting switch 2ND
- Lighting switch AUTO, and the auto light function ON judgment (with auto light system)
- IPDM E/R turns the integrated tail lamp relay ON and turns the parking lamp, the license plate, side marker and tail lamps ON according to the position light request signal.
- Combination meter turns the tail lamp indicator lamp ON according to the position light request signal.

PARKING, LICENSE PLATE AND TAIL LAMPS SYSTEM

< FUNCTION DIAGNOSIS >

[XENON TYPE]

Component Parts Location

INFOID:000000003135282

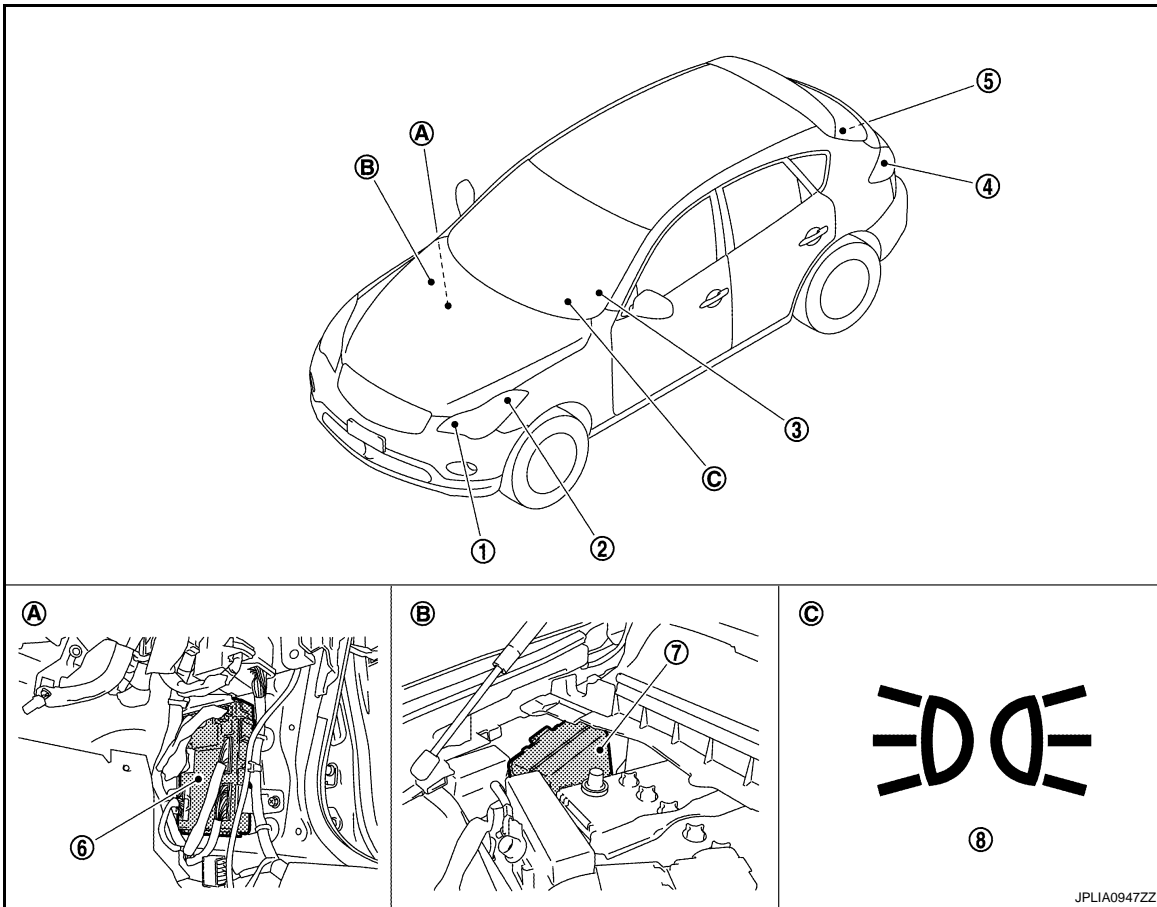

- | | | |
|-------------------------------------|--------------------------------|-----------------------------|
| 1. Parking lamp | 2. Side marker lamp | 3. Combination switch |
| 4. Tail lamp and side marker lamp | 5. License plate lamp | 6. BCM |
| 7. IPDM E/R | 8. Tail lamp indicator lamp | |
| A. Dash side lower (Passenger side) | B. Engine room dash panel (RH) | C. On the combination meter |

Component Description

INFOID:000000003135283

Part	Description
BCM	<ul style="list-style-type: none"> Judges each switch condition by the combination switch reading function. Judges the ON/OFF status of the clearance, license plate, side marker and tail lamps according to the vehicle condition. Requests the tail lamp relay ON to IPDM E/R (with CAN communication).
IPDM E/R	Controls the integrated relay and supplies voltage to the load according to the request from BCM (with CAN communication).
Combination switch (Lighting & turn signal switch)	Refer to BCS-8, "System Diagram" .
Combination meter (Tail lamp indicator lamp)	Turns the tail lamp indicator lamp ON according to the request from BCM [with CAN communication (through the unified meter and A/C amp.)].

EXTERIOR LAMP BATTERY SAVER SYSTEM

< FUNCTION DIAGNOSIS >

[XENON TYPE]

EXTERIOR LAMP BATTERY SAVER SYSTEM

System Diagram

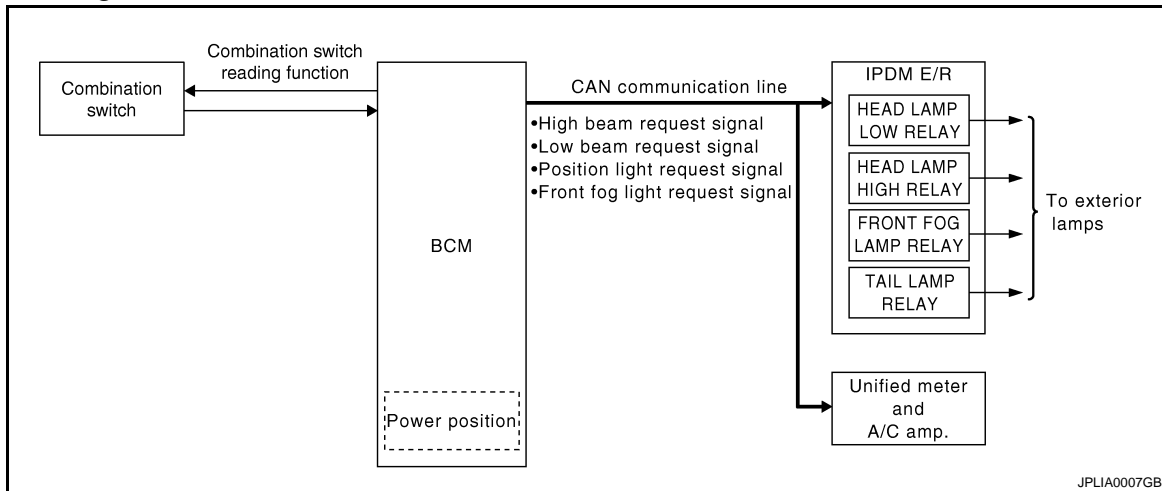

System Description

INFOID:000000003135285

OUTLINE

- Exterior lamp battery saver system is controlled by each function of BCM and IPDM E/R.

Control by BCM

- Combination switch reading function
- Headlamp control function
- Exterior lamp battery saver function

Control by IPDM E/R

- Relay control function
- BCM turns the exterior lamp* OFF after a period of time to prevent the battery from over-discharge when the ignition switch is turned OFF with the exterior lamp ON.

*: Headlamp (LO/HI), parking lamp, tail lamp, side marker lamp, license plate lamp and front fog lamp

NOTE:

When the lighting switch is turned AUTO, the exterior lamp battery saver switches to the auto light system. Refer to [EXL-14. "System Diagram"](#).

EXTERIOR LAMP BATTERY SAVER ACTIVATION

BCM activates the timer and turns the exterior lamp OFF 5 minutes after the ignition switch is turned from ON → OFF with the exterior lamps ON.

NOTE:

- Headlamp control function turns the exterior lamps ON normally when the ignition switch is turned ACC or the engine started (both before and after the exterior lamp battery saver is turned OFF).
- The timer starts at the time that the lighting switch is turned from OFF → 1ST or 2ND with the exterior lamp OFF.

EXTERIOR LAMP BATTERY SAVER SYSTEM

< FUNCTION DIAGNOSIS >

[XENON TYPE]

Component Parts Location

INFOID:000000003135286

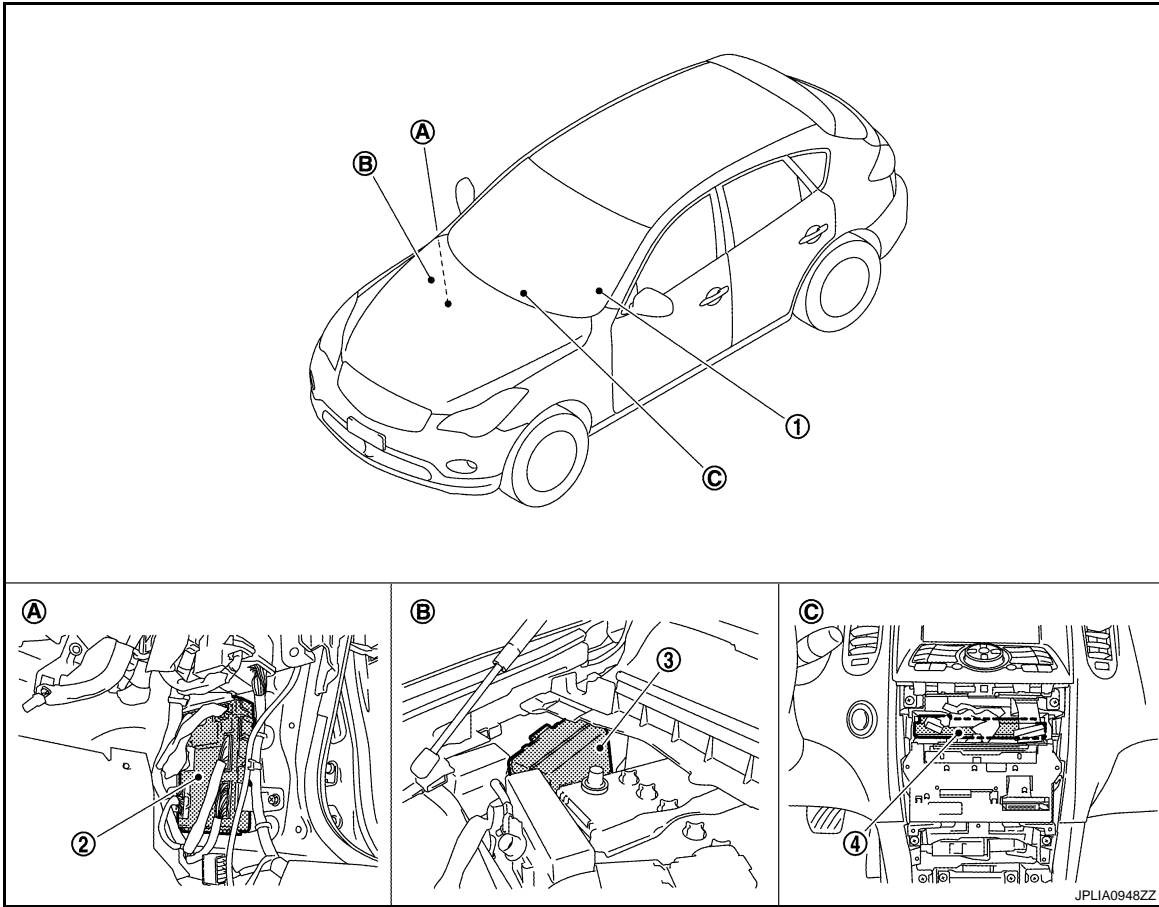

- | | | |
|-------------------------------------|--------------------------------|-----------------------------|
| 1. Combination switch | 2. BCM | 3. IPDM E/R |
| 4. Unified meter and A/C amp. | | |
| A. Dash side lower (Passenger side) | B. Engine room dash panel (RH) | C. Behind the cluster lid C |

Component Description

INFOID:000000003135287

Part	Description
BCM	<ul style="list-style-type: none"> Judges each switch condition by the combination switch reading function. Judges the exterior lamp OFF according to the vehicle condition. Requests each relay OFF to IPDM E/R (with CAN communication).
IPDM E/R	Controls the integrated relay according to the request from BCM (with CAN communication).
Combination switch (Lighting & turn signal switch)	Refer to BCS-8, "System Diagram" .

DIAGNOSIS SYSTEM (BCM)

< FUNCTION DIAGNOSIS >

[XENON TYPE]

DIAGNOSIS SYSTEM (BCM)

COMMON ITEM

COMMON ITEM : CONSULT-III Function (BCM - COMMON ITEM)

INFOID:000000003784722

APPLICATION ITEM

CONSULT-III performs the following functions via CAN communication with BCM.

Diagnosis mode	Function Description
Work Support	Changes the setting for each system function.
Self Diagnostic Result	Displays the diagnosis results judged by BCM.
CAN Diag Support Monitor	Monitors the reception status of CAN communication viewed from BCM. Refer to CONSULT-III operation manual.
Data Monitor	The BCM input/output signals are displayed.
Active Test	The signals used to activate each device are forcibly supplied from BCM.
Ecu Identification	The BCM part number is displayed.
Configuration	<ul style="list-style-type: none"> Read and save the vehicle specification. Write the vehicle specification when replacing BCM.

SYSTEM APPLICATION

BCM can perform the following functions for each system.

NOTE:

It can perform the diagnosis modes except the following for all sub system selection items.

×: Applicable item

System	Sub system selection item	Diagnosis mode		
		Work Support	Data Monitor	Active Test
Door lock	DOOR LOCK	×	×	×
Rear window defogger	REAR DEFOGGER		×	×
Warning chime	BUZZER		×	×
Interior room lamp timer	INT LAMP	×	×	×
Exterior lamp	HEAD LAMP	×	×	×
Wiper and washer	WIPER		×	×
Turn signal and hazard warning lamps	FLASHER	×	×	×
—	AIR CONDITONER*			
<ul style="list-style-type: none"> Intelligent Key system Engine start system 	INTELLIGENT KEY	×	×	×
Combination switch	COMB SW		×	
Body control system	BCM	×		
IVIS - NATS	IMMU		×	×
Interior room lamp battery saver	BATTERY SAVER	×	×	×
—	TRUNK*		×	×
Vehicle security system	THEFT ALM	×	×	×
RAP system	RETAINED PWR		×	
Signal buffer system	SIGNAL BUFFER		×	×
TPMS	TPMS (AIR PRESSURE MONITOR)	×	×	×

NOTE:

*: This item is displayed, but is not used.

FREEZE FRAME DATA (FFD) AND IGN COUNTER

Freeze Frame Data

DIAGNOSIS SYSTEM (BCM)

[XENON TYPE]

< FUNCTION DIAGNOSIS >

The BCM records the following condition at the moment a particular DTC is detected.

- Vehicle Speed
- Odd Trip Meter
- Vehicle Condition (BCM detected condition)

CONSULT screen terms	Description
SLEEP>LOCK	While turning BCM status from low power consumption mode to normal mode (Power supply position is "LOCK")
SLEEP>OFF	While turning BCM status from low power consumption mode to normal mode (Power supply position is "OFF".)
LOCK>ACC	While turning power supply position from "LOCK" to "ACC"
ACC>ON	While turning power supply position from "ACC" to "IGN"
RUN>ACC	While turning power supply position from "RUN" to "ACC" (Vehicle is stopping and selector lever is except P position.)
CRANK>RUN	While turning power supply position from "CRANKING" to "RUN" (From cranking up the engine to run it)
RUN>URGENT	While turning power supply position from "RUN" to "ACC" (Emergency stop operation)
ACC>OFF	While turning power supply position from "ACC" to "OFF"
OFF>LOCK	While turning power supply position from "OFF" to "LOCK"
OFF>ACC	While turning power supply position from "OFF" to "ACC"
ON>CRANK	While turning power supply position from "IGN" to "CRANKING"
OFF>SLEEP	While turning BCM status from normal mode (Power supply position is "OFF".) to low power consumption mode
LOCK>SLEEP	While turning BCM status from normal mode (Power supply position is "LOCK".) to low power consumption mode
LOCK	Power supply position is "LOCK" (Ignition switch OFF with steering is locked.)
OFF	Power supply position is "OFF" (Ignition switch OFF with steering is unlocked.)
ACC	Power supply position is "ACC" (Ignition switch ACC)
ON	Power supply position is "IGN" (Ignition switch ON with engine stopped)
ENGINE RUN	Power supply position is "RUN" (Ignition switch ON with engine running)
CRANKING	Power supply position is "CRANKING" (At engine cranking)

IGN Counter

IGN counter indicates the number of times that ignition switch is turned ON after DTC is detected.

- The number is 0 when a malfunction is detected now.
- The number increases like 1 → 2 → 3...38 → 39 after returning to the normal condition whenever ignition switch OFF → ON.
- The number is fixed to 39 until the self-diagnosis results are erased if it is over 39.

HEADLAMP

HEADLAMP : CONSULT-III Function (BCM - HEAD LAMP)

INFOID:000000003135289

WORK SUPPORT

Service item	Setting item	Setting
BATTERY SAVER SET	On*	With the exterior lamp battery saver function
	Off	Without the exterior lamp battery saver function

DIAGNOSIS SYSTEM (BCM)

< FUNCTION DIAGNOSIS >

[XENON TYPE]

Service item	Setting item	Setting
ILL DELAY SET	MODE 1*	45 sec.
	MODE 2	Without the function
	MODE 3	30 sec.
	MODE 4	60 sec.
	MODE 5	90 sec.
	MODE 6	120 sec.
	MODE 7	150 sec.
	MODE 8	180 sec.
Sets delay timer function timer operation time. (All doors closed)		
CUSTOM A/LIGHT SETTING	MODE 1*	Normal
	MODE 2	More sensitive setting than normal setting (Turns ON earlier than normal operation.)
	MODE 3	More sensitive setting than MODE 2 (Turns ON earlier than MODE 2.)
	MODE 4	Less sensitive setting than normal setting (Turns ON later than normal operation.)

*: Initial setting

DATA MONITOR

Monitor item [Unit]	Description	
PUSH SW [On/Off]	The switch status input from push-button ignition switch	
ENGINE STATE [Stop/Stall/Crank/Run]	The engine status received from ECM with CAN communication	
VEH SPEED 1 [km/h]	The value of the vehicle speed received from unified meter and A/C amp. with CAN communication	
KEY SW-SLOT [On/Off]	Key switch status input from key slot	
TURN SIGNAL R [On/Off]	Each switch status that BCM judges from the combination switch reading function	
TURN SIGNAL L [On/Off]		
TAIL LAMP SW [On/Off]		
HI BEAM SW [On/Off]		
HEAD LAMP SW1 [On/Off]		
HEAD LAMP SW2 [On/Off]		
PASSING SW [On/Off]		
AUTO LIGHT SW [On/Off]		
FR FOG SW [On/Off]		
RR FOG SW [On/Off]		NOTE: The item is indicated, but not monitored.
DOOR SW-DR [On/Off]		The switch status input from front door switch (driver side)
DOOR SW-AS [On/Off]		The switch status input from front door switch (passenger side)

DIAGNOSIS SYSTEM (BCM)

< FUNCTION DIAGNOSIS >

[XENON TYPE]

Monitor item [Unit]	Description
DOOR SW-RR [On/Off]	The switch status input from rear door switch RH
DOOR SW- RL [On/Off]	The switch status input from rear door switch LH
DOOR SW-BK [On/Off]	NOTE: The item is indicated, but not monitored.
OPTICAL SENSOR [V]	The value of exterior brightness voltage input from the optical sensor

ACTIVE TEST

Test item	Operation	Description
TAIL LAMP	On	Transmits the position light request signal to IPDM E/R with CAN communication to turn the tail lamp ON.
	Off	Stops the position light request signal transmission.
HEAD LAMP	Hi	Transmits the high beam request signal with CAN communication to turn the headlamp (HI).
	Low	Transmits the low beam request signal with CAN communication to turn the headlamp (LO).
	Off	Stops the high & low beam request signal transmission.
FR FOG LAMP	On	Transmits the front fog light request signal to IPDM E/R with CAN communication to turn the front fog lamp ON.
	Off	Stops the front fog light request signal transmission.
RR FOG LAMP	On	NOTE: The item is indicated, but cannot be tested.
	Off	
DAYTIME RUNNING LIGHT	On	NOTE: The item is indicated, but cannot be tested.
	Off	
CORNERING LAMP	RH	NOTE: The item is indicated, but cannot be tested.
	LH	
	Off	
ILL DIM SIGNAL	On	NOTE: The item is indicated, but cannot be tested.
	Off	

FLASHER

FLASHER : CONSULT-III Function (BCM - FLASHER)

INFOID:000000003135290

WORK SUPPORT

Service item	Setting item	Setting	
HAZARD ANSWER BACK	Lock Only*	With locking only	Sets the hazard warning lamp answer back function when the door is lock/unlock with the request switch or the key fob.
	Unlk Only	With unlocking only	
	Lock/Unlk	With locking/unlocking	
	Off	Without the function	

*: Initial setting

DATA MONITOR

DIAGNOSIS SYSTEM (BCM)

< FUNCTION DIAGNOSIS >

[XENON TYPE]

Monitor item [Unit]	Description
REQ SW-DR [On/Off]	The switch status input from the request switch (driver side)
REQ SW-AS [On/Off]	The switch status input from the request switch (passenger side)
PUSH SW [On/Off]	The switch status input from the push-button ignition switch
TURN SIGNAL R [On/Off]	Each switch condition that BCM judges from the combination switch reading function
TURN SIGNAL L [On/Off]	
HAZARD SW [On/Off]	The switch status input from the hazard switch
RKE-LOCK [On/Off]	Lock signal status received from the remote keyless entry receiver
RKE-UNLOCK [On/Off]	Unlock signal status received from the remote keyless entry receiver
RKE-PANIC [On/Off]	Panic alarm signal status received from the remote keyless entry receiver

ACTIVE TEST

Test item	Operation	Description
FLASHER	RH	Outputs the voltage to blink the right side turn signal lamps.
	LH	Outputs the voltage to blink the left side turn signal lamps.
	Off	Stops the voltage to turn the turn signal lamps OFF.

DIAGNOSIS SYSTEM (IPDM E/R)

Diagnosis Description

INFOID:000000003757032

AUTO ACTIVE TEST

Description

In auto active test mode, the IPDM E/R sends a drive signal to the following systems to check their operation.

- Oil pressure warning lamp
- Front wiper (LO, HI)
- Parking lamps
- License plate lamps
- Side maker lamps
- Tail lamps
- Front fog lamps
- Headlamps (LO, HI)
- A/C compressor (magnet clutch)
- Cooling fan (cooling fan control module)

Operation Procedure

1. Close the hood and lift the wiper arms from the windshield. (Prevent windshield damage due to wiper operation)
NOTE:
 When auto active test is performed with hood opened, sprinkle water on windshield beforehand.
2. Turn ignition switch OFF.
3. Turn the ignition switch ON, and within 20 seconds, press the driver door switch 10 times. Then turn the ignition switch OFF.
CAUTION:
Close passenger door.
4. Turn the ignition switch ON within 10 seconds. After that the horn sounds once and the auto active test starts.
5. The oil pressure warning lamp starts blinking when the auto active test starts.
6. After a series of the following operations is repeated 3 times, auto active test is completed.

NOTE:

When auto active test mode has to be cancelled halfway through test, turn ignition switch OFF.

CAUTION:

- If auto active test mode cannot be actuated, check door switch system. Refer to [DLK-63](#), "[Component Function Check](#)".
- Do not start the engine.

Inspection in Auto Active Test Mode

When auto active test mode is actuated, the following 5 steps are repeated 3 times.

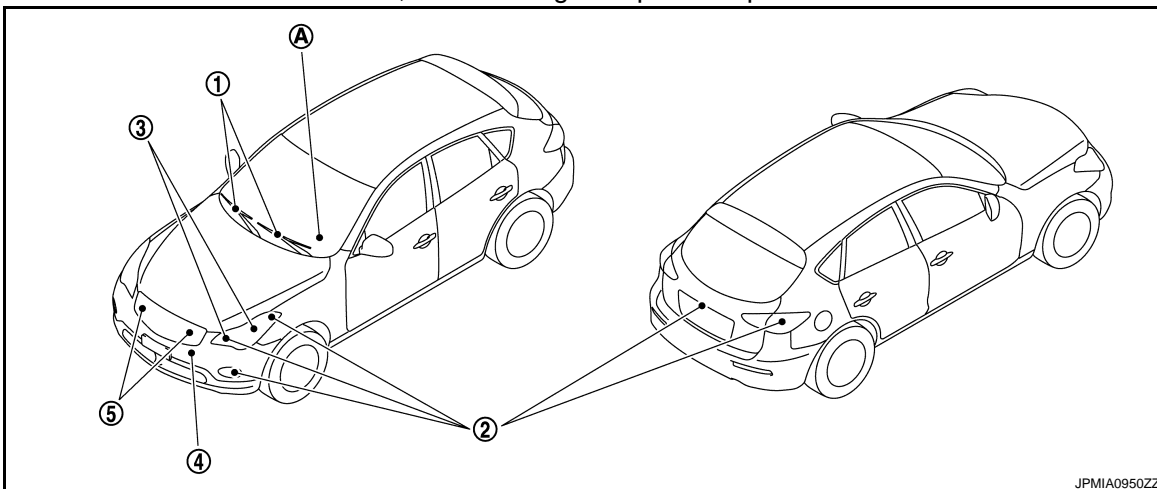

JPMIA0950ZZ

DIAGNOSIS SYSTEM (IPDM E/R)

< FUNCTION DIAGNOSIS >

[XENON TYPE]

Operation sequence	Inspection location	Operation
A	Oil pressure warning lamp	Blinks continuously during operation of auto active test
1	Front wiper	LO for 5 seconds → HI for 5 seconds
2	<ul style="list-style-type: none"> • Parking lamps • License plate lamps • Side maker lamps • Tail lamps • Front fog lamps 	10 seconds
3	Headlamps	<ul style="list-style-type: none"> • LO 10 seconds • HI ON ⇔ OFF 5 times
4	A/C compressor (magnet clutch)	ON ⇔ OFF 5 times
5*	Cooling fan	MID for 5 seconds → HI for 5 seconds

*: Outputs duty ratio of 50% for 5 seconds → duty ratio of 100% for 5 seconds on the cooling fan control module.

Concept of auto active test

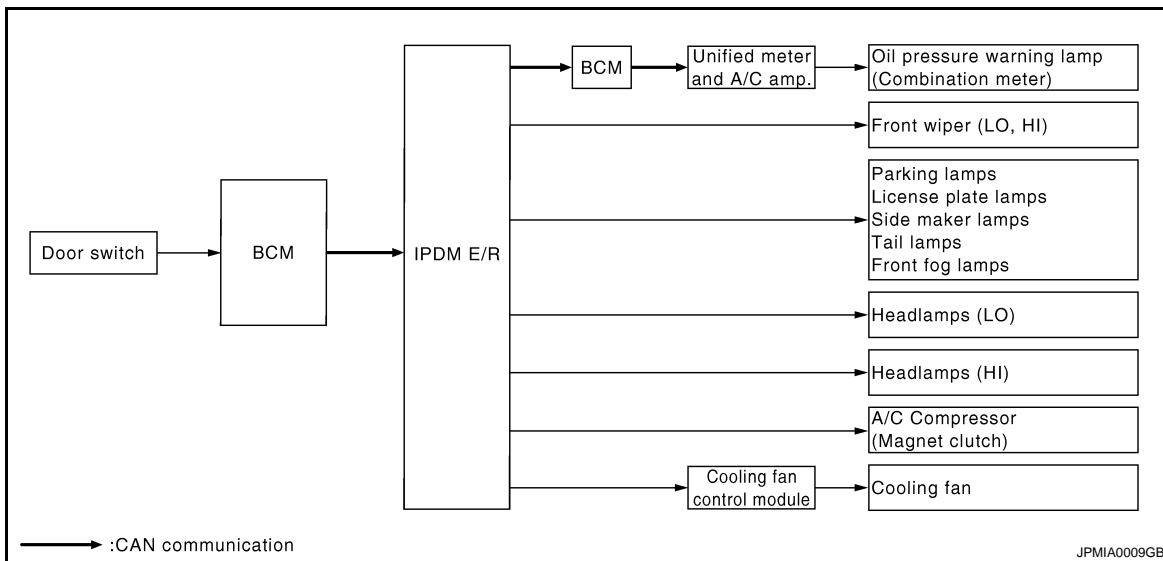

- IPDM E/R starts the auto active test with the door switch signals transmitted by BCM via CAN communication. Therefore, the CAN communication line between IPDM E/R and BCM is considered normal if the auto active test starts successfully.
- The auto active test facilitates troubleshooting if any systems controlled by IPDM E/R cannot be operated.

Diagnosis chart in auto active test mode

Symptom	Inspection contents	Possible cause	
Any of the following components do not operate <ul style="list-style-type: none"> • Parking lamps • License plate lamps • Side maker lamps • Tail lamps • Front fog lamps • Headlamp (HI, LO) • Front wiper 	Perform auto active test. Does the applicable system operate?	YES	BCM signal input circuit
		NO	<ul style="list-style-type: none"> • Lamp or motor • Lamp or motor ground circuit • Harness or connector between IPDM E/R and applicable system • IPDM E/R

DIAGNOSIS SYSTEM (IPDM E/R)

< FUNCTION DIAGNOSIS >

[XENON TYPE]

Symptom	Inspection contents		Possible cause
A/C compressor does not operate	Perform auto active test. Does the magnet clutch operate?	YES	<ul style="list-style-type: none"> • Unified meter and A/C amp. signal input circuit • CAN communication signal between unified meter and A/C amp. and ECM • CAN communication signal between ECM and IPDM E/R
		NO	<ul style="list-style-type: none"> • Magnet clutch • Harness or connector between IPDM E/R and magnet clutch • IPDM E/R
Oil pressure warning lamp does not operate	Perform auto active test. Does the oil pressure warning lamp blink?	YES	<ul style="list-style-type: none"> • Harness or connector between IPDM E/R and oil pressure switch • Oil pressure switch • IPDM E/R
		NO	<ul style="list-style-type: none"> • CAN communication signal between IPDM E/R and BCM • CAN communication signal between BCM and unified meter and A/C amp. • Combination meter
Cooling fan does not operate	Perform auto active test. Does the cooling fan operate?	YES	<ul style="list-style-type: none"> • ECM signal input circuit • CAN communication signal between ECM and IPDM E/R
		NO	<ul style="list-style-type: none"> • Cooling fan • Harness or connector between cooling fan and cooling fan control module • Cooling fan control module • Harness or connector between IPDM E/R and cooling fan control module • Cooling fan relay • Harness or connector between IPDM E/R and cooling fan relay • IPDM E/R

A
B
C
D
E
F
G
H
I
J
K
EXL
M
N
O
P

CONSULT-III Function (IPDM E/R)

INFOID:000000003757033

APPLICATION ITEM

CONSULT-III performs the following functions via CAN communication with IPDM E/R.

Diagnosis mode	Description
Ecu Identification	Allows confirmation of IPDM E/R part number.
Self Diagnostic Result	Displays the diagnosis results judged by IPDM E/R.
Data Monitor	Displays the real-time input/output data from IPDM E/R input/output data.
Active Test	IPDM E/R can provide a drive signal to electronic components to check their operations.
CAN Diag Support Monitor	The results of transmit/receive diagnosis of CAN communication can be read.

SELF DIAGNOSTIC RESULT

Refer to [EXL-167, "DTC Index"](#).

DATA MONITOR

DIAGNOSIS SYSTEM (IPDM E/R)

[XENON TYPE]

< FUNCTION DIAGNOSIS >

Monitor item

Monitor Item [Unit]	MAIN SIG- NALS	Description
RAD FAN REQ [%]	×	Displays the value of the cooling fan speed signal received from ECM via CAN communication.
AC COMP REQ [Off/On]	×	Displays the status of the A/C compressor request signal received from ECM via CAN communication.
TAIL&CLR REQ [Off/On]	×	Displays the status of the position light request signal received from BCM via CAN communication.
HL LO REQ [Off/On]	×	Displays the status of the low beam request signal received from BCM via CAN communication.
HL HI REQ [Off/On]	×	Displays the status of the high beam request signal received from BCM via CAN communication.
FR FOG REQ [Off/On]	×	Displays the status of the front fog light request signal received from BCM via CAN communication.
FR WIP REQ [Stop/1LOW/Low/Hi]	×	Displays the status of the front wiper request signal received from BCM via CAN communication.
WIP AUTO STOP [STOP P/ACT P]	×	Displays the status of the front wiper auto stop signal judged by IPDM E/R.
WIP PROT [Off/BLOCK]	×	Displays the status of the front wiper fail-safe operation judged by IPDM E/R.
IGN RLY1 -REQ [Off/On]		Displays the status of the ignition switch ON signal received from BCM via CAN communication.
IGN RLY [Off/On]	×	Displays the status of the ignition relay judged by IPDM E/R.
PUSH SW [Off/On]		Displays the status of the push-button ignition switch judged by IPDM E/R.
INTER/NP SW [Off/On]		Displays the status of the shift position judged by IPDM E/R.
ST RLY CONT [Off/On]		Displays the status of the starter relay status signal received from BCM via CAN communication.
IHBT RLY -REQ [Off/On]		Displays the status of the starter control relay signal received from BCM via CAN communication.
ST/INH RLY [Off/ ST /INH/UNKWN]		Displays the status of the starter relay and starter control relay judged by IPDM E/R.
DETENT SW [Off/On]		Displays the status of the control device (detention switch) judged by IPDM E/R.
S/L RLY -REQ [Off/On]		Displays the status of the steering lock relay request received from BCM via CAN communication.
S/L STATE [LOCK/UNLOCK/UNKWN]		Displays the status of the steering lock judged by IPDM E/R.
DTRL REQ [Off]		NOTE: The item is indicated, but not monitored.
OIL P SW [Open/Close]		Displays the status of the oil pressure switch judged by IPDM E/R.
HOOD SW [Off/On]		Displays the status of the hood switch judged by IPDM E/R.
HL WASHER REQ [Off]		NOTE: The item is indicated, but not monitored.
THFT HRN REQ [Off/On]		Displays the status of the theft warning horn request signal received from BCM via CAN communication.

DIAGNOSIS SYSTEM (IPDM E/R)

< FUNCTION DIAGNOSIS >

[XENON TYPE]

Monitor Item [Unit]	MAIN SIG- NALS	Description
HORN CHIRP [Off/On]		Displays the status of the horn reminder signal received from BCM via CAN communication.
CRNRNG LMP REQ [Off]		NOTE: The item is indicated, but not monitored.

ACTIVE TEST

Test item

Test item	Operation	Description
CORNERING LAMP	Off	NOTE: The item is indicated, but cannot be tested.
	LH	
	RH	
HORN	On	Operates horn relay 1 and horn relay 2 for 20 ms.
FRONT WIPER	Off	OFF
	Lo	Operates the front wiper relay.
	Hi	Operates the front wiper relay and front wiper high relay.
MOTOR FAN	1	OFF
	2	Outputs 50% pulse duty signal (PWM signal) to the cooling fan control module.
	3	Outputs 80% pulse duty signal (PWM signal) to the cooling fan control module.
	4	Outputs 100% pulse duty signal (PWM signal) to the cooling fan control module.
HEAD LAMP WASHER	On	NOTE: The item is indicated, but cannot be tested.
EXTERNAL LAMPS	Off	OFF
	TAIL	Operates the tail lamp relay.
	Lo	Operates the headlamp low relay.
	Hi	Operates the headlamp low relay and ON/OFF the headlamp high relay at 1 second intervals.
	Fog	Operates the front fog lamp relay.

A
B
C
D
E
F
G
H
I
J
K
EXL
M
N
O
P

EXL

DIAGNOSIS SYSTEM (AFS)

CONSULT-III Function (ADAPTIVE LIGHT)

INFOID:000000003135293

APPLICATION ITEM

Diagnostic mode	Description
Ecu Identification	Allows confirmation of auto levelizer control unit part number.
Self Diagnostic Result	Displays the diagnosis results judged by AFS control unit.
Work support	Sets each sensor.
Data monitor	Indicates AFS control unit input data in real time.
Active test	Provides the drive signal to the load. Checks operation.

WORK SUPPORT

Service item	Description
ST ANG SEN ADJUSTMENT*	—
LEVELIZER ADJUSTMENT	Adjusts the height sensor signal output value (AFS control unit recognized) in the unloaded vehicle condition.

*: Adjusts the steering angle sensor neutral position on ABS actuator and electrical unit (control unit) side. Refer to [BRC-8. "ADJUSTMENT OF STEERING ANGLE SENSOR NEUTRAL POSITION : Special Repair Requirement"](#).

DATA MONITOR

Monitor item [Unit]	Description
STR ANGLS SIG [deg]	The steering angle value judged by the steering angle sensor signal received from the steering angle sensor with CAN communication
VHCL SPD [km/h]	The vehicle speed signal value from the unified meter and A/C amp. with CAN communication
SLCT LVR POSI [P - 1]	The selector lever status judged by the position indicator signal received from TCM with CAN communication
HEAD LAMP [On/Off]	The headlamp On/Off status judged by the low beam headlamp (ON) signal received from IPDM E/R with CAN communication
AFS SW [On/Off]	The switch status input from AFS OFF switch
HI SEN OTP RR [V]	The height sensor signal voltage value input from the height sensor
LEV ACTR VLTG [%]	The ratio value to the battery voltage generated by the levelizer activation signal control value judged by AFS control unit
SWVL SEN RH* [deg]	The head lamp swivel angle value judged by AFS control unit received from the swivel position sensor signal input from the swivel actuator
SWVL SEN LH* [deg]	
SWVL ANGLE RH* [deg]	The swivel angle command value to the swivel motor judged by AFS control unit
SWVL ANGLE LH* [deg]	

*: The swivel angle "0°" (feedback value) of the swivel position sensor signal may differ from the swivel angle "0°" of the swivel motor (AFS control unit command value). This causes that the swivel motor initializes the value based on the step number from the stopper.

ACTIVE TEST

CAUTION:

Start the engine when using "ACTIVE TEST".

DIAGNOSIS SYSTEM (AFS)

[XENON TYPE]

< FUNCTION DIAGNOSIS >

Test item	Operation Item	Description
LOW BEAM TEST RIGHT	Origin Fast	Swivels the right headlamp to the swivel angle 0° in the normal speed.
	Peak Fast	Swivels the right headlamp to the swivel angle approximately 15° in the normal speed.
	Origin Slow	Swivels the right headlamp to the swivel angle 0° in the speed at the initialization.
	Peak Slow	Swivels the right headlamp to the swivel angle approximately 15° in the speed at the initialization.
LOW BEAM TEST LEFT	Origin Fast	Swivels the left headlamp to the swivel angle 0° in the normal speed.
	Peak Fast	Swivels the left headlamp to the swivel angle approximately 17° in the normal speed.
	Origin Slow	Swivels the left headlamp to the swivel angle 0° in the speed at the initialization.
	Peak Slow	Swivels the left headlamp to the swivel angle approximately 17° in the speed at the initialization.
LEVELIZER TEST	Origin	Changes the aiming motor drive signal to approximately 70% of the battery voltage. Moves the headlamp upward and downward.
	Peak	Changes the aiming motor drive signal to approximately 15% of the battery voltage. Moves the headlamp upward and downward.

NOTE:

"Fast" operation speed is as three times fast as "Slow".

A
B
C
D
E
F
G
H
I
J
K
L
M
N
O
P

EXL

COMPONENT DIAGNOSIS

B2503, B2504 SWIVEL ACTUATOR

Description

INFOID:000000003135294

SWIVEL ACTUATOR

The swivel actuator is installed in the headlamp unit. The swivel actuator consists of the swivel motor and the swivel position sensor.

SWIVEL MOTOR

- The swivel motor is the two-phase step motor.
- The swivel motor drives headlamp by exciting the two drive coils according to the drive signal from AFS control unit.
- The rotation direction of the swivel motor is changeable by changing the exciting pattern.

SWIVEL POSITION SENSOR

The swivel position sensor detects the headlamp swivel angle to transmit the swivel position sensor signal to AFS control unit.

DTC Logic

INFOID:000000003135295

DTC DETECTION LOGIC

- [B2503] Swivel actuator [RH]
- [B2504] Swivel actuator [LH]

DTC detection condition	DTC erase condition	Possible cause
<p>AFS control unit indicates an applicable DTC when detecting any of the following conditions continuously for 2 seconds or more.</p> <ul style="list-style-type: none"> • AFS control unit-recognized swivel position differs extremely from the swivel position sensor-input value while the swivel operating.* • The swivel position sensor signal does not change even though AFS control unit transmits the swivel motor driving signal while the swivel operating* . • The swivel motor short and open is detected while the swivel operating* . • The swivel position sensor power supply is 6 V or more, or 4 V or less. • The swivel position sensor signal is 0.25 V or less, or 4.75 V or more. 	<p>Ignition switch OFF</p>	<p>Swivel position sensor</p> <ul style="list-style-type: none"> • Swivel position sensor • Harness and connector • AFS control unit <p>Swivel motor</p> <ul style="list-style-type: none"> • Swivel motor • Harness and connector • AFS control unit

*: Initialization is not included.

DTC CONFIRMATION PROCEDURE

1. DTC ERASE

Erase the DTC memory of AFS with CONSULT-III.

>> GO TO 2.

2. CONFIRMATION DTC SELECTION

Select "B2503" or "B2504" for confirmation.

Which DTC is confirmation?

B2503 >> GO TO 3.

B2504 >> GO TO 4.

3. DTC CONFIRMATION (B2503)

1. Steer to the straight-forward position.
2. Start the engine.
3. Turn AFS OFF switch OFF.
4. Turn the headlamp ON.
5. Shift the selector lever to "N".
6. Steer to the right. (Rotate it once or more.)
7. Perform the self-diagnosis with CONSULT-III.

B2503, B2504 SWIVEL ACTUATOR

[XENON TYPE]

< COMPONENT DIAGNOSIS >

Is "B2503" detected?

- YES >> Refer to [EXL-45, "Diagnosis Procedure"](#).
- NO >> Refer to [GI-38, "Intermittent Incident"](#).

4.DTC CONFIRMATION (B2504)

1. Steer to the straight-forward position.
2. Start the engine.
3. Turn AFS OFF switch OFF.
4. Turn the headlamp ON.
5. Drive at 25 km/h (15.5 MPH) or more.
6. Steer to the left. (Rotate it once or more.)
7. Stop the vehicle.
8. Perform the self-diagnosis with CONSULT-III.

Is "B2504" detected?

- YES >> Refer to [EXL-45, "Diagnosis Procedure"](#).
- NO >> Refer to [GI-38, "Intermittent Incident"](#).

Diagnosis Procedure

INFOID:000000003135296

1.CHECK SWIVEL POSITION SENSOR SIGNAL INPUT

1. Turn the ignition switch ON.
2. Check the voltage between the AFS control unit harness connector and the ground.

Terminals			Voltage (Approx.)
(+)	(-)		
AFS control unit			Ground 0.25 - 4.75 V
Connector	Terminal		
RH	M16	9	
LH		29	

Is the measurement value within the standard value?

- YES >> GO TO 2.
- Less than the standard value >>GO TO 6.
- Higher than the standard value>>GO TO 9.

2.CHECK SWIVEL MOTOR

Check the swivel motor.[EXL-48, "Component Inspection"](#).

Is the inspection result normal?

- YES >> GO TO 3.
- NO >> Replace the front combination lamp.

3.CHECK SWIVEL MOTOR OPEN CIRCUIT

1. Turn the ignition switch OFF.
2. Disconnect AFS control unit connector and the headlamp swivel actuator connector.
3. Check continuity between the AFS control unit harness connector and the headlamp swivel actuator harness connector.

A
B
C
D
E
F
G
H
I
J
K
EXL
M
N
O
P

B2503, B2504 SWIVEL ACTUATOR

< COMPONENT DIAGNOSIS >

[XENON TYPE]

AFS control unit		Headlamp swivel actuator		Continuity			
Connector	Terminal	Connector	Terminal				
RH	M16	E29	11	8	Existed		
			13	7			
			32	3			
			34	4			
LH		M16	E59	15		3	Existed
				17		4	
				36		8	
				38		7	

Does continuity exist?

YES >> GO TO 4.

NO >> Repair the harnesses or connectors.

4. CHECK SWIVEL MOTOR SHORT CIRCUIT

Check continuity between the AFS control unit harness connector and the ground.

AFS control unit		Continuity					
Connector	Terminal						
RH	M16	Ground	11	Not existed			
			13				
			32				
			34				
LH			M16		Ground	15	Not existed
						17	
						36	
						38	

Does continuity exist?

YES >> Repair the harnesses or connectors.

NO >> GO TO 5.

5. CHECK SWIVEL MOTOR CIRCUIT VOLTAGE OUTPUT

1. Connect AFS control unit connector.
2. Turn the ignition switch ON.
3. Turn the headlamp ON.
4. Select "LOW BEAM TEST RIGHT" or "LOW BEAM TEST LEFT" of ADAPTIVE LIGHT active test item.
5. With operating the test item, check the voltage between the AFS control unit harness connector and the ground.

B2503, B2504 SWIVEL ACTUATOR

< COMPONENT DIAGNOSIS >

[XENON TYPE]

Terminals			Condition	Voltage (Approx.)				
(+)		(-)						
AFS control unit			Swivel motor					
Connector	Terminal							
RH	M16	11	Ground	Active				
		32						
		15						
LH	M16	36			Ground	Active		
		13						
		34						
		17						
LH	M16	38					Ground	Active
				8 - 12 V				
				9.5 - 11.5 V				

Is the measurement value within the standard value?

YES >> Replace the front combination lamp.

NO >> Replace AFS control unit.

6. CHECK SWIVEL POSITION SENSOR SIGNAL OUTPUT

Check the voltage between the AFS control unit harness connector and the ground.

Terminals			Condition	Voltage (Approx.)
(+)		(-)		
AFS control unit			Ground	5 V
Connector	Terminal			
RH	M16	4	Ground	5 V
LH		24		

Is the measurement value normal?

YES >> GO TO 7.

NO >> GO TO 9.

7. CHECK SWIVEL POSITION SENSOR POWER SUPPLY CIRCUIT INPUT VOLTAGE

1. Turn the ignition switch OFF.
2. Disconnect the headlamp swivel actuator connector.
3. Turn the ignition switch ON.
4. Check the voltage between the headlamp swivel actuator harness connector and the ground.

Terminals			Condition	Voltage (Approx.)
(+)		(-)		
Headlamp swivel actuator			Ground	5 V
Connector	Terminal			
RH	E29	2	Ground	5 V
LH	E59	2		

Is the measurement value normal?

YES >> GO TO 8.

NO >> Repair the harnesses or connectors.

8. CHECK SWIVEL POSITION SENSOR SIGNAL SHORT CIRCUIT

B2503, B2504 SWIVEL ACTUATOR

[XENON TYPE]

< COMPONENT DIAGNOSIS >

1. Turn the ignition switch OFF.
2. Disconnect AFS control unit connector.
3. Check continuity between the AFS control unit harness connector and the headlamp swivel actuator harness connector.

AFS control unit		Headlamp swivel actuator		Continuity
Connector	Terminal	Connector	Terminal	
RH	M16	9	E29	Existed
LH		29	E59	

Does continuity exist?

YES >> Replace the front combination lamp.

NO >> Repair the harnesses or connectors.

9. CHECK SWIVEL POSITION SENSOR GROUND CIRCUIT VOLTAGE OUTPUT

Check the voltage between the AFS control unit harness connector and the ground.

Terminals			Voltage (Approx.)
(+)		(-)	
AFS control unit			Ground
Connector	Terminal		
RH	M16	2	
LH		27	
			0 V

Is the measurement value normal?

YES >> GO TO 10.

NO >> Replace AFS control unit.

10. CHECK SWIVEL POSITION SENSOR SHORT GROUND CIRCUIT

1. Turn the ignition switch OFF.
2. Disconnect AFS control unit connector and the headlamp swivel actuator connector.
3. Check continuity between the AFS control unit harness connector and the headlamp swivel actuator harness connector.

AFS control unit		Headlamp swivel actuator		Continuity
Connector	Terminal	Connector	Terminal	
RH	M16	2	E29	Existed
LH		27	E59	

Does continuity exist?

YES >> Replace the front combination lamp.

NO >> Repair the harnesses or connectors.

Component Inspection

INFOID:000000003135297

1. CHECK SWIVEL MOTOR SINGLE PART

1. Disconnect the swivel actuator connector.
2. Check the resistance among each swivel actuator connector terminal.

Swivel actuator		Resistance (Approx.)
Terminal	Terminal	
3	7	7.2 Ω
4	8	7.2 Ω
3	4	10 MΩ or more

B2503, B2504 SWIVEL ACTUATOR

< COMPONENT DIAGNOSIS >

[XENON TYPE]

Is the measurement value normal?

YES >> Swivel actuator is normal.

NO >> Replace the front combination lamp.

A

B

C

D

E

F

G

H

I

J

K

EXL

M

N

O

P

B2514 HEIGHT SENSOR UNUSUAL [RR]

< COMPONENT DIAGNOSIS >

[XENON TYPE]

B2514 HEIGHT SENSOR UNUSUAL [RR]

Description

INFOID:000000003135298

The height sensor is installed to the rear suspension arm. The height sensor detects the suspension arm displacement as the vehicle height change. The height sensor transmits the height sensor signal to AFS control unit.

NOTE:

The sensor angle of the unloaded vehicle position is the reference value.

DTC Logic

INFOID:000000003135299

DTC DETECTION LOGIC

[B2514] Height sensor unusual [RR]

DTC detection condition	DTC erase condition	Possible cause
An applicable DTC is indicated when any of the following conditions is detected continuously for 2 seconds or more. <ul style="list-style-type: none"> The height sensor power supply is 6 V or more, or 4 V or less. The height sensor signal is 0.25 V or less, or 4.75 V or more. 	Ignition switch OFF	Height sensor <ul style="list-style-type: none"> Height sensor Harness and connector AFS control unit

DTC CONFIRMATION PROCEDURE

1.DTC ERASE

Erase the DTC memory of AFS with CONSULT-III.

>> GO TO 2.

2.DTC CONFIRMATION

1. Start the engine.
2. Turn the headlamp ON.
3. Select the self-diagnosis with CONSULT-III.
4. Check the self-diagnosis result. Refer to [EXL-178, "DTC Index"](#).

Is "B2514" detected?

YES >> Refer to [EXL-50, "Diagnosis Procedure"](#).

NO >> Refer to [GI-38, "Intermittent Incident"](#).

Diagnosis Procedure

INFOID:000000003135300

1.CHECK HEIGHT SENSOR POWER SUPPLY OUTPUT

1. Turn the ignition switch ON.
2. Check the voltage between the AFS control unit harness connector and the ground.

Terminals		Voltage (Approx.)
(+)	(-)	
AFS control unit		5 V
Connector	Terminal	
M16	6	

Is the measurement value within the standard value?

YES >> GO TO 2.

NO >> Replace AFS control unit.

2.CHECK HEIGHT SENSOR POWER SUPPLY INPUT

Check the voltage between the AFS control unit harness connector and the ground.

B2514 HEIGHT SENSOR UNUSUAL [RR]

< COMPONENT DIAGNOSIS >

[XENON TYPE]

Terminals		Voltage (Approx.)
(+)	(-)	
AFS control unit		Ground
Connector	Terminal	
M16	28	
		0.25 - 4.75 V

A

B

Is the measurement value within the standard value?

C

- YES >> Replace AFS control unit.
- Less than the standard value >>GO TO 3.
- Higher than the standard value>>GO TO 6.

D

3.CHECK HEIGHT SENSOR POWER SUPPLY CIRCUIT OUTPUT VOLTAGE

1. Turn the ignition switch OFF.
2. Disconnect the height sensor connector.
3. Turn the ignition switch ON.
4. Check the voltage between the height sensor harness connector and the ground.

E

F

Terminals		Voltage (Approx.)
(+)	(-)	
Height sensor		Ground
Connector	Terminal	
B32	1	
		5 V

G

H

Is the measurement value within the standard value?

- YES >> GO TO 4.
- NO >> Repair the harnesses or connectors.

I

4.CHECK HEIGHT SENSOR SIGNAL OPEN CIRCUIT

1. Turn the ignition switch OFF.
2. Disconnect AFS control unit connector.
3. Check continuity between the AFS control unit harness connector and the height sensor harness connector.

J

K

AFS control unit		Height sensor		Continuity
Connector	Terminal	Connector	Terminal	
M16	28	B32	2	Existed

EXL

Does continuity exist?

- YES >> GO TO 5.
- NO >> Repair the harnesses or connectors.

M

5.CHECK HEIGHT SENSOR SIGNAL SHORT CIRCUIT

Check continuity between the height sensor harness connector and the ground.

N

Height sensor		Ground	Continuity
Connector	Terminal		
B32	2		Not existed

O

P

Does continuity exist?

- YES >> Repair the harnesses or connectors.
- NO >> Replace the height sensor.

6.CHECK HEIGHT SENSOR GROUND

Check the voltage between the AFS control unit harness connector and the ground.

B2514 HEIGHT SENSOR UNUSUAL [RR]

< COMPONENT DIAGNOSIS >

[XENON TYPE]

Terminals		Voltage (Approx.)
(+)	(-)	
AFS control unit		Ground
Connector	Terminal	
M16	8	

Is the measurement value within the standard value?

YES >> GO TO 7.

NO >> Replace AFS control unit.

7.CHECK HEIGHT SENSOR GROUND CIRCUIT

1. Turn the ignition switch OFF.
2. Disconnect AFS control unit connector and the height sensor connector.
3. Check continuity between the AFS control unit harness connector and the height sensor harness connector.

AFS control unit		Height sensor		Continuity
Connector	Terminal	Connector	Terminal	
M16	8	B32	3	Existed

Does continuity exist?

YES >> Replace the height sensor.

NO >> Repair the harnesses or connectors.

Component Inspection

INFOID:000000003135301

1.CHECK HEIGHT SENSOR

1. Remove the height sensor (the height sensor connector is connected).
2. Start the engine.
3. Turn the light switch 2ND.
4. Select "HI SEN OTP RR" of AFS data monitor item.
5. With moving the sensor lever, check the monitor status.

Monitor item	Condition		Monitor status [Standard value (Approx.)]
HI SEN OTP RR	Sensor lever position	Contact with stopper	0.9 V
		Moving between two positions	Smooth movement
		90° from stopper	4.5 V

Is the output value normal?

YES >> Height sensor is normal.

NO >> Replace the height sensor.

B2516 SHIFT SIGNAL [P, R]

< COMPONENT DIAGNOSIS >

[XENON TYPE]

B2516 SHIFT SIGNAL [P, R]

Description

INFOID:000000003135302

AFS control unit receives the shift position signal from TCM with CAN communication.

DTC Logic

INFOID:000000003135303

DTC DETECTION LOGIC

[B2516] Shift signal [P, R]

DTC detection condition	DTC erase condition	Possible causes
The shift position signal is not received.	Ignition switch OFF	<ul style="list-style-type: none">• TCM• AFS control unit

DTC CONFIRMATION PROCEDURE

1. DTC ERASE

Erase the DTC memory of AFS with CONSULT-III.

>> GO TO 2.

2. DTC CONFIRMATION

1. Turn ignition ON.
2. Select the self-diagnosis with CONSULT-III.
3. Check the self-diagnosis result. Refer to [EXL-178. "DTC Index"](#).

Is "B2516" detected?

- YES >> Refer to [EXL-53. "Diagnosis Procedure"](#).
NO >> Refer to [GI-38. "Intermittent Incident"](#).

Diagnosis Procedure

INFOID:000000003135304

1. TCM SELF-DIAGNOSIS

Check the self-diagnosis result with CONSULT-III. Check that TCM does not detect any DTCs.

Is any DTC detected?

- YES >> Check TCM. Refer to [TM-104. "Reference Value"](#).
NO >> GO TO 2.

2. DTC ERASE

Erase the DTC memory of AFS with CONSULT-III.

Is the memory erased?

- YES >> Inspection end.
NO >> Replace AFS control unit.

A
B
C
D
E
F
G
H
I
J
K
L
M
N
O
P

EXL

B2517 VEHICLE SPEED SIGNAL

< COMPONENT DIAGNOSIS >

[XENON TYPE]

B2517 VEHICLE SPEED SIGNAL

Description

INFOID:000000003135305

AFS control unit receives the vehicle speed signal from the unified meter and A/C amp. with CAN communication.

DTC Logic

INFOID:000000003135306

DTC DETECTION LOGIC

[B2517] Vehicle speed signal

DTC detection condition	DTC erase condition	Possible causes
The vehicle speed signal is not received.	Ignition switch OFF	<ul style="list-style-type: none">Unified meter and A/C amp.AFS control unit

DTC CONFIRMATION PROCEDURE

1. DTC ERASE

Erase the DTC memory of AFS with CONSULT-III.

>> GO TO 2.

2. DTC CONFIRMATION

- Turn ignition ON.
- Select the self-diagnosis with CONSULT-III.
- Check the self-diagnosis result. Refer to [EXL-178, "DTC Index"](#).

Is "B2517" detected?

- YES >> Refer to [EXL-54, "Diagnosis Procedure"](#).
NO >> Refer to [GI-38, "Intermittent Incident"](#).

Diagnosis Procedure

INFOID:000000003135307

1. UNIFIED METER AND A/C AMP. SELF-DIAGNOSIS

Check the self-diagnosis result with CONSULT-III. Check that the unified meter and A/C amp. does not detect any DTCs.

Is any DTC detected?

- YES >> Check the unified meter and A/C amp. Refer to [MWI-101, "DTC Index"](#).
NO >> GO TO 2.

2. DTC ERASE

Erase the DTC memory of AFS with CONSULT-III.

Is the memory erased?

- YES >> Inspection end.
NO >> Replace AFS control unit.

B2519 LEVELIZER CALIBRATION

< COMPONENT DIAGNOSIS >

[XENON TYPE]

B2519 LEVELIZER CALIBRATION

Description

INFOID:000000003135308

AFS control unit transmits the height sensor signal from the height sensor.

DTC Logic

INFOID:000000003135309

[B2519] Levelizer calibration

DTC detection condition	DTC erase condition	Possible causes
The height sensor adjustment position is not recognized.	When the levelizer adjustment is completed	AFS control unit

Diagnosis Procedure

INFOID:000000003135310

1. LEVELIZER ADJUSTMENT

Perform the levelizer adjustment.

>> Refer to [EXL-9, "LEVELIZER ADJUSTMENT : Special Repair Requirement"](#).

A
B
C
D
E
F
G
H
I
J
K
L
M
N
O
P

EXL

B2521 ECU CIRCUIT

Description

INFOID:000000003135311

AFS control unit judges the vehicle condition from each signal. AFS control unit controls AFS function and the headlamp aiming.

DTC Logic

INFOID:000000003135312

DTC DETECTION LOGIC

[B2521] ECU circuit

Error detection condition	DTC erase condition	Possible cause
<ul style="list-style-type: none"> • AFS control unit indicates an applicable DTC when detecting any of the following conditions continuously for 2 seconds or more. - The swivel position sensor is shorted to the power supply or the ground. - The swivel position sensor signal is shorted to the ground. - The height sensor power supply is shorted to the power supply or the ground. - The height sensor signal is shorted to the ground. • AFS control unit RAM/ROM error 	Ignition switch OFF	Swivel position sensor <ul style="list-style-type: none"> • Swivel position sensor • Harness and connector • AFS control unit Height sensor <ul style="list-style-type: none"> • Height sensor • Harness and connector • AFS control unit AFS control unit (RAM/ROM) <ul style="list-style-type: none"> • AFS control unit

DTC CONFIRMATION PROCEDURE

1.DTC ERASE

Erase the DTC memory of AFS with CONSULT-III.

>> GO TO 2.

2.DTC CONFIRMATION PROCEDURE

1. Turn ignition ON.
2. Select the self-diagnosis with CONSULT-III.
3. Check the self-diagnosis result. Refer to [EXL-178, "DTC Index"](#).

Is "B2521" detected?

- YES >> Refer to [EXL-56, "Diagnosis Procedure"](#).
 NO >> Refer to [GI-38, "Intermittent Incident"](#).

Diagnosis Procedure

INFOID:000000003135313

1.CHECK EACH SENSOR POWER SUPPLY

1. Turn the ignition switch ON.
2. Check the voltage between the AFS control unit harness connector and the ground.

Terminals		Voltage (Approx.)
(+)	(-)	
AFS control unit		5 V
Connector	Terminal	
M16	4	
	6	
	24	
		Ground

Is the measurement value within the standard value?

- YES >> GO TO 2.
 Less than the standard value >>GO TO 3.
 Higher than the standard value>>GO TO 4.

B2521 ECU CIRCUIT

[XENON TYPE]

< COMPONENT DIAGNOSIS >

2. CHECK EACH SENSOR SIGNAL

Check the voltage between the AFS control unit harness connector and the ground.

Terminals		Voltage (Approx.)	
(+)	(-)		
AFS control unit		Ground	0.25 - 4.75 V
Connector	Terminal		
M16	9		
	28		
	29		

Is the measurement value within the standard value?

YES >> Replace AFS control unit.

Less than the standard value >> GO TO 5.

Higher than the standard value >> GO TO 6.

3. CHECK EACH SENSOR POWER SUPPLY SHORT CIRCUIT

1. Turn the ignition switch OFF.
2. Disconnect AFS control unit connector.
3. Check continuity between the AFS control unit harness connector and the ground.

AFS control unit		Ground	Continuity
Connector	Terminal		
M16	4	Ground	Not existed
	6		
	24		

Does continuity exist?

YES >> Repair the harnesses or connectors.

NO >> Replace AFS control unit.

4. CHECK EACH SENSOR POWER SUPPLY CIRCUIT

1. Turn the ignition switch OFF.
2. Disconnect AFS control unit connector.
3. Check the voltage between the AFS control unit harness connector and the ground.

Terminals		Voltage (Approx.)	
(+)	(-)		
AFS control unit		Ground	0 V
Connector	Terminal		
M16	4		
	6		
	24		

Is the measurement value normal?

YES >> Replace AFS control unit.

NO >> Repair the harnesses or connectors.

5. CHECK EACH SENSOR SIGNAL SHORT CIRCUIT

1. Turn the ignition switch OFF.
2. Disconnect AFS control unit connector.
3. Check continuity between the AFS control unit harness connector and the ground.

B2521 ECU CIRCUIT

[XENON TYPE]

< COMPONENT DIAGNOSIS >

AFS control unit		Ground	Continuity
Connector	Terminal		
M16	9	Ground	Not existed
	28		
	29		

Does continuity exist?

- YES >> Repair the harnesses or connectors.
NO >> Replace AFS control unit.

6. CHECK EACH SENSOR SIGNAL SHORT CIRCUIT

1. Turn the ignition switch OFF.
2. Disconnect AFS control unit connector.
3. Turn the ignition switch ON.
4. Check the voltage between the AFS control unit harness connector and the ground.

Terminals		Ground	Voltage (Approx.)
(+)	(-)		
AFS control unit		Ground	0 V
Connector	Terminal		
M16	9		
	28		
	29		

Is the measurement value normal?

- YES >> Replace AFS control unit.
NO >> Repair the harnesses or connectors.

C0126 STEERING ANGLE SENSOR SIGNAL

< COMPONENT DIAGNOSIS >

[XENON TYPE]

C0126 STEERING ANGLE SENSOR SIGNAL

Description

INFOID:000000003135314

AFS control unit receives the steering angle sensor signal from the steering angle sensor with CAN communication.

DTC Logic

INFOID:000000003135315

DTC DETECTION LOGIC

[C0126] Steering angle sensor signal

DTC detection condition	DTC erase condition	Possible causes
In any of the following conditions <ul style="list-style-type: none">The steering angle sensor signal is not received.The steering angle sensor signal error is received.Out-of-standard signal (-900°- +900°) is received.	The ignition switch OFF	<ul style="list-style-type: none">Steering angle sensorAFS control unit

DTC CONFIRMATION PROCEDURE

1. DTC ERASE

Erase the DTC memory of AFS with CONSULT-III.

>> GO TO 2.

2. DTC CONFIRMATION

1. Start the engine.
2. Turn the steering wheel to the maximum right/left.
3. Select the self-diagnosis with CONSULT-III.
4. Check the self-diagnosis result. Refer to [EXL-178. "DTC Index"](#).

Is "C0126" detected?

- YES >> Refer to [EXL-59. "Diagnosis Procedure"](#).
NO >> Refer to [GI-38. "Intermittent Incident"](#).

Diagnosis Procedure

INFOID:000000003135316

1. ABS ACTUATOR AND ELECTRICAL UNIT (CONTROL UNIT) SELF-DIAGNOSIS

Check the self-diagnosis result with CONSULT-III. Check that ABS actuator and electrical unit (control unit) does not detect any DTCs.

Is any DTC detected?

- YES >> Check ABS actuator and electrical unit (control unit). Refer to [BRC-95. "DTC No. Index"](#).
NO >> GO TO 2.

2. DTC ERASE

Erase DTC memory of AFS with CONSULT-III.

Is the memory erased?

- YES >> Inspection end.
NO >> Replace AFS control unit.

C0428 STEERING ANGLE SENSOR CALIBRATION

< COMPONENT DIAGNOSIS >

[XENON TYPE]

C0428 STEERING ANGLE SENSOR CALIBRATION

Description

INFOID:000000003135317

AFS control unit receives the steering angle sensor signal from the steering angle sensor with CAN communication.

DTC Logic

INFOID:000000003135318

[C0428] Steering angle sensor calibration

DTC detection condition	DTC erase condition	Possible causes
The steering angle sensor neutral position is not recognized.	When the steering angle sensor neutral position registration is completed	Steering angle sensor

Diagnosis Procedure

INFOID:000000003135319

1. STEERING ANGLE SENSOR NEUTRAL POSITION ADJUSTMENT

Perform the steering angle sensor neutral position adjustment.

CAUTION:

Perform the steering angle sensor neutral position adjustment on VDC side. VDC may activate incorrectly.

>> Refer to [BRC-8, "ADJUSTMENT OF STEERING ANGLE SENSOR NEUTRAL POSITION : Special Repair Requirement"](#).

U1000 CAN COMM CIRCUIT

< COMPONENT DIAGNOSIS >

[XENON TYPE]

U1000 CAN COMM CIRCUIT

Description

INFOID:000000003135320

CAN (Controller Area Network) is the serial transmission for real time application. CAN is the multiplex communication for the vehicle with superior data transmission speed and error detection ability. Many electronic control units are equipped on the vehicle. These control units do not operate individually, but associates with other control units by sharing information. In CAN communication, each control unit is connected with two communication lines (CAN-H and CAN-L). Much information is transmitted with fewer communication lines than before. Each control unit transmits/receives data and reads the necessary data only. CAN Communication Signal Chart. Refer to [LAN-27. "CAN Communication Signal Chart"](#).

DTC Logic

INFOID:000000003135321

DTC DETECTION LOGIC

[U1000] CAN communication circuit

DTC detection condition	DTC erase condition	Possible causes
When AFS control unit does not transmit/receive CAN communication signal continuously for 2 seconds or more	Ignition switch OFF	CAN communication system

Diagnosis Procedure

INFOID:000000003135322

1. PERFORM SELF DIAGNOSTIC

1. Turn ignition switch ON and wait for 2 seconds or more.
2. Check "Self Diagnostic Result".

Is "CAN COMM CIRCUIT" displayed?

- YES >> Refer to [LAN-18. "Trouble Diagnosis Flow Chart"](#).
NO >> Refer to [GI-38. "Intermittent Incident"](#).

A
B
C
D
E
F
G
H
I
J
K
EXL
M
N
O
P

U1010 CONTROL UNIT (CAN)

< COMPONENT DIAGNOSIS >

[XENON TYPE]

U1010 CONTROL UNIT (CAN)

DTC Logic

INFOID:000000003596964

DTC DETECTION LOGIC

[U1000] CAN communication circuit

DTC	CONSULT-III display description	DTC detection condition	Possible causes
U1010	CONTROL UNIT (CAN)	AFS control unit detected internal CAN communication circuit malfunction.	AFS control unit

Diagnosis Procedure

INFOID:000000003596965

1. REPLACE AFS CONTROL UNIT

When DTC [U1010] is detected, replace AFS control unit.

>> Replace AFS control unit.

POWER SUPPLY AND GROUND CIRCUIT

< COMPONENT DIAGNOSIS >

[XENON TYPE]

POWER SUPPLY AND GROUND CIRCUIT

BCM (BODY CONTROL MODULE)

BCM (BODY CONTROL MODULE) : Diagnosis Procedure

INFOID:000000003757034

1. CHECK FUSE AND FUSIBLE LINK

Check that the following fuse and fusible link are not blown.

Signal name	Fuse and fusible link No.
Battery power supply	K
	10

Is the fuse fusing?

YES >> Replace the blown fuse or fusible link after repairing the affected circuit if a fuse or fusible link is blown.

NO >> GO TO 2.

2. CHECK POWER SUPPLY CIRCUIT

1. Turn ignition switch OFF.
2. Disconnect BCM connectors.
3. Check voltage between BCM harness connector and ground.

Terminals		Voltage (Approx.)
(+)	(-)	
BCM		Ground Battery voltage
Connector	Terminal	
M118	1	
M119	11	

Is the measurement value normal?

YES >> GO TO 3.

NO >> Repair harness or connector.

3. CHECK GROUND CIRCUIT

Check continuity between BCM harness connector and ground.

BCM		Ground	Continuity
Connector	Terminal		
M119	13		Existed

Does continuity exist?

YES >> INSPECTION END

NO >> Repair harness or connector.

IPDM E/R (INTELLIGENT POWER DISTRIBUTION MODULE ENGINE ROOM)

IPDM E/R (INTELLIGENT POWER DISTRIBUTION MODULE ENGINE ROOM) : Diagnosis Procedure

INFOID:000000003757035

1. CHECK FUSES AND FUSIBLE LINK

Check that the following IPDM E/R fuses or fusible links are not blown.

POWER SUPPLY AND GROUND CIRCUIT

< COMPONENT DIAGNOSIS >

[XENON TYPE]

Signal name	Fuses and fusible link No.
Battery power supply	C
	50
	51

Is the fuse fusing?

YES >> Replace the blown fuse or fusible link after repairing the affected circuit if a fuse or fusible link is blown.

NO >> GO TO 2.

2.CHECK POWER SUPPLY CIRCUIT

1. Turn ignition switch OFF.
2. Disconnect IPDM E/R connector.
3. Check voltage between IPDM E/R harness connector and ground.

Terminals		Voltage (Approx.)
(+)	(-)	
IPDM E/R		Battery voltage
Connector	Terminal	
E4	1	

Is the measurement value normal?

YES >> GO TO 3.

NO >> Repair harness or connector.

3.CHECK GROUND CIRCUIT

Check continuity between IPDM E/R harness connectors and ground.

IPDM E/R		Ground	Continuity
Connector	Terminal		
E5	12		Existed
E6	41		

Does continuity exist?

YES >> INSPECTION END

NO >> Repair harness or connector.

AFS CONTROL UNIT

AFS CONTROL UNIT : Diagnosis Procedure

INFOID:000000003135326

1.FUSE INSPECTION

Check that the following fuses are not fusing.

Signal name	Connection position	Fuse No.	Capacity
Ignition power supply	FUSE BLOCK (J/B)	3	10 A

Is the fuse fusing?

YES >> Repair the applicable circuit. And then replace the fuse.

NO >> GO TO 2.

2.CHECK POWER SUPPLY CIRCUIT

1. Turn ignition switch OFF.
2. Disconnect AFS control unit harness connector.
3. Turn ignition switch ON.
4. Check voltage between AFS control unit harness connector and ground.

POWER SUPPLY AND GROUND CIRCUIT

< COMPONENT DIAGNOSIS >

[XENON TYPE]

Terminals		Voltage (Approx.)
(+)	(-)	
AFS control unit		Ground Battery voltage
Connector	Terminal	
M16	1	

A

B

Is the measurement value normal?

C

YES >> GO TO 3.

NO >> Repair harness or connector.

3.CHECK GROUND CIRCUIT

D

1. Turn ignition switch OFF.
2. Check continuity between AFS control unit harness connectors and ground.

E

AFS control unit		Ground	Continuity
Connector	Terminal		
M16	25		Existed

F

Does continuity exist?

YES >> Power supply and ground circuit are normal.

NO >> Repair harness or connector.

G

H

I

J

K

EXL

M

N

O

P

EXTERIOR LAMP FUSE

< COMPONENT DIAGNOSIS >

[XENON TYPE]

EXTERIOR LAMP FUSE

Description

INFOID:000000003135327

Fuse list

Unit	Location	Fuse No.	Capacity
Headlamp HI (LH)	IPDM E/R	#54	10 A
Headlamp HI (RH)	IPDM E/R	#55	10 A
Headlamp LO (LH)	IPDM E/R	#56	15 A
Headlamp LO (RH)	IPDM E/R	#57	15 A
Front fog lamp	IPDM E/R	#58	15 A
<ul style="list-style-type: none">• Parking lamp• Front side marker lamp	IPDM E/R	#52	10 A
<ul style="list-style-type: none">• Tail lamp• Rear side marker lamp• License plate lamp• Each illumination	IPDM E/R	#53	10 A
Stop lamp	FUSE BLOCK (J/B)	#7	10 A
Back-up lamp	FUSE BLOCK (J/B)	#4	10 A

Diagnosis Procedure

INFOID:000000003135328

1. CHECK FUSE

Check that the following fuses are not fusing.

Unit	Location	Fuse No.	Capacity
Headlamp HI (LH)	IPDM E/R	#54	10 A
Headlamp HI (RH)	IPDM E/R	#55	10 A
Headlamp LO (LH)	IPDM E/R	#56	15 A
Headlamp LO (RH)	IPDM E/R	#57	15 A
Front fog lamp	IPDM E/R	#58	15 A
<ul style="list-style-type: none">• Parking lamp• Front side marker lamp	IPDM E/R	#52	10 A
<ul style="list-style-type: none">• Tail lamp• Rear side marker lamp• License plate lamp• Each illumination	IPDM E/R	#53	10 A
Stop lamp	FUSE BLOCK (J/B)	#7	10 A
Back-up lamp	FUSE BLOCK (J/B)	#4	10 A

Is the fuse fusing?

- YES >> Repair the applicable circuit. And then replace the fuse.
NO >> The fuse is normal.

HEADLAMP (HI) CIRCUIT

< COMPONENT DIAGNOSIS >

[XENON TYPE]

HEADLAMP (HI) CIRCUIT

Component Function Check

INFOID:000000003534172

1. CHECK HEADLAMP (HI) OPERATION

IPDM E/R AUTO ACTIVE TEST

1. Activate IPDM E/R auto active test. Refer to [PCS-11, "Diagnosis Description"](#).
2. Check that the headlamp switches to the high beam.

CONSULT-III ACTIVE TEST

1. Select "EXTERNAL LAMP" of IPDM E/R active test item.
2. With operating the test items, check that the headlamp (HI) is turned ON.

Hi : Headlamp (HI) ON

Off : Headlamp (HI) OFF

NOTE:

ON/OFF is repeated 1 second each.

Is the headlamp (HI) turned ON?

YES >> Headlamp (HI) circuit is normal.

NO >> Refer to [EXL-67, "Diagnosis Procedure"](#).

Diagnosis Procedure

INFOID:000000003534173

1. CHECK HEADLAMP (HI) OUTPUT VOLTAGE

CONSULT-III ACTIVE TEST

1. Turn the ignition switch OFF.
2. Disconnect the front combination lamp connector.
3. Turn the ignition switch ON.
4. Select "EXTERNAL LAMP" of IPDM E/R active test item.
5. With operating the test items, check the voltage between the IPDM E/R harness connector and the ground.

Terminals			Condition	Voltage (Approx.)
(+)	(-)			
IPDM E/R			External lamp	Battery voltage
Connector	Terminal			
RH	E8	89	Hi	Battery voltage
				Off
LH		90	Hi	Battery voltage
			Off	0 V

Is the measurement value normal?

YES >> GO TO 2.

NO >> GO TO 3.

2. CHECK HEADLAMP (HI) OPEN CIRCUIT

1. Turn the ignition switch OFF.
2. Disconnect IPDM E/R connector.
3. Check continuity between the IPDM E/R harness connector and the front combination lamp harness connector.

HEADLAMP (HI) CIRCUIT

[XENON TYPE]

< COMPONENT DIAGNOSIS >

IPDM E/R		Front combination lamp		Continuity
Connector	Terminal	Connector	Terminal	
RH	E8	E28	7	Existed
LH		90	E58	

Does continuity exist?

YES >> GO TO 5.

NO >> Repair the harnesses or connectors.

3. CHECK HEADLAMP (HI) FUSE

1. Turn the ignition switch OFF.
2. Check that the following fuses are not fusing.

Unit	Location	Fuse No.	Capacity
Headlamp HI (RH)	IPDM E/R	#55	10 A
Headlamp HI (LH)	IPDM E/R	#54	10 A

Is the fuse fusing?

YES >> GO TO 4.

NO >> Replace IPDM E/R.

4. CHECK HEAD LAMP (HI) SHORT CIRCUIT

1. Disconnect IPDM E/R connector.
2. Check continuity between the IPDM E/R harness connector terminal and the ground.

IPDM E/R		Ground	Continuity
Connector	Terminal		
RH	E8		Not existed
LH			

Does continuity exist?

YES >> Repair the harnesses or connectors. And then replace the fuse.

NO >> Replace the fuse. (Replace IPDM E/R if the fuse is fusing again.)

5. CHECK HEAD LAMP (HI) GROUND OPEN CIRCUIT

1. Turn the ignition switch OFF.
2. Disconnect the front combination lamp connector.
3. Check continuity between the front combination lamp harness connector and the ground.

Front combination lamp		Ground	Continuity
Connector	Terminal		
RH	E28		Existed
LH	E58		

Does continuity exist?

YES >> Replace the headlamp (HI) bulb. (Bulb socket is abnormally.)

NO >> Repair the harnesses or connectors.

HEADLAMP (LO) CIRCUIT

< COMPONENT DIAGNOSIS >

[XENON TYPE]

HEADLAMP (LO) CIRCUIT

Description

INFOID:000000003534174

Headlamp (LO) circuit is connected to HID control unit integrated in the headlamp. Headlamp (LO) circuit turns xenon headlamp ON.

For the details of HID control unit and the xenon headlamp, refer to [EXL-71, "Description"](#).

Component Function Check

INFOID:000000003534175

1. CHECK HEADLAMP (LO) OPERATION

IPDM E/R AUTO ACTIVE TEST

1. Activate IPDM E/R auto active test. Refer to [PCS-11, "Diagnosis Description"](#).
2. Check that the headlamp is turned ON.

CONSULT-III ACTIVE TEST

1. Select "EXTERNAL LAMP" of IPDM E/R active test item.
2. With operating the test items, check that the headlamp (LO) is turned ON.

Lo : Headlamp (LO) ON

Off : Headlamp (LO) OFF

Is the headlamp (LO) turned ON?

YES >> Headlamp (LO) is normal.

NO >> Refer to [EXL-69, "Diagnosis Procedure"](#).

Diagnosis Procedure

INFOID:000000003534176

1. CHECK HEADLAMP (LO) OUTPUT VOLTAGE

CONSULT-III ACTIVE TEST

1. Turn the ignition switch OFF.
2. Disconnect the front combination lamp connector.
3. Turn the ignition switch ON.
4. Select "EXTERNAL LAMP" of IPDM E/R active test item.
5. With operating the test items, check the voltage between the IPDM E/R harness connector and the ground.

Terminals			Test item	Voltage (Approx.)
(+)	(-)			
IPDM E/R			EXTERNAL LAMP	Battery voltage
Connector	Terminal			
RH	E8	83	Lo	Battery voltage
		84	Off	0 V
LH			Lo	Battery voltage
			Off	0 V

Is the measurement value normal?

YES >> GO TO 2.

NO >> GO TO 3.

2. CHECK HEADLAMP (LO) OPEN CIRCUIT

1. Turn the ignition switch OFF.
2. Disconnect IPDM E/R connector.
3. Check continuity between the IPDM E/R harness connector and the front combination lamp harness connector.

HEADLAMP (LO) CIRCUIT

[XENON TYPE]

< COMPONENT DIAGNOSIS >

IPDM E/R		Front combination lamp		Continuity
Connector	Terminal	Connector	Terminal	
RH	E8	E28	5	Existed
LH		E58	5	

Does continuity exist?

YES >> GO TO 5.

NO >> Repair the harnesses or connectors.

3. CHECK HEADLAMP (LO) FUSE

1. Turn the ignition switch OFF.
2. Check that the following fuses are not fusing.

Unit	Lotion	Fuse No.	Capacity
Headlamp LO (RH)	IPDM E/R	#57	15 A
Headlamp LO (LH)	IPDM E/R	#56	15 A

Is the fuse fusing?

YES >> GO TO 4.

NO >> Replace IPDM E/R.

4. CHECK HEADLAMP (LO) SHORT CIRCUIT

1. Disconnect IPDM E/R connector.
2. Check continuity between the IPDM E/R harness connector and the ground.

IPDM E/R		Ground	Continuity
Connector	Terminal		
RH	E8	83	Not existed
LH		84	

Does continuity exist?

YES >> Repair the harnesses or connectors. And then replace the fuse.

NO >> Replace the fuse. (Replace IPDM E/R if the fuse is fusing again.)

5. CHECK HEADLAMP (LO) GROUND OPEN CIRCUIT

1. Turn the ignition switch OFF.
2. Disconnect the front combination lamp connector.
3. Check continuity between the front combination lamp harness connector and the ground.

Front combination lamp		Ground	Continuity
Connector	Terminal		
RH	E28	3	Existed
LH	E58	3	

Does continuity exist?

YES >> Perform the xenon headlamp diagnosis. Refer to [EXL-71. "Diagnosis Procedure"](#).

NO >> Repair the harnesses or connectors.

XENON HEADLAMP

< COMPONENT DIAGNOSIS >

[XENON TYPE]

XENON HEADLAMP

Description

INFOID:000000003135335

OUTLINE

- The lamp light source is by the arch discharge by applying high voltage into the xenon gas-filled bulb instead of the halogen bulb filament.
- Sight becomes more natural and brighter because the amount of light are gained adequately and the color of light is sunshine-like white.
- The xenon bulb drops the amount of light, repeats blinking, and illuminates in red if the bulb reaches the service life.

ILLUMINATION PRINCIPLE

1. Discharging starts in high voltage pulse between bulb electrodes.
2. Xenon gas is activated by current between electrodes. Pale light is emitted.
3. The luminous tube (bulb) temperature elevates. Evaporated halide is activated by discharge. The color of light changes into white.

NOTE:

- Brightness and the color of light may change slightly immediately after the headlamp turned ON until the xenon bulb becomes stable. This is not malfunction.
- Illumination time lag may occur between right and left. This is not malfunction.

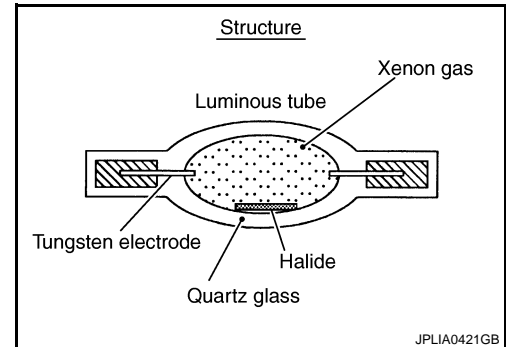

PRECAUTIONS FOR TROUBLE DIAGNOSIS

Representative malfunction examples are; "Light does not turn ON", "Light blinks", and "Brightness is inadequate." The cause often be the xenon bulb. Such malfunctions, however, are occurred occasionally by HID control unit malfunction or lamp case malfunction. Specify the malfunctioning part with diagnosis procedure.

WARNING:

- **Never touch the harness, HID control unit, the inside and metal part of lamp when turning the headlamp ON or operating the light switch.**
- **Never work with wet hands.**

CAUTION:

- **Never perform HID control unit circuit diagnosis with a circuit tester or an equivalent.**
- **Temporarily install the headlamp on the vehicle. Connect the battery to the connector (vehicle side) when checking ON/OFF status.**
- **Disconnect the battery negative terminal before disconnecting the lamp socket connector or the harness connector.**
- **Check for fusing of the fusible link(s), open around connector, short, disconnection if the symptom is caused by electric error.**

NOTE:

- Turn the switch OFF once before turning ON, if the ON/OFF is inoperative.
- The xenon bulb drops the amount of light, repeats blinking, and illuminates in red if the bulb reaches the service life.

Diagnosis Procedure

INFOID:000000003135336

1.CHECK XENON BULB

Install the normal bulb to the applicable headlamp. Check that the xenon bulb is turned ON.

Is the headlamp turned ON?

- YES >> Replace the xenon bulb.
- NO >> GO TO 2.

2.CHECK HID CONTROL UNIT

Install the normal HID control unit to the applicable headlamp. Check that the lamp is turned ON.

Is the headlamp turned ON?

XENON HEADLAMP

[XENON TYPE]

< COMPONENT DIAGNOSIS >

- YES >> Replace HID control unit.
- NO >> GO TO 3.

3.CHECK XENON HEADLAMP HOUSING ASSEMBLY

Install the normal xenon headlamp housing assembly to the applicable headlamp. Check that the xenon headlamp is turned ON.

Is the headlamp turned ON?

- YES >> Replace the front combination lamp. (Xenon headlamp housing voltage converter malfunctions.)
- NO >> Xenon headlamp is normal. check the headlamp control system.

HEADLAMP LEVELIZER CIRCUIT

< COMPONENT DIAGNOSIS >

[XENON TYPE]

HEADLAMP LEVELIZER CIRCUIT

Description

INFOID:000000003135337

The headlamp levelizer adjusts the headlamp light axis upward and downward with the aiming motor integrated in the front combination lamp.

Component Function Check

INFOID:000000003135338

1.CHECK AIMING MOTOR OPERATION

CONSULT-III ACTIVE TEST

1. Start the engine.
2. Turn the lighting switch 2ND.
3. Select "LEVELIZER TEST" of ADAPTIVE LIGHT active test item.
4. With operating the test item, check the operation.

Test item	Light axis angle (Reference value)	10 m (32.8 ft)-forward light axis change refer- ence quantity (Approx.)
LEVELIZER TEST		
Origin	0°	—
Peak	2.5°	450 mm (17.9 in)

Is the operation normal?

- YES >> Headlamp levelizer circuit is normal.
NO >> Refer to [EXL-73, "Diagnosis Procedure"](#).

Diagnosis Procedure

INFOID:000000003135339

1.CHECK AIMING MOTOR DRIVE SIGNAL OUTPUT

CONSULT-III ACTIVE TEST

1. Start the engine.
2. Turn the light switch 2ND.
3. Select "LEVELIZER TEST" of ADAPTIVE LIGHT active test item.
4. With operating the test item, check the voltage between the AFS control unit harness connector and the ground.

Terminals			Test item	Voltage (Approx.)
(+)	(-)			
AFS control unit			LEVELIZER TEST	
Connector	Terminal			
RH	M16	19	Origin	8.8 V
			Peak	1.9 V
LH	M16	40	Origin	8.8 V
			Peak	1.9 V

Is the measurement value normal?

- YES >> GO TO 2.
NO >> GO TO 3.

2.CHECK AIMING MOTOR DRIVE SIGNAL CIRCUIT INPUT

1. Turn the ignition switch OFF.
2. Disconnect AFS control unit connector and aiming motor connector.
3. Check continuity between AFS control unit harness connector and the aiming motor harness connector.

HEADLAMP LEVELIZER CIRCUIT

[XENON TYPE]

< COMPONENT DIAGNOSIS >

AFS control unit		Aiming motor		Continuity
Connector	Terminal	Connector	Terminal	
RH	M16	E26	1	Existed
LH		40	E56	

Does continuity exist?

- YES >> Replace the front combination lamp.
NO >> Repair the harnesses and connectors.

3. CHECK AIMING MOTOR DRIVE SIGNAL SHORT CIRCUIT

1. Turn the ignition switch OFF.
2. Disconnect AFS control unit connector and aiming motor connector.
3. Check continuity between AFS control unit harness connector and ground.

AFS control unit		Ground	Continuity
Connector	Terminal		
RH	M16	19	Not existed
LH		40	

Does continuity exist?

- YES >> Repair the harness and connectors.
NO >> Replace AFS control unit.

FRONT FOG LAMP CIRCUIT

< COMPONENT DIAGNOSIS >

[XENON TYPE]

FRONT FOG LAMP CIRCUIT

Component Function Check

INFOID:000000003135340

1. CHECK FRONT FOG LAMP OPERATION

IPDM E/R AUTO ACTIVE TEST

1. Activate IPDM E/R auto active test. Refer to [PCS-11, "Diagnosis Description"](#).
2. Check that the front fog lamp is turned ON.

CONSULT-III ACTIVE TEST

1. Select "EXTERNAL LAMPS" of IPDM E/R active test item.
2. With operating the test items, Check that the front fog lamp is turned ON.

Fog : Front fog lamp ON
Off : Front fog lamp OFF

Is the front fog lamp turned ON?

- YES >> Front fog lamp circuit is normal.
NO >> Refer to [EXL-75, "Diagnosis Procedure"](#).

Diagnosis Procedure

INFOID:000000003135341

1. CHECK FRONT FOG LAMP FUSE

1. Turn the ignition switch OFF.
2. Check that the following fuses are not fusing.

Unit	Location	Fuse No.	Capacity
Front fog lamp	IPDM E/R	#58	15 A

Is the fuse fusing?

- YES >> GO TO 2.
NO >> GO TO 3.

2. CHECK FRONT FOG LAMP SHORT CIRCUIT

1. Disconnect IPDM E/R connector and the front fog lamp connector.
2. Check continuity between the IPDM E/R harness connector and the ground.

IPDM E/R		Ground	Continuity
Connector	Terminal		
RH	E8	86	Not existed
LH		87	

Does continuity exist?

- YES >> Repair the harnesses or connectors. And then replace the fuse.
NO >> Replace the fuse. (Replace IPDM E/R if the fuse is fusing again.)

3. CHECK FRONT FOG LAMP BULB

Check the applicable lamp bulb.

Is the bulb normal?

- YES >> GO TO 4.
NO >> Replace the bulb.

4. CHECK FRONT FOG LAMP OUTPUT VOLTAGE

CONSULT-III ACTIVE TEST

1. Disconnect the front fog lamp connector.
2. Turn the ignition switch ON.
3. Select "EXTERNAL LAMPS" of IPDM E/R active test item.

FRONT FOG LAMP CIRCUIT

[XENON TYPE]

< COMPONENT DIAGNOSIS >

4. With operating the test items, check the voltage between the IPDM E/R harness connector and the ground.

Terminals			Test item	Voltage (Approx.)
(+)		(-)		
IPDM E/R			EXTERNAL LAMP	Battery voltage
Connector	Terminal			
RH	E8	86	Ground	Fog
				Off
LH		87	Fog	
			Off	

Is the measurement value normal?

YES >> GO TO 5.

NO >> Replace IPDM E/R.

5. CHECK FRONT FOG LAMP OPEN CIRCUIT

1. Turn the ignition switch OFF.
2. Disconnect IPDM E/R connector.
3. Check continuity between the IPDM E/R harness connector and the front fog lamp harness connector.

IPDM E/R			Front fog lamp		Continuity
Connector	Terminal		Connector	Terminal	
RH	E8	86	E34	1	Existed
LH		87	E64	1	

Does continuity exist?

YES >> GO TO 6.

NO >> Repair the harnesses or connectors.

6. CHECK FRONT FOG LAMP GROUND CIRCUIT OPEN CIRCUIT

Check continuity between the front fog lamp harness connector and the ground.

Front fog lamp			Ground	Continuity
Connector	Terminal			
RH	E34	2	Ground	Existed
LH	E64	2		

Does continuity exist?

YES >> Replace the front fog lamp.

NO >> Repair the harnesses or connectors.

PARKING LAMP CIRCUIT

< COMPONENT DIAGNOSIS >

[XENON TYPE]

PARKING LAMP CIRCUIT

Component Function Check

INFOID:000000003135342

1. CHECK PARKING LAMP OPERATION

IPDM E/R AUTO ACTIVE TEST

1. Activate IPDM E/R auto active test. Refer to [PCS-11, "Diagnosis Description"](#).
2. Check that the parking lamp is turned ON.

CONSULT-III ACTIVE TEST

1. Select "EXTERNAL LAMPS" of IPDM E/R active test item.
2. With operating the test items, check that the parking lamp is turned ON.

TAIL : Parking lamp ON
Off : Parking lamp OFF

Is the parking lamp turned ON?

- YES >> Parking lamp circuit is normal.
NO >> Refer to [EXL-77, "Diagnosis Procedure"](#).

Diagnosis Procedure

INFOID:000000003135343

1. CHECK PARKING LAMP FUSE

1. Turn the ignition switch OFF.
2. Check that the following fuses are not fusing.

Unit	Location	Fuse No.	Capacity
Parking lamp	IPDM E/R	#52	10 A

Is the fuse fusing?

- YES >> GO TO 2.
NO >> GO TO 3.

2. CHECK PARKING LAMP SHORT CIRCUIT

1. Disconnect IPDM E/R connector and the front combination lamp connector.
2. Check continuity between the IPDM E/R harness connector and the ground.

IPDM E/R		Ground	Continuity
Connector	Terminal		
RH	E9	91	Not existed
LH		92	

Does continuity exist?

- YES >> Repair the harnesses or connectors. And then replace the fuse.
NO >> Replace the fuse. (Replace IPDM E/R if fusing is found again.)

3. CHECK PARKING LAMP BULB

Check the applicable lamp bulb.

Is the bulb normal?

- YES >> GO TO 4.
NO >> Replace the bulb.

4. CHECK PARKING LAMP OUTPUT VOLTAGE

CONSULT-III ACTIVE TEST

1. Disconnect the front combination lamp connector.
2. Turn the ignition switch ON.
3. Select "EXTERNAL LAMPS" of IPDM E/R active test item.

PARKING LAMP CIRCUIT

[XENON TYPE]

< COMPONENT DIAGNOSIS >

4. With operating the test items, check the voltage between the IPDM E/R harness connector and the ground.

Terminals			Test item	Voltage (Approx.)
(+)		(-)		
IPDM E/R			EXTERNAL LAMP	Battery voltage
Connector	Terminal			
RH	E9	91	TAIL	0 V
LH		92	TAIL	Battery voltage
			Off	0 V

Is the measurement value normal?

YES >> GO TO 5.

NO >> Replace IPDM E/R.

5. CHECK PARKING LAMP OPEN CIRCUIT

1. Turn the ignition switch OFF.
2. Disconnect IPDM E/R connector.
3. Check continuity between the IPDM E/R harness connector and the front combination lamp harness connector.

IPDM E/R		Front combination lamp		Continuity
Connector	Terminal	Connector	Terminal	
RH	E9	E28	8	Existed
LH		92	E58	

Does continuity exist?

YES >> GO TO 6.

NO >> Repair the harnesses or connectors.

6. CHECK PARKING LAMP GROUND OPEN CIRCUIT

Check continuity between the front combination lamp harness connector and the ground.

Front combination lamp			Ground	Continuity
Connector	Terminal			
RH	E28	4	Ground	Existed
LH	E58	4		

Does continuity exist?

YES >> Replace the front combination lamp.

NO >> Repair the harnesses or connectors.

TURN SIGNAL LAMP CIRCUIT

< COMPONENT DIAGNOSIS >

[XENON TYPE]

TURN SIGNAL LAMP CIRCUIT

Description

INFOID:000000003135344

BCM performs the high flasher operation (fail-safe) if any bulb or harness of the turn signal lamp circuit is open.

NOTE:

Turn signal lamp blinks at normal speed when using the hazard warning lamp.

Component Function Check

INFOID:000000003135345

1. CHECK TURN SIGNAL LAMP

Ⓜ CONSULT-III ACTIVE TEST

1. Select "FLASHER" of BCM (FLASHER) active test item.
2. With operating the test items, check that the turn signal lamp blinks.

- LH** : Turn signal lamp LH blinking
- RH** : Turn signal lamp RH blinking
- Off** : The turn signal lamp OFF

Does the turn signal lamp blink?

- YES >> Turn signal lamp circuit is normal.
- NO >> Refer to [EXL-79. "Diagnosis Procedure"](#).

Diagnosis Procedure

INFOID:000000003135346

1. CHECK TURN SIGNAL LAMP BULB

Check the applicable lamp bulb.

Is the bulb normal?

- YES >> GO TO 2.
- NO >> Replace the bulb.

2. CHECK TURN SIGNAL LAMP OUTPUT VOLTAGE

Ⓜ CONSULT-III ACTIVE TEST

1. Turn the ignition switch OFF.
2. Disconnect the front combination lamp connector or the rear combination lamp connector.
3. Turn the ignition switch ON.
4. Select "FLASHER" of BCM (FLASHER) active test item.
5. With operating the turn signal switch, check the voltage between the BCM harness connector and the ground.

EXL

Terminals			Test item	Voltage (Approx.)
(+)	(-)			
BCM			FLASHER	<p style="text-align: right;">PKID0926E</p>
Connector	Terminal			
Front RH	M119	17	LH or RH	
Front LH		18		
Rear RH	M120	20	Off	0 V
Rear LH		25		

Is the measurement value normal?

TURN SIGNAL LAMP CIRCUIT

[XENON TYPE]

< COMPONENT DIAGNOSIS >

- YES >> GO TO 3.
NO >> Replace BCM.

3. CHECK TURN SIGNAL LAMP OPEN CIRCUIT

1. Turn the ignition switch OFF.
2. Disconnect BCM connector.
3. Check the continuity between the BCM harness connector and the front combination lamp or the rear combination lamp harness connector.

BCM		Front combination lamp/ Rear combination lamp		Continuity
Connector	Terminal	Connector	Terminal	
Front RH	M119	E28	17	Existed
Front LH			18	
Rear RH	M120	B261	20	
Rear LH			25	

Does continuity exist?

- YES >> GO TO 4.
NO >> Repair the harnesses or connectors.

4. CHECK TURN SIGNAL LAMP SHORT CIRCUIT

Check continuity between the BCM harness connector and the ground.

BCM		Ground	Continuity
Connector	Terminal		
Front RH	M119	17	Not existed
Front LH		18	
Rear RH	M120	20	
Rear LH		25	

Does continuity exist?

- YES >> Repair the harnesses or connectors.
NO >> GO TO 5.

5. CHECK TURN SIGNAL LAMP GROUND OPEN CIRCUIT

Check the continuity between the BCM harness connector and the front combination lamp or the rear combination lamp and the ground.

Front combination lamp / Rear combination lamp		Ground	Continuity
Connector	Terminal		
Front RH	E28	4	Existed
Front LH	E58	4	
Rear RH	B261	2	
Rear LH	B260	2	

Does continuity exist?

- YES >> Replace the front combination lamp or the rear combination lamp.
NO >> Repair the harnesses or connectors.

OPTICAL SENSOR

< COMPONENT DIAGNOSIS >

[XENON TYPE]

OPTICAL SENSOR

Description

INFOID:000000003135347

Optical sensor converts the outside brightness (lux) to voltage and transmits the optical sensor signal to BCM.

Component Function Check

INFOID:000000003135348

1.CHECK OPTICAL SENSOR SIGNAL BY CONSULT-III

CONSULT-III DATA MONITOR

1. Turn the ignition switch ON.
2. Select "OPTICAL SENSOR" of BCM (HEADLAMP) data monitor item.
3. Turn the lighting switch AUTO.
4. With the optical sensor illuminating, check the monitor status.

Monitor item	Condition		Voltage (Approx.)
OPTICAL SENSOR	Optical sensor	When illuminating	3.1 V or more *
		When shutting off light	0.6 V or less

*: Illuminates the optical sensor. The value may be less than the standard value if brightness is weak.

Is the item status normal?

- YES >> Optical sensor is normal.
 NO >> Refer to [EXL-81, "Diagnosis Procedure"](#).

Diagnosis Procedure

INFOID:000000003135349

1.CHECK OPTICAL SENSOR POWER SUPPLY INPUT

1. Turn the ignition switch ON.
2. Turn the lighting switch AUTO.
3. Check the voltage between the optical sensor harness connector and the ground.

Terminals		Voltage (Approx.)
(+)	(-)	
Optical sensor		Ground
Connector	Terminal	
M94	1	

Is the measurement value normal?

- YES >> GO TO 2.
 NO >> GO TO 4.

2.CHECK OPTICAL SENSOR GROUND INPUT

Check the voltage between the optical sensor harness connector and the ground.

Terminals		Voltage (Approx.)
(+)	(-)	
Optical sensor		Ground
Connector	Terminal	
M94	3	

Is the measurement value normal?

- YES >> GO TO 3.
 NO >> GO TO 6.

OPTICAL SENSOR

[XENON TYPE]

< COMPONENT DIAGNOSIS >

3. CHECK OPTICAL SENSOR SIGNAL OUTPUT

With illuminating the optical sensor, check the voltage between the optical sensor harness connector and the ground.

Terminals		Condition	Voltage (Approx.)
(+)	(-)		
Optical sensor		Optical sensor	
Connector	Terminal		
M94	2	Ground	
		When illuminating	3.1 V or more *
		When shutting off light	0.6 V or less

*: Illuminate the optical sensor. The value may be less than the standard if brightness is weak.

Is the measurement value normal?

YES >> GO TO 7.

NO >> Replace the optical sensor.

4. CHECK OPTICAL SENSOR OPEN CIRCUIT

1. Turn the ignition switch OFF.
2. Disconnect the optical sensor connector and BCM connector.
3. Check continuity between the optical sensor harness connector and the BCM harness connector.

Optical sensor		BCM		Continuity
Connector	Terminal	Connector	Terminal	
M94	1	M123	138	Existed

Does continuity exist?

YES >> GO TO 5.

NO >> Repair the harnesses or connectors.

5. CHECK OPTICAL SENSOR SHORT CIRCUIT

Check the continuity between the optical sensor harness connector and the ground.

Optical sensor		Ground	Continuity
Connector	Terminal		
M94	1		Not existed

Does continuity exist?

YES >> Repair the harnesses or connectors.

NO >> Replace BCM.

6. CHECK OPTICAL SENSOR GROUND OPEN CIRCUIT

1. Turn the ignition switch OFF.
2. Disconnect the optical sensor connector and BCM connector.
3. Check continuity between the optical sensor harness connector and the BCM harness connector.

Optical sensor		BCM		Continuity
Connector	Terminal	Connector	Terminal	
M94	3	M123	137	Existed

Does continuity exist?

YES >> Replace BCM.

NO >> Repair the harnesses or connectors.

7. CHECK OPTICAL SENSOR SIGNAL OPEN CIRCUIT

OPTICAL SENSOR

[XENON TYPE]

< COMPONENT DIAGNOSIS >

1. Turn the ignition switch OFF.
2. Disconnect the optical sensor connector and BCM connector.
3. Check continuity between the optical sensor harness connector and the BCM harness connector.

Optical sensor		BCM		Continuity
Connector	Terminal	Connector	Terminal	
M94	2	M123	113	Existed

Does continuity exist?

YES >> GO TO 8.

NO >> Repair the harnesses or connectors.

8.CHECK OPTICAL SENSOR SHORT CIRCUIT

Check the continuity between the optical sensor harness connector and the ground.

Optical sensor		Ground	Continuity
Connector	Terminal		
M94	2		Not existed

Does continuity exist?

YES >> Repair the harnesses or connectors.

NO >> Replace BCM.

A
B
C
D
E
F
G
H
I
J
K
EXL
M
N
O
P

HAZARD SWITCH

< COMPONENT DIAGNOSIS >

[XENON TYPE]

HAZARD SWITCH

Description

INFOID:000000003135350

Hazard switch is integrated in the multifunction switch. Hazard switch inputs the signals to BCM when pressing the switch.

Component Function Check

INFOID:000000003135351

1.CHECK HAZARD SWITCH SIGNAL BY CONSULT-III

CONSULT-III DATA MONITOR

1. Turn the ignition switch ON.
2. Select "HAZARD SW" of BCM (FLASHER) data monitor item.
3. With operating the hazard switch, check the monitor status.

Monitor item	Condition		Monitor status
HAZARD SW	Hazard switch	While pressing the switch	On
		While not pressing the switch	Off

Is the item status normal?

- YES >> Hazard switch circuit is normal.
 NO >> Refer to [EXL-84, "Diagnosis Procedure"](#).

Diagnosis Procedure

INFOID:000000003135352

1.CHECK HAZARD SWITCH SIGNAL INPUT

With operating the hazard switch, check the voltage between the BCM harness connector and the ground.

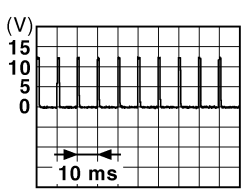
Terminals		Condition	Voltage (Approx.)
(+)	(-)		
BCM		Hazard switch	0 V
Connector	Terminal		
M122	110	While pressing the switch	
		Ground	

JPMIA0012GB

Is the measurement value normal?

- YES >> Replace BCM.
 NO >> GO TO 2.

2.CHECK HAZARD SWITCH SIGNAL OPEN CIRCUIT

1. Turn the ignition switch OFF.
2. Disconnect the multifunction switch connector and BCM connector.
3. Check continuity between the multifunction switch harness connector and the BCM harness connector.

HAZARD SWITCH

< COMPONENT DIAGNOSIS >

[XENON TYPE]

Multifunction switch		BCM		Continuity
Connector	Terminal	Connector	Terminal	
M72	16	M122	110	Existed

Does continuity exist?

YES >> GO TO 3.

NO >> Repair the harnesses or connectors.

3.CHECK HAZARD SWITCH SIGNAL SHORT CIRCUIT

Check continuity between the multifunction switch harness connector and the ground.

Multifunction switch		Ground	Continuity
Connector	Terminal		
M72	16		Not existed

Does continuity exist?

YES >> Repair the harnesses or connectors.

NO >> GO TO 4.

4.CHECK HAZARD SWITCH GROUND OPEN CIRCUIT

Check continuity between the multifunction switch harness connector and the ground.

Multifunction switch		Ground	Continuity
Connector	Terminal		
M72	1		Existed

Does continuity exist?

YES >> Replace the hazard switch (multifunction switch).

NO >> Repair the harnesses or connectors.

A
B
C
D
E
F
G
H
I
J
K
EXL
M
N
O
P

TAIL LAMP CIRCUIT

[XENON TYPE]

< COMPONENT DIAGNOSIS >

TAIL LAMP CIRCUIT

Component Function Check

INFOID:000000003135353

1. CHECK TAIL LAMP OPERATION

IPDM E/R AUTO ACTIVE TEST

1. Activate IPDM E/R auto active test. Refer to [PCS-11, "Diagnosis Description"](#).
2. Check that the tail lamp is turned ON.

CONSULT-III ACTIVE TEST

1. Select "EXTERNAL LAMPS" of IPDM E/R active test item.
2. With operating the test items, check that the tail lamp is turned ON.

TAIL : Tail lamp ON

Off : Tail lamp OFF

Is the tail lamp turned ON?

YES >> Tail lamp circuit is normal.

NO >> Refer to [EXL-86, "Diagnosis Procedure"](#).

Diagnosis Procedure

INFOID:000000003135354

1. CHECK TAIL LAMP FUSE

1. Turn the ignition switch OFF.
2. Check that the following fuses are not fusing.

Unit	Location	Fuse No.	Capacity
<ul style="list-style-type: none">• Tail lamp• Rear side marker lamp• License plate lamp	IPDM E/R	#53	10 A

Is the fuse fusing?

YES >> Repair the malfunctioning part before replacing the fuse.

NO >> GO TO 2.

2. CHECK TAIL LAMP OUTPUT VOLTAGE

CONSULT-III ACTIVE TEST

1. Disconnect the rear combination lamp connector.
2. Turn the ignition switch ON.
3. Select "EXTERNAL LAMPS" of IPDM E/R active test item.
4. With operating the test items, check the voltage between the IPDM E/R harness connector and the ground.

Terminals		Test item	Voltage (Approx.)
(+)	(-)		
IPDM E/R		EXTERNAL LAMP	Battery voltage
Connector	Terminal		
E5	7	TAIL	0 V
		Off	0 V

Is the measurement value normal?

YES >> GO TO 3.

NO >> Replace IPDM E/R.

3. CHECK TAIL LAMP OPEN CIRCUIT

1. Turn the ignition switch OFF.
2. Disconnect IPDM E/R connector.

TAIL LAMP CIRCUIT

[XENON TYPE]

< COMPONENT DIAGNOSIS >

3. Check continuity between the IPDM E/R harness connector and the rear combination lamp harness connector.

IPDM E/R		Rear combination lamp		Continuity	
Connector	Terminal	Connector	Terminal		
RH	E5	7	B232	1	Existed
LH			B60	1	

Does continuity exist?

YES >> GO TO 4.

NO >> Repair the harnesses or connectors.

4. CHECK TAIL LAMP GROUND OPEN CIRCUIT

Check continuity between the rear combination lamp harness connector and the ground.

Rear combination lamp			Ground	Continuity
Connector	Terminal			
RH	B232	4		Existed
LH	B60	4		

Does continuity exist?

YES >> Replace the rear combination lamp.

NO >> Repair the harnesses or connectors.

A
B
C
D
E
F
G
H
I
J
K
M
N
O
P

EXL

LICENSE PLATE LAMP CIRCUIT

[XENON TYPE]

< COMPONENT DIAGNOSIS >

LICENSE PLATE LAMP CIRCUIT

Component Function Check

INFOID:000000003135355

NOTE:

Check the tail lamp circuit if the tail lamp and the license plate lamp are not turned ON.

1.CHECK LICENSE PLATE LAMP OPERATION

⊗IPDM E/R AUTO ACTIVE TEST

1. Activate IPDM E/R auto active test. Refer to [PCS-11, "Diagnosis Description"](#).
2. Check that the license plate lamp is turned ON.

ⓅCONSULT-III ACTIVE TEST

1. Select "EXTERNAL LAMPS" of IPDM E/R active test item.
2. With operating the lighting switch, check that the license plate lamp is turned ON.

TAIL : License plate lamp ON

Off : License plate lamp OFF

Is the license plate lamp turned ON?

- YES >> License plate lamp circuit is normal.
NO >> Refer to [EXL-88, "Diagnosis Procedure"](#).

Diagnosis Procedure

INFOID:000000003135356

1.CHECK LICENSE PLATE LAMP BULB

Check the applicable lamp bulb.

Is the bulb normal?

- YES >> GO TO 2.
NO >> Replace the bulb.

2.CHECK LICENSE PLATE LAMP OPEN CIRCUIT

1. Turn the ignition switch OFF.
2. Disconnect IPDM E/R connector and the license plate lamp connector.
3. Check continuity between the IPDM E/R harness connector and the license plate lamp harness connector.

IPDM E/R		License plate lamp		Continuity
Connector	Terminal	Connector	Terminal	
RH	E5	D117	1	Existed
LH		D112	1	

Does continuity exist?

- YES >> GO TO 3.
NO >> Repair the harnesses or connectors.

3.CHECK LICENSE PLATE LAMP GROUND OPEN CIRCUIT

Check continuity between the license plate lamp harness connector and the ground.

License plate lamp			Ground	Continuity
Connector	Terminal			
RH	D117	2	Existed	
LH	D112	2		

Does continuity exist?

- YES >> Replace the license plate lamp.
NO >> Repair the harnesses or connectors.

HEADLAMP SYSTEM

< COMPONENT DIAGNOSIS >

[XENON TYPE]

HEADLAMP SYSTEM

Wiring Diagram - HEADLAMP -

INFOID:000000003135357

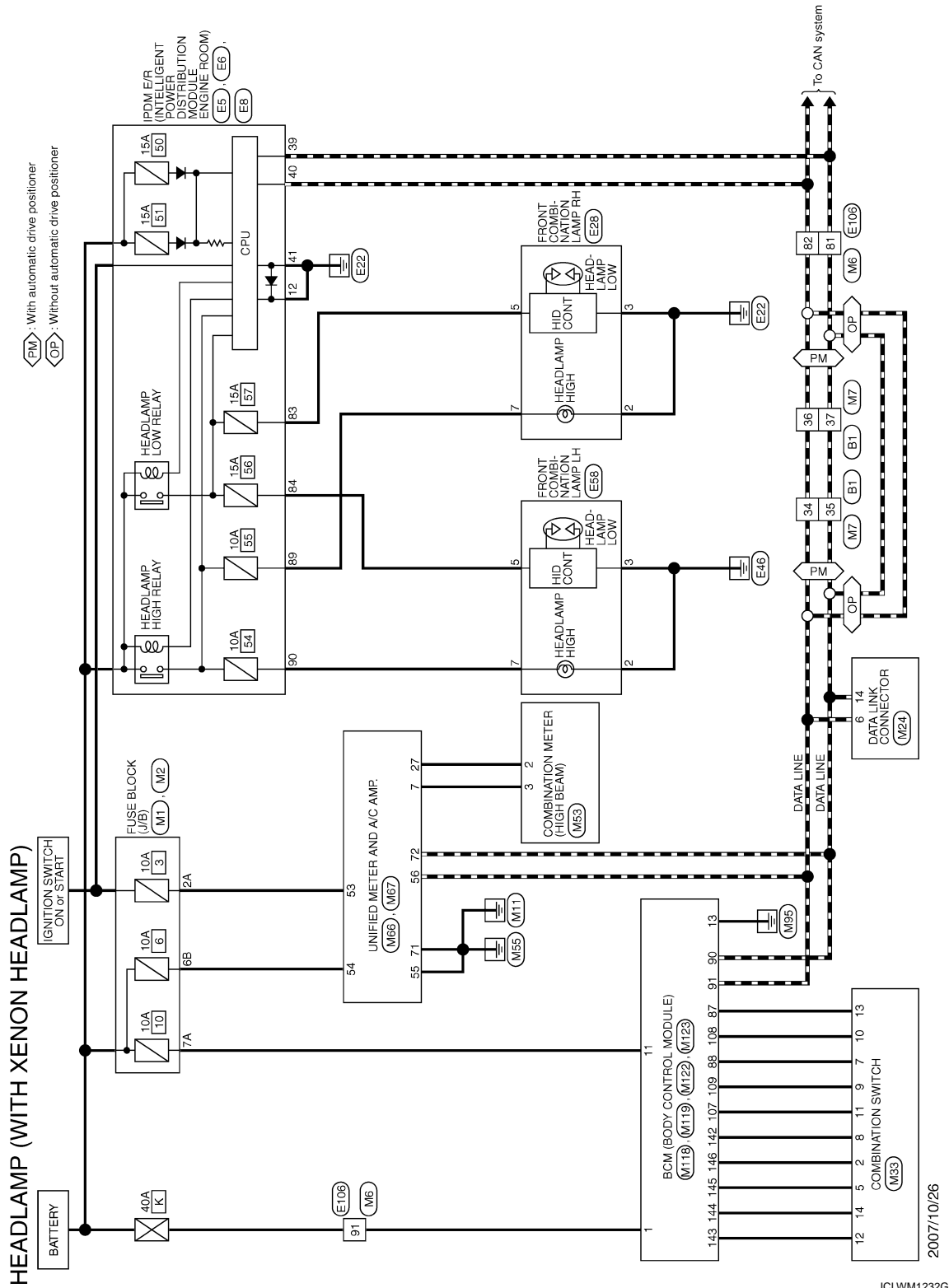

A
B
C
D
E
F
G
H
I
J
K
L
M
N
O
P

EXL

HEADLAMP SYSTEM

< COMPONENT DIAGNOSIS >

[XENON TYPE]

HEADLAMP (WITH XENON HEADLAMP)

Connector No.	E8
Connector Name	IPDM E/R (INTELLIGENT POWER DISTRIBUTION MODULE ENGINE ROOM)
Connector Type	NS30FW-CS

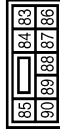

Terminal No.	Color of Wire	Signal Name [Specification]
83	O	-
84	V	-
89	BR	-
80	P	-

Connector No.	E5
Connector Name	IPDM E/R (INTELLIGENT POWER DISTRIBUTION MODULE ENGINE ROOM)
Connector Type	TH80FW-RH



Terminal No.	Color of Wire	Signal Name [Specification]
39	P	-
40	L	-
41	B/W	-

Connector No.	E5
Connector Name	IPDM E/R (INTELLIGENT POWER DISTRIBUTION MODULE ENGINE ROOM)
Connector Type	TH20FW-CS/2-M4-1V

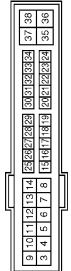

Terminal No.	Color of Wire	Signal Name [Specification]
12	B/W	-

Connector No.	B1
Connector Name	WIRE TO WIRE
Connector Type	TH80FW-CS16-TM4

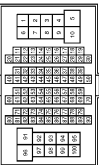

Terminal No.	Color of Wire	Signal Name [Specification]
34	L	-
35	P	-
36	L	-
37	P	-

Connector No.	M1
Connector Name	FUSE BLOCK (J/B)
Connector Type	NS30FW-M2



Terminal No.	Color of Wire	Signal Name [Specification]
2A	G	-
7A	R	-

Connector No.	E106
Connector Name	WIRE TO WIRE
Connector Type	TH80FW-CS16-TM4

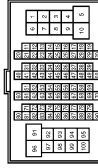

Terminal No.	Color of Wire	Signal Name [Specification]
81	P	-
82	L	-
91	W	-

Connector No.	E58
Connector Name	FRONT COMBINATION LAMP LH
Connector Type	RS08FB-PR



Terminal No.	Color of Wire	Signal Name [Specification]
2	B	-
3	B/Y	-
5	V	-
7	P	-

Connector No.	E28
Connector Name	FRONT COMBINATION LAMP RH
Connector Type	RS08FB-PR



Terminal No.	Color of Wire	Signal Name [Specification]
2	B	-
3	B/Y	-
5	O	-
7	BR	-

JCLWM1233GE

HEADLAMP SYSTEM

< COMPONENT DIAGNOSIS >

[XENON TYPE]

HEADLAMP (WITH XENON HEADLAMP)

Connector No.	M2
Connector Name	FUSE BLOCK (J/B)
Connector Type	HS10FW-CS

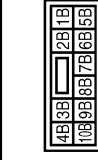

Terminal No.	Color of Wire	Signal Name [Specification]
6B	Y	-

Connector No.	M6
Connector Name	WIRE TO WIRE
Connector Type	TH80MP-CS16-TM4

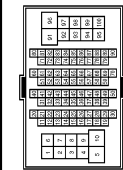

Terminal No.	Color of Wire	Signal Name [Specification]
81	P	-
82	L	-
91	W	-

Connector No.	M7
Connector Name	WIRE TO WIRE
Connector Type	TH80MP-CS16-TM4

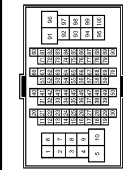

Terminal No.	Color of Wire	Signal Name [Specification]
34	L	-
35	L	-
36	L	-
37	P	-

Connector No.	M24
Connector Name	DATA LINK CONNECTOR
Connector Type	BD16FW

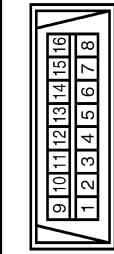

Terminal No.	Color of Wire	Signal Name [Specification]
6	L	-
14	P	-

Connector No.	M33
Connector Name	COMBINATION SWITCH
Connector Type	TH16FW-NH

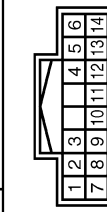

Terminal No.	Color of Wire	Signal Name [Specification]
2	SB	OUTPUT 4
5	L	OUTPUT 3
7	V	INPUT 3
8	O	OUTPUT 5
9	Y	INPUT 2
10	R	INPUT 4
11	LG	INPUT 1
12	P	OUTPUT 1
13	BR	INPUT 5
14	G	OUTPUT 2

Connector No.	M53
Connector Name	COMBINATION METER
Connector Type	TH40FW-NH

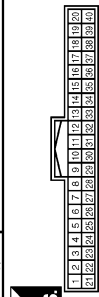

Terminal No.	Color of Wire	Signal Name [Specification]
2	LG	COMM (METER->AMP)
3	GR	COMM (AMP->METER)

Connector No.	M66
Connector Name	UNIFIED METER AND A/C AMP.
Connector Type	TH40FW-NH

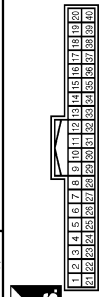

Terminal No.	Color of Wire	Signal Name [Specification]
7	GR	COMM (AMP->METER)
27	LG	COMM (METER->AMP)

Connector No.	M67
Connector Name	UNIFIED METER AND A/C AMP.
Connector Type	TH42FW-NH

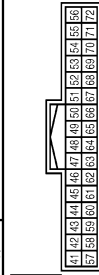

Terminal No.	Color of Wire	Signal Name [Specification]
53	G	IGN
54	Y	BAT
55	B	GND
56	L	CAN-H
71	B	GND
72	P	CAN-L

A
B
C
D
E
F
G
H
I
J
K
EXL
M
N
O
P

HEADLAMP SYSTEM

< COMPONENT DIAGNOSIS >

[XENON TYPE]

HEADLAMP (WITH XENON HEADLAMP)

Connector No.	M118
Connector Name	BCM (BODY CONTROL MODULE)
Connector Type	MD9FB-1C



Terminal No.	Color of Wire	Signal Name [Specification]
1	W	BAT (F/L)

Connector No.	M119
Connector Name	BCM (BODY CONTROL MODULE)
Connector Type	NS16FW-CS



Terminal No.	Color of Wire	Signal Name [Specification]
11	R	BAT (FUSE)
13	B	GND

Connector No.	M122
Connector Name	BCM (BODY CONTROL MODULE)
Connector Type	TH40FB-NH

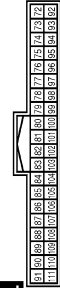

Terminal No.	Color of Wire	Signal Name [Specification]
87	BR	COMBI SW INPUT 5
88	V	COMBI SW INPUT 3
90	P	CAN-L
91	L	CAN-H
107	LG	COMBI SW INPUT 1
108	R	COMBI SW INPUT 4
109	Y	COMBI SW INPUT 2

Connector No.	M123
Connector Name	BCM (BODY CONTROL MODULE)
Connector Type	TH40FG-NH



Terminal No.	Color of Wire	Signal Name [Specification]
142	O	COMBI SW OUTPUT 5
143	P	COMBI SW OUTPUT 1
144	G	COMBI SW OUTPUT 2
145	L	COMBI SW OUTPUT 3
146	SB	COMBI SW OUTPUT 4

JCLWM1235GE

AUTO LIGHT SYSTEM

< COMPONENT DIAGNOSIS >

[XENON TYPE]

AUTO LIGHT SYSTEM

Wiring Diagram - AUTO LIGHT SYSTEM -

INFOID:000000003135358

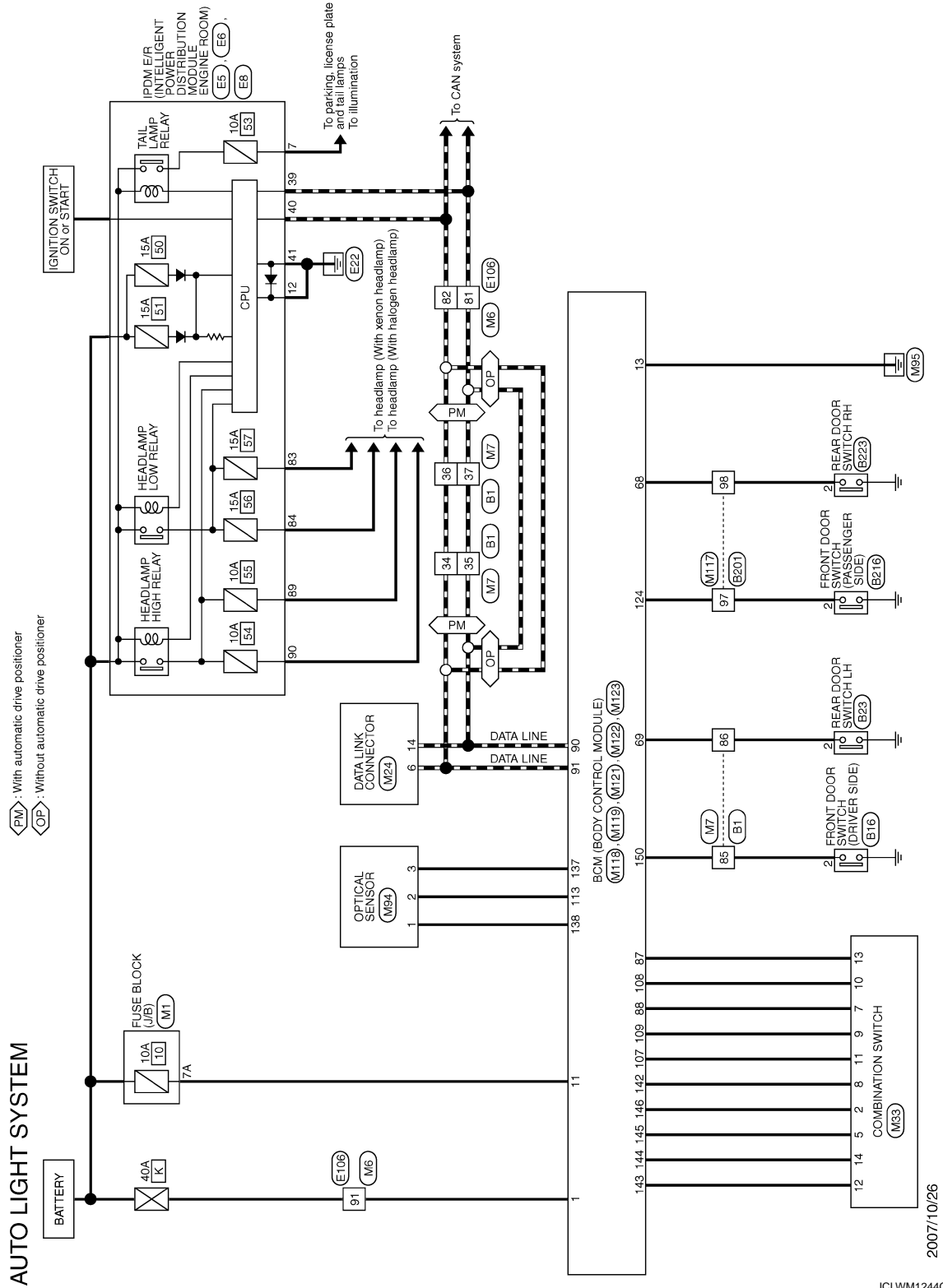











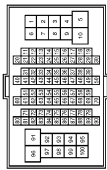

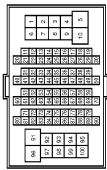

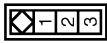

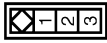
A
B
C
D
E
F
G
H
I
J
K
EXL
M
N
O
P

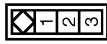
AUTO LIGHT SYSTEM

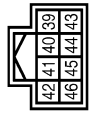
< COMPONENT DIAGNOSIS >

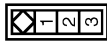
[XENON TYPE]

AUTO LIGHT SYSTEM

<table border="1" style="width: 100%; border-collapse: collapse;"> <tr><td>Connector No.</td><td>B1</td></tr> <tr><td>Connector Name</td><td>WIRE TO WIRE</td></tr> <tr><td>Connector Type</td><td>TH80FW-CS16-TM4</td></tr> </table>  <div style="text-align: center;"></div>	Connector No.	B1	Connector Name	WIRE TO WIRE	Connector Type	TH80FW-CS16-TM4	<table border="1" style="width: 100%; border-collapse: collapse;"> <tr><td>Terminal No.</td><td>Color of Wire</td><td>Signal Name [Specification]</td></tr> <tr><td>34</td><td>L</td><td>-</td></tr> <tr><td>35</td><td>P</td><td>-</td></tr> <tr><td>36</td><td>L</td><td>-</td></tr> <tr><td>37</td><td>P</td><td>-</td></tr> <tr><td>85</td><td>V</td><td>-</td></tr> <tr><td>86</td><td>LG</td><td>-</td></tr> </table>	Terminal No.	Color of Wire	Signal Name [Specification]	34	L	-	35	P	-	36	L	-	37	P	-	85	V	-	86	LG	-	<table border="1" style="width: 100%; border-collapse: collapse;"> <tr><td>Connector No.</td><td>B201</td></tr> <tr><td>Connector Name</td><td>WIRE TO WIRE</td></tr> <tr><td>Connector Type</td><td>TH80FW-CS16-TM4</td></tr> </table>  <div style="text-align: center;"></div>	Connector No.	B201	Connector Name	WIRE TO WIRE	Connector Type	TH80FW-CS16-TM4	<table border="1" style="width: 100%; border-collapse: collapse;"> <tr><td>Terminal No.</td><td>Color of Wire</td><td>Signal Name [Specification]</td></tr> <tr><td>97</td><td>GR</td><td>-</td></tr> <tr><td>98</td><td>BR</td><td>-</td></tr> </table>	Terminal No.	Color of Wire	Signal Name [Specification]	97	GR	-	98	BR	-
Connector No.	B1																																												
Connector Name	WIRE TO WIRE																																												
Connector Type	TH80FW-CS16-TM4																																												
Terminal No.	Color of Wire	Signal Name [Specification]																																											
34	L	-																																											
35	P	-																																											
36	L	-																																											
37	P	-																																											
85	V	-																																											
86	LG	-																																											
Connector No.	B201																																												
Connector Name	WIRE TO WIRE																																												
Connector Type	TH80FW-CS16-TM4																																												
Terminal No.	Color of Wire	Signal Name [Specification]																																											
97	GR	-																																											
98	BR	-																																											
<table border="1" style="width: 100%; border-collapse: collapse;"> <tr><td>Connector No.</td><td>B16</td></tr> <tr><td>Connector Name</td><td>FRONT DOOR SWITCH (DRIVER SIDE)</td></tr> <tr><td>Connector Type</td><td>A03FW</td></tr> </table>  <div style="text-align: center;"></div>	Connector No.	B16	Connector Name	FRONT DOOR SWITCH (DRIVER SIDE)	Connector Type	A03FW	<table border="1" style="width: 100%; border-collapse: collapse;"> <tr><td>Terminal No.</td><td>Color of Wire</td><td>Signal Name [Specification]</td></tr> <tr><td>2</td><td>V</td><td>-</td></tr> </table>	Terminal No.	Color of Wire	Signal Name [Specification]	2	V	-	<table border="1" style="width: 100%; border-collapse: collapse;"> <tr><td>Connector No.</td><td>B23</td></tr> <tr><td>Connector Name</td><td>REAR DOOR SWITCH LH</td></tr> <tr><td>Connector Type</td><td>A03FW</td></tr> </table>  <div style="text-align: center;"></div>	Connector No.	B23	Connector Name	REAR DOOR SWITCH LH	Connector Type	A03FW	<table border="1" style="width: 100%; border-collapse: collapse;"> <tr><td>Terminal No.</td><td>Color of Wire</td><td>Signal Name [Specification]</td></tr> <tr><td>2</td><td>LG</td><td>-</td></tr> </table>	Terminal No.	Color of Wire	Signal Name [Specification]	2	LG	-																		
Connector No.	B16																																												
Connector Name	FRONT DOOR SWITCH (DRIVER SIDE)																																												
Connector Type	A03FW																																												
Terminal No.	Color of Wire	Signal Name [Specification]																																											
2	V	-																																											
Connector No.	B23																																												
Connector Name	REAR DOOR SWITCH LH																																												
Connector Type	A03FW																																												
Terminal No.	Color of Wire	Signal Name [Specification]																																											
2	LG	-																																											
<table border="1" style="width: 100%; border-collapse: collapse;"> <tr><td>Connector No.</td><td>B216</td></tr> <tr><td>Connector Name</td><td>FRONT DOOR SWITCH (PASSENGER SIDE)</td></tr> <tr><td>Connector Type</td><td>A03FW</td></tr> </table>  <div style="text-align: center;"></div>	Connector No.	B216	Connector Name	FRONT DOOR SWITCH (PASSENGER SIDE)	Connector Type	A03FW	<table border="1" style="width: 100%; border-collapse: collapse;"> <tr><td>Terminal No.</td><td>Color of Wire</td><td>Signal Name [Specification]</td></tr> <tr><td>2</td><td>GR</td><td>-</td></tr> </table>	Terminal No.	Color of Wire	Signal Name [Specification]	2	GR	-	<table border="1" style="width: 100%; border-collapse: collapse;"> <tr><td>Connector No.</td><td>E6</td></tr> <tr><td>Connector Name</td><td>IPDM E/R (INTELLIGENT POWER DISTRIBUTION MODULE ENGINE ROOM)</td></tr> <tr><td>Connector Type</td><td>TH80FW-NH</td></tr> </table>  <div style="text-align: center;"></div>	Connector No.	E6	Connector Name	IPDM E/R (INTELLIGENT POWER DISTRIBUTION MODULE ENGINE ROOM)	Connector Type	TH80FW-NH	<table border="1" style="width: 100%; border-collapse: collapse;"> <tr><td>Terminal No.</td><td>Color of Wire</td><td>Signal Name [Specification]</td></tr> <tr><td>39</td><td>P</td><td>-</td></tr> <tr><td>40</td><td>L</td><td>-</td></tr> <tr><td>41</td><td>B/W</td><td>-</td></tr> </table>	Terminal No.	Color of Wire	Signal Name [Specification]	39	P	-	40	L	-	41	B/W	-												
Connector No.	B216																																												
Connector Name	FRONT DOOR SWITCH (PASSENGER SIDE)																																												
Connector Type	A03FW																																												
Terminal No.	Color of Wire	Signal Name [Specification]																																											
2	GR	-																																											
Connector No.	E6																																												
Connector Name	IPDM E/R (INTELLIGENT POWER DISTRIBUTION MODULE ENGINE ROOM)																																												
Connector Type	TH80FW-NH																																												
Terminal No.	Color of Wire	Signal Name [Specification]																																											
39	P	-																																											
40	L	-																																											
41	B/W	-																																											
<table border="1" style="width: 100%; border-collapse: collapse;"> <tr><td>Connector No.</td><td>B233</td></tr> <tr><td>Connector Name</td><td>REAR DOOR SWITCH RH</td></tr> <tr><td>Connector Type</td><td>A03FW</td></tr> </table>  <div style="text-align: center;"></div>	Connector No.	B233	Connector Name	REAR DOOR SWITCH RH	Connector Type	A03FW	<table border="1" style="width: 100%; border-collapse: collapse;"> <tr><td>Terminal No.</td><td>Color of Wire</td><td>Signal Name [Specification]</td></tr> <tr><td>2</td><td>GR</td><td>-</td></tr> </table>	Terminal No.	Color of Wire	Signal Name [Specification]	2	GR	-	<table border="1" style="width: 100%; border-collapse: collapse;"> <tr><td>Connector No.</td><td>E5</td></tr> <tr><td>Connector Name</td><td>IPDM E/R (INTELLIGENT POWER DISTRIBUTION MODULE ENGINE ROOM)</td></tr> <tr><td>Connector Type</td><td>TH20FW-CS12-M4-IV</td></tr> </table>  <div style="text-align: center;"></div>	Connector No.	E5	Connector Name	IPDM E/R (INTELLIGENT POWER DISTRIBUTION MODULE ENGINE ROOM)	Connector Type	TH20FW-CS12-M4-IV	<table border="1" style="width: 100%; border-collapse: collapse;"> <tr><td>Terminal No.</td><td>Color of Wire</td><td>Signal Name [Specification]</td></tr> <tr><td>7</td><td>R</td><td>-</td></tr> <tr><td>12</td><td>B/W</td><td>-</td></tr> </table>	Terminal No.	Color of Wire	Signal Name [Specification]	7	R	-	12	B/W	-															
Connector No.	B233																																												
Connector Name	REAR DOOR SWITCH RH																																												
Connector Type	A03FW																																												
Terminal No.	Color of Wire	Signal Name [Specification]																																											
2	GR	-																																											
Connector No.	E5																																												
Connector Name	IPDM E/R (INTELLIGENT POWER DISTRIBUTION MODULE ENGINE ROOM)																																												
Connector Type	TH20FW-CS12-M4-IV																																												
Terminal No.	Color of Wire	Signal Name [Specification]																																											
7	R	-																																											
12	B/W	-																																											

JCLWM1245GE

AUTO LIGHT SYSTEM

< COMPONENT DIAGNOSIS >

[XENON TYPE]

AUTO LIGHT SYSTEM

Connector No.	E8
Connector Name	IPDM E/R (INTELLIGENT POWER DISTRIBUTION MODULE ENGINE ROOM)
Connector Type	NSDBFW-CS

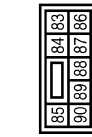

Terminal No.	Color of Wire	Signal Name [Specification]
83	O	-
84	V	-
88	BR	-
90	P	-

Connector No.	E106
Connector Name	WIRE TO WIRE
Connector Type	TH8GFW-CS16-TM4



Terminal No.	Color of Wire	Signal Name [Specification]
81	P	-
82	L	-
91	W	-

Connector No.	M1
Connector Name	FUSE BLOCK (L/R)
Connector Type	NSDBFW-M2

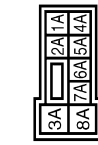

Terminal No.	Color of Wire	Signal Name [Specification]
7A	R	-

Connector No.	M6
Connector Name	WIRE TO WIRE
Connector Type	TH80MW-CS16-TM4

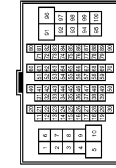

Terminal No.	Color of Wire	Signal Name [Specification]
81	P	-
82	L	-
81	W	-

Connector No.	M7
Connector Name	WIRE TO WIRE
Connector Type	TH80MW-CS16-TM4



Terminal No.	Color of Wire	Signal Name [Specification]
34	L	-
35	P	-
36	L	-
37	P	-
85	LG	-
86	R	-

Connector No.	M24
Connector Name	DATA LINK CONNECTOR
Connector Type	BD18FW

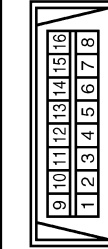

Terminal No.	Color of Wire	Signal Name [Specification]
6	L	-
14	P	-

Connector No.	M33
Connector Name	COMBINATION SWITCH
Connector Type	TH18FW-MH

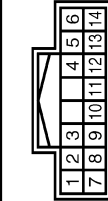

Terminal No.	Color of Wire	Signal Name [Specification]
2	SB	OUTPUT 4
5	L	OUTPUT 3
7	V	INPUT 3
8	O	OUTPUT 5
9	Y	INPUT 2
10	R	INPUT 4
11	LG	INPUT 1
12	P	OUTPUT 1
13	BR	INPUT 5
14	G	OUTPUT 2

Connector No.	M94
Connector Name	OPTICAL SENSOR
Connector Type	TK03FW



Terminal No.	Color of Wire	Signal Name [Specification]
1	Y	POWER
2	P	OUTPUT
3	B	GND





A
B
C
D
E
F
G
H
I
J
K
EXL
M
N
O
P



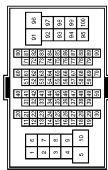

AUTO LIGHT SYSTEM

< COMPONENT DIAGNOSIS >

[XENON TYPE]

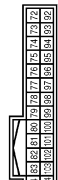
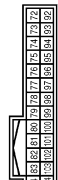
AUTO LIGHT SYSTEM

Connector No.	M117				
Connector Name	WIRE TO WIRE	BCM (BODY CONTROL MODULE)	BCM (BODY CONTROL MODULE)	BCM (BODY CONTROL MODULE)	BCM (BODY CONTROL MODULE)
Connector Type	TH80WV-CS1(F-TM4)	M03FB-LC	M118	M119	M121
					
Terminal No.	97	98	1	11	68
Color of Wire	LG	BR	W	R	BR
Signal Name [Specification]	-	-	BAT (F/L)	BAT (FUSE)	REAR RH DOOR SW
Terminal No.				13	69
Color of Wire				B	R
Signal Name [Specification]				GND	REAR LH DOOR SW

Connector No.	M122				
Connector Name	BCM (BODY CONTROL MODULE)	BCM (BODY CONTROL MODULE)	BCM (BODY CONTROL MODULE)	BCM (BODY CONTROL MODULE)	BCM (BODY CONTROL MODULE)
Connector Type	TH40FB-NH	TH40FB-NH	TH40FG-NH	TH40FG-NH	TH40FG-NH
					
Terminal No.	87	88	90	91	107
Color of Wire	BR	V	P	L	LG
Signal Name [Specification]	COMBI SW INPUT 3	COMBI SW INPUT 3	CAN-L	CAN-H	COMBI SW INPUT 1
Terminal No.	108	109			
Color of Wire	R	Y			
Signal Name [Specification]	COMBI SW INPUT 4	COMBI SW INPUT 2			

Terminal No.	113	124	137	138	142	143	144	145	146	150
Color of Wire	P	LG	O	Y	O	P	G	L	SB	LG
Signal Name [Specification]	OPTICAL SENSOR	PASSENGER DOOR SW	RECEIVER/SENSOR GND	RECEIVER/SENSOR POWER SUPPLY	COMBI SW OUTPUT 5	COMBI SW OUTPUT 1	COMBI SW OUTPUT 2	COMBI SW OUTPUT 3	COMBI SW OUTPUT 4	DRIVER DOOR SW

JCLWM1247GE

DAYTIME RUNNING LIGHT SYSTEM

< COMPONENT DIAGNOSIS >

[XENON TYPE]

DAYTIME RUNNING LIGHT SYSTEM

Wiring Diagram - DAYTIME LIGHT SYSTEM -

INFOID:000000003135359

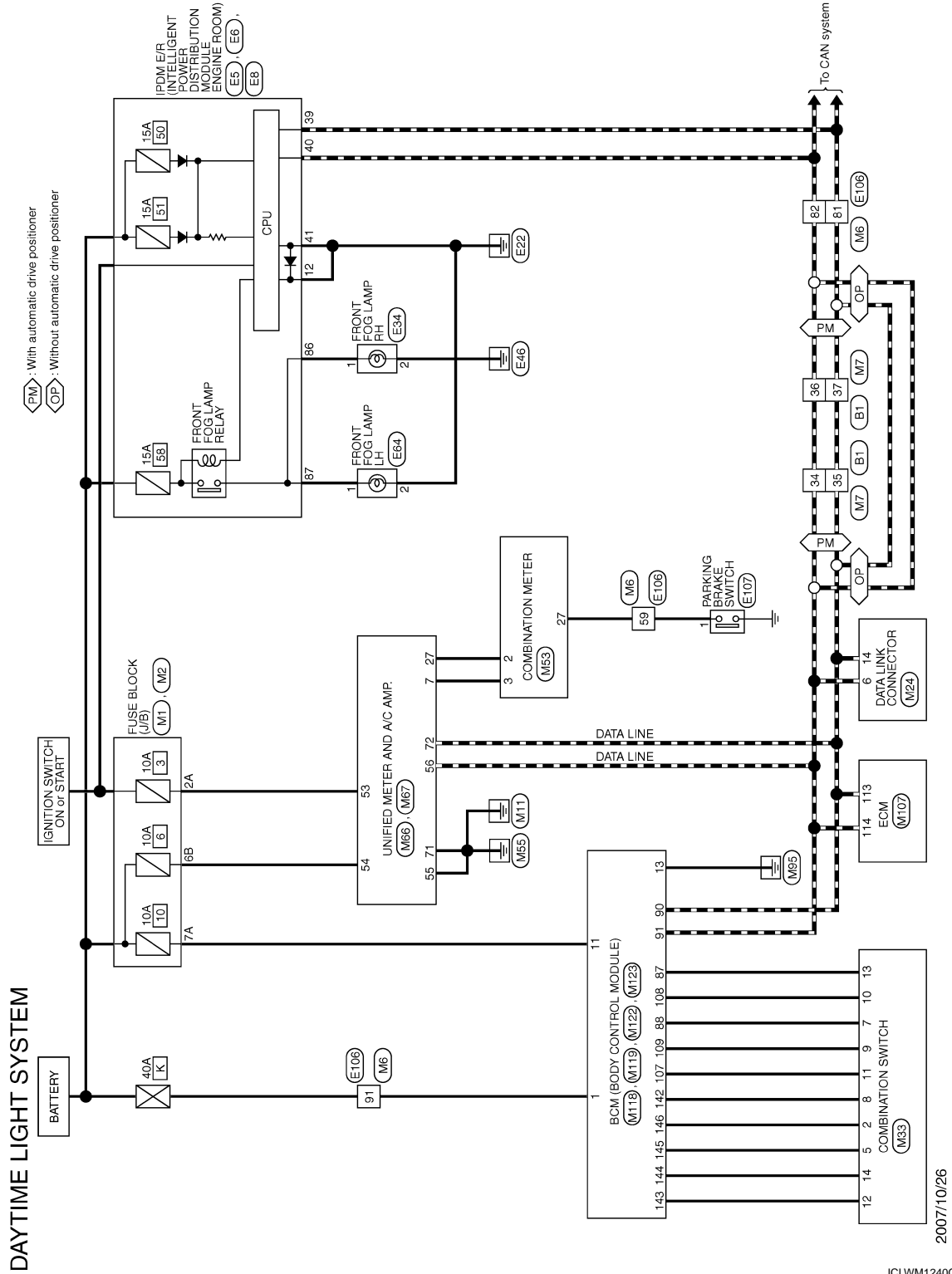

2007/10/26

JCLWM1240GE

A
B
C
D
E
F
G
H
I
J
K
L
M
N
O
P











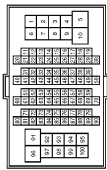

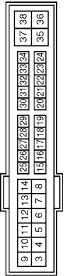

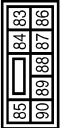

EXL

DAYTIME RUNNING LIGHT SYSTEM

< COMPONENT DIAGNOSIS >

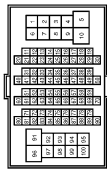
[XENON TYPE]

DAYTIME LIGHT SYSTEM

<table border="1"> <tr><td>Connector No.</td><td>B1</td></tr> <tr><td>Connector Name</td><td>WIRE TO WIRE</td></tr> <tr><td>Connector Type</td><td>TH80FW-CS16-TM4</td></tr> </table>  	Connector No.	B1	Connector Name	WIRE TO WIRE	Connector Type	TH80FW-CS16-TM4	<table border="1"> <tr><td>Terminal No.</td><td>Color of Wire</td><td>Signal Name [Specification]</td></tr> <tr><td>34</td><td>L</td><td>-</td></tr> <tr><td>35</td><td>P</td><td>-</td></tr> <tr><td>36</td><td>L</td><td>-</td></tr> <tr><td>37</td><td>P</td><td>-</td></tr> </table>	Terminal No.	Color of Wire	Signal Name [Specification]	34	L	-	35	P	-	36	L	-	37	P	-
Connector No.	B1																					
Connector Name	WIRE TO WIRE																					
Connector Type	TH80FW-CS16-TM4																					
Terminal No.	Color of Wire	Signal Name [Specification]																				
34	L	-																				
35	P	-																				
36	L	-																				
37	P	-																				
<table border="1"> <tr><td>Connector No.</td><td>E5</td></tr> <tr><td>Connector Name</td><td>IPDM E/R (INTELLIGENT POWER DISTRIBUTION MODULE ENGINE ROOM)</td></tr> <tr><td>Connector Type</td><td>TH20FW-CS12-M4-1V</td></tr> </table>  	Connector No.	E5	Connector Name	IPDM E/R (INTELLIGENT POWER DISTRIBUTION MODULE ENGINE ROOM)	Connector Type	TH20FW-CS12-M4-1V	<table border="1"> <tr><td>Terminal No.</td><td>Color of Wire</td><td>Signal Name [Specification]</td></tr> <tr><td>12</td><td>B/W</td><td>-</td></tr> </table>	Terminal No.	Color of Wire	Signal Name [Specification]	12	B/W	-									
Connector No.	E5																					
Connector Name	IPDM E/R (INTELLIGENT POWER DISTRIBUTION MODULE ENGINE ROOM)																					
Connector Type	TH20FW-CS12-M4-1V																					
Terminal No.	Color of Wire	Signal Name [Specification]																				
12	B/W	-																				
<table border="1"> <tr><td>Connector No.</td><td>E5</td></tr> <tr><td>Connector Name</td><td>IPDM E/R (INTELLIGENT POWER DISTRIBUTION MODULE ENGINE ROOM)</td></tr> <tr><td>Connector Type</td><td>TH80FW-RH</td></tr> </table>  	Connector No.	E5	Connector Name	IPDM E/R (INTELLIGENT POWER DISTRIBUTION MODULE ENGINE ROOM)	Connector Type	TH80FW-RH	<table border="1"> <tr><td>Terminal No.</td><td>Color of Wire</td><td>Signal Name [Specification]</td></tr> <tr><td>39</td><td>P</td><td>-</td></tr> <tr><td>40</td><td>L</td><td>-</td></tr> <tr><td>41</td><td>B/W</td><td>-</td></tr> </table>	Terminal No.	Color of Wire	Signal Name [Specification]	39	P	-	40	L	-	41	B/W	-			
Connector No.	E5																					
Connector Name	IPDM E/R (INTELLIGENT POWER DISTRIBUTION MODULE ENGINE ROOM)																					
Connector Type	TH80FW-RH																					
Terminal No.	Color of Wire	Signal Name [Specification]																				
39	P	-																				
40	L	-																				
41	B/W	-																				
<table border="1"> <tr><td>Connector No.</td><td>E6</td></tr> <tr><td>Connector Name</td><td>IPDM E/R (INTELLIGENT POWER DISTRIBUTION MODULE ENGINE ROOM)</td></tr> <tr><td>Connector Type</td><td>NS30FW-CS</td></tr> </table>  	Connector No.	E6	Connector Name	IPDM E/R (INTELLIGENT POWER DISTRIBUTION MODULE ENGINE ROOM)	Connector Type	NS30FW-CS	<table border="1"> <tr><td>Terminal No.</td><td>Color of Wire</td><td>Signal Name [Specification]</td></tr> <tr><td>86</td><td>W</td><td>-</td></tr> <tr><td>87</td><td>L</td><td>-</td></tr> </table>	Terminal No.	Color of Wire	Signal Name [Specification]	86	W	-	87	L	-						
Connector No.	E6																					
Connector Name	IPDM E/R (INTELLIGENT POWER DISTRIBUTION MODULE ENGINE ROOM)																					
Connector Type	NS30FW-CS																					
Terminal No.	Color of Wire	Signal Name [Specification]																				
86	W	-																				
87	L	-																				
<table border="1"> <tr><td>Connector No.</td><td>E34</td></tr> <tr><td>Connector Name</td><td>FRONT FOG LAMP RH</td></tr> <tr><td>Connector Type</td><td>FC1.240P-C023S4019</td></tr> </table>  	Connector No.	E34	Connector Name	FRONT FOG LAMP RH	Connector Type	FC1.240P-C023S4019	<table border="1"> <tr><td>Terminal No.</td><td>Color of Wire</td><td>Signal Name [Specification]</td></tr> <tr><td>1</td><td>W</td><td>-</td></tr> <tr><td>2</td><td>B/W</td><td>-</td></tr> </table>	Terminal No.	Color of Wire	Signal Name [Specification]	1	W	-	2	B/W	-						
Connector No.	E34																					
Connector Name	FRONT FOG LAMP RH																					
Connector Type	FC1.240P-C023S4019																					
Terminal No.	Color of Wire	Signal Name [Specification]																				
1	W	-																				
2	B/W	-																				
<table border="1"> <tr><td>Connector No.</td><td>E64</td></tr> <tr><td>Connector Name</td><td>FRONT FOG LAMP LH</td></tr> <tr><td>Connector Type</td><td>FC1.240P-C023S4019</td></tr> </table>  	Connector No.	E64	Connector Name	FRONT FOG LAMP LH	Connector Type	FC1.240P-C023S4019	<table border="1"> <tr><td>Terminal No.</td><td>Color of Wire</td><td>Signal Name [Specification]</td></tr> <tr><td>1</td><td>L</td><td>-</td></tr> <tr><td>2</td><td>B/W</td><td>-</td></tr> </table>	Terminal No.	Color of Wire	Signal Name [Specification]	1	L	-	2	B/W	-						
Connector No.	E64																					
Connector Name	FRONT FOG LAMP LH																					
Connector Type	FC1.240P-C023S4019																					
Terminal No.	Color of Wire	Signal Name [Specification]																				
1	L	-																				
2	B/W	-																				
<table border="1"> <tr><td>Connector No.</td><td>E106</td></tr> <tr><td>Connector Name</td><td>WIRE TO WIRE</td></tr> <tr><td>Connector Type</td><td>TH80FW-CS16-TM4</td></tr> </table>  	Connector No.	E106	Connector Name	WIRE TO WIRE	Connector Type	TH80FW-CS16-TM4	<table border="1"> <tr><td>Terminal No.</td><td>Color of Wire</td><td>Signal Name [Specification]</td></tr> <tr><td>59</td><td>O</td><td>-</td></tr> <tr><td>81</td><td>P</td><td>-</td></tr> <tr><td>82</td><td>L</td><td>-</td></tr> <tr><td>91</td><td>W</td><td>-</td></tr> </table>	Terminal No.	Color of Wire	Signal Name [Specification]	59	O	-	81	P	-	82	L	-	91	W	-
Connector No.	E106																					
Connector Name	WIRE TO WIRE																					
Connector Type	TH80FW-CS16-TM4																					
Terminal No.	Color of Wire	Signal Name [Specification]																				
59	O	-																				
81	P	-																				
82	L	-																				
91	W	-																				
<table border="1"> <tr><td>Connector No.</td><td>E107</td></tr> <tr><td>Connector Name</td><td>PARKING BRAKE SWITCH</td></tr> <tr><td>Connector Type</td><td>TE80FW</td></tr> </table>  	Connector No.	E107	Connector Name	PARKING BRAKE SWITCH	Connector Type	TE80FW	<table border="1"> <tr><td>Terminal No.</td><td>Color of Wire</td><td>Signal Name [Specification]</td></tr> <tr><td>1</td><td>O</td><td>-</td></tr> </table>	Terminal No.	Color of Wire	Signal Name [Specification]	1	O	-									
Connector No.	E107																					
Connector Name	PARKING BRAKE SWITCH																					
Connector Type	TE80FW																					
Terminal No.	Color of Wire	Signal Name [Specification]																				
1	O	-																				

JCLWM1241GE

DAYTIME RUNNING LIGHT SYSTEM

< COMPONENT DIAGNOSIS >

[XENON TYPE]

DAYTIME LIGHT SYSTEM

Connector No.	M1
Connector Name	FUSE BLOCK (J/B)
Connector Type	NSDFV-M2

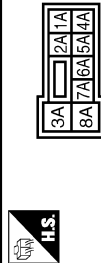

Terminal No.	Color of Wire	Signal Name [Specification]
2A	G	-
7A	R	-

Connector No.	M2
Connector Name	FUSE BLOCK (J/B)
Connector Type	NSDFV-CS

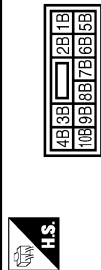

Terminal No.	Color of Wire	Signal Name [Specification]
6B	Y	-

Connector No.	M6
Connector Name	WIRE TO WIRE
Connector Type	TH80MP-CS16-TM4

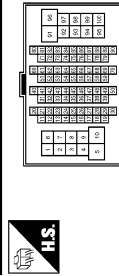

Terminal No.	Color of Wire	Signal Name [Specification]
59	V	-
81	P	-
82	L	-
91	W	-

Connector No.	M7
Connector Name	WIRE TO WIRE
Connector Type	TH80MP-CS16-TM4

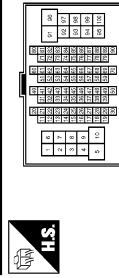

Terminal No.	Color of Wire	Signal Name [Specification]
34	L	-
35	P	-
36	L	-
37	P	-

Connector No.	M24
Connector Name	DATA LINK CONNECTOR
Connector Type	BD16FW

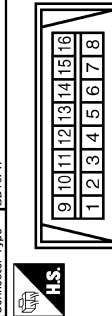

Terminal No.	Color of Wire	Signal Name [Specification]
6	L	-
14	P	-

Connector No.	M33
Connector Name	COMBINATION SWITCH
Connector Type	TH16FW-NH

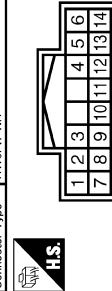

Terminal No.	Color of Wire	Signal Name [Specification]
2	SB	OUTPUT 4
5	L	OUTPUT 3
7	V	INPUT 3
8	O	OUTPUT 5
9	Y	INPUT 2
10	R	INPUT 4
11	LG	INPUT 1
12	P	OUTPUT 1
13	BR	INPUT 5
14	G	OUTPUT 2

Connector No.	M53
Connector Name	COMBINATION METER
Connector Type	TH40FW-NH



Terminal No.	Color of Wire	Signal Name [Specification]
2	LG	COMM (METER->AMP.)
3	GR	COMM (AMP->METER)
27	V	PARKING BRAKE SW

Connector No.	M66
Connector Name	UNIFIED METER AND A/C AMP.
Connector Type	TH40FW-NH



Terminal No.	Color of Wire	Signal Name [Specification]
7	GR	COMM (AMP->METER)
27	LG	COMM (METER->AMP.)

A
B
C
D
E
F
G
H
I
J
K
EXL
M
N
O
P

DAYTIME RUNNING LIGHT SYSTEM

< COMPONENT DIAGNOSIS >

[XENON TYPE]

DAYTIME LIGHT SYSTEM

Connector No.	M167
Connector Name	UNIFIED METER AND A/C AMP.
Connector Type	TH22FY-NH

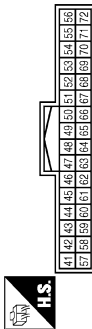

Terminal No.	Color of Wire	Signal Name [Specification]
53	G	IGN
54	Y	BAT
55	B	GND
56	L	CAN-H
71	B	GND
72	P	CAN-L

Connector No.	M122
Connector Name	BCM (BODY CONTROL MODULE)
Connector Type	TH40FB-NH

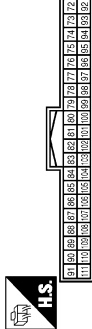

Terminal No.	Color of Wire	Signal Name [Specification]
87	BR	COMBI SW INPUT 3
88	V	COMBI SW INPUT 3
90	P	CAN-L
91	L	CAN-H
107	LG	COMBI SW INPUT 1
108	R	COMBI SW INPUT 4
109	Y	COMBI SW INPUT 2

Connector No.	M107
Connector Name	ECM
Connector Type	RH24FY-R28-R-LH-Z

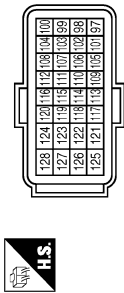

Terminal No.	Color of Wire	Signal Name [Specification]
113	P	VEHCAN-L
114	L	VEHCAN-H

Connector No.	M123
Connector Name	BCM (BODY CONTROL MODULE)
Connector Type	TH40FG-NH

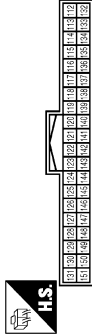

Terminal No.	Color of Wire	Signal Name [Specification]
142	O	COMBI SW OUTPUT 5
143	P	COMBI SW OUTPUT 1
144	G	COMBI SW OUTPUT 2
145	L	COMBI SW OUTPUT 3
146	SB	COMBI SW OUTPUT 4

Connector No.	M119
Connector Name	BCM (BODY CONTROL MODULE)
Connector Type	NS3.6FW-CS

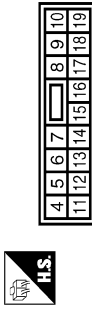

Terminal No.	Color of Wire	Signal Name [Specification]
11	R	BAT (FUSE)
13	B	GND

Connector No.	M118
Connector Name	BCM (BODY CONTROL MODULE)
Connector Type	M03FB-LC



Terminal No.	Color of Wire	Signal Name [Specification]
1	W	BAT (F/L)

JCLWM1243GE

FRONT FOG LAMP SYSTEM

< COMPONENT DIAGNOSIS >

[XENON TYPE]

FRONT FOG LAMP SYSTEM

Wiring Diagram - FRONT FOG LAMP -

INFOID:000000003135360

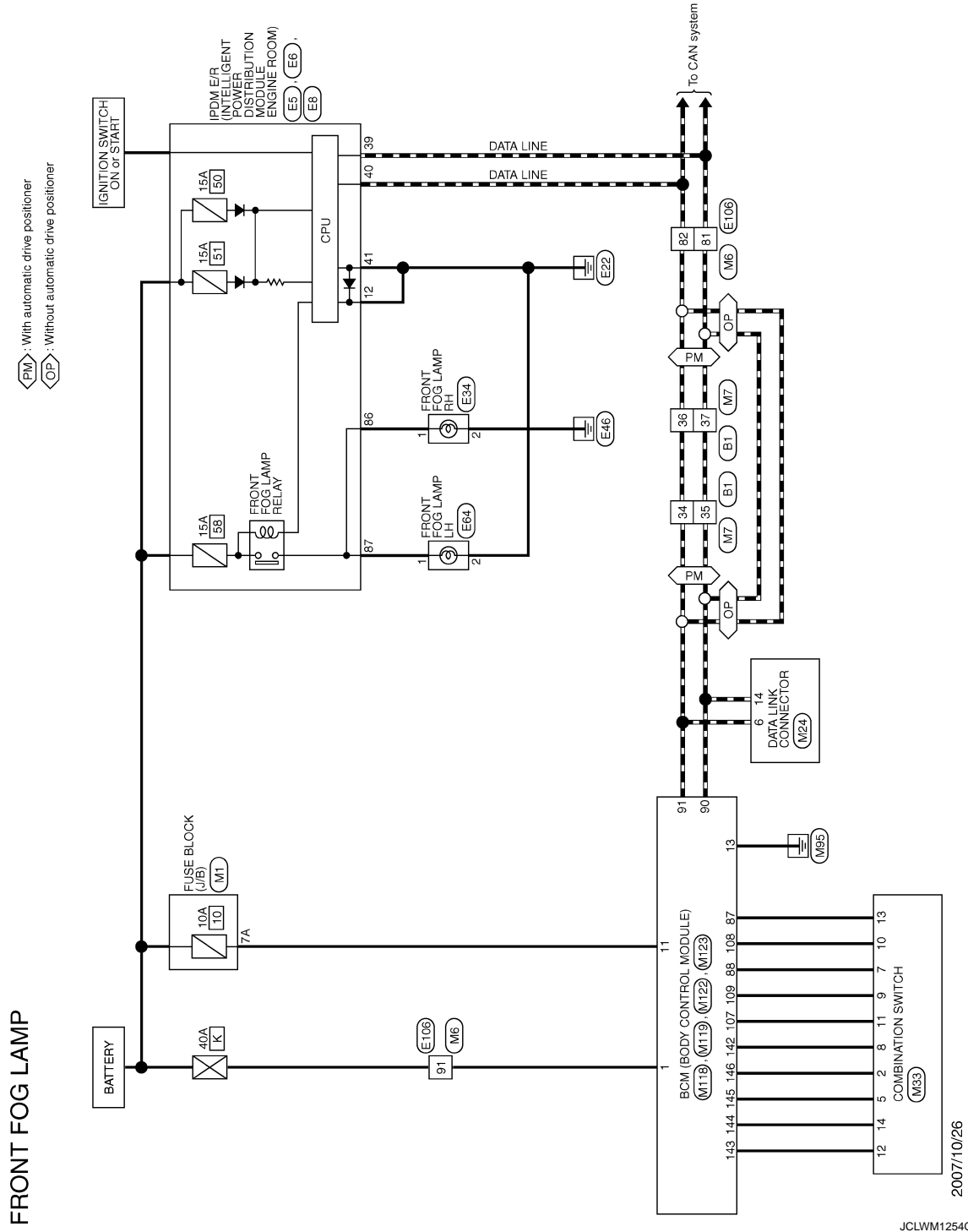

2007/10/26

JCLWM1254GE





A
B
C
D
E
F
G
H
I
J
K
EXL
M
N
O
P

FRONT FOG LAMP SYSTEM

< COMPONENT DIAGNOSIS >

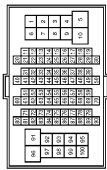
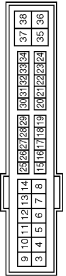
[XENON TYPE]

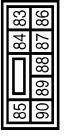
FRONT FOG LAMP

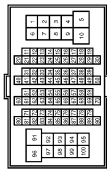
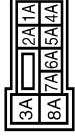
Connector No. B1	WIRE TO WIRE TH80FW-GS16-TM4		Terminal No.	Color of Wire	Signal Name [Specification]
Connector Name			34	L	
Connector Type			35	P	
			36	L	
			37	P	
Connector No. E5	IPDM E/R (INTELLIGENT POWER DISTRIBUTION MODULE ENGINE ROOM)		Terminal No.	Color of Wire	Signal Name [Specification]
Connector Name			12	B/W	
Connector Type	TH20FW-GS12-M4-1V				
Connector No. E5	IPDM E/R (INTELLIGENT POWER DISTRIBUTION MODULE ENGINE ROOM)		Terminal No.	Color of Wire	Signal Name [Specification]
Connector Name			39	P	
Connector Type	TH80FW-RH		40	L	
			41	B/W	
Connector No. E5	IPDM E/R (INTELLIGENT POWER DISTRIBUTION MODULE ENGINE ROOM)		Terminal No.	Color of Wire	Signal Name [Specification]
Connector Name			86	W	
Connector Type	NS30FW-CS		87	L	
Connector No. E34	FRONT FOG LAMP RH FC1.240P-C023S4019		Terminal No.	Color of Wire	Signal Name [Specification]
Connector Name			1	W	
Connector Type			2	B/W	
Connector No. E64	FRONT FOG LAMP LH FC1.240P-C023S4019		Terminal No.	Color of Wire	Signal Name [Specification]
Connector Name			1	L	
Connector Type			2	B/W	
Connector No. E106	WIRE TO WIRE TH80FW-GS16-TM4		Terminal No.	Color of Wire	Signal Name [Specification]
Connector Name			81	P	
Connector Type			82	L	
			91	W	
Connector No. M1	FUSE BLOCK (J/B) NS30FW-M2		Terminal No.	Color of Wire	Signal Name [Specification]
Connector Name			7A	R	
Connector Type					

JCLWM1255GE

FRONT FOG LAMP SYSTEM

< COMPONENT DIAGNOSIS >

[XENON TYPE]

FRONT FOG LAMP

Connector No.	M6
Connector Name	WIRE TO WIRE
Connector Type	TH80MW-CS1F-TM4



Terminal No.	Color of Wire	Signal Name [Specification]
81	P	-
82	L	-
91	W	-

Connector No.	M7
Connector Name	WIRE TO WIRE
Connector Type	TH80MW-CS1B-TM4

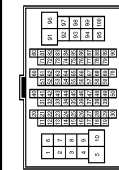

Terminal No.	Color of Wire	Signal Name [Specification]
34	L	-
35	P	-
36	L	-
37	P	-

Connector No.	M24
Connector Name	DATA LINK CONNECTOR
Connector Type	BD16FW

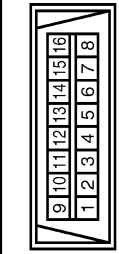

Terminal No.	Color of Wire	Signal Name [Specification]
6	L	-
14	P	-

Connector No.	M83
Connector Name	COMBINATION SWITCH
Connector Type	TH18FW-NH

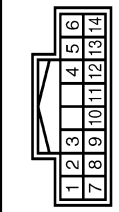

Terminal No.	Color of Wire	Signal Name [Specification]
2	SB	OUTPUT 4
5	L	OUTPUT 3
7	V	INPUT 3
8	O	OUTPUT 5
9	Y	INPUT 2
10	R	INPUT 4
11	LG	INPUT 1
12	P	OUTPUT 1
13	BR	INPUT 5
14	G	OUTPUT 2

Connector No.	M18
Connector Name	BCM (BODY CONTROL MODULE)
Connector Type	MG3FB-LG



Terminal No.	Color of Wire	Signal Name [Specification]
1	W	BAT (F/L)

Connector No.	M118
Connector Name	BCM (BODY CONTROL MODULE)
Connector Type	NS18FW-CS

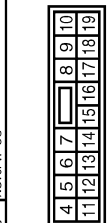

Terminal No.	Color of Wire	Signal Name [Specification]
11	R	BAT (FUSE)
13	B	GND

Connector No.	M122
Connector Name	BCM (BODY CONTROL MODULE)
Connector Type	TH40FB-NH

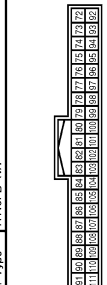

Terminal No.	Color of Wire	Signal Name [Specification]
87	BR	COMBI SW INPUT 5
88	V	COMBI SW INPUT 3
90	P	CAN-L
91	L	CAN-H
107	LG	COMBI SW INPUT 1
108	R	COMBI SW INPUT 4
109	Y	COMBI SW INPUT 2

Connector No.	M123
Connector Name	BCM (BODY CONTROL MODULE)
Connector Type	TH40FG-NH

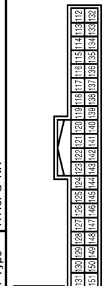

Terminal No.	Color of Wire	Signal Name [Specification]
142	O	COMBI SW OUTPUT 5
143	P	COMBI SW OUTPUT 1
144	G	COMBI SW OUTPUT 2
145	L	COMBI SW OUTPUT 3
146	SB	COMBI SW OUTPUT 4

A
B
C
D
E
F
G
H
I
J
K
EXL
M
N
O
P

TURN SIGNAL AND HAZARD WARNING LAMP SYSTEM

< COMPONENT DIAGNOSIS >

[XENON TYPE]

TURN SIGNAL AND HAZARD WARNING LAMP SYSTEM

Wiring Diagram - TURN AND HAZARD WARNING LAMPS -

INFOID:000000003135361

TURN SIGNAL AND HAZARD WARNING LAMPS

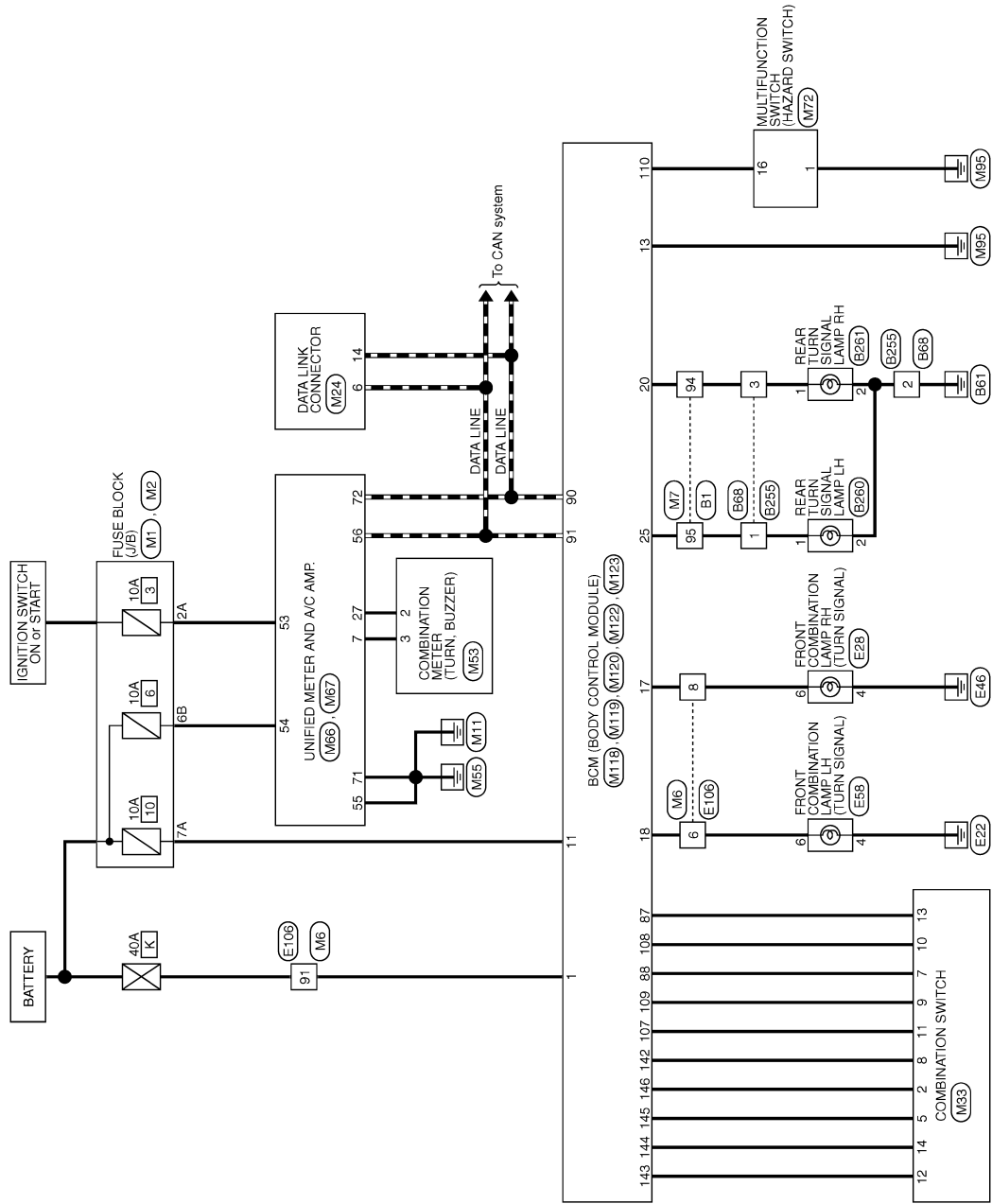

2007/10/26













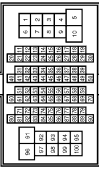

JCLWM1257GE

TURN SIGNAL AND HAZARD WARNING LAMP SYSTEM

< COMPONENT DIAGNOSIS >

[XENON TYPE]

TURN SIGNAL AND HAZARD WARNING LAMPS

<table border="1" style="width: 100%; border-collapse: collapse;"> <tr><td>Connector No.</td><td>B1</td></tr> <tr><td>Connector Name</td><td>WIRE TO WIRE</td></tr> <tr><td>Connector Type</td><td>TH8DFW-CS16-TM4</td></tr> </table>   <table border="1" style="width: 100%; border-collapse: collapse;"> <tr><td>Terminal No.</td><td>94</td><td>95</td></tr> <tr><td>Color of Wire</td><td>SB</td><td>G</td></tr> <tr><td>Signal Name [Specification]</td><td>-</td><td>-</td></tr> </table>	Connector No.	B1	Connector Name	WIRE TO WIRE	Connector Type	TH8DFW-CS16-TM4	Terminal No.	94	95	Color of Wire	SB	G	Signal Name [Specification]	-	-	<table border="1" style="width: 100%; border-collapse: collapse;"> <tr><td>Connector No.</td><td>E108</td></tr> <tr><td>Connector Name</td><td>WIRE TO WIRE</td></tr> <tr><td>Connector Type</td><td>FR408MB</td></tr> </table>   <table border="1" style="width: 100%; border-collapse: collapse;"> <tr><td>Terminal No.</td><td>1</td><td>2</td><td>3</td></tr> <tr><td>Color of Wire</td><td>G</td><td>B</td><td>SB</td></tr> <tr><td>Signal Name [Specification]</td><td>-</td><td>-</td><td>-</td></tr> </table>	Connector No.	E108	Connector Name	WIRE TO WIRE	Connector Type	FR408MB	Terminal No.	1	2	3	Color of Wire	G	B	SB	Signal Name [Specification]	-	-	-	<table border="1" style="width: 100%; border-collapse: collapse;"> <tr><td>Connector No.</td><td>B255</td></tr> <tr><td>Connector Name</td><td>WIRE TO WIRE</td></tr> <tr><td>Connector Type</td><td>FR408FB</td></tr> </table>   <table border="1" style="width: 100%; border-collapse: collapse;"> <tr><td>Terminal No.</td><td>1</td><td>2</td><td>3</td></tr> <tr><td>Color of Wire</td><td>G</td><td>B</td><td>V</td></tr> <tr><td>Signal Name [Specification]</td><td>-</td><td>-</td><td>-</td></tr> </table>	Connector No.	B255	Connector Name	WIRE TO WIRE	Connector Type	FR408FB	Terminal No.	1	2	3	Color of Wire	G	B	V	Signal Name [Specification]	-	-	-	<table border="1" style="width: 100%; border-collapse: collapse;"> <tr><td>Connector No.</td><td>E109</td></tr> <tr><td>Connector Name</td><td>WIRE TO WIRE</td></tr> <tr><td>Connector Type</td><td>TH8DFW-CS16-TM4</td></tr> </table>   <table border="1" style="width: 100%; border-collapse: collapse;"> <tr><td>Terminal No.</td><td>6</td><td>8</td><td>91</td></tr> <tr><td>Color of Wire</td><td>G</td><td>V</td><td>W</td></tr> <tr><td>Signal Name [Specification]</td><td>-</td><td>-</td><td>-</td></tr> </table>	Connector No.	E109	Connector Name	WIRE TO WIRE	Connector Type	TH8DFW-CS16-TM4	Terminal No.	6	8	91	Color of Wire	G	V	W	Signal Name [Specification]	-	-	-
Connector No.	B1																																																																							
Connector Name	WIRE TO WIRE																																																																							
Connector Type	TH8DFW-CS16-TM4																																																																							
Terminal No.	94	95																																																																						
Color of Wire	SB	G																																																																						
Signal Name [Specification]	-	-																																																																						
Connector No.	E108																																																																							
Connector Name	WIRE TO WIRE																																																																							
Connector Type	FR408MB																																																																							
Terminal No.	1	2	3																																																																					
Color of Wire	G	B	SB																																																																					
Signal Name [Specification]	-	-	-																																																																					
Connector No.	B255																																																																							
Connector Name	WIRE TO WIRE																																																																							
Connector Type	FR408FB																																																																							
Terminal No.	1	2	3																																																																					
Color of Wire	G	B	V																																																																					
Signal Name [Specification]	-	-	-																																																																					
Connector No.	E109																																																																							
Connector Name	WIRE TO WIRE																																																																							
Connector Type	TH8DFW-CS16-TM4																																																																							
Terminal No.	6	8	91																																																																					
Color of Wire	G	V	W																																																																					
Signal Name [Specification]	-	-	-																																																																					
<table border="1" style="width: 100%; border-collapse: collapse;"> <tr><td>Connector No.</td><td>B261</td></tr> <tr><td>Connector Name</td><td>REAR TURN SIGNAL LAMP RH</td></tr> <tr><td>Connector Type</td><td>HS02FG-W</td></tr> </table>   <table border="1" style="width: 100%; border-collapse: collapse;"> <tr><td>Terminal No.</td><td>1</td><td>2</td></tr> <tr><td>Color of Wire</td><td>V</td><td>B</td></tr> <tr><td>Signal Name [Specification]</td><td>-</td><td>-</td></tr> </table>	Connector No.	B261	Connector Name	REAR TURN SIGNAL LAMP RH	Connector Type	HS02FG-W	Terminal No.	1	2	Color of Wire	V	B	Signal Name [Specification]	-	-	<table border="1" style="width: 100%; border-collapse: collapse;"> <tr><td>Connector No.</td><td>E28</td></tr> <tr><td>Connector Name</td><td>FRONT COMBINATION LAMP RH</td></tr> <tr><td>Connector Type</td><td>RS08FB-PR</td></tr> </table>   <table border="1" style="width: 100%; border-collapse: collapse;"> <tr><td>Terminal No.</td><td>4</td><td>6</td></tr> <tr><td>Color of Wire</td><td>B/W</td><td>V</td></tr> <tr><td>Signal Name [Specification]</td><td>-</td><td>-</td></tr> </table>	Connector No.	E28	Connector Name	FRONT COMBINATION LAMP RH	Connector Type	RS08FB-PR	Terminal No.	4	6	Color of Wire	B/W	V	Signal Name [Specification]	-	-	<table border="1" style="width: 100%; border-collapse: collapse;"> <tr><td>Connector No.</td><td>E58</td></tr> <tr><td>Connector Name</td><td>FRONT COMBINATION LAMP LH</td></tr> <tr><td>Connector Type</td><td>RS08FB-PR</td></tr> </table>   <table border="1" style="width: 100%; border-collapse: collapse;"> <tr><td>Terminal No.</td><td>4</td><td>6</td></tr> <tr><td>Color of Wire</td><td>B/W</td><td>G</td></tr> <tr><td>Signal Name [Specification]</td><td>-</td><td>-</td></tr> </table>	Connector No.	E58	Connector Name	FRONT COMBINATION LAMP LH	Connector Type	RS08FB-PR	Terminal No.	4	6	Color of Wire	B/W	G	Signal Name [Specification]	-	-	<table border="1" style="width: 100%; border-collapse: collapse;"> <tr><td>Connector No.</td><td>E108</td></tr> <tr><td>Connector Name</td><td>WIRE TO WIRE</td></tr> <tr><td>Connector Type</td><td>TH8DFW-CS16-TM4</td></tr> </table>	Connector No.	E108	Connector Name	WIRE TO WIRE	Connector Type	TH8DFW-CS16-TM4																		
Connector No.	B261																																																																							
Connector Name	REAR TURN SIGNAL LAMP RH																																																																							
Connector Type	HS02FG-W																																																																							
Terminal No.	1	2																																																																						
Color of Wire	V	B																																																																						
Signal Name [Specification]	-	-																																																																						
Connector No.	E28																																																																							
Connector Name	FRONT COMBINATION LAMP RH																																																																							
Connector Type	RS08FB-PR																																																																							
Terminal No.	4	6																																																																						
Color of Wire	B/W	V																																																																						
Signal Name [Specification]	-	-																																																																						
Connector No.	E58																																																																							
Connector Name	FRONT COMBINATION LAMP LH																																																																							
Connector Type	RS08FB-PR																																																																							
Terminal No.	4	6																																																																						
Color of Wire	B/W	G																																																																						
Signal Name [Specification]	-	-																																																																						
Connector No.	E108																																																																							
Connector Name	WIRE TO WIRE																																																																							
Connector Type	TH8DFW-CS16-TM4																																																																							

TURN SIGNAL AND HAZARD WARNING LAMP SYSTEM

< COMPONENT DIAGNOSIS >

[XENON TYPE]

TURN SIGNAL AND HAZARD WARNING LAMPS

Connector No.	M1	Connector No.	M2	Connector No.	M6	Connector No.	M7
Connector Name	FUSE BLOCK (J/B)	Connector Name	FUSE BLOCK (J/B)	Connector Name	WIRE TO WIRE	Connector Name	WIRE TO WIRE
Connector Type	NSDBFW-M2	Connector Type	NS16FW-CS	Connector Type	TH4DFW-CS18-TM4	Connector Type	TH8DMW-CS16-TM4

Terminal No.	2A	Terminal No.	6B	Terminal No.	6	Terminal No.	94
Color of Wire	G	Color of Wire	Y	Color of Wire	O	Color of Wire	V
Signal Name [Specification]	-	Signal Name [Specification]	-	Signal Name [Specification]	-	Signal Name [Specification]	-
Terminal No.	7A	Terminal No.	6B	Terminal No.	8	Terminal No.	95
Color of Wire	R	Color of Wire	Y	Color of Wire	W	Color of Wire	G
Signal Name [Specification]	-	Signal Name [Specification]	-	Signal Name [Specification]	-	Signal Name [Specification]	-

Connector No.	M24	Connector No.	M33	Connector No.	M53	Connector No.	M66
Connector Name	DATA LINK CONNECTOR	Connector Name	COMBINATION SWITCH	Connector Name	COMBINATION METER	Connector Name	UNIFIED METER AND A/C AMP.
Connector Type	BD16FW	Connector Type	TH16FW-NH	Connector Type	TH4DFW-NH	Connector Type	TH4DFW-NH

Terminal No.	6	Terminal No.	2	Terminal No.	2	Terminal No.	7
Color of Wire	L	Color of Wire	SB	Color of Wire	L	Color of Wire	GR
Signal Name [Specification]	-	Signal Name [Specification]	OUTPUT 4	Signal Name [Specification]	OUTPUT 3	Signal Name [Specification]	COMM (AMP->METER)
Terminal No.	14	Terminal No.	5	Terminal No.	7	Terminal No.	27
Color of Wire	P	Terminal No.	9	Terminal No.	8	Color of Wire	LG
Signal Name [Specification]	-	Terminal No.	10	Terminal No.	11	Signal Name [Specification]	COMM (METER->AMP.)
		Terminal No.	12	Terminal No.	13	Signal Name [Specification]	COMM (METER->AMP.)
		Terminal No.	13	Terminal No.	14	Signal Name [Specification]	COMM (METER->AMP.)
		Terminal No.	14	Terminal No.	15	Signal Name [Specification]	COMM (METER->AMP.)

JCLWM1259GE

TURN SIGNAL AND HAZARD WARNING LAMP SYSTEM

< COMPONENT DIAGNOSIS >

[XENON TYPE]

TURN SIGNAL AND HAZARD WARNING LAMPS

Connector No.	M67
Connector Name	UNIFIED METER AND A/C AMP.
Connector Type	TH22FV-NH

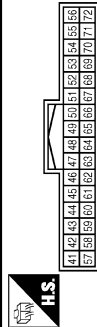

Connector No.	M72
Connector Name	MULTIFUNCTION SWITCH
Connector Type	TH18FV-NH

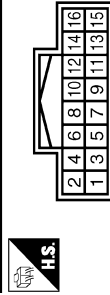

Connector No.	M118
Connector Name	BCM (BODY CONTROL MODULE)
Connector Type	M03FE-LC

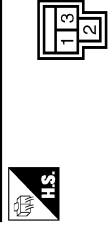

Connector No.	M119
Connector Name	BCM (BODY CONTROL MODULE)
Connector Type	NS18FW-CS

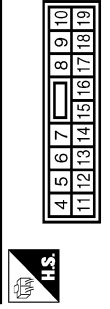

Terminal No.	Color of Wire	Signal Name [Specification]
53	G	IGN
54	Y	BAT
55	B	GND
56	L	CAN-H
71	B	GND
72	P	CAN-L

Terminal No.	Color of Wire	Signal Name [Specification]
1	B	GND
16	G	HAZARD ON

Terminal No.	Color of Wire	Signal Name [Specification]
1	W	BAT (F/L)

Terminal No.	Color of Wire	Signal Name [Specification]
11	R	BAT (FUSE)
13	B	GND
17	W	TURN SIGNAL RH (FRONT)
18	O	TURN SIGNAL LH (FRONT)

Connector No.	M120
Connector Name	BCM (BODY CONTROL MODULE)
Connector Type	NS12FW-CS

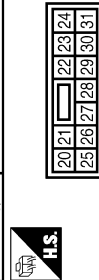

Connector No.	M122
Connector Name	BCM (BODY CONTROL MODULE)
Connector Type	TH40FB-NH

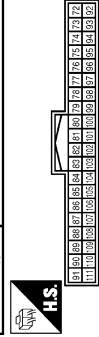

Connector No.	M123
Connector Name	BCM (BODY CONTROL MODULE)
Connector Type	TH40FG-NH

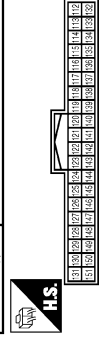

Terminal No.	Color of Wire	Signal Name [Specification]
20	V	TURN SIGNAL RH (REAR)
25	G	TURN SIGNAL LH (REAR)

Terminal No.	Color of Wire	Signal Name [Specification]
87	BR	COMBI SW INPUT 5
88	V	COMBI SW INPUT 3
90	P	CAN-L
91	L	CAN-H
107	LG	COMBI SW INPUT 1
108	R	COMBI SW INPUT 4
109	Y	COMBI SW INPUT 2
110	G	HAZARD SW

Terminal No.	Color of Wire	Signal Name [Specification]
142	O	COMBI SW OUTPUT 5
143	P	COMBI SW OUTPUT 1
144	G	COMBI SW OUTPUT 2
145	L	COMBI SW OUTPUT 3
146	SB	COMBI SW OUTPUT 4

A
B
C
D
E
F
G
H
I
J
K
EXL
M
N
O
P

PARKING, LICENSE PLATE AND TAIL LAMPS SYSTEM

< COMPONENT DIAGNOSIS >

[XENON TYPE]

PARKING, LICENSE PLATE AND TAIL LAMPS SYSTEM

Wiring Diagram - PARKING, LICENSE PLATE AND TAIL LAMPS -

INFOID:000000003135362

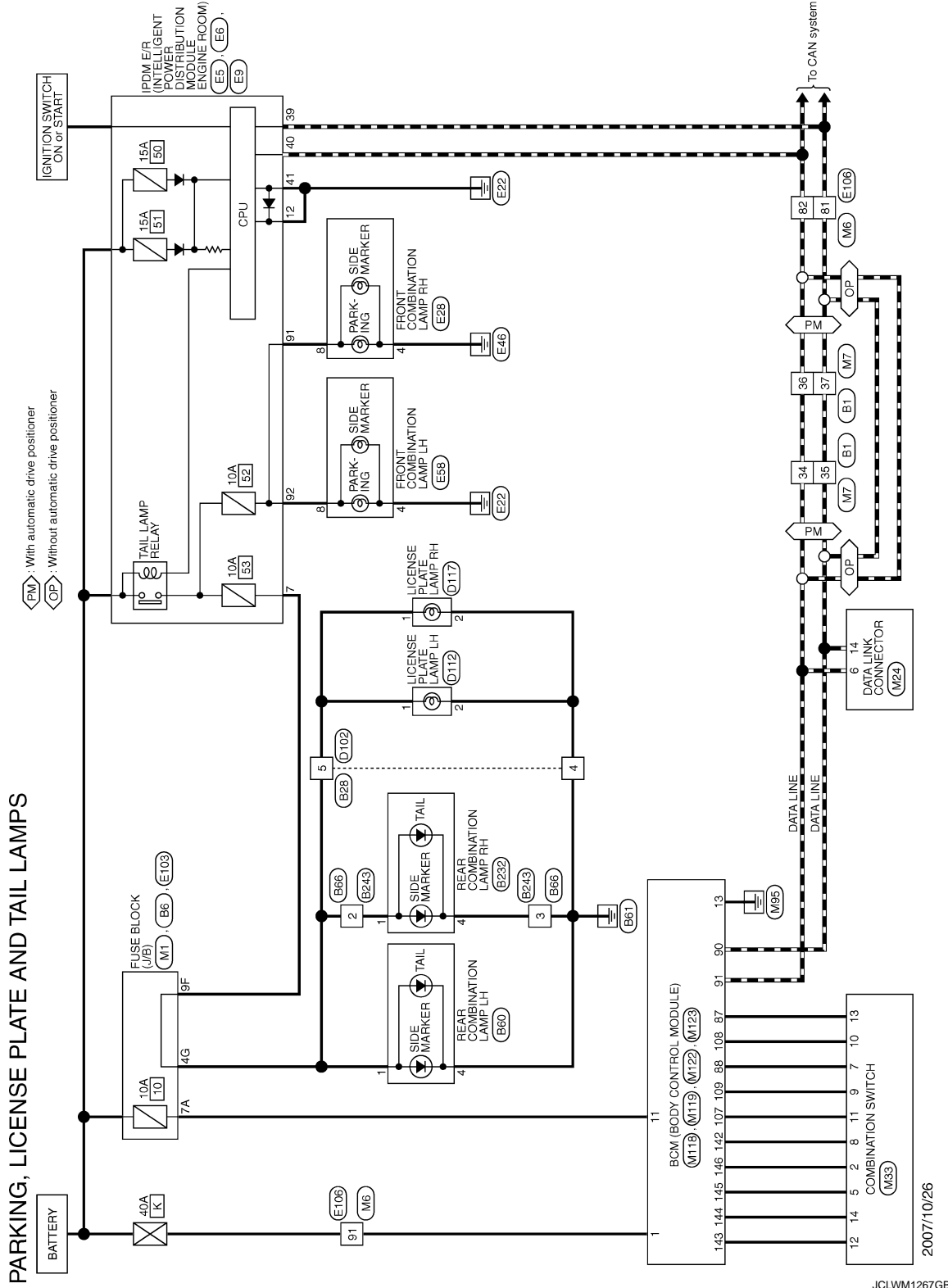



PARKING, LICENSE PLATE AND TAIL LAMPS SYSTEM

< COMPONENT DIAGNOSIS >

[XENON TYPE]



PARKING, LICENSE PLATE AND TAIL LAMPS

Connector No.	B60
Connector Name	REAR COMBINATION LAMP LH
Connector Type	TH04MW-NH

Terminal No.	Color of Wire	Signal Name [Specification]
1	R	
4	B	

Connector No.	B23
Connector Name	WIRE TO WIRE
Connector Type	TH24MW-NH



Terminal No.	Color of Wire	Signal Name [Specification]
4	B	
5	R	

Connector No.	B6
Connector Name	FUSE BLOCK (J/B)
Connector Type	NS17PER-CS

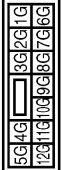

Terminal No.	Color of Wire	Signal Name [Specification]
4G	R	

Connector No.	B1
Connector Name	WIRE TO WIRE
Connector Type	TH07V-CS16-TM4

Terminal No.	Color of Wire	Signal Name [Specification]
34	L	
35	P	
36	L	
37	P	

Connector No.	D102
Connector Name	WIRE TO WIRE
Connector Type	TH24FW-NH



Terminal No.	Color of Wire	Signal Name [Specification]
4	B	
5	R	

Connector No.	B243
Connector Name	WIRE TO WIRE
Connector Type	TH24FW-NH

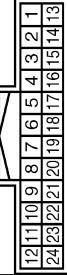
Terminal No.	Color of Wire	Signal Name [Specification]
2	R	
3	B	

Connector No.	B232
Connector Name	REAR COMBINATION LAMP RH
Connector Type	TH04MW-NH

Terminal No.	Color of Wire	Signal Name [Specification]
1	R	
4	B	

Connector No.	B66
Connector Name	WIRE TO WIRE
Connector Type	TH24MW-NH

Terminal No.	Color of Wire	Signal Name [Specification]
2	R	
3	B	

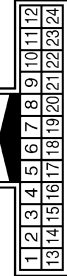
A
B
C
D
E
F
G
H
I
J
K
EXL
M
N
O
P

JCLWM1268GE

PARKING, LICENSE PLATE AND TAIL LAMPS SYSTEM

< COMPONENT DIAGNOSIS >

[XENON TYPE]

PARKING, LICENSE PLATE AND TAIL LAMPS

Connector No.	D12
Connector Name	LICENSE PLATE LAMP LH
Connector Type	TK02FBR



Terminal No.	Color of Wire	Signal Name [Specification]
1	R	-
2	B	-

Connector No.	D17
Connector Name	LICENSE PLATE LAMP RH
Connector Type	TK02FBR



Terminal No.	Color of Wire	Signal Name [Specification]
1	R	-
2	B	-

Connector No.	E5
Connector Name	IPDM E/R (INTELLIGENT POWER DISTRIBUTION MODULE ENGINE ROOM)
Connector Type	TH08FW-GS12-M4-IV



Terminal No.	Color of Wire	Signal Name [Specification]
7	R	-
12	B/W	-

Connector No.	E6
Connector Name	IPDM E/R (INTELLIGENT POWER DISTRIBUTION MODULE ENGINE ROOM)
Connector Type	TH08FW-NH



Terminal No.	Color of Wire	Signal Name [Specification]
39	P	-
40	L	-
41	B/W	-

Connector No.	E3
Connector Name	IPDM E/R (INTELLIGENT POWER DISTRIBUTION MODULE ENGINE ROOM)
Connector Type	TH167V-NH



Terminal No.	Color of Wire	Signal Name [Specification]
91	P	-
92	O	-

Connector No.	E28
Connector Name	FRONT COMBINATION LAMP RH
Connector Type	RS08FB-PR



Terminal No.	Color of Wire	Signal Name [Specification]
4	B/W	-
8	P	-

Connector No.	E58
Connector Name	FRONT COMBINATION LAMP LH
Connector Type	RS08FB-PR



Terminal No.	Color of Wire	Signal Name [Specification]
4	B/W	-
8	O	-

Connector No.	E103
Connector Name	FUSE BLOCK (J/B)
Connector Type	NS16FW-CS

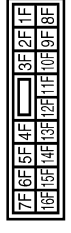

Terminal No.	Color of Wire	Signal Name [Specification]
9F	R	-

JCLWM1269GE

PARKING, LICENSE PLATE AND TAIL LAMPS SYSTEM

< COMPONENT DIAGNOSIS >

[XENON TYPE]

PARKING, LICENSE PLATE AND TAIL LAMPS

Connector No.	M7
Connector Name	WIRE TO WIRE
Connector Type	TH80MP-CS16-TM4

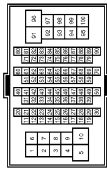

Terminal No.	Color of Wire	Signal Name [Specification]
34	L	-
35	P	-
36	L	-
37	P	-

Connector No.	M6
Connector Name	WIRE TO WIRE
Connector Type	TH80MP-CS16-TM4

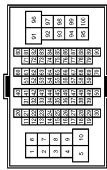

Terminal No.	Color of Wire	Signal Name [Specification]
81	P	-
82	L	-
91	W	-

Connector No.	M1
Connector Name	FUSE BLOCK (J/B)
Connector Type	NSGFPF-M2

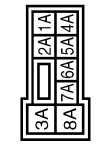

Terminal No.	Color of Wire	Signal Name [Specification]
7A	R	-

Connector No.	E106
Connector Name	WIRE TO WIRE
Connector Type	TH80FW-CS16-TM4

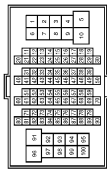

Terminal No.	Color of Wire	Signal Name [Specification]
81	P	-
82	L	-
91	W	-

Connector No.	M119
Connector Name	BCM (BODY CONTROL MODULE)
Connector Type	NS16FW-CS

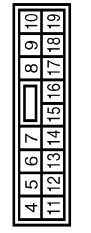

Terminal No.	Color of Wire	Signal Name [Specification]
11	R	BAT (FUSE)
13	B	GND

Connector No.	M118
Connector Name	BCM (BODY CONTROL MODULE)
Connector Type	MD3FB-LC



Terminal No.	Color of Wire	Signal Name [Specification]
1	W	BAT (F/L)

Connector No.	M33
Connector Name	COMBINATION SWITCH
Connector Type	TH16FW-NH



Terminal No.	Color of Wire	Signal Name [Specification]
2	SB	OUTPUT 4
5	L	OUTPUT 3
7	V	INPUT 3
8	O	OUTPUT 5
9	Y	INPUT 2
10	R	INPUT 4
11	LG	INPUT 1
12	P	OUTPUT 1
13	BR	INPUT 5
14	G	OUTPUT 2

Connector No.	M24
Connector Name	DATA LINK CONNECTOR
Connector Type	BD16FW

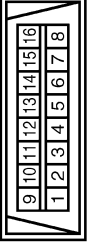

Terminal No.	Color of Wire	Signal Name [Specification]
6	L	-
14	P	-

JCLWM1270GE

A
B
C
D
E
F
G
H
I
J
K
EXL
M
N
O
P

PARKING, LICENSE PLATE AND TAIL LAMPS

< COMPONENT DIAGNOSIS >

[XENON TYPE]

PARKING, LICENSE PLATE AND TAIL LAMPS

Connector No.	M122
Connector Name	BCM (BODY CONTROL MODULE)
Connector Type	TH40FB-NH

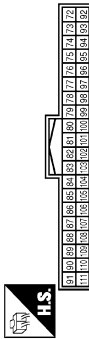

Terminal No.	Color of Wire	Signal Name [Specification]
87	BR	COMBI SW INPUT 5
88	V	COMBI SW INPUT 3
90	P	CAN-L
91	L	CAN-H
107	LG	COMBI SW INPUT 1
108	R	COMBI SW INPUT 4
109	Y	COMBI SW INPUT 2

Connector No.	M123
Connector Name	BCM (BODY CONTROL MODULE)
Connector Type	TH40FG-NH

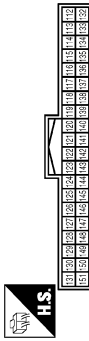

Terminal No.	Color of Wire	Signal Name [Specification]
142	O	COMBI SW OUTPUT 5
143	P	COMBI SW OUTPUT 1
144	G	COMBI SW OUTPUT 2
145	L	COMBI SW OUTPUT 3
146	SB	COMBI SW OUTPUT 4

JCLWM1271GE

STOP LAMP

< COMPONENT DIAGNOSIS >

[XENON TYPE]

STOP LAMP

Wiring Diagram - STOP LAMP -

INFOID:000000003135363

STOP LAMP

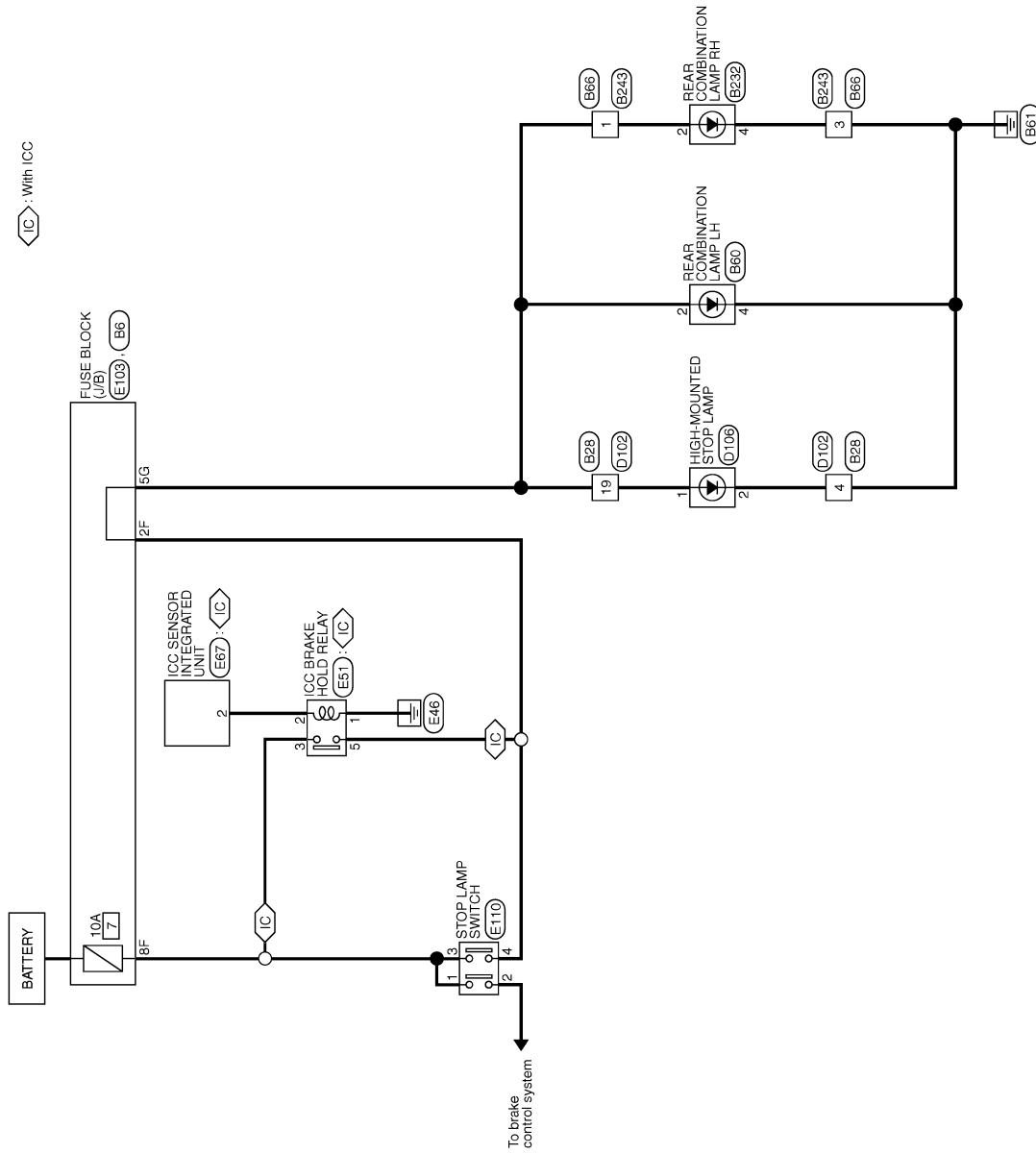

A
B
C
D
E
F
G
H
I
J
K
EXL
M
N
O
P

2007/10/26

JCLWM1261GE

STOP LAMP

< COMPONENT DIAGNOSIS >

[XENON TYPE]

STOP LAMP

Connector No. B6	FUSE BLOCK (J/B)	NS12FB-CS	5G4G 12G1G 10G9G8G7G6G	1 2 3 4 5 6 7 8 9 10 11 12 13 14 15 16 17 18 19 20 21 22 23 24	1 2 3 4 5 6 7 8 9 10 11 12 13 14 15 16 17 18 19 20 21 22 23 24	Connector No. B66	WIRE TO WIRE	TH2AMV-NH	1 2 3 4 5 6 7 8 9 10 11 12 13 14 15 16 17 18 19 20 21 22 23 24	Terminal No. 5G LG B	Color of Wire	Signal Name [Specification]
Connector No. B50	REAR COMBINATION LAMP LH	TH6AMV-NH	1 2 3 4	1 2 3 4	1 2 3 4	Connector No. B50	REAR COMBINATION LAMP LH	TH6AMV-NH	1 2 3 4	Terminal No. 2 4	Color of Wire LG B	Signal Name [Specification]
Connector No. B28	WIRE TO WIRE	TH2AMV-NH	1 2 3 4 5 6 7 8 9 10 11 12 13 14 15 16 17 18 19 20 21 22 23 24	1 2 3 4 5 6 7 8 9 10 11 12 13 14 15 16 17 18 19 20 21 22 23 24	1 2 3 4 5 6 7 8 9 10 11 12 13 14 15 16 17 18 19 20 21 22 23 24	Connector No. B28	WIRE TO WIRE	TH2AMV-NH	1 2 3 4 5 6 7 8 9 10 11 12 13 14 15 16 17 18 19 20 21 22 23 24	Terminal No. 4 19	Color of Wire B LG	Signal Name [Specification]
Connector No. B232	REAR COMBINATION LAMP RH	TH04MW-NH	1 2 3 4	1 2 3 4	1 2 3 4	Connector No. B232	REAR COMBINATION LAMP RH	TH04MW-NH	1 2 3 4	Terminal No. 2 4	Color of Wire LG B	Signal Name [Specification]
Connector No. D102	WIRE TO WIRE	TH24FW-NH	12 11 10 9 8 7 6 5 4 3 2 1 24 23 22 21 20 19 18 17 16 15 14 13	12 11 10 9 8 7 6 5 4 3 2 1 24 23 22 21 20 19 18 17 16 15 14 13	12 11 10 9 8 7 6 5 4 3 2 1 24 23 22 21 20 19 18 17 16 15 14 13	Connector No. D102	WIRE TO WIRE	TH24FW-NH	12 11 10 9 8 7 6 5 4 3 2 1 24 23 22 21 20 19 18 17 16 15 14 13	Terminal No. 4 19	Color of Wire B LG	Signal Name [Specification]
Connector No. D106	HIGH-MOUNTED STOP LAMP	TEB02MW	1 2	1 2	1 2	Connector No. D106	HIGH-MOUNTED STOP LAMP	TEB02MW	1 2	Terminal No. 1 2	Color of Wire LG B	Signal Name [Specification]









JCLWM1262GE

STOP LAMP

< COMPONENT DIAGNOSIS >

[XENON TYPE]

STOP LAMP

Connector No.	E110	Connector No.	E103	Connector No.	E67	Connector No.	E51
Connector Name	STOP LAMP SWITCH	Connector Name	FUSE BLOCK (L/B)	Connector Name	ICC SENSOR INTEGRATED UNIT	Connector Name	ICC BRAKE HOLD RELAY
Connector Type	MSAFW-LC	Connector Type	MS18FW-CS	Connector Type	RS0GFE-PR	Connector Type	MS02FL-MZ
							
Terminal No.	1 2 3 4	Terminal No.	2F 8F	Terminal No.	2	Terminal No.	1 2 3 5
Color of Wire	L SS L W	Color of Wire	W L	Color of Wire	V	Color of Wire	B V O P
Signal Name [Specification]	- - - -	Signal Name [Specification]	- -	Signal Name [Specification]	BRK LMP RLY	Signal Name [Specification]	- - - -

A
B
C
D
E
F
G
H
I
J
K
EXL
M
N
O
P

JCLWM1263GE

BACK-UP LAMP

< COMPONENT DIAGNOSIS >

[XENON TYPE]

BACK-UP LAMP

Wiring Diagram - BACK-UP LAMP -

INFOID:000000003135364

BACK-UP LAMP

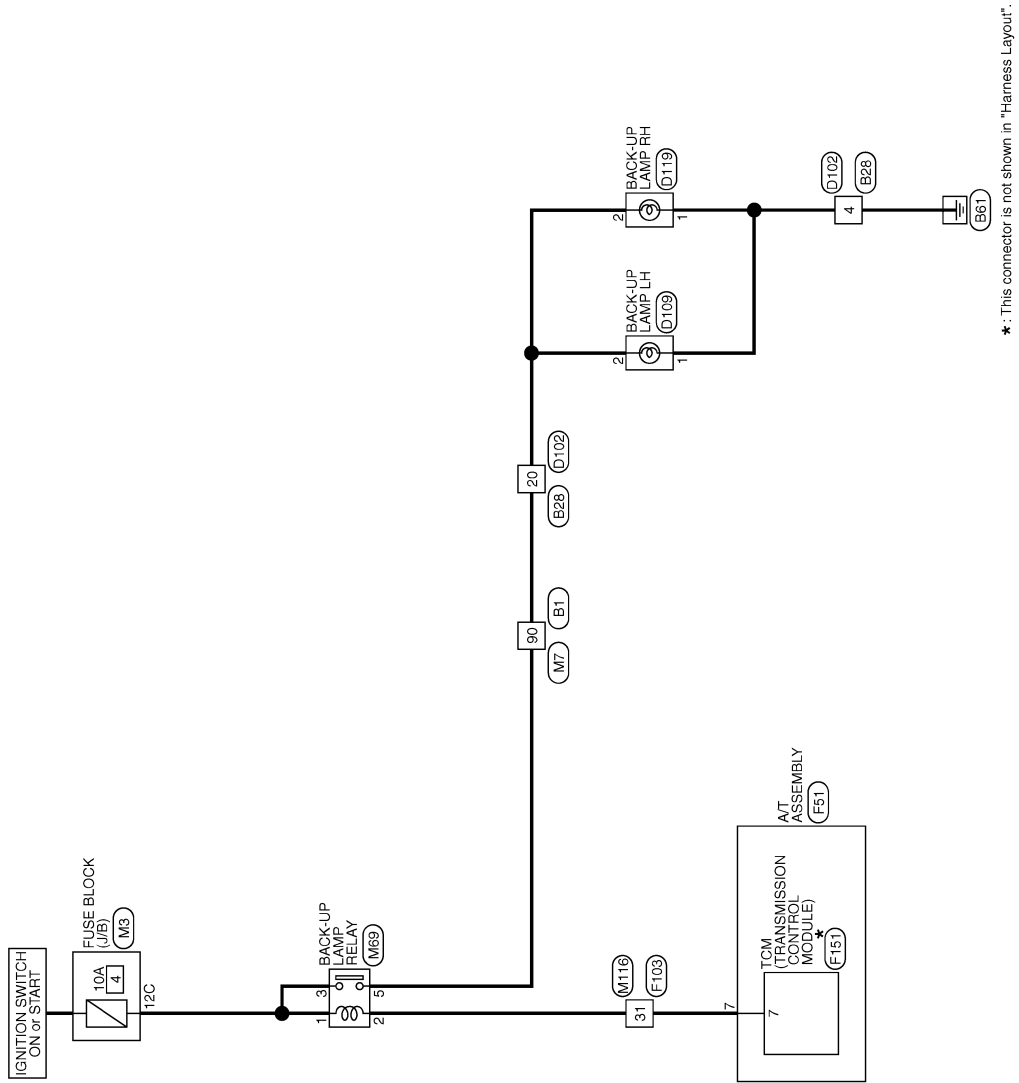

2007/10/26

JCLWM1264GE

BACK-UP LAMP

< COMPONENT DIAGNOSIS >

[XENON TYPE]

BACK-UP LAMP

Connector No.	B1	D109
Connector Name	WIRE TO WIRE	BACK-UP LAMP LH
Connector Type	TH8DFW-CS16-TM4	NS02MP-CS

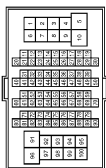

Terminal No.	90	Color of Wire	O	Signal Name [Specification]	-
--------------	----	---------------	---	-----------------------------	---

Connector No.	D102
Connector Name	WIRE TO WIRE
Connector Type	TH24FW-NH

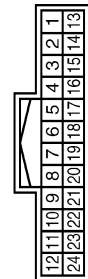

Terminal No.	4	Color of Wire	B	Signal Name [Specification]	-
	20	Color of Wire	O	Signal Name [Specification]	-

Connector No.	B28
Connector Name	WIRE TO WIRE
Connector Type	TH24MP-NH



Terminal No.	4	Color of Wire	B	Signal Name [Specification]	-
	20	Color of Wire	O	Signal Name [Specification]	-

Connector No.	D13
Connector Name	BACK-UP LAMP RH
Connector Type	NS02MW-CS



Terminal No.	1	Color of Wire	B	Signal Name [Specification]	-
	2	Color of Wire	O	Signal Name [Specification]	-

Connector No.	F103
Connector Name	WIRE TO WIRE
Connector Type	TK38FW-NS10

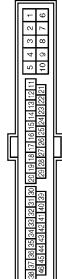

Terminal No.	31	Color of Wire	R	Signal Name [Specification]	-
--------------	----	---------------	---	-----------------------------	---

Connector No.	F151
Connector Name	TGM (TRANSMISSION CONTROL MODULE)
Connector Type	SP10FBGY



Terminal No.	7	Color of Wire	O	Signal Name [Specification]	REV LAMP RLY
--------------	---	---------------	---	-----------------------------	--------------

A
B
C
D
E
F
G
H
I
J
K
EXL
M
N
O
P

BACK-UP LAMP

< COMPONENT DIAGNOSIS >

[XENON TYPE]

BACK-UP LAMP

Connector No.	M116
Connector Name	WIRE TO WIRE
Connector Type	TK36MM-NS/D

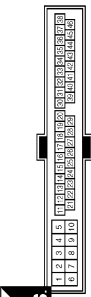

Terminal No.	Color of Wire	Signal Name [Specification]
31	W	-

Connector No.	M69
Connector Name	BACK-UP LAMP RELAY
Connector Type	MS2FEL-M2



Terminal No.	Color of Wire	Signal Name [Specification]
1	R	-
2	W	-
3	LG	-
5	O	-

Connector No.	M7
Connector Name	WIRE TO WIRE
Connector Type	TH6MM-CS(B)-TM4



Terminal No.	Color of Wire	Signal Name [Specification]
90	O	-

Connector No.	M3
Connector Name	FUSE BLOCK (J/B)
Connector Type	NS12FW-CS



Terminal No.	Color of Wire	Signal Name [Specification]
12C	O	-

JCLWM1266GE

BCM (BODY CONTROL MODULE)

< ECU DIAGNOSIS >

[XENON TYPE]

ECU DIAGNOSIS

BCM (BODY CONTROL MODULE)

Reference Value

INFOID:000000003784717

VALUES ON THE DIAGNOSIS TOOL

CONSULT-III MONITOR ITEM

Monitor Item	Condition	Value/Status
FR WIPER HI	Other than front wiper switch HI	Off
	Front wiper switch HI	On
FR WIPER LOW	Other than front wiper switch LO	Off
	Front wiper switch LO	On
FR WASHER SW	Front washer switch OFF	Off
	Front washer switch ON	On
FR WIPER INT	Other than front wiper switch INT	Off
	Front wiper switch INT	On
FR WIPER STOP	Front wiper is not in STOP position	Off
	Front wiper is in STOP position	On
INT VOLUME	Wiper intermittent dial is in a dial position 1 - 7	Wiper intermittent dial position
RR WIPER ON	Other than rear wiper switch ON	Off
	Rear wiper switch ON	On
RR WIPER INT	Other than rear wiper switch INT	Off
	Rear wiper switch INT	On
RR WASHER SW	Rear washer switch OFF	Off
	Rear washer switch ON	On
RR WIPER STOP	Rear wiper is in STOP position	Off
	Rear wiper is not in STOP position	On
TURN SIGNAL R	Other than turn signal switch RH	Off
	Turn signal switch RH	On
TURN SIGNAL L	Other than turn signal switch LH	Off
	Turn signal switch LH	On
TAIL LAMP SW	Other than lighting switch 1ST and 2ND	Off
	Lighting switch 1ST or 2ND	On
HI BEAM SW	Other than lighting switch HI	Off
	Lighting switch HI	On
HEAD LAMP SW 1	Other than lighting switch 2ND	Off
	Lighting switch 2ND	On
HEAD LAMP SW 2	Other than lighting switch 2ND	Off
	Lighting switch 2ND	On
PASSING SW	Other than lighting switch PASS	Off
	Lighting switch PASS	On
AUTO LIGHT SW	Other than lighting switch AUTO	Off
	Lighting switch AUTO	On
FR FOG SW	Front fog lamp switch OFF	Off
	Front fog lamp switch ON	On

BCM (BODY CONTROL MODULE)

< ECU DIAGNOSIS >

[XENON TYPE]

Monitor Item	Condition	Value/Status
RR FOG SW	NOTE: The item is indicated, but not monitored.	Off
DOOR SW-DR	Driver door closed	Off
	Driver door opened	On
DOOR SW-AS	Passenger door closed	Off
	Passenger door opened	On
DOOR SW-RR	Rear RH door closed	Off
	Rear RH door opened	On
DOOR SW-RL	Rear LH door closed	Off
	Rear LH door opened	On
DOOR SW-BK	Back door closed	Off
	Back door opened	On
CDL LOCK SW	Other than power door lock switch LOCK	Off
	Power door lock switch LOCK	On
CDL UNLOCK SW	Other than power door lock switch UNLOCK	Off
	Power door lock switch UNLOCK	On
KEY CYL LK-SW	Other than driver door key cylinder LOCK position	Off
	Driver door key cylinder LOCK position	On
KEY CYL UN-SW	Other than driver door key cylinder UNLOCK position	Off
	Driver door key cylinder UNLOCK position	On
KEY CYL SW-TR	NOTE: The item is indicated, but not monitored.	Off
HAZARD SW	Hazard switch is OFF	Off
	Hazard switch is ON	On
REAR DEF SW	NOTE: The item is indicated, but not monitored.	Off
TR CANCEL SW	NOTE: The item is indicated, but not monitored.	Off
TR/BD OPEN SW	Back door opener switch OFF	Off
	While the back door opener switch is turned ON	On
TRNK/HAT MNTR	NOTE: The item is indicated, but not monitored.	Off
RKE-LOCK	LOCK button of the key is not pressed	Off
	LOCK button of the key is pressed	On
RKE-UNLOCK	UNLOCK button of the key is not pressed	Off
	UNLOCK button of the key is pressed	On
RKE-TR/BD	NOTE: The item is indicated, but not monitored.	Off
RKE-PANIC	PANIC button of the key is not pressed	Off
	PANIC button of the key is pressed	On
RKE-P/W OPEN	UNLOCK button of the key is not pressed	Off
	UNLOCK button of the key is pressed and held	On
RKE-MODE CHG	LOCK/UNLOCK button of the key is not pressed and held simultaneously	Off
	LOCK/UNLOCK button of the key is pressed and held simultaneously	On

BCM (BODY CONTROL MODULE)

< ECU DIAGNOSIS >

[XENON TYPE]

Monitor Item	Condition	Value/Status	
OPTICAL SENSOR	Bright outside of the vehicle	Close to 5 V	A
	Dark outside of the vehicle	Close to 0 V	
REQ SW -DR	Driver door request switch is not pressed	Off	B
	Driver door request switch is pressed	On	
REQ SW -AS	Passenger door request switch is not pressed	Off	C
	Passenger door request switch is pressed	On	
REQ SW -RR	NOTE: The item is indicated, but not monitored.	Off	D
REQ SW -RL	NOTE: The item is indicated, but not monitored.	Off	D
REQ SW -BD/TR	Back door request switch is not pressed	Off	E
	Back door request switch is pressed	On	
PUSH SW	Push-button ignition switch (push switch) is not pressed	Off	F
	Push-button ignition switch (push switch) is pressed	On	
IGN RLY2 -F/B	Ignition switch in OFF or ACC position	Off	G
	Ignition switch in ON position	On	
CLUCH SW	NOTE: The item is indicated, but not monitored.	Off	G
BRAKE SW 1	The brake pedal is not depressed	On	H
	The brake pedal is depressed	Off	
DETE/CANCL SW	Selector lever in P position	Off	I
	Selector lever in any position other than P	On	
SFT PN/N SW	Selector lever in any position other than P and N	Off	J
	Selector lever in P or N position	On	
S/L -LOCK	Steering is locked	Off	J
	Steering is unlocked	On	
S/L -UNLOCK	Steering is unlocked	Off	K
	Steering is locked	On	
S/L RELAY-F/B	Ignition switch in OFF or ACC position	Off	EXL
	Ignition switch in ON position	On	
UNLK SEN -DR	Driver door is unlocked	Off	M
	Driver door is locked	On	
PUSH SW -IPDM	Push-button ignition switch (push-switch) is not pressed	Off	N
	Push-button ignition switch (push-switch) is pressed	On	
IGN RLY1 -F/B	Ignition switch in OFF or ACC position	Off	N
	Ignition switch in ON position	On	
DETE SW -IPDM	Selector lever in P position	Off	O
	Selector lever in any position other than P	On	
SFT PN -IPDM	Selector lever in any position other than P and N	Off	P
	Selector lever in P or N position	On	
SFT P -MET	Selector lever in any position other than P	Off	
	Selector lever in P position	On	
SFT N -MET	Selector lever in any position other than N	Off	
	Selector lever in N position	On	

BCM (BODY CONTROL MODULE)

< ECU DIAGNOSIS >

[XENON TYPE]

Monitor Item	Condition	Value/Status
ENGINE STATE	Engine stopped	Stop
	While the engine stalls	Stall
	At engine cranking	Crank
	Engine running	Run
S/L LOCK-IPDM	Steering is locked	Off
	Steering is unlocked	On
S/L UNLK-IPDM	Steering is unlocked	Off
	Steering is locked	On
S/L RELAY-REQ	Ignition switch in OFF or ACC position	Off
	Ignition switch in ON position	On
VEH SPEED 1	While driving	Equivalent to speedometer reading
VEH SPEED 2	While driving	Equivalent to speedometer reading
DOOR STAT-DR	Driver door is locked	LOCK
	Wait with selective UNLOCK operation (5 seconds)	READY
	Driver door is unlocked	UNLOCK
DOOR STAT-AS	Passenger door is locked	LOCK
	Wait with selective UNLOCK operation (5 seconds)	READY
	Passenger door is unlocked	UNLOCK
ID OK FLAG	Ignition switch in ACC or ON position	Reset
	Ignition switch in OFF position	Set
PRMT ENG STRT	The engine start is prohibited	Reset
	The engine start is permitted	Set
PRMT RKE STRT	NOTE: The item is indicated, but not monitored.	Reset
KEY SW -SLOT	The key is not inserted into key slot	Off
	The key is inserted into key slot	On
RKE OPE COUN1	During the operation of the key	Operation frequency of the key
RKE OPE COUN2	NOTE: The item is indicated, but not monitored.	—
CONFIRM ID ALL	The key ID that the key slot receives does not accord with any key ID registered to BCM.	Yet
	The key ID that the key slot receives accords with any key ID registered to BCM.	DONE
CONFIRM ID4	The key ID that the key slot receives does not accord with the fourth key ID registered to BCM.	Yet
	The key ID that the key slot receives accords with the fourth key ID registered to BCM.	DONE
CONFIRM ID3	The key ID that the key slot receives does not accord with the third key ID registered to BCM.	Yet
	The key ID that the key slot receives accords with the third key ID registered to BCM.	DONE
CONFIRM ID2	The key ID that the key slot receives does not accord with the second key ID registered to BCM.	Yet
	The key ID that the key slot receives accords with the second key ID registered to BCM.	DONE

BCM (BODY CONTROL MODULE)

< ECU DIAGNOSIS >

[XENON TYPE]

Monitor Item	Condition	Value/Status	
CONFIRM ID1	The key ID that the key slot receives does not accord with the first key ID registered to BCM.	Yet	A
	The key ID that the key slot receives accords with the first key ID registered to BCM.	DONE	B
TP 4	The ID of fourth key is not registered to BCM	Yet	C
	The ID of fourth key is registered to BCM	DONE	
TP 3	The ID of third key is not registered to BCM	Yet	D
	The ID of third key is registered to BCM	DONE	
TP 2	The ID of second key is not registered to BCM	Yet	E
	The ID of second key is registered to BCM	DONE	
TP 1	The ID of first key is not registered to BCM	Yet	F
	The ID of first key is registered to BCM	DONE	
AIR PRESS FL	Ignition switch ON (Only when the signal from the transmitter is received)	Air pressure of front LH tire	G
AIR PRESS FR	Ignition switch ON (Only when the signal from the transmitter is received)	Air pressure of front RH tire	H
AIR PRESS RR	Ignition switch ON (Only when the signal from the transmitter is received)	Air pressure of rear RH tire	I
AIR PRESS RL	Ignition switch ON (Only when the signal from the transmitter is received)	Air pressure of rear LH tire	J
ID REGST FL1	ID of front LH tire transmitter is registered	DONE	K
	ID of front LH tire transmitter is not registered	Yet	
ID REGST FR1	ID of front RH tire transmitter is registered	DONE	EXL
	ID of front RH tire transmitter is not registered	Yet	
ID REGST RR1	ID of rear RH tire transmitter is registered	DONE	M
	ID of rear RH tire transmitter is not registered	Yet	
ID REGST RL1	ID of rear LH tire transmitter is registered	DONE	N
	ID of rear LH tire transmitter is not registered	Yet	
WARNING LAMP	Tire pressure indicator OFF	Off	O
	Tire pressure indicator ON	On	
BUZZER	Tire pressure warning alarm is not sounding	Off	P
	Tire pressure warning alarm is sounding	On	

BCM (BODY CONTROL MODULE)

< ECU DIAGNOSIS >

[XENON TYPE]

TERMINAL LAYOUT

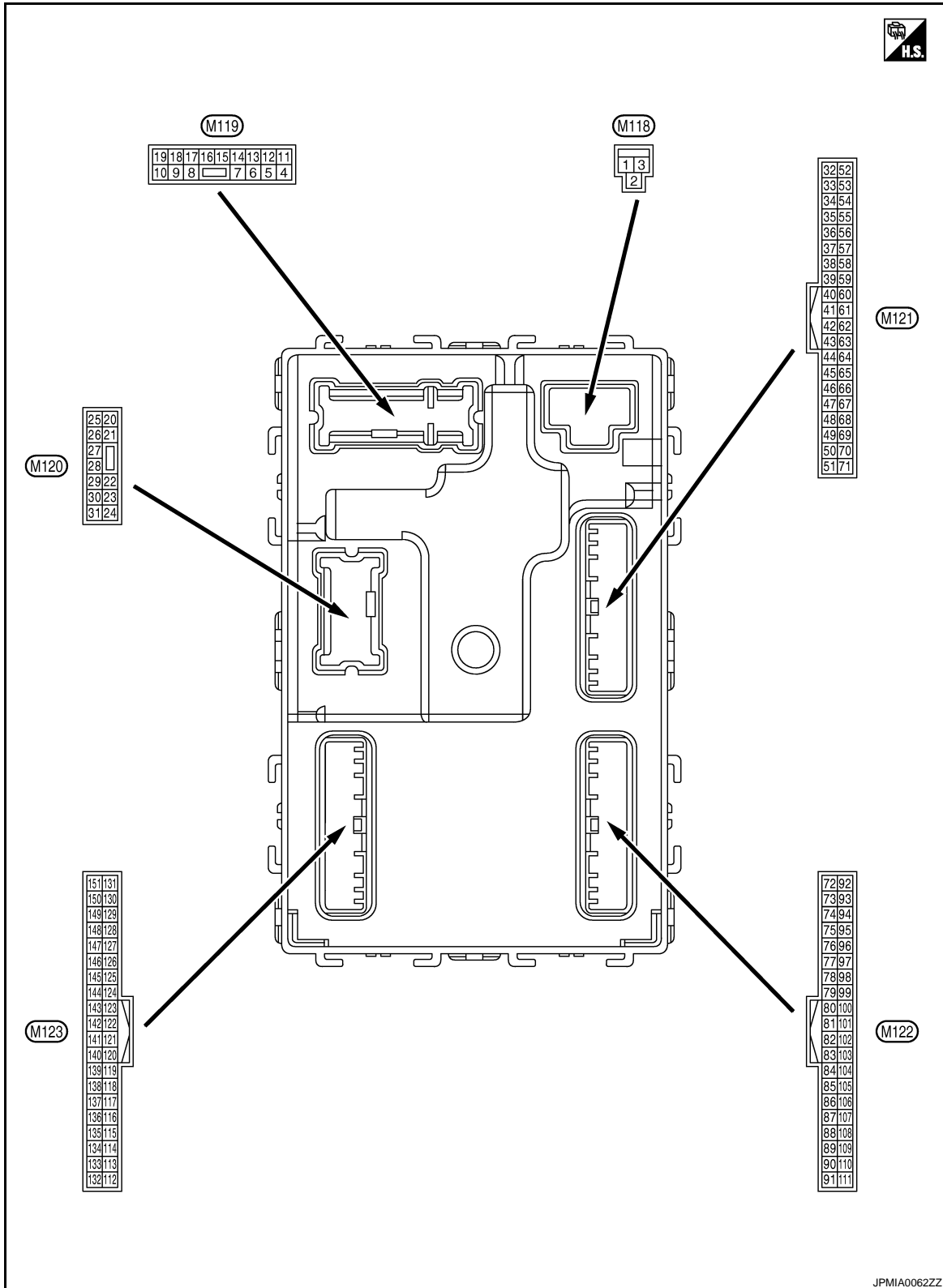

PHYSICAL VALUES

BCM (BODY CONTROL MODULE)

< ECU DIAGNOSIS >

[XENON TYPE]

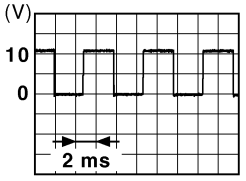
Terminal No. (Wire color)		Description		Condition		Value (Approx.)
		Signal name	Input/ Output			
+	-					
1 (W)	Ground	Battery power supply	Input	Ignition switch OFF		Battery voltage
2 (Y)	Ground	P/W power supply (BAT)	Output	Ignition switch OFF		Battery voltage
3 (O)	Ground	P/W power supply (RAP)	Output	Ignition switch ON		Battery voltage
4 (LG)	Ground	Interior room lamp power supply	Output	Interior room lamp battery saver is activated. (Cuts the interior room lamp power supply)		0 V
				Interior room lamp battery saver is not activated. (Outputs the interior room lamp power supply)		Battery voltage
5 (L)	Ground	Passenger door UN- LOCK	Output	Passenger door	UNLOCK (Actuator is activated)	Battery voltage
					Other than UNLOCK (Actuator is not activated)	0 V
7 (Y)	Ground	Step lamp	Output	Step lamp	ON	0 V
					OFF	Battery voltage
8 (V)	Ground	All doors, fuel lid LOCK	Output	All doors	LOCK (Actuator is activated)	Battery voltage
					Other than LOCK (Actuator is not activated)	0 V
9 (G)	Ground	Driver door, fuel lid UNLOCK	Output	Driver door	UNLOCK (Actuator is activated)	Battery voltage
					Other than UNLOCK (Actuator is not activated)	0 V
10 (BR)	Ground	Rear RH door and rear LH door UN- LOCK	Output	Rear RH door and rear LH door	UNLOCK (Actuator is activated)	Battery voltage
					Other than UNLOCK (Actuator is not activated)	0 V
11 (R)	Ground	Battery power supply	Input	Ignition switch OFF		Battery voltage
13 (B)	Ground	Ground	—	Ignition switch ON		0 V
14 (W)	Ground	Push-button ignition switch illumination ground	Output	Tail lamp	OFF	0 V
					ON	<p>NOTE: When the illumination brightening/dimming level is in the neutral position</p>  <p style="text-align: right; font-size: small;">JSNIA0010GB</p>
15 (Y)	Ground	ACC indicator lamp	Output	Ignition switch	OFF or ON	Battery voltage
					ACC	0 V

A
B
C
D
E
F
G
H
I
J
K
EXL
M
N
O
P

BCM (BODY CONTROL MODULE)

< ECU DIAGNOSIS >

[XENON TYPE]

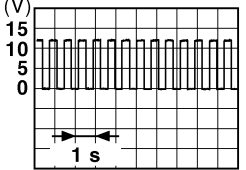
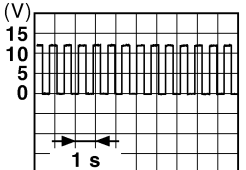
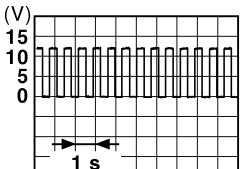
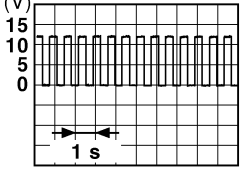
Terminal No. (Wire color)		Description		Condition		Value (Approx.)
+	-	Signal name	Input/ Output			
17 (W)	Ground	Turn signal RH (Front)	Output	Ignition switch ON	Turn signal switch OFF	0 V
					Turn signal switch RH	 <p style="text-align: right; font-size: small;">PKID0926E 6.5 V</p>
18 (O)	Ground	Turn signal LH (Front)	Output	Ignition switch ON	Turn signal switch OFF	0 V
					Turn signal switch LH	 <p style="text-align: right; font-size: small;">PKID0926E 6.5 V</p>
19 (V)	Ground	Room lamp timer control	Output	Interior room lamp	OFF	Battery voltage
					ON	0 V
20 (V)	Ground	Turn signal RH (Rear)	Output	Ignition switch ON	Turn signal switch OFF	0 V
					Turn signal switch RH	 <p style="text-align: right; font-size: small;">PKID0926E 6.5 V</p>
23 (G)	Ground	Back door opening	Output	Back door	OPEN (Back door opener actuator is activated)	Battery voltage
					Other than OPEN (Back door opener actuator is not activated)	0 V
25 (G)	Ground	Turn signal LH (Rear)	Output	Ignition switch ON	Turn signal switch OFF	0 V
					Turn signal switch LH	 <p style="text-align: right; font-size: small;">PKID0926E 6.5 V</p>
26 (G)	Ground	Rear wiper	Output	Rear wiper	OFF (Stopped)	0 V
					ON (Operated)	Battery voltage

BCM (BODY CONTROL MODULE)

< ECU DIAGNOSIS >

[XENON TYPE]

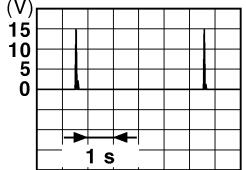
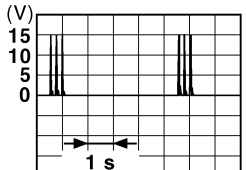
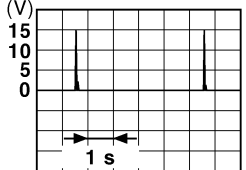
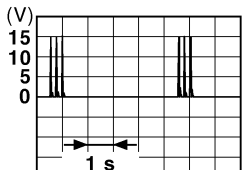
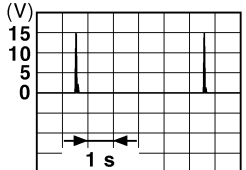
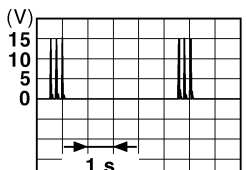
Terminal No. (Wire color)		Description		Condition	Value (Approx.)
+	-	Signal name	Input/ Output		
34 (SB)	Ground	Luggage room antenna 1 (-)	Output	Ignition switch OFF	 <p style="text-align: right; font-size: small;">JMKIA0062GB</p>
				When Intelligent Key is not in the passenger compartment	 <p style="text-align: right; font-size: small;">JMKIA0063GB</p>
35 (V)	Ground	Luggage room antenna 1 (+)	Output	Ignition switch OFF	 <p style="text-align: right; font-size: small;">JMKIA0062GB</p>
				When Intelligent Key is not in the passenger compartment	 <p style="text-align: right; font-size: small;">JMKIA0063GB</p>
38 (B)	Ground	Rear bumper antenna (-)	Output	When the back door request switch is operated with ignition switch OFF	 <p style="text-align: right; font-size: small;">JMKIA0062GB</p>
				When Intelligent Key is not in the antenna detection area	 <p style="text-align: right; font-size: small;">JMKIA0063GB</p>

A
B
C
D
E
F
G
H
I
J
K
EXL
M
N
O
P

BCM (BODY CONTROL MODULE)

< ECU DIAGNOSIS >

[XENON TYPE]

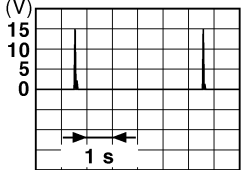
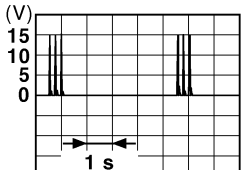
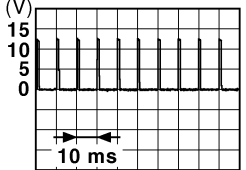
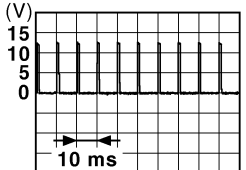
Terminal No. (Wire color)		Description		Condition		Value (Approx.)
+	-	Signal name	Input/ Output			
39 (W)	Ground	Rear bumper antenna (+)	Output	When the back door request switch is operated with ignition switch OFF	When Intelligent Key is in the antenna detection area	
					When Intelligent Key is not in the antenna detection area	
47 (Y)	Ground	Ignition relay (IPDM E/R) control	Output	Ignition switch	OFF or ACC	Battery voltage
					ON	0 V
52 (SB)	Ground	Starter relay control	Output	Ignition switch ON	When selector lever is in P or N position	Battery voltage
					When selector lever is not in P or N position	0 V
61 (W)	Ground	Back door opener request switch	Input	Back door request switch	ON (Pressed)	0 V
					OFF (Not pressed)	 <p style="text-align: center;">1.0 V</p>
64 (V)	Ground	Request switch buzzer	Output	Request switch buzzer	Sounding	0 V
					Not sounding	Battery voltage
65 (O)	Ground	Rear wiper stop position	Input	Rear wiper	In stop position	 <p style="text-align: center;">1.0 V</p>
					Not in stop position	0 V

BCM (BODY CONTROL MODULE)

< ECU DIAGNOSIS >

[XENON TYPE]

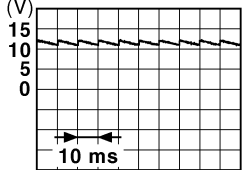
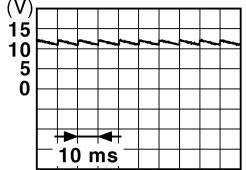
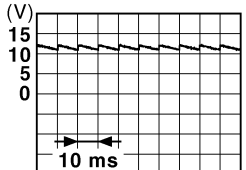
Terminal No. (Wire color)		Description		Condition	Value (Approx.)
		Signal name	Input/ Output		
+	-				
66 (R)	Ground	Back door switch	Input	Back door switch	OFF (Door close)  <small>JPMIA0011GB</small> 11.8 V
					ON (Door open)
67 (GR)	Ground	Back door opener switch	Input	Back door opener switch	Pressed 0 V
					Not pressed
68 (BR)	Ground	Rear RH door switch	Input	Rear RH door switch	OFF (Door close)  <small>JPMIA0011GB</small> 11.8 V
					ON (Door open)
69 (R)	Ground	Rear LH door switch	Input	Rear LH door switch	OFF (Door close)  <small>JPMIA0011GB</small> 11.8 V
					ON (Door open)

A
B
C
D
E
F
G
H
I
J
K
L
M
N
O
P

EXL

BCM (BODY CONTROL MODULE)

< ECU DIAGNOSIS >

[XENON TYPE]

Terminal No. (Wire color)		Description		Condition	Value (Approx.)
+	-	Signal name	Input/ Output		
72 (R)	Ground	Room antenna 2 (-) (Center console)	Output	Ignition switch OFF	<p style="text-align: right; font-size: small;">JMKIA0062GB</p>
				When Intelligent Key is not in the passenger compart- ment	<p style="text-align: right; font-size: small;">JMKIA0063GB</p>
73 (G)	Ground	Room antenna 2 (+) (Center console)	Output	Ignition switch OFF	<p style="text-align: right; font-size: small;">JMKIA0062GB</p>
				When Intelligent Key is not in the passenger compart- ment	<p style="text-align: right; font-size: small;">JMKIA0063GB</p>
74 (SB)	Ground	Passenger door an- tenna (-)	Output	When the pas- senger door re- quest switch is operated with ig- nition switch OFF	<p style="text-align: right; font-size: small;">JMKIA0062GB</p>
				When Intelligent Key is not in the antenna detection area	<p style="text-align: right; font-size: small;">JMKIA0063GB</p>

BCM (BODY CONTROL MODULE)

< ECU DIAGNOSIS >

[XENON TYPE]

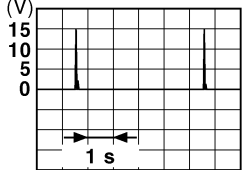
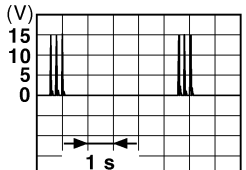
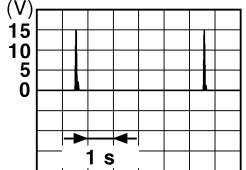
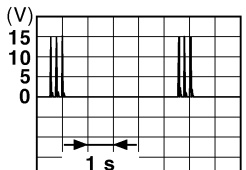
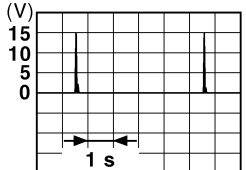
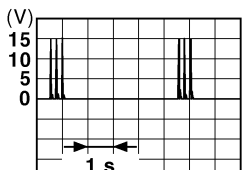
Terminal No. (Wire color)		Description		Condition	Value (Approx.)
		Signal name	Input/ Output		
+	-				
75 (GR)	Ground	Passenger door antenna (+)	Output	When Intelligent Key is in the antenna detection area	 <p style="text-align: right; font-size: small;">JMKIA0062GB</p>
				When the passenger door request switch is operated with ignition switch OFF	 <p style="text-align: right; font-size: small;">JMKIA0063GB</p>
76 (V)	Ground	Driver door antenna (-)	Output	When Intelligent Key is in the antenna detection area	 <p style="text-align: right; font-size: small;">JMKIA0062GB</p>
				When the driver door request switch is operated with ignition switch OFF	 <p style="text-align: right; font-size: small;">JMKIA0063GB</p>
77 (LG)	Ground	Driver door antenna (+)	Output	When Intelligent Key is in the antenna detection area	 <p style="text-align: right; font-size: small;">JMKIA0062GB</p>
				When the driver door request switch is operated with ignition switch OFF	 <p style="text-align: right; font-size: small;">JMKIA0063GB</p>

A
B
C
D
E
F
G
H
I
J
K
M
N
O
P

EXL

BCM (BODY CONTROL MODULE)

< ECU DIAGNOSIS >

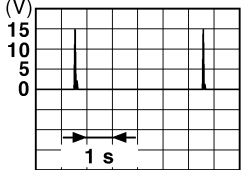
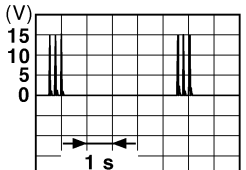
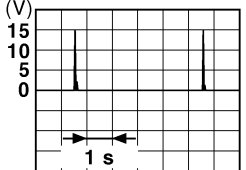
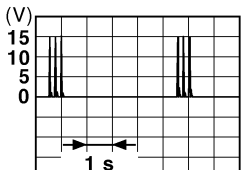

[XENON TYPE]

Terminal No. (Wire color)		Description		Condition	Value (Approx.)
+	-	Signal name	Input/ Output		
78 (Y)	Ground	Room antenna (-) (Instrument panel)	Output	Ignition switch OFF	When Intelligent Key is in the passenger compart- ment  <small>JMKIA0062GB</small>
				Ignition switch OFF	When Intelligent Key is not in the passenger compart- ment  <small>JMKIA0063GB</small>
79 (BR)	Ground	Room antenna (+) (Instrument panel)	Output	Ignition switch OFF	When Intelligent Key is in the passenger compart- ment  <small>JMKIA0062GB</small>
				Ignition switch OFF	When Intelligent Key is not in the passenger compart- ment  <small>JMKIA0063GB</small>
80 (GR)	Ground	NATS antenna amp (Built in key slot)	Input/ Output	During waiting	Ignition switch is pressed while inserting the key into the key slot. Just after pressing ignition switch. Pointer of tester should move.
81 (W)	Ground	NATS antenna amp (Built in key slot)	Input/ Output	During waiting	Ignition switch is pressed while inserting the key into the key slot. Just after pressing ignition switch. Pointer of tester should move.
82 (R)	Ground	Ignition relay [Fuse block (J/B)] control	Output	Ignition switch	OFF or ACC 0 V
				ON	Battery voltage

BCM (BODY CONTROL MODULE)

< ECU DIAGNOSIS >

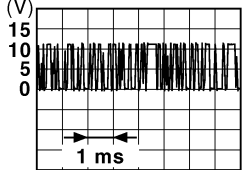
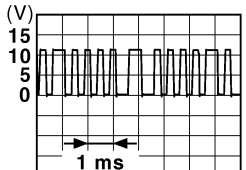
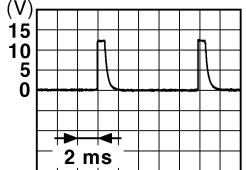
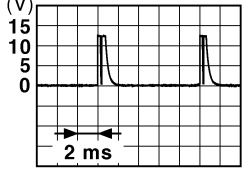
[XENON TYPE]

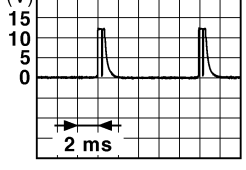

Terminal No. (Wire color)		Description		Condition	Value (Approx.)	
		Signal name	Input/ Output			
+	-					
83 (Y)	Ground	Remote keyless entry receiver signal	Input/ Output	During waiting	 <small>JMKIA0064GB</small>	
				When operating either button on the key	 <small>JMKIA0065GB</small>	
87 (BR)	Ground	Combination switch INPUT 5	Input	Combination switch	All switch OFF (Wiper intermittent dial 4)	 <small>JPMIA0041GB</small> 1.4 V
					Front fog lamp switch ON (Wiper intermittent dial 4)	 <small>JPMIA0037GB</small> 1.3 V
					Rear wiper switch ON (Wiper intermittent dial 4)	 <small>JPMIA0039GB</small> 1.3 V
					Any of the conditions below with all switch OFF <ul style="list-style-type: none"> • Wiper intermittent dial 1 • Wiper intermittent dial 2 • Wiper intermittent dial 6 • Wiper intermittent dial 7 	 <small>JPMIA0040GB</small> 1.3 V

A
B
C
D
E
F
G
H
I
J
K
EXL
M
N
O
P

BCM (BODY CONTROL MODULE)

< ECU DIAGNOSIS >

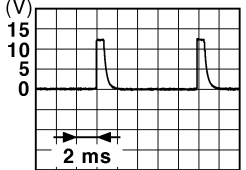
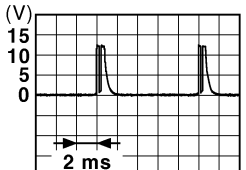
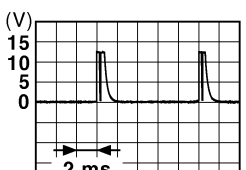
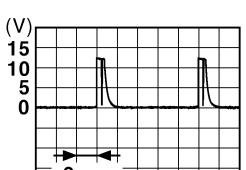
[XENON TYPE]

Terminal No. (Wire color)		Description		Condition	Value (Approx.)	
+	-	Signal name	Input/ Output			
88 (V)	Ground	Combination switch INPUT 3	Input	Combination switch	All switch OFF (Wiper intermittent dial 4)	 <small>JPMIA0041GB</small> 1.4 V
					Lighting switch HI (Wiper intermittent dial 4)	 <small>JPMIA0036GB</small> 1.3 V
					Lighting switch 2ND (Wiper intermittent dial 4)	 <small>JPMIA0037GB</small> 1.3 V
					Rear washer switch ON (Wiper intermittent dial 4)	 <small>JPMIA0039GB</small> 1.3 V
					Any of the conditions below with all switch OFF • Wiper intermittent dial 1 • Wiper intermittent dial 2 • Wiper intermittent dial 3	 <small>JPMIA0040GB</small> 1.3 V
89 (BR)	Ground	Push-button ignition switch (Push switch)	Input	Push-button igni- tion switch (push switch)	Pressed Not pressed	0 V Battery voltage
90 (P)	Ground	CAN-L	Input/ Output	—	—	—
91 (L)	Ground	CAN-H	Input/ Output	—	—	—

BCM (BODY CONTROL MODULE)

< ECU DIAGNOSIS >

[XENON TYPE]

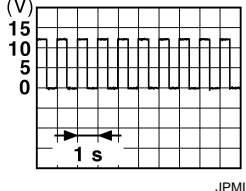
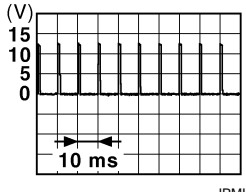
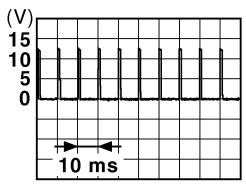
Terminal No. (Wire color)		Description		Condition	Value (Approx.)	
		Signal name	Input/ Output			
+	-					
92 (LG)	Ground	Key slot illumination	Output	Key slot illumination	OFF	Battery voltage
					Blinking	 <p style="text-align: center;">6.5 V</p>
					ON	0 V
93 (V)	Ground	ON indicator lamp	Output	Ignition switch	OFF or ACC	Battery voltage
					ON	0 V
94 (Y)	Ground	Puddle lamp control	Output	Puddle lamp	OFF	Battery voltage
					ON	0 V
95 (O)	Ground	ACC relay control	Output	Ignition switch	OFF	0 V
					ACC or ON	Battery voltage
96 (GR)	Ground	Control device (De- tention switch) power supply	Output	—	Battery voltage	
97 (L)	Ground	Steering lock condi- tion No. 1	Input	Steering lock	LOCK status	0 V
					UNLOCK status	Battery voltage
98 (P)	Ground	Steering lock condi- tion No. 2	Input	Steering lock	LOCK status	Battery voltage
					UNLOCK status	0 V
99 (R)	Ground	Selector lever P posi- tion switch	Input	Selector lever	P position	0 V
					Any position other than P	Battery voltage
100 (G)	Ground	Passenger door re- quest switch	Input	Passenger door request switch	ON (Pressed)	0 V
					OFF (Not pressed)	 <p style="text-align: center;">1.0 V</p>
101 (SB)	Ground	Driver door request switch	Input	Driver door re- quest switch	ON (Pressed)	0 V
					OFF (Not pressed)	 <p style="text-align: center;">1.0 V</p>
102 (O)	Ground	Blower fan motor re- lay control	Output	Ignition switch	OFF or ACC	0 V
					ON	Battery voltage



A
B
C
D
E
F
G
H
I
J
K
L
M
N
O
P

EXL

BCM (BODY CONTROL MODULE)

< ECU DIAGNOSIS >

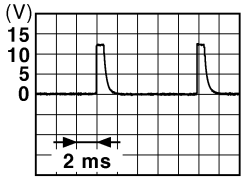
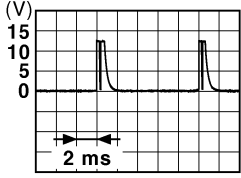
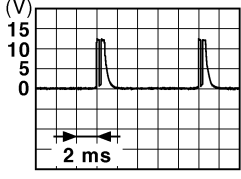
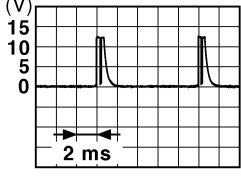



[XENON TYPE]

Terminal No. (Wire color)		Description		Condition		Value (Approx.)
+	-	Signal name	Input/ Output			
103 (LG)	Ground	Remote keyless entry receiver power supply	Output	Ignition switch OFF		Battery voltage
106 (W)	Ground	Steering wheel lock unit power supply	Output	Ignition switch	OFF or ACC	Battery voltage
					ON	0 V
107 (LG)	Ground	Combination switch INPUT 1	Input	Combination switch (Wiper intermittent dial 4)	All switch OFF	 <p style="text-align: right; font-size: small;">JPMIA0041GB</p> <p style="text-align: center;">1.4 V</p>
					Turn signal switch LH	 <p style="text-align: right; font-size: small;">JPMIA0037GB</p> <p style="text-align: center;">1.3 V</p>
					Turn signal switch RH	 <p style="text-align: right; font-size: small;">JPMIA0036GB</p> <p style="text-align: center;">1.3 V</p>
					Front wiper switch LO	 <p style="text-align: right; font-size: small;">JPMIA0038GB</p> <p style="text-align: center;">1.3 V</p>
					Front washer switch ON	 <p style="text-align: right; font-size: small;">JPMIA0039GB</p> <p style="text-align: center;">1.3 V</p>

BCM (BODY CONTROL MODULE)

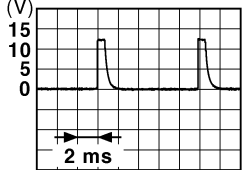
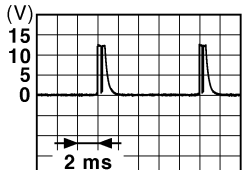
< ECU DIAGNOSIS >

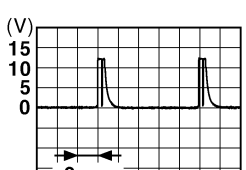
[XENON TYPE]



Terminal No. (Wire color)		Description		Condition	Value (Approx.)	
		Signal name	Input/ Output			
+	-					
108 (R)	Ground	Combination switch INPUT 4	Input	Combination switch	All switch OFF (Wiper intermittent dial 4)	 <small>JPMIA0041GB</small> 1.4 V
					Lighting switch AUTO (Wiper intermittent dial 4)	 <small>JPMIA0038GB</small> 1.3 V
					Lighting switch 1ST (Wiper intermittent dial 4)	 <small>JPMIA0036GB</small> 1.3 V
					Rear wiper switch INT (Wiper intermittent dial 4)	 <small>JPMIA0040GB</small> 1.3 V
					Any of the conditions below with all switch OFF • Wiper intermittent dial 1 • Wiper intermittent dial 5 • Wiper intermittent dial 6	 <small>JPMIA0039GB</small> 1.3 V

A
B
C
D
E
F
G
H
I
J
K
EXL
M
N
O
P

BCM (BODY CONTROL MODULE)

< ECU DIAGNOSIS >

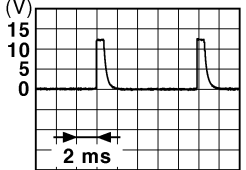
[XENON TYPE]

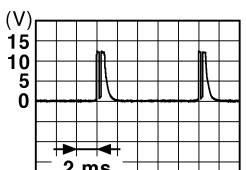
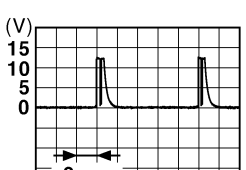
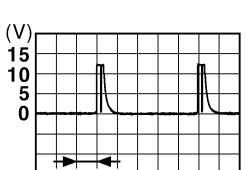
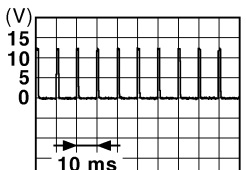
Terminal No. (Wire color)		Description		Condition	Value (Approx.)	
+	-	Signal name	Input/ Output			
109 (Y)	Ground	Combination switch INPUT 2	Input	Combination switch (Wiper intermittent dial 4)	All switch OFF	 1.4 V
					Lighting switch PASS	 1.3 V
					Lighting switch 2ND	 1.3 V
					Front wiper switch INT	 1.3 V
					Front wiper switch HI	 1.3 V
					ON	0 V
110 (G)	Ground	Hazard switch	Input	Hazard switch	OFF	
				OFF	 1.1 V	

BCM (BODY CONTROL MODULE)

< ECU DIAGNOSIS >

[XENON TYPE]

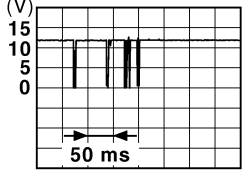
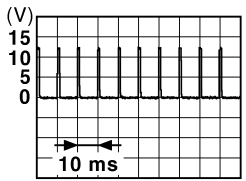
Terminal No. (Wire color)		Description		Condition	Value (Approx.)	
		Signal name	Input/ Output			
+	-					
111 (Y)	Ground	Steering lock unit communication	Input/ Output	Steering lock	LOCK status	Battery voltage
					LOCK or UNLOCK	 <p style="text-align: right; font-size: small;">JMKIA0066GB</p>
					For 15 seconds after UNLOCK	Battery voltage
					15 seconds or later after UNLOCK	0 V
113* (P)	Ground	Optical sensor signal	Input	Ignition switch ON	When bright outside of the vehicle	Close to 5 V
					When dark outside of the vehicle	Close to 0 V
116 (SB)	Ground	Fuse check [Stop lamp switch, ICC brake hold relay (With ICC)]	Input	—	Battery voltage	
118 (P)	Ground	Stop lamp switch (Without ICC)	Input	Stop lamp switch	OFF (Brake pedal is not depressed)	0 V
					ON (Brake pedal is depressed)	Battery voltage
		Stop lamp switch and ICC brake hold relay (With ICC)		Stop lamp switch OFF (Brake pedal is not depressed) and ICC brake hold relay OFF	0 V	
				Stop lamp switch ON (Brake pedal is depressed) or ICC brake hold relay ON	Battery voltage	
119 (SB)	Ground	Front door lock assembly driver side (unlock sensor)	Input	Driver door	LOCK status (Unlock sensor switch OFF)	 <p style="text-align: right; font-size: small;">JPMIA0012GB</p>
					UNLOCK status (Unlock switch sensor ON)	0 V
					EXL	
121 (BR)	Ground	Key slot switch	Input	When the key is inserted into key slot	Battery voltage	
				When the key is not inserted into key slot	0 V	
122 (V)	Ground	ACC feedback signal	Input	Ignition switch	OFF	0 V
					ACC or ON	Battery voltage
123 (W)	Ground	IGN feedback signal	Input	Ignition switch	OFF or ACC	0 V
					ON	Battery voltage

A
B
C
D
E
F
G
H
I
J
K
M
N
O
P

BCM (BODY CONTROL MODULE)

< ECU DIAGNOSIS >

[XENON TYPE]

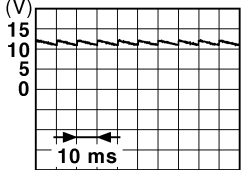
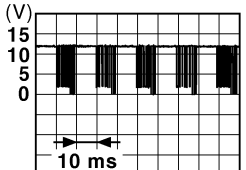
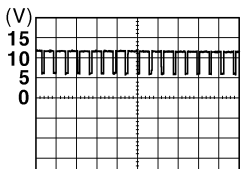
Terminal No. (Wire color)		Description		Condition		Value (Approx.)
+	-	Signal name	Input/ Output			
124 (LG)	Ground	Passenger door switch	Input	Passenger door switch	OFF (Door close)	 11.8 V
					ON (Door open)	0 V
132 (V)	Ground	Power window switch communication	Input/ Output	Ignition switch ON	 10.2 V	
				Ignition switch OFF or ACC	Battery voltage	
133 (W)	Ground	Push-button ignition switch illumination	Output	Push-button igni- tion switch illumina- tion	ON (Tail lamps OFF)	9.5 V
					ON (Tail lamps ON)	<p>NOTE: The pulse width of this wave is varied by the illumination bright- ening/dimming level.</p>  9.5 V
134 (GR)	Ground	LOCK indicator lamp	Output	LOCK indicator lamp	OFF	Battery voltage
					ON	0 V
137 (O)	Ground	Receiver and sensor ground	Input	Ignition switch ON		0 V
138 (Y)	Ground	Sensor power supply	Output	Ignition switch	OFF	0 V
					ACC or ON	5.0 V

BCM (BODY CONTROL MODULE)

< ECU DIAGNOSIS >

[XENON TYPE]

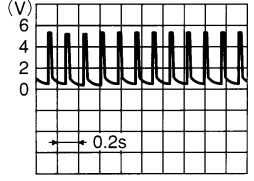
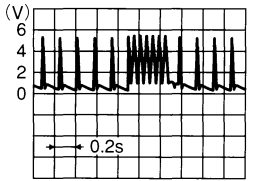
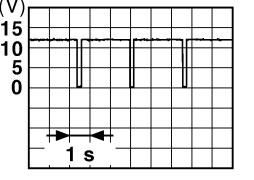
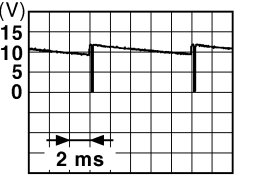
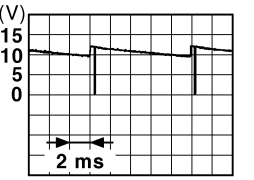
Terminal No. (Wire color)		Description		Condition	Value (Approx.)
		Signal name	Input/ Output		
+	-				
139 (L)	Ground	Tire pressure receiver signal	Input/ Output	Ignition switch ON	Standby state  OCC3881D
					When receiving the signal from the transmitter  OCC3880D
140 (GR)	Ground	Selector lever P/N position signal	Input	Selector lever	P or N position Battery voltage
					Except P and N positions 0 V
141 (G)	Ground	Security indicator signal	Output	Security indicator	ON 0 V
					Blinking  11.3 V JPMIA0014GB
					OFF Battery voltage
142 (O)	Ground	Combination switch OUTPUT 5	Output	Combination switch (Wiper intermittent dial 4)	All switch OFF 0 V
					Lighting switch 1ST  10.7 V JPMIA0031GB
					Lighting switch HI
					Lighting switch 2ND
				Turn signal switch RH	
143 (P)	Ground	Combination switch OUTPUT 1	Output	Combination switch	All switch OFF (Wiper intermittent dial 4) 0 V
					Front wiper switch HI (Wiper intermittent dial 4)  10.7 V JPMIA0032GB
					Rear wiper switch INT (Wiper intermittent dial 4)
					Any of the conditions below with all switch OFF • Wiper intermittent dial 1 • Wiper intermittent dial 2 • Wiper intermittent dial 3 • Wiper intermittent dial 6 • Wiper intermittent dial 7

A
B
C
D
E
F
G
H
I
J
K
L
M
N
O
P

EXL

BCM (BODY CONTROL MODULE)

< ECU DIAGNOSIS >

[XENON TYPE]

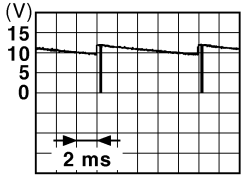
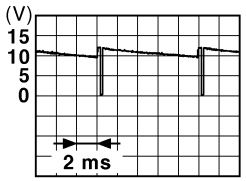
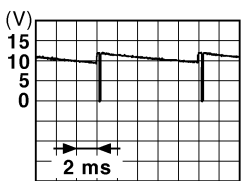
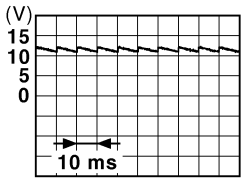
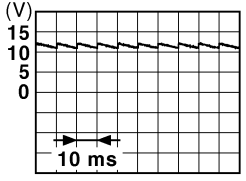
Terminal No. (Wire color)		Description		Condition	Value (Approx.)		
+	-	Signal name	Input/ Output				
144 (G)	Ground	Combination switch OUTPUT 2	Output	Combination switch	All switch OFF (Wiper intermittent dial 4)	0 V	
					Front washer switch ON (Wiper intermittent dial 4)		
					Rear wiper switch ON (Wiper intermittent dial 4)		
					Rear washer switch ON (Wiper intermittent dial 4)		
					Any of the conditions below with all switch OFF <ul style="list-style-type: none"> • Wiper intermittent dial 1 • Wiper intermittent dial 5 • Wiper intermittent dial 6 		
					10.7 V		
145 (L)	Ground	Combination switch OUTPUT 3	Output	Combination switch (Wiper intermit- tent dial 4)	All switch OFF	0 V	
					Front wiper switch INT		
					Front wiper switch LO		
					Lighting switch AUTO		
					10.7 V		
146 (SB)	Ground	Combination switch OUTPUT 4	Output	Combination switch (Wiper intermit- tent dial 4)	All switch OFF	0 V	
					Front fog lamp switch ON		
					Lighting switch 2ND		
					Lighting switch PASS		
					Turn signal switch LH		
					10.7 V		
149 (W)	Ground	Tire pressure warn- ing check switch	Input	Ignition switch ON		11.8 V	
150 (LG)	Ground	Driver door switch	Input	Driver door switch	OFF (Door close)		11.8 V
					ON (Door open)	0 V	
151 (G)	Ground	Rear window defog- ger relay	Output	Rear window de- fogger	Active	0 V	
					Not activated	Battery voltage	

BCM (BODY CONTROL MODULE)

[XENON TYPE]

< ECU DIAGNOSIS >

NOTE:

*: With auto light system

Wiring Diagram - BCM -

INFOID:000000003784718

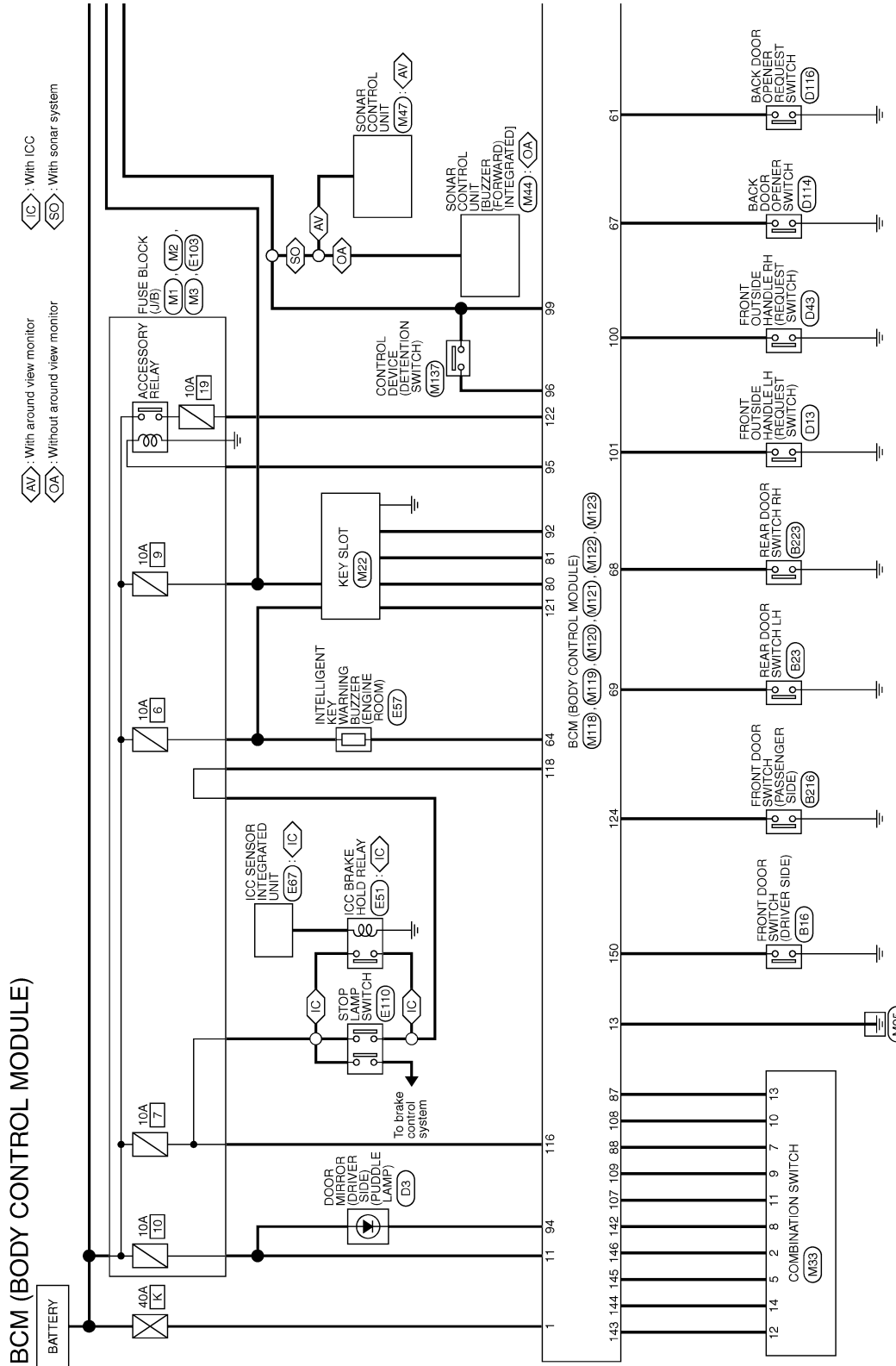

A
B
C
D
E
F
G
H
I
J
K
L
M
N
O
P

EXL

BCM (BODY CONTROL MODULE)

< ECU DIAGNOSIS >

[XENON TYPE]

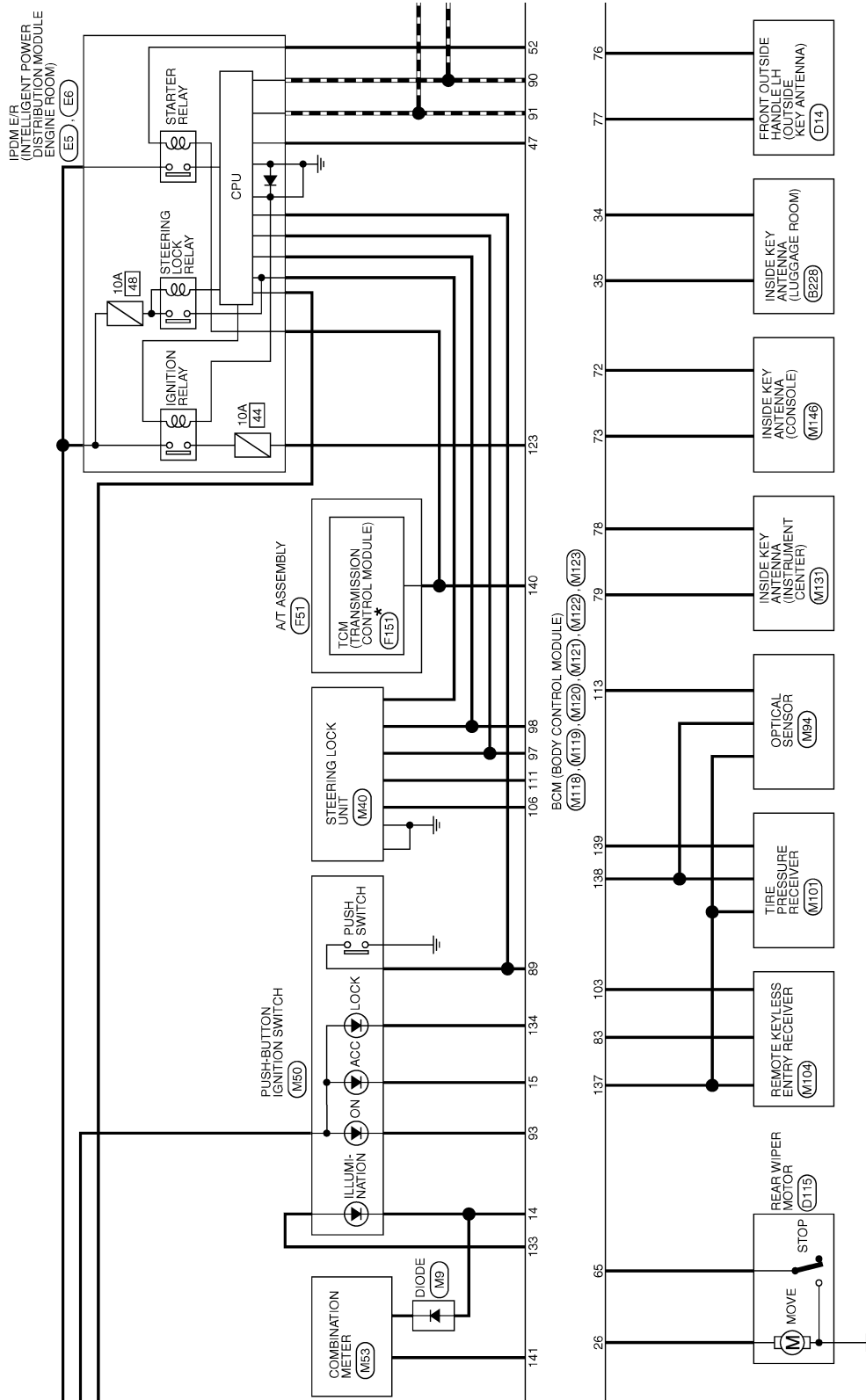

*: This connector is not shown in "Harness Layout".

JCMWM1399G

BCM (BODY CONTROL MODULE)

< ECU DIAGNOSIS >

[XENON TYPE]

- ◀ NV ▶ : With NAVI
- ◀ ON ▶ : Without NAVI
- ◀ RF ▶ : With sunroof
- ◀ PM ▶ : With automatic drive positioner
- ◀ OP ▶ : Without automatic drive positioner

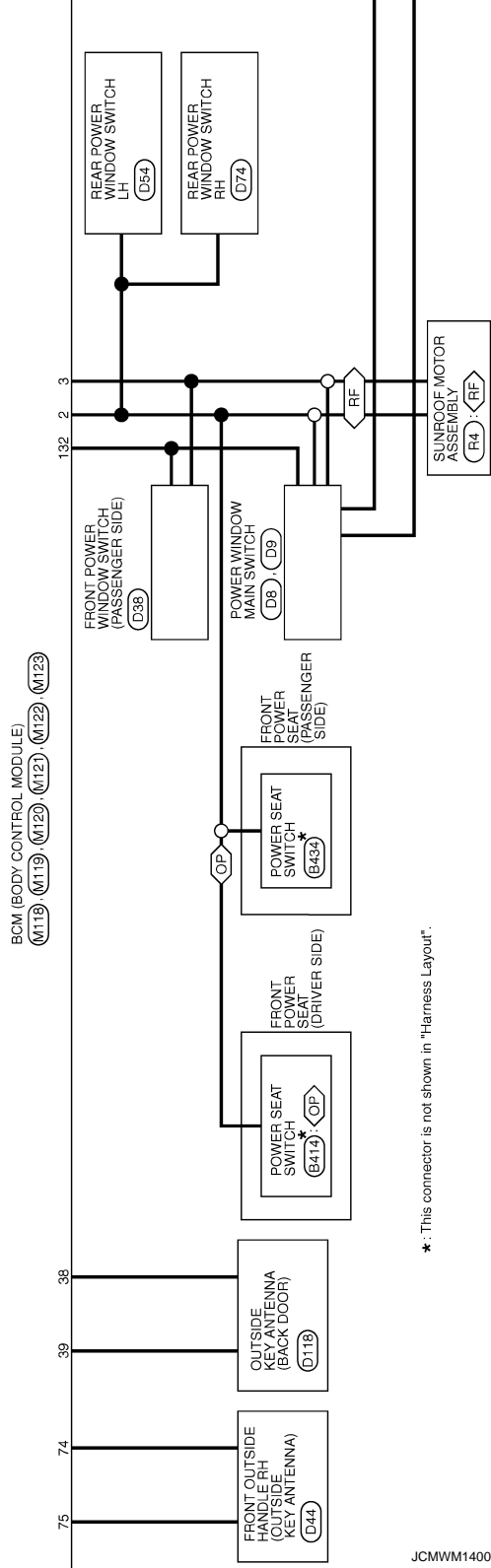
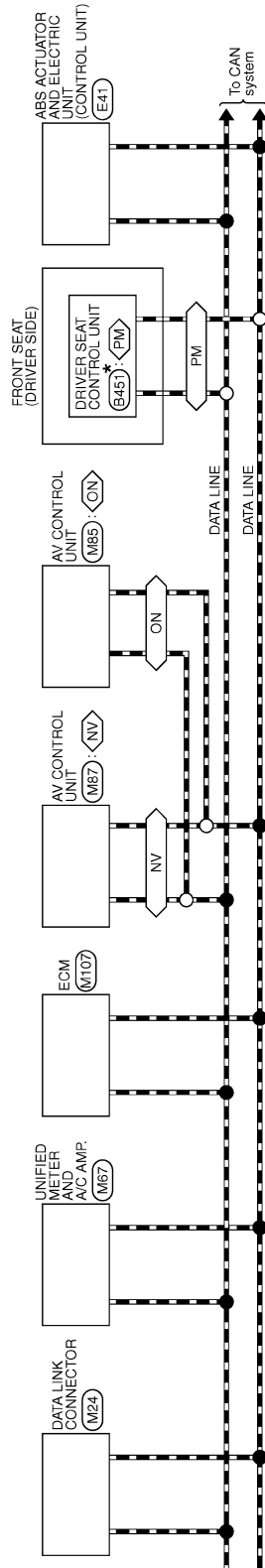

JCMWM1400G1

A
B
C
D
E
F
G
H
I
J
K
EXL
M
N
O
P

BCM (BODY CONTROL MODULE)

< ECU DIAGNOSIS >

[XENON TYPE]

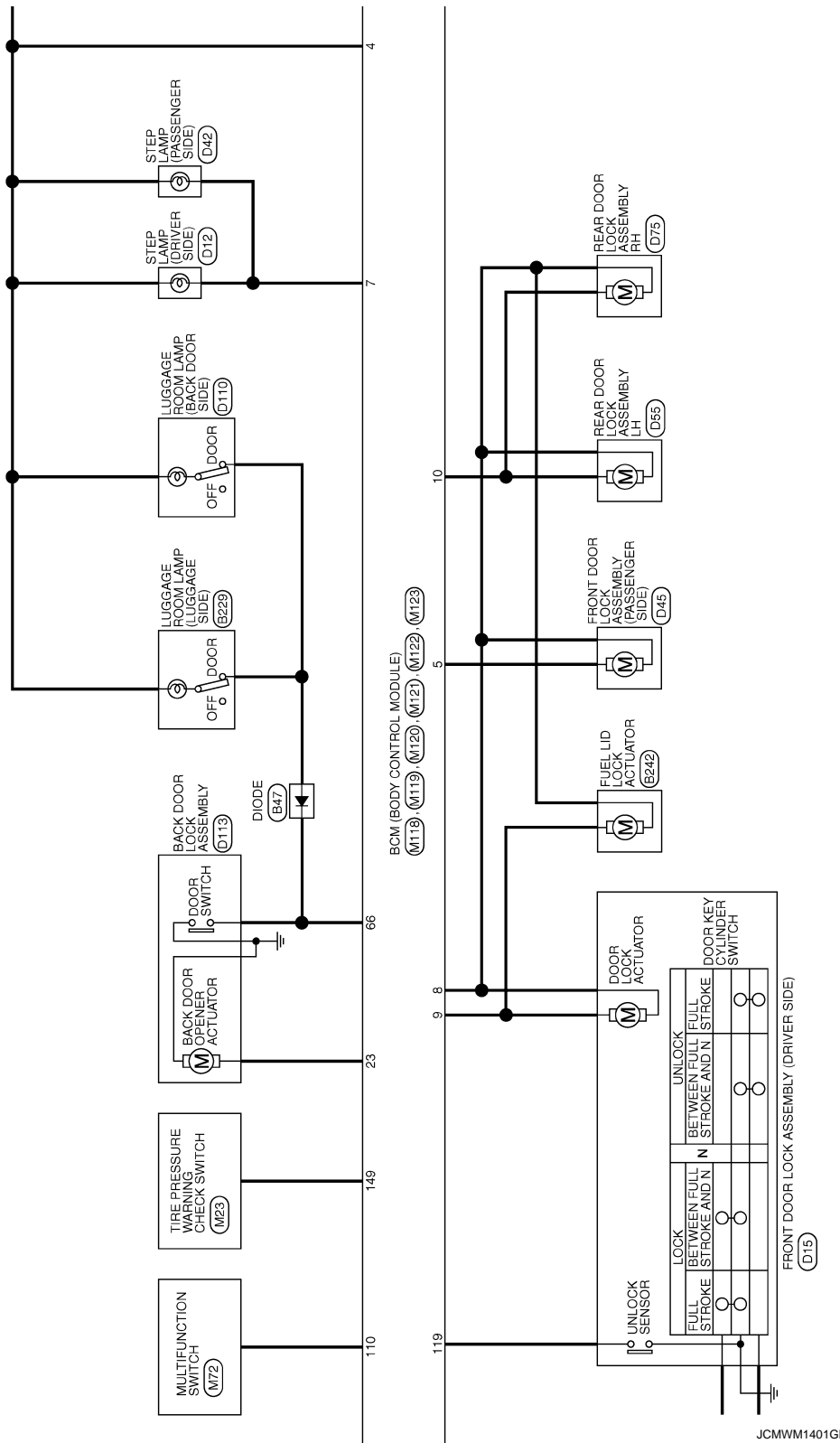

BCM (BODY CONTROL MODULE)

< ECU DIAGNOSIS >

[XENON TYPE]

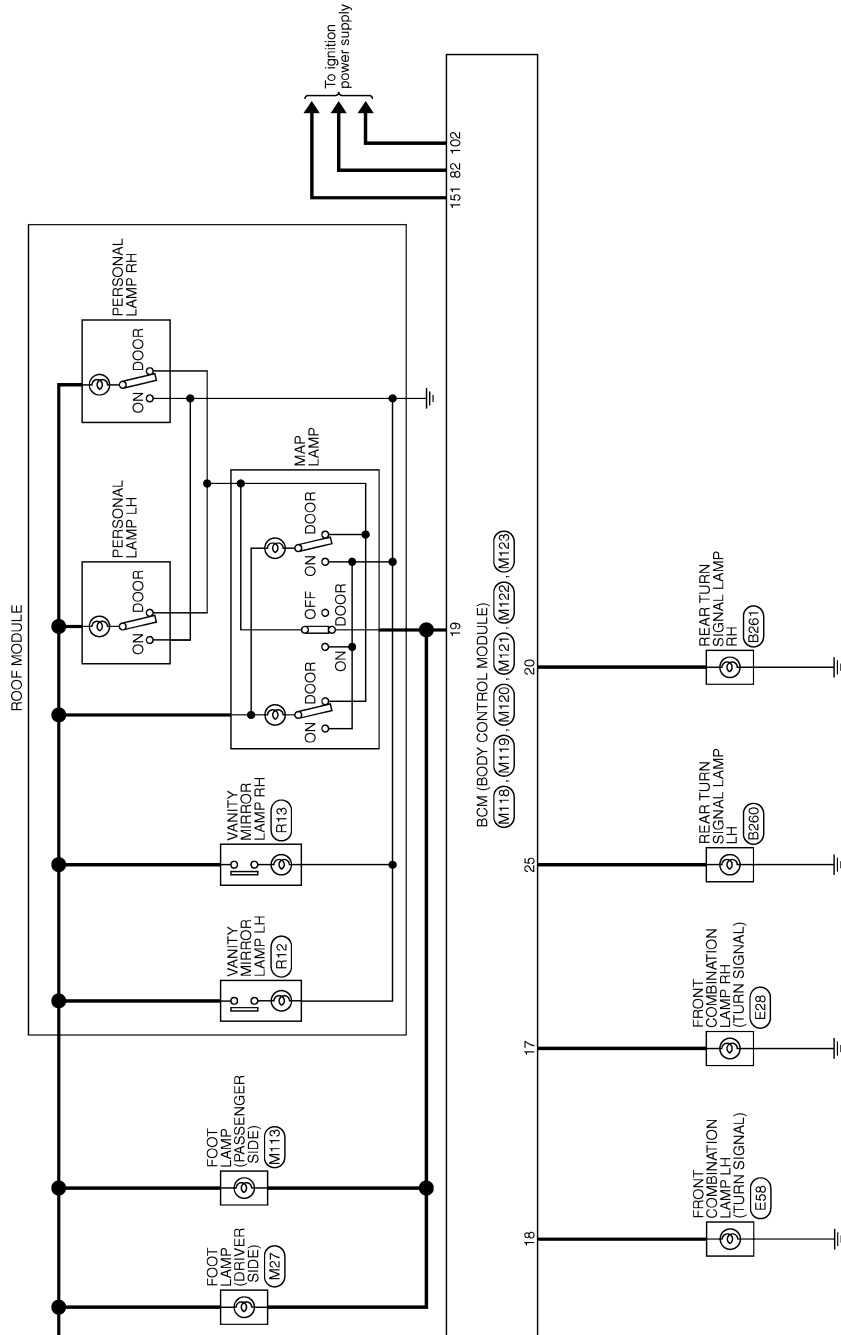

JCMWM1402GI

A
B
C
D
E
F
G
H
I
J
K
EXL
M
N
O
P

BCM (BODY CONTROL MODULE)

< ECU DIAGNOSIS >

[XENON TYPE]

BCM (BODY CONTROL MODULE)

Connector No.	M33
Connector Name	COMBINATION SWITCH
Connector Type	TH16FW-NH

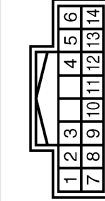

Terminal No.	Color of Wire	Signal Name [Specification]
2	SB	OUTPUT 4
5	L	OUTPUT 3
7	V	INPUT 3
8	O	OUTPUT 5
9	Y	INPUT 2
10	R	INPUT 4
11	LG	INPUT 1
12	P	OUTPUT 1
13	BR	INPUT 5
14	G	OUTPUT 2

Connector No.	M120
Connector Name	BCM (BODY CONTROL MODULE)
Connector Type	NS12FW-CS



Terminal No.	Color of Wire	Signal Name [Specification]
20	V	TURN SIGNAL RH (REAR)
23	G	BACK DOOR OPEN OUTPUT
25	G	TURN SIGNAL LH (REAR)
26	G	REAR WIPER OUTPUT

Connector No.	M118
Connector Name	BCM (BODY CONTROL MODULE)
Connector Type	M03FB-LC



Terminal No.	Color of Wire	Signal Name [Specification]
1	W	BAT (F/L)
2	Y	POWER WINDOW POWER SUPPLY(BAT)
3	O	POWER WINDOW POWER SUPPLY(TRAP)

Connector No.	M121
Connector Name	BCM (BODY CONTROL MODULE)
Connector Type	TH40FGY-NH



Terminal No.	Color of Wire	Signal Name [Specification]
34	SB	LUGGAGE ROOM ANTI-
35	V	LUGGAGE ROOM ANTI+
38	B	REAR BUMPER ANTI-
39	W	REAR BUMPER ANTI+
47	Y	IGN RELAY IPDM E/R CONT
52	SB	STARTER RELAY CONT
61	W	BACK DOOR OPENER REQUEST SW
64	V	REQUEST SW BUZZER
65	O	REAR WIPER STOP POSITION
66	R	BACK DOOR SW
67	GR	BACK DOOR OPENER SW

Connector No.	M119
Connector Name	BCM (BODY CONTROL MODULE)
Connector Type	NS16FW-CS

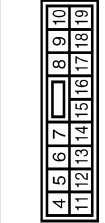

Terminal No.	Color of Wire	Signal Name [Specification]
4	LG	INTERIOR ROOM LAMP POWER SUPPLY
5	L	PASSINGER DOOR UNLOCK OUTPUT
7	Y	STEP LAMP OUTPUT
8	V	ALL DOOR FUEL LID LOCK OUTPUT
9	G	DRIVER DOOR UNLOCK OUTPUT
10	BR	REAR DOOR UNLOCK OUTPUT
11	R	BAT (R/USE)
13	B	GND
14	W	PUSH-BUTTON IGNITION SW ILL GND
15	Y	ACC INID
17	W	TURN SIGNAL RH (FRONT)

Connector No.	68
Connector Name	REAR RH DOOR SW
Connector Type	69
Connector Name	REAR LH DOOR SW
Connector Type	

18	O	TURN SIGNAL LH (FRONT)
19	V	ROOM LAMP TIMER CONTROL

BCM (BODY CONTROL MODULE)

< ECU DIAGNOSIS >

[XENON TYPE]

BCM (BODY CONTROL MODULE)

Connector No.	M122
Connector Name	BCM (BODY CONTROL MODULE)
Connector Type	TH40FB-NH

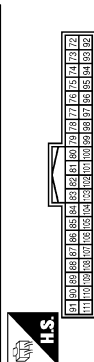

Terminal No.	Color of Wire	Signal Name [Specification]
72	R	ROOM ANT2-
73	G	ROOM ANT2+
74	SB	PASSENGER DOOR ANT-
75	GR	PASSENGER DOOR ANT+
76	V	DRIVER DOOR ANT-
77	LG	DRIVER DOOR ANT+
78	Y	ROOM ANTI-
79	BR	ROOM ANTI+
80	GR	IMMOBI ANTENNA CONTROL
81	W	IMMOBI ANTENNA SIGNAL
82	R	IGN RELAY (F/B) CONT

83	Y	KEYLESS TIMER SIGNAL
87	BR	COMBI SW INPUT 5
88	V	COMBI SW INPUT 3
89	BR	PUSH SW
90	P	CAN-L
91	L	CAN-H
92	LG	KEY SLOT ILL
93	Y	ON IND
94	V	PUDDLE LAMP CONT
95	O	ACC RELAY CONT
96	GR	A-T DEVICE POWER SUPPLY
97	L	S/L CONDITION 1
98	P	S/L CONDITION 2
99	R	SHIFT P
100	G	PASSENGER DOOR REQUEST SW
101	SB	DRIVER DOOR REQUEST SW
102	O	BLOWER FAN MOTOR RELAY CONT
103	LG	KEYLESS ENTRY RECEIVER POWER SUPPLY
106	W	S/L POWER SUPPLY
107	LG	COMBI SW INPUT 1
108	R	IGN F/B
109	Y	COMBI SW INPUT 4
110	G	COMBI SW INPUT 2
111	Y	HAZARD SW
		S/L COMM

Connector No.	M123
Connector Name	BCM (BODY CONTROL MODULE)
Connector Type	TH40FG-NH

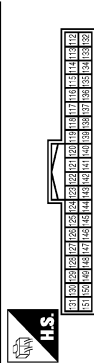

Terminal No.	Color of Wire	Signal Name [Specification]
113	P	OPTICAL SENSOR
116	SB	FUSE CHECK
118	P	STOP LAMP SW
119	SB	DR DOOR UNLOCK SENSOR
121	BR	KEY SLOT SW
122	V	ACC F/B
123	W	IGN F/B
124	LG	PASSENGER DOOR SW
132	V	POWER WINDOW SW COMM
133	W	PUSH-BUTTON IGNITION SW ILL POWER
134	GR	LOCK IND

137	O	RECEIVER SENSOR GND
138	Y	RECEIVER SENSOR POWER SUPPLY
139	L	TIRE PRESS RECEIVER SIGNAL
140	GR	SHIFT R/P
141	G	SECURITY INDICATOR OUTPUT
142	O	COMBI SW OUTPUT 5
143	P	COMBI SW OUTPUT 1
144	G	COMBI SW OUTPUT 2
145	L	COMBI SW OUTPUT 3
146	SB	COMBI SW OUTPUT 4
149	W	TIRE PRESS WARNING CHECK SW
150	LG	DRIVER DOOR SW
151	G	REAR WINDOW DEFOGGER RELAY

A
B
C
D
E
F
G
H
I
J
K
EXL
M
N
O
P

Fail-safe

FAIL-SAFE CONTROL BY DTC

BCM performs fail-safe control when any DTC is detected.

JCMWM1404G

INFOID:000000003784719

BCM (BODY CONTROL MODULE)

< ECU DIAGNOSIS >

[XENON TYPE]

Display contents of CONSULT	Fail-safe	Cancellation
B2013: ID DISCORD BCM-S/L	Inhibit engine cranking	Erase DTC
B2014: CHAIN OF S/L-BCM	Inhibit engine cranking	Erase DTC
B2190: NATS ANTENNA AMP	Inhibit engine cranking	Erase DTC
B2191: DIFFERENCE OF KEY	Inhibit engine cranking	Erase DTC
B2192: ID DISCORD BCM-ECM	Inhibit engine cranking	Erase DTC
B2193: CHAIN OF BCM-ECM	Inhibit engine cranking	Erase DTC
B2557: VEHICLE SPEED	Inhibit steering lock	When normal vehicle speed signals have been received from ABS actuator and electric unit (control unit) for 500 ms
B2560: STARTER CONT RELAY	Inhibit engine cranking	500 ms after the following CAN signal communication status has become consistent <ul style="list-style-type: none"> • Starter control relay signal • Starter relay status signal
B2601: SHIFT POSITION	Inhibit steering lock	500 ms after the following signal reception status becomes consistent <ul style="list-style-type: none"> • Selector lever P position switch signal • P range signal (CAN)
B2602: SHIFT POSITION	Inhibit steering lock	5 seconds after the following BCM recognition conditions are fulfilled <ul style="list-style-type: none"> • Ignition switch is in the ON position • Selector lever P position switch signal: Except P position (battery voltage) • Vehicle speed: 4 km/h (2.5 MPH) or more
B2603: SHIFT POSI STATUS	Inhibit steering lock	500 ms after the following BCM recognition conditions are fulfilled <ul style="list-style-type: none"> • Ignition switch is in the ON position • Selector lever P position switch signal: Except P position (battery voltage) • Selector lever P/N position signal: Except P and N positions (0 V)
B2604: PNP SW	Inhibit steering lock	500 ms after any of the following BCM recognition conditions is fulfilled <ul style="list-style-type: none"> • Status 1 <ul style="list-style-type: none"> - Ignition switch is in the ON position - Selector lever P/N position signal: P and N position (battery voltage) - P range signal or N range signal (CAN): ON • Status 2 <ul style="list-style-type: none"> - Ignition switch is in the ON position - Selector lever P/N position signal: Except P and N positions (0 V) - P range signal and N range signal (CAN): OFF
B2605: PNP SW	Inhibit steering lock	500 ms after any of the following BCM recognition conditions is fulfilled <ul style="list-style-type: none"> • Ignition switch is in the ON position <ul style="list-style-type: none"> - Power position: IGN - Selector lever P/N position signal: Except P and N positions (0 V) - Interlock/PNP switch signal (CAN): OFF • Status 2 <ul style="list-style-type: none"> - Ignition switch is in the ON position - Selector lever P/N position signal: P or N position (battery voltage) - PNP switch signal (CAN): ON
B2606: S/L RELAY	Inhibit engine cranking	500 ms after the following CAN signal communication status has become consistent <ul style="list-style-type: none"> • Steering lock relay signal (Request signal) • Steering lock relay signal (Condition signal)
B2607: S/L RELAY	Inhibit engine cranking	500 ms after the following CAN signal communication status has become consistent <ul style="list-style-type: none"> • Steering lock relay signal (Request signal) • Steering lock relay signal (Condition signal)

BCM (BODY CONTROL MODULE)

[XENON TYPE]

< ECU DIAGNOSIS >

Display contents of CONSULT	Fail-safe	Cancellation
B2608: STARTER RELAY	Inhibit engine cranking	500 ms after the following signal communication status becomes consistent <ul style="list-style-type: none"> • Starter motor relay control signal • Starter relay status signal (CAN)
B2609: S/L STATUS	<ul style="list-style-type: none"> • Inhibit engine cranking • Inhibit steering lock 	When the following steering lock conditions agree <ul style="list-style-type: none"> • BCM steering lock control status • Steering lock condition No. 1 signal status • Steering lock condition No. 2 signal status
B260A: IGNITION RELAY	Inhibit engine cranking	500 ms after the following conditions are fulfilled <ul style="list-style-type: none"> • IGN relay (IPDM E/R) control signal: OFF (Battery voltage) • Ignition ON signal (CAN to IPDM E/R): OFF (Request signal) • Ignition ON signal (CAN from IPDM E/R): OFF (Condition signal)
B260F: ENG STATE SIG LOST	Maintains the power supply position attained at the time of DTC detection	When any of the following conditions is fulfilled <ul style="list-style-type: none"> • Power position changes to ACC • Receives engine status signal (CAN)
B2612: S/L STATUS	<ul style="list-style-type: none"> • Inhibit engine cranking • Inhibit steering lock 	When any of the following conditions is fulfilled <ul style="list-style-type: none"> • Steering lock unit status signal (CAN) is received normally • The BCM steering lock control status matches the steering lock status recognized by the steering lock unit status signal (CAN from IPDM E/R)
B2617: STARTER RELAY CIRC	Inhibit engine cranking	1 second after the starter motor relay control inside BCM becomes normal
B2618: BCM	Inhibit engine cranking	1 second after the ignition relay (IPDM E/R) control inside BCM becomes normal
B2619: BCM	Inhibit engine cranking	1 second after the steering lock unit power supply output control inside BCM becomes normal
B261E: VEHICLE TYPE	Inhibit engine cranking	BCM initialization
B26E1: ENG STATE NO RECIV	Inhibit engine cranking	When any of the following conditions is fulfilled <ul style="list-style-type: none"> • Power position changes to ACC • Receives engine status signal (CAN)
B26E9: S/L STATUS	<ul style="list-style-type: none"> • Inhibit engine cranking • Inhibit steering lock 	When BCM transmits the LOCK request signal to steering lock unit, and receives LOCK response signal from steering lock unit, the following conditions is fulfilled <ul style="list-style-type: none"> • Steering condition No. 1 signal: LOCK (0V) • Steering condition No. 2 signal: LOCK (Battery voltage)

HIGH FLASHER OPERATION

BCM detects the turn signal lamp circuit status by the current value.

BCM increases the turn signal lamp blinking speed if the bulb or harness open is detected with the turn signal lamp operating.

NOTE:

The blinking speed is normal while activating the hazard warning lamp.

DTC Inspection Priority Chart

INFOID:000000003784720

If some DTCs are displayed at the same time, perform inspections one by one based on the following priority chart.

Priority	DTC
1	B2562: LOW VOLTAGE
2	<ul style="list-style-type: none"> • U1000: CAN COMM CIRCUIT • U1010: CONTROL UNIT (CAN)
3	<ul style="list-style-type: none"> • B2190: NATS ANTENNA AMP • B2191: DIFFERENCE OF KEY • B2192: ID DISCORD BCM-ECM • B2193: CHAIN OF BCM-ECM

BCM (BODY CONTROL MODULE)

< ECU DIAGNOSIS >

[XENON TYPE]

Priority	DTC
4	<ul style="list-style-type: none"> • B2013: ID DISCORD BCM-S/L • B2014: CHAIN OF S/L-BCM • B2553: IGNITION RELAY • B2555: STOP LAMP • B2556: PUSH-BTN IGN SW • B2557: VEHICLE SPEED • B2560: STARTER CONT RELAY • B2601: SHIFT POSITION • B2602: SHIFT POSITION • B2603: SHIFT POSI STATUS • B2604: PNP SW • B2605: PNP SW • B2606: S/L RELAY • B2607: S/L RELAY • B2608: STARTER RELAY • B2609: S/L STATUS • B260A: IGNITION RELAY • B260B: STEERING LOCK UNIT • B260C: STEERING LOCK UNIT • B260D: STEERING LOCK UNIT • B260F: ENG STATE SIG LOST • B2612: S/L STATUS • B2614: ACC RELAY CIRC • B2615: BLOWER RELAY CIRC • B2616: IGN RELAY CIRC • B2617: STARTER RELAY CIRC • B2618: BCM • B2619: BCM • B261A: PUSH-BTN IGN SW • B261E: VEHICLE TYPE • B26E1: ENG STATE NO RECIV • B26E9: S/L STATUS • B26EA: KEY REGISTRATION • C1729: VHCL SPEED SIG ERR • U0415: VEHICLE SPEED SIG
5	<ul style="list-style-type: none"> • C1704: LOW PRESSURE FL • C1705: LOW PRESSURE FR • C1706: LOW PRESSURE RR • C1707: LOW PRESSURE RL • C1708: [NO DATA] FL • C1709: [NO DATA] FR • C1710: [NO DATA] RR • C1711: [NO DATA] RL • C1712: [CHECKSUM ERR] FL • C1713: [CHECKSUM ERR] FR • C1714: [CHECKSUM ERR] RR • C1715: [CHECKSUM ERR] RL • C1716: [PRESSDATA ERR] FL • C1717: [PRESSDATA ERR] FR • C1718: [PRESSDATA ERR] RR • C1719: [PRESSDATA ERR] RL • C1720: [CODE ERR] FL • C1721: [CODE ERR] FR • C1722: [CODE ERR] RR • C1723: [CODE ERR] RL • C1724: [BATT VOLT LOW] FL • C1725: [BATT VOLT LOW] FR • C1726: [BATT VOLT LOW] RR • C1727: [BATT VOLT LOW] RL • C1734: CONTROL UNIT
6	<ul style="list-style-type: none"> • B2621: INSIDE ANTENNA • B2622: INSIDE ANTENNA • B2623: INSIDE ANTENNA

BCM (BODY CONTROL MODULE)

[XENON TYPE]

< ECU DIAGNOSIS >

DTC Index

INFOID:000000003784721

NOTE:

The details of time display are as follows.

- CRNT: A malfunction is detected now.
- PAST: A malfunction was detected in the past.

IGN counter is displayed on Freeze Frame Data. For details of Freeze Frame Data and IGN Counter, refer to [EXL-229, "COMMON ITEM : CONSULT-III Function \(BCM - COMMON ITEM\)"](#).

CONSULT display	Fail-safe	Freeze Frame Data	Intelligent Key warning lamp ON	Tire pressure monitor warning lamp ON	Reference page
No DTC is detected. further testing may be required.	—	—	—	—	—
U1000: CAN COMM CIRCUIT	—	—	—	—	BCS-37
U1010: CONTROL UNIT (CAN)	—	—	—	—	BCS-38
U0415: VEHICLE SPEED SIG	—	—	—	—	BCS-39
B2013: ID DISCORD BCM-S/L	×	×	—	—	SEC-48
B2014: CHAIN OF S/L-BCM	×	×	—	—	SEC-49
B2190: NATS ANTENNA AMP	×	—	—	—	SEC-42
B2191: DIFFERENCE OF KEY	×	—	—	—	SEC-45
B2192: ID DISCORD BCM-ECM	×	—	—	—	SEC-46
B2193: CHAIN OF BCM-ECM	×	—	—	—	SEC-47
B2553: IGNITION RELAY	—	×	—	—	PCS-49
B2555: STOP LAMP	—	×	—	—	SEC-52
B2556: PUSH-BTN IGN SW	—	×	×	—	SEC-54
B2557: VEHICLE SPEED	×	×	×	—	SEC-56
B2560: STARTER CONT RELAY	×	×	×	—	SEC-57
B2562: LOW VOLTAGE	—	×	—	—	BCS-40
B2601: SHIFT POSITION	×	×	×	—	SEC-58
B2602: SHIFT POSITION	×	×	×	—	SEC-61
B2603: SHIFT POSI STATUS	×	×	×	—	SEC-63
B2604: PNP SW	×	×	×	—	SEC-66
B2605: PNP SW	×	×	×	—	SEC-68
B2606: S/L RELAY	×	×	×	—	SEC-70
B2607: S/L RELAY	×	×	×	—	SEC-71
B2608: STARTER RELAY	×	×	×	—	SEC-73
B2609: S/L STATUS	×	×	×	—	SEC-75
B260A: IGNITION RELAY	×	×	×	—	PCS-51
B260B: STEERING LOCK UNIT	—	×	×	—	SEC-79
B260C: STEERING LOCK UNIT	—	×	×	—	SEC-80
B260D: STEERING LOCK UNIT	—	×	×	—	SEC-81
B260F: ENG STATE SIG LOST	×	×	×	—	SEC-82
B2612: S/L STATUS	×	×	×	—	SEC-86
B2614: ACC RELAY CIRC	—	×	×	—	PCS-53
B2615: BLOWER RELAY CIRC	—	×	×	—	PCS-57
B2616: IGN RELAY CIRC	—	×	×	—	PCS-59
B2617: STARTER RELAY CIRC	×	×	×	—	SEC-90

BCM (BODY CONTROL MODULE)

< ECU DIAGNOSIS >

[XENON TYPE]

CONSULT display	Fail-safe	Freeze Frame Data	Intelligent Key warning lamp ON	Tire pressure monitor warning lamp ON	Reference page
B2618: BCM	×	×	×	—	PCS-61
B2619: BCM	×	×	×	—	SEC-92
B261A: PUSH-BTN IGN SW	—	×	×	—	SEC-93
B261E: VEHICLE TYPE	×	×	× (Turn ON for 15 seconds)	—	SEC-96
B2621: INSIDE ANTENNA	—	×	—	—	DLK-56
B2622: INSIDE ANTENNA	—	×	—	—	DLK-58
B2623: INSIDE ANTENNA	—	×	—	—	DLK-60
B26E1: ENG STATE NO RES	×	×	×	—	SEC-83
B26E9: S/L STATUS	×	×	× (Turn ON for 15 seconds)	—	SEC-84
B26EA: KEY REGISTRATION	—	×	× (Turn ON for 15 seconds)	—	SEC-85
C1704: LOW PRESSURE FL	—	—	—	×	WT-16
C1705: LOW PRESSURE FR	—	—	—	×	
C1706: LOW PRESSURE RR	—	—	—	×	
C1707: LOW PRESSURE RL	—	—	—	×	
C1708: [NO DATA] FL	—	—	—	×	WT-18
C1709: [NO DATA] FR	—	—	—	×	
C1710: [NO DATA] RR	—	—	—	×	
C1711: [NO DATA] RL	—	—	—	×	
C1712: [CHECKSUM ERR] FL	—	—	—	×	WT-21
C1713: [CHECKSUM ERR] FR	—	—	—	×	
C1714: [CHECKSUM ERR] RR	—	—	—	×	
C1715: [CHECKSUM ERR] RL	—	—	—	×	
C1716: [PRESSDATA ERR] FL	—	—	—	×	WT-24
C1717: [PRESSDATA ERR] FR	—	—	—	×	
C1718: [PRESSDATA ERR] RR	—	—	—	×	
C1719: [PRESSDATA ERR] RL	—	—	—	×	
C1720: [CODE ERR] FL	—	—	—	×	WT-26
C1721: [CODE ERR] FR	—	—	—	×	
C1722: [CODE ERR] RR	—	—	—	×	
C1723: [CODE ERR] RL	—	—	—	×	
C1724: [BATT VOLT LOW] FL	—	—	—	×	WT-29
C1725: [BATT VOLT LOW] FR	—	—	—	×	
C1726: [BATT VOLT LOW] RR	—	—	—	×	
C1727: [BATT VOLT LOW] RL	—	—	—	×	
C1729: VHCL SPEED SIG ERR	—	—	—	×	WT-32
C1734: CONTROL UNIT	—	—	—	×	WT-33

IPDM E/R (INTELLIGENT POWER DISTRIBUTION MODULE ENGINE ROOM)

< ECU DIAGNOSIS >

[XENON TYPE]

IPDM E/R (INTELLIGENT POWER DISTRIBUTION MODULE ENGINE ROOM)

Reference Value

INFOID:000000003757041

VALUES ON THE DIAGNOSIS TOOL

Monitor Item	Condition		Value/Status
RAD FAN REQ	Engine idle speed	Changes depending on engine coolant temperature, air conditioner operation status, vehicle speed, etc.	0 – 100 %
AC COMP REQ	Engine running	A/C switch OFF	Off
		A/C switch ON (Compressor is operating)	On
TAIL&CLR REQ	Lighting switch OFF		Off
	Lighting switch 1ST, 2ND, HI or AUTO (Light is illuminated)		On
HL LO REQ	Lighting switch OFF		Off
	Lighting switch 2ND HI or AUTO (Light is illuminated)		On
HL HI REQ	Lighting switch OFF		Off
	Lighting switch HI		On
FR FOG REQ	Lighting switch 2ND or AUTO (Light is illuminated)	Front fog lamp switch OFF	Off
		<ul style="list-style-type: none"> • Front fog lamp switch ON • Daytime running light activated (Only for Canada) 	On
FR WIP REQ	Ignition switch ON	Front wiper switch OFF	Stop
		Front wiper switch INT	1LOW
		Front wiper switch LO	Low
		Front wiper switch HI	Hi
WIP AUTO STOP	Ignition switch ON	Front wiper stop position	STOP P
		Any position other than front wiper stop position	ACT P
WIP PROT	Ignition switch ON	Front wiper operates normally	Off
		Front wiper stops at fail-safe operation	BLOCK
IGN RLY1 -REQ	Ignition switch OFF or ACC		Off
	Ignition switch ON		On
IGN RLY	Ignition switch OFF or ACC		Off
	Ignition switch ON		On
PUSH SW	Release the push-button ignition switch		Off
	Press the push-button ignition switch		On
INTER/NP SW	Ignition switch ON	Selector lever in any position other than P or N	Off
		Selector lever in P or N position	On
ST RLY CONT	Ignition switch ON		Off
	At engine cranking		On
IHBT RLY -REQ	Ignition switch ON		Off
	At engine cranking		On

IPDM E/R (INTELLIGENT POWER DISTRIBUTION MODULE ENGINE ROOM)

< ECU DIAGNOSIS >

[XENON TYPE]

Monitor Item	Condition	Value/Status
ST/INHI RLY	Ignition switch ON	Off
	At engine cranking	INHI → ST
	The status of starter relay or starter control relay cannot be recognized by the battery voltage malfunction, etc. when the starter relay is ON and the starter control relay is OFF	UNKWN
DETENT SW	Ignition switch ON <ul style="list-style-type: none"> • Press the selector button with selector lever in P position • Selector lever in any position other than P 	Off
	Release the selector button with selector lever in P position	On
S/L RLY -REQ	None of the conditions below are present	Off
	<ul style="list-style-type: none"> • Open the driver door after the ignition switch is turned OFF (for a few seconds) • Press the push-button ignition switch when the steering lock is activated 	On
S/L STATE	Steering lock is activated	LOCK
	Steering lock is deactivated	UNLOCK
	[DTC: B210A] is detected	UNKWN
DTRL REQ	NOTE: The item is indicated, but not monitored.	Off
OIL P SW	Ignition switch OFF, ACC or engine running	Open
	Ignition switch ON	Close
HOOD SW	Close the hood	Off
	Open the hood	On
HL WASHER REQ	NOTE: The item is indicated, but not monitored.	Off
THFT HRN REQ	Not operation	Off
	<ul style="list-style-type: none"> • Panic alarm is activated • Horn is activated with VEHICLE SECURITY (THEFT WARNING) SYSTEM 	On
HORN CHIRP	Not operating	Off
	Door locking with Intelligent Key (horn chirp mode)	On
CRNRNG LMP REQ	NOTE: The item is indicated, but not monitored.	Off

IPDM E/R (INTELLIGENT POWER DISTRIBUTION MODULE ENGINE ROOM)

< ECU DIAGNOSIS >

[XENON TYPE]

TERMINAL LAYOUT

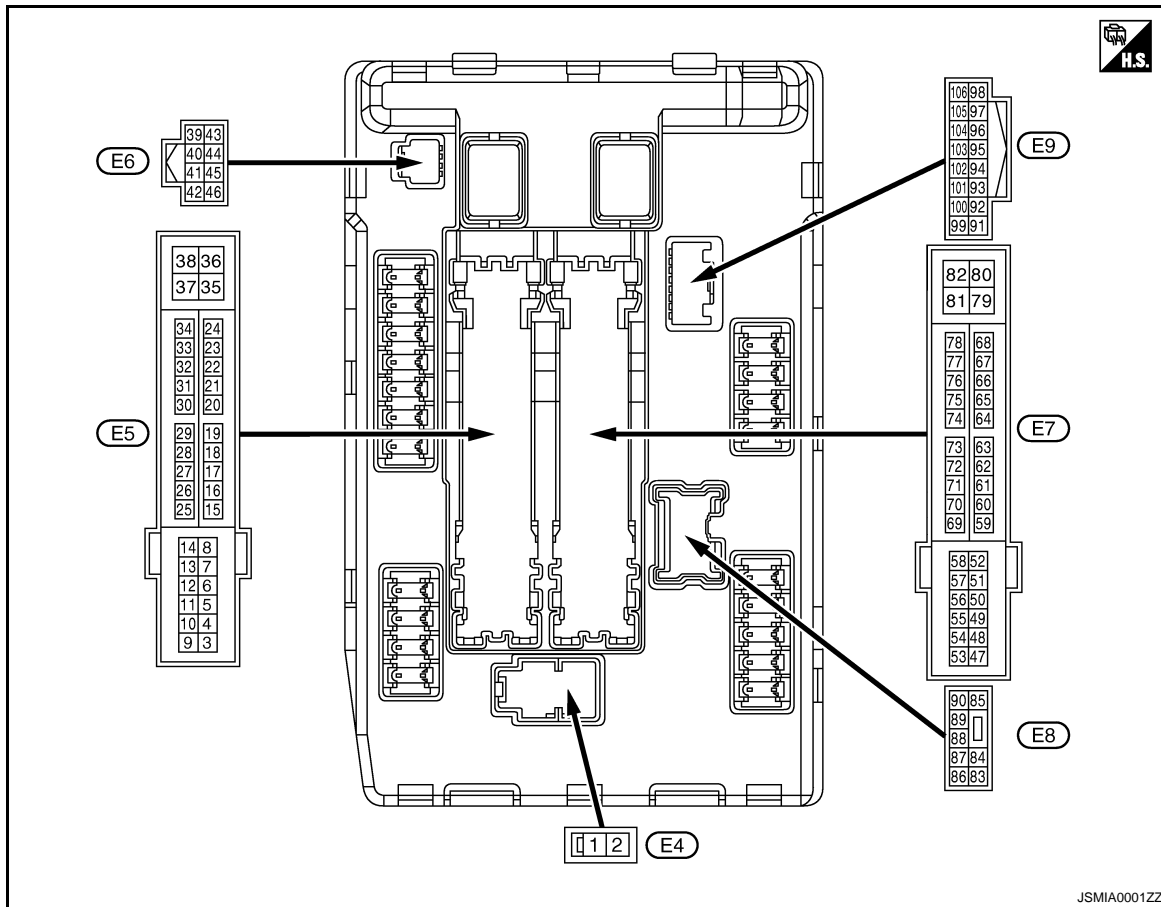

PHYSICAL VALUES

Terminal No. (Wire color)		Description		Condition		Value (Approx.)
+	-	Signal name	Input/ Output			
1 (W)	Ground	Battery power supply	Input	Ignition switch OFF		Battery voltage
2 (L)	Ground	Battery power supply	Input	Ignition switch OFF		Battery voltage
4 (V)	Ground	Front wiper LO	Output	Ignition switch OFF	Front wiper switch OFF	0 V
				Ignition switch ON	Front wiper switch LO	Battery voltage
5 (L)	Ground	Front wiper HI	Output	Ignition switch OFF	Front wiper switch OFF	0 V
				Ignition switch ON	Front wiper switch HI	Battery voltage
7 (R)	Ground	Tail, license plate lamps & interior lamps	Output	Ignition switch OFF	Lighting switch OFF	0 V
				Ignition switch ON	Lighting switch 1ST	Battery voltage
11 (BR)	Ground	Steering lock unit power supply	Output	Ignition switch OFF	A few seconds after open- ing the driver door	Battery voltage
				Ignition switch LOCK	Press the push-button ig- nition switch	Battery voltage
				Ignition switch ACC or ON		0 V
12 (B/W)	Ground	Ground	—	Ignition switch ON		0 V

IPDM E/R (INTELLIGENT POWER DISTRIBUTION MODULE ENGINE ROOM)

[XENON TYPE]

< ECU DIAGNOSIS >

Terminal No. (Wire color)		Description		Condition		Value (Approx.)
+	-	Signal name	Input/ Output			
13 (SB)	Ground	Fuel pump power supply	Output	Approximately 1 second or more after turning the ignition switch ON		0 V
				<ul style="list-style-type: none"> • Approximately 1 second after turning the ignition switch ON • Engine running 		Battery voltage
16 (LG)	Ground	Front wiper auto stop	Input	Ignition switch ON	Front wiper stop position	0 V
					Any position other than front wiper stop position	Battery voltage
19 (W)	Ground	Ignition relay power supply	Output	Ignition switch OFF		0 V
				Ignition switch ON		Battery voltage
25 (G)	Ground	Ignition relay power supply	Output	Ignition switch OFF		0 V
				Ignition switch ON		Battery voltage
26* (R)	Ground	Ignition relay power supply	Output	Ignition switch OFF		0 V
				Ignition switch ON		Battery voltage
27 (O)	Ground	Ignition relay monitor	Input	Ignition switch OFF or ACC		Battery voltage
				Ignition switch ON		0 V
28 (L)	Ground	Push-button ignition switch	Input	Press the push-button ignition switch		0 V
				Release the push-button ignition switch		Battery voltage
30 (GR)	Ground	Starter relay control	Input	Ignition switch ON	Selector lever in any position other than P or N	0 V
					Selector lever P or N	Battery voltage
32 (L)	Ground	Steering lock unit condition-1	Input	Steering lock is activated		0 V
				Steering lock is deactivated		Battery voltage
33 (P)	Ground	Steering lock unit condition-2	Input	Steering lock is activated		Battery voltage
				Steering lock is deactivated		0 V
36 (G)	Ground	Battery power supply	Input	Ignition switch OFF		Battery voltage
39 (P)	—	CAN-L	Input/ Output	—		—
40 (L)	—	CAN-H	Input/ Output	—		—
41 (B/W)	Ground	Ground	—	Ignition switch ON		0 V
42 (Y)	Ground	Cooling fan relay control	Input	Ignition switch OFF or ACC		0 V
				Ignition switch ON		0.7 V
43 (SB)	Ground	Control device (Detention switch)	Input	Ignition switch ON	<ul style="list-style-type: none"> • Press the selector button (Selector lever P) • Selector lever in any position other than P 	Battery voltage
					Release the selector button (selector lever P)	0 V
44 (W)	Ground	Horn relay control	Input	The horn is deactivated		Battery voltage
				The horn is activated		0 V
45 (G)	Ground	Anti theft horn relay control	Input	The horn is deactivated		Battery voltage
				The horn is activated		0 V

IPDM E/R (INTELLIGENT POWER DISTRIBUTION MODULE ENGINE ROOM)

< ECU DIAGNOSIS >

[XENON TYPE]

Terminal No. (Wire color)		Description		Condition		Value (Approx.)	
		Signal name	Input/ Output				
+	-						
46 (R)	Ground	Starter relay control	Input	Ignition switch ON	Selector lever in any position other than P or N	0 V	A
					Selector lever P or N	Battery voltage	B
48 (L)	Ground	A/C relay power supply	Output	Engine running	A/C switch OFF	0 V	C
					A/C switch ON (A/C compressor is operating)	Battery voltage	D
49 (R)	Ground	ECM relay power supply	Output		Ignition switch OFF (More than a few seconds after turning ignition switch OFF)	0 V	E
					<ul style="list-style-type: none"> • Ignition switch ON • Ignition switch OFF (For a few seconds after turning ignition switch OFF) 	Battery voltage	F
51 (G)	Ground	Ignition relay power supply	Output		Ignition switch OFF	0 V	G
					Ignition switch ON	Battery voltage	H
53 (W)	Ground	ECM relay power supply	Output		Ignition switch OFF (More than a few seconds after turning ignition switch OFF)	0 V	I
					<ul style="list-style-type: none"> • Ignition switch ON • Ignition switch OFF (For a few seconds after turning ignition switch OFF) 	Battery voltage	J
54 (LG)	Ground	Throttle control motor relay power supply	Output		Ignition switch OFF (More than a few seconds after turning ignition switch OFF)	0 V	K
					<ul style="list-style-type: none"> • Ignition switch ON • Ignition switch OFF (For a few seconds after turning ignition switch OFF) 	Battery voltage	EXL
55 (BR)	Ground	ECM power supply	Output		Ignition switch OFF	Battery voltage	
56 (V)	Ground	Ignition relay power supply	Output		Ignition switch OFF	0 V	
					Ignition switch ON	Battery voltage	M
57 (SB)	Ground	Ignition relay power supply	Output		Ignition switch OFF	0 V	
					Ignition switch ON	Battery voltage	N
58 (P)	Ground	Ignition relay power supply	Output		Ignition switch OFF	0 V	
					Ignition switch ON	Battery voltage	O
69 (W)	Ground	ECM relay control	Output		Ignition switch OFF (More than a few seconds after turning ignition switch OFF)	Battery voltage	
					<ul style="list-style-type: none"> • Ignition switch ON • Ignition switch OFF (For a few seconds after turning ignition switch OFF) 	0 – 1.5 V	P
70 (O)	Ground	Throttle control motor relay control	Output		Ignition switch ON → OFF	0 – 1.0 V ↓ Battery voltage ↓ 0 V	
					Ignition switch ON	0 – 1.0 V	

IPDM E/R (INTELLIGENT POWER DISTRIBUTION MODULE ENGINE ROOM)

[XENON TYPE]

< ECU DIAGNOSIS >

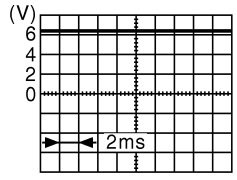
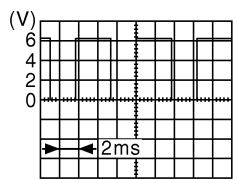
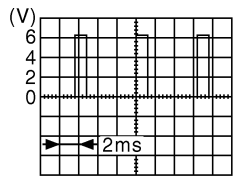
Terminal No. (Wire color)		Description		Condition		Value (Approx.)
+	-					
74 (P)	Ground	Ignition relay power supply	Output	Ignition switch OFF		0 V
				Ignition switch ON		Battery voltage
75 (Y)	Ground	Oil pressure switch	Input	Ignition switch ON	Engine stopped	0 V
					Engine running	Battery voltage
76 (V)	Ground	Power generation command signal	Output	Ignition switch ON		 <p style="text-align: center;">6.3 V</p>
				40% is set on "ACTIVE TEST", "ALTERNATOR DUTY" of "ENGINE"		 <p style="text-align: center;">3.8 V</p>
				80% is set on "ACTIVE TEST", "ALTERNATOR DUTY" of "ENGINE"		 <p style="text-align: center;">1.4 V</p>
77 (L)	Ground	Fuel pump relay control	Output	<ul style="list-style-type: none"> Approximately 1 second after turning the ignition switch ON Engine running 		0 – 1.0 V
				Approximately 1 second or more after turning the ignition switch ON		Battery voltage
80 (W)	Ground	Starter motor	Output	At engine cranking		Battery voltage
83 (O)	Ground	Headlamp LO (RH)	Output	Ignition switch ON	Lighting switch OFF	0 V
					Lighting switch 2ND	Battery voltage
84 (V)	Ground	Headlamp LO (LH)	Output	Ignition switch ON	Lighting switch OFF	0 V
					Lighting switch 2ND	Battery voltage
86 (W)	Ground	Front fog lamp (RH)	Output	Lighting switch 2ND	<ul style="list-style-type: none"> Front fog lamp switch ON Daytime running light activated (Only for Canada) 	Battery voltage
					Front fog lamp switch OFF	0 V

IPDM E/R (INTELLIGENT POWER DISTRIBUTION MODULE ENGINE ROOM)

< ECU DIAGNOSIS >

[XENON TYPE]

Terminal No. (Wire color)		Description		Condition		Value (Approx.)
+	-	Signal name	Input/ Output			
87 (L)	Ground	Front fog lamp (LH)	Output	Lighting switch 2ND	<ul style="list-style-type: none"> • Front fog lamp switch ON • Daytime running light activated (Only for Canada) 	Battery voltage
				Front fog lamp switch OFF	0 V	
88 (GR)	Ground	Washer pump power supply	Output	Ignition switch ON		Battery voltage
89 (BR)	Ground	Headlamp HI (RH)	Output	Ignition switch ON	<ul style="list-style-type: none"> • Lighting switch HI • Lighting switch PASS 	Battery voltage
				Lighting switch OFF	0 V	
90 (P)	Ground	Headlamp HI (LH)	Output	Ignition switch ON	<ul style="list-style-type: none"> • Lighting switch HI • Lighting switch PASS 	Battery voltage
				Lighting switch OFF	0 V	
91 (P)	Ground	Parking lamp (RH)	Output	Ignition switch ON	Lighting switch 1ST	Battery voltage
				Lighting switch OFF	0 V	
92 (O)	Ground	Parking lamp (LH)	Output	Ignition switch ON	Lighting switch 1ST	Battery voltage
				Lighting switch OFF	0 V	
97 (V)	Ground	Cooling fan control	Output	Engine idling		0 – 5 V
104 (LG)	Ground	Hood switch	Input	Close the hood		Battery voltage
				Open the hood		0 V

*: Only for the models with ICC system

A
B
C
D
E
F
G
H
I
J
K
L
M
N
O
P

EXL

IPDM E/R (INTELLIGENT POWER DISTRIBUTION MODULE ENGINE ROOM)

< ECU DIAGNOSIS >

[XENON TYPE]

Wiring Diagram - IPDM E/R -

INFOID:000000003757042

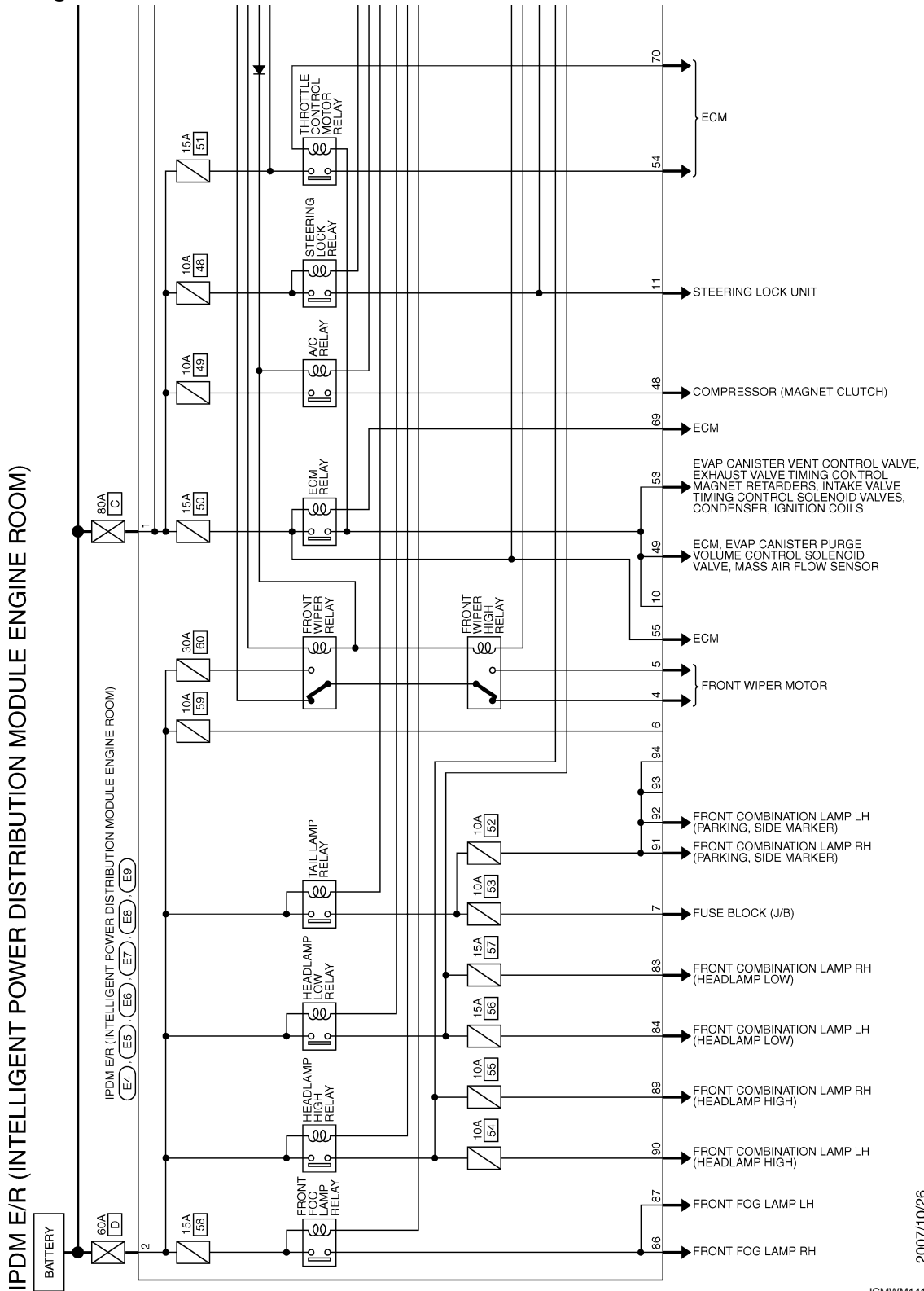

2007/10/26

JCMWM1411G1

IPDM E/R (INTELLIGENT POWER DISTRIBUTION MODULE ENGINE ROOM)

< ECU DIAGNOSIS >

[XENON TYPE]

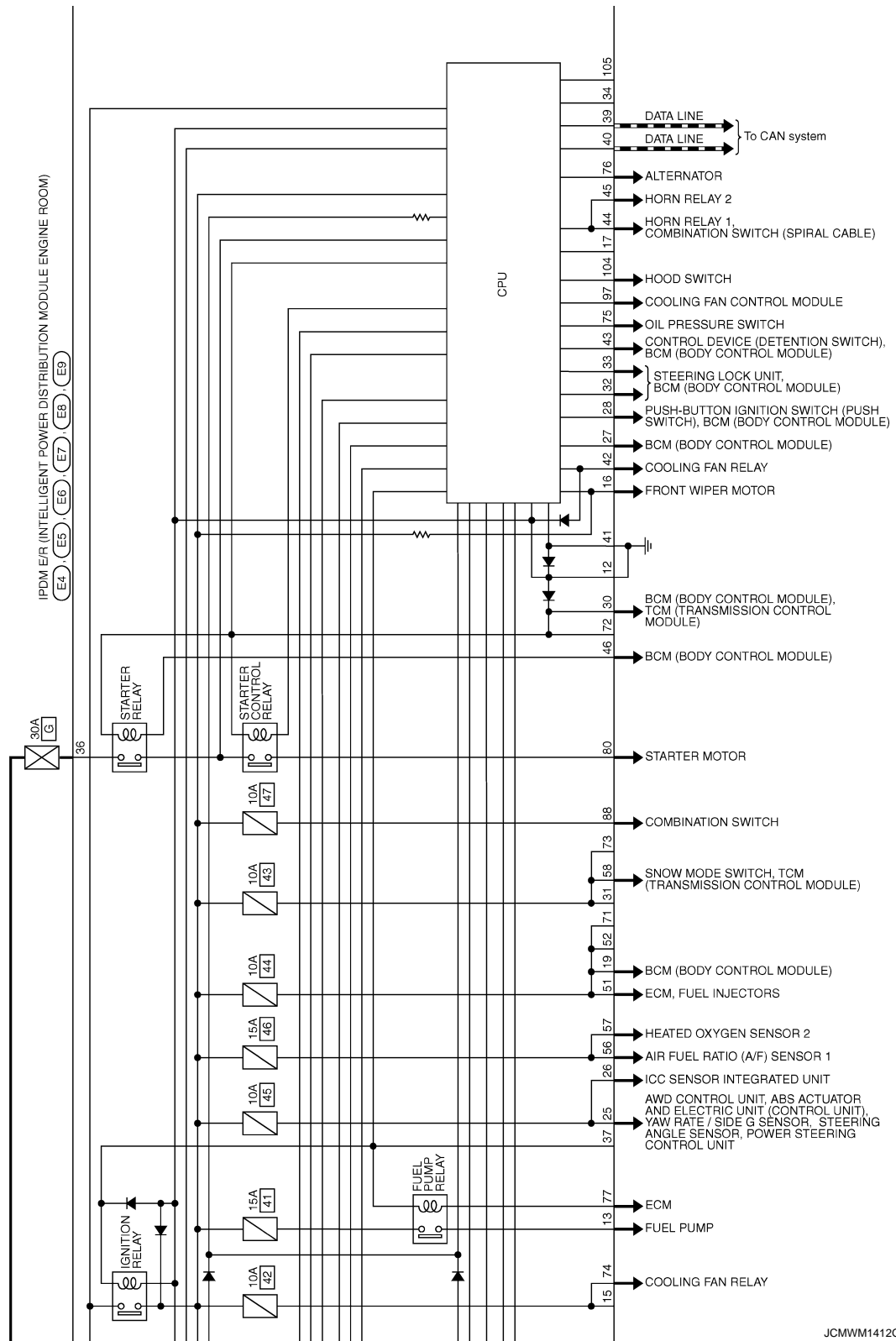

JCMWM1412G1

A
B
C
D
E
F
G
H
I
J
K
EXL
M
N
O
P

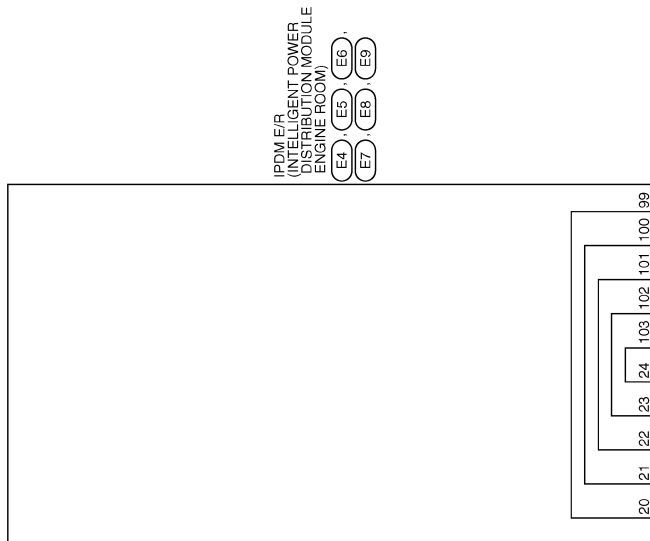

JCMWM1413G

IPDM E/R (INTELLIGENT POWER DISTRIBUTION MODULE ENGINE ROOM)

< ECU DIAGNOSIS >

[XENON TYPE]

Connector No.	E6
Connector Name	IPDM E/R (INTELLIGENT POWER DISTRIBUTION MODULE ENGINE ROOM)
Connector Type	TH183FW-NH



42	41	40	39
46	45	44	43

Terminal No.	Color of Wire	Signal Name [Specification]
39	P	-
40	L	-
41	B/W	-
42	Y	-
43	SB	-
44	W	-
45	G	-
46	R	-

Connector No.	E9
Connector Name	IPDM E/R (INTELLIGENT POWER DISTRIBUTION MODULE ENGINE ROOM)
Connector Type	TH183FW-NH



98	97	96	95	94	93	92	91
108	105	104	103	102	101	100	99

Terminal No.	Color of Wire	Signal Name [Specification]
91	P	-
92	O	-
97	V	-
104	LG	-

28	L	-
30	GR	-
32	L	-
33	P	-
36	G	-

Connector No.	E8
Connector Name	IPDM E/R (INTELLIGENT POWER DISTRIBUTION MODULE ENGINE ROOM)
Connector Type	NS08FW-CS



85	84	83
90	89	88
87	86	-

Terminal No.	Color of Wire	Signal Name [Specification]
83	O	-
84	V	-
86	W	-
87	L	-
88	GR	-
89	BR	-
90	P	-

Connector No.	E5
Connector Name	IPDM E/R (INTELLIGENT POWER DISTRIBUTION MODULE ENGINE ROOM)
Connector Type	TH20FW-CS12-M4-1V



9	10	11	12	13	14	24	22	21	20	19	18	17	16	15	14	13	12	11	10	9	
3	4	5	6	7	8	18	17	16	15	14	13	12	11	10	9	8	7	6	5	4	3

Terminal No.	Color of Wire	Signal Name [Specification]
4	V	-
5	L	-
7	R	-
11	BR	-
12	B/W	-
13	SB	-
16	LG	-
19	W	-
25	G	-
26	R	-
27	O	-

Connector No.	E8
Connector Name	IPDM E/R (INTELLIGENT POWER DISTRIBUTION MODULE ENGINE ROOM)
Connector Type	NS08FW-CS



74	P
75	Y
76	V
77	L
80	W

Connector No.	E4
Connector Name	IPDM E/R (INTELLIGENT POWER DISTRIBUTION MODULE ENGINE ROOM)
Connector Type	LOPE-MC



1	2
---	---

Terminal No.	Color of Wire	Signal Name [Specification]
1	W	-
2	L	-

Connector No.	E7
Connector Name	IPDM E/R (INTELLIGENT POWER DISTRIBUTION MODULE ENGINE ROOM)
Connector Type	TH20FW-CS12-M4



35	34	33	32	31	30	29	28	27	26	25	24	23	22	21	20	19	18	17	16	15	14	13	12	11	10	9	8	7	6	5	4	3	2	1
----	----	----	----	----	----	----	----	----	----	----	----	----	----	----	----	----	----	----	----	----	----	----	----	----	----	---	---	---	---	---	---	---	---	---

Terminal No.	Color of Wire	Signal Name [Specification]
48	L	-
49	R	-
51	G	-
53	W	-
54	LG	-
55	BR	-
56	V	-
57	SB	-
58	P	-
68	W	-
70	O	-

Fail-safe

CAN COMMUNICATION CONTROL

When CAN communication with ECM and BCM is impossible, IPDM E/R performs fail-safe control. After CAN communication recovers normally, it also returns to normal control.

If No CAN Communication Is Available With ECM

JCMWM1414G

INFOID:000000003757043

A
B
C
D
E
F
G
H
I
J
K
L
M
N
O
P

EXL

IPDM E/R (INTELLIGENT POWER DISTRIBUTION MODULE ENGINE ROOM)

[XENON TYPE]

< ECU DIAGNOSIS >

Control part	Fail-safe operation
Cooling fan	<ul style="list-style-type: none"> • Outputs the pulse duty signal (PWM signal) 100% when the ignition switch is turned ON • Outputs the pulse duty signal (PWM signal) 0% when the ignition switch is turned OFF
A/C compressor	A/C relay OFF
Alternator	Outputs the power generation command signal (PWM signal) 0%

If No CAN Communication Is Available With BCM

Control part	Fail-safe operation
Headlamp	<ul style="list-style-type: none"> • Turns ON the headlamp low relay when the ignition switch is turned ON • Turns OFF the headlamp low relay when the ignition switch is turned OFF • Headlamp high relay OFF
<ul style="list-style-type: none"> • Parking lamps • License plate lamps • Side maker lamps • Illuminations • Tail lamps 	<ul style="list-style-type: none"> • Turns ON the tail lamp relay when the ignition switch is turned ON • Turns OFF the tail lamp relay when the ignition switch is turned OFF
Front wiper	<ul style="list-style-type: none"> • The status just before activation of fail-safe control is maintained until the ignition switch is turned OFF while the front wiper is operating at LO or HI speed. • The wiper is operated at LO speed until the ignition switch is turned OFF if the fail-safe control is activated while the front wiper is set in the INT mode and the front wiper motor is operating.
Front fog lamps	Front fog lamp relay OFF
Horn	Horn OFF
Ignition relay	The status just before activation of fail-safe is maintained.
Starter motor	Starter control relay OFF
Steering lock unit	Steering lock relay OFF

IGNITION RELAY MALFUNCTION DETECTION FUNCTION

- IPDM E/R monitors the voltage at the contact circuit and excitation coil circuit of the ignition relay inside it.
- IPDM E/R judges the ignition relay error if the voltage differs between the contact circuit and the excitation coil circuit.
- If the ignition relay cannot turn OFF due to contact seizure, it activates the tail lamp relay for 10 minutes to alert the user to the ignition relay malfunction when the ignition switch is turned OFF.

Voltage judgment		IPDM E/R judgment	Operation
Ignition relay contact side	Ignition relay excitation coil side		
ON	ON	Ignition relay ON normal	—
OFF	OFF	Ignition relay OFF normal	—
ON	OFF	Ignition relay ON stuck	<ul style="list-style-type: none"> • Detects DTC "B2098: IGN RELAY ON" • Turns ON the tail lamp relay for 10 minutes
OFF	ON	Ignition relay OFF stuck	Detects DTC "B2099: IGN RELAY OFF"

FRONT WIPER CONTROL

IPDM E/R detects front wiper stop position by a front wiper auto stop signal.

When a front wiper auto stop signal is in the conditions listed below, IPDM E/R stops power supply to wiper after repeating a front wiper 10 seconds activation and 20 seconds stop five times.

IPDM E/R (INTELLIGENT POWER DISTRIBUTION MODULE ENGINE ROOM)

< ECU DIAGNOSIS >

[XENON TYPE]

Ignition switch	Front wiper switch	Front wiper auto stop signal
ON	OFF	The front wiper auto stop signal (stop position) cannot be input for 10 seconds.
	ON	The front wiper auto stop signal does not change for 10 seconds.

NOTE:

This operation status can be confirmed on the IPDM E/R “Data Monitor” that displays “BLOCK” for the item “WIP PROT” while the wiper is stopped.

STARTER MOTOR PROTECTION FUNCTION

IPDM E/R turns OFF the starter control relay to protect the starter motor when the starter control relay remains active for 90 seconds.

DTC Index

INFOID:000000003757044

NOTE:

- The details of time display are as follows.
 - CRNT: A malfunction is detected now
 - PAST: A malfunction was detected in the past.
- IGN counter is displayed on FFD (Freeze Frame data).
 - The number is 0 when is detected now
 - The number increases like 1 → 2 ... 38 → 39 after returning to the normal condition whenever IGN OFF → ON.
 - The number is fixed to 39 until the self-diagnosis results are erased if it is over 39.

x: Applicable

CONSULT display	Fail-safe	Reference
No DTC is detected. further testing may be required.	—	—
U1000: CAN COMM CIRCUIT	×	PCS-16
B2098: IGN RELAY ON	×	PCS-17
B2099: IGN RELAY OFF	—	PCS-18
B2108: STRG LCK RELAY ON	—	SEC-97
B2109: STRG LCK RELAY OFF	—	SEC-98
B210A: STRG LCK STATE SW	—	SEC-99
B210B: START CONT RLY ON	—	SEC-103
B210C: START CONT RLY OFF	—	SEC-104
B210D: STARTER RELAY ON	—	SEC-105
B210E: STARTER RELAY OFF	—	SEC-106
B210F: INTRLCK/PNP SW ON	—	SEC-108
B2110: INTRLCK/PNP SW OFF	—	SEC-110

A
B
C
D
E
F
G
H
I
J
K
EXL
M
N
O
P

AFS CONTROL UNIT

< ECU DIAGNOSIS >

[XENON TYPE]

AFS CONTROL UNIT

Reference Value

INFOID:000000003135374

VALUES ON THE DIAGNOSIS TOOL

CONSULT-III MONITOR ITEM

Monitor Item	Condition		Value/Status
STR ANGLE SIG	Steering	Straight-forward	Approx. 0°
		Steering	Approx. -900° - +900°
VHCL SPD	Driving at 40 km/h (25 MPH)		40 km/h
SLCT LVR POSI	Selector lever operation		P - 1
HEAD LAMP	Light switch	2ND	On
		Other than 2ND	Off
AFS SW	AFS OFF switch	ON	On
		OFF	Off
HI SEN OTP RR	Vehicle rear height	Unloaded vehicle condition	Approx. 2.5 V
		Low (Leveling operation downward edge)	Approx. 1.6 V
LEV ACTR VLTG	Headlamp leveling	Unloaded vehicle condition	Approx. 70.0%
		Low (Leveling operation downward edge)	Approx. 35.4% (With 17-inch wheel) Approx. 32.1% (With 18-inch wheel)
SWVL SEN RH	Right headlamp swivel activation	Standard position	Approx. 0°
		Activation	Positive degree (+°)
SWVL SEN LH	Left headlamp swivel activation	Standard position	Approx. 0°
		Activation	Positive degree (+°)
SWVL ANGLE RH	Right headlamp swivel activation	Standard position	Approx. 0°
		Activation	Positive degree (+°)
SWVL ANGLE LH	Left headlamp swivel activation	Standard position	Approx. 0°
		Activation	Positive degree (+°)

TERMINAL LAYOUT

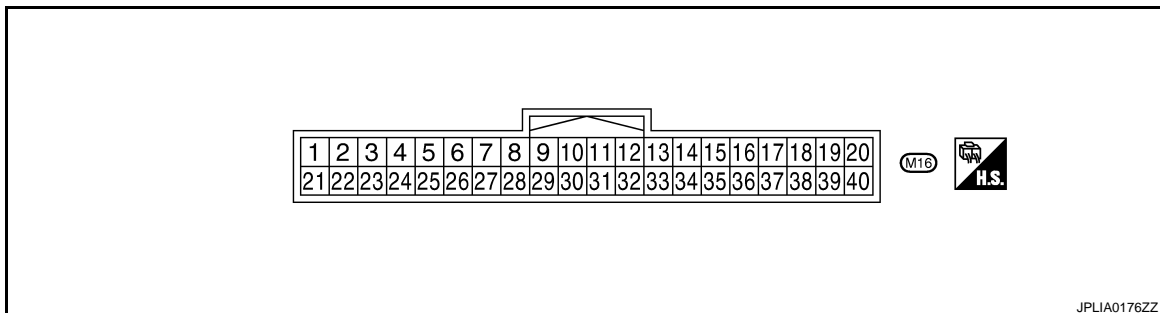

JPLIA0176ZZ

PHYSICAL VALUES

AFS CONTROL UNIT

< ECU DIAGNOSIS >

[XENON TYPE]

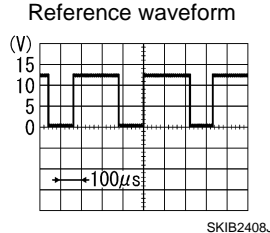
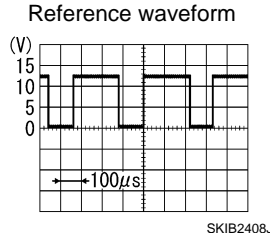
Terminal No. (Wire color)		Description		Condition		Value (Approx.)
+	-	Signal name	Input/ output			
1 (Y)	Ground	Ignition power supply	Input	The ignition switch ON		Battery voltage
2 (LG)	Ground	Right swivel position sensor ground	Input	The ignition switch ON		0 V
3 (GR)	Ground	AFS switch signal	Input	AFS OFF switch	ON	0 V
					OFF	Battery voltage
4 (Y)	Ground	Right swivel position sensor power supply	Output	The ignition switch ON		5 V
6 (W)	Ground	Height sensor power supply	Output	The ignition switch ON		5 V
7 (P)	Ground	CAN-L	Input/ output	—		—
8 (B)	Ground	Height sensor ground	Input	The ignition switch ON		0 V
9 (GR)	Ground	Right swivel position sensor signal	Output	Right headlamp swivel angle	0°	0.7 V
					15°	2.8 V
11 (R)	Ground	Right swivel motor 1-phase (-)	Output	Right headlamp swivel	Activation	Reference waveform 
						8 - 12 V
13 (B)	Ground	Right swivel motor 2-phase (-)	Output	Right headlamp swivel	Stopped	9.5 - 11.5 V
15 (G)	Ground	Left swivel motor 1-phase (+)	Output	Left headlamp swivel	Activation	Reference waveform 
						8 - 12 V
17 (W)	Ground	Left swivel motor 2-phase (+)	Output	Left headlamp swivel	Stopped	9.5 - 11.5 V
19 (SB)	Ground	Right levelizer signal	Output	Right headlamp leveling	Unloaded vehicle condition	8.8 V
					Leveling operation downward edge	4.4 V (With 17-inch wheel)
						4.0 V (With 18-inch wheel)
24 (V)	Ground	Left swivel position sensor power supply	Output	The ignition switch ON		5 V
25 (B)	Ground	Ground	—	The ignition switch ON		0 V
27 (BR)	Ground	Left swivel position sensor ground	Input	The ignition switch ON		0 V

A
B
C
D
E
F
G
H
I
J
K
L
M
N
O
P

EXL

AFS CONTROL UNIT

< ECU DIAGNOSIS >

[XENON TYPE]

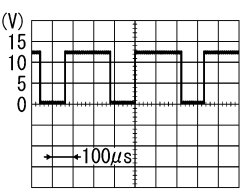
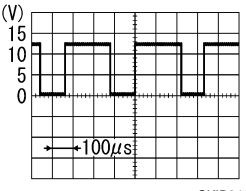
Terminal No. (Wire color)		Description		Condition		Value (Approx.)
+	-	Signal name	Input/ output			
28 (SB)	Ground	Height sensor signal	Output	Vehicle rear height	Unloaded vehicle condition	2.5 V
					Low (Leveling operation downward edge)	1.6 V
29 (O)	Ground	Left swivel position sensor signal	Output	Left headlamp swivel angle	0°	0.7 V
					17°	3.0 V
30 (L)	Ground	CAN-H	Input/ output	—		—
32 (G)	Ground	Right swivel motor 2-phase (+)	Output	Right headlamp swivel	Activation	Reference waveform  SKIB2408J 8 - 12 V
						8 - 12 V
34 (W)	Ground	Right swivel motor 1-phase (+)	Output	Right headlamp swivel	Stopped	9.5 - 11.5 V
36 (R)	Ground	Left swivel motor 2-phase (-)	Output	Left headlamp swivel	Activation	Reference waveform  SKIB2408J 8 - 12 V
						8 - 12 V
38 (B)	Ground	Left swivel motor 1-phase (-)	Output	Left headlamp swivel	Stopped	9.5 - 11.5 V
40 (L)	Ground	Left levelizer signal	Output	Right headlamp leveling	Unloaded vehicle condition	8.8 V
					Leveling operation downward edge	4.4 V (With 17-inch wheel)
					Leveling operation downward edge	4.0 V (With 18-inch wheel)

AFS CONTROL UNIT

< ECU DIAGNOSIS >

[XENON TYPE]

Wiring Diagram - ACTIVE AFS -

INFOID:000000003135375

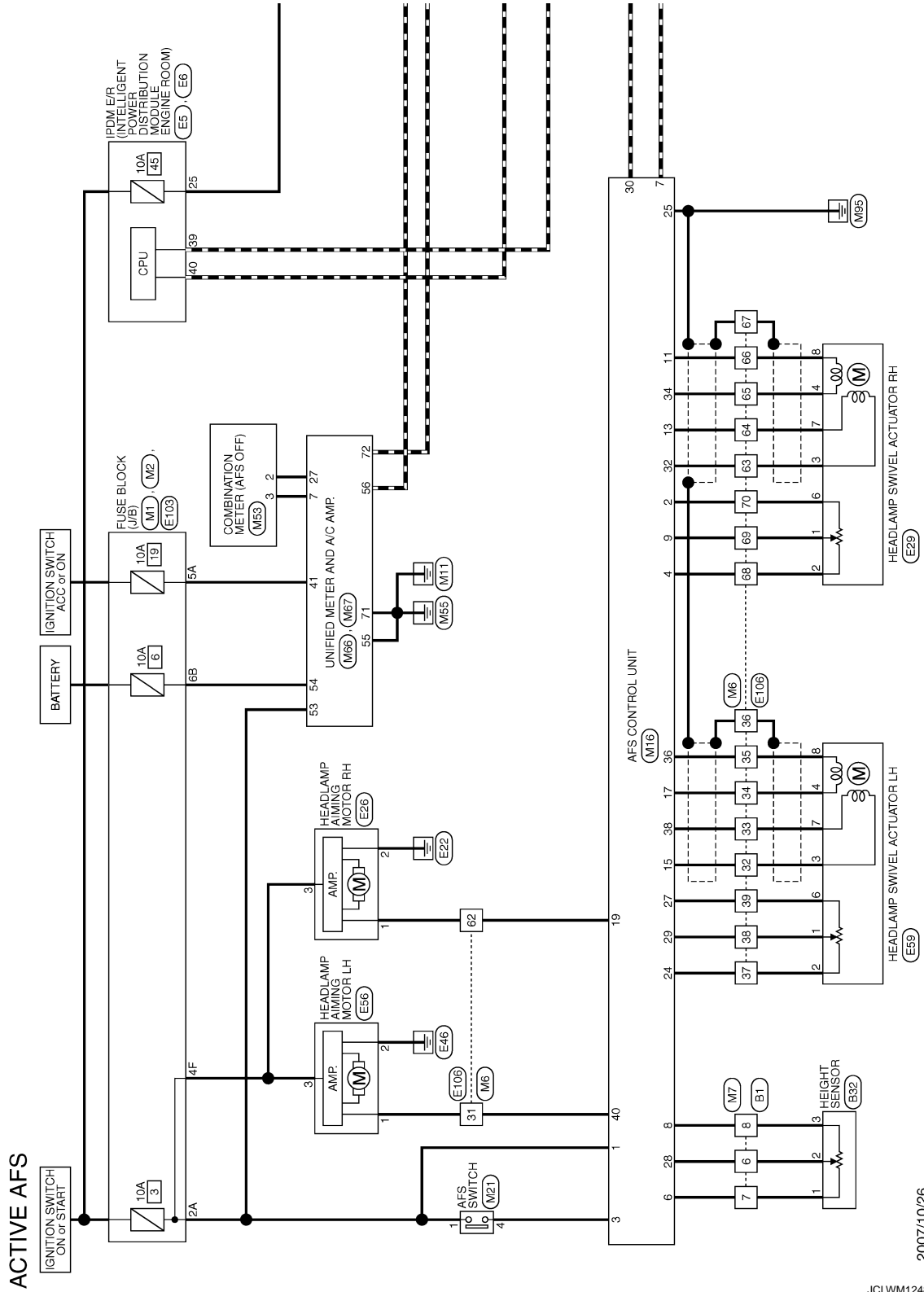

2007/10/26

JCLWM1248GE

A
B
C
D
E
F
G
H
I
J
K
EXL
M
N
O
P

AFS CONTROL UNIT

< ECU DIAGNOSIS >

[XENON TYPE]

FM : With automatic drive positioner
OP : Without automatic drive positioner

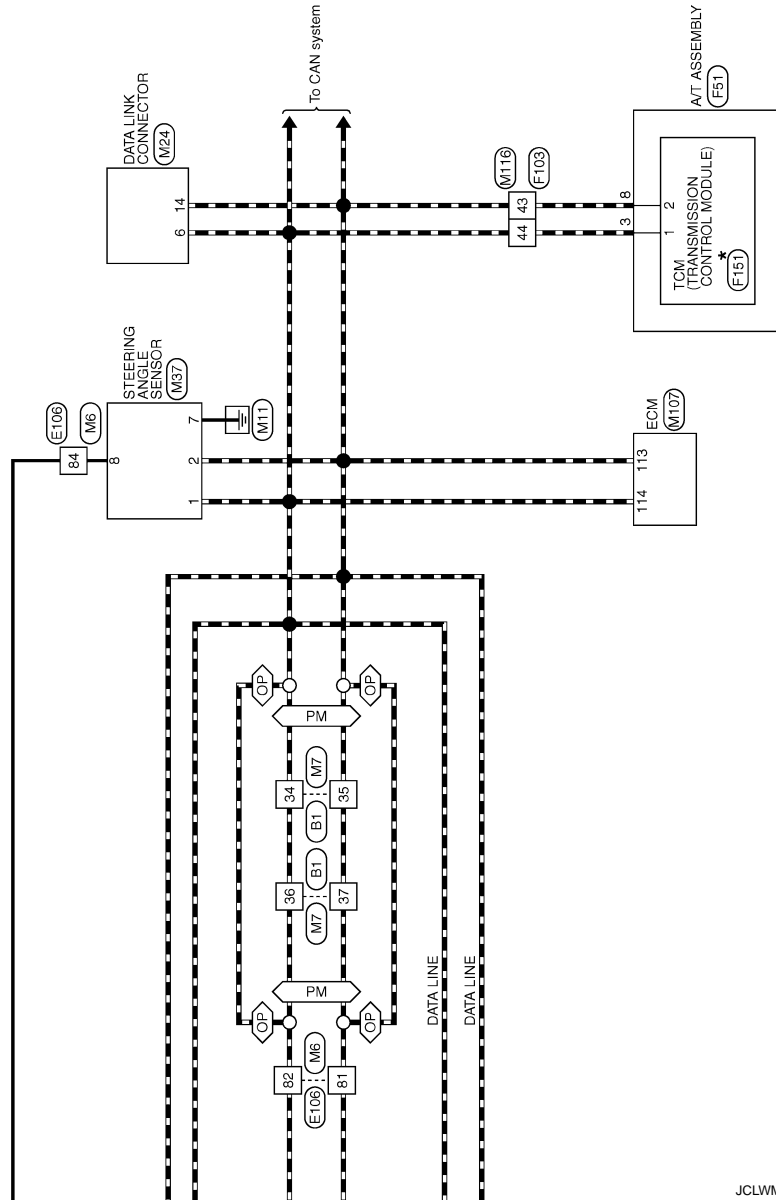

*: This connector is not shown in "Harness Layout".







JCLW1249GE

AFS CONTROL UNIT

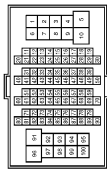
< ECU DIAGNOSIS >

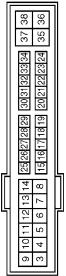
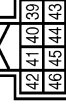
[XENON TYPE]

ACTIVE AFS

<p>Connector No. B1 Connector Name WIRE TO WIRE Connector Type TH8DFW-CS16-TM4</p>  <p>H.S.</p>	<p>Terminal No. Color of Wire Signal Name [Specification]</p> <table border="1"> <tr><td>6</td><td>SB</td><td>-</td></tr> <tr><td>7</td><td>V</td><td>-</td></tr> <tr><td>8</td><td>GR</td><td>-</td></tr> <tr><td>34</td><td>L</td><td>-</td></tr> <tr><td>35</td><td>P</td><td>-</td></tr> <tr><td>36</td><td>L</td><td>-</td></tr> <tr><td>37</td><td>P</td><td>-</td></tr> </table>	6	SB	-	7	V	-	8	GR	-	34	L	-	35	P	-	36	L	-	37	P	-
6	SB	-																				
7	V	-																				
8	GR	-																				
34	L	-																				
35	P	-																				
36	L	-																				
37	P	-																				
<p>Connector No. E32 Connector Name HEIGHT SENSOR Connector Type RH0GFB</p>  <p>H.S.</p>	<p>Terminal No. Color of Wire Signal Name [Specification]</p> <table border="1"> <tr><td>1</td><td>V</td><td>-</td></tr> <tr><td>2</td><td>SB</td><td>-</td></tr> <tr><td>3</td><td>GR</td><td>-</td></tr> </table>	1	V	-	2	SB	-	3	GR	-												
1	V	-																				
2	SB	-																				
3	GR	-																				
<p>Connector No. E5 Connector Name IPDM E/R (INTELLIGENT POWER DISTRIBUTION MODULE ENGINE ROOM) Connector Type TH2DFW-CS12-M4-1V</p>  <p>H.S.</p>	<p>Terminal No. Color of Wire Signal Name [Specification]</p> <table border="1"> <tr><td>25</td><td>G</td><td>-</td></tr> </table>	25	G	-																		
25	G	-																				
<p>Connector No. E6 Connector Name IPDM E/R (INTELLIGENT POWER DISTRIBUTION MODULE ENGINE ROOM) Connector Type TH8DFW-NH</p>  <p>H.S.</p>	<p>Terminal No. Color of Wire Signal Name [Specification]</p> <table border="1"> <tr><td>39</td><td>P</td><td>-</td></tr> <tr><td>40</td><td>L</td><td>-</td></tr> </table>	39	P	-	40	L	-															
39	P	-																				
40	L	-																				
<p>Connector No. E26 Connector Name HEADLAMP AIMING MOTOR RH Connector Type HS03FGY</p>  <p>H.S.</p>	<p>Terminal No. Color of Wire Signal Name [Specification]</p> <table border="1"> <tr><td>1</td><td>SB</td><td>-</td></tr> <tr><td>2</td><td>B</td><td>-</td></tr> <tr><td>3</td><td>G</td><td>-</td></tr> </table>	1	SB	-	2	B	-	3	G	-												
1	SB	-																				
2	B	-																				
3	G	-																				
<p>Connector No. E29 Connector Name HEADLAMP SWIVEL ACTUATOR RH Connector Type RS08FGY-PR</p>  <p>H.S.</p>	<p>Terminal No. Color of Wire Signal Name [Specification]</p> <table border="1"> <tr><td>1</td><td>LG</td><td>-</td></tr> <tr><td>2</td><td>Y</td><td>-</td></tr> <tr><td>3</td><td>W</td><td>-</td></tr> <tr><td>4</td><td>G</td><td>-</td></tr> <tr><td>6</td><td>W</td><td>-</td></tr> <tr><td>7</td><td>B</td><td>-</td></tr> <tr><td>8</td><td>R</td><td>-</td></tr> </table>	1	LG	-	2	Y	-	3	W	-	4	G	-	6	W	-	7	B	-	8	R	-
1	LG	-																				
2	Y	-																				
3	W	-																				
4	G	-																				
6	W	-																				
7	B	-																				
8	R	-																				
<p>Connector No. E56 Connector Name HEADLAMP AIMING MOTOR LH Connector Type HS03FGY</p>  <p>H.S.</p>	<p>Terminal No. Color of Wire Signal Name [Specification]</p> <table border="1"> <tr><td>1</td><td>O</td><td>-</td></tr> <tr><td>2</td><td>B</td><td>-</td></tr> <tr><td>3</td><td>G</td><td>-</td></tr> </table>	1	O	-	2	B	-	3	G	-												
1	O	-																				
2	B	-																				
3	G	-																				
<p>Connector No. E59 Connector Name HEADLAMP SWIVEL ACTUATOR LH Connector Type RS08FGY-PR</p>  <p>H.S.</p>	<p>Terminal No. Color of Wire Signal Name [Specification]</p> <table border="1"> <tr><td>1</td><td>BR</td><td>-</td></tr> <tr><td>2</td><td>V</td><td>-</td></tr> <tr><td>3</td><td>W</td><td>-</td></tr> <tr><td>4</td><td>R</td><td>-</td></tr> <tr><td>6</td><td>O</td><td>-</td></tr> <tr><td>7</td><td>B</td><td>-</td></tr> <tr><td>8</td><td>G</td><td>-</td></tr> </table>	1	BR	-	2	V	-	3	W	-	4	R	-	6	O	-	7	B	-	8	G	-
1	BR	-																				
2	V	-																				
3	W	-																				
4	R	-																				
6	O	-																				
7	B	-																				
8	G	-																				

JCLWM1250GE

A
B
C
D
E
F
G
H
I
J
K
EXL
M
N
O
P

AFS CONTROL UNIT

< ECU DIAGNOSIS >

[XENON TYPE]

ACTIVE AFS

Connector No.	E103
Connector Name	FUSE BLOCK (J/B)
Connector Type	NS16FW-CS



Terminal No.	4F	Color of Wire	G	Signal Name [Specification]	-
--------------	----	---------------	---	-----------------------------	---

Connector No.	E106
Connector Name	WIRE TO WIRE
Connector Type	TK86FW-CS16-TM4

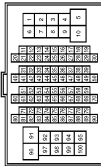

Terminal No.	Color of Wire	Signal Name [Specification]
31	O	-
32	W	-
33	B	-
34	R	-
35	G	-
36	SHIELD	-
37	V	-
38	BR	-
39	O	-
62	SB	-
63	W	-

Connector No.	F103
Connector Name	WIRE TO WIRE
Connector Type	TK36FW-NS10



Terminal No.	43	Color of Wire	P	Signal Name [Specification]	-
44	L	-	-	-	-

64	B	-
65	G	-
66	R	-
67	SHIELD	-
68	Y	-
69	LG	-
70	W	-
81	P	-
82	L	-
84	G	-

Connector No.	F51
Connector Name	A/T ASSEMBLY
Connector Type	RK10FG-DGY

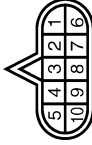

Terminal No.	Color of Wire	Signal Name [Specification]
3	L	-
8	P	-

Connector No.	M1
Connector Name	FUSE BLOCK (J/B)
Connector Type	NS06FW-M2



Terminal No.	Color of Wire	Signal Name [Specification]
2A	G	-
5A	V	-

Connector No.	M2
Connector Name	FUSE BLOCK (J/B)
Connector Type	NS10FW-CS



Terminal No.	Color of Wire	Signal Name [Specification]
8B	Y	-

Connector No.	F151
Connector Name	TCM (TRANSMISSION CONTROL MODULE)
Connector Type	SP10FBGY



Terminal No.	Color of Wire	Signal Name [Specification]
1	BR	CAN-H
2	L/Y	CAN-L

AFS CONTROL UNIT

< ECU DIAGNOSIS >

[XENON TYPE]

ACTIVE AFS

Connector No.	M16
Connector Name	WIRE TO WIRE
Connector Type	TH80MW-CS16-TM4

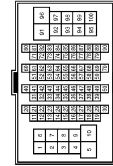

Terminal No.	Color of Wire	Signal Name [Specification]
31	L	-
32	G	-
33	B	-
34	W	-
35	R	-
36	SHIELD	-
37	V	-
38	O	-
39	BR	-
62	SB	-
63	G	-

Connector No.	M18
Connector Name	AFS CONTROL UNIT
Connector Type	TH40FW-NH



Terminal No.	Color of Wire	Signal Name [Specification]
1	Y	IGN
2	LG	PSG-R
3	GR	SW
4	Y	PSV-R
6	W	HSV-R
7	P	CAN-L
8	B	HSC-R
9	GR	PS-R
11	R	SMR-1 (-)
13	B	SMR-2 (-)
15	G	SML-1 (+)

64	B	-
65	W	-
66	R	-
67	SHIELD	-
68	Y	-
69	GR	-
70	LG	-
81	P	-
82	L	-
84	G	-

Connector No.	M7
Connector Name	WIRE TO WIRE
Connector Type	TH80MW-CS16-TM4

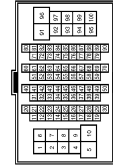

Terminal No.	Color of Wire	Signal Name [Specification]
6	SB	-
7	W	-
8	B	-
34	L	-
35	P	-
36	L	-
37	P	-

17	W	SML-2 (+)
19	SB	AMDS-R
24	V	PSV-L
25	B	GND
27	BR	PSG-L
28	SB	HS-L
29	O	PS-L
30	L	CAN-H
32	G	SMR-2 (+)
34	W	SMR-1 (+)
36	R	SML-2 (-)
38	B	SML-1 (-)
40	L	AMDS-L

Connector No.	M21
Connector Name	AFS SWITCH
Connector Type	TK81FW-1V

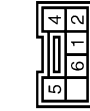

Terminal No.	Color of Wire	Signal Name [Specification]
1	Y	-
4	GR	-

Connector No.	M24
Connector Name	DATA LINK CONNECTOR
Connector Type	BD16FW

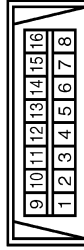

Terminal No.	Color of Wire	Signal Name [Specification]
6	L	-
14	P	-

A
B
C
D
E
F
G
H
I
J
K
EXL
M
N
O
P

AFS CONTROL UNIT

< ECU DIAGNOSIS >

[XENON TYPE]

ACTIVE AFS

Connector No.	M67
Connector Name	UNIFIED METER AND A/C AMP.
Connector Type	TH32FW-NH



1	2	3	4	5	6	7	8	9	10	11	12	13	14	15	16	17	18	19	20	21	22	23	24	25	26	27	28	29	30	31	32	33	34	35	36	37	38	39	40	41	42	43	44	45	46	47	48	49	50	51	52	53	54	55	56	71	72
---	---	---	---	---	---	---	---	---	----	----	----	----	----	----	----	----	----	----	----	----	----	----	----	----	----	----	----	----	----	----	----	----	----	----	----	----	----	----	----	----	----	----	----	----	----	----	----	----	----	----	----	----	----	----	----	----	----

Terminal No.	Color of Wire	Signal Name [Specification]
41	V	AGC
53	Y	IGN
54	Y	BAT
55	B	GND
56	L	CAN-H
71	B	GND
72	P	CAN-L

Connector No.	M66
Connector Name	UNIFIED METER AND A/C AMP.
Connector Type	TH40FW-NH



1	2	3	4	5	6	7	8	9	10	11	12	13	14	15	16	17	18	19	20	21	22	23	24	25	26	27	28	29	30	31	32	33	34	35	36	37	38	39	40	41	42	43	44	45	46	47	48	49	50	51	52	53	54	55	56	57	58	59	60	61	62	63	64	65	66	67	68	69	70	71	72	73	74	75	76	77	78	79	80	81	82	83	84	85	86	87	88	89	90	91	92	93	94	95	96	97	98	99	100
---	---	---	---	---	---	---	---	---	----	----	----	----	----	----	----	----	----	----	----	----	----	----	----	----	----	----	----	----	----	----	----	----	----	----	----	----	----	----	----	----	----	----	----	----	----	----	----	----	----	----	----	----	----	----	----	----	----	----	----	----	----	----	----	----	----	----	----	----	----	----	----	----	----	----	----	----	----	----	----	----	----	----	----	----	----	----	----	----	----	----	----	----	----	----	----	----	----	----	-----

Terminal No.	Color of Wire	Signal Name [Specification]
7	GR	COMM (AMP->METER)
27	LG	COMM (METER->AMP)

Connector No.	M65
Connector Name	COMBINATION METER
Connector Type	TH40FW-NH



1	2	3	4	5	6	7	8	9	10	11	12	13	14	15	16	17	18	19	20	21	22	23	24	25	26	27	28	29	30	31	32	33	34	35	36	37	38	39	40	41	42	43	44	45	46	47	48	49	50	51	52	53	54	55	56	57	58	59	60	61	62	63	64	65	66	67	68	69	70	71	72	73	74	75	76	77	78	79	80	81	82	83	84	85	86	87	88	89	90	91	92	93	94	95	96	97	98	99	100
---	---	---	---	---	---	---	---	---	----	----	----	----	----	----	----	----	----	----	----	----	----	----	----	----	----	----	----	----	----	----	----	----	----	----	----	----	----	----	----	----	----	----	----	----	----	----	----	----	----	----	----	----	----	----	----	----	----	----	----	----	----	----	----	----	----	----	----	----	----	----	----	----	----	----	----	----	----	----	----	----	----	----	----	----	----	----	----	----	----	----	----	----	----	----	----	----	----	----	-----

Terminal No.	Color of Wire	Signal Name [Specification]
2	LG	COMM (METER->AMP)
3	GR	COMM (AMP->METER)

Connector No.	M116
Connector Name	WIRE TO WIRE
Connector Type	TK38MW-NS10



1	2	3	4	5	6	7	8	9	10	11	12	13	14	15	16	17	18	19	20	21	22	23	24	25	26	27	28	29	30	31	32	33	34	35	36	37	38	39	40	41	42	43	44	45	46	47	48	49	50	51	52	53	54	55	56	57	58	59	60	61	62	63	64	65	66	67	68	69	70	71	72	73	74	75	76	77	78	79	80	81	82	83	84	85	86	87	88	89	90	91	92	93	94	95	96	97	98	99	100
---	---	---	---	---	---	---	---	---	----	----	----	----	----	----	----	----	----	----	----	----	----	----	----	----	----	----	----	----	----	----	----	----	----	----	----	----	----	----	----	----	----	----	----	----	----	----	----	----	----	----	----	----	----	----	----	----	----	----	----	----	----	----	----	----	----	----	----	----	----	----	----	----	----	----	----	----	----	----	----	----	----	----	----	----	----	----	----	----	----	----	----	----	----	----	----	----	----	----	-----

Terminal No.	Color of Wire	Signal Name [Specification]
43	P	-
44	L	-

Connector No.	M107
Connector Name	ECM
Connector Type	RH24FGY-RZ8-R-LH-Z



128	124	123	16	12	13	14	10	11	12	13	14	15	16	17	18	19	20	21	22	23	24	25	26	27	28	29	30	31	32	33	34	35	36	37	38	39	40	41	42	43	44	45	46	47	48	49	50	51	52	53	54	55	56	57	58	59	60	61	62	63	64	65	66	67	68	69	70	71	72	73	74	75	76	77	78	79	80	81	82	83	84	85	86	87	88	89	90	91	92	93	94	95	96	97	98	99	100
-----	-----	-----	----	----	----	----	----	----	----	----	----	----	----	----	----	----	----	----	----	----	----	----	----	----	----	----	----	----	----	----	----	----	----	----	----	----	----	----	----	----	----	----	----	----	----	----	----	----	----	----	----	----	----	----	----	----	----	----	----	----	----	----	----	----	----	----	----	----	----	----	----	----	----	----	----	----	----	----	----	----	----	----	----	----	----	----	----	----	----	----	----	----	----	----	----	----	-----

Terminal No.	Color of Wire	Signal Name [Specification]
113	P	VEHCAN-L1
114	L	VEHCAN-H1

JCLWM1253GE

AFS CONTROL UNIT

< ECU DIAGNOSIS >

[XENON TYPE]

Fail-Safe

INFOID:000000003135376

DTC	Fail-safe	AFS OFF indicator lamp	Cancellation
CAN COMM CIRCUIT [U1000]	<ul style="list-style-type: none"> Right and left swivel motors stop at the position when DTC is detected. Right and left aiming motors stop at the position when DTC is detected. 	Blinks 1 second each.	Ignition switch OFF
CONTROL UNIT (CAN) [U1010]	<ul style="list-style-type: none"> Right and left swivel motors stop at the position when DTC is detected. Right and left aiming motors stop at the position when DTC is detected. 	Blinks 1 second each.	Ignition switch OFF
SWIVEL ACTUATOR [RH, LH] [B2503, B2504]	<ul style="list-style-type: none"> Right and left swivel motors stop at the position when DTC is detected. The signal, approximately 2 V decreased from the levelizer signal when DTC detected, is output. 	Blinks 1 second each.	Ignition switch OFF
HI SEN UNUSUAL [RR] [B2514]	<ul style="list-style-type: none"> Right and left aiming motors stop at the position when DTC is detected. 	—	Ignition switch OFF
ST ANG SEN SIG [C0126]	<ul style="list-style-type: none"> Right and left swivel motor swivel angle returns to 0° and fixed. 	Blinks 1 second each.	Ignition switch OFF
SHIFT SIG [P, R] [B2516]	<ul style="list-style-type: none"> Right and left swivel motor swivel angle returns to 0° and fixed. 	Blinks 1 second each.	Ignition switch OFF
VEHICLE SPEED SIG [B2517]	<ul style="list-style-type: none"> Right and left swivel motor swivel angle returns to 0° and fixed. Right and left aiming motors stop at the position when DTC is detected. 	Blinks 1 second each.	Ignition switch OFF
LEVELIZER CALIB [B2519]	<ul style="list-style-type: none"> Right and left aiming motors stop at the position when DTC is detected. 	—	When the levelizer adjustment is completed.
ST ANGLE SEN CALIB [C0428]	<ul style="list-style-type: none"> Right and left swivel motor swivel angle returns to 0° and fixed. 	Blinks 1 second each.	When the steering angle sensor neutral position registration is completed
ECU CIRC [B2521]	<ul style="list-style-type: none"> Right and left swivel motors stop at the position when DTC is detected. Right and left aiming motors stop at the position when DTC is detected. 	Blinks 1 second each.	Ignition switch OFF

DTC Inspection Priority Chart

INFOID:000000003135377

If some DTCs are displayed at the same time, perform inspections one by one based on the following priority chart.

NOTE:

- If DTC U1000 is displayed with other DTC, first perform the trouble diagnosis for DTC U1000.
- If DTC U1010 is displayed with other DTC, first perform the trouble diagnosis for DTC U1010.

Priority	Detected items (DTC)
1	<ul style="list-style-type: none"> U1000 CAN COMM CIRCUIT U1010 CONTROL UNIT (CAN)
2	<ul style="list-style-type: none"> B2519 LEVELIZER CALIB B2521 ECU CIRC C0428 ST ANG SEN CALIB
3	<ul style="list-style-type: none"> B2503 SWIVEL ACTUATOR [RH] B2504 SWIVEL ACTUATOR [LH] B2514 HI SEN UNUSUAL [RR] B2516 SHIFT SIG [P, R] B2517 VEHICLE SPEED SIG C0126 ST ANG SEN SIG

AFS CONTROL UNIT

< ECU DIAGNOSIS >

[XENON TYPE]

DTC Index

INFOID:000000003135378

×: Applicable

CONSULT indication	Fail-safe	AFS OFF indicator lamp	Reference
U1000: CAN COMM CIRCUIT	×	×	EXL-61, "Description"
U1010: CONTROL UNIT (CAN)	×	×	EXL-62, "DTC Logic"
B2503, B2504: SWIVEL ACTUATOR [RH, LH]	×	×	EXL-44, "Description"
B2514: HI SEN UNUSUAL [RR]	×		EXL-50, "Description"
B2516: SHIFT SIG [P, R]	×	×	EXL-53, "Description"
B2517: VEHICLE SPEED SIG	×	×	EXL-54, "Description"
B2519: LEVELIZER CALIB	×		EXL-55, "Description"
B2521: ECU CIRC	×	×	EXL-56, "Description"
C0126: ST ANG SEN SIG	×	×	EXL-59, "Description"
C0428: ST ANGLE SEN CALIB	×	×	EXL-60, "Description"

EXTERIOR LIGHTING SYSTEM SYMPTOMS

< SYMPTOM DIAGNOSIS >

[XENON TYPE]

SYMPTOM DIAGNOSIS

EXTERIOR LIGHTING SYSTEM SYMPTOMS

Symptom Table

INFOID:000000003135379

CAUTION:

Perform the self-diagnosis with CONSULT-III before the symptom diagnosis. Perform the trouble diagnosis if any DTC is detected.

Symptom		Possible cause	Inspection item
Headlamp (HI) is not turned ON.	One side	<ul style="list-style-type: none"> • Fuse • Halogen bulb (HI) • Harness between IPDM E/R and the headlamp high • IPDM E/R 	Headlamp (HI) circuit Refer to EXL-67 .
	Both sides	Symptom diagnosis "BOTH SIDE HEADLAMPS (HI) ARE NOT TURNED ON" Refer to EXL-182 .	
Headlamp (HI) is not turned OFF.	When ignition switch is turned ON.	"BOTH SIDE HEADLAMPS (HI) ARE NOT TURNED ON" Refer to EXL-182 .	
	When ignition switch is turned OFF.	IPDM E/R	—
High beam indicator lamp is not turned ON. [The headlamp (HI) is turned ON.]		Combination meter	<ul style="list-style-type: none"> • Combination meter • Data monitor "HI-BEAM IND" • BCM (HEAD LAMP) • Active test "HEADLAMP"
Headlamp (LO) is not turned ON.	One side	<ul style="list-style-type: none"> • Fuse • Xenon bulb (LO) • Harness between IPDM E/R and the headlamp low • IPDM E/R 	Headlamp (LO) circuit Refer to EXL-69 .
	Both sides	Symptom diagnosis "BOTH SIDE HEADLAMPS (LO) ARE NOT TURNED ON" Refer to EXL-183 .	
Headlamp (LO) is not turned OFF.	When ignition switch is turned ON.	"BOTH SIDE HEADLAMPS (LO) ARE NOT TURNED ON" Refer to EXL-183 .	
	When ignition switch is turned OFF.	IPDM E/R	—
Headlamp is not turned ON/OFF with the lighting switch AUTO.		<ul style="list-style-type: none"> • Combination switch • Harness between the combination switch and BCM • BCM 	Combination switch Refer to BCS-82 .
		<ul style="list-style-type: none"> • Optical sensor • Harness between the optical sensor and BCM • BCM 	Optical sensor Refer to EXL-81 .
Front fog lamp is not turned ON.	One side	<ul style="list-style-type: none"> • Front fog lamp bulb • Harness between IPDM E/R and the front combination lamp • Front combination lamp • IPDM E/R 	Front fog lamp circuit Refer to EXL-75 .
	Both side	Symptom diagnosis "BOTH SIDE FRONT FOG LAMPS ARE NOT TURNED ON" Refer to EXL-185 .	
Front fog lamp is not turned ON.		"BOTH SIDE FRONT FOG LAMPS ARE NOT TURNED ON" Refer to EXL-185 .	
Parking lamp is not turned ON.		<ul style="list-style-type: none"> • Fuse • Parking lamp bulb • Harness between IPDM E/R and the front combination lamp • Front combination lamp • IPDM E/R 	Parking lamp circuit Refer to EXL-77 .

A
B
C
D
E
F
G
H
I
J
K
L
M
N
O
P

EXL

EXTERIOR LIGHTING SYSTEM SYMPTOMS

< SYMPTOM DIAGNOSIS >

[XENON TYPE]

Symptom	Possible cause	Inspection item	
Tail lamp is not turned ON.	<ul style="list-style-type: none"> • Harness between IPDM E/R and the rear combination lamp • Rear combination lamp 	Tail lamp circuit Refer to EXL-86 .	
License plate lamp is not turned ON.	<ul style="list-style-type: none"> • Harness between IPDM E/R and the license plate lamp • License plate lamp 	License plate lamp circuit Refer to EXL-88 .	
Tail lamp and the license plate lamp are not turned ON.	<ul style="list-style-type: none"> • Fuse • Harness between IPDM E/R and the rear combination lamp • IPDM E/R 	Tail lamp circuit Refer to EXL-86 .	
<ul style="list-style-type: none"> • Parking lamp, the tail lamp and the license plate lamp are not turned ON. • Parking lamp, the tail lamp and the license plate lamp are not turned OFF. (Each illumination is turned ON/OFF.)	Symptom diagnosis "PARKING, LICENSE PLATE AND TAIL LAMPS ARE NOT TURNED ON" Refer to EXL-184 .		
Turn signal lamp does not blink.	Indicator lamp is normal. (The applicable side performs the high flasher activation.)	<ul style="list-style-type: none"> • Harness between BCM and each turn signal lamp • Turn signal lamp bulb 	Turn signal lamp circuit Refer to EXL-79 .
	Indicator lamp is included	<ul style="list-style-type: none"> • Combination switch • Harness between the combination switch and BCM • BCM 	Combination switch Refer to BCS-82 .
Turn signal indicator lamp does not blink. (The turn signal indicator lamp is normal.)	One side	Combination meter	—
	Both sides (Always)	<ul style="list-style-type: none"> • Turn signal indicator lamp signal - Unified meter and A/C amp. - BCM • Combination meter 	<ul style="list-style-type: none"> • Unified meter and A/C amp. Data monitor "TURN IND" • BCM (FLASHER) Active test "FLASHER"
	Both sides (Only when activating the hazard warning lamp with the ignition switch OFF)	<ul style="list-style-type: none"> • The combination meter power supply and the ground circuit • Combination meter 	Combination meter Power supply and the ground circuit Refer to MWI-53 .
<ul style="list-style-type: none"> • Hazard warning lamp does not activate. • Hazard warning lamp continues activating. (Turn signal is normal.)	<ul style="list-style-type: none"> • Hazard switch • Harness between the hazard switch and BCM • BCM 	Hazard switch Refer to EXL-84 .	
Headlamp auto aiming does not activate. (AFS is normal.)	<ul style="list-style-type: none"> • Harness between AFS control unit and aiming motor • Front combination lamp (Aiming motor) • AFS control unit 	Headlamp levelizer circuit Refer to EXL-73 .	
AFS OFF indicator lamp is not turned ON.	<ul style="list-style-type: none"> • AFS OFF indicator lamp signal - Unified meter and A/C amp. - AFS control unit • Combination meter 	Unified meter and A/C amp. Data monitor "AFS OFF IND"	

NORMAL OPERATING CONDITION

< SYMPTOM DIAGNOSIS >

[XENON TYPE]

NORMAL OPERATING CONDITION

Description

INFOID:000000003135380

XENON HEADLAMP

- Brightness and the color of light may change slightly immediately after turning the headlamp ON until the xenon bulb becomes stable. This is normal.
- Illumination time lag may occur between right and left. This is normal.

AUTO LIGHT SYSTEM

The headlamp may not be turned ON/OFF immediately after passing dark area or bright area (short tunnel, sky bridge, shadowed area etc.) while using the auto light system. This causes for the control difference. This is normal.

A
B
C
D
E
F
G
H
I
J
K
EXL
M
N
O
P

EXL

BOTH SIDE HEADLAMPS (HI) ARE NOT TURNED ON

< SYMPTOM DIAGNOSIS >

[XENON TYPE]

BOTH SIDE HEADLAMPS (HI) ARE NOT TURNED ON

Description

INFOID:000000003534177

Both side headlamps (HI) are not turned ON when setting to the lighting switch HI or PASS.

Diagnosis Procedure

INFOID:000000003534178

1.COMBINATION SWITCH INSPECTION

Check the combination switch. Refer to [BCS-82, "Symptom Table"](#).

Is the combination switch normal?

YES >> GO TO 2.

NO >> Repair or replace the malfunctioning part.

2.CHECK HEADLAMP (HI) REQUEST SIGNAL INPUT

ⓅCONSULT-III DATA MONITOR

1. Select "HL HI REQ" of IPDM E/R data monitor item.
2. With operating the lighting switch, check the monitor status.

Monitor item	Condition		Monitor status
HL HI REQ	Lighting switch (2ND)	HI or PASS	On
		LO	Off

Is the item status normal?

YES >> GO TO 3.

NO >> Replace BCM. Refer to [BCS-84, "Exploded View"](#).

3.HEADLAMP (HI) CIRCUIT INSPECTION

Check the headlamp (HI) circuit. Refer to [EXL-67, "Component Function Check"](#).

Is the headlamp (HI) circuit normal?

YES >> Replace IPDM E/R.

NO >> Repair or replace the malfunctioning part.

BOTH SIDE HEADLAMPS (LO) ARE NOT TURNED ON

< SYMPTOM DIAGNOSIS >

[XENON TYPE]

BOTH SIDE HEADLAMPS (LO) ARE NOT TURNED ON

Description

INFOID:000000003135383

The headlamps (both sides) are not turned ON in any condition.

Diagnosis Procedure

INFOID:000000003135384

1. CHECK COMBINATION SWITCH

Check the combination switch. Refer to [BCS-82. "Symptom Table"](#).

Is the combination switch normal?

YES >> GO TO 2.

NO >> Repair or replace the malfunctioning part.

2. CHECK HEADLAMP (LO) REQUEST SIGNAL INPUT

 CONSULT-III DATA MONITOR

1. Select "HL LO REQ" of IPDM E/R data monitor item.

2. With operating the lighting switch, check the monitor status.

Monitor item	Condition		Monitor status
HL LO REQ	Lighting switch	2ND	On
		OFF	Off

Is the item status normal?

YES >> GO TO 3.

NO >> Replace BCM.

3. HEADLAMP (LO) CIRCUIT INSPECTION

Check the headlamp (LO) circuit. Refer to [EXL-69. "Description"](#).

Is the headlamp (LO) circuit normal?

YES >> Replace IPDM E/R.

NO >> Repair or replace the malfunctioning part.

A
B
C
D
E
F
G
H
I
J
K

EXL

M
N
O
P

PARKING, LICENSE PLATE AND TAIL LAMPS ARE NOT TURNED ON

< SYMPTOM DIAGNOSIS >

[XENON TYPE]

PARKING, LICENSE PLATE AND TAIL LAMPS ARE NOT TURNED ON

Description

INFOID:000000003135385

The parking, license plate, tail, side marker lamps and each illumination are not turned ON in any condition.

Diagnosis Procedure

INFOID:000000003135386

1.COMBINATION SWITCH INSPECTION

Check the combination switch. Refer to [BCS-82, "Symptom Table"](#).

Is the combination switch normal?

YES >> GO TO 2.

NO >> Repair or replace the malfunctioning part.

2.CHECK TAIL LAMP RELAY REQUEST SIGNAL INPUT

ⓅCONSULT-III DATA MONITOR

1. Select "TAIL & CLR REQ" of IPDM E/R data monitor item.
2. With operating the lighting switch, check the monitor status.

Monitor item	Condition	Monitor status	
TAIL & CLR REQ	Lighting switch	1ST	On
		OFF	Off

Is the item status normal?

YES >> GO TO 3.

NO >> Replace BCM.

3.TAIL LAMP CIRCUIT INSPECTION

Check the tail lamp circuit. Refer to [EXL-86, "Component Function Check"](#).

Is the tail lamp circuit normal?

YES >> Replace IPDM E/R.

NO >> Repair or replace the malfunctioning part.

BOTH SIDE FRONT FOG LAMPS ARE NOT TURNED ON

< SYMPTOM DIAGNOSIS >

[XENON TYPE]

BOTH SIDE FRONT FOG LAMPS ARE NOT TURNED ON

Description

INFOID:000000003135387

The front fog lamps are not turned ON in any condition.

Diagnosis Procedure

INFOID:000000003135388

1.COMBINATION SWITCH INSPECTION

Check the combination switch. Refer to [BCS-82. "Symptom Table"](#).

Is the combination switch normal?

YES >> GO TO 2.

NO >> Repair or replace the malfunctioning part.

2.CHECK FRONT FOG LAMP REQUEST SIGNAL INPUT

 CONSULT-III DATA MONITOR

1. Select "FR FOG REQ" of IPDM E/R data monitor item.
2. With operating the front fog lamp switch, check the monitor status.

Monitor item	Condition	Monitor status	
FR FOG REQ	Front fog lamp switch (Lighting switch 2ND)	ON	On
		OFF	Off

Is the item status normal?

YES >> GO TO 3.

NO >> Replace BCM.

3.FRONT FOG LAMP CIRCUIT INSPECTION

Check the front fog lamp circuit. Refer to [EXL-75. "Component Function Check"](#).

Is the front fog lamp circuit normal?

YES >> Replace IPDM E/R.

NO >> Repair or replace the malfunctioning part.

A
B
C
D
E
F
G
H
I
J
K
EXL
M
N
O
P

PRECAUTION

PRECAUTIONS

Precaution for Supplemental Restraint System (SRS) "AIR BAG" and "SEAT BELT PRE-TENSIONER"

INFOID:000000003533915

The Supplemental Restraint System such as "AIR BAG" and "SEAT BELT PRE-TENSIONER", used along with a front seat belt, helps to reduce the risk or severity of injury to the driver and front passenger for certain types of collision. This system includes seat belt switch inputs and dual stage front air bag modules. The SRS system uses the seat belt switches to determine the front air bag deployment, and may only deploy one front air bag, depending on the severity of a collision and whether the front occupants are belted or unbelted. Information necessary to service the system safely is included in the "SRS AIRBAG" and "SEAT BELT" of this Service Manual.

WARNING:

- To avoid rendering the SRS inoperative, which could increase the risk of personal injury or death in the event of a collision which would result in air bag inflation, all maintenance must be performed by an authorized NISSAN/INFINITI dealer.
- Improper maintenance, including incorrect removal and installation of the SRS, can lead to personal injury caused by unintentional activation of the system. For removal of Spiral Cable and Air Bag Module, see the "SRS AIRBAG".
- Do not use electrical test equipment on any circuit related to the SRS unless instructed to in this Service Manual. SRS wiring harnesses can be identified by yellow and/or orange harnesses or harness connectors.

Precautions For Xenon Headlamp Service

INFOID:000000003135390

WARNING:

Comply with the following warnings to prevent any serious accident.

- Disconnect the battery cable (negative terminal) or the power supply fuse before installing, removing, or touching the xenon headlamp (bulb included). The xenon headlamp contains high-voltage generated parts.
- Never work with wet hands.
- Check the xenon headlamp ON-OFF status after assembling it to the vehicle. Never turn the xenon headlamp ON in other conditions. Connect the power supply to the vehicle-side connector. (Turning it ON outside the lamp case may cause fire or visual impairments.)
- Never touch the bulb glass immediately after turning it OFF. It is extremely hot.

CAUTION:

Comply with the following cautions to prevent any error and malfunction.

- Install the xenon bulb securely. (Insufficient bulb socket installation may melt the bulb, the connector, the housing, etc. by high-voltage leakage or corona discharge.)
- Never perform HID circuit inspection with a tester.
- Never touch the xenon bulb glass with hands. Never put oil and grease on it.
- Dispose of the used xenon bulb after packing it in thick vinyl without breaking it.
- Never wipe out dirt and contamination with organic solvent (thinner, gasoline, etc.).

HEADLAMP AIMING ADJUSTMENT

< ON-VEHICLE MAINTENANCE >

[XENON TYPE]

ON-VEHICLE MAINTENANCE

HEADLAMP AIMING ADJUSTMENT

Description

INFOID:000000003135391

PREPARATION BEFORE ADJUSTING

NOTE:

- For details, refer to the regulations in your own country.
- Perform aiming if the vehicle front body has been repaired and/or the headlamp assembly has been replaced.

Before performing aiming adjustment, check the following.

- Adjust the tire pressure to the specification.
- Fill with fuel, engine coolant and each oil.
- Maintain the unloaded vehicle condition. (Remove luggage from the passenger compartment and the trunk room.)

NOTE:

Do not remove the temporary tire, jack and on-vehicle tool.

- Wipe out dirt on the headlamp.

CAUTION:

Never use organic solvent (thinner, gasoline etc.)

- Ride alone on the driver seat.

AIMING ADJUSTMENT SCREW

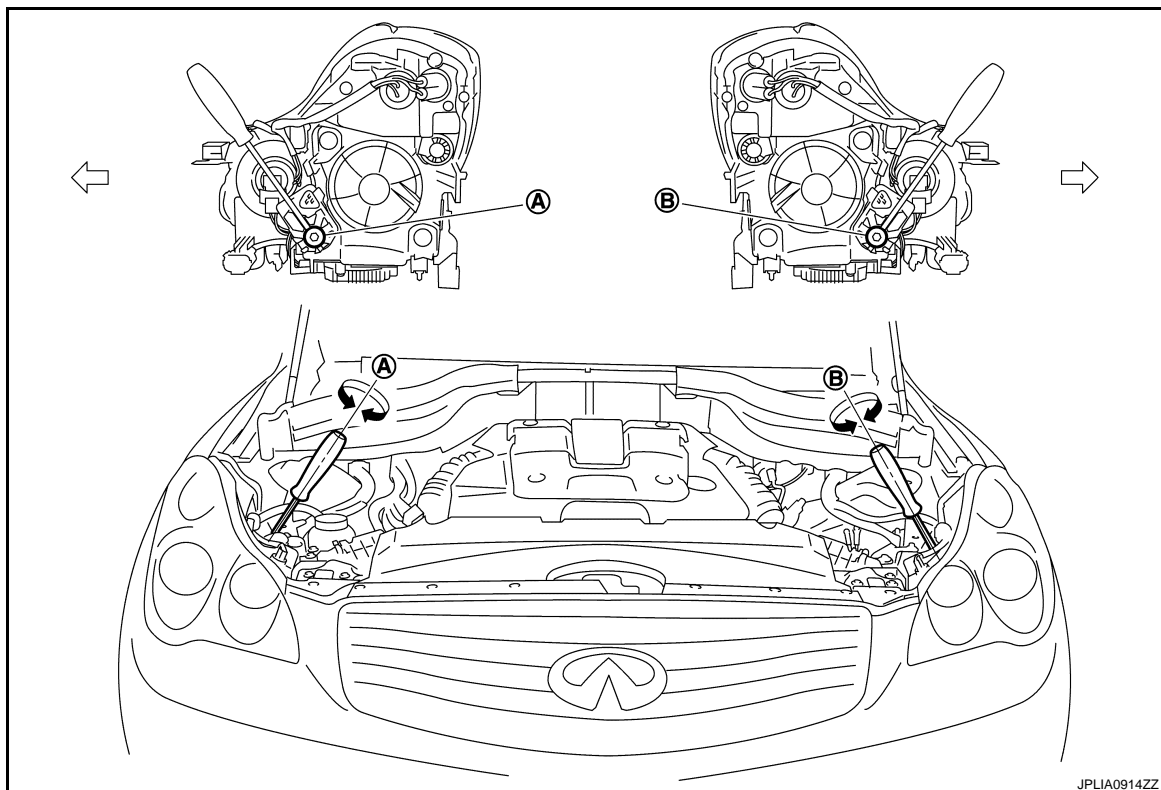

A Headlamp RH (UP/DOWN) adjustment screw B. Headlamp LH (UP/DOWN) adjustment screw

↔: Vehicle center

NOTE:

The figure is the vehicle without AFS. Each adjustment screw is applied to the vehicle with AFS.

HEADLAMP AIMING ADJUSTMENT

< ON-VEHICLE MAINTENANCE >

[XENON TYPE]

Adjustment screw		Screw driver rotation	Facing direction
A	Headlamp RH (UP/DOWN)	Clockwise	UP
		Counterclockwise	DOWN
B	Headlamp LH (UP/DOWN)	Clockwise	UP
		Counterclockwise	DOWN

Aiming Adjustment Procedure

INFOID:000000003135392

- Place the screen.

NOTE:

- Stop the vehicle facing the wall.
- Place the board on a plain road vertically.

- Face the vehicle with the screen. Maintain 10 m (32.8 ft) between the headlamp center and the screen.
- Start the engine. Turn the headlamp (LO) ON.

NOTE:

Shut off the headlamp light with the board to prevent from illuminating the adjustment screen.

CAUTION:

Never cover the lens surface with a tape etc. The lens is made of resin.

- Measure the distance (X) between the horizontal center line of headlamp (H) and the cutoff line (A) within the light axis measurement range (R) from the vertical center line ahead of headlamp (V).

Light axis measurement range (R) : 350 ± 175 mm (13.78 ± 6.89 in)

Low beam distribution on the screen

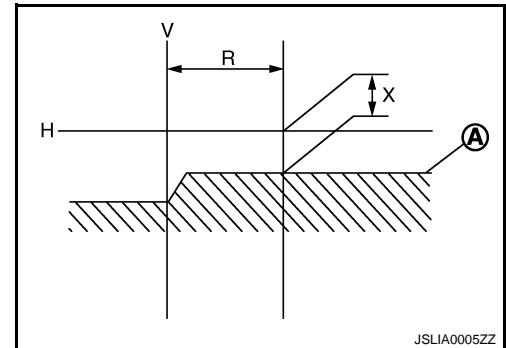

JSLIA0005ZZ

- Adjust the cutoff line height (X) with the aiming adjustment screw so as to enter in the adjustment range (M–N) according to the horizontal center line of headlamp (H).

unit: mm (in)

Horizontal center line of headlamp (H)	Highest cutoff line height (M)	Lowest cutoff line height (N)
700 (27.56) or less	4 (0.16)	30 (1.18)
701(27.60) – 800 (31.50)	4 (0.16)	30 (1.18)
801 (31.54) or more	17 (0.67)	44 (1.73)

Side view

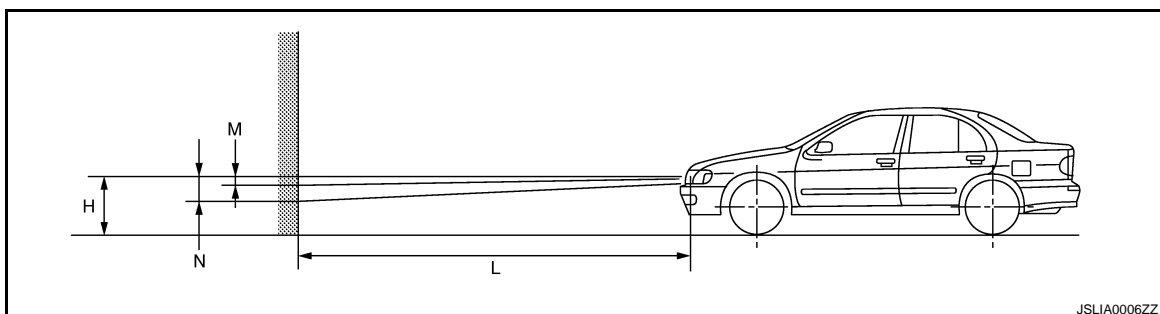

JSLIA0006ZZ

HEADLAMP AIMING ADJUSTMENT

< ON-VEHICLE MAINTENANCE >

[XENON TYPE]

Distance between the headlamp center and the screen (L) : 10 m (32.8 ft)

A

B

C

D

E

F

G

H

I

J

K

EXL

M

N

O

P

FRONT FOG LAMP AIMING ADJUSTMENT

< ON-VEHICLE MAINTENANCE >

[XENON TYPE]

FRONT FOG LAMP AIMING ADJUSTMENT

Description

INFOID:000000003135393

PREPARATION BEFORE ADJUSTING

NOTE:

- For details, refer to the regulations in your own country.
- Perform aiming if the vehicle front body has been repaired and/or the headlamp assembly has been replaced.

Before performing aiming adjustment, check the following.

- Adjust the tire pressure to the specification.
- Fill with fuel, engine coolant and each oil.
- Maintain the unloaded vehicle condition. (Remove luggage from the passenger compartment and the trunk room.)

NOTE:

Do not remove the temporary tire, jack and on-vehicle tool.

- Wipe out dirt on the headlamp.

CAUTION:

Never use organic solvent (thinner, gasoline etc.)

- Ride alone on the driver seat.

AIMING ADJUSTMENT SCREW

- Turn the aiming adjusting screw for adjustment.

A: UP

B: DOWN

- For the position and direction of the adjusting screw, refer to the figure.

NOTE:

A screwdriver or hexagonal wrench [6 mm (0.24 in)] can be used for adjustment.

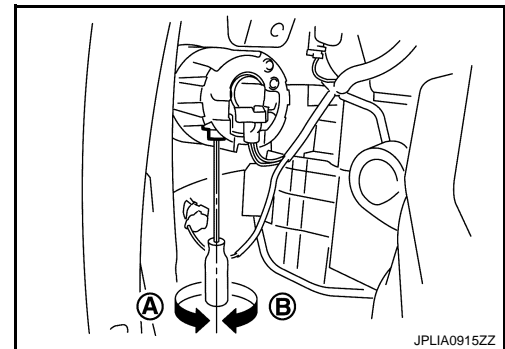

Aiming Adjustment Procedure

INFOID:000000003135394

1. Place the screen.

NOTE:

- Stop the vehicle facing the wall.
- Place the board on a plain road vertically.

2. Face the vehicle with the screen. Maintain 10 m (32.8 ft) between the front fog lamp center and the screen.

3. Start the engine. Turn the front fog lamp ON.

NOTE:

Shut off the headlamp light with the board to prevent from illuminating the adjustment screen.

CAUTION:

Never cover the lens surface with a tape etc. The lens is made of resin.

4. Adjust the cutoff line height (A) with the aiming adjustment screw so that the distance (X) between the horizontal center line of front fog lamp (H) and (A) becomes 200 mm (7.87 in).

FRONT FOG LAMP AIMING ADJUSTMENT

< ON-VEHICLE MAINTENANCE >

[XENON TYPE]

Front fog lamp light distribution on the screen

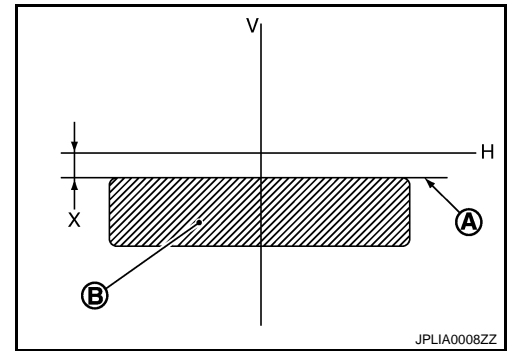

- A : Cutoff line
- B : High illuminance area
- H : Horizontal center line of front fog lamp
- V : Vertical center line of front fog lamp
- X : Cutoff line height

A
B
C
D
E
F
G
H
I
J
K
L
M
N
O
P

EXL

FRONT COMBINATION LAMP

< ON-VEHICLE REPAIR >

[XENON TYPE]

ON-VEHICLE REPAIR

FRONT COMBINATION LAMP

Exploded View

INFOID:000000003135395

REMOVAL

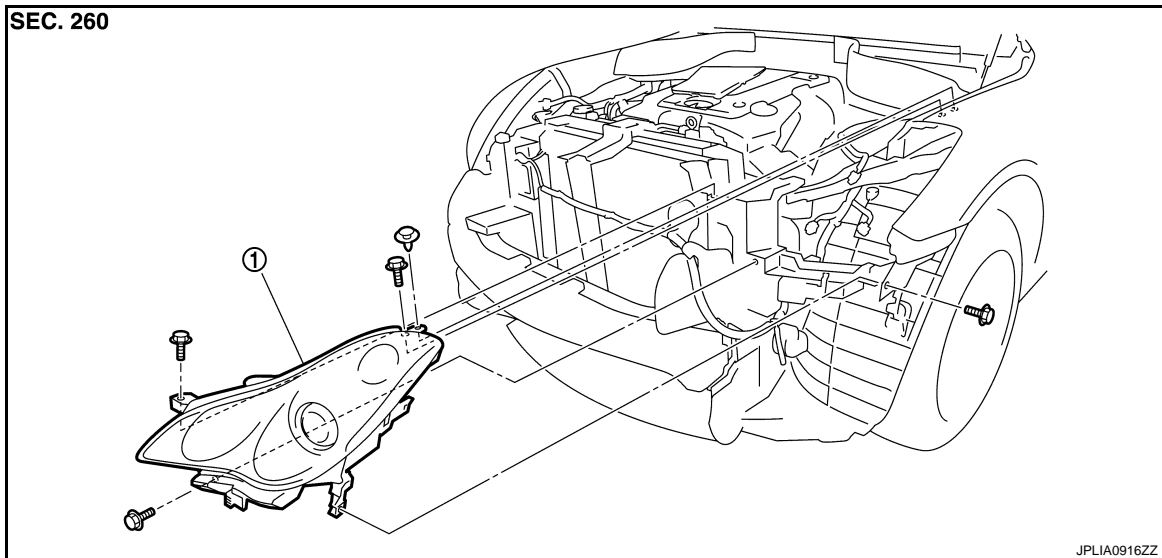

1. Front combination lamp

DISASSEMBLY

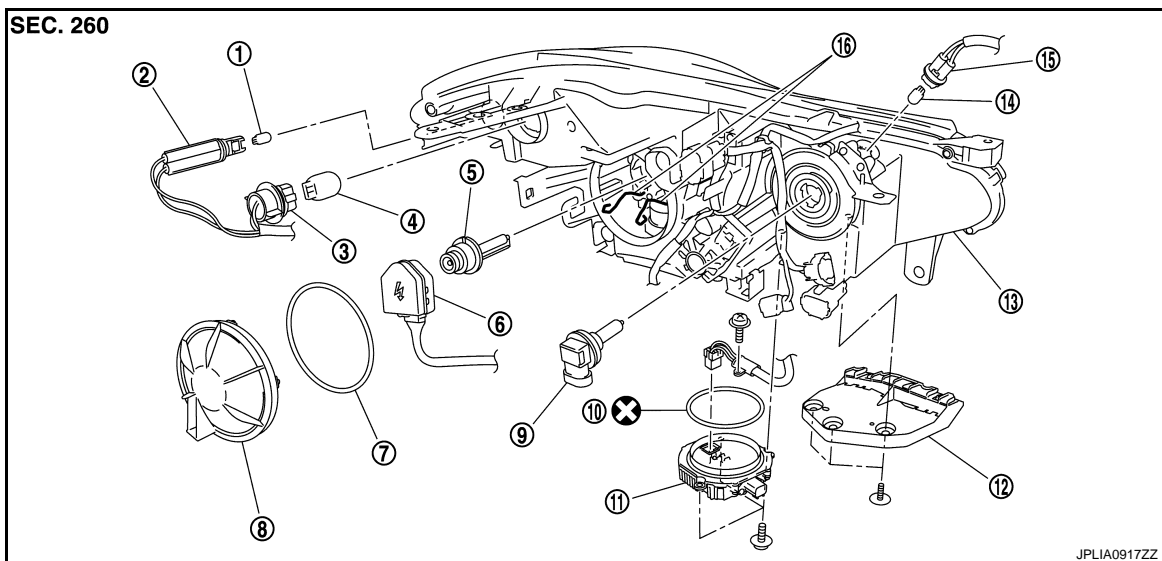

- | | | |
|--------------------------------|---------------------------------------|---------------------------------------|
| 1. Front side marker lamp bulb | 2. Front side marker lamp bulb socket | 3. Front turn signal lamp bulb socket |
| 4. Front turn signal lamp bulb | 5. Xenon bulb | 6. Xenon bulb socket |
| 7. Seal packing | 8. Resin cap | 9. Headlamp (HI) bulb |
| 10. Seal packing | 11. HID control unit | 12. Bumper bracket |
| 13. Headlamp housing assembly | 14. Parking lamp bulb | 15. Parking lamp bulb socket |
| 16. Retaining spring | | |

Refer to [GI-4, "Components"](#) for symbols not described above.

FRONT COMBINATION LAMP

< ON-VEHICLE REPAIR >

[XENON TYPE]

Removal and Installation

INFOID:000000003135396

REMOVAL

CAUTION:

Disconnect the battery negative terminal or remove the fuse.

1. Remove the front bumper fascia. Refer to [EXT-12. "Exploded View"](#).
2. Remove the headlamp mounting bolts and clips.
3. Remove the harness clip and the holding clip (A) *.
*: Left side only.

← : Vehicle front

4. Pull out the headlamp assembly forward the vehicle.
5. Disconnect the connector before removing the headlamp assembly.

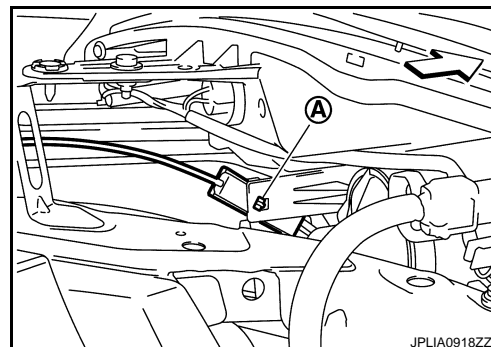

INSTALLATION

Install in the reverse order of removal.

NOTE:

After installation, perform aiming adjustment. Refer to [EXL-187. "Description"](#).

Replacement

INFOID:000000003135397

CAUTION:

- Disconnect the battery negative terminal or remove the fuse.
- After installing the bulb, install the resin cap and the bulb socket securely for watertightness.
- Never touch the glass of bulb directly by hand. Keep grease and other oily matters away from it. Never touch bulb by hand while it is lit or right after being turned off.
- Never leave bulb out of lamp reflector for a long time because dust, moisture smoke, etc. may affect the performance of lamp. When replacing bulb, be sure to replace it with new one.

HEADLAMP BULB (LO)

1. Remove the fender rubber protector in the engine room. Keep a service area.
2. Rotate the resin cap counterclockwise and unlock it.
3. Rotate the bulb socket counterclockwise and unlock it.
4. Remove the retaining spring lock. And then remove the bulb from the headlamp housing assembly.

CAUTION:

Never break the xenon bulb ceramic tube when replacing the bulb.

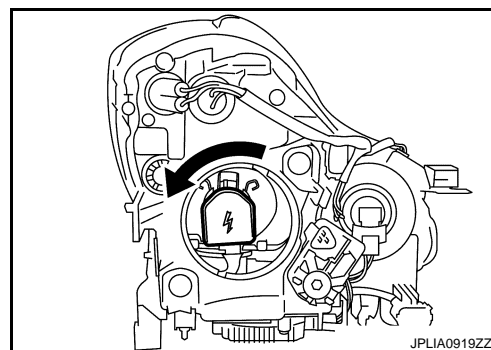

HEADLAMP BULB (HI)

1. Remove the washer tank inlet *. Refer to [WW-100. "Exploded View"](#).
*:When replace a right.
2. Disconnect the headlamp (HI) bulb connector.
3. Rotate the bulb socket counterclockwise and unlock it.
4. Remove the bulb socket from the headlamp housing assembly.

PARKING LAMP BULB

1. Rotate the bulb socket counterclockwise and unlock it.

FRONT COMBINATION LAMP

[XENON TYPE]

< ON-VEHICLE REPAIR >

2. Remove the bulb from the bulb socket.

FRONT TURN SIGNAL LAMP BULB

1. Remove the fender rubber protector in the engine room. Keep a service area.
2. Rotate the bulb socket counterclockwise and unlock it.
3. Remove the bulb from the bulb socket.

FRONT SIDE MARKER LAMP BULB

1. Remove the fender rubber protector in the engine room. Keep a service area.
2. Rotate the bulb socket counterclockwise and unlock it.
3. Remove the bulb from the bulb socket.

Disassembly and Assembly

INFOID:000000003135398

DISASSEMBLY

1. Rotate the resin cap counterclockwise and unlock it.
2. Rotate the xenon bulb socket counterclockwise and unlock it.
3. Remove the retaining spring lock. Remove the xenon bulb.
4. Remove the bumper bracket.
5. Remove the HID control unit installation screw.
6. Remove the screw. Disconnect the connector from HID control unit.
7. Pull out the xenon bulb socket from the headlamp housing assembly.
8. Rotate the parking lamp bulb socket counterclockwise and unlock it.
9. Remove the bulb from the parking lamp bulb socket.
10. Rotate the front turn signal lamp bulb socket counterclockwise and unlock it.
11. Remove the bulb from the front turn signal lamp bulb socket.
12. Rotate the front side marker lamp bulb socket counterclockwise and unlock it.
13. Remove the bulb from the front side marker lamp bulb socket.
14. Rotate the headlamp (HI) bulb socket counterclockwise and unlock it.
15. Remove the bulb socket from the headlamp housing assembly.

ASSEMBLY

Assemble in the reverse order of disassembly.

CAUTION:

- Install HID control unit securely.
- After installing the bulb, install the resin cap and the bulb socket securely for watertightness.
- Seal packing cannot be reused.

FRONT FOG LAMP

< ON-VEHICLE REPAIR >

[XENON TYPE]

FRONT FOG LAMP

Exploded View

INFOID:000000003552491

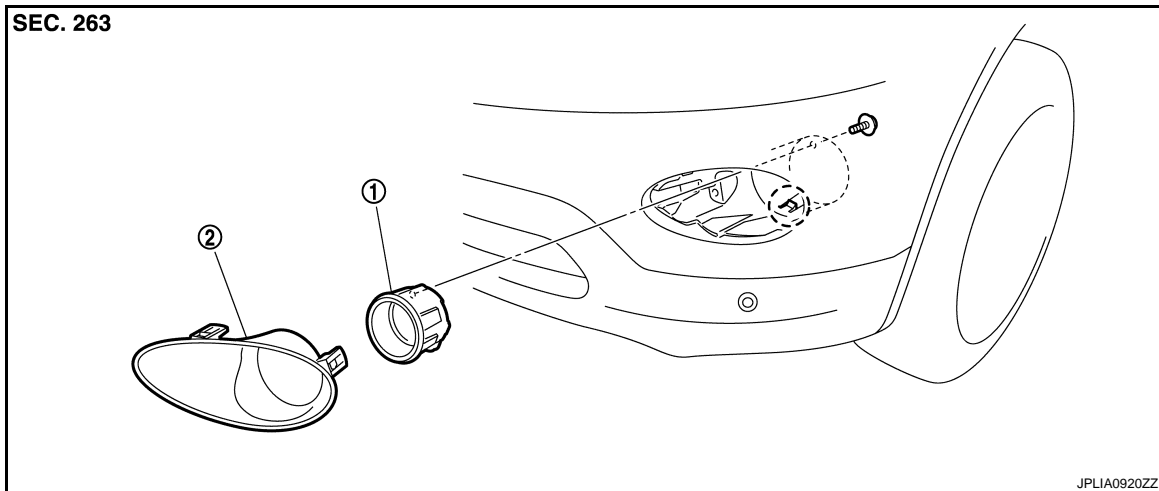

1. Front fog lamp
2. Front fog lamp finisher

 : Pawl

Removal and Installation

INFOID:000000003552492

CAUTION:
Disconnect the battery negative terminal or remove the fuse.

REMOVAL

1. Remove the front fender protector. Keep a service area. Refer to [EXT-25. "FENDER PROTECTOR : Exploded View"](#).
2. Remove the front fog lamp finisher.
3. Remove the front fog lamp connector.
4. Remove the screw.
5. Disengage the pawl. And then remove the front fog lamp.

INSTALLATION

Installation is the reverse order of removal.

NOTE:

After installation, perform aiming adjustment. Refer to [EXL-190. "Description"](#)

Replacement

INFOID:000000003552493

CAUTION:

- Disconnect the battery negative terminal or remove the fuse.
- Never touch the glass of bulb directly by hand. Keep grease and other oily matters away from it. Never touch bulb by hand while it is lit or right after being turned off.
- Never leave bulb out of lamp reflector for a long time because dust, moisture smoke, etc. may affect the performance of lamp. When replacing bulb, be sure to replace it with new one.

FRONT FOG LAMP BULB

1. Remove the front fender protector. Keep the service area. Refer to [EXT-25. "FENDER PROTECTOR : Exploded View"](#).

FRONT FOG LAMP

< ON-VEHICLE REPAIR >

[XENON TYPE]

2. Remove the front fog lamp bulb connector (1).
3. Rotate the bulb (2) counterclockwise and unlock it.

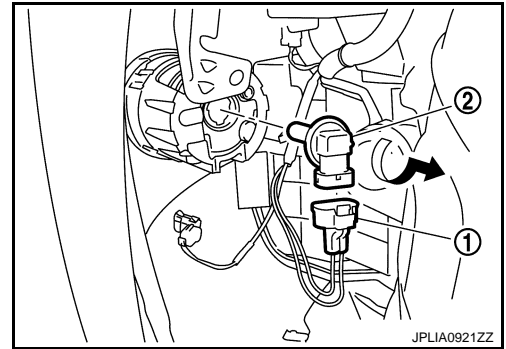

OPTICAL SENSOR

Exploded View

INFOID:000000003135400

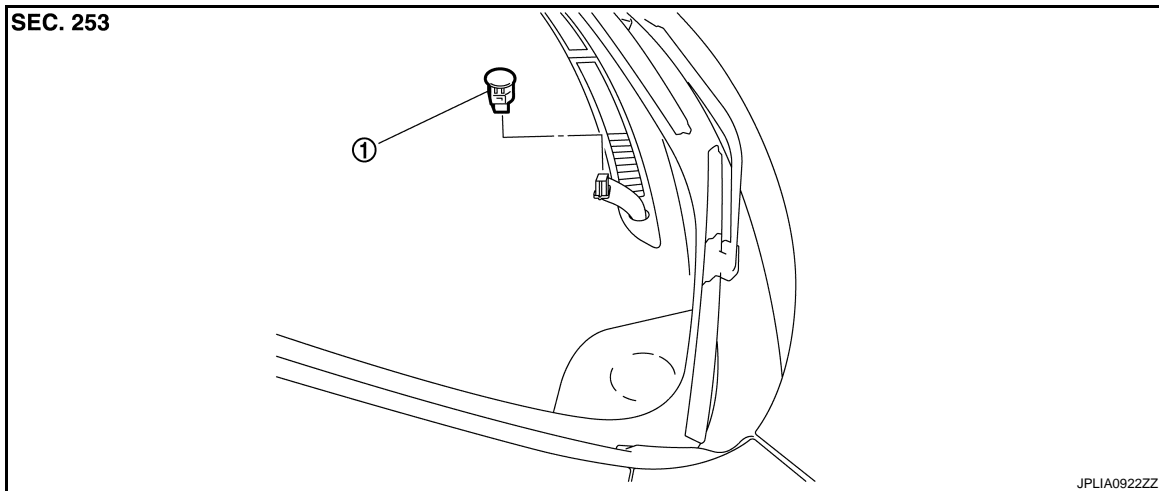

1. Optical sensor

Removal and Installation

INFOID:000000003135401

REMOVAL

1. Insert an appropriate tool between the optical sensor and the instrument upper panel. Pull out the optical sensor upward.
2. Disconnect the optical sensor connector. And then remove the optical sensor.

INSTALLATION

Install in the reverse order of removal.

A
B
C
D
E
F
G
H
I
J
K
EXL
M
N
O
P

LIGHTING AND TURN SIGNAL SWITCH

< ON-VEHICLE REPAIR >

[XENON TYPE]

LIGHTING AND TURN SIGNAL SWITCH

Exploded View

INFOID:000000003135402

Lighting and turn signal switch is integrated in the combination switch. [BCS-85. "Exploded View"](#).

HAZARD SWITCH

< ON-VEHICLE REPAIR >

[XENON TYPE]

HAZARD SWITCH

Exploded View

INFOID:000000003135403

The hazard warning switch is integrated in the multifunction switch. Refer to [AV-163. "Exploded View"](#).

- A
- B
- C
- D
- E
- F
- G
- H
- I
- J
- K
- EXL
- M
- N
- O
- P

AFS CONTROL UNIT

Exploded View

INFOID:000000003135404

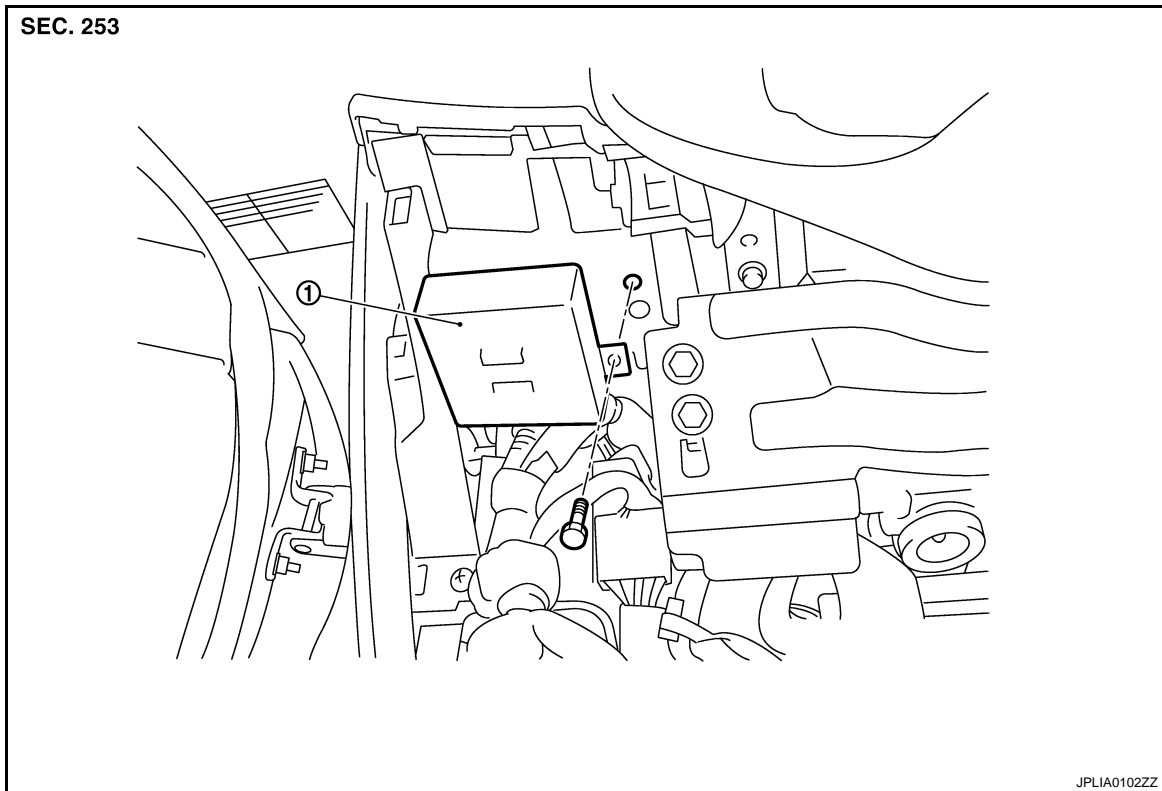

1. AFS control unit

Removal and Installation

INFOID:000000003135405

REMOVAL

1. Remove the instrument driver lower panel. Refer to [IP-11, "Exploded View"](#).
2. Remove the instrument finisher A. Refer to [IP-11, "Exploded View"](#).
3. Remove the AFS control unit mounting bolt.
4. Disconnect the AFS control unit connector.
5. Remove the AFS control unit.

INSTALLATION

Install in the reverse order of removal.

STEERING ANGLE SENSOR

< ON-VEHICLE REPAIR >

[XENON TYPE]

STEERING ANGLE SENSOR

Removal and Installation

INFOID:000000003135406

Refer to [SR-6. "Removal and Installation"](#).

A

B

C

D

E

F

G

H

I

J

K

EXL

M

N

O

P

AFS OFF SWITCH

< ON-VEHICLE REPAIR >

[XENON TYPE]

AFS OFF SWITCH

Exploded View

INFOID:000000003135407

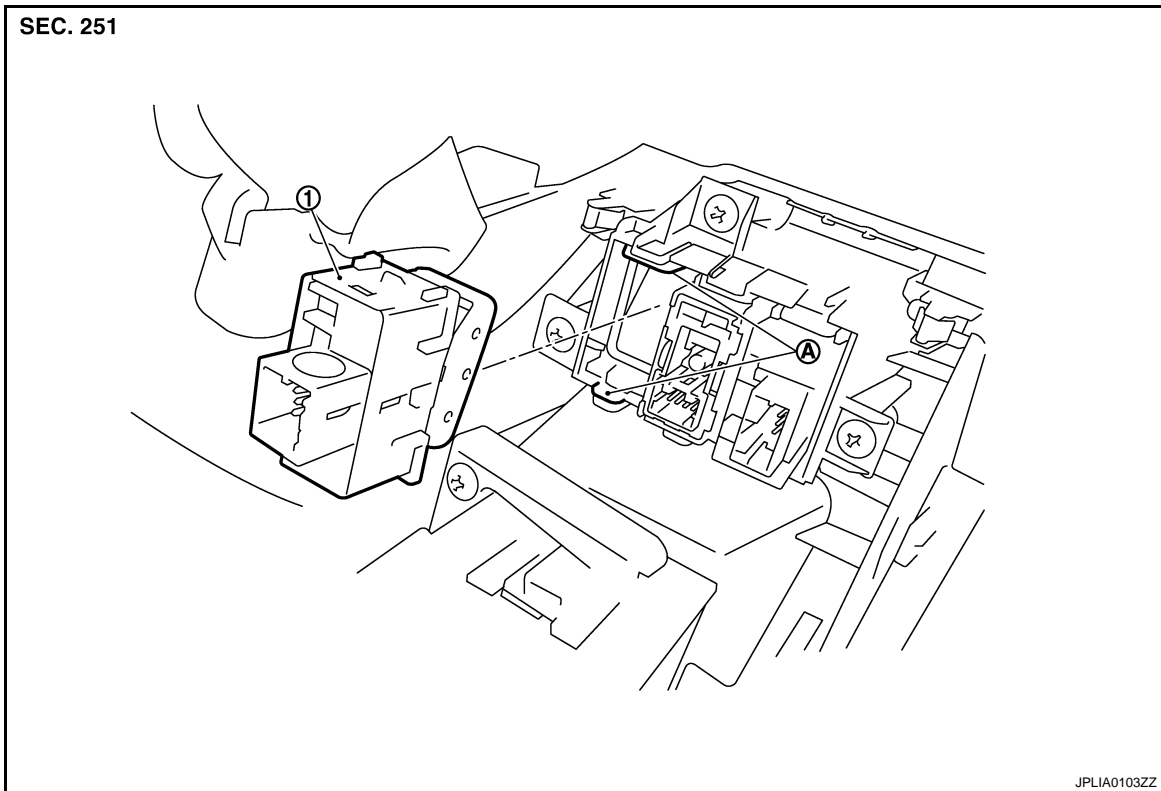

- 1. AFS OFF switch
- A Pawls

Removal and Installation

INFOID:000000003135408

REMOVAL

1. Remove the instrument driver lower panel. Refer to [IP-11. "Exploded View"](#).
2. Widen the pawl. And then remove AFS OFF switch.

INSTALLATION

Install in the reverse order of removal.

HEIGHT SENSOR

< ON-VEHICLE REPAIR >

[XENON TYPE]

HEIGHT SENSOR

Exploded View

INFOID:000000003135409

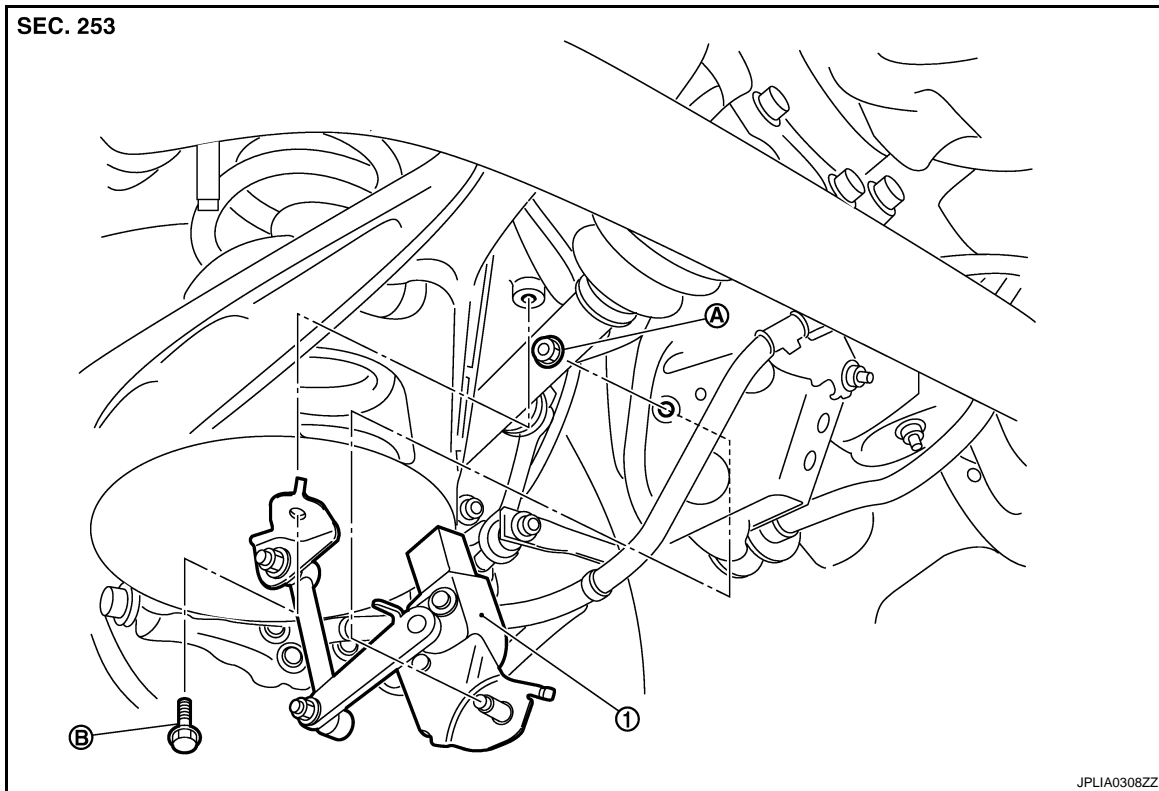

- 1. Height sensor
- A Height sensor mounting nut
- B. Height sensor lever link bracket mounting bolt

Removal and Installation

INFOID:000000003135410

REMOVAL

1. Remove the height sensor mounting nut.
2. Remove the height sensor lever link bracket mounting bolt.
3. Disconnect the height sensor connector.
4. Remove the height sensor.

INSTALLATION

Install in the reverse order of removal.

CAUTION:

Perform the levelizer adjustment when removing the height sensor. Refer to [EXL-9, "LEVELIZER ADJUSTMENT : Special Repair Requirement"](#).

A
B
C
D
E
F
G
H
I
J
K
EXL
M
N
O
P

REAR COMBINATION LAMP

< ON-VEHICLE REPAIR >

[XENON TYPE]

REAR COMBINATION LAMP

Exploded View

INFOID:000000003135411

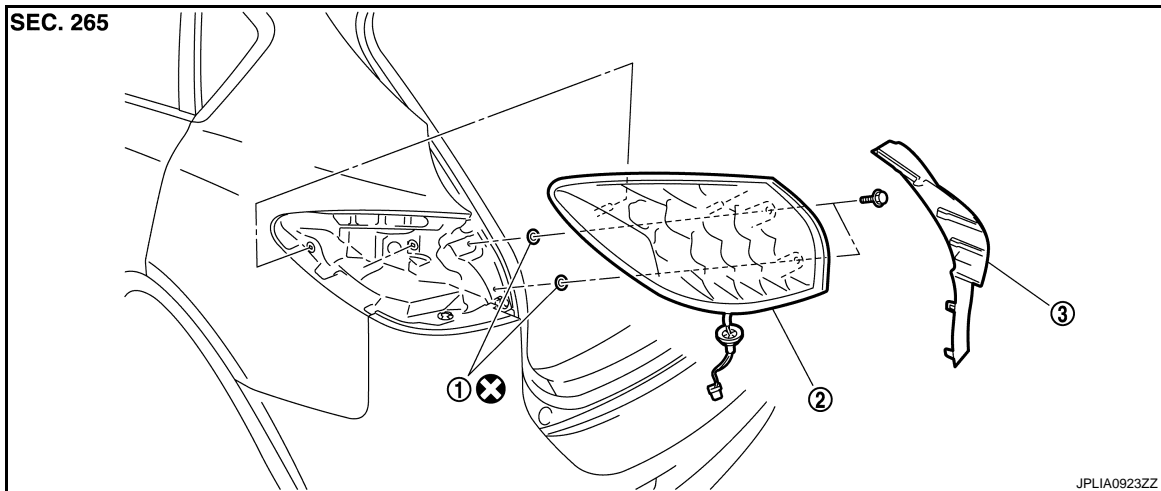

1. Seal packing
2. Rear combination lamp
3. Rear combination lamp finisher

Refer to [GI-4, "Components"](#) for symbols in the figure.

Removal and Installation

INFOID:000000003135412

CAUTION:

Disconnect the battery negative terminal or remove the fuse.

REMOVAL

1. Remove the luggage side finisher lower. Refer to [INT-34, "Exploded View"](#).
2. Remove the rear combination lamp finisher.
3. Remove the rear combination lamp mounting bolts.
4. Disconnect the rear combination lamp connector.
5. Pull the rear combination lamp toward outside of the vehicle. Remove the rear combination lamp.

INSTALLATION

Install in the reverse order of removal.

CAUTION:

Seal packing cannot be reused.

REAR TURN SIGNAL LAMP

< ON-VEHICLE REPAIR >

[XENON TYPE]

REAR TURN SIGNAL LAMP

Exploded View

INFOID:000000003566439

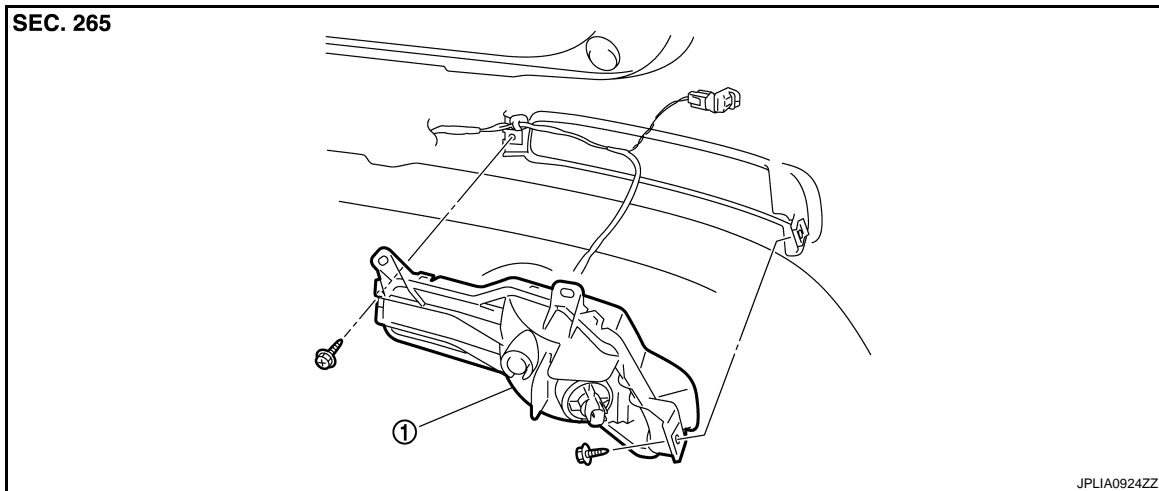

1. Rear turn signal lamp

Removal and Installation

INFOID:000000003566440

CAUTION:

Disconnect the battery negative terminal or remove the fuse.

REMOVAL

1. Remove the rear bumper fascia. Refer to [EXT-16, "Exploded View"](#).
2. Remove the rear turn signal lamp.

INSTALLATION

Install in the reverse order of removal.

Replacement

INFOID:000000003566441

CAUTION:

- **Disconnect the battery negative terminal or remove the fuse.**
- **Never touch the glass of bulb directly by hand. Keep grease and other oily matters away from it. Never touch bulb by hand while it is lit or right after being turned off.**
- **Never leave bulb out of lamp reflector for a long time because dust, moisture smoke, etc. may affect the performance of lamp. When replacing bulb, be sure to replace it with new one.**

REAR TURN SIGNAL LAMP BULB

1. Turn the bulb socket (1) counterclockwise and unlock it.
2. Remove the bulb (2) from the socket.

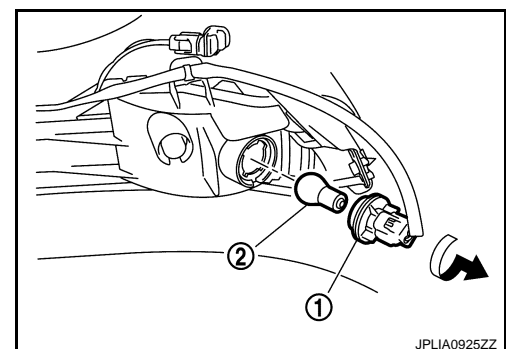

HIGH-MOUNTED STOP LAMP

< ON-VEHICLE REPAIR >

[XENON TYPE]

HIGH-MOUNTED STOP LAMP

Exploded View

INFOID:000000003135414

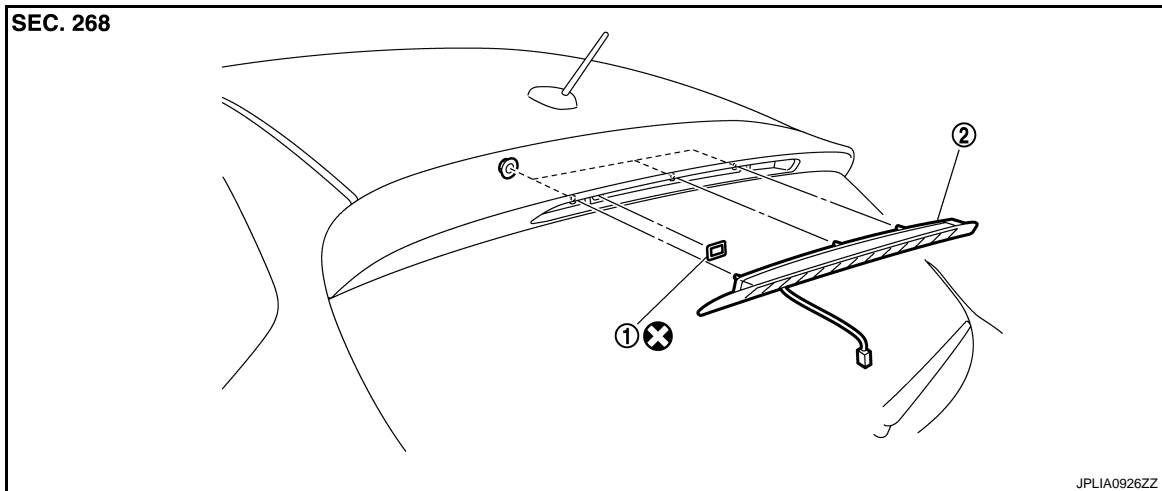

1. Seal packing
2. High-mounted stop lamp

Refer to [GI-4, "Components"](#) for symbols in the figure.

Removal and Installation

INFOID:000000003135415

REMOVAL

1. Remove the back door plate. Refer to [INT-38, "Exploded View"](#).
2. Remove the high-mounted stop lamp mounting nuts.
3. Disconnect the high-mounted stop lamp connector. And then remove the rear washer tube.
4. Pull the high-mounted stop lamp toward rear of the vehicle.
5. Remove the high-mounted stop lamp.

INSTALLATION

Install in the reverse order of removal.

CAUTION:

Seal packing cannot be reused.

BACK-UP LAMP

< ON-VEHICLE REPAIR >

[XENON TYPE]

BACK-UP LAMP

Exploded View

INFOID:000000003135418

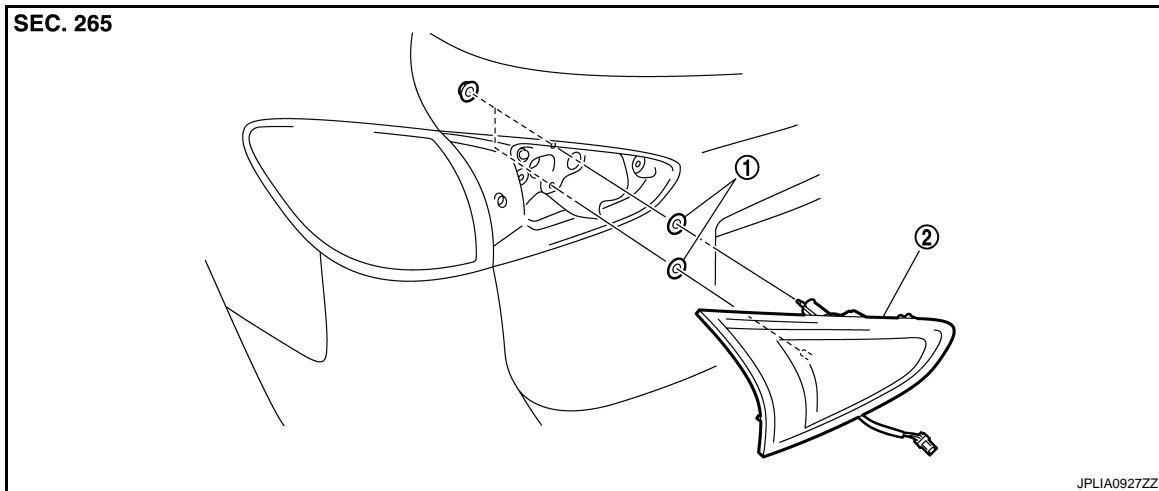

1. Seal packing
2. Back-up lamp

Removal and Installation

INFOID:000000003135419

CAUTION:
Disconnect the battery negative terminal or remove the fuse.

REMOVAL

1. Remove the back door finisher inner. Refer to [INT-38, "Exploded View"](#).
2. Remove the back-up lamp mounting nuts.
3. Disconnect the back-up lamp connector. And then remove the back-up lamp.

INSTALLATION

Install in the reverse order of removal.

Replacement

INFOID:000000003135420

- CAUTION:**
- Disconnect the battery negative terminal or remove the fuse.
 - Never touch the glass of bulb directly by hand. Keep grease and other oily matters away from it. Never touch bulb by hand while it is lit or right after being turned off.
 - Never leave bulb out of lamp reflector for a long time because dust, moisture smoke, etc. may affect the performance of lamp. When replacing bulb, be sure to replace it with new one.

BACK-UP LAMP BULB

1. Remove the back-up lamp. Refer to [EXL-207, "Exploded View"](#).
2. Turn the bulb socket (1) counterclockwise and unlock it.
3. Remove the bulb (2) from the socket.

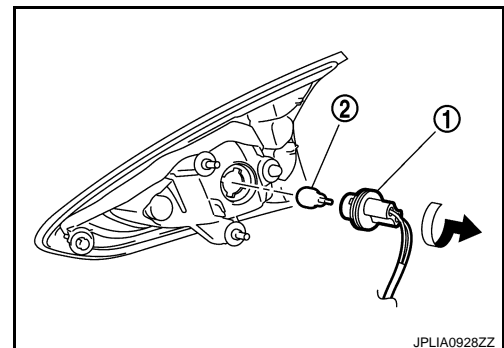

LICENSE PLATE LAMP

< ON-VEHICLE REPAIR >

[XENON TYPE]

LICENSE PLATE LAMP

Exploded View

INFOID:000000003135421

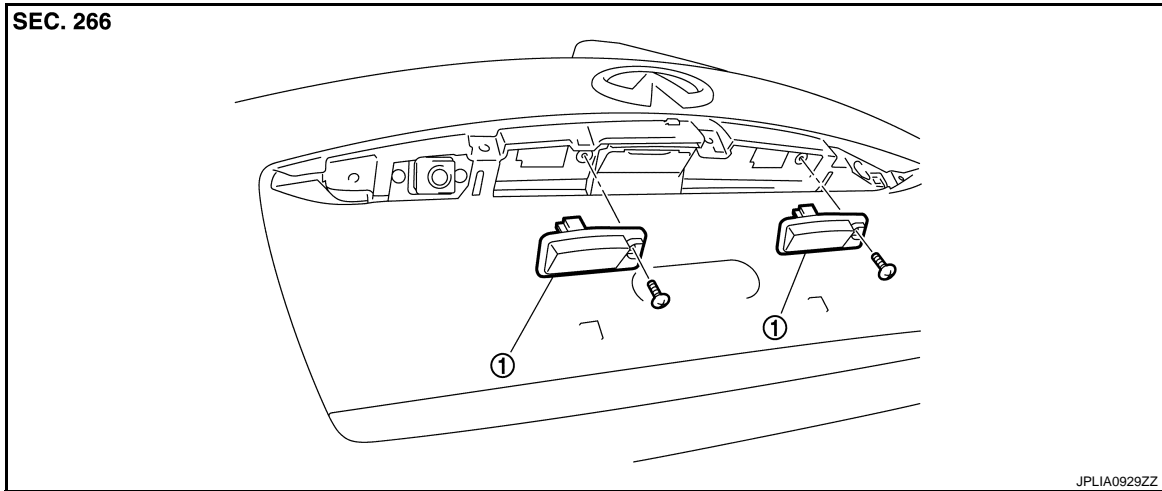

1. License plate lamp

Removal and Installation

INFOID:000000003135422

CAUTION:

Disconnect the battery negative terminal or remove the fuse.

REMOVAL

1. Remove the door handle cover. Refer to [INT-38, "Exploded View"](#).
2. Remove the screw. And then remove the license plate lamp.
3. Disconnect the license plate lamp connector.

INSTALLATION

Install in the reverse order of removal.

Replacement

INFOID:000000003135423

CAUTION:

- Disconnect the battery negative terminal or remove the fuse.
- Never touch the glass of bulb directly by hand. Keep grease and other oily matters away from it. Never touch bulb by hand while it is lit or right after being turned off.
- Never leave bulb out of lamp reflector for a long time because dust, moisture smoke, etc. may affect the performance of lamp. When replacing bulb, be sure to replace it with new one.

LICENSE PLATE LAMP BULB

1. Remove the back door finisher inner. Refer to [INT-38, "Exploded View"](#).
2. Turn the bulb socket (1) counterclockwise and unlock it.
3. Remove the bulb (2) from the socket.

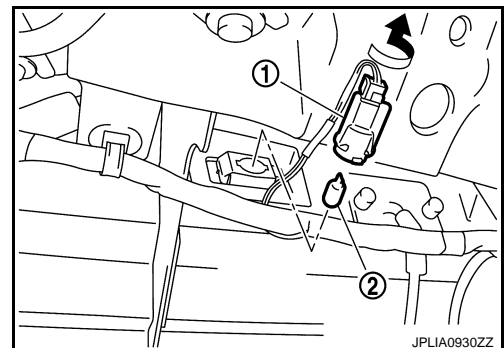

SERVICE DATA AND SPECIFICATIONS (SDS)

< SERVICE DATA AND SPECIFICATIONS (SDS)

[XENON TYPE]

SERVICE DATA AND SPECIFICATIONS (SDS)

SERVICE DATA AND SPECIFICATIONS (SDS)

Bulb Specifications

INFOID:000000003135424

Item	Type	Wattage (W)	
Front combination lamp	Headlamp (HI)	H9 (Halogen)	65
	Headlamp (LO)	D2S (XENON)	35
	Front turn signal lamp	W21W	21
	Parking lamp	W5W	5
	Front side marker lamp	W5W	5
Front fog lamp	H8	35	
Rear combination lamp	Stop lamp/Tail lamp	LED	—
	Rear side marker lamp	LED	—
Rear turn signal lamp	PY21W (Amber)	21	
Back-up lamp	W16W	16	
License plate lamp	W5W	5	
High-mounted stop lamp	LED	—	

A
B
C
D
E
F
G
H
I
J
K
L
M
N
O
P

EXL

BASIC INSPECTION

DIAGNOSIS AND REPAIR WORKFLOW

Work Flow

INFOID:000000003533917

OVERALL SEQUENCE

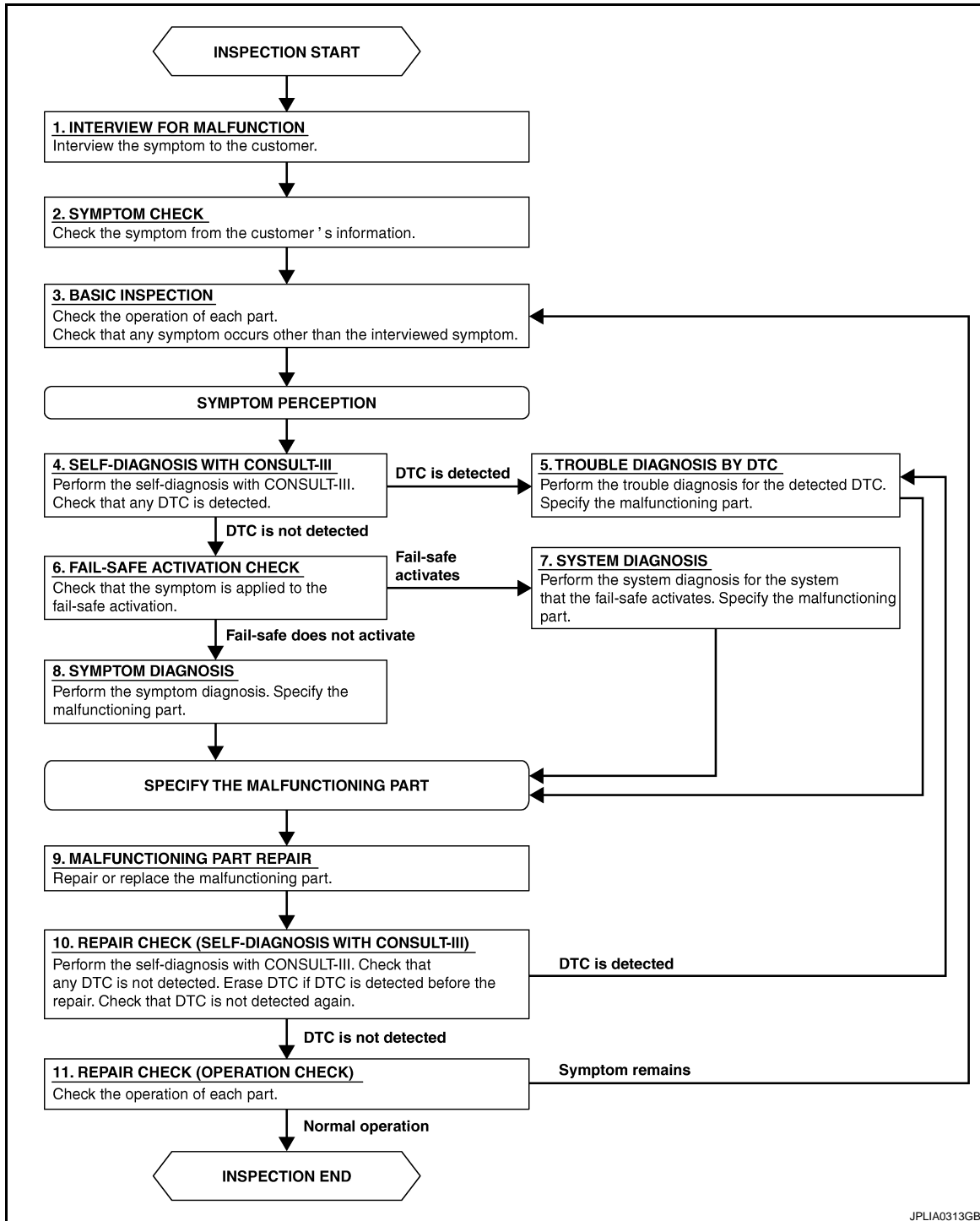

JPLIA0313GB

DETAILED FLOW

1. INTERVIEW FOR MALFUNCTION

Interview the symptom to the customer.

DIAGNOSIS AND REPAIR WORKFLOW

[HALOGEN TYPE]

< BASIC INSPECTION >

>> GO TO 2.

2. SYMPTOM CHECK

Check the symptom from the customer's information.

>> GO TO 3.

3. BASIC INSPECTION

Check the operation of each part. Check that any symptom occurs other than the interviewed symptom.

>> GO TO 4.

4. SELF-DIAGNOSIS WITH CONSULT-III

Perform the self-diagnosis with CONSULT-III. Check that any DTC is detected.

Is any DTC detected?

YES >> GO TO 5.

NO >> GO TO 6.

5. TROUBLE DIAGNOSIS BY DTC

Perform the trouble diagnosis for the detected DTC. Specify the malfunctioning part.

>> GO TO 9.

6. FAIL-SAFE ACTIVATION CHECK

Check that the symptom is applied to the fail-safe activation.

Does the fail-safe activate?

YES >> GO TO 7.

NO >> GO TO 8.

7. SYSTEM DIAGNOSIS

Perform the system diagnosis for the system that the fail-safe activates. Specify the malfunctioning part.

>> GO TO 9.

8. SYMPTOM DIAGNOSIS

Perform the symptom diagnosis. Specify the malfunctioning part.

>> GO TO 9.

9. MALFUNCTION PART REPAIR

Repair or replace the malfunctioning part.

>> GO TO 10.

10. REPAIR CHECK (SELF-DIAGNOSIS WITH CONSULT-III)

Perform the self-diagnosis with CONSULT-III. Check that any DTC is not detected. Erase DTC if DTC is detected before the repair. Check that DTC is not detected again.

Is any DTC detected?

YES >> GO TO 5.

NO >> GO TO 11.

11. REPAIR CHECK (OPERATION CHECK)

Check the operation of each part.

Does it operate normally?

YES >> INSPECTION END

NO >> GO TO 3.

A

B

C

D

E

F

G

H

I

J

K

EXL

M

N

O

P

FUNCTION DIAGNOSIS

HEADLAMP SYSTEM

System Diagram

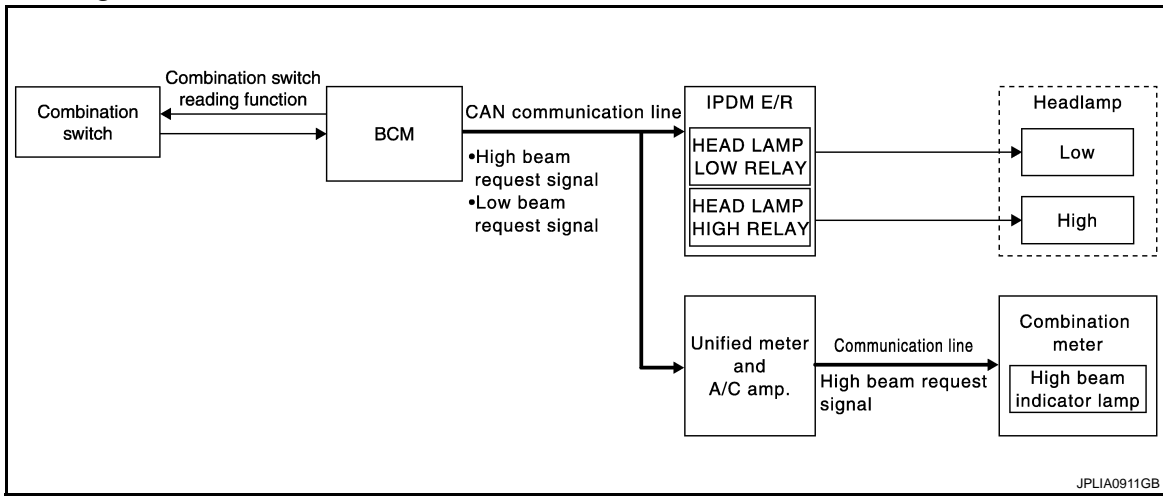

System Description

INFOID:000000003534183

OUTLINE

Headlamp is controlled by combination switch reading function and headlamp control function of BCM, and relay control function of IPDM E/R.

HEADLAMP (LO) OPERATION

- BCM detects the combination switch condition with the combination switch reading function.
- BCM transmits the low beam request signal to IPDM E/R with CAN communication according to the headlamp (LO) ON condition.

Headlamp (LO) ON condition

- Lighting switch 2ND
- IPDM E/R turns the integrated headlamp low relay ON, and turns the headlamp ON according to the low beam request signal.

HEADLAMP (HI) OPERATION

- BCM transmits the high beam request signal to IPDM E/R and the combination meter (through unified meter and A/C amp.) with CAN communication according to the headlamp (HI) ON condition.

Headlamp (HI) ON condition

- Lighting switch HI with the lighting switch 2ND
- Lighting switch PASS
- Combination meter turns the high beam indicator lamp ON according to the high beam request signal.
- IPDM E/R turns the integrated headlamp high relay ON, and turns the headlamp ON according to the high beam request signal.

HEADLAMP SYSTEM

< FUNCTION DIAGNOSIS >

[HALOGEN TYPE]

Component Parts Location

INFOID:000000003534184

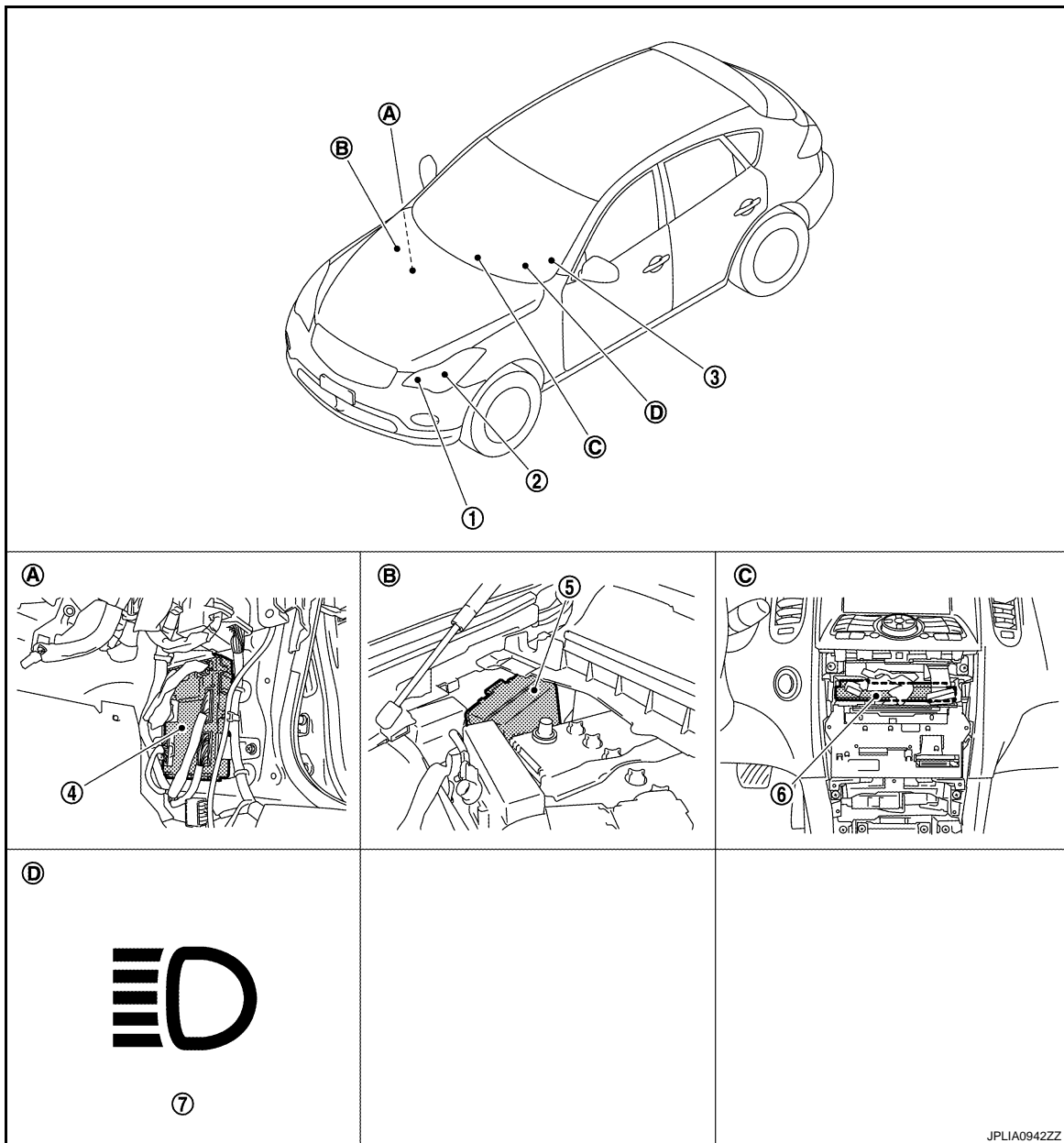

- | | | |
|-------------------------------------|--------------------------------|-------------------------------|
| 1. Headlamp (HI) | 2. Headlamp (LO) | 3. Combination switch |
| 4. BCM | 5. IPDM E/R | 6. Unified meter and A/C amp. |
| 7. High beam indicator lamp | | |
| A. Dash side lower (Passenger side) | B. Engine room dash panel (LH) | C. Behind the cluster lid c |
| D. On the combination meter | | |

JPLIA0942ZZ

A
B
C
D
E
F
G
H
I
J
K
L
M
N
O
P

EXL

HEADLAMP SYSTEM

< FUNCTION DIAGNOSIS >

[HALOGEN TYPE]

Component Description

INFOID:000000003534185

Part	Description
BCM	<ul style="list-style-type: none">• Detects each switch condition by the combination switch reading function.• Judges that the headlamp is turned ON according to the vehicle condition.- Requests the headlamp relay (HI/LO) ON to IPDM E/R (with CAN communication).- Requests the high beam indicator lamp ON to the combination meter (with CAN communication).
IPDM E/R	Controls the integrated relay, and supplies voltage to the load according to the request from BCM (with CAN communication).
Combination switch (Lighting & turn signal switch)	Refer to BCS-8, "System Diagram" .
Combination meter (High beam indicator lamp)	Turns the high beam indicator lamp ON according to the request from BCM[(with CAN communication (through unified meter and A/C amp.))].

AUTO LIGHT SYSTEM

System Diagram

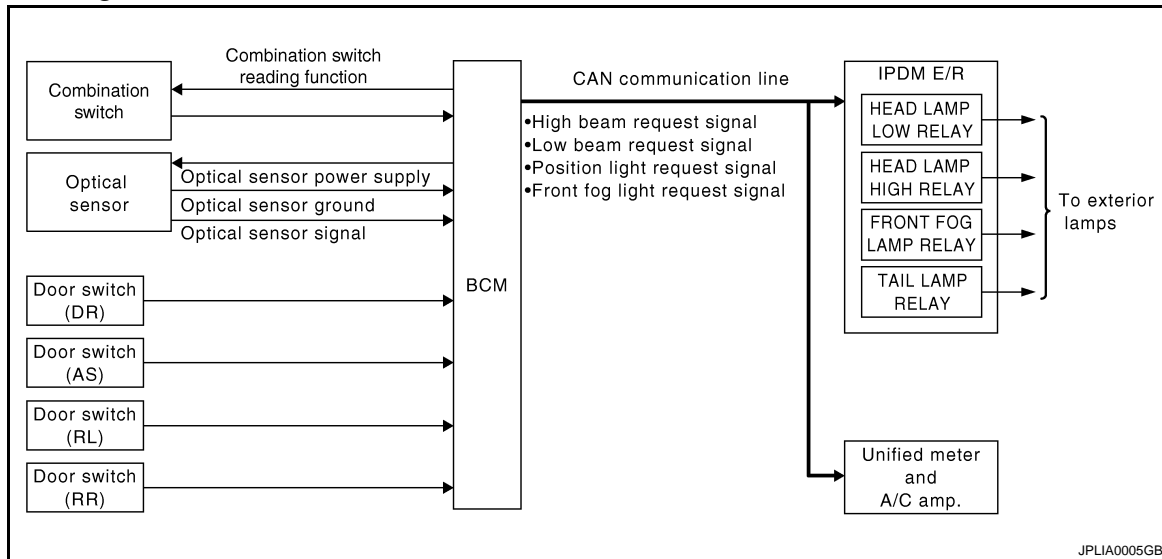

System Description

INFOID:000000003756954

OUTLINE

- Auto light system is controlled by each function of BCM and IPDM E/R.

Control by BCM

- Combination switch reading function
- Headlamp control function
- Auto light function
- Delay timer function

Control by IPDM E/R

- Relay control function
- Auto light system has the auto light function and the delay timer function.
- Auto light function turns the exterior lamps* and each illumination ON/OFF automatically according to the outside brightness.
- When auto light system turns the exterior lamps ON with the ignition switch OFF, delay timer function turns the exterior lamps OFF depending on the vehicle condition with the auto light function after a certain period of time.

*: Headlamp (LO/HI), parking lamp, tail lamp, and front fog lamp (Headlamp HI and front fog lamp depend on the combination switch condition.)

AUTO LIGHT FUNCTION

- BCM detects the combination switch condition with the combination switch reading function.
- BCM supplies voltage to optical sensor when the ignition switch is turned ON or ACC.
- Optical sensor converts outside brightness (lux) to voltage and transmits the optical sensor signal to BCM.
- BCM judges outside brightness from the optical sensor signal and judges ON/OFF condition of the exterior lamp and each illumination according to the outside brightness.
- BCM transmits each request signal to IPDM E/R with CAN communication according to ON/OFF condition by the auto light function.

NOTE:

ON/OFF timing differs based on the sensitivity from the setting. The setting can be set by CONSULT-III. Refer to [EXL-33. "HEADLAMP : CONSULT-III Function \(BCM - HEAD LAMP\)".](#)

DELAY TIMER FUNCTION

BCM turns the exterior lamp OFF depending on the vehicle condition with the auto light function when the ignition switch is turned OFF.

- Turns the exterior lamp OFF 5 minutes after detecting that any door opens (Door switch ON).
- Turns the exterior lamp OFF a certain period of time* after closing all doors (Door switch ON→OFF).

AUTO LIGHT SYSTEM

[HALOGEN TYPE]

< FUNCTION DIAGNOSIS >

- Turns the exterior lamp OFF with the ignition switch ACC or the light switch OFF.
- *: The preset time is 45 seconds. The timer operating time can be set by CONSULT-III. Refer to [EXL-33](#), "[HEADLAMP : CONSULT-III Function \(BCM - HEAD LAMP\)](#)".

NOTE:

When any position other than the light switch AUTO is set, the auto light system function switches to the exterior lamp battery saver function.

Component Parts Location

INFOID:000000003756955

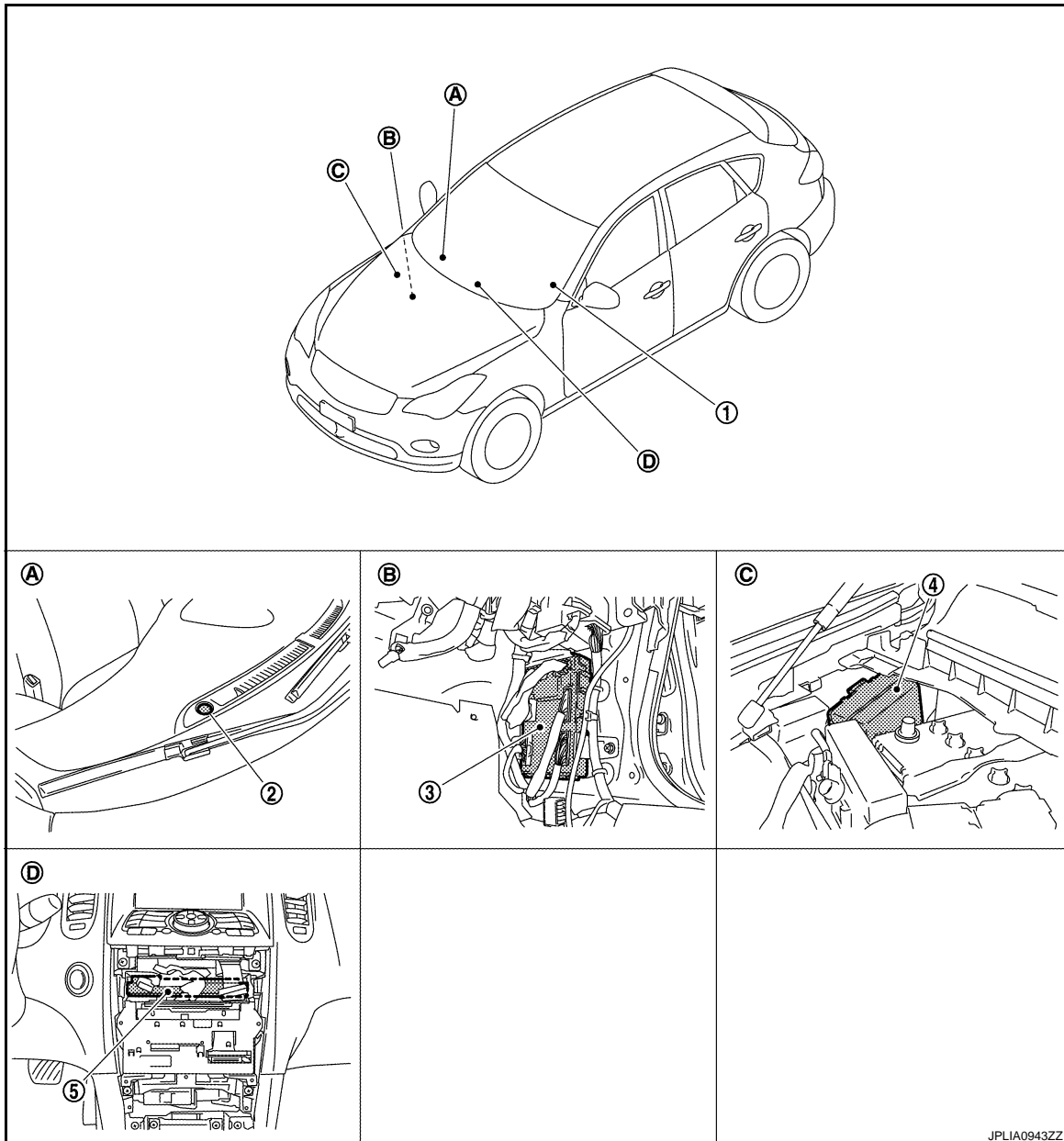

- | | | |
|--------------------------------|-------------------------------------|--------------------------------|
| 1. Combination switch | 2. Optical sensor | 3. BCM |
| 4. IPDM E/R | 5. Unified meter and A/C amp. | |
| A. Instrument upper panel (RH) | B. Dash side lower (Passenger side) | C. Engine room dash panel (RH) |
| D. Behind the cluster lid C | | |

AUTO LIGHT SYSTEM

< FUNCTION DIAGNOSIS >

[HALOGEN TYPE]

Component Description

INFOID:000000003756956

Part	Description
BCM	<ul style="list-style-type: none">• Judges each switch condition by the combination switch reading function.• Judges the outside brightness from the optical sensor signal.• Judges the OFF timing according to the vehicle condition.• Judges the ON/OFF status of the exterior lamp and each illumination according to the outside brightness and the vehicle condition. Requests ON/OFF of each relay to IPDM E/R (with CAN communication).
IPDM E/R	Controls the integrated relay, and supplies voltage to the load according to the request from BCM (with CAN communication).
Combination switch (Lighting & turn signal switch)	Refer to BCS-8, "System Diagram" .
Optical sensor	Refer to EXL-252, "Description" .

A

B

C

D

E

F

G

H

I

J

K

EXL

M

N

O

P

DAYTIME RUNNING LIGHT SYSTEM

< FUNCTION DIAGNOSIS >

[HALOGEN TYPE]

DAYTIME RUNNING LIGHT SYSTEM

System Diagram

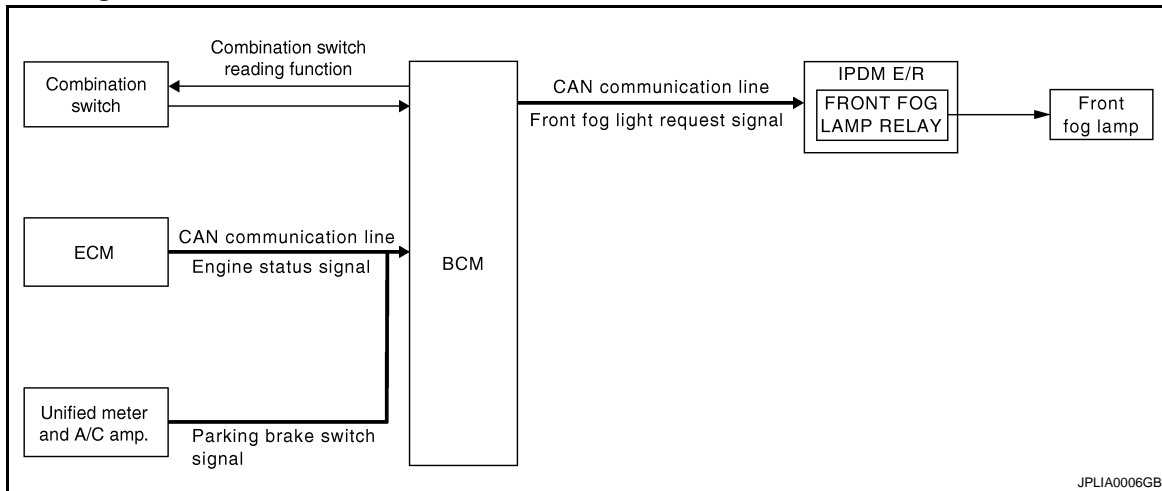

System Description

INFOID:000000003756958

OUTLINE

- Turns the front fog lamp ON as the daytime running light.
- Daytime running light is controlled by daytime running light control function and combination switch reading function of BCM, and relay control function of IPDM E/R.

DAYTIME RUNNING LIGHT OPERATION

- BCM detects the combination switch condition by the combination switch reading function.
- BCM detects the vehicle condition depending on the following signals.
 - Engine condition signal (received from ECM with CAN communication)
 - Parking brake switch signal (received from unified meter and A/C amp. with CAN communication)
- BCM transmits the front fog light request signal to IPDM E/R with CAN communication according to the daytime running light ON condition.

Daytime running light ON condition

- While the engine running with the parking brake released

Daytime running light OFF condition

- Engine stopped
- Headlamp ON (Passing included)
- IPDM E/R turns the integrated front fog lamp relay ON and turns the front fog lamp ON according to the front fog light request signal.

DAYTIME RUNNING LIGHT SYSTEM

< FUNCTION DIAGNOSIS >

[HALOGEN TYPE]

Component Parts Location

INFOID:000000003756959

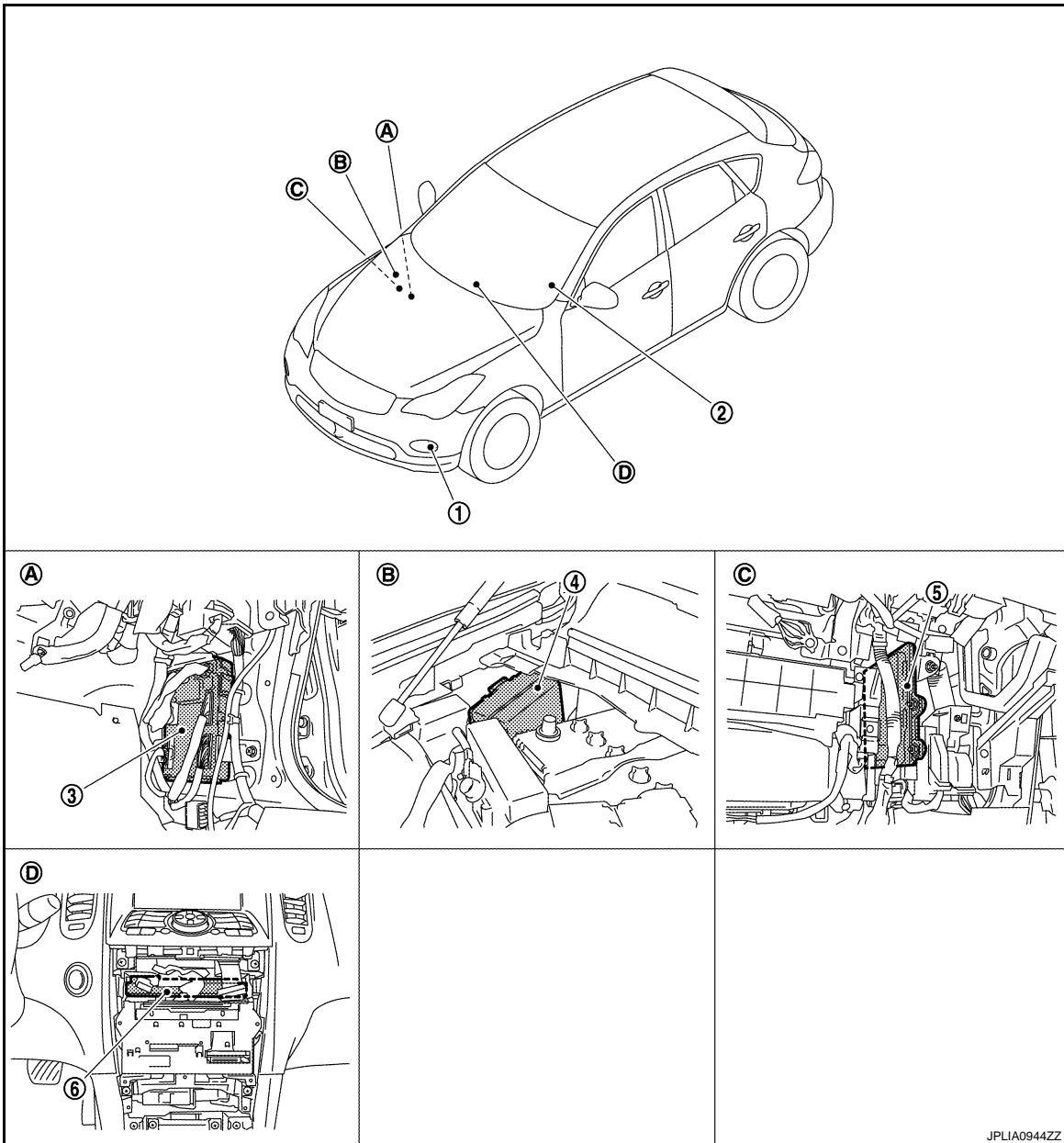

- | | | |
|--|--------------------------------|-------------------------------|
| 1. Daytime running light
(Front fog lamp) | 2. Combination switch | 3. BCM |
| 4. IPDM E/R | 5. ECM | 6. Unified meter and A/C amp. |
| A. Dash side lower (Passenger side) | B. Engine room dash panel (RH) | C. Behind the glove box |
| D. Behind the cluster lid C | | |

Component Description

INFOID:000000003756960

Part	Description
BCM	<ul style="list-style-type: none"> Judges each switch condition with the combination switch reading function. Judges the headlamp ON/OFF status according to the vehicle condition. Requests the front fog lamp relay ON to IPDM E/R (with CAN communication).
IPDM E/R	Controls the integrated relay and supplies voltage to the load according to the request from BCM (with CAN communication).

A
B
C
D
E
F
G
H
I
J
K
EXL
M
N
O
P

DAYTIME RUNNING LIGHT SYSTEM

[HALOGEN TYPE]

< FUNCTION DIAGNOSIS >

Part	Description
Combination switch (Lighting & turn signal switch)	Refer to BCS-8, "System Diagram" .
ECM	Transmits the engine condition signal to BCM with CAN communication.
Unified meter and A/C amp.	Transmits the parking brake switch signal to BCM with CAN communication.

FRONT FOG LAMP SYSTEM

< FUNCTION DIAGNOSIS >

[HALOGEN TYPE]

FRONT FOG LAMP SYSTEM

System Diagram

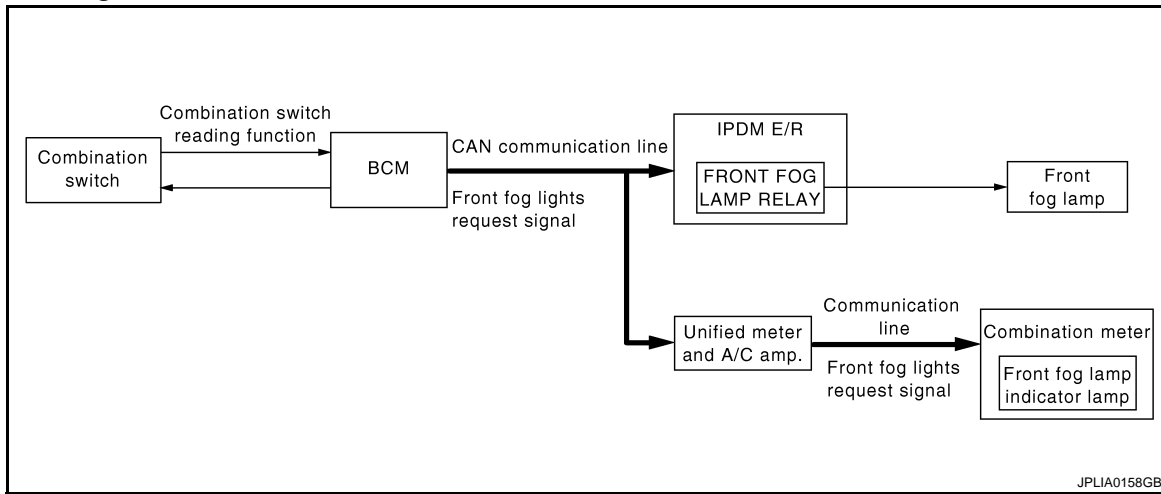

System Description

INFOID:000000003756963

OUTLINE

Front fog lamp is controlled by combination switch reading function and front fog lamp control function of BCM, and relay control function of IPDM E/R.

NOTE:

For Canada models, the front fog lamp is turned ON as the daytime running light. Refer to [EXL-227. "System Diagram"](#) for the detail.

FRONT FOG LAMP OPERATION

- BCM detects the combination switch condition by the combination switch reading function.
- BCM transmits the front fog light request signal to IPDM E/R and the combination meter (through the unified meter and A/C amp.) with CAN communication according to the front fog lamp ON condition.

Front fog lamp ON condition

- Front fog lamp switch ON with the headlamp ON (except for the high beam ON)
- IPDM E/R turns the integrated front fog lamp relay ON, and turns the front fog lamp ON according to the front fog light request signal.
- Combination meter turns the front fog lamp indicator lamp ON according to the front fog light request signal.

A
B
C
D
E
F
G
H
I
J
K
EXL
M
N
O
P

FRONT FOG LAMP SYSTEM

[HALOGEN TYPE]

< FUNCTION DIAGNOSIS >

Component Parts Location

INFOID:000000003756964

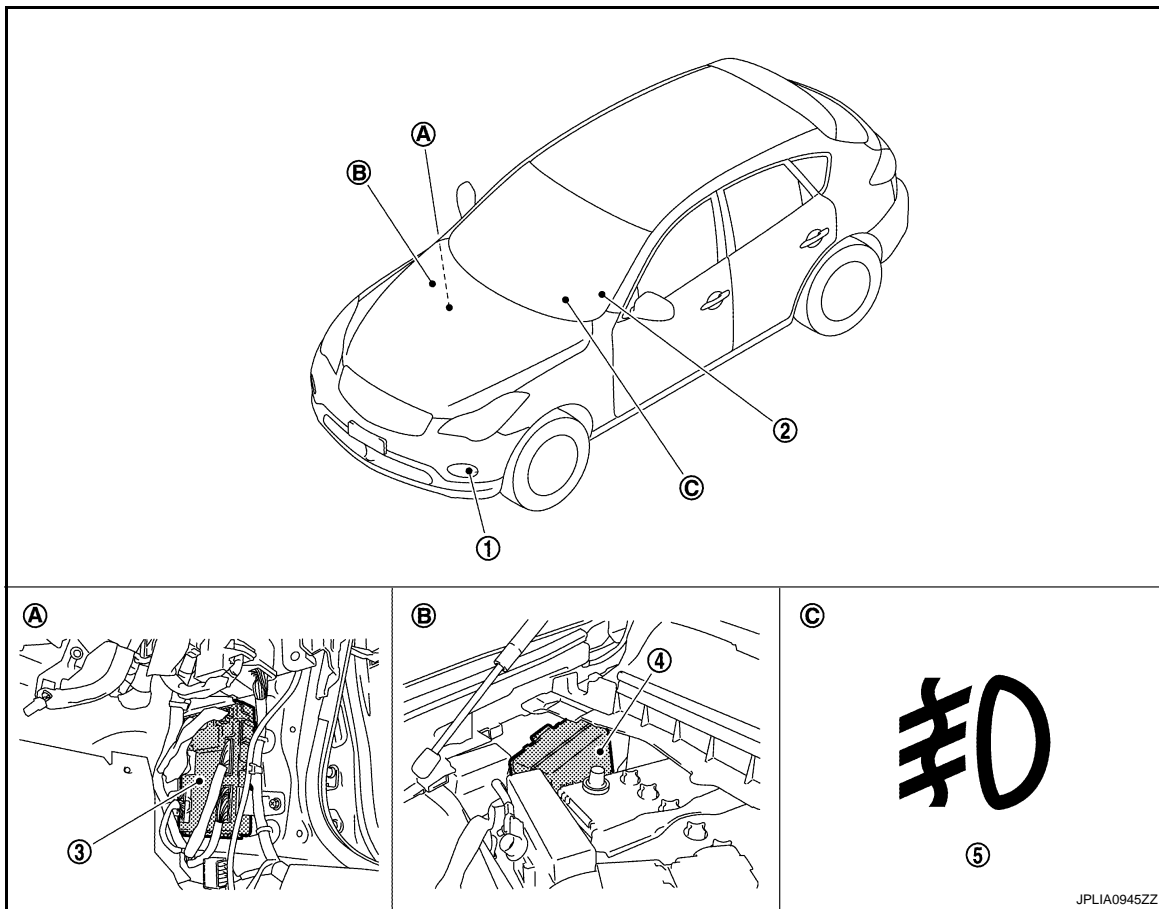

- | | | |
|-------------------------------------|----------------------------------|-----------------------------|
| 1. Front fog lamp | 2. Combination switch | 3. BCM |
| 4. IPDM E/R | 5. Front fog lamp indicator lamp | |
| A. Dash side lower (Passenger side) | B. Engine room dash panel (RH) | C. On the combination meter |

Component Description

INFOID:000000003756965

Part	Description
BCM	<ul style="list-style-type: none"> Judges each switch condition by the combination switch reading function. Judges the front fog lamp ON/OFF status according to the vehicle condition. Requests the front fog lamp relay ON to IPDM E/R (with CAN communication).
IPDM E/R	Controls the integrated relay and supplies voltage to the load according to the request from BCM (with CAN communication).
Combination switch (Lighting & turn signal switch)	Refer to BCS-8, "System Diagram" .
Combination meter (Front fog lamp indicator lamp)	Turns the front fog lamp indicator lamp ON according to the request from BCM [with CAN communication (through the unified meter and A/C amp.)].

TURN SIGNAL AND HAZARD WARNING LAMP SYSTEM

< FUNCTION DIAGNOSIS >

[HALOGEN TYPE]

TURN SIGNAL AND HAZARD WARNING LAMP SYSTEM

System Diagram

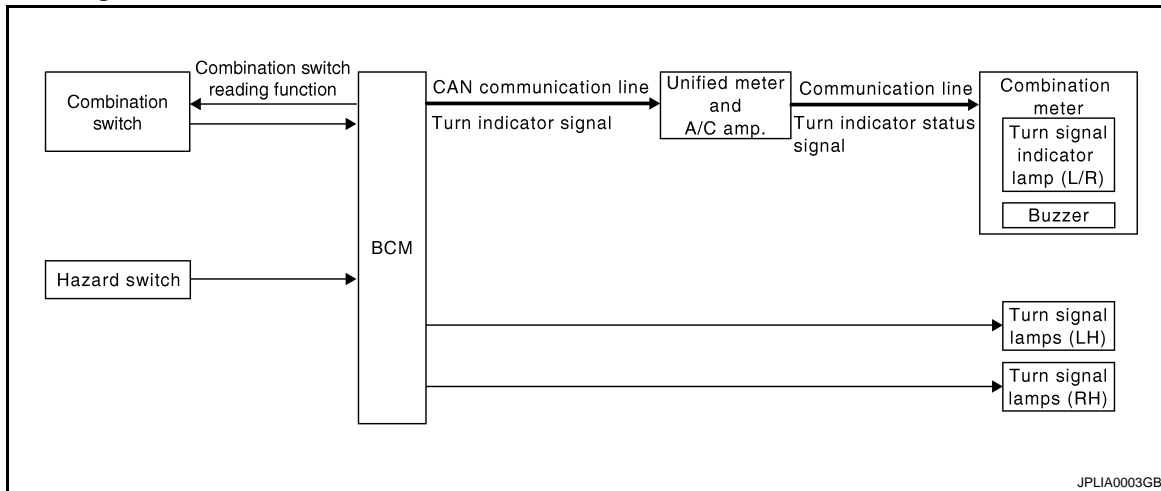

System Description

INFOID:000000003756967

OUTLINE

Turn signal and the hazard warning lamp is controlled by combination switch reading function and the flasher control function of BCM.

TURN SIGNAL LAMP OPERATION

- BCM detects the combination switch condition by the combination switch reading function.
- BCM supplies voltage to the right (left) turn signal lamp circuit when the ignition switch is turned ON and the turn signal switch is in the right (left) position. BCM blinks the turn signal lamp.

HAZARD WARNING LAMP OPERATION

BCM supplies voltage to both turn signal lamp circuit when the hazard switch is turned ON. BCM blinks the hazard warning lamp.

TURN SIGNAL INDICATOR LAMP AND TURN SIGNAL SOUND OPERATION

- BCM transmits the turn signal indicator lamp signal to the combination meter (through the unified meter and A/C amp.) with CAN communication while the turn signal lamp and the hazard warning lamp operating.
- Combination meter outputs the turn signal sound with the integrated buzzer while blinking the turn signal indicator lamp according to the turn signal indicator lamp signal.

HIGH FLASHER OPERATION (FAIL-SAFE)

- BCM detects the turn signal lamp circuit status from the current value.
- BCM increases the turn signal lamp blinking speed if the bulb or harness open is detected with the turn signal lamp operating.

NOTE:

The blinking speed is normal while operating the hazard warning lamp.

A
B
C
D
E
F
G
H
I
J
K
EXL
M
N
O
P

TURN SIGNAL AND HAZARD WARNING LAMP SYSTEM

< FUNCTION DIAGNOSIS >

[HALOGEN TYPE]

Component Parts Location

INFOID:000000003756968

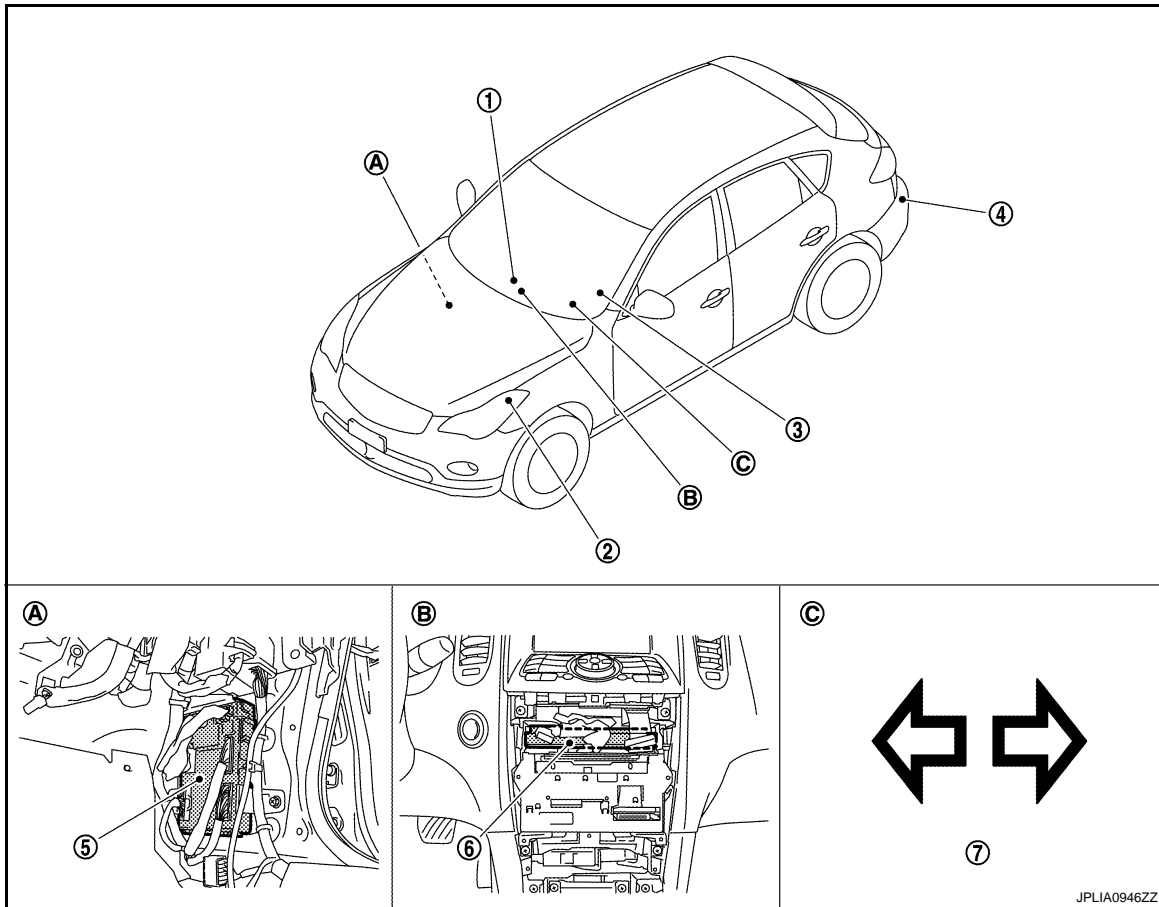

- | | | |
|-------------------------------|-------------------------------------|-------------------------------|
| 1. Hazard warning switch | 2. Front turn signal lamp | 3. Combination switch |
| 4. Rear turn signal lamp | 5. BCM | 6. Unified meter and A/C amp. |
| 7. Turn signal indicator lamp | A. Dash side lower (Passenger side) | B. Behind the cluster lid C |
| | | C. On the combination meter |

Component Description

INFOID:000000003756969

Part	Description
BCM	<ul style="list-style-type: none"> Judges each switch condition by the combination switch reading function. Judges the blinks of the turn signal lamp and the hazard warning lamp from each switch status. The applicable turn signal lamp blinks. Requests the turn signal indicator lamp blink to the combination meter (with CAN communication).
Combination switch (Lighting & turn signal switch)	Refer to BCS-8, "System Diagram" .
Hazard switch (Multifunction switch)	Refer to EXL-255, "Description" .
Combination meter (Turn signal indicator lamp & buzzer)	Blinks the turn signal indicator lamp and outputs the turn signal operating sound with integrated buzzer according to the request from BCM [with CAN communication (through unified meter and A/C amp.)].

PARKING, LICENSE PLATE AND TAIL LAMPS SYSTEM

< FUNCTION DIAGNOSIS >

[HALOGEN TYPE]

PARKING, LICENSE PLATE AND TAIL LAMPS SYSTEM

System Diagram

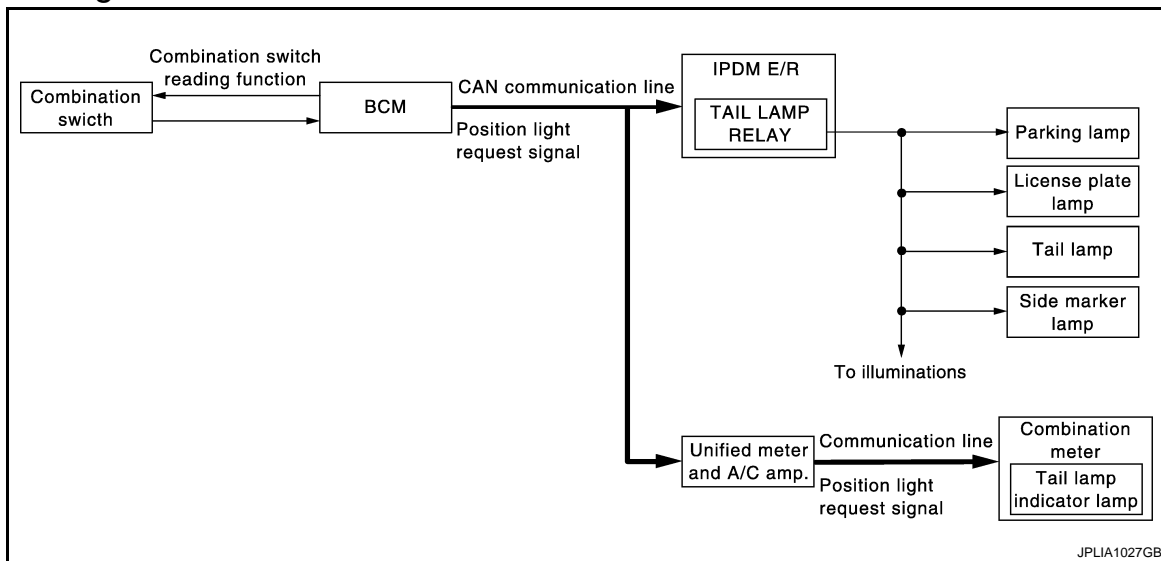

System Description

INFOID:000000003756971

OUTLINE

Parking, license plate, side marker and tail lamps are controlled by combination switch reading function and headlamp control function of BCM, and relay control function of IPDM E/R.

PARKING, LICENSE PLATE, SIDE MARKER AND TAIL LAMPS OPERATION

- BCM detects the combination switch condition by the combination switch reading function.
- BCM transmits the position light request signal to IPDM E/R with CAN communication according to the ON/OFF condition of the parking, license plate, side marker and tail lamps.

Parking, license plate, side marker and tail lamps ON condition

- Lighting switch 1ST
- Lighting switch 2ND
- Lighting switch AUTO, and the auto light function ON judgment (with auto light system)
- IPDM E/R turns the integrated tail lamp relay ON and turns the parking lamp, the license plate, side marker and tail lamps ON according to the position light request signal.
- Combination meter turns the tail lamp indicator lamp ON according to the position light request signal.

PARKING, LICENSE PLATE AND TAIL LAMPS SYSTEM

< FUNCTION DIAGNOSIS >

[HALOGEN TYPE]

Component Parts Location

INFOID:000000003756972

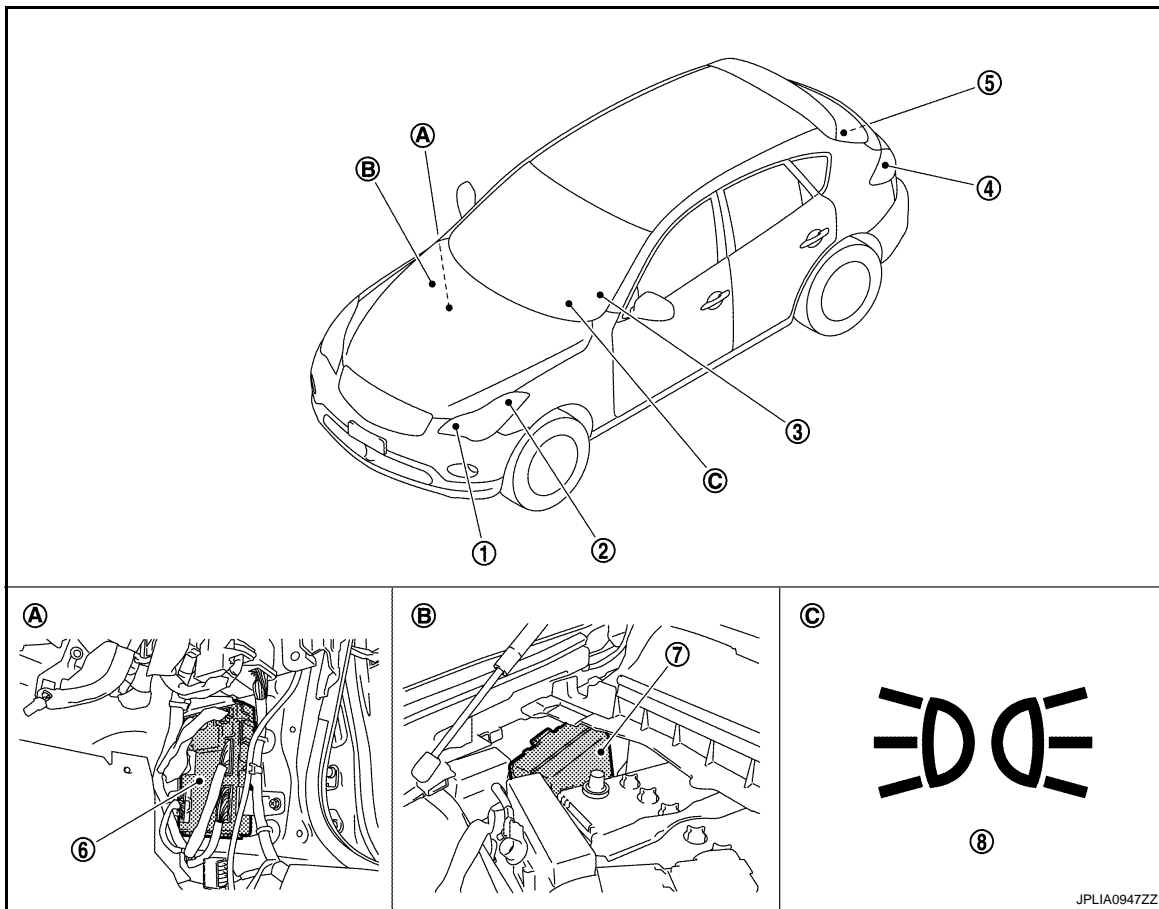

- | | | |
|-------------------------------------|--------------------------------|-----------------------------|
| 1. Parking lamp | 2. Side marker lamp | 3. Combination switch |
| 4. Tail lamp and side marker lamp | 5. License plate lamp | 6. BCM |
| 7. IPDM E/R | 8. Tail lamp indicator lamp | |
| A. Dash side lower (Passenger side) | B. Engine room dash panel (RH) | C. On the combination meter |

Component Description

INFOID:000000003756973

Part	Description
BCM	<ul style="list-style-type: none"> Judges each switch condition by the combination switch reading function. Judges the ON/OFF status of the clearance, license plate, side marker and tail lamps according to the vehicle condition. Requests the tail lamp relay ON to IPDM E/R (with CAN communication).
IPDM E/R	Controls the integrated relay and supplies voltage to the load according to the request from BCM (with CAN communication).
Combination switch (Lighting & turn signal switch)	Refer to BCS-8, "System Diagram" .
Combination meter (Tail lamp indicator lamp)	Turns the tail lamp indicator lamp ON according to the request from BCM [with CAN communication (through the unified meter and A/C amp.)].

EXTERIOR LAMP BATTERY SAVER SYSTEM

< FUNCTION DIAGNOSIS >

[HALOGEN TYPE]

EXTERIOR LAMP BATTERY SAVER SYSTEM

System Diagram

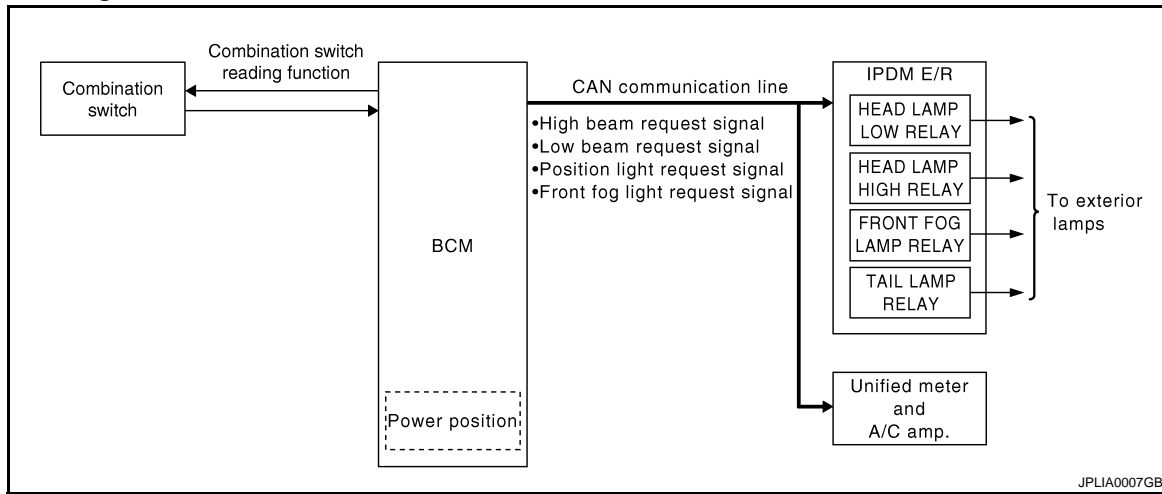

System Description

INFOID:000000003756975

OUTLINE

- Exterior lamp battery saver system is controlled by each function of BCM and IPDM E/R.

Control by BCM

- Combination switch reading function
- Headlamp control function
- Exterior lamp battery saver function

Control by IPDM E/R

- Relay control function
- BCM turns the exterior lamp* OFF after a period of time to prevent the battery from over-discharge when the ignition switch is turned OFF with the exterior lamp ON.

*: Headlamp (LO/HI), parking lamp, tail lamp, side marker lamp, license plate lamp and front fog lamp

NOTE:

When the lighting switch is turned AUTO, the exterior lamp battery saver switches to the auto light system. Refer to [EXL-215. "System Diagram"](#).

EXTERIOR LAMP BATTERY SAVER ACTIVATION

BCM activates the timer and turns the exterior lamp OFF 5 minutes after the ignition switch is turned from ON → OFF with the exterior lamps ON.

NOTE:

- Headlamp control function turns the exterior lamps ON normally when the ignition switch is turned ACC or the engine started (both before and after the exterior lamp battery saver is turned OFF).
- The timer starts at the time that the lighting switch is turned from OFF → 1ST or 2ND with the exterior lamp OFF.

EXTERIOR LAMP BATTERY SAVER SYSTEM

< FUNCTION DIAGNOSIS >

[HALOGEN TYPE]

Component Parts Location

INFOID:000000003756976

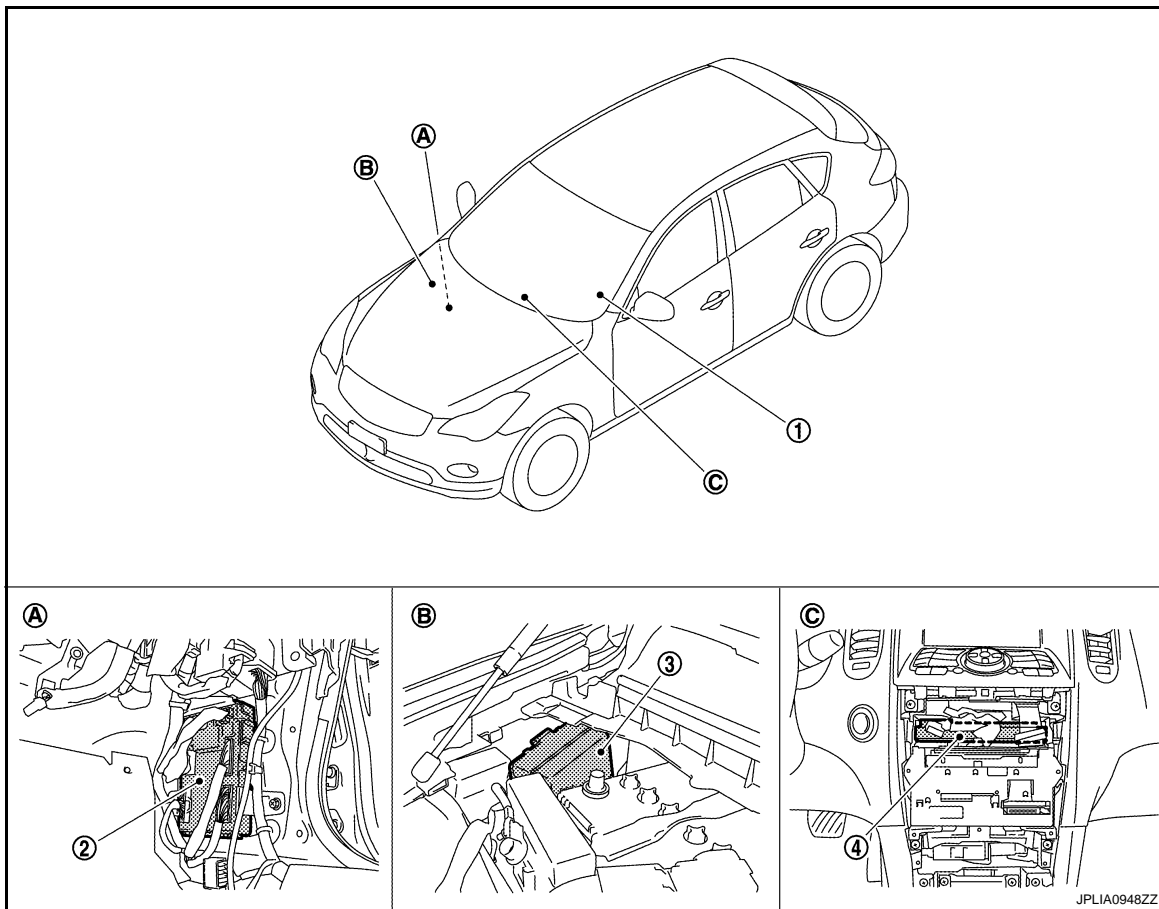

- | | | |
|-------------------------------------|--------------------------------|-----------------------------|
| 1. Combination switch | 2. BCM | 3. IPDM E/R |
| 4. Unified meter and A/C amp. | | |
| A. Dash side lower (Passenger side) | B. Engine room dash panel (RH) | C. Behind the cluster lid C |

Component Description

INFOID:000000003756977

Part	Description
BCM	<ul style="list-style-type: none"> Judges each switch condition by the combination switch reading function. Judges the exterior lamp OFF according to the vehicle condition. Requests each relay OFF to IPDM E/R (with CAN communication).
IPDM E/R	Controls the integrated relay according to the request from BCM (with CAN communication).
Combination switch (Lighting & turn signal switch)	Refer to BCS-8, "System Diagram" .

DIAGNOSIS SYSTEM (BCM)

< FUNCTION DIAGNOSIS >

[HALOGEN TYPE]

DIAGNOSIS SYSTEM (BCM)

COMMON ITEM

COMMON ITEM : CONSULT-III Function (BCM - COMMON ITEM)

INFOID:000000003784723

APPLICATION ITEM

CONSULT-III performs the following functions via CAN communication with BCM.

Diagnosis mode	Function Description
Work Support	Changes the setting for each system function.
Self Diagnostic Result	Displays the diagnosis results judged by BCM.
CAN Diag Support Monitor	Monitors the reception status of CAN communication viewed from BCM. Refer to CONSULT-III operation manual.
Data Monitor	The BCM input/output signals are displayed.
Active Test	The signals used to activate each device are forcibly supplied from BCM.
Ecu Identification	The BCM part number is displayed.
Configuration	<ul style="list-style-type: none"> • Read and save the vehicle specification. • Write the vehicle specification when replacing BCM.

SYSTEM APPLICATION

BCM can perform the following functions for each system.

NOTE:

It can perform the diagnosis modes except the following for all sub system selection items.

x: Applicable item

System	Sub system selection item	Diagnosis mode		
		Work Support	Data Monitor	Active Test
Door lock	DOOR LOCK	x	x	x
Rear window defogger	REAR DEFOGGER		x	x
Warning chime	BUZZER		x	x
Interior room lamp timer	INT LAMP	x	x	x
Exterior lamp	HEAD LAMP	x	x	x
Wiper and washer	WIPER		x	x
Turn signal and hazard warning lamps	FLASHER	x	x	x
—	AIR CONDITONER*			
<ul style="list-style-type: none"> • Intelligent Key system • Engine start system 	INTELLIGENT KEY	x	x	x
Combination switch	COMB SW		x	
Body control system	BCM	x		
IVIS - NATS	IMMU		x	x
Interior room lamp battery saver	BATTERY SAVER	x	x	x
—	TRUNK*		x	x
Vehicle security system	THEFT ALM	x	x	x
RAP system	RETAINED PWR		x	
Signal buffer system	SIGNAL BUFFER		x	x
TPMS	TPMS (AIR PRESSURE MONITOR)	x	x	x

NOTE:

*: This item is displayed, but is not used.

FREEZE FRAME DATA (FFD) AND IGN COUNTER

Freeze Frame Data

DIAGNOSIS SYSTEM (BCM)

[HALOGEN TYPE]

< FUNCTION DIAGNOSIS >

The BCM records the following condition at the moment a particular DTC is detected.

- Vehicle Speed
- Odd Trip Meter
- Vehicle Condition (BCM detected condition)

CONSULT screen terms	Description
SLEEP>LOCK	While turning BCM status from low power consumption mode to normal mode (Power supply position is "LOCK")
SLEEP>OFF	While turning BCM status from low power consumption mode to normal mode (Power supply position is "OFF".)
LOCK>ACC	While turning power supply position from "LOCK" to "ACC"
ACC>ON	While turning power supply position from "ACC" to "IGN"
RUN>ACC	While turning power supply position from "RUN" to "ACC" (Vehicle is stopping and selector lever is except P position.)
CRANK>RUN	While turning power supply position from "CRANKING" to "RUN" (From cranking up the engine to run it)
RUN>URGENT	While turning power supply position from "RUN" to "ACC" (Emergency stop operation)
ACC>OFF	While turning power supply position from "ACC" to "OFF"
OFF>LOCK	While turning power supply position from "OFF" to "LOCK"
OFF>ACC	While turning power supply position from "OFF" to "ACC"
ON>CRANK	While turning power supply position from "IGN" to "CRANKING"
OFF>SLEEP	While turning BCM status from normal mode (Power supply position is "OFF".) to low power consumption mode
LOCK>SLEEP	While turning BCM status from normal mode (Power supply position is "LOCK".) to low power consumption mode
LOCK	Power supply position is "LOCK" (Ignition switch OFF with steering is locked.)
OFF	Power supply position is "OFF" (Ignition switch OFF with steering is unlocked.)
ACC	Power supply position is "ACC" (Ignition switch ACC)
ON	Power supply position is "IGN" (Ignition switch ON with engine stopped)
ENGINE RUN	Power supply position is "RUN" (Ignition switch ON with engine running)
CRANKING	Power supply position is "CRANKING" (At engine cranking)

IGN Counter

IGN counter indicates the number of times that ignition switch is turned ON after DTC is detected.

- The number is 0 when a malfunction is detected now.
- The number increases like 1 → 2 → 3...38 → 39 after returning to the normal condition whenever ignition switch OFF → ON.
- The number is fixed to 39 until the self-diagnosis results are erased if it is over 39.

HEADLAMP

HEADLAMP : CONSULT-III Function (BCM - HEAD LAMP)

INFOID:000000003757048

WORK SUPPORT

Service item	Setting item	Setting
BATTERY SAVER SET	On*	With the exterior lamp battery saver function
	Off	Without the exterior lamp battery saver function

DIAGNOSIS SYSTEM (BCM)

< FUNCTION DIAGNOSIS >

[HALOGEN TYPE]

Service item	Setting item	Setting	
ILL DELAY SET	MODE 1*	45 sec.	Sets delay timer function timer operation time. (All doors closed)
	MODE 2	Without the function	
	MODE 3	30 sec.	
	MODE 4	60 sec.	
	MODE 5	90 sec.	
	MODE 6	120 sec.	
	MODE 7	150 sec.	
	MODE 8	180 sec.	
CUSTOM A/LIGHT SETTING	MODE 1*	Normal	
	MODE 2	More sensitive setting than normal setting (Turns ON earlier than normal operation.)	
	MODE 3	More sensitive setting than MODE 2 (Turns ON earlier than MODE 2.)	
	MODE 4	Less sensitive setting than normal setting (Turns ON later than normal operation.)	

*: Initial setting

DATA MONITOR

Monitor item [Unit]	Description	
PUSH SW [On/Off]	The switch status input from push-button ignition switch	
ENGINE STATE [Stop/Stall/Crank/Run]	The engine status received from ECM with CAN communication	
VEH SPEED 1 [km/h]	The value of the vehicle speed received from unified meter and A/C amp. with CAN communication	
KEY SW-SLOT [On/Off]	Key switch status input from key slot	
TURN SIGNAL R [On/Off]	Each switch status that BCM judges from the combination switch reading function	
TURN SIGNAL L [On/Off]		
TAIL LAMP SW [On/Off]		
HI BEAM SW [On/Off]		
HEAD LAMP SW1 [On/Off]		
HEAD LAMP SW2 [On/Off]		
PASSING SW [On/Off]		
AUTO LIGHT SW [On/Off]		
FR FOG SW [On/Off]		
RR FOG SW [On/Off]		NOTE: The item is indicated, but not monitored.
DOOR SW-DR [On/Off]		The switch status input from front door switch (driver side)
DOOR SW-AS [On/Off]		The switch status input from front door switch (passenger side)

DIAGNOSIS SYSTEM (BCM)

[HALOGEN TYPE]

< FUNCTION DIAGNOSIS >

Monitor item [Unit]	Description
DOOR SW-RR [On/Off]	The switch status input from rear door switch RH
DOOR SW- RL [On/Off]	The switch status input from rear door switch LH
DOOR SW-BK [On/Off]	NOTE: The item is indicated, but not monitored.
OPTICAL SENSOR [V]	The value of exterior brightness voltage input from the optical sensor

ACTIVE TEST

Test item	Operation	Description
TAIL LAMP	On	Transmits the position light request signal to IPDM E/R with CAN communication to turn the tail lamp ON.
	Off	Stops the position light request signal transmission.
HEAD LAMP	Hi	Transmits the high beam request signal with CAN communication to turn the headlamp (HI).
	Low	Transmits the low beam request signal with CAN communication to turn the headlamp (LO).
	Off	Stops the high & low beam request signal transmission.
FR FOG LAMP	On	Transmits the front fog light request signal to IPDM E/R with CAN communication to turn the front fog lamp ON.
	Off	Stops the front fog light request signal transmission.
RR FOG LAMP	On	NOTE: The item is indicated, but cannot be tested.
	Off	
DAYTIME RUNNING LIGHT	On	NOTE: The item is indicated, but cannot be tested.
	Off	
CORNERING LAMP	RH	NOTE: The item is indicated, but cannot be tested.
	LH	
	Off	
ILL DIM SIGNAL	On	NOTE: The item is indicated, but cannot be tested.
	Off	

FLASHER

FLASHER : CONSULT-III Function (BCM - FLASHER)

INFOID:000000003757049

WORK SUPPORT

Service item	Setting item	Setting
HAZARD ANSWER BACK	Lock Only*	With locking only
	Unlk Only	With unlocking only
	Lock/Unlk	With locking/unlocking
	Off	Without the function
		Sets the hazard warning lamp answer back function when the door is lock/unlock with the request switch or the key fob.

*: Initial setting

DATA MONITOR

DIAGNOSIS SYSTEM (BCM)

< FUNCTION DIAGNOSIS >

[HALOGEN TYPE]

Monitor item [Unit]	Description
REQ SW-DR [On/Off]	The switch status input from the request switch (driver side)
REQ SW-AS [On/Off]	The switch status input from the request switch (passenger side)
PUSH SW [On/Off]	The switch status input from the push-button ignition switch
TURN SIGNAL R [On/Off]	Each switch condition that BCM judges from the combination switch reading function
TURN SIGNAL L [On/Off]	
HAZARD SW [On/Off]	The switch status input from the hazard switch
RKE-LOCK [On/Off]	Lock signal status received from the remote keyless entry receiver
RKE-UNLOCK [On/Off]	Unlock signal status received from the remote keyless entry receiver
RKE-PANIC [On/Off]	Panic alarm signal status received from the remote keyless entry receiver

ACTIVE TEST

Test item	Operation	Description
FLASHER	RH	Outputs the voltage to blink the right side turn signal lamps.
	LH	Outputs the voltage to blink the left side turn signal lamps.
	Off	Stops the voltage to turn the turn signal lamps OFF.

A
B
C
D
E
F
G
H
I
J
K
L
M
N
O
P

EXL

DIAGNOSIS SYSTEM (IPDM E/R)

Diagnosis Description

INFOID:000000003757052

AUTO ACTIVE TEST

Description

In auto active test mode, the IPDM E/R sends a drive signal to the following systems to check their operation.

- Oil pressure warning lamp
- Front wiper (LO, HI)
- Parking lamps
- License plate lamps
- Side marker lamps
- Tail lamps
- Front fog lamps
- Headlamps (LO, HI)
- A/C compressor (magnet clutch)
- Cooling fan (cooling fan control module)

Operation Procedure

1. Close the hood and lift the wiper arms from the windshield. (Prevent windshield damage due to wiper operation)

NOTE:

When auto active test is performed with hood opened, sprinkle water on windshield beforehand.

2. Turn ignition switch OFF.
3. Turn the ignition switch ON, and within 20 seconds, press the driver door switch 10 times. Then turn the ignition switch OFF.

CAUTION:

Close passenger door.

4. Turn the ignition switch ON within 10 seconds. After that the horn sounds once and the auto active test starts.
5. The oil pressure warning lamp starts blinking when the auto active test starts.
6. After a series of the following operations is repeated 3 times, auto active test is completed.

NOTE:

When auto active test mode has to be cancelled halfway through test, turn ignition switch OFF.

CAUTION:

- If auto active test mode cannot be actuated, check door switch system. Refer to [DLK-63](#), "[Component Function Check](#)".
- Do not start the engine.

Inspection in Auto Active Test Mode

When auto active test mode is actuated, the following 5 steps are repeated 3 times.

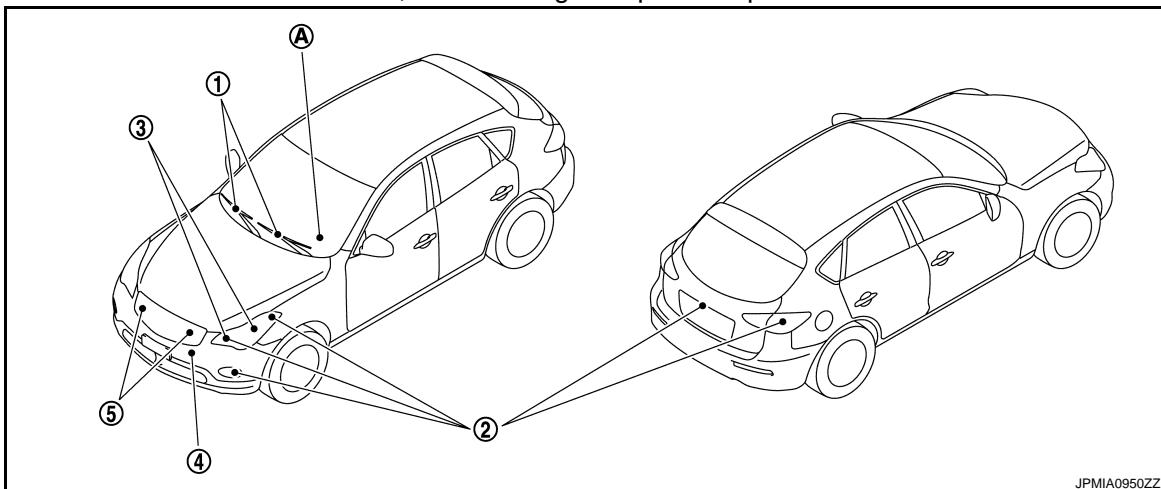

JPMIA0950ZZ

DIAGNOSIS SYSTEM (IPDM E/R)

< FUNCTION DIAGNOSIS >

[HALOGEN TYPE]

Operation sequence	Inspection location	Operation
A	Oil pressure warning lamp	Blinks continuously during operation of auto active test
1	Front wiper	LO for 5 seconds → HI for 5 seconds
2	<ul style="list-style-type: none"> • Parking lamps • License plate lamps • Side maker lamps • Tail lamps • Front fog lamps 	10 seconds
3	Headlamps	<ul style="list-style-type: none"> • LO 10 seconds • HI ON ⇔ OFF 5 times
4	A/C compressor (magnet clutch)	ON ⇔ OFF 5 times
5*	Cooling fan	MID for 5 seconds → HI for 5 seconds

*: Outputs duty ratio of 50% for 5 seconds → duty ratio of 100% for 5 seconds on the cooling fan control module.

Concept of auto active test

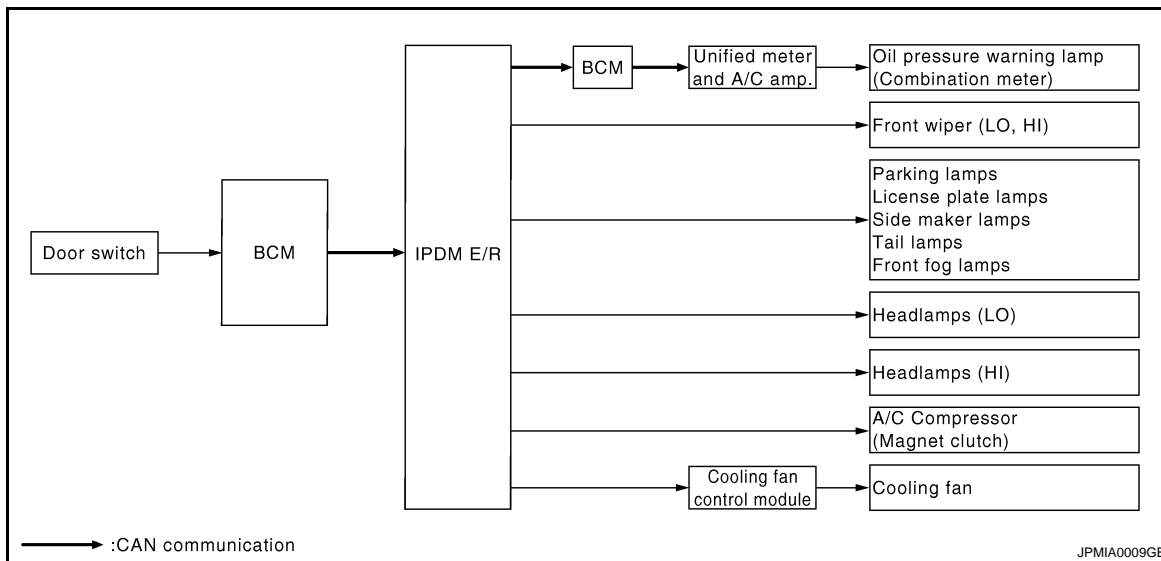

- IPDM E/R starts the auto active test with the door switch signals transmitted by BCM via CAN communication. Therefore, the CAN communication line between IPDM E/R and BCM is considered normal if the auto active test starts successfully.
- The auto active test facilitates troubleshooting if any systems controlled by IPDM E/R cannot be operated.

Diagnosis chart in auto active test mode

Symptom	Inspection contents	Possible cause
Any of the following components do not operate <ul style="list-style-type: none"> • Parking lamps • License plate lamps • Side maker lamps • Tail lamps • Front fog lamps • Headlamp (HI, LO) • Front wiper 	Perform auto active test. Does the applicable system operate?	YES BCM signal input circuit
		NO <ul style="list-style-type: none"> • Lamp or motor • Lamp or motor ground circuit • Harness or connector between IPDM E/R and applicable system • IPDM E/R

DIAGNOSIS SYSTEM (IPDM E/R)

[HALOGEN TYPE]

< FUNCTION DIAGNOSIS >

Symptom	Inspection contents	Possible cause
A/C compressor does not operate	Perform auto active test. Does the magnet clutch operate?	YES <ul style="list-style-type: none"> • Unified meter and A/C amp. signal input circuit • CAN communication signal between unified meter and A/C amp. and ECM • CAN communication signal between ECM and IPDM E/R
		NO <ul style="list-style-type: none"> • Magnet clutch • Harness or connector between IPDM E/R and magnet clutch • IPDM E/R
Oil pressure warning lamp does not operate	Perform auto active test. Does the oil pressure warning lamp blink?	YES <ul style="list-style-type: none"> • Harness or connector between IPDM E/R and oil pressure switch • Oil pressure switch • IPDM E/R
		NO <ul style="list-style-type: none"> • CAN communication signal between IPDM E/R and BCM • CAN communication signal between BCM and unified meter and A/C amp. • Combination meter
Cooling fan does not operate	Perform auto active test. Does the cooling fan operate?	YES <ul style="list-style-type: none"> • ECM signal input circuit • CAN communication signal between ECM and IPDM E/R
		NO <ul style="list-style-type: none"> • Cooling fan • Harness or connector between cooling fan and cooling fan control module • Cooling fan control module • Harness or connector between IPDM E/R and cooling fan control module • Cooling fan relay • Harness or connector between IPDM E/R and cooling fan relay • IPDM E/R

CONSULT-III Function (IPDM E/R)

INFOID:000000003757053

APPLICATION ITEM

CONSULT-III performs the following functions via CAN communication with IPDM E/R.

Diagnosis mode	Description
Ecu Identification	Allows confirmation of IPDM E/R part number.
Self Diagnostic Result	Displays the diagnosis results judged by IPDM E/R.
Data Monitor	Displays the real-time input/output data from IPDM E/R input/output data.
Active Test	IPDM E/R can provide a drive signal to electronic components to check their operations.
CAN Diag Support Monitor	The results of transmit/receive diagnosis of CAN communication can be read.

SELF DIAGNOSTIC RESULT

Refer to [EXL-338, "DTC Index"](#).

DATA MONITOR

DIAGNOSIS SYSTEM (IPDM E/R)

[HALOGEN TYPE]

< FUNCTION DIAGNOSIS >

Monitor item

Monitor Item [Unit]	MAIN SIG- NALS	Description
RAD FAN REQ [%]	×	Displays the value of the cooling fan speed signal received from ECM via CAN communication.
AC COMP REQ [Off/On]	×	Displays the status of the A/C compressor request signal received from ECM via CAN communication.
TAIL&CLR REQ [Off/On]	×	Displays the status of the position light request signal received from BCM via CAN communication.
HL LO REQ [Off/On]	×	Displays the status of the low beam request signal received from BCM via CAN communication.
HL HI REQ [Off/On]	×	Displays the status of the high beam request signal received from BCM via CAN communication.
FR FOG REQ [Off/On]	×	Displays the status of the front fog light request signal received from BCM via CAN communication.
FR WIP REQ [Stop/1LOW/Low/Hi]	×	Displays the status of the front wiper request signal received from BCM via CAN communication.
WIP AUTO STOP [STOP P/ACT P]	×	Displays the status of the front wiper auto stop signal judged by IPDM E/R.
WIP PROT [Off/BLOCK]	×	Displays the status of the front wiper fail-safe operation judged by IPDM E/R.
IGN RLY1 -REQ [Off/On]		Displays the status of the ignition switch ON signal received from BCM via CAN communication.
IGN RLY [Off/On]	×	Displays the status of the ignition relay judged by IPDM E/R.
PUSH SW [Off/On]		Displays the status of the push-button ignition switch judged by IPDM E/R.
INTER/NP SW [Off/On]		Displays the status of the shift position judged by IPDM E/R.
ST RLY CONT [Off/On]		Displays the status of the starter relay status signal received from BCM via CAN communication.
IHBT RLY -REQ [Off/On]		Displays the status of the starter control relay signal received from BCM via CAN communication.
ST/INHI RLY [Off/ ST /INHI/UNKWN]		Displays the status of the starter relay and starter control relay judged by IPDM E/R.
DETENT SW [Off/On]		Displays the status of the control device (detention switch) judged by IPDM E/R.
S/L RLY -REQ [Off/On]		Displays the status of the steering lock relay request received from BCM via CAN communication.
S/L STATE [LOCK/UNLOCK/UNKWN]		Displays the status of the steering lock judged by IPDM E/R.
DTRL REQ [Off]		NOTE: The item is indicated, but not monitored.
OIL P SW [Open/Close]		Displays the status of the oil pressure switch judged by IPDM E/R.
HOOD SW [Off/On]		Displays the status of the hood switch judged by IPDM E/R.
HL WASHER REQ [Off]		NOTE: The item is indicated, but not monitored.
THFT HRN REQ [Off/On]		Displays the status of the theft warning horn request signal received from BCM via CAN communication.

A
B
C
D
E
F
G
H
I
J
K
EXL
M
N
O
P

DIAGNOSIS SYSTEM (IPDM E/R)

[HALOGEN TYPE]

< FUNCTION DIAGNOSIS >

Monitor Item [Unit]	MAIN SIG- NALS	Description
HORN CHIRP [Off/On]		Displays the status of the horn reminder signal received from BCM via CAN communication.
CRNRNG LMP REQ [Off]		NOTE: The item is indicated, but not monitored.

ACTIVE TEST

Test item

Test item	Operation	Description
CORNERING LAMP	Off	NOTE: The item is indicated, but cannot be tested.
	LH	
	RH	
HORN	On	Operates horn relay 1 and horn relay 2 for 20 ms.
FRONT WIPER	Off	OFF
	Lo	Operates the front wiper relay.
	Hi	Operates the front wiper relay and front wiper high relay.
MOTOR FAN	1	OFF
	2	Outputs 50% pulse duty signal (PWM signal) to the cooling fan control module.
	3	Outputs 80% pulse duty signal (PWM signal) to the cooling fan control module.
	4	Outputs 100% pulse duty signal (PWM signal) to the cooling fan control module.
HEAD LAMP WASHER	On	NOTE: The item is indicated, but cannot be tested.
EXTERNAL LAMPS	Off	OFF
	TAIL	Operates the tail lamp relay.
	Lo	Operates the headlamp low relay.
	Hi	Operates the headlamp low relay and ON/OFF the headlamp high relay at 1 second intervals.
	Fog	Operates the front fog lamp relay.

POWER SUPPLY AND GROUND CIRCUIT

< COMPONENT DIAGNOSIS >

[HALOGEN TYPE]

COMPONENT DIAGNOSIS

POWER SUPPLY AND GROUND CIRCUIT

BCM (BODY CONTROL MODULE)

BCM (BODY CONTROL MODULE) : Diagnosis Procedure

INFOID:000000003757056

1. CHECK FUSE AND FUSIBLE LINK

Check that the following fuse and fusible link are not blown.

Signal name	Fuse and fusible link No.
Battery power supply	K
	10

Is the fuse fusing?

YES >> Replace the blown fuse or fusible link after repairing the affected circuit if a fuse or fusible link is blown.

NO >> GO TO 2.

2. CHECK POWER SUPPLY CIRCUIT

1. Turn ignition switch OFF.
2. Disconnect BCM connectors.
3. Check voltage between BCM harness connector and ground.

Terminals		Voltage (Approx.)
(+)	(-)	
BCM		Ground Battery voltage
Connector	Terminal	
M118	1	
M119	11	

Is the measurement value normal?

YES >> GO TO 3.

NO >> Repair harness or connector.

3. CHECK GROUND CIRCUIT

Check continuity between BCM harness connector and ground.

BCM		Ground	Continuity
Connector	Terminal		
M119	13		Existed

Does continuity exist?

YES >> INSPECTION END

NO >> Repair harness or connector.

IPDM E/R (INTELLIGENT POWER DISTRIBUTION MODULE ENGINE ROOM)

IPDM E/R (INTELLIGENT POWER DISTRIBUTION MODULE ENGINE ROOM) : Diagnosis Procedure

INFOID:000000003757059

1. CHECK FUSES AND FUSIBLE LINK

Check that the following IPDM E/R fuses or fusible links are not blown.

A
B
C
D
E
F
G
H
I
J
K
EXL
M
N
O
P

POWER SUPPLY AND GROUND CIRCUIT

< COMPONENT DIAGNOSIS >

[HALOGEN TYPE]

Signal name	Fuses and fusible link No.
Battery power supply	C
	50
	51

Is the fuse fusing?

YES >> Replace the blown fuse or fusible link after repairing the affected circuit if a fuse or fusible link is blown.

NO >> GO TO 2.

2.CHECK POWER SUPPLY CIRCUIT

1. Turn ignition switch OFF.
2. Disconnect IPDM E/R connector.
3. Check voltage between IPDM E/R harness connector and ground.

Terminals		Voltage (Approx.)
(+)	(-)	
IPDM E/R		Battery voltage
Connector	Terminal	
E4	1	

Is the measurement value normal?

YES >> GO TO 3.

NO >> Repair harness or connector.

3.CHECK GROUND CIRCUIT

Check continuity between IPDM E/R harness connectors and ground.

IPDM E/R		Ground	Continuity
Connector	Terminal		
E5	12		Existed
E6	41		

Does continuity exist?

YES >> INSPECTION END

NO >> Repair harness or connector.

EXTERIOR LAMP FUSE

[HALOGEN TYPE]

< COMPONENT DIAGNOSIS >

EXTERIOR LAMP FUSE

Description

INFOID:000000003533997

Fuse list

Unit	Location	Fuse No.	Capacity
Headlamp HI (LH)	IPDM E/R	#54	10 A
Headlamp HI (RH)	IPDM E/R	#55	10 A
Headlamp LO (LH)	IPDM E/R	#56	15 A
Headlamp LO (RH)	IPDM E/R	#57	15 A
Front fog lamp	IPDM E/R	#58	15 A
Parking lamp (also used as the front side marker lamp)	IPDM E/R	#52	10 A
<ul style="list-style-type: none"> • Tail lamp • Rear side marker lamp • License plate lamp • Each illumination 	IPDM E/R	#53	10 A
Stop lamp	FUSE BLOCK (J/B)	#7	10 A
Back-up lamp	FUSE BLOCK (J/B)	#4	10 A

Diagnosis Procedure

INFOID:000000003533998

1. CHECK FUSE

Check that the following fuses are not fusing.

Unit	Location	Fuse No.	Capacity
Headlamp HI (LH)	IPDM E/R	#54	10 A
Headlamp HI (RH)	IPDM E/R	#55	10 A
Headlamp LO (LH)	IPDM E/R	#56	15 A
Headlamp LO (RH)	IPDM E/R	#57	15 A
Front fog lamp	IPDM E/R	#58	15 A
Parking lamp (also used as the front side marker lamp)	IPDM E/R	#52	10 A
<ul style="list-style-type: none"> • Tail lamp • Rear side marker lamp • License plate lamp • Each illumination 	IPDM E/R	#53	10 A
Stop lamp	FUSE BLOCK (J/B)	#7	10 A
Back-up lamp	FUSE BLOCK (J/B)	#4	10 A

Is the fuse fusing?

- YES >> Repair the applicable circuit. And then replace the fuse.
 NO >> The fuse is normal.

A
B
C
D
E
F
G
H
I
J
K
L
M
N
O
P

EXL

HEADLAMP (HI) CIRCUIT

< COMPONENT DIAGNOSIS >

[HALOGEN TYPE]

HEADLAMP (HI) CIRCUIT

Component Function Check

INFOID:000000003534188

1. CHECK HEADLAMP (HI) OPERATION

IPDM E/R AUTO ACTIVE TEST

1. Activate IPDM E/R auto active test. Refer to [PCS-11, "Diagnosis Description"](#).
2. Check that the headlamp switches to the high beam.

CONSULT-III ACTIVE TEST

1. Select "EXTERNAL LAMP" of IPDM E/R active test item.
2. With operating the test items, check that the headlamp (HI) is turned ON.

Hi : Headlamp (HI) ON

Off : Headlamp (HI) OFF

NOTE:

ON/OFF is repeated 1 second each.

Is the headlamp (HI) turned ON?

- YES >> Headlamp (HI) circuit is normal.
NO >> Refer to [EXL-242, "Diagnosis Procedure"](#).

Diagnosis Procedure

INFOID:000000003534189

1. CHECK HEADLAMP (HI) OUTPUT VOLTAGE

CONSULT-III ACTIVE TEST

1. Turn the ignition switch OFF.
2. Disconnect the headlamp high connector.
3. Turn the ignition switch ON.
4. Select "EXTERNAL LAMP" of IPDM E/R active test item.
5. With operating the test items, check the voltage between the IPDM E/R harness connector and the ground.

Terminals			Condition	Voltage (Approx.)
(+)	(-)			
IPDM E/R			External lamp	
Connector	Terminal			
RH	E8	89	Hi	Battery voltage
		90	Off	0 V
LH			Hi	Battery voltage
			Off	0 V

Is the measurement value normal?

- YES >> GO TO 2.
NO >> GO TO 3.

2. CHECK HEADLAMP (HI) OPEN CIRCUIT

1. Turn the ignition switch OFF.
2. Disconnect IPDM E/R connector.
3. Check continuity between the IPDM E/R harness connector and the front combination lamp harness connector.

HEADLAMP (HI) CIRCUIT

[HALOGEN TYPE]

< COMPONENT DIAGNOSIS >

IPDM E/R		Front combination lamp		Continuity
Connector	Terminal	Connector	Terminal	
RH	E8	89	E28	Existed
LH		90	E58	

Does continuity exist?

YES >> GO TO 5.

NO >> Repair the harnesses or connectors.

3. CHECK HEADLAMP (HI) FUSE

1. Turn the ignition switch OFF.
2. Check that the following fuses are not fusing.

Unit	Location	Fuse No.	Capacity
Headlamp HI (RH)	IPDM E/R	#55	10 A
Headlamp HI (LH)	IPDM E/R	#54	10 A

Is the fuse fusing?

YES >> GO TO 4.

NO >> Replace IPDM E/R.

4. CHECK HEADLAMP (HI) SHORT CIRCUIT

1. Disconnect IPDM E/R connector.
2. Check continuity between the IPDM E/R harness connector terminal and the ground.

IPDM E/R		Ground	Continuity
Connector	Terminal		
RH	E8	89	Not existed
LH			

Does continuity exist?

YES >> Repair the harnesses or connectors. And then replace the fuse.

NO >> Replace the fuse. (Replace IPDM E/R if the fuse is fusing again.)

5. CHECK HEADLAMP (HI) GROUND OPEN CIRCUIT

1. Turn the ignition switch OFF.
2. Disconnect the front combination lamp connector.
3. Check continuity between the front combination lamp harness connector and ground.

Front combination lamp		Ground	Continuity
Connector	Terminal		
RH	E28	2	Existed
LH	E58		

Does continuity exist?

YES >> Replace the headlamp (HI) bulb. (Bulb socket is abnormally.)

NO >> Repair the harnesses or connectors.

A
B
C
D
E
F
G
H
I
J
K
EXL
M
N
O
P

HEADLAMP (LO) CIRCUIT

< COMPONENT DIAGNOSIS >

[HALOGEN TYPE]

HEADLAMP (LO) CIRCUIT

Component Function Check

INFOID:000000003534190

1. CHECK HEADLAMP (LO) OPERATION

⊗ IPDM E/R AUTO ACTIVE TEST

1. Activate IPDM E/R auto active test. Refer to [PCS-11, "Diagnosis Description"](#).
2. Check that the headlamp is turned ON.

Ⓟ CONSULT-III ACTIVE TEST

1. Select "EXTERNAL LAMP" of IPDM E/R active test item.
2. With operating the test items, check that the headlamp (LO) is turned ON.

Lo : Headlamp (LO) ON
Off : Headlamp (LO) OFF

Is the headlamp (LO) turned ON?

- YES >> Headlamp (LO) is normal.
 NO >> Refer to [EXL-244, "Diagnosis Procedure"](#).

Diagnosis Procedure

INFOID:000000003534191

1. CHECK HEADLAMP (LO) OUTPUT VOLTAGE

Ⓟ CONSULT-III ACTIVE TEST

1. Turn the ignition switch OFF.
2. Disconnect the front combination lamp connector.
3. Turn the ignition switch ON.
4. Select "EXTERNAL LAMP" of IPDM E/R active test item.
5. With operating the test items, check the voltage between the IPDM E/R harness connector and the ground.

Terminals			Test item	Voltage (Approx.)
(+) (+)		(-) (-)		
IPDM E/R			External lamp	Battery voltage
Connector	Terminal			
RH	E8	83	Lo	
LH		84	Off	
			Lo	Battery voltage
			Off	0 V

Is the measurement value normal?

- YES >> GO TO 2.
 NO >> GO TO 3.

2. CHECK HEADLAMP (LO) OPEN CIRCUIT

1. Turn the ignition switch OFF.
2. Disconnect IPDM E/R connector.
3. Check continuity between the IPDM E/R harness connector and the front combination lamp harness connector.

IPDM E/R		Front combination lamp		Continuity
Connector	Terminal	Connector	Terminal	
RH	E8	E28	5	Existed
LH		84	E58	

HEADLAMP (LO) CIRCUIT

[HALOGEN TYPE]

< COMPONENT DIAGNOSIS >

Does continuity exist?

- YES >> GO TO 5.
NO >> Repair the harnesses or connectors.

3.CHECK HEADLAMP (LO) FUSE

1. Turn the ignition switch OFF.
2. Check that the following fuses are not fusing.

Unit	Location	Fuse No.	Capacity
Headlamp LO (RH)	IPDM E/R	#57	15 A
Headlamp LO (LH)	IPDM E/R	#56	15 A

Is the fuse fusing?

- YES >> GO TO 4.
NO >> Replace IPDM E/R.

4.CHECK HEADLAMP (LO) SHORT CIRCUIT

1. Disconnect IPDM E/R connector.
2. Check continuity between the IPDM E/R harness connector and the ground.

IPDM E/R		Ground	Continuity
Connector	Terminal		
RH	E8	83	Not existed
LH		84	

Does continuity exist?

- YES >> Repair the harnesses or connectors. And then replace the fuse.
NO >> Replace the fuse. (Replace IPDM E/R if the fuse is fusing again.)

5.CHECK HEADLAMP (LO) GROUND OPEN CIRCUIT

1. Turn the ignition switch OFF.
2. Disconnect the front combination lamp connector.
3. Check continuity between the front combination lamp harness connector and ground.

Front combination lamp		Ground	Continuity
Connector	Terminal		
RH	E28	3	Existed
LH	E58	3	

Does continuity exist?

- YES >> Replace the headlamp (LO) bulb. (Bulb socket is abnormally.)
NO >> Repair the harnesses or connectors.

A
B
C
D
E
F
G
H
I
J
K
M
N
O
P

EXL

FRONT FOG LAMP CIRCUIT

[HALOGEN TYPE]

< COMPONENT DIAGNOSIS >

FRONT FOG LAMP CIRCUIT

Component Function Check

INFOID:000000003756979

1. CHECK FRONT FOG LAMP OPERATION

IPDM E/R AUTO ACTIVE TEST

1. Activate IPDM E/R auto active test. Refer to [EXL-37, "Diagnosis Description"](#).
2. Check that the front fog lamp is turned ON.

CONSULT-III ACTIVE TEST

1. Select "EXTERNAL LAMPS" of IPDM E/R active test item.
2. With operating the test items, Check that the front fog lamp is turned ON.

Fog : Front fog lamp ON
Off : Front fog lamp OFF

Is the front fog lamp turned ON?

- YES >> Front fog lamp circuit is normal.
NO >> Refer to [EXL-246, "Diagnosis Procedure"](#).

Diagnosis Procedure

INFOID:000000003756980

1. CHECK FRONT FOG LAMP FUSE

1. Turn the ignition switch OFF.
2. Check that the following fuses are not fusing.

Unit	Location	Fuse No.	Capacity
Front fog lamp	IPDM E/R	#58	15 A

Is the fuse fusing?

- YES >> GO TO 2.
NO >> GO TO 3.

2. CHECK FRONT FOG LAMP SHORT CIRCUIT

1. Disconnect IPDM E/R connector and the front fog lamp connector.
2. Check continuity between the IPDM E/R harness connector and the ground.

IPDM E/R		Ground	Continuity
Connector	Terminal		
RH	E8	86	Not existed
LH		87	

Does continuity exist?

- YES >> Repair the harnesses or connectors. And then replace the fuse.
NO >> Replace the fuse. (Replace IPDM E/R if the fuse is fusing again.)

3. CHECK FRONT FOG LAMP BULB

Check the applicable lamp bulb.

Is the bulb normal?

- YES >> GO TO 4.
NO >> Replace the bulb.

4. CHECK FRONT FOG LAMP OUTPUT VOLTAGE

CONSULT-III ACTIVE TEST

1. Disconnect the front fog lamp connector.
2. Turn the ignition switch ON.
3. Select "EXTERNAL LAMPS" of IPDM E/R active test item.

FRONT FOG LAMP CIRCUIT

[HALOGEN TYPE]

< COMPONENT DIAGNOSIS >

4. With operating the test items, check the voltage between the IPDM E/R harness connector and the ground.

Terminals			Test item	Voltage (Approx.)
(+)		(-)		
IPDM E/R			EXTERNAL LAMP	Battery voltage
Connector	Terminal			
RH	E8	86	Fog	Battery voltage
LH		87	Off	0 V
			Ground	Battery voltage
				Off

Is the measurement value normal?

YES >> GO TO 5.

NO >> Replace IPDM E/R.

5. CHECK FRONT FOG LAMP OPEN CIRCUIT

1. Turn the ignition switch OFF.
2. Disconnect IPDM E/R connector.
3. Check continuity between the IPDM E/R harness connector and the front fog lamp harness connector.

IPDM E/R		Front fog lamp		Continuity
Connector	Terminal	Connector	Terminal	
RH	E8	86	E34 1	Existed
LH		87	E64 1	

Does continuity exist?

YES >> GO TO 6.

NO >> Repair the harnesses or connectors.

6. CHECK FRONT FOG LAMP GROUND CIRCUIT OPEN CIRCUIT

Check continuity between the front fog lamp harness connector and the ground.

Front fog lamp			Ground	Continuity
Connector	Terminal			
RH	E34	2	Ground	Existed
LH	E64	2		

Does continuity exist?

YES >> Replace the front fog lamp.

NO >> Repair the harnesses or connectors.

A
B
C
D
E
F
G
H
I
J
K
EXL
M
N
O
P

PARKING LAMP CIRCUIT

< COMPONENT DIAGNOSIS >

[HALOGEN TYPE]

PARKING LAMP CIRCUIT

Component Function Check

INFOID:000000003756981

1. CHECK PARKING LAMP OPERATION

⊗ IPDM E/R AUTO ACTIVE TEST

1. Activate IPDM E/R auto active test. Refer to [EXL-37, "Diagnosis Description"](#).
2. Check that the parking lamp is turned ON.

Ⓟ CONSULT-III ACTIVE TEST

1. Select "EXTERNAL LAMPS" of IPDM E/R active test item.
2. With operating the test items, check that the parking lamp is turned ON.

TAIL : Parking lamp ON
Off : Parking lamp OFF

Is the parking lamp turned ON?

- YES >> Parking lamp circuit is normal.
NO >> Refer to [EXL-248, "Diagnosis Procedure"](#).

Diagnosis Procedure

INFOID:000000003756982

1. CHECK PARKING LAMP FUSE

1. Turn the ignition switch OFF.
2. Check that the following fuses are not fusing.

Unit	Location	Fuse No.	Capacity
Parking lamp	IPDM E/R	#52	10 A

Is the fuse fusing?

- YES >> GO TO 2.
NO >> GO TO 3.

2. CHECK PARKING LAMP SHORT CIRCUIT

1. Disconnect IPDM E/R connector and the front combination lamp connector.
2. Check continuity between the IPDM E/R harness connector and the ground.

IPDM E/R			Ground	Continuity
Connector	Terminal			
RH	E9	91		Not existed
LH		92		

Does continuity exist?

- YES >> Repair the harnesses or connectors. And then replace the fuse.
NO >> Replace the fuse. (Replace IPDM E/R if fusing is found again.)

3. CHECK PARKING LAMP BULB

Check the applicable lamp bulb.

Is the bulb normal?

- YES >> GO TO 4.
NO >> Replace the bulb.

4. CHECK PARKING LAMP OUTPUT VOLTAGE

Ⓟ CONSULT-III ACTIVE TEST

1. Disconnect the front combination lamp connector.
2. Turn the ignition switch ON.
3. Select "EXTERNAL LAMPS" of IPDM E/R active test item.

PARKING LAMP CIRCUIT

[HALOGEN TYPE]

< COMPONENT DIAGNOSIS >

- With operating the test items, check the voltage between the IPDM E/R harness connector and the ground.

Terminals			Test item	Voltage (Approx.)
(+)		(-)		
IPDM E/R			EXTERNAL LAMP	Battery voltage
Connector	Terminal			
RH	E9	91	TAIL	0 V
LH		92	TAIL	0 V
			Off	Battery voltage
			Off	0 V

Is the measurement value normal?

YES >> GO TO 5.

NO >> Replace IPDM E/R.

5. CHECK PARKING LAMP OPEN CIRCUIT

- Turn the ignition switch OFF.
- Disconnect IPDM E/R connector.
- Check continuity between the IPDM E/R harness connector and the front combination lamp harness connector.

IPDM E/R		Front combination lamp		Continuity
Connector	Terminal	Connector	Terminal	
RH	E9	E28	8	Existed
LH		92	E58	

Does continuity exist?

YES >> GO TO 6.

NO >> Repair the harnesses or connectors.

6. CHECK PARKING LAMP GROUND OPEN CIRCUIT

Check continuity between the front combination lamp harness connector and the ground.

Front combination lamp			Ground	Continuity
Connector	Terminal			
RH	E28	4	Ground	Existed
LH	E58	4		

Does continuity exist?

YES >> Replace the front combination lamp.

NO >> Repair the harnesses or connectors.

A
B
C
D
E
F
G
H
I
J
K
EXL
M
N
O
P

TURN SIGNAL LAMP CIRCUIT

< COMPONENT DIAGNOSIS >

[HALOGEN TYPE]

TURN SIGNAL LAMP CIRCUIT

Description

INFOID:000000003756983

BCM performs the high flasher operation (fail-safe) if any bulb or harness of the turn signal lamp circuit is open.

NOTE:

Turn signal lamp blinks at normal speed when using the hazard warning lamp.

Component Function Check

INFOID:000000003756984

1. CHECK TURN SIGNAL LAMP

ⓈCONSULT-III ACTIVE TEST

1. Select "FLASHER" of BCM (FLASHER) active test item.
2. With operating the test items, check that the turn signal lamp blinks.

- LH** : Turn signal lamp LH blinking
- RH** : Turn signal lamp RH blinking
- Off** : The turn signal lamp OFF

Does the turn signal lamp blink?

- YES >> Turn signal lamp circuit is normal.
- NO >> Refer to [EXL-250, "Diagnosis Procedure"](#).

Diagnosis Procedure

INFOID:000000003756985

1. CHECK TURN SIGNAL LAMP BULB

Check the applicable lamp bulb.

Is the bulb normal?

- YES >> GO TO 2.
- NO >> Replace the bulb.

2. CHECK TURN SIGNAL LAMP OUTPUT VOLTAGE

ⓈCONSULT-III ACTIVE TEST

1. Turn the ignition switch OFF.
2. Disconnect the front combination lamp connector or the rear combination lamp connector.
3. Turn the ignition switch ON.
4. Select "FLASHER" of BCM (FLASHER) active test item.
5. With operating the turn signal switch, check the voltage between the BCM harness connector and the ground.

Terminals			Test item	Voltage (Approx.)
(+)	(-)			
BCM			FLASHER	<p style="text-align: right; font-size: small;">PKID0926E</p>
Connector	Terminal			
Front RH	M119	17	LH or RH	
Front LH		18		
Rear RH	M120	20	Off	0 V
Rear LH		25		

Is the measurement value normal?

TURN SIGNAL LAMP CIRCUIT

[HALOGEN TYPE]

< COMPONENT DIAGNOSIS >

- YES >> GO TO 3.
NO >> Replace BCM.

3.CHECK TURN SIGNAL LAMP OPEN CIRCUIT

1. Turn the ignition switch OFF.
2. Disconnect BCM connector.
3. Check the continuity between the BCM harness connector and the front combination lamp or the rear combination lamp harness connector.

BCM		Front combination lamp/ Rear combination lamp		Continuity
Connector	Terminal	Connector	Terminal	
Front RH	M119	17	E28	Existed
Front LH		18	E58	
Rear RH	M120	20	B261	
Rear LH		25	B260	

Does continuity exist?

- YES >> GO TO 4.
NO >> Repair the harnesses or connectors.

4.CHECK TURN SIGNAL LAMP SHORT CIRCUIT

Check continuity between the BCM harness connector and the ground.

BCM		Ground	Continuity
Connector	Terminal		
Front RH	M119	17	Not existed
Front LH		18	
Rear RH	M120	20	
Rear LH		25	

Does continuity exist?

- YES >> Repair the harnesses or connectors.
NO >> GO TO 5.

5.CHECK TURN SIGNAL LAMP GROUND OPEN CIRCUIT

Check the continuity between the BCM harness connector and the front combination lamp or the rear combination lamp and the ground.

Front combination lamp / Rear combination lamp		Ground	Continuity
Connector	Terminal		
Front RH	E28	4	Existed
Front LH	E58	4	
Rear RH	B261	2	
Rear LH	B260	2	

Does continuity exist?

- YES >> Replace the front combination lamp or the rear combination lamp.
NO >> Repair the harnesses or connectors.

OPTICAL SENSOR

Description

INFOID:000000003756986

Optical sensor converts the outside brightness (lux) to voltage and transmits the optical sensor signal to BCM.

Component Function Check

INFOID:000000003756987

1. CHECK OPTICAL SENSOR SIGNAL BY CONSULT-III

CONSULT-III DATA MONITOR

1. Turn the ignition switch ON.
2. Select "OPTICAL SENSOR" of BCM (HEADLAMP) data monitor item.
3. Turn the lighting switch AUTO.
4. With the optical sensor illuminating, check the monitor status.

Monitor item	Condition	Voltage (Approx.)
OPTICAL SENSOR	Optical sensor	When illuminating
		When shutting off light
		3.1 V or more *
		0.6 V or less

*: Illuminates the optical sensor. The value may be less than the standard value if brightness is weak.

Is the item status normal?

- YES >> Optical sensor is normal.
 NO >> Refer to [EXL-252, "Diagnosis Procedure"](#).

Diagnosis Procedure

INFOID:000000003756988

1. CHECK OPTICAL SENSOR POWER SUPPLY INPUT

1. Turn the ignition switch ON.
2. Turn the lighting switch AUTO.
3. Check the voltage between the optical sensor harness connector and the ground.

Terminals			
(+)	(-)		
Optical sensor		Ground	Voltage (Approx.)
Connector	Terminal		
M94	1		
			5 V

Is the measurement value normal?

- YES >> GO TO 2.
 NO >> GO TO 4.

2. CHECK OPTICAL SENSOR GROUND INPUT

Check the voltage between the optical sensor harness connector and the ground.

Terminals			
(+)	(-)		
Optical sensor		Ground	Voltage (Approx.)
Connector	Terminal		
M94	3		
			0 V

Is the measurement value normal?

- YES >> GO TO 3.
 NO >> GO TO 6.

OPTICAL SENSOR

[HALOGEN TYPE]

< COMPONENT DIAGNOSIS >

3. CHECK OPTICAL SENSOR SIGNAL OUTPUT

With illuminating the optical sensor, check the voltage between the optical sensor harness connector and the ground.

Terminals		Condition	Voltage (Approx.)
(+)	(-)		
Optical sensor		Optical sensor	
Connector	Terminal		
M94	2	Ground	
		When illuminating	3.1 V or more *
		When shutting off light	0.6 V or less

*: Illuminate the optical sensor. The value may be less than the standard if brightness is weak.

Is the measurement value normal?

YES >> GO TO 7.

NO >> Replace the optical sensor.

4. CHECK OPTICAL SENSOR OPEN CIRCUIT

1. Turn the ignition switch OFF.
2. Disconnect the optical sensor connector and BCM connector.
3. Check continuity between the optical sensor harness connector and the BCM harness connector.

Optical sensor		BCM		Continuity
Connector	Terminal	Connector	Terminal	
M94	1	M123	138	Existed

Does continuity exist?

YES >> GO TO 5.

NO >> Repair the harnesses or connectors.

5. CHECK OPTICAL SENSOR SHORT CIRCUIT

Check the continuity between the optical sensor harness connector and the ground.

Optical sensor		Ground	Continuity
Connector	Terminal		
M94	1		Not existed

Does continuity exist?

YES >> Repair the harnesses or connectors.

NO >> Replace BCM.

6. CHECK OPTICAL SENSOR GROUND OPEN CIRCUIT

1. Turn the ignition switch OFF.
2. Disconnect the optical sensor connector and BCM connector.
3. Check continuity between the optical sensor harness connector and the BCM harness connector.

Optical sensor		BCM		Continuity
Connector	Terminal	Connector	Terminal	
M94	3	M123	137	Existed

Does continuity exist?

YES >> Replace BCM.

NO >> Repair the harnesses or connectors.

7. CHECK OPTICAL SENSOR SIGNAL OPEN CIRCUIT

A
B
C
D
E
F
G
H
I
J
K
EXL
M
N
O
P

OPTICAL SENSOR

[HALOGEN TYPE]

< COMPONENT DIAGNOSIS >

1. Turn the ignition switch OFF.
2. Disconnect the optical sensor connector and BCM connector.
3. Check continuity between the optical sensor harness connector and the BCM harness connector.

Optical sensor		BCM		Continuity
Connector	Terminal	Connector	Terminal	
M94	2	M123	113	Existed

Does continuity exist?

YES >> GO TO 8.

NO >> Repair the harnesses or connectors.

8.CHECK OPTICAL SENSOR SHORT CIRCUIT

Check the continuity between the optical sensor harness connector and the ground.

Optical sensor		Ground	Continuity
Connector	Terminal		
M94	2		Not existed

Does continuity exist?

YES >> Repair the harnesses or connectors.

NO >> Replace BCM.

HAZARD SWITCH

< COMPONENT DIAGNOSIS >

[HALOGEN TYPE]

HAZARD SWITCH

Description

INFOID:000000003756989

Hazard switch is integrated in the multifunction switch. Hazard switch inputs the signals to BCM when pressing the switch.

Component Function Check

INFOID:000000003756990

1.CHECK HAZARD SWITCH SIGNAL BY CONSULT-III

CONSULT-III DATA MONITOR

1. Turn the ignition switch ON.
2. Select "HAZARD SW" of BCM (FLASHER) data monitor item.
3. With operating the hazard switch, check the monitor status.

Monitor item	Condition		Monitor status
HAZARD SW	Hazard switch	While pressing the switch	On
		While not pressing the switch	Off

Is the item status normal?

- YES >> Hazard switch circuit is normal.
 NO >> Refer to [EXL-255, "Diagnosis Procedure"](#).

Diagnosis Procedure

INFOID:000000003756991

1.CHECK HAZARD SWITCH SIGNAL INPUT

With operating the hazard switch, check the voltage between the BCM harness connector and the ground.

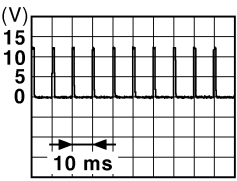
Terminals		Condition	Voltage (Approx.)
(+)	(-)		
BCM		Hazard switch	0 V
Connector	Terminal		
M122	110	While pressing the switch	
		While not pressing the switch	
	Ground		

JPMIA0012GB

Is the measurement value normal?

- YES >> Replace BCM.
 NO >> GO TO 2.

2.CHECK HAZARD SWITCH SIGNAL OPEN CIRCUIT

1. Turn the ignition switch OFF.
2. Disconnect the multifunction switch connector and BCM connector.
3. Check continuity between the multifunction switch harness connector and the BCM harness connector.

HAZARD SWITCH

[HALOGEN TYPE]

< COMPONENT DIAGNOSIS >

Multifunction switch		BCM		Continuity
Connector	Terminal	Connector	Terminal	
M72	16	M122	110	Existed

Does continuity exist?

YES >> GO TO 3.

NO >> Repair the harnesses or connectors.

3.CHECK HAZARD SWITCH SIGNAL SHORT CIRCUIT

Check continuity between the multifunction switch harness connector and the ground.

Multifunction switch		Ground	Continuity
Connector	Terminal		
M72	16		Not existed

Does continuity exist?

YES >> Repair the harnesses or connectors.

NO >> GO TO 4.

4.CHECK HAZARD SWITCH GROUND OPEN CIRCUIT

Check continuity between the multifunction switch harness connector and the ground.

Multifunction switch		Ground	Continuity
Connector	Terminal		
M72	1		Existed

Does continuity exist?

YES >> Replace the hazard switch (multifunction switch).

NO >> Repair the harnesses or connectors.

TAIL LAMP CIRCUIT

[HALOGEN TYPE]

< COMPONENT DIAGNOSIS >

TAIL LAMP CIRCUIT

Component Function Check

INFOID:000000003756992

1. CHECK TAIL LAMP OPERATION

IPDM E/R AUTO ACTIVE TEST

1. Activate IPDM E/R auto active test. Refer to [EXL-37, "Diagnosis Description"](#).
2. Check that the tail lamp is turned ON.

CONSULT-III ACTIVE TEST

1. Select "EXTERNAL LAMPS" of IPDM E/R active test item.
2. With operating the test items, check that the tail lamp is turned ON.

TAIL : Tail lamp ON

Off : Tail lamp OFF

Is the tail lamp turned ON?

YES >> Tail lamp circuit is normal.

NO >> Refer to [EXL-257, "Diagnosis Procedure"](#).

Diagnosis Procedure

INFOID:000000003756993

1. CHECK TAIL LAMP FUSE

1. Turn the ignition switch OFF.
2. Check that the following fuses are not fusing.

Unit	Location	Fuse No.	Capacity
<ul style="list-style-type: none"> • Tail lamp • Rear side marker lamp • License plate lamp 	IPDM E/R	#53	10 A

Is the fuse fusing?

YES >> Repair the malfunctioning part before replacing the fuse.

NO >> GO TO 2.

2. CHECK TAIL LAMP OUTPUT VOLTAGE

CONSULT-III ACTIVE TEST

1. Disconnect the rear combination lamp connector.
2. Turn the ignition switch ON.
3. Select "EXTERNAL LAMPS" of IPDM E/R active test item.
4. With operating the test items, check the voltage between the IPDM E/R harness connector and the ground.

Terminals		Test item	Voltage (Approx.)
(+)	(-)		
IPDM E/R		EXTERNAL LAMP	Battery voltage
Connector	Terminal		
E5	7	TAIL	
		Off	0 V

Is the measurement value normal?

YES >> GO TO 3.

NO >> Replace IPDM E/R.

3. CHECK TAIL LAMP OPEN CIRCUIT

1. Turn the ignition switch OFF.
2. Disconnect IPDM E/R connector.

A
B
C
D
E
F
G
H
I
J
K
M
N
O
P

EXL

TAIL LAMP CIRCUIT

[HALOGEN TYPE]

< COMPONENT DIAGNOSIS >

3. Check continuity between the IPDM E/R harness connector and the rear combination lamp harness connector.

IPDM E/R		Rear combination lamp		Continuity	
Connector	Terminal	Connector	Terminal		
RH	E5	7	B232	1	Existed
LH			B60	1	

Does continuity exist?

YES >> GO TO 4.

NO >> Repair the harnesses or connectors.

4. CHECK TAIL LAMP GROUND OPEN CIRCUIT

Check continuity between the rear combination lamp harness connector and the ground.

Rear combination lamp			Ground	Continuity
Connector	Terminal			
RH	B232	4		Existed
LH	B60	4		

Does continuity exist?

YES >> Replace the rear combination lamp.

NO >> Repair the harnesses or connectors.

LICENSE PLATE LAMP CIRCUIT

< COMPONENT DIAGNOSIS >

[HALOGEN TYPE]

LICENSE PLATE LAMP CIRCUIT

Component Function Check

INFOID:000000003756994

NOTE:

Check the tail lamp circuit if the tail lamp and the license plate lamp are not turned ON.

1.CHECK LICENSE PLATE LAMP OPERATION

IPDM E/R AUTO ACTIVE TEST

1. Activate IPDM E/R auto active test. Refer to [EXL-37, "Diagnosis Description"](#).
2. Check that the license plate lamp is turned ON.

CONSULT-III ACTIVE TEST

1. Select "EXTERNAL LAMPS" of IPDM E/R active test item.
2. With operating the lighting switch, check that the license plate lamp is turned ON.

TAIL : License plate lamp ON

Off : License plate lamp OFF

Is the license plate lamp turned ON?

YES >> License plate lamp circuit is normal.

NO >> Refer to [EXL-259, "Diagnosis Procedure"](#).

Diagnosis Procedure

INFOID:000000003756995

1.CHECK LICENSE PLATE LAMP BULB

Check the applicable lamp bulb.

Is the bulb normal?

YES >> GO TO 2.

NO >> Replace the bulb.

2.CHECK LICENSE PLATE LAMP OPEN CIRCUIT

1. Turn the ignition switch OFF.
2. Disconnect IPDM E/R connector and the license plate lamp connector.
3. Check continuity between the IPDM E/R harness connector and the license plate lamp harness connector.

IPDM E/R		License plate lamp		Continuity
Connector	Terminal	Connector	Terminal	
RH	E5	7	D117	Existed
LH			D112	

Does continuity exist?

YES >> GO TO 3.

NO >> Repair the harnesses or connectors.

3.CHECK LICENSE PLATE LAMP GROUND OPEN CIRCUIT

Check continuity between the license plate lamp harness connector and the ground.

License plate lamp			Ground	Continuity
Connector	Terminal			
RH	D117	2	Existed	
LH	D112	2		

Does continuity exist?

YES >> Replace the license plate lamp.

NO >> Repair the harnesses or connectors.

HEADLAMP SYSTEM

[HALOGEN TYPE]

< COMPONENT DIAGNOSIS >

HEADLAMP SYSTEM

Wiring Diagram - HEADLAMP -

INFOID:000000003534027

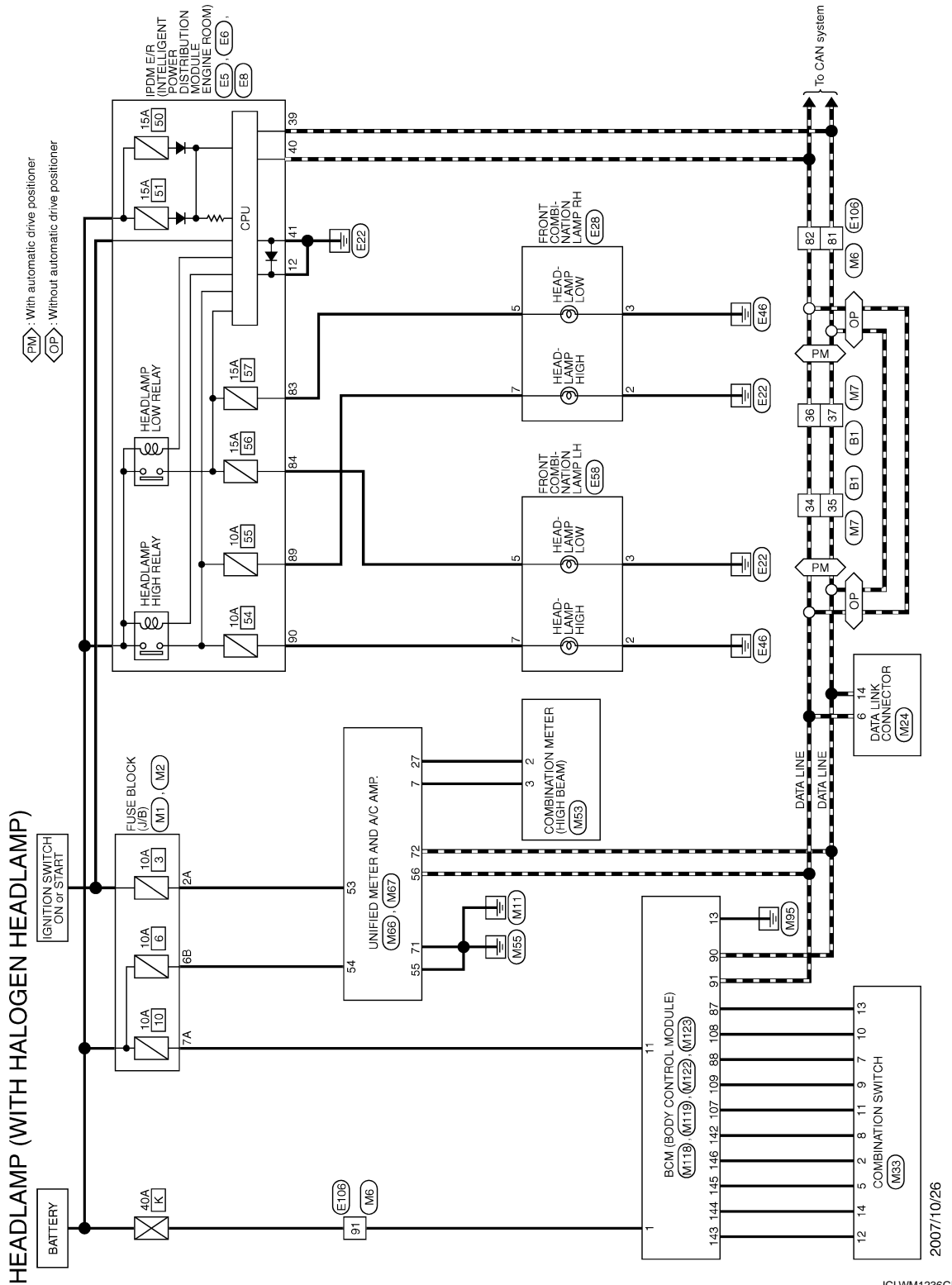





HEADLAMP SYSTEM

< COMPONENT DIAGNOSIS >

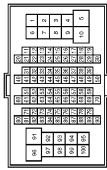
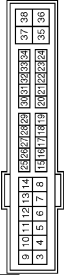
[HALOGEN TYPE]

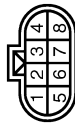
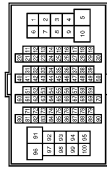
HEADLAMP (WITH HALOGEN HEADLAMP)

<p>Connector No. B1 Connector Name WIRE TO WIRE Connector Type TH80FW-CS16-TM4</p>  <p>H.S.</p>	<p>Connector No. E5 Connector Name IPDM E/R (INTELLIGENT POWER DISTRIBUTION MODULE ENGINE ROOM) Connector Type TH2DFW-CS12-M4-1V</p>  <p>H.S.</p>	<p>Connector No. E6 Connector Name IPDM E/R (INTELLIGENT POWER DISTRIBUTION MODULE ENGINE ROOM) Connector Type TH80FW-NH</p>  <p>H.S.</p>	<p>Connector No. E8 Connector Name FRONT COMBINATION LAMP LH Connector Type RS08FB-PR</p>  <p>H.S.</p>	<p>Connector No. E106 Connector Name WIRE TO WIRE Connector Type TH80FW-CS16-TM4</p>  <p>H.S.</p>	<p>Connector No. M1 Connector Name FUSE BLOK (J/B) Connector Type NS09FW-M2</p>  <p>H.S.</p>
<p>Terminal No. 34 Color of Wire L Signal Name [Specification] -</p> <p>Terminal No. 35 Color of Wire P Signal Name [Specification] -</p> <p>Terminal No. 36 Color of Wire L Signal Name [Specification] -</p> <p>Terminal No. 37 Color of Wire P Signal Name [Specification] -</p>	<p>Terminal No. 9 Color of Wire B/W Signal Name [Specification] -</p> <p>Terminal No. 10 Color of Wire B/W Signal Name [Specification] -</p> <p>Terminal No. 11 Color of Wire B/W Signal Name [Specification] -</p> <p>Terminal No. 12 Color of Wire B/W Signal Name [Specification] -</p> <p>Terminal No. 13 Color of Wire B/W Signal Name [Specification] -</p> <p>Terminal No. 14 Color of Wire B/W Signal Name [Specification] -</p> <p>Terminal No. 15 Color of Wire B/W Signal Name [Specification] -</p> <p>Terminal No. 16 Color of Wire B/W Signal Name [Specification] -</p>	<p>Terminal No. 83 Color of Wire O Signal Name [Specification] -</p> <p>Terminal No. 84 Color of Wire V Signal Name [Specification] -</p> <p>Terminal No. 89 Color of Wire BR Signal Name [Specification] -</p> <p>Terminal No. 90 Color of Wire P Signal Name [Specification] -</p>	<p>Terminal No. 1 Color of Wire B/W Signal Name [Specification] -</p> <p>Terminal No. 2 Color of Wire B Signal Name [Specification] -</p> <p>Terminal No. 3 Color of Wire B/Y Signal Name [Specification] -</p> <p>Terminal No. 5 Color of Wire V Signal Name [Specification] -</p> <p>Terminal No. 7 Color of Wire P Signal Name [Specification] -</p>	<p>Terminal No. 81 Color of Wire P Signal Name [Specification] -</p> <p>Terminal No. 82 Color of Wire L Signal Name [Specification] -</p> <p>Terminal No. 91 Color of Wire W Signal Name [Specification] -</p>	<p>Terminal No. 2A Color of Wire G Signal Name [Specification] -</p> <p>Terminal No. 7A Color of Wire R Signal Name [Specification] -</p>

A
B
C
D
E
F
G
H
I
J
K
EXL
M
N
O
P

HEADLAMP SYSTEM

< COMPONENT DIAGNOSIS >

[HALOGEN TYPE]

HEADLAMP (WITH HALOGEN HEADLAMP)

Connector No. M2	FUSE BLOCK (J/B)	Connector Name NS10FW-CS	Terminal No. 6B	Color of Wire Y	Signal Name [Specification]		
Connector No. M24	DATA LINK CONNECTOR	Connector Name BD16FW	Terminal No. 6	Color of Wire L	Signal Name [Specification]		
Connector No. M6	WIRE TO WIRE	TH6GMW-CS16-TM4	Terminal No. 81	Color of Wire P	Signal Name [Specification]		
Connector No. M7	WIRE TO WIRE	TH62MW-CS16-TM4	Terminal No. 34	Color of Wire L	Signal Name [Specification]		
Connector No. M33	COMBINATION SWITCH	TH16FW-NH	Terminal No. 7	Color of Wire GR	Signal Name [Specification]		
Connector No. M53	COMBINATION METER	TH40FW-NH	Terminal No. 2	Color of Wire LG	Signal Name [Specification]		
Connector No. M66	UNIFIED METER AND A/C AMP.	TH40FW-NH	Terminal No. 7	Color of Wire GR	Signal Name [Specification]		
Connector No. M67	UNIFIED METER AND A/C AMP.	TH43ZFW-NH	Terminal No. 53	Color of Wire G	Signal Name [Specification]		

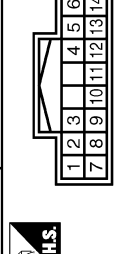
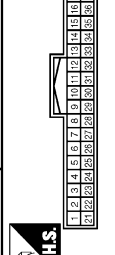
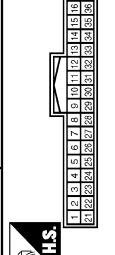
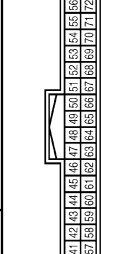
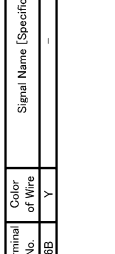
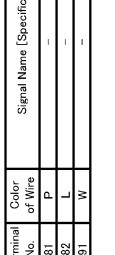
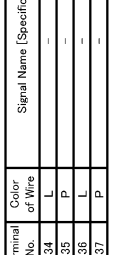
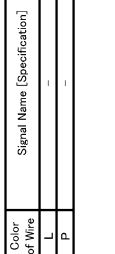
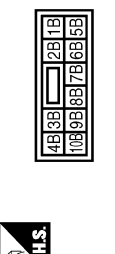
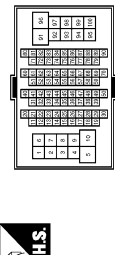
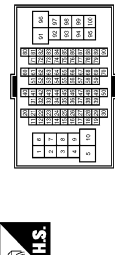
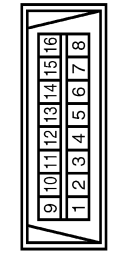

Terminal No.	Color of Wire	Signal Name [Specification]
53	G	IGN
54	Y	BAT
55	B	GND
56	L	CAN-H
71	B	GND
72	P	CAN-L

Terminal No.	Color of Wire	Signal Name [Specification]
27	LG	COMM (METER->AMP.)
7	GR	COMM (AMP->METER)

Terminal No.	Color of Wire	Signal Name [Specification]
3	GR	COMM (AMP->METER)
2	LG	COMM (METER->AMP.)

Terminal No.	Color of Wire	Signal Name [Specification]
2	SB	OUTPUT 4
5	L	OUTPUT 3
7	V	INPUT 3
8	O	OUTPUT 5
9	Y	INPUT 2
10	R	INPUT 4
11	LG	INPUT 1
12	P	OUTPUT 1
13	BR	INPUT 5
14	G	OUTPUT 2

HEADLAMP SYSTEM

< COMPONENT DIAGNOSIS >

[HALOGEN TYPE]

HEADLAMP (WITH HALOGEN HEADLAMP)

Connector No.	M123
Connector Name	BCM (BODY CONTROL MODULE)
Connector Type	TH40FG-NH



Terminal No.	Color of Wire	Signal Name [Specification]
142	O	COMBI SW OUTPUT 5
143	P	COMBI SW OUTPUT 1
144	G	COMBI SW OUTPUT 2
145	L	COMBI SW OUTPUT 3
146	SB	COMBI SW OUTPUT 4

Connector No.	M122
Connector Name	BCM (BODY CONTROL MODULE)
Connector Type	TH40FB-NH



Terminal No.	Color of Wire	Signal Name [Specification]
87	BR	COMBI SW INPUT 5
88	V	COMBI SW INPUT 3
90	P	CAN-L
91	L	CAN-H
107	LG	COMBI SW INPUT 1
108	R	COMBI SW INPUT 4
109	Y	COMBI SW INPUT 2

Connector No.	M119
Connector Name	BCM (BODY CONTROL MODULE)
Connector Type	NS10FT-CS



Terminal No.	Color of Wire	Signal Name [Specification]
11	R	BAT (FUSE)
13	B	GND

Connector No.	M118
Connector Name	BCM (BODY CONTROL MODULE)
Connector Type	MD0EP-LC



Terminal No.	Color of Wire	Signal Name [Specification]
1	W	BAT (F/L)

A
B
C
D
E
F
G
H
I
J
K
EXL
M
N
O
P

JCLWM1239GE

AUTO LIGHT SYSTEM

< COMPONENT DIAGNOSIS >

[HALOGEN TYPE]

AUTO LIGHT SYSTEM

Wiring Diagram - AUTO LIGHT SYSTEM -

INFOID:000000003534028

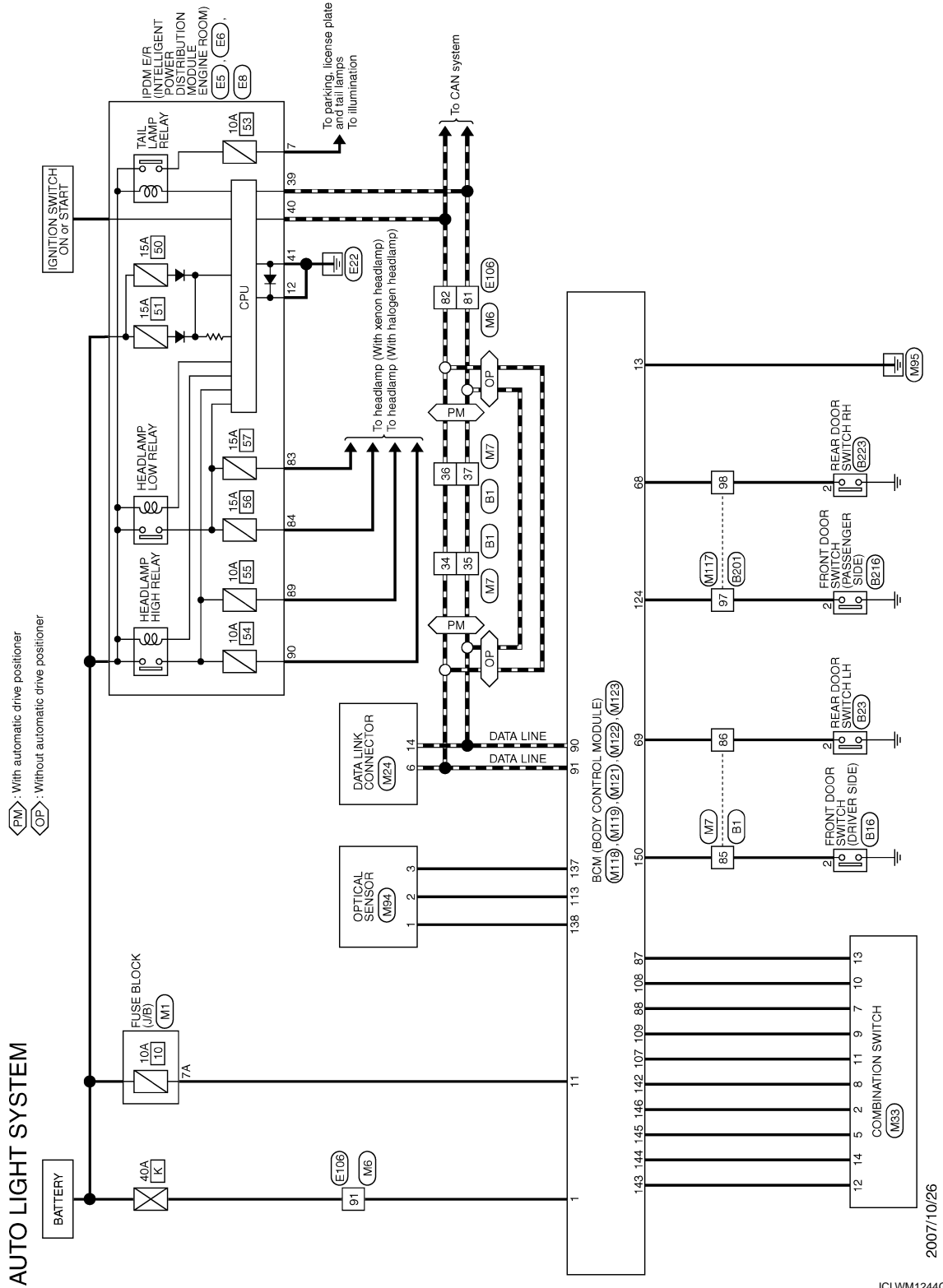

2007/10/26



JCLWM1244GE

AUTO LIGHT SYSTEM

< COMPONENT DIAGNOSIS >

[HALOGEN TYPE]

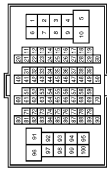
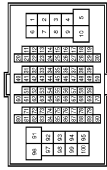
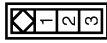
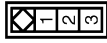
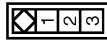
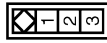
AUTO LIGHT SYSTEM

<table border="1" style="width: 100%; border-collapse: collapse;"> <tr><td>Connector No.</td><td>B1</td></tr> <tr><td>Connector Name</td><td>WIRE TO WIRE</td></tr> <tr><td>Connector Type</td><td>TH80FW-CS16-TM4</td></tr> </table>  <p style="text-align: center;">H.S.</p>	Connector No.	B1	Connector Name	WIRE TO WIRE	Connector Type	TH80FW-CS16-TM4	<table border="1" style="width: 100%; border-collapse: collapse;"> <tr><td>Terminal No.</td><td>Color of Wire</td><td>Signal Name [Specification]</td></tr> <tr><td>34</td><td>L</td><td>-</td></tr> <tr><td>35</td><td>P</td><td>-</td></tr> <tr><td>36</td><td>L</td><td>-</td></tr> <tr><td>37</td><td>P</td><td>-</td></tr> <tr><td>85</td><td>V</td><td>-</td></tr> <tr><td>88</td><td>LG</td><td>-</td></tr> </table>	Terminal No.	Color of Wire	Signal Name [Specification]	34	L	-	35	P	-	36	L	-	37	P	-	85	V	-	88	LG	-	<table border="1" style="width: 100%; border-collapse: collapse;"> <tr><td>Connector No.</td><td>B201</td></tr> <tr><td>Connector Name</td><td>WIRE TO WIRE</td></tr> <tr><td>Connector Type</td><td>TH80FW-CS16-TM4</td></tr> </table>  <p style="text-align: center;">H.S.</p>	Connector No.	B201	Connector Name	WIRE TO WIRE	Connector Type	TH80FW-CS16-TM4	<table border="1" style="width: 100%; border-collapse: collapse;"> <tr><td>Terminal No.</td><td>Color of Wire</td><td>Signal Name [Specification]</td></tr> <tr><td>97</td><td>GR</td><td>-</td></tr> <tr><td>98</td><td>BR</td><td>-</td></tr> </table>	Terminal No.	Color of Wire	Signal Name [Specification]	97	GR	-	98	BR	-
Connector No.	B1																																												
Connector Name	WIRE TO WIRE																																												
Connector Type	TH80FW-CS16-TM4																																												
Terminal No.	Color of Wire	Signal Name [Specification]																																											
34	L	-																																											
35	P	-																																											
36	L	-																																											
37	P	-																																											
85	V	-																																											
88	LG	-																																											
Connector No.	B201																																												
Connector Name	WIRE TO WIRE																																												
Connector Type	TH80FW-CS16-TM4																																												
Terminal No.	Color of Wire	Signal Name [Specification]																																											
97	GR	-																																											
98	BR	-																																											
<table border="1" style="width: 100%; border-collapse: collapse;"> <tr><td>Connector No.</td><td>B16</td></tr> <tr><td>Connector Name</td><td>FRONT DOOR SWITCH (DRIVER SIDE)</td></tr> <tr><td>Connector Type</td><td>A03FW</td></tr> </table>  <p style="text-align: center;">H.S.</p>	Connector No.	B16	Connector Name	FRONT DOOR SWITCH (DRIVER SIDE)	Connector Type	A03FW	<table border="1" style="width: 100%; border-collapse: collapse;"> <tr><td>Terminal No.</td><td>Color of Wire</td><td>Signal Name [Specification]</td></tr> <tr><td>2</td><td>V</td><td>-</td></tr> </table>	Terminal No.	Color of Wire	Signal Name [Specification]	2	V	-	<table border="1" style="width: 100%; border-collapse: collapse;"> <tr><td>Connector No.</td><td>B23</td></tr> <tr><td>Connector Name</td><td>REAR DOOR SWITCH LH</td></tr> <tr><td>Connector Type</td><td>A03FW</td></tr> </table>  <p style="text-align: center;">H.S.</p>	Connector No.	B23	Connector Name	REAR DOOR SWITCH LH	Connector Type	A03FW	<table border="1" style="width: 100%; border-collapse: collapse;"> <tr><td>Terminal No.</td><td>Color of Wire</td><td>Signal Name [Specification]</td></tr> <tr><td>2</td><td>LG</td><td>-</td></tr> </table>	Terminal No.	Color of Wire	Signal Name [Specification]	2	LG	-																		
Connector No.	B16																																												
Connector Name	FRONT DOOR SWITCH (DRIVER SIDE)																																												
Connector Type	A03FW																																												
Terminal No.	Color of Wire	Signal Name [Specification]																																											
2	V	-																																											
Connector No.	B23																																												
Connector Name	REAR DOOR SWITCH LH																																												
Connector Type	A03FW																																												
Terminal No.	Color of Wire	Signal Name [Specification]																																											
2	LG	-																																											
<table border="1" style="width: 100%; border-collapse: collapse;"> <tr><td>Connector No.</td><td>B218</td></tr> <tr><td>Connector Name</td><td>FRONT DOOR SWITCH (PASSENGER SIDE)</td></tr> <tr><td>Connector Type</td><td>A03FW</td></tr> </table>  <p style="text-align: center;">H.S.</p>	Connector No.	B218	Connector Name	FRONT DOOR SWITCH (PASSENGER SIDE)	Connector Type	A03FW	<table border="1" style="width: 100%; border-collapse: collapse;"> <tr><td>Terminal No.</td><td>Color of Wire</td><td>Signal Name [Specification]</td></tr> <tr><td>2</td><td>GR</td><td>-</td></tr> </table>	Terminal No.	Color of Wire	Signal Name [Specification]	2	GR	-	<table border="1" style="width: 100%; border-collapse: collapse;"> <tr><td>Connector No.</td><td>B23</td></tr> <tr><td>Connector Name</td><td>REAR DOOR SWITCH RH</td></tr> <tr><td>Connector Type</td><td>A03FW</td></tr> </table>  <p style="text-align: center;">H.S.</p>	Connector No.	B23	Connector Name	REAR DOOR SWITCH RH	Connector Type	A03FW	<table border="1" style="width: 100%; border-collapse: collapse;"> <tr><td>Terminal No.</td><td>Color of Wire</td><td>Signal Name [Specification]</td></tr> <tr><td>2</td><td>BR</td><td>-</td></tr> </table>	Terminal No.	Color of Wire	Signal Name [Specification]	2	BR	-																		
Connector No.	B218																																												
Connector Name	FRONT DOOR SWITCH (PASSENGER SIDE)																																												
Connector Type	A03FW																																												
Terminal No.	Color of Wire	Signal Name [Specification]																																											
2	GR	-																																											
Connector No.	B23																																												
Connector Name	REAR DOOR SWITCH RH																																												
Connector Type	A03FW																																												
Terminal No.	Color of Wire	Signal Name [Specification]																																											
2	BR	-																																											
<table border="1" style="width: 100%; border-collapse: collapse;"> <tr><td>Connector No.</td><td>E5</td></tr> <tr><td>Connector Name</td><td>IPDM E/R (INTELLIGENT POWER DISTRIBUTION MODULE ENGINE ROOM)</td></tr> <tr><td>Connector Type</td><td>TH20FW-CS12-M4-IV</td></tr> </table>  <p style="text-align: center;">H.S.</p>	Connector No.	E5	Connector Name	IPDM E/R (INTELLIGENT POWER DISTRIBUTION MODULE ENGINE ROOM)	Connector Type	TH20FW-CS12-M4-IV	<table border="1" style="width: 100%; border-collapse: collapse;"> <tr><td>Terminal No.</td><td>Color of Wire</td><td>Signal Name [Specification]</td></tr> <tr><td>7</td><td>R</td><td>-</td></tr> <tr><td>12</td><td>B/W</td><td>-</td></tr> </table>	Terminal No.	Color of Wire	Signal Name [Specification]	7	R	-	12	B/W	-	<table border="1" style="width: 100%; border-collapse: collapse;"> <tr><td>Connector No.</td><td>E6</td></tr> <tr><td>Connector Name</td><td>IPDM E/R (INTELLIGENT POWER DISTRIBUTION MODULE ENGINE ROOM)</td></tr> <tr><td>Connector Type</td><td>TH80FW-NH</td></tr> </table>  <p style="text-align: center;">H.S.</p>	Connector No.	E6	Connector Name	IPDM E/R (INTELLIGENT POWER DISTRIBUTION MODULE ENGINE ROOM)	Connector Type	TH80FW-NH	<table border="1" style="width: 100%; border-collapse: collapse;"> <tr><td>Terminal No.</td><td>Color of Wire</td><td>Signal Name [Specification]</td></tr> <tr><td>39</td><td>P</td><td>-</td></tr> <tr><td>40</td><td>L</td><td>-</td></tr> <tr><td>41</td><td>B/W</td><td>-</td></tr> </table>	Terminal No.	Color of Wire	Signal Name [Specification]	39	P	-	40	L	-	41	B/W	-									
Connector No.	E5																																												
Connector Name	IPDM E/R (INTELLIGENT POWER DISTRIBUTION MODULE ENGINE ROOM)																																												
Connector Type	TH20FW-CS12-M4-IV																																												
Terminal No.	Color of Wire	Signal Name [Specification]																																											
7	R	-																																											
12	B/W	-																																											
Connector No.	E6																																												
Connector Name	IPDM E/R (INTELLIGENT POWER DISTRIBUTION MODULE ENGINE ROOM)																																												
Connector Type	TH80FW-NH																																												
Terminal No.	Color of Wire	Signal Name [Specification]																																											
39	P	-																																											
40	L	-																																											
41	B/W	-																																											

A
B
C
D
E
F
G
H
I
J
K
EXL
M
N
O
P

JCLWM1245GE

AUTO LIGHT SYSTEM

< COMPONENT DIAGNOSIS >

[HALOGEN TYPE]

AUTO LIGHT SYSTEM

Connector No.	EB
Connector Name	IPDM E/R (INTELLIGENT POWER DISTRIBUTION MODULE ENGINE ROOM)
Connector Type	NSDBFW-CS

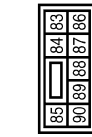

Terminal No.	Color of Wire	Signal Name [Specification]
83	O	-
84	V	-
86	BR	-
89	P	-

Connector No.	E106
Connector Name	WIRE TO WIRE
Connector Type	TH80FW-CS16-TM4

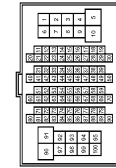

Terminal No.	Color of Wire	Signal Name [Specification]
81	P	-
82	L	-
91	W	-

Connector No.	M1
Connector Name	FUSE BLOCK (J/B)
Connector Type	NSDBFW-M2

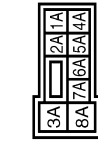

Terminal No.	Color of Wire	Signal Name [Specification]
7A	R	-

Connector No.	M6
Connector Name	WIRE TO WIRE
Connector Type	TH80MW-CS16-TM4

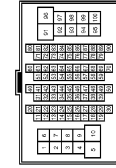

Terminal No.	Color of Wire	Signal Name [Specification]
81	P	-
82	L	-
91	W	-

Connector No.	M7
Connector Name	WIRE TO WIRE
Connector Type	TH80MW-CS16-TM4



Terminal No.	Color of Wire	Signal Name [Specification]
34	L	-
35	P	-
36	L	-
37	P	-
85	LG	-
86	R	-

Connector No.	M24
Connector Name	DATA LINK CONNECTOR
Connector Type	BD16FW

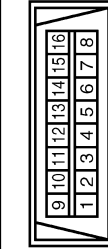

Terminal No.	Color of Wire	Signal Name [Specification]
6	L	-
14	P	-

Connector No.	M33
Connector Name	COMBINATION SWITCH
Connector Type	TH16FW-NH

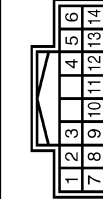

Terminal No.	Color of Wire	Signal Name [Specification]
2	SB	OUTPUT 4
5	L	OUTPUT 3
7	V	INPUT 3
8	O	OUTPUT 5
9	Y	INPUT 2
10	R	INPUT 4
11	LG	INPUT 1
12	P	OUTPUT 1
13	BR	INPUT 5
14	G	OUTPUT 2

Connector No.	M94
Connector Name	OPTICAL SENSOR
Connector Type	TK03FW



Terminal No.	Color of Wire	Signal Name [Specification]
1	Y	POWER
2	P	OUTPUT
3	B	GND

JCLWM1246GE

AUTO LIGHT SYSTEM

< COMPONENT DIAGNOSIS >

[HALOGEN TYPE]

AUTO LIGHT SYSTEM

Connector No.	M117	Connector No.	M118	Connector No.	M119	Connector No.	M121
Connector Name	WIRE TO WIRE	BCM (BODY CONTROL MODULE)	BCM (BODY CONTROL MODULE)	BCM (BODY CONTROL MODULE)	BCM (BODY CONTROL MODULE)	BCM (BODY CONTROL MODULE)	BCM (BODY CONTROL MODULE)
Connector Type	TH80MW-CS (F-TM4)	M03FB-LC	M03FB-CS	MS18FN-CS	TH40FGY-NH		

Terminal No.	97	Terminal No.	1	Terminal No.	11	Terminal No.	68
Color of Wire	LG	W		R	R	BR	BR
Signal Name [Specification]	-	BAT (F/L)			BAT (FUSE)		REAR RH DOOR SW
	98						REAR LH DOOR SW
Color of Wire	BR			B			R
Signal Name [Specification]	-				GND		

Terminal No.	87	Terminal No.	113	Terminal No.	124	Terminal No.	137
Color of Wire	BR	P	LG	O	Y	O	Y
Signal Name [Specification]	COMBI SW INPUT 5	OPTICAL SENSOR	PASSENGER DOOR SW	RECEIVER/SENSOR GND	RECEIVER/SENSOR POWER SUPPLY	COMBI SW OUTPUT 5	COMBI SW OUTPUT 1
	88		124		138		142
Color of Wire	V	LG	LG	O	Y	O	P
Signal Name [Specification]	COMBI SW INPUT 3	PASSENGER DOOR SW	RECEIVER/SENSOR GND	RECEIVER/SENSOR POWER SUPPLY	COMBI SW OUTPUT 5	COMBI SW OUTPUT 1	COMBI SW OUTPUT 2
	90		137		142		144
Color of Wire	P	O	O	Y	O	G	L
Signal Name [Specification]	CAN-L	RECEIVER/SENSOR GND	RECEIVER/SENSOR POWER SUPPLY	COMBI SW OUTPUT 5	COMBI SW OUTPUT 1	COMBI SW OUTPUT 2	COMBI SW OUTPUT 3
	91		138		142		145
Color of Wire	L	Y	O	Y	O	G	LG
Signal Name [Specification]	CAN-H	RECEIVER/SENSOR POWER SUPPLY	COMBI SW OUTPUT 5	COMBI SW OUTPUT 1	COMBI SW OUTPUT 2	COMBI SW OUTPUT 3	COMBI SW OUTPUT 4
	107		142		144		146
Color of Wire	LG	O	O	L	SS	SS	LG
Signal Name [Specification]	COMBI SW INPUT 4	COMBI SW OUTPUT 1	COMBI SW OUTPUT 2	COMBI SW OUTPUT 3	COMBI SW OUTPUT 4	DRIVER DOOR SW	
	108		143		146		150
Color of Wire	R	P	G	L	SS	SS	LG
Signal Name [Specification]	COMBI SW INPUT 4	COMBI SW OUTPUT 1	COMBI SW OUTPUT 2	COMBI SW OUTPUT 3	COMBI SW OUTPUT 4	DRIVER DOOR SW	
	109		144		146		150
Color of Wire	Y	G	L	SS	SS	SS	LG
Signal Name [Specification]	COMBI SW INPUT 2	COMBI SW OUTPUT 3	COMBI SW OUTPUT 4	DRIVER DOOR SW			

JCLWM1247GE

A B C D E F G H I J K M N O P

EXL

DAYTIME RUNNING LIGHT SYSTEM

< COMPONENT DIAGNOSIS >

[HALOGEN TYPE]

DAYTIME RUNNING LIGHT SYSTEM

Wiring Diagram - DAYTIME LIGHT SYSTEM -

INFOID:00000003534029

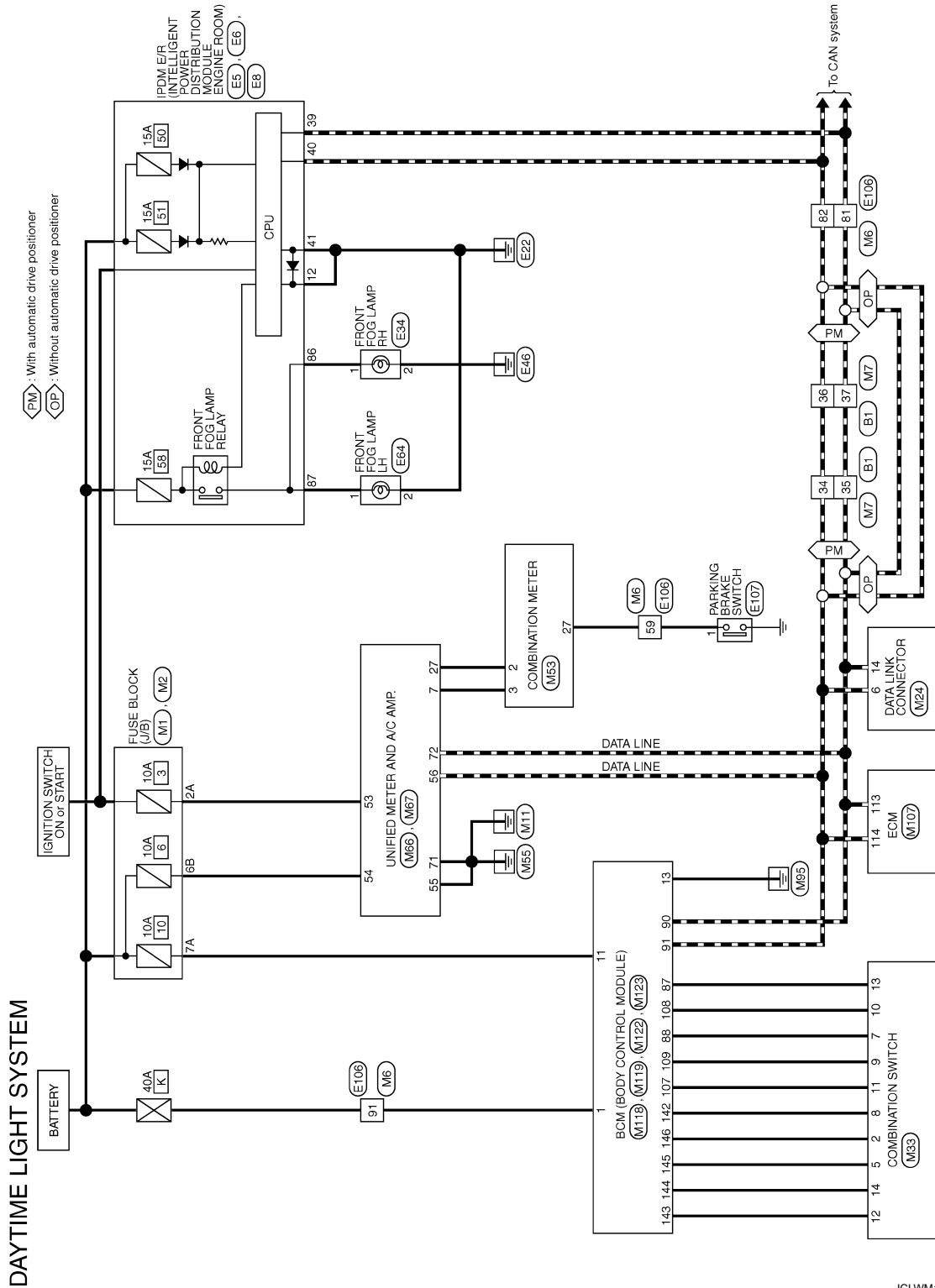











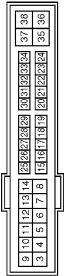

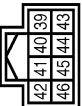

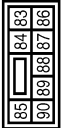
DAYTIME RUNNING LIGHT SYSTEM

< COMPONENT DIAGNOSIS >

[HALOGEN TYPE]

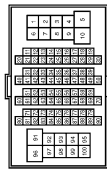
DAYTIME LIGHT SYSTEM

<table border="1"> <tr><td>Connector No.</td><td>B1</td></tr> <tr><td>Connector Name</td><td>WIRE TO WIRE</td></tr> <tr><td>Connector Type</td><td>TH80FW-CS16-TM4</td></tr> </table>   <table border="1"> <tr><td>Terminal No.</td><td>Color of Wire</td><td>Signal Name [Specification]</td></tr> <tr><td>34</td><td>L</td><td>-</td></tr> <tr><td>35</td><td>P</td><td>-</td></tr> <tr><td>36</td><td>L</td><td>-</td></tr> <tr><td>37</td><td>P</td><td>-</td></tr> </table>	Connector No.	B1	Connector Name	WIRE TO WIRE	Connector Type	TH80FW-CS16-TM4	Terminal No.	Color of Wire	Signal Name [Specification]	34	L	-	35	P	-	36	L	-	37	P	-	<table border="1"> <tr><td>Connector No.</td><td>E5</td></tr> <tr><td>Connector Name</td><td>IPDM E/R (INTELLIGENT POWER DISTRIBUTION MODULE ENGINE ROOM)</td></tr> <tr><td>Connector Type</td><td>TH20FW-CS12-M4-1V</td></tr> </table>   <table border="1"> <tr><td>Terminal No.</td><td>Color of Wire</td><td>Signal Name [Specification]</td></tr> <tr><td>12</td><td>B/W</td><td>-</td></tr> </table>	Connector No.	E5	Connector Name	IPDM E/R (INTELLIGENT POWER DISTRIBUTION MODULE ENGINE ROOM)	Connector Type	TH20FW-CS12-M4-1V	Terminal No.	Color of Wire	Signal Name [Specification]	12	B/W	-	<table border="1"> <tr><td>Connector No.</td><td>E6</td></tr> <tr><td>Connector Name</td><td>IPDM E/R (INTELLIGENT POWER DISTRIBUTION MODULE ENGINE ROOM)</td></tr> <tr><td>Connector Type</td><td>TH80FW-NH</td></tr> </table>   <table border="1"> <tr><td>Terminal No.</td><td>Color of Wire</td><td>Signal Name [Specification]</td></tr> <tr><td>39</td><td>P</td><td>-</td></tr> <tr><td>40</td><td>L</td><td>-</td></tr> <tr><td>41</td><td>B/W</td><td>-</td></tr> </table>	Connector No.	E6	Connector Name	IPDM E/R (INTELLIGENT POWER DISTRIBUTION MODULE ENGINE ROOM)	Connector Type	TH80FW-NH	Terminal No.	Color of Wire	Signal Name [Specification]	39	P	-	40	L	-	41	B/W	-	<table border="1"> <tr><td>Connector No.</td><td>E8</td></tr> <tr><td>Connector Name</td><td>IPDM E/R (INTELLIGENT POWER DISTRIBUTION MODULE ENGINE ROOM)</td></tr> <tr><td>Connector Type</td><td>NS30FW-CS</td></tr> </table>   <table border="1"> <tr><td>Terminal No.</td><td>Color of Wire</td><td>Signal Name [Specification]</td></tr> <tr><td>86</td><td>W</td><td>-</td></tr> <tr><td>87</td><td>L</td><td>-</td></tr> </table>	Connector No.	E8	Connector Name	IPDM E/R (INTELLIGENT POWER DISTRIBUTION MODULE ENGINE ROOM)	Connector Type	NS30FW-CS	Terminal No.	Color of Wire	Signal Name [Specification]	86	W	-	87	L	-
Connector No.	B1																																																																				
Connector Name	WIRE TO WIRE																																																																				
Connector Type	TH80FW-CS16-TM4																																																																				
Terminal No.	Color of Wire	Signal Name [Specification]																																																																			
34	L	-																																																																			
35	P	-																																																																			
36	L	-																																																																			
37	P	-																																																																			
Connector No.	E5																																																																				
Connector Name	IPDM E/R (INTELLIGENT POWER DISTRIBUTION MODULE ENGINE ROOM)																																																																				
Connector Type	TH20FW-CS12-M4-1V																																																																				
Terminal No.	Color of Wire	Signal Name [Specification]																																																																			
12	B/W	-																																																																			
Connector No.	E6																																																																				
Connector Name	IPDM E/R (INTELLIGENT POWER DISTRIBUTION MODULE ENGINE ROOM)																																																																				
Connector Type	TH80FW-NH																																																																				
Terminal No.	Color of Wire	Signal Name [Specification]																																																																			
39	P	-																																																																			
40	L	-																																																																			
41	B/W	-																																																																			
Connector No.	E8																																																																				
Connector Name	IPDM E/R (INTELLIGENT POWER DISTRIBUTION MODULE ENGINE ROOM)																																																																				
Connector Type	NS30FW-CS																																																																				
Terminal No.	Color of Wire	Signal Name [Specification]																																																																			
86	W	-																																																																			
87	L	-																																																																			
<table border="1"> <tr><td>Connector No.</td><td>E24</td></tr> <tr><td>Connector Name</td><td>FRONT FOG LAMP RH</td></tr> <tr><td>Connector Type</td><td>FCI.240P-C023S4019</td></tr> </table>   <table border="1"> <tr><td>Terminal No.</td><td>Color of Wire</td><td>Signal Name [Specification]</td></tr> <tr><td>1</td><td>W</td><td>-</td></tr> <tr><td>2</td><td>B/W</td><td>-</td></tr> </table>	Connector No.	E24	Connector Name	FRONT FOG LAMP RH	Connector Type	FCI.240P-C023S4019	Terminal No.	Color of Wire	Signal Name [Specification]	1	W	-	2	B/W	-	<table border="1"> <tr><td>Connector No.</td><td>E64</td></tr> <tr><td>Connector Name</td><td>FRONT FOG LAMP LH</td></tr> <tr><td>Connector Type</td><td>FCI.240P-C023S4019</td></tr> </table>   <table border="1"> <tr><td>Terminal No.</td><td>Color of Wire</td><td>Signal Name [Specification]</td></tr> <tr><td>1</td><td>L</td><td>-</td></tr> <tr><td>2</td><td>B/W</td><td>-</td></tr> </table>	Connector No.	E64	Connector Name	FRONT FOG LAMP LH	Connector Type	FCI.240P-C023S4019	Terminal No.	Color of Wire	Signal Name [Specification]	1	L	-	2	B/W	-	<table border="1"> <tr><td>Connector No.</td><td>E106</td></tr> <tr><td>Connector Name</td><td>WIRE TO WIRE</td></tr> <tr><td>Connector Type</td><td>TH80FW-CS16-TM4</td></tr> </table>   <table border="1"> <tr><td>Terminal No.</td><td>Color of Wire</td><td>Signal Name [Specification]</td></tr> <tr><td>59</td><td>O</td><td>-</td></tr> <tr><td>81</td><td>P</td><td>-</td></tr> <tr><td>82</td><td>L</td><td>-</td></tr> <tr><td>91</td><td>W</td><td>-</td></tr> </table>	Connector No.	E106	Connector Name	WIRE TO WIRE	Connector Type	TH80FW-CS16-TM4	Terminal No.	Color of Wire	Signal Name [Specification]	59	O	-	81	P	-	82	L	-	91	W	-	<table border="1"> <tr><td>Connector No.</td><td>E107</td></tr> <tr><td>Connector Name</td><td>PARKING BRAKE SWITCH</td></tr> <tr><td>Connector Type</td><td>TE801FW</td></tr> </table>   <table border="1"> <tr><td>Terminal No.</td><td>Color of Wire</td><td>Signal Name [Specification]</td></tr> <tr><td>1</td><td>O</td><td>-</td></tr> </table>	Connector No.	E107	Connector Name	PARKING BRAKE SWITCH	Connector Type	TE801FW	Terminal No.	Color of Wire	Signal Name [Specification]	1	O	-			
Connector No.	E24																																																																				
Connector Name	FRONT FOG LAMP RH																																																																				
Connector Type	FCI.240P-C023S4019																																																																				
Terminal No.	Color of Wire	Signal Name [Specification]																																																																			
1	W	-																																																																			
2	B/W	-																																																																			
Connector No.	E64																																																																				
Connector Name	FRONT FOG LAMP LH																																																																				
Connector Type	FCI.240P-C023S4019																																																																				
Terminal No.	Color of Wire	Signal Name [Specification]																																																																			
1	L	-																																																																			
2	B/W	-																																																																			
Connector No.	E106																																																																				
Connector Name	WIRE TO WIRE																																																																				
Connector Type	TH80FW-CS16-TM4																																																																				
Terminal No.	Color of Wire	Signal Name [Specification]																																																																			
59	O	-																																																																			
81	P	-																																																																			
82	L	-																																																																			
91	W	-																																																																			
Connector No.	E107																																																																				
Connector Name	PARKING BRAKE SWITCH																																																																				
Connector Type	TE801FW																																																																				
Terminal No.	Color of Wire	Signal Name [Specification]																																																																			
1	O	-																																																																			

A
B
C
D
E
F
G
H
I
J
K
EXL
M
N
O
P

DAYTIME RUNNING LIGHT SYSTEM

< COMPONENT DIAGNOSIS >

[HALOGEN TYPE]

DAYTIME LIGHT SYSTEM

Connector No.	M1
Connector Name	FUSE BLOCK (J/B)
Connector Type	NSDBFW-M2



Terminal No.	Color of Wire	Signal Name [Specification]
2A	G	-
7A	R	-

Connector No.	M2
Connector Name	FUSE BLOCK (J/B)
Connector Type	NS10FW-CS



Terminal No.	Color of Wire	Signal Name [Specification]
6B	Y	-

Connector No.	M6
Connector Name	WIRE TO WIRE
Connector Type	TH6DMW-CS16-TM4

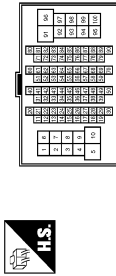

Terminal No.	Color of Wire	Signal Name [Specification]
59	V	-
81	P	-
82	L	-
91	W	-

Connector No.	M7
Connector Name	WIRE TO WIRE
Connector Type	TH8DMW-CS16-TM4

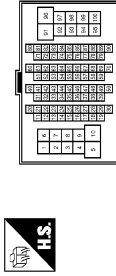

Terminal No.	Color of Wire	Signal Name [Specification]
34	L	-
35	P	-
36	L	-
37	P	-

Connector No.	M24
Connector Name	DATA LINK CONNECTOR
Connector Type	BD16FW

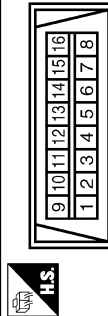

Terminal No.	Color of Wire	Signal Name [Specification]
6	L	-
14	P	-

Connector No.	M33
Connector Name	COMBINATION SWITCH
Connector Type	TH16FW-NH

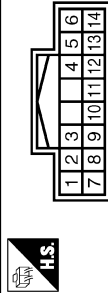

Terminal No.	Color of Wire	Signal Name [Specification]
2	SB	OUTPUT 4
5	L	OUTPUT 3
7	V	INPUT 3
8	O	OUTPUT 5
9	Y	INPUT 2
10	R	INPUT 4
11	LG	INPUT 1
12	P	OUTPUT 1
13	BR	INPUT 5
14	G	OUTPUT 2

Connector No.	M53
Connector Name	COMBINATION METER
Connector Type	TH40FW-NH

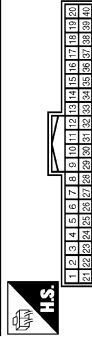

Terminal No.	Color of Wire	Signal Name [Specification]
2	LG	COMM (METER->AMP.)
3	GR	COMM (AMP->METER)
27	V	PARKING BRAKE SW

Connector No.	M66
Connector Name	UNIFIED METER AND A/C AMP.
Connector Type	TH40FW-NH

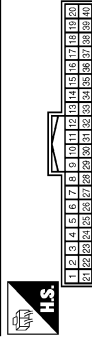

Terminal No.	Color of Wire	Signal Name [Specification]
7	GR	COMM (AMP->METER)
27	LG	COMM (METER->AMP.)

JCLWM1242GE

DAYTIME RUNNING LIGHT SYSTEM

< COMPONENT DIAGNOSIS >

[HALOGEN TYPE]

DAYTIME LIGHT SYSTEM

Connector No.	M67
Connector Name	UNIFIED METER AND A/C AMP.
Connector Type	TH27V-NH

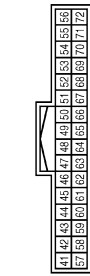

Terminal No.	Color of Wire	Signal Name [Specification]
53	G	IGN
54	Y	BAT
55	B	GND
56	L	CAN-H
71	B	GND
72	P	CAN-L

Connector No.	M107
Connector Name	ECM
Connector Type	RH2FCY-RZB-R-LH-Z

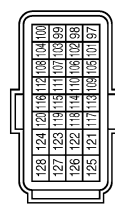

Terminal No.	Color of Wire	Signal Name [Specification]
113	P	VEHCAN-LI
114	L	VEHCAN-HI

Connector No.	M118
Connector Name	BCM (BODY CONTROL MODULE)
Connector Type	M03PF-LC



Terminal No.	Color of Wire	Signal Name [Specification]
1	W	BAT (F/L)

Connector No.	M119
Connector Name	BCM (BODY CONTROL MODULE)
Connector Type	NS38PW-CS



Terminal No.	Color of Wire	Signal Name [Specification]
11	R	BAT (FUSE)
13	B	GND

Connector No.	M122
Connector Name	BCM (BODY CONTROL MODULE)
Connector Type	TH40FB-NH

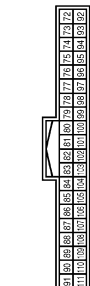

Terminal No.	Color of Wire	Signal Name [Specification]
87	BR	COMBI SW INPUT 5
88	V	COMBI SW INPUT 3
90	P	CAN-L
91	L	CAN-H
107	LG	COMBI SW INPUT 1
108	R	COMBI SW INPUT 4
109	Y	COMBI SW INPUT 2

Connector No.	M123
Connector Name	BCM (BODY CONTROL MODULE)
Connector Type	TH40FG-NH

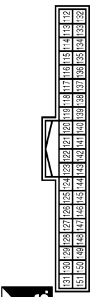

Terminal No.	Color of Wire	Signal Name [Specification]
142	O	COMBI SW OUTPUT 5
143	P	COMBI SW OUTPUT 1
144	G	COMBI SW OUTPUT 2
145	L	COMBI SW OUTPUT 3
146	SB	COMBI SW OUTPUT 4

A
B
C
D
E
F
G
H
I
J
K
L
M
N
O
P

EXL

FRONT FOG LAMP SYSTEM

< COMPONENT DIAGNOSIS >

[HALOGEN TYPE]

FRONT FOG LAMP SYSTEM

Wiring Diagram - FRONT FOG LAMP -

INFOID:000000003534030

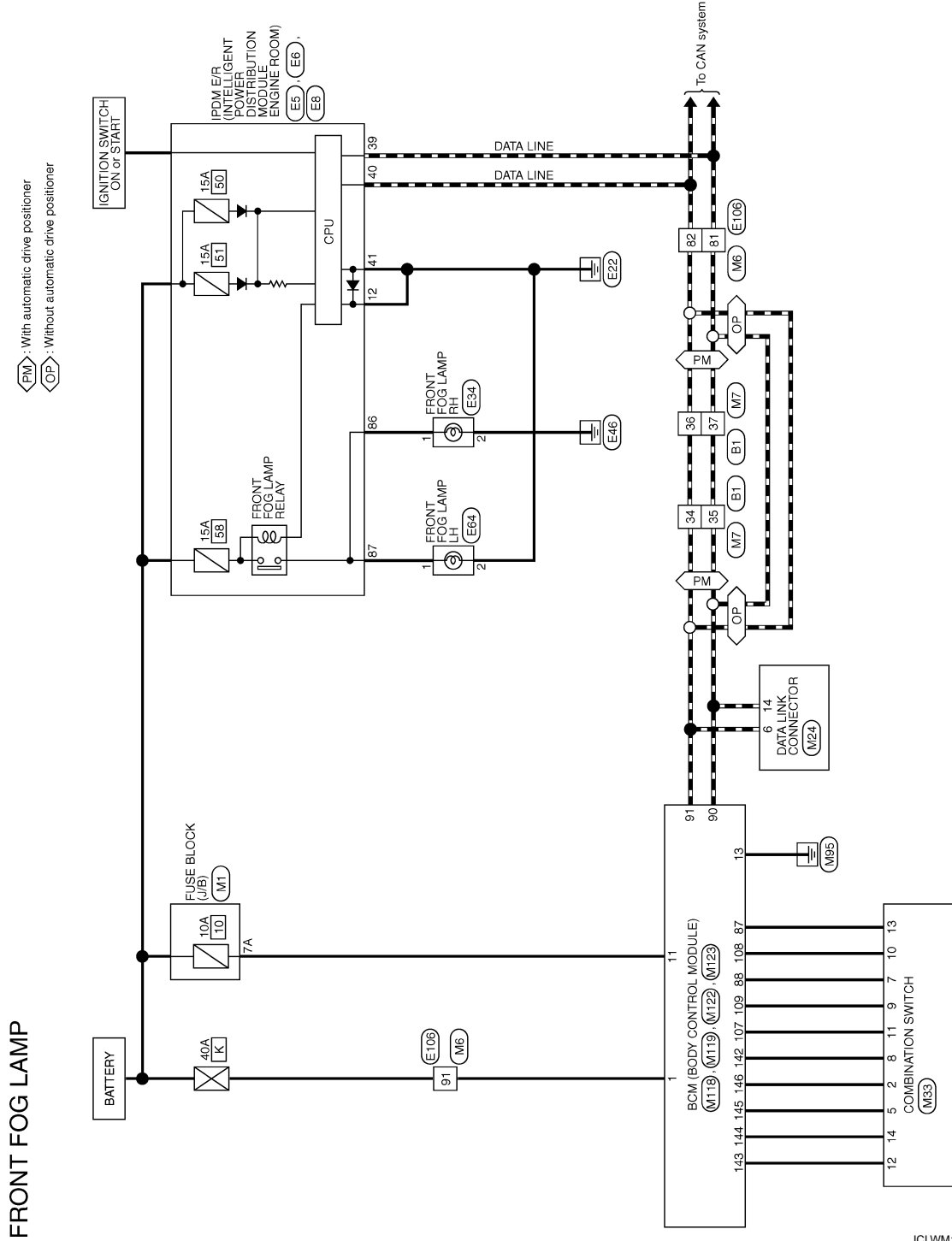

2007/10/26

JCLWM1254GE

FRONT FOG LAMP SYSTEM

< COMPONENT DIAGNOSIS >

[HALOGEN TYPE]

FRONT FOG LAMP

Connector No.	M33	Connector Name	COMBINATION SWITCH
Connector Type	TH16FW-NH		
Terminal No.	Color of Wire	Signal Name [Specification]	
2	SB	OUTPUT 4	
5	L	OUTPUT 3	
7	V	INPUT 3	
8	O	OUTPUT 5	
9	Y	INPUT 2	
10	R	INPUT 4	
11	LG	INPUT 1	
12	P	OUTPUT 1	
13	BR	INPUT 5	
14	G	OUTPUT 2	

Connector No.	M24	Connector Name	DATA LINK CONNECTOR
Connector Type	BD16FW		
Terminal No.	Color of Wire	Signal Name [Specification]	
6	L	-	
14	P	-	

Connector No.	M7	Connector Name	WIRE TO WIRE
Connector Type	TH80MW-CS16-TM4		
Terminal No.	Color of Wire	Signal Name [Specification]	
34	L	-	
35	P	-	
36	L	-	
37	P	-	

Connector No.	M18	Connector Name	BCM (BODY CONTROL MODULE)
Connector Type	MG3FB-LC		
Terminal No.	Color of Wire	Signal Name [Specification]	
1	W	BAT (F/L)	

Connector No.	M19	Connector Name	BCM (BODY CONTROL MODULE)
Connector Type	NS16FW-CS		
Terminal No.	Color of Wire	Signal Name [Specification]	
11	R	BAT FUSE	
13	B	GND	

Connector No.	M122	Connector Name	BCM (BODY CONTROL MODULE)
Connector Type	TH40FB-NH		
Terminal No.	Color of Wire	Signal Name [Specification]	
87	BR	COMBI SW INPUT 5	
88	V	COMBI SW INPUT 3	
90	P	CAN-L	
91	L	CAN-H	
107	LG	COMBI SW INPUT 1	
108	R	COMBI SW INPUT 4	
109	Y	COMBI SW INPUT 2	

Connector No.	M123	Connector Name	BCM (BODY CONTROL MODULE)
Connector Type	TH40FG-NH		
Terminal No.	Color of Wire	Signal Name [Specification]	
142	O	COMBI SW OUTPUT 5	
143	P	COMBI SW OUTPUT 1	
144	G	COMBI SW OUTPUT 2	
145	L	COMBI SW OUTPUT 3	
146	SB	COMBI SW OUTPUT 4	

JCLWM1256GE

TURN SIGNAL AND HAZARD WARNING LAMP SYSTEM

< COMPONENT DIAGNOSIS >

[HALOGEN TYPE]

TURN SIGNAL AND HAZARD WARNING LAMP SYSTEM

Wiring Diagram - TURN AND HAZARD WARNING LAMPS -

INFOID:000000003534031

TURN SIGNAL AND HAZARD WARNING LAMPS

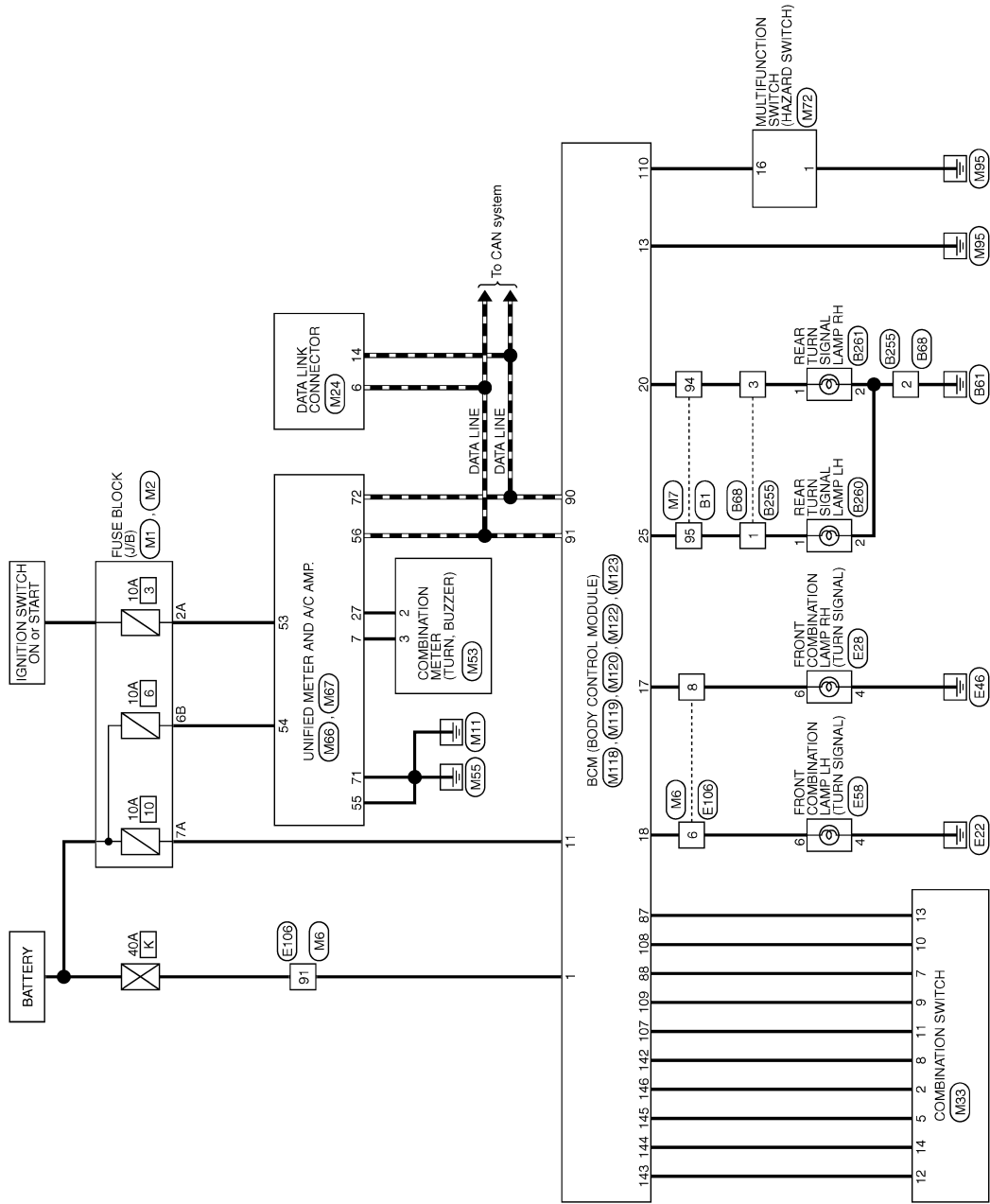

2007/10/26

JCLWM1257GE

A
B
C
D
E
F
G
H
I
J
K
L
M
N
O
P

EXL

TURN SIGNAL AND HAZARD WARNING LAMP SYSTEM

< COMPONENT DIAGNOSIS >

[HALOGEN TYPE]

TURN SIGNAL AND HAZARD WARNING LAMPS

Connector No. B1	WIRE TO WIRE TH80FW-CS16-TM4		
Terminal No.	Color of Wire	Signal Name [Specification]	
94	SB	-	
95	G	-	

Connector No. B261	REAR TURN SIGNAL LAMP RH HS02FG-W		
Terminal No.	Color of Wire	Signal Name [Specification]	
1	V	-	
2	B	-	

Connector No. B261	REAR TURN SIGNAL LAMP LH HS02FG-W		
Terminal No.	Color of Wire	Signal Name [Specification]	
1	G	-	
2	B	-	

Connector No. B255	WIRE TO WIRE RH08FB		
Terminal No.	Color of Wire	Signal Name [Specification]	
1	G	-	
2	B	-	
3	V	-	

Connector No. B260	REAR TURN SIGNAL LAMP LH HS02FG-W		
Terminal No.	Color of Wire	Signal Name [Specification]	
1	G	-	
2	B	-	

Connector No. E28	FRONT COMBINATION LAMP RH RS08FB-PR		
Terminal No.	Color of Wire	Signal Name [Specification]	
4	B/W	-	
6	V	-	

Connector No. E28	FRONT COMBINATION LAMP RH RS08FB-PR		
Terminal No.	Color of Wire	Signal Name [Specification]	
4	B/W	-	
6	V	-	

Connector No. E58	FRONT COMBINATION LAMP LH RS08FB-PR		
Terminal No.	Color of Wire	Signal Name [Specification]	
4	B/W	-	
6	G	-	

Connector No. E58	FRONT COMBINATION LAMP LH RS08FB-PR		
Terminal No.	Color of Wire	Signal Name [Specification]	
4	B/W	-	
6	G	-	

Connector No. E108	WIRE TO WIRE TH80FW-CS16-TM4		
Terminal No.	Color of Wire	Signal Name [Specification]	
6	G	-	
8	V	-	
91	W	-	

Connector No. E108	WIRE TO WIRE TH80FW-CS16-TM4		
Terminal No.	Color of Wire	Signal Name [Specification]	
6	G	-	
8	V	-	
91	W	-	

JCLWM1258GE

TURN SIGNAL AND HAZARD WARNING LAMP SYSTEM

< COMPONENT DIAGNOSIS >

[HALOGEN TYPE]

TURN SIGNAL AND HAZARD WARNING LAMPS

Connector No.	M1	Connector No.	M2	Connector No.	M6	Connector No.	M7
Connector Name	FUSE BLOCK (J/B)	Connector Name	FUSE BLOCK (J/B)	Connector Name	WIRE TO WIRE	Connector Name	WIRE TO WIRE
Connector Type	NSDFW-M2	Connector Type	NSDFW-CS	Connector Type	TH4DFW-NH	Connector Type	TH4DFW-CS (6-TM4)

Terminal No.	2A	7A	6B	6	8	91	Terminal No.	94	95
Color of Wire	G	R	Y	Y	O	W	Color of Wire	V	G
Signal Name [Specification]							Signal Name [Specification]		

Connector No.	M4	Connector No.	M3	Connector No.	M53	Connector No.	M56
Connector Name	DATA LINK CONNECTOR	Connector Name	COMBINATION SWITCH	Connector Name	COMBINATION METER	Connector Name	UNIFIED METER AND A/C AMP.
Connector Type	BD16FW	Connector Type	TH16FW-NH	Connector Type	TH4DFW-NH	Connector Type	TH4DFW-NH

Terminal No.	6	14	2	5	7	8	9	10	11	12	13	14	15	16
Color of Wire	L	P	SB	L	V	O	Y	R	LG	P	BR	G	GR	LG
Signal Name [Specification]				OUTPUT 4	OUTPUT 3	INPUT 3	OUTPUT 5	INPUT 2	INPUT 4	INPUT 1	OUTPUT 1	INPUT 5	OUTPUT 2	COMM (AMP->METER)

JCLWM1259GE

A
B
C
D
E
F
G
H
I
J
K
EXL
M
N
O
P

TURN SIGNAL AND HAZARD WARNING LAMP SYSTEM

< COMPONENT DIAGNOSIS >

[HALOGEN TYPE]

TURN SIGNAL AND HAZARD WARNING LAMPS

Connector No.	M119
Connector Name	BCM (BODY CONTROL MODULE)
Connector Type	NSJ6FW-CS



Terminal No.	Color of Wire	Signal Name [Specification]
11	R	BAT (FUSE)
13	B	GND
17	W	TURN SIGNAL RH (FRONT)
18	O	TURN SIGNAL LH (FRONT)

Connector No.	M118
Connector Name	BCM (BODY CONTROL MODULE)
Connector Type	M03EF-LC



Terminal No.	Color of Wire	Signal Name [Specification]
1	W	BAT (F/L)

Connector No.	M122
Connector Name	MULTIFUNCTION SWITCH
Connector Type	T111EFW-NH



Terminal No.	Color of Wire	Signal Name [Specification]
1	B	GND
16	G	HAZARD ON

Connector No.	M67
Connector Name	UNIFIED METER AND A/C AMP.
Connector Type	TH22FW-NH



Terminal No.	Color of Wire	Signal Name [Specification]
53	G	IGN
54	Y	BAT
55	B	GND
56	L	CAN-H
71	B	GND
72	P	CAN-L

Connector No.	M123
Connector Name	BCM (BODY CONTROL MODULE)
Connector Type	T140DFG-NH



Terminal No.	Color of Wire	Signal Name [Specification]
142	O	COMBI SW OUTPUT 5
143	P	COMBI SW OUTPUT 1
144	G	COMBI SW OUTPUT 2
145	L	COMBI SW OUTPUT 3
146	SB	COMBI SW OUTPUT 4

Connector No.	M122
Connector Name	BCM (BODY CONTROL MODULE)
Connector Type	T140DFE-NH



Terminal No.	Color of Wire	Signal Name [Specification]
87	BR	COMBI SW INPUT 5
88	V	COMBI SW INPUT 3
90	P	CAN-L
91	L	CAN-H
107	LG	COMBI SW INPUT 1
108	R	COMBI SW INPUT 4
109	Y	COMBI SW INPUT 2
110	G	HAZARD SW

Connector No.	M120
Connector Name	BCM (BODY CONTROL MODULE)
Connector Type	NS12FW-CS



Terminal No.	Color of Wire	Signal Name [Specification]
20	V	TURN SIGNAL RH (REAR)
25	G	TURN SIGNAL LH (REAR)

Connector No.	M120
Connector Name	BCM (BODY CONTROL MODULE)
Connector Type	NS12FW-CS



Terminal No.	Color of Wire	Signal Name [Specification]
20	V	TURN SIGNAL RH (REAR)
25	G	TURN SIGNAL LH (REAR)

JCLW1260GE

PARKING, LICENSE PLATE AND TAIL LAMPS SYSTEM

< COMPONENT DIAGNOSIS >

[HALOGEN TYPE]

PARKING, LICENSE PLATE AND TAIL LAMPS SYSTEM

Wiring Diagram - PARKING, LICENSE PLATE AND TAIL LAMPS -

INFOID:000000003534032

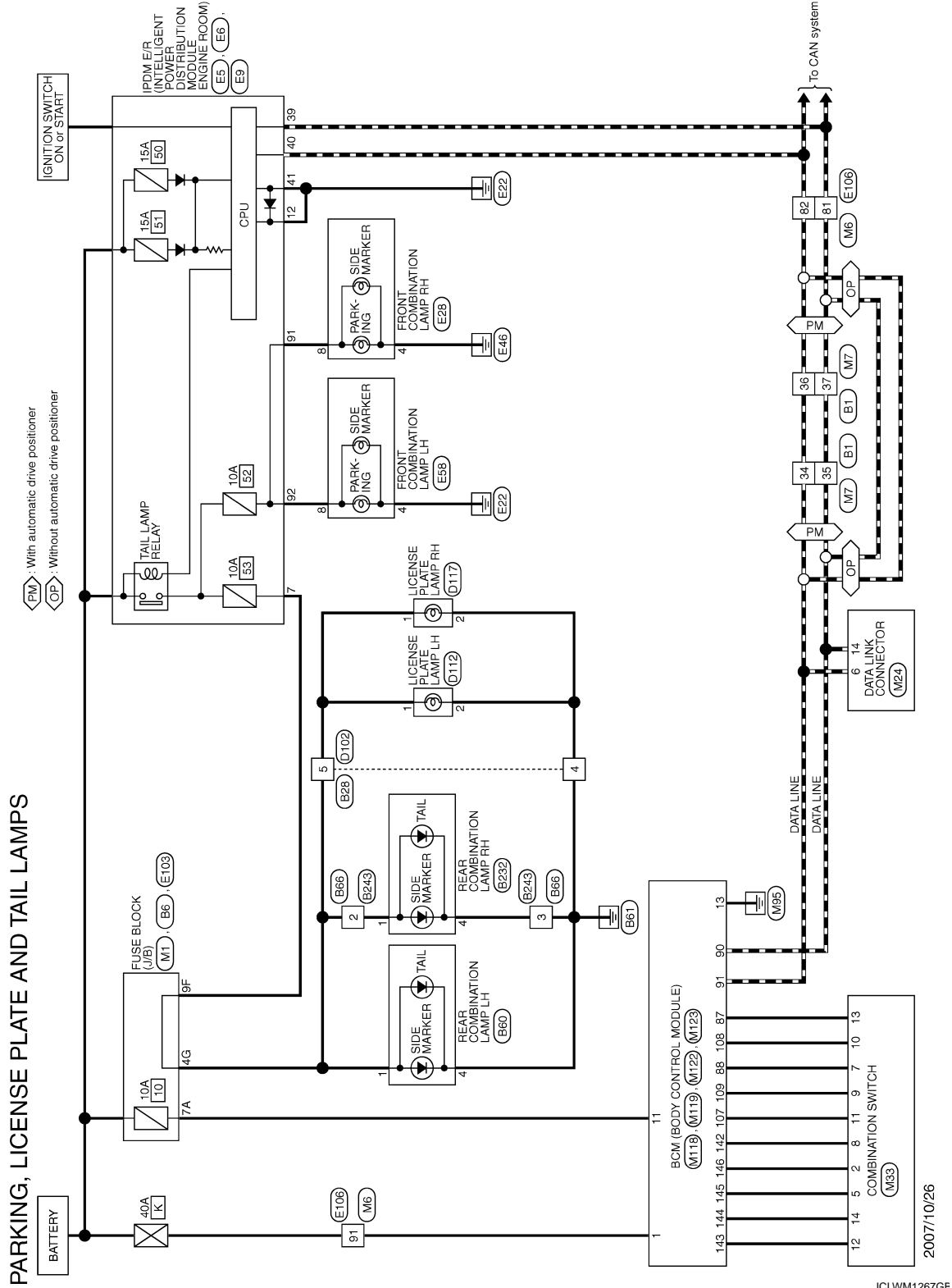

A
B
C
D
E
F
G
H
I
J
K
L
M
N
O
P

EXL

PARKING, LICENSE PLATE AND TAIL LAMPS SYSTEM

< COMPONENT DIAGNOSIS >

[HALOGEN TYPE]

PARKING, LICENSE PLATE AND TAIL LAMPS

Connector No.	D12
Connector Name	LICENSE PLATE LAMP LH
Connector Type	TK02FBR



Terminal No.	Color of Wire	Signal Name [Specification]
1	R	-
2	B	-

Connector No.	D17
Connector Name	LICENSE PLATE LAMP RH
Connector Type	TK02FBR



Terminal No.	Color of Wire	Signal Name [Specification]
1	R	-
2	B	-

Connector No.	E5
Connector Name	IPDM E/R (INTELLIGENT POWER DISTRIBUTION MODULE ENGINE ROOM)
Connector Type	TH20FW-CS12-M4-TV

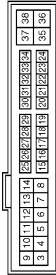

Terminal No.	Color of Wire	Signal Name [Specification]
7	R	-
12	B/W	-

Connector No.	E6
Connector Name	IPDM E/R (INTELLIGENT POWER DISTRIBUTION MODULE ENGINE ROOM)
Connector Type	TH03FW-NH

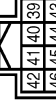

Terminal No.	Color of Wire	Signal Name [Specification]
39	P	-
40	L	-
41	B/W	-

Connector No.	E9
Connector Name	IPDM E/R (INTELLIGENT POWER DISTRIBUTION MODULE ENGINE ROOM)
Connector Type	TH16FW-NH



Terminal No.	Color of Wire	Signal Name [Specification]
91	P	-
92	O	-

Connector No.	E28
Connector Name	FRONT COMBINATION LAMP RH
Connector Type	RS08FB-PR



Terminal No.	Color of Wire	Signal Name [Specification]
8	P	-

Connector No.	E58
Connector Name	FRONT COMBINATION LAMP LH
Connector Type	RS08FB-PR



Terminal No.	Color of Wire	Signal Name [Specification]
4	B/W	-
8	O	-

Connector No.	E103
Connector Name	FUSE BLOCK (J/B)
Connector Type	NS16FW-CS



Terminal No.	Color of Wire	Signal Name [Specification]
9F	R	-

A
B
C
D
E
F
G
H
I
J
K
EXL
M
N
O
P

PARKING, LICENSE PLATE AND TAIL LAMPS SYSTEM

< COMPONENT DIAGNOSIS >

[HALOGEN TYPE]

PARKING, LICENSE PLATE AND TAIL LAMPS

Connector No.	M7
Connector Name	WIRE TO WIRE
Connector Type	TH80MW-CS16-TM4

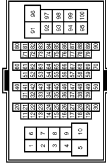

Terminal No.	Color of Wire	Signal Name [Specification]
34	L	-
35	P	-
36	L	-
37	P	-

Connector No.	M6
Connector Name	WIRE TO WIRE
Connector Type	TH80MW-CS16-TM4

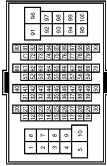

Terminal No.	Color of Wire	Signal Name [Specification]
81	P	-
82	L	-
91	W	-

Connector No.	M1
Connector Name	FUSE BLOCK (J/B)
Connector Type	NS06FW-M2

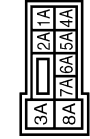

Terminal No.	Color of Wire	Signal Name [Specification]
7A	R	-

Connector No.	E106
Connector Name	WIRE TO WIRE
Connector Type	TH80FW-CS16-TM4

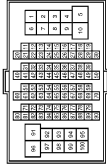

Terminal No.	Color of Wire	Signal Name [Specification]
81	P	-
82	L	-
91	W	-

Connector No.	M119
Connector Name	BCM (BODY CONTROL MODULE)
Connector Type	NS16FW-CS



Terminal No.	Color of Wire	Signal Name [Specification]
11	R	BAT (FUSE)
13	B	GND

Connector No.	M118
Connector Name	BCM (BODY CONTROL MODULE)
Connector Type	M03FE-LC



Terminal No.	Color of Wire	Signal Name [Specification]
1	W	BAT (F/L)

Connector No.	M33
Connector Name	COMBINATION SWITCH
Connector Type	TH16FW-NH



Terminal No.	Color of Wire	Signal Name [Specification]
2	SB	OUTPUT 4
5	L	OUTPUT 3
7	V	INPUT 3
8	O	OUTPUT 5
9	Y	INPUT 2
10	R	INPUT 4
11	LG	INPUT 1
12	P	OUTPUT 1
13	BR	INPUT 5
14	G	OUTPUT 2

Connector No.	M24
Connector Name	DATA LINK CONNECTOR
Connector Type	BD16FW



Terminal No.	Color of Wire	Signal Name [Specification]
6	L	-
14	P	-

JCLWM1270GE

PARKING, LICENSE PLATE AND TAIL LAMPS SYSTEM

< COMPONENT DIAGNOSIS >

[HALOGEN TYPE]

PARKING, LICENSE PLATE AND TAIL LAMPS

Connector No.	M122
Connector Name	BCM (BODY CONTROL MODULE)
Connector Type	TH40FB-NH

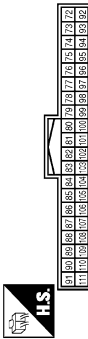

Terminal No.	Color of Wire	Signal Name [Specification]
87	BR	COMBI SW INPUT 5
88	V	COMBI SW INPUT 3
90	P	CAN-L
91	L	CAN-H
107	LG	COMBI SW INPUT 1
108	R	COMBI SW INPUT 4
109	Y	COMBI SW INPUT 2

Connector No.	M123
Connector Name	BCM (BODY CONTROL MODULE)
Connector Type	TH40FG-NH

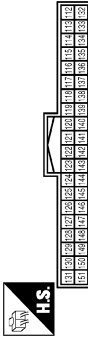

Terminal No.	Color of Wire	Signal Name [Specification]
142	O	COMBI SW OUTPUT 5
143	P	COMBI SW OUTPUT 1
144	G	COMBI SW OUTPUT 2
145	L	COMBI SW OUTPUT 3
146	SB	COMBI SW OUTPUT 4

A
B
C
D
E
F
G
H
I
J
K
EXL
M
N
O
P

JCLWM1271GE

STOP LAMP

< COMPONENT DIAGNOSIS >

[HALOGEN TYPE]

STOP LAMP

Wiring Diagram - STOP LAMP -

INFOID:000000003534033

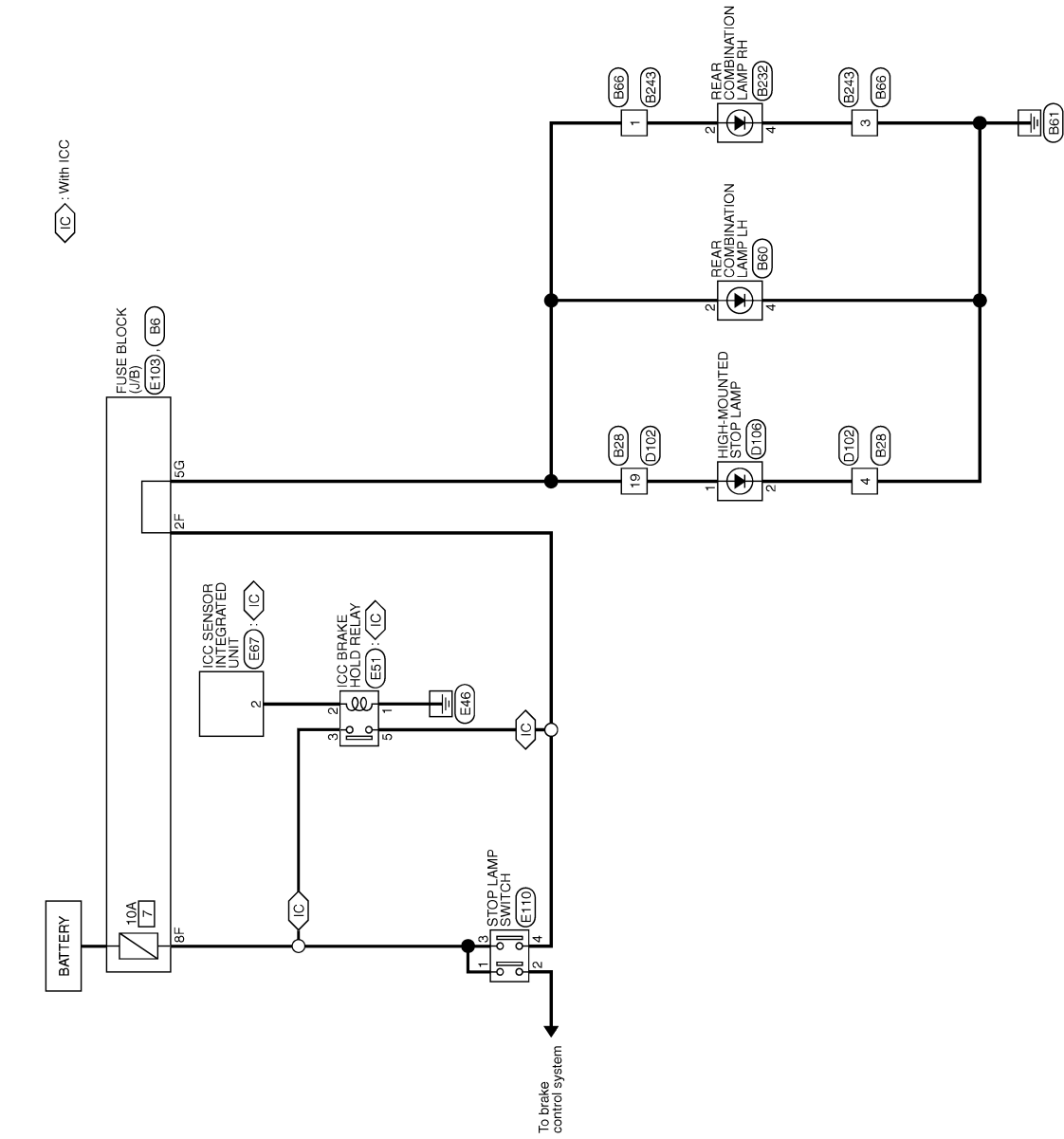

STOP LAMP

2007/10/26

JCLWM1261GE

STOP LAMP

< COMPONENT DIAGNOSIS >

[HALOGEN TYPE]

STOP LAMP

Connector No.	B6
Connector Name	FUSE BLOCK (J/B)
Connector Type	HS/2FBF-CS



Terminal No.	5G	Color of Wire	Signal Name [Specification]
	LG		
	B		

Connector No.	B28
Connector Name	WIRE TO WIRE
Connector Type	TH24MF-NH

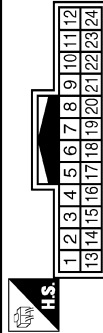

Terminal No.	4	Color of Wire	Signal Name [Specification]
	19	B	
	LG		

Connector No.	B60
Connector Name	REAR COMBINATION LAMP LH
Connector Type	TH64MF-NH



Terminal No.	2	Color of Wire	Signal Name [Specification]
	4	LG	
	B		

Connector No.	B66
Connector Name	WIRE TO WIRE
Connector Type	TH24MF-NH

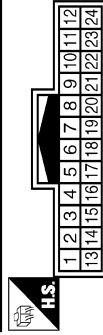

Terminal No.	1	Color of Wire	Signal Name [Specification]
	3	LG	
	B		

Connector No.	B232
Connector Name	REAR COMBINATION LAMP RH
Connector Type	TH04MF-NH

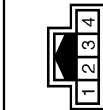

Terminal No.	2	Color of Wire	Signal Name [Specification]
	4	LG	
	B		

Connector No.	B243
Connector Name	WIRE TO WIRE
Connector Type	TH24FW-NH

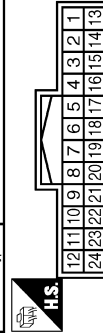

Terminal No.	4	Color of Wire	Signal Name [Specification]
	3	B	
	19	LG	

Connector No.	D102
Connector Name	WIRE TO WIRE
Connector Type	TH24FW-NH

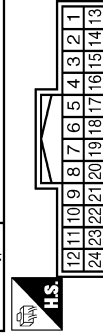

Terminal No.	4	Color of Wire	Signal Name [Specification]
	19	B	
	LG		

Connector No.	D106
Connector Name	HIGH-MOUNTED STOP LAMP
Connector Type	TE02MW

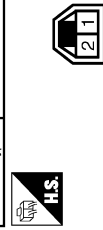

Terminal No.	1	Color of Wire	Signal Name [Specification]
	2	B	
	LG		

JCLWM1262GE







A
B
C
D
E
F
G
H
I
J
K
EXL
M
N
O
P

STOP LAMP

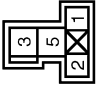
< COMPONENT DIAGNOSIS >

[HALOGEN TYPE]

STOP LAMP

Connector No.	E51	Connector No.	E103	Connector No.	E67	Connector No.	E110
Connector Name	ICC BRAKE HOLD RELAY	Connector Name	FUSE BLOCK (J/B)	Connector Name	ICC SENSOR INTEGRATED UNIT	Connector Name	STOP LAMP SWITCH
Connector Type	MS2FL-M2	Connector Type	NS18FW-CS	Connector Type	RS0FB-PR	Connector Type	MSAFW-LC
							
Terminal No.	1	Terminal No.	2F	Terminal No.	2	Terminal No.	1
Color of Wire	B	Color of Wire	W	Color of Wire	V	Color of Wire	L
Signal Name [Specification]	-	Color of Wire	L	Color of Wire	-	Color of Wire	SB
	-	Terminal No.	8F	Signal Name [Specification]	BRK LMP RLY	Color of Wire	L
	-	Signal Name [Specification]	-	Signal Name [Specification]	-	Color of Wire	SB
	-	Signal Name [Specification]	-	Signal Name [Specification]	-	Color of Wire	L
	-	Signal Name [Specification]	-	Signal Name [Specification]	-	Color of Wire	L
	-	Signal Name [Specification]	-	Signal Name [Specification]	-	Color of Wire	W
	-	Signal Name [Specification]	-	Signal Name [Specification]	-	Color of Wire	W

JCLWM1263GE

BACK-UP LAMP

< COMPONENT DIAGNOSIS >

[HALOGEN TYPE]

BACK-UP LAMP

Wiring Diagram - BACK-UP LAMP -

INFOID:000000003534034

BACK-UP LAMP

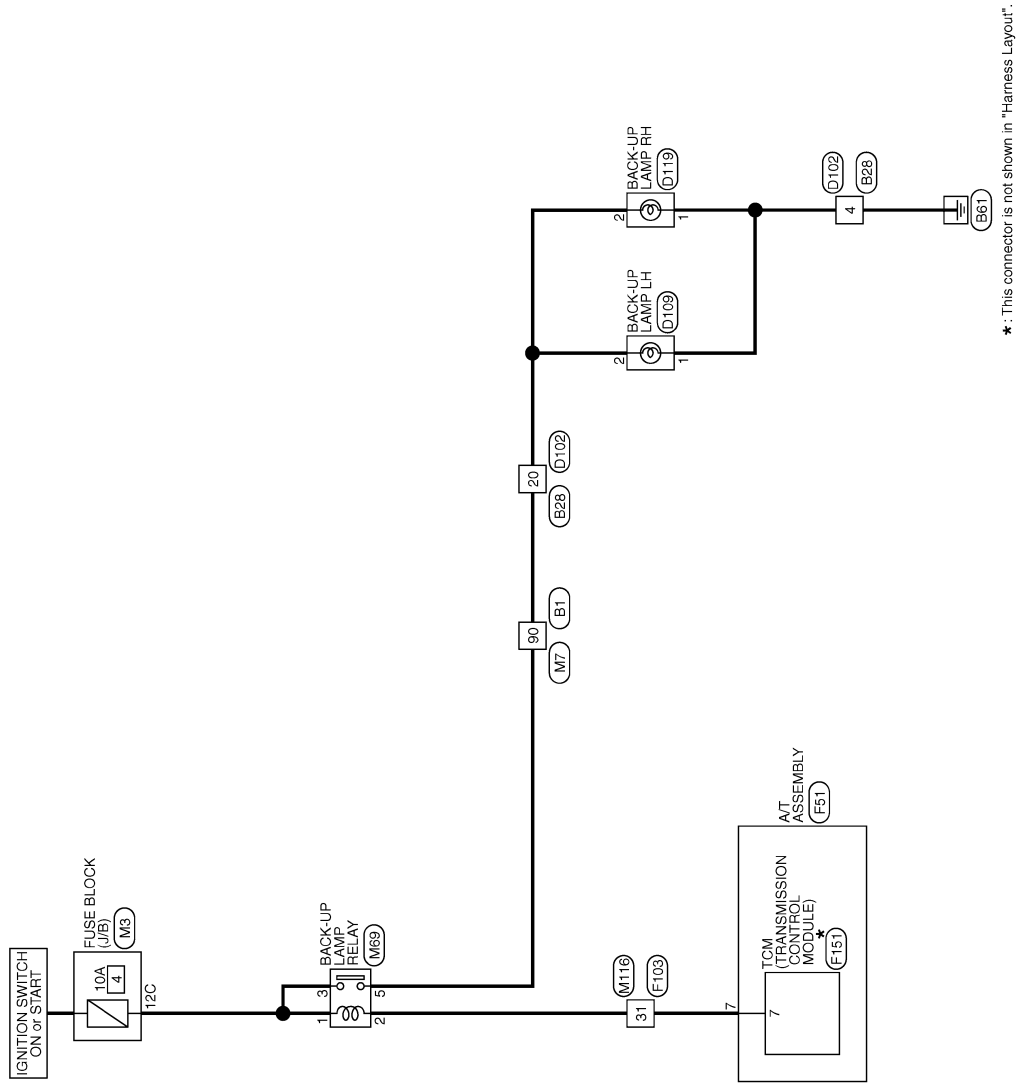

2007/10/26

JCLWM1264GE











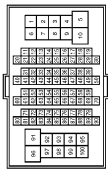





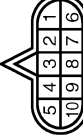

A
B
C
D
E
F
G
H
I
J
K
EXL
M
N
O
P

BACK-UP LAMP

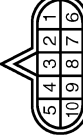
< COMPONENT DIAGNOSIS >

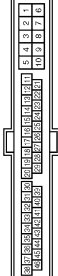
[HALOGEN TYPE]

BACK-UP LAMP

Connector No. B1	WIRE TO WIRE TH807V-CS16-TM4			Connector No. D109	BACK-UP LAMP LH NS02MW-CS			Terminal No. 1	Color of Wire B	Signal Name [Specification]
Connector No. B28	WIRE TO WIRE TH24MF-RH			Terminal No. 4	Color of Wire B	Signal Name [Specification]	Terminal No. 2	Color of Wire O	Signal Name [Specification]	
Connector No. D102	WIRE TO WIRE TH24FW-RH			Terminal No. 4	Color of Wire B	Signal Name [Specification]	Terminal No. 7	Color of Wire O	Signal Name [Specification]	
Connector No. F51	A/T ASSEMBLY RK10FG-DGY			Terminal No. 31	Color of Wire R	Signal Name [Specification]	Terminal No. 31	Color of Wire R	Signal Name [Specification]	
Connector No. D13	BACK-UP LAMP RH NS02MW-CS			Terminal No. 1	Color of Wire B	Signal Name [Specification]	Terminal No. 1	Color of Wire B	Signal Name [Specification]	
Connector No. F51	A/T ASSEMBLY RK10FG-DGY			Terminal No. 7	Color of Wire R	Signal Name [Specification]	Terminal No. 7	Color of Wire O	Signal Name [Specification]	
Connector No. F103	WIRE TO WIRE TK30FW-NS10			Terminal No. 31	Color of Wire R	Signal Name [Specification]	Terminal No. 31	Color of Wire R	Signal Name [Specification]	
Connector No. F151	TGM (TRANSMISSION CONTROL MODULE) SP10FBGY			Terminal No. 7	Color of Wire O	Signal Name [Specification]	Terminal No. 7	Color of Wire O	Signal Name [Specification]	

JCLWM1265GE

BACK-UP LAMP

< COMPONENT DIAGNOSIS >

[HALOGEN TYPE]

BACK-UP LAMP

Connector No.	M3
Connector Name	FUSE BLOCK (J/B)
Connector Type	NS12FW-CS



Terminal No.	12C	Color of Wire	O	Signal Name [Specification]	-
--------------	-----	---------------	---	-----------------------------	---

Connector No.	M7
Connector Name	WIRE TO WIRE
Connector Type	TR6GMF-CS16-TM4

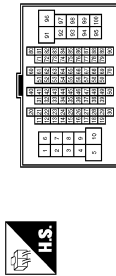

Terminal No.	90	Color of Wire	O	Signal Name [Specification]	-
--------------	----	---------------	---	-----------------------------	---

Connector No.	M69
Connector Name	BACK-UP LAMP RELAY
Connector Type	MS22FL-M2

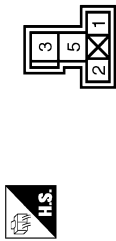

Terminal No.	1	Color of Wire	R	Signal Name [Specification]	-
2	W	-	-	-	-
3	LG	-	-	-	-
5	O	-	-	-	-

Connector No.	M116
Connector Name	WIRE TO WIRE
Connector Type	TK36MF-NS10

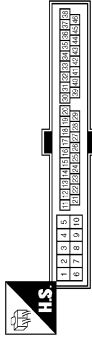

Terminal No.	31	Color of Wire	W	Signal Name [Specification]	-
--------------	----	---------------	---	-----------------------------	---

A
B
C
D
E
F
G
H
I
J
K
EXL
M
N
O
P

JCLWM1266GE

BCM (BODY CONTROL MODULE)

< ECU DIAGNOSIS >

[HALOGEN TYPE]

ECU DIAGNOSIS

BCM (BODY CONTROL MODULE)

Reference Value

INFOID:000000003784724

VALUES ON THE DIAGNOSIS TOOL

CONSULT-III MONITOR ITEM

Monitor Item	Condition	Value/Status
FR WIPER HI	Other than front wiper switch HI	Off
	Front wiper switch HI	On
FR WIPER LOW	Other than front wiper switch LO	Off
	Front wiper switch LO	On
FR WASHER SW	Front washer switch OFF	Off
	Front washer switch ON	On
FR WIPER INT	Other than front wiper switch INT	Off
	Front wiper switch INT	On
FR WIPER STOP	Front wiper is not in STOP position	Off
	Front wiper is in STOP position	On
INT VOLUME	Wiper intermittent dial is in a dial position 1 - 7	Wiper intermittent dial position
RR WIPER ON	Other than rear wiper switch ON	Off
	Rear wiper switch ON	On
RR WIPER INT	Other than rear wiper switch INT	Off
	Rear wiper switch INT	On
RR WASHER SW	Rear washer switch OFF	Off
	Rear washer switch ON	On
RR WIPER STOP	Rear wiper is in STOP position	Off
	Rear wiper is not in STOP position	On
TURN SIGNAL R	Other than turn signal switch RH	Off
	Turn signal switch RH	On
TURN SIGNAL L	Other than turn signal switch LH	Off
	Turn signal switch LH	On
TAIL LAMP SW	Other than lighting switch 1ST and 2ND	Off
	Lighting switch 1ST or 2ND	On
HI BEAM SW	Other than lighting switch HI	Off
	Lighting switch HI	On
HEAD LAMP SW 1	Other than lighting switch 2ND	Off
	Lighting switch 2ND	On
HEAD LAMP SW 2	Other than lighting switch 2ND	Off
	Lighting switch 2ND	On
PASSING SW	Other than lighting switch PASS	Off
	Lighting switch PASS	On
AUTO LIGHT SW	Other than lighting switch AUTO	Off
	Lighting switch AUTO	On
FR FOG SW	Front fog lamp switch OFF	Off
	Front fog lamp switch ON	On

BCM (BODY CONTROL MODULE)

[HALOGEN TYPE]

< ECU DIAGNOSIS >

Monitor Item	Condition	Value/Status	
RR FOG SW	NOTE: The item is indicated, but not monitored.	Off	A
DOOR SW-DR	Driver door closed	Off	B
	Driver door opened	On	
DOOR SW-AS	Passenger door closed	Off	C
	Passenger door opened	On	
DOOR SW-RR	Rear RH door closed	Off	D
	Rear RH door opened	On	
DOOR SW-RL	Rear LH door closed	Off	D
	Rear LH door opened	On	
DOOR SW-BK	Back door closed	Off	E
	Back door opened	On	
CDL LOCK SW	Other than power door lock switch LOCK	Off	F
	Power door lock switch LOCK	On	
CDL UNLOCK SW	Other than power door lock switch UNLOCK	Off	G
	Power door lock switch UNLOCK	On	
KEY CYL LK-SW	Other than driver door key cylinder LOCK position	Off	H
	Driver door key cylinder LOCK position	On	
KEY CYL UN-SW	Other than driver door key cylinder UNLOCK position	Off	H
	Driver door key cylinder UNLOCK position	On	
KEY CYL SW-TR	NOTE: The item is indicated, but not monitored.	Off	I
HAZARD SW	Hazard switch is OFF	Off	J
	Hazard switch is ON	On	
REAR DEF SW	NOTE: The item is indicated, but not monitored.	Off	K
TR CANCEL SW	NOTE: The item is indicated, but not monitored.	Off	K
TR/BD OPEN SW	Back door opener switch OFF	Off	EXL
	While the back door opener switch is turned ON	On	
TRNK/HAT MNTR	NOTE: The item is indicated, but not monitored.	Off	
RKE-LOCK	LOCK button of the key is not pressed	Off	M
	LOCK button of the key is pressed	On	
RKE-UNLOCK	UNLOCK button of the key is not pressed	Off	N
	UNLOCK button of the key is pressed	On	
RKE-TR/BD	NOTE: The item is indicated, but not monitored.	Off	O
RKE-PANIC	PANIC button of the key is not pressed	Off	O
	PANIC button of the key is pressed	On	
RKE-P/W OPEN	UNLOCK button of the key is not pressed	Off	P
	UNLOCK button of the key is pressed and held	On	
RKE-MODE CHG	LOCK/UNLOCK button of the key is not pressed and held simultaneously	Off	
	LOCK/UNLOCK button of the key is pressed and held simultaneously	On	

BCM (BODY CONTROL MODULE)

< ECU DIAGNOSIS >

[HALOGEN TYPE]

Monitor Item	Condition	Value/Status
OPTICAL SENSOR	Bright outside of the vehicle	Close to 5 V
	Dark outside of the vehicle	Close to 0 V
REQ SW -DR	Driver door request switch is not pressed	Off
	Driver door request switch is pressed	On
REQ SW -AS	Passenger door request switch is not pressed	Off
	Passenger door request switch is pressed	On
REQ SW -RR	NOTE: The item is indicated, but not monitored.	Off
REQ SW -RL	NOTE: The item is indicated, but not monitored.	Off
REQ SW -BD/TR	Back door request switch is not pressed	Off
	Back door request switch is pressed	On
PUSH SW	Push-button ignition switch (push switch) is not pressed	Off
	Push-button ignition switch (push switch) is pressed	On
IGN RLY2 -F/B	Ignition switch in OFF or ACC position	Off
	Ignition switch in ON position	On
CLUCH SW	NOTE: The item is indicated, but not monitored.	Off
BRAKE SW 1	The brake pedal is not depressed	On
	The brake pedal is depressed	Off
DETE/CANCL SW	Selector lever in P position	Off
	Selector lever in any position other than P	On
SFT PN/N SW	Selector lever in any position other than P and N	Off
	Selector lever in P or N position	On
S/L -LOCK	Steering is locked	Off
	Steering is unlocked	On
S/L -UNLOCK	Steering is unlocked	Off
	Steering is locked	On
S/L RELAY-F/B	Ignition switch in OFF or ACC position	Off
	Ignition switch in ON position	On
UNLK SEN -DR	Driver door is unlocked	Off
	Driver door is locked	On
PUSH SW -IPDM	Push-button ignition switch (push-switch) is not pressed	Off
	Push-button ignition switch (push-switch) is pressed	On
IGN RLY1 -F/B	Ignition switch in OFF or ACC position	Off
	Ignition switch in ON position	On
DETE SW -IPDM	Selector lever in P position	Off
	Selector lever in any position other than P	On
SFT PN -IPDM	Selector lever in any position other than P and N	Off
	Selector lever in P or N position	On
SFT P -MET	Selector lever in any position other than P	Off
	Selector lever in P position	On
SFT N -MET	Selector lever in any position other than N	Off
	Selector lever in N position	On

BCM (BODY CONTROL MODULE)

< ECU DIAGNOSIS >

[HALOGEN TYPE]

Monitor Item	Condition	Value/Status	
ENGINE STATE	Engine stopped	Stop	A
	While the engine stalls	Stall	
	At engine cranking	Crank	B
	Engine running	Run	
S/L LOCK-IPDM	Steering is locked	Off	
	Steering is unlocked	On	C
S/L UNLK-IPDM	Steering is unlocked	Off	
	Steering is locked	On	D
S/L RELAY-REQ	Ignition switch in OFF or ACC position	Off	
	Ignition switch in ON position	On	
VEH SPEED 1	While driving	Equivalent to speedometer reading	E
VEH SPEED 2	While driving	Equivalent to speedometer reading	
DOOR STAT-DR	Driver door is locked	LOCK	
	Wait with selective UNLOCK operation (5 seconds)	READY	F
	Driver door is unlocked	UNLOCK	
DOOR STAT-AS	Passenger door is locked	LOCK	G
	Wait with selective UNLOCK operation (5 seconds)	READY	
	Passenger door is unlocked	UNLOCK	
ID OK FLAG	Ignition switch in ACC or ON position	Reset	H
	Ignition switch in OFF position	Set	
PRMT ENG STRT	The engine start is prohibited	Reset	I
	The engine start is permitted	Set	
PRMT RKE STRT	NOTE: The item is indicated, but not monitored.	Reset	J
KEY SW -SLOT	The key is not inserted into key slot	Off	
	The key is inserted into key slot	On	
RKE OPE COUN1	During the operation of the key	Operation frequency of the key	K
RKE OPE COUN2	NOTE: The item is indicated, but not monitored.	—	EXL
CONFIRM ID ALL	The key ID that the key slot receives does not accord with any key ID registered to BCM.	Yet	
	The key ID that the key slot receives accords with any key ID registered to BCM.	DONE	M
CONFIRM ID4	The key ID that the key slot receives does not accord with the fourth key ID registered to BCM.	Yet	
	The key ID that the key slot receives accords with the fourth key ID registered to BCM.	DONE	N
CONFIRM ID3	The key ID that the key slot receives does not accord with the third key ID registered to BCM.	Yet	O
	The key ID that the key slot receives accords with the third key ID registered to BCM.	DONE	
CONFIRM ID2	The key ID that the key slot receives does not accord with the second key ID registered to BCM.	Yet	P
	The key ID that the key slot receives accords with the second key ID registered to BCM.	DONE	

BCM (BODY CONTROL MODULE)

< ECU DIAGNOSIS >

[HALOGEN TYPE]

Monitor Item	Condition	Value/Status
CONFIRM ID1	The key ID that the key slot receives does not accord with the first key ID registered to BCM.	Yet
	The key ID that the key slot receives accords with the first key ID registered to BCM.	DONE
TP 4	The ID of fourth key is not registered to BCM	Yet
	The ID of fourth key is registered to BCM	DONE
TP 3	The ID of third key is not registered to BCM	Yet
	The ID of third key is registered to BCM	DONE
TP 2	The ID of second key is not registered to BCM	Yet
	The ID of second key is registered to BCM	DONE
TP 1	The ID of first key is not registered to BCM	Yet
	The ID of first key is registered to BCM	DONE
AIR PRESS FL	Ignition switch ON (Only when the signal from the transmitter is received)	Air pressure of front LH tire
AIR PRESS FR	Ignition switch ON (Only when the signal from the transmitter is received)	Air pressure of front RH tire
AIR PRESS RR	Ignition switch ON (Only when the signal from the transmitter is received)	Air pressure of rear RH tire
AIR PRESS RL	Ignition switch ON (Only when the signal from the transmitter is received)	Air pressure of rear LH tire
ID REGST FL1	ID of front LH tire transmitter is registered	DONE
	ID of front LH tire transmitter is not registered	Yet
ID REGST FR1	ID of front RH tire transmitter is registered	DONE
	ID of front RH tire transmitter is not registered	Yet
ID REGST RR1	ID of rear RH tire transmitter is registered	DONE
	ID of rear RH tire transmitter is not registered	Yet
ID REGST RL1	ID of rear LH tire transmitter is registered	DONE
	ID of rear LH tire transmitter is not registered	Yet
WARNING LAMP	Tire pressure indicator OFF	Off
	Tire pressure indicator ON	On
BUZZER	Tire pressure warning alarm is not sounding	Off
	Tire pressure warning alarm is sounding	On

BCM (BODY CONTROL MODULE)

[HALOGEN TYPE]

< ECU DIAGNOSIS >

TERMINAL LAYOUT

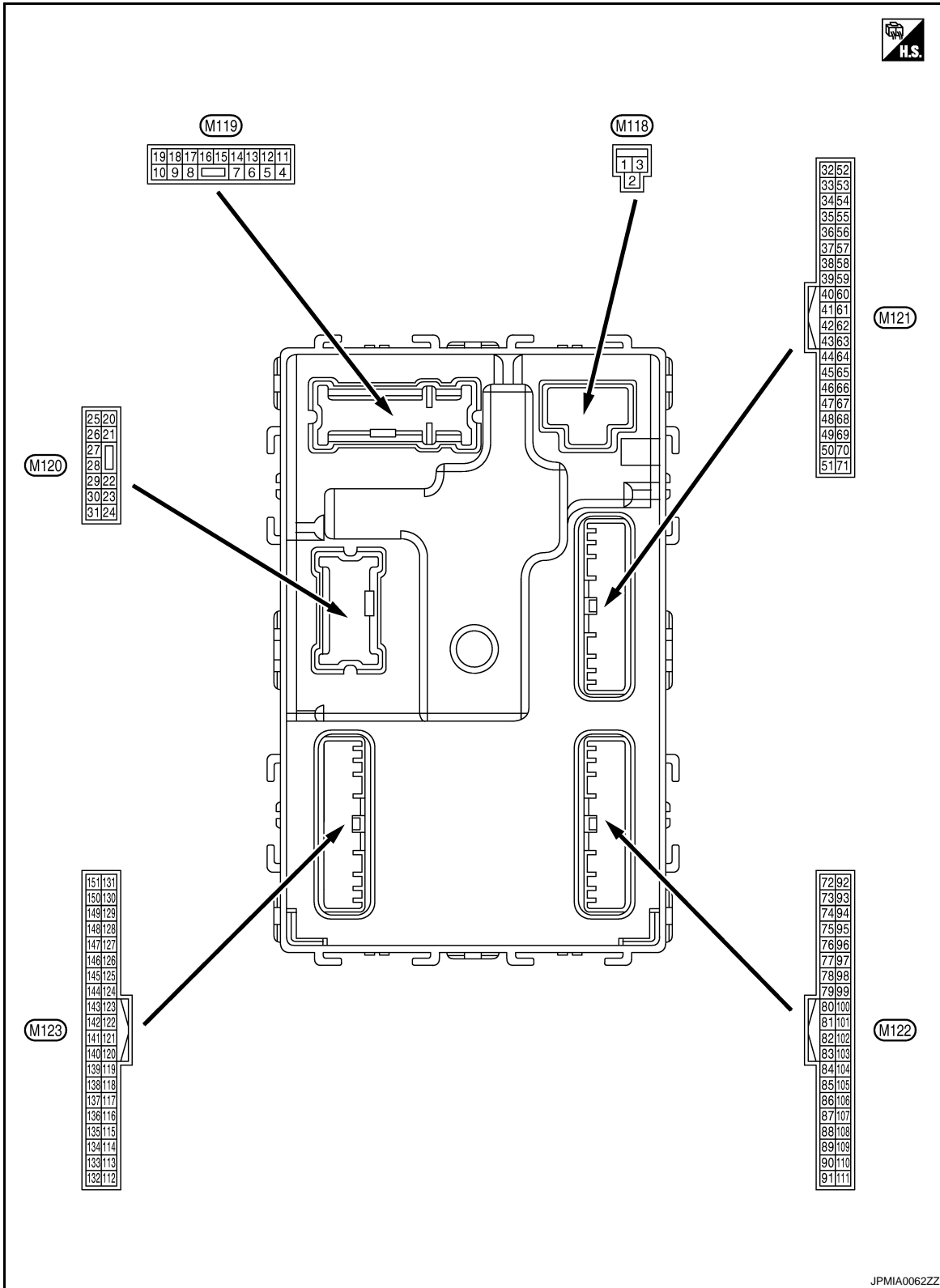

PHYSICAL VALUES

A
B
C
D
E
F
G
H
I
J
K
EXL
M
N
O
P

BCM (BODY CONTROL MODULE)

< ECU DIAGNOSIS >

[HALOGEN TYPE]

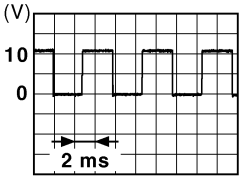
Terminal No. (Wire color)		Description		Condition		Value (Approx.)
		Signal name	Input/ Output			
+	-					
1 (W)	Ground	Battery power supply	Input	Ignition switch OFF		Battery voltage
2 (Y)	Ground	P/W power supply (BAT)	Output	Ignition switch OFF		Battery voltage
3 (O)	Ground	P/W power supply (RAP)	Output	Ignition switch ON		Battery voltage
4 (LG)	Ground	Interior room lamp power supply	Output	Interior room lamp battery saver is activated. (Cuts the interior room lamp power supply)		0 V
				Interior room lamp battery saver is not activated. (Outputs the interior room lamp power supply)		Battery voltage
5 (L)	Ground	Passenger door UN- LOCK	Output	Passenger door	UNLOCK (Actuator is activated)	Battery voltage
					Other than UNLOCK (Actuator is not activated)	0 V
7 (Y)	Ground	Step lamp	Output	Step lamp	ON	0 V
					OFF	Battery voltage
8 (V)	Ground	All doors, fuel lid LOCK	Output	All doors	LOCK (Actuator is activated)	Battery voltage
					Other than LOCK (Actuator is not activated)	0 V
9 (G)	Ground	Driver door, fuel lid UNLOCK	Output	Driver door	UNLOCK (Actuator is activated)	Battery voltage
					Other than UNLOCK (Actuator is not activated)	0 V
10 (BR)	Ground	Rear RH door and rear LH door UN- LOCK	Output	Rear RH door and rear LH door	UNLOCK (Actuator is activated)	Battery voltage
					Other than UNLOCK (Actuator is not activated)	0 V
11 (R)	Ground	Battery power supply	Input	Ignition switch OFF		Battery voltage
13 (B)	Ground	Ground	—	Ignition switch ON		0 V
14 (W)	Ground	Push-button ignition switch illumination ground	Output	Tail lamp	OFF	0 V
					ON	<p>NOTE: When the illumination brighten- ing/dimming level is in the neutral position</p>  <p style="text-align: right; font-size: small;">JSNIA0010GB</p>
15 (Y)	Ground	ACC indicator lamp	Output	Ignition switch	OFF or ON	Battery voltage
					ACC	0 V

BCM (BODY CONTROL MODULE)

< ECU DIAGNOSIS >

[HALOGEN TYPE]

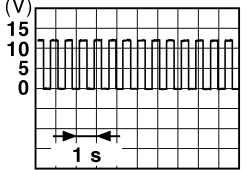
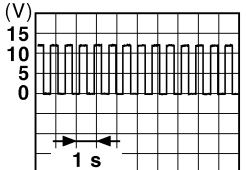
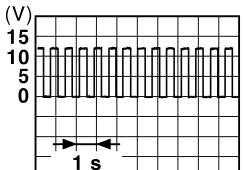
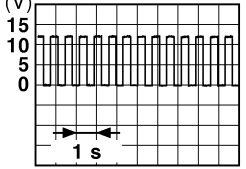
Terminal No. (Wire color)		Description		Condition	Value (Approx.)	
+	-	Signal name	Input/ Output			
17 (W)	Ground	Turn signal RH (Front)	Output	Ignition switch ON	Turn signal switch OFF	0 V
					Turn signal switch RH	 <p style="text-align: right; font-size: small;">PKID0926E</p>
18 (O)	Ground	Turn signal LH (Front)	Output	Ignition switch ON	Turn signal switch OFF	0 V
					Turn signal switch LH	 <p style="text-align: right; font-size: small;">PKID0926E</p>
19 (V)	Ground	Room lamp timer control	Output	Interior room lamp	OFF	Battery voltage
					ON	0 V
20 (V)	Ground	Turn signal RH (Rear)	Output	Ignition switch ON	Turn signal switch OFF	0 V
					Turn signal switch RH	 <p style="text-align: right; font-size: small;">PKID0926E</p>
23 (G)	Ground	Back door opening	Output	Back door	OPEN (Back door opener actuator is activated)	Battery voltage
					Other than OPEN (Back door opener actuator is not activated)	0 V
25 (G)	Ground	Turn signal LH (Rear)	Output	Ignition switch ON	Turn signal switch OFF	0 V
					Turn signal switch LH	 <p style="text-align: right; font-size: small;">PKID0926E</p>
26 (G)	Ground	Rear wiper	Output	Rear wiper	OFF (Stopped)	0 V
					ON (Operated)	Battery voltage

A
B
C
D
E
F
G
H
I
J
K
M
N
O
P

EXL

BCM (BODY CONTROL MODULE)

< ECU DIAGNOSIS >

[HALOGEN TYPE]

Terminal No. (Wire color)		Description		Condition	Value (Approx.)
+	-	Signal name	Input/ Output		
34 (SB)	Ground	Luggage room antenna 1 (-)	Output	Ignition switch OFF	<p>JMKIA0062GB</p>
				When Intelligent Key is not in the passenger compartment	<p>JMKIA0063GB</p>
35 (V)	Ground	Luggage room antenna 1 (+)	Output	Ignition switch OFF	<p>JMKIA0062GB</p>
				When Intelligent Key is not in the passenger compartment	<p>JMKIA0063GB</p>
38 (B)	Ground	Rear bumper antenna (-)	Output	When the back door request switch is operated with ignition switch OFF	<p>JMKIA0062GB</p>
				When Intelligent Key is not in the antenna detection area	<p>JMKIA0063GB</p>

BCM (BODY CONTROL MODULE)

< ECU DIAGNOSIS >

[HALOGEN TYPE]

Terminal No. (Wire color)		Description		Condition	Value (Approx.)	
		Signal name	Input/ Output			
+	-					
39 (W)	Ground	Rear bumper antenna (+)	Output	When the back door request switch is operated with ignition switch OFF	When Intelligent Key is in the antenna detection area	<p style="text-align: right; font-size: small;">JMKIA0062GB</p>
				When Intelligent Key is not in the antenna detection area	<p style="text-align: right; font-size: small;">JMKIA0063GB</p>	
47 (Y)	Ground	Ignition relay (IPDM E/R) control	Output	Ignition switch	OFF or ACC	Battery voltage
					ON	0 V
52 (SB)	Ground	Starter relay control	Output	Ignition switch ON	When selector lever is in P or N position	Battery voltage
					When selector lever is not in P or N position	0 V
61 (W)	Ground	Back door opener request switch	Input	Back door request switch	ON (Pressed)	0 V
					OFF (Not pressed)	<p style="text-align: right; font-size: small;">JPMIA0016GB</p> <p style="text-align: center;">1.0 V</p>
64 (V)	Ground	Request switch buzzer	Output	Request switch buzzer	Sounding	0 V
					Not sounding	Battery voltage
65 (O)	Ground	Rear wiper stop position	Input	Rear wiper	In stop position	<p style="text-align: right; font-size: small;">JPMIA0016GB</p> <p style="text-align: center;">1.0 V</p>
					Not in stop position	0 V

A
B
C
D
E
F
G
H
I
J
K
M
N
O
P

EXL

BCM (BODY CONTROL MODULE)

< ECU DIAGNOSIS >

[HALOGEN TYPE]

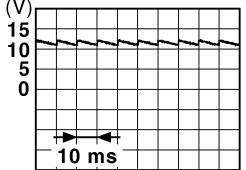
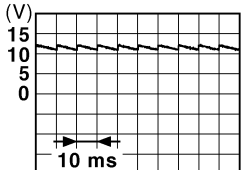
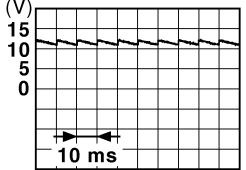
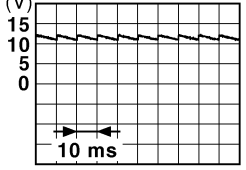
Terminal No. (Wire color)		Description		Condition	Value (Approx.)	
		Signal name	Input/ Output			
+	-					
66 (R)	Ground	Back door switch	Input	Back door switch	OFF (Door close)	 <small>JPMIA0011GB</small> 11.8 V
					ON (Door open)	0 V
67 (GR)	Ground	Back door opener switch	Input	Back door opener switch	Pressed	0 V
					Not pressed	 <small>JPMIA0011GB</small> 11.8 V
68 (BR)	Ground	Rear RH door switch	Input	Rear RH door switch	OFF (Door close)	 <small>JPMIA0011GB</small> 11.8 V
					ON (Door open)	0 V
69 (R)	Ground	Rear LH door switch	Input	Rear LH door switch	OFF (Door close)	 <small>JPMIA0011GB</small> 11.8 V
					ON (Door open)	0 V

BCM (BODY CONTROL MODULE)

< ECU DIAGNOSIS >

[HALOGEN TYPE]

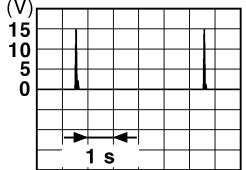
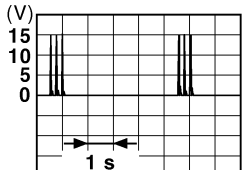
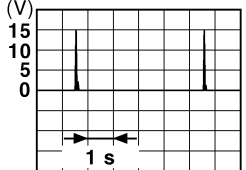
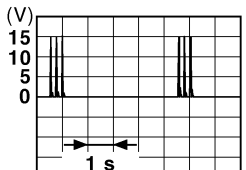
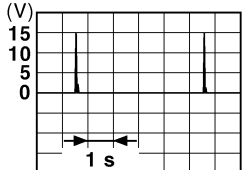
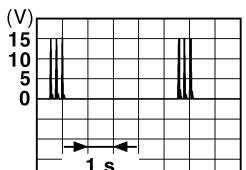
Terminal No. (Wire color)		Description		Condition	Value (Approx.)
		Signal name	Input/ Output		
+	-				
72 (R)	Ground	Room antenna 2 (-) (Center console)	Output	Ignition switch OFF	 <p style="text-align: right; font-size: small;">JMKIA0062GB</p>
				When Intelligent Key is not in the passenger compart- ment	 <p style="text-align: right; font-size: small;">JMKIA0063GB</p>
73 (G)	Ground	Room antenna 2 (+) (Center console)	Output	Ignition switch OFF	 <p style="text-align: right; font-size: small;">JMKIA0062GB</p>
				When Intelligent Key is not in the passenger compart- ment	 <p style="text-align: right; font-size: small;">JMKIA0063GB</p>
74 (SB)	Ground	Passenger door an- tenna (-)	Output	When the pas- senger door re- quest switch is operated with ig- nition switch OFF	 <p style="text-align: right; font-size: small;">JMKIA0062GB</p>
				When Intelligent Key is not in the antenna detec- tion area	 <p style="text-align: right; font-size: small;">JMKIA0063GB</p>

A
B
C
D
E
F
G
H
I
J
K
EXL
M
N
O
P

BCM (BODY CONTROL MODULE)

< ECU DIAGNOSIS >

[HALOGEN TYPE]

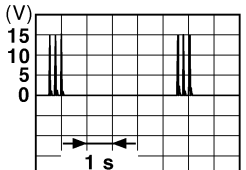
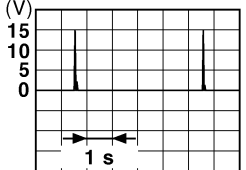
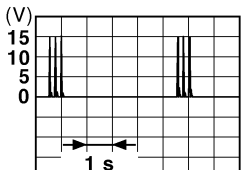
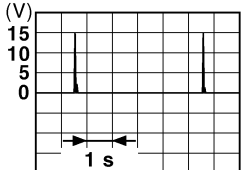
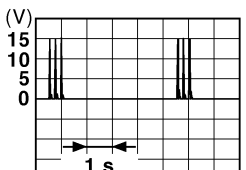
Terminal No. (Wire color)		Description		Condition	Value (Approx.)
+	-	Signal name	Input/ Output		
75 (GR)	Ground	Passenger door antenna (+)	Output		
				When the passenger door request switch is operated with ignition switch OFF	 <p style="text-align: right; font-size: small;">JMKIA0063GB</p>
76 (V)	Ground	Driver door antenna (-)	Output	When Intelligent Key is in the antenna detection area	 <p style="text-align: right; font-size: small;">JMKIA0062GB</p>
				When the driver door request switch is operated with ignition switch OFF	 <p style="text-align: right; font-size: small;">JMKIA0063GB</p>
77 (LG)	Ground	Driver door antenna (+)	Output	When Intelligent Key is in the antenna detection area	 <p style="text-align: right; font-size: small;">JMKIA0062GB</p>
				When the driver door request switch is operated with ignition switch OFF	 <p style="text-align: right; font-size: small;">JMKIA0063GB</p>

BCM (BODY CONTROL MODULE)

< ECU DIAGNOSIS >

[HALOGEN TYPE]

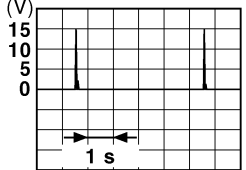
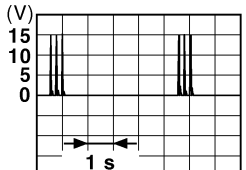
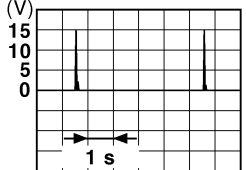
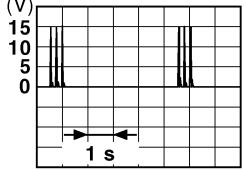
Terminal No. (Wire color)		Description		Condition	Value (Approx.)	
+	-	Signal name	Input/ Output			
78 (Y)	Ground	Room antenna (-) (Instrument panel)	Output	Ignition switch OFF	When Intelligent Key is in the passenger compart- ment 	
				Ignition switch OFF	When Intelligent Key is not in the passenger compart- ment 	
79 (BR)	Ground	Room antenna (+) (Instrument panel)	Output	Ignition switch OFF	When Intelligent Key is in the passenger compart- ment 	
				Ignition switch OFF	When Intelligent Key is not in the passenger compart- ment 	
80 (GR)	Ground	NATS antenna amp (Built in key slot)	Input/ Output	During waiting	Ignition switch is pressed while inserting the key into the key slot.	Just after pressing ignition switch. Pointer of tester should move.
81 (W)	Ground	NATS antenna amp (Built in key slot)	Input/ Output	During waiting	Ignition switch is pressed while inserting the key into the key slot.	Just after pressing ignition switch. Pointer of tester should move.
82 (R)	Ground	Ignition relay [Fuse block (J/B)] control	Output	Ignition switch	OFF or ACC	0 V
				Ignition switch	ON	Battery voltage





A
B
C
D
E
F
G
H
I
J
K
L
M
N
O
P

EXL

BCM (BODY CONTROL MODULE)

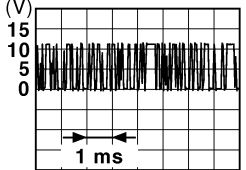
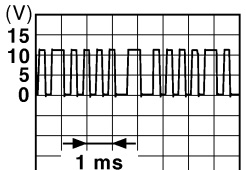
< ECU DIAGNOSIS >

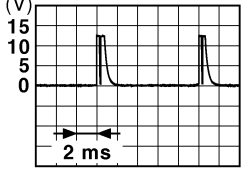

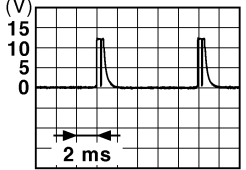
[HALOGEN TYPE]

Terminal No. (Wire color)		Description		Condition	Value (Approx.)	
+	-	Signal name	Input/ Output			
83 (Y)	Ground	Remote keyless entry receiver signal	Input/ Output	During waiting	 <small>JMKIA0064GB</small>	
				When operating either button on the key	 <small>JMKIA0065GB</small>	
87 (BR)	Ground	Combination switch INPUT 5	Input	Combination switch	All switch OFF (Wiper intermittent dial 4)	 <small>JPMIA0041GB</small> 1.4 V
					Front fog lamp switch ON (Wiper intermittent dial 4)	 <small>JPMIA0037GB</small> 1.3 V
					Rear wiper switch ON (Wiper intermittent dial 4)	 <small>JPMIA0039GB</small> 1.3 V
					Any of the conditions below with all switch OFF <ul style="list-style-type: none"> • Wiper intermittent dial 1 • Wiper intermittent dial 2 • Wiper intermittent dial 6 • Wiper intermittent dial 7 	 <small>JPMIA0040GB</small> 1.3 V

BCM (BODY CONTROL MODULE)

< ECU DIAGNOSIS >

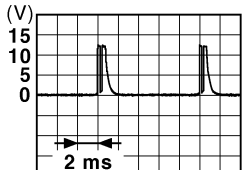
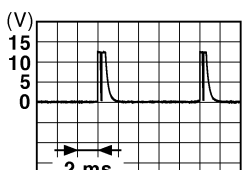
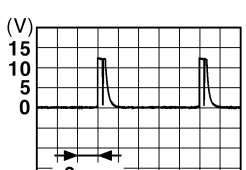
[HALOGEN TYPE]

Terminal No. (Wire color)		Description		Condition	Value (Approx.)	
+	-	Signal name	Input/ Output			
88 (V)	Ground	Combination switch INPUT 3	Input			Combination switch
				Lighting switch HI (Wiper intermittent dial 4)	 <small>JPMIA0036GB</small> 1.3 V	
				Lighting switch 2ND (Wiper intermittent dial 4)	 <small>JPMIA0037GB</small> 1.3 V	
				Rear washer switch ON (Wiper intermittent dial 4)	 <small>JPMIA0039GB</small> 1.3 V	
				Any of the conditions below with all switch OFF • Wiper intermittent dial 1 • Wiper intermittent dial 2 • Wiper intermittent dial 3	 <small>JPMIA0040GB</small> 1.3 V	
89 (BR)	Ground	Push-button ignition switch (Push switch)	Input	Push-button igni- tion switch (push switch)	Pressed	0 V
					Not pressed	Battery voltage
90 (P)	Ground	CAN-L	Input/ Output	—	—	
91 (L)	Ground	CAN-H	Input/ Output	—	—	

A
B
C
D
E
F
G
H
I
J
K
EXL
M
N
O
P

BCM (BODY CONTROL MODULE)

< ECU DIAGNOSIS >

[HALOGEN TYPE]

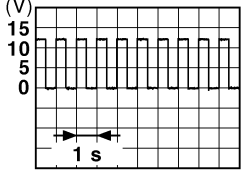
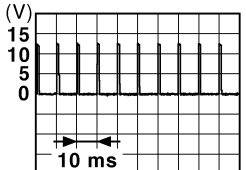
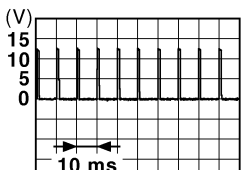
Terminal No. (Wire color)		Description		Condition	Value (Approx.)	
+	-	Signal name	Input/ Output			
92 (LG)	Ground	Key slot illumination	Output	Key slot illumination	OFF	Battery voltage
				Blinking	 <p style="text-align: right; font-size: small;">JPMIA0015GB 6.5 V</p>	
93 (V)	Ground	ON indicator lamp	Output	Ignition switch	OFF or ACC	Battery voltage
				ON	0 V	
94 (Y)	Ground	Puddle lamp control	Output	Puddle lamp	OFF	Battery voltage
				ON	0 V	
95 (O)	Ground	ACC relay control	Output	Ignition switch	OFF	0 V
				ACC or ON	Battery voltage	
96 (GR)	Ground	Control device (Detention switch) power supply	Output	—	Battery voltage	
97 (L)	Ground	Steering lock condition No. 1	Input	Steering lock	LOCK status	0 V
				UNLOCK status	Battery voltage	
98 (P)	Ground	Steering lock condition No. 2	Input	Steering lock	LOCK status	Battery voltage
				UNLOCK status	0 V	
99 (R)	Ground	Selector lever P position switch	Input	Selector lever	P position	0 V
				Any position other than P	Battery voltage	
100 (G)	Ground	Passenger door request switch	Input	Passenger door request switch	ON (Pressed)	0 V
				OFF (Not pressed)	 <p style="text-align: right; font-size: small;">JPMIA0016GB 1.0 V</p>	
101 (SB)	Ground	Driver door request switch	Input	Driver door request switch	ON (Pressed)	0 V
				OFF (Not pressed)	 <p style="text-align: right; font-size: small;">JPMIA0016GB 1.0 V</p>	
102 (O)	Ground	Blower fan motor relay control	Output	Ignition switch	OFF or ACC	0 V
				ON	Battery voltage	

BCM (BODY CONTROL MODULE)

< ECU DIAGNOSIS >

[HALOGEN TYPE]

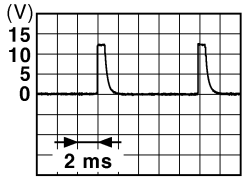
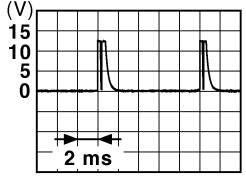
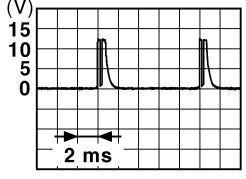
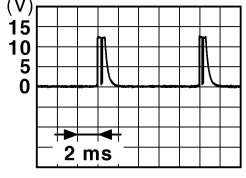
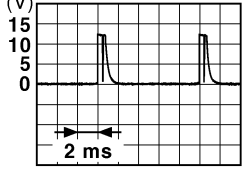
Terminal No. (Wire color)		Description		Condition		Value (Approx.)
+	-	Signal name	Input/ Output			
103 (LG)	Ground	Remote keyless entry receiver power supply	Output	Ignition switch OFF		Battery voltage
106 (W)	Ground	Steering wheel lock unit power supply	Output	Ignition switch	OFF or ACC	Battery voltage
					ON	0 V
107 (LG)	Ground	Combination switch INPUT 1	Input	Combination switch (Wiper intermittent dial 4)	All switch OFF	 <p style="text-align: right; margin-right: 20px;">1.4 V</p>
					Turn signal switch LH	 <p style="text-align: right; margin-right: 20px;">1.3 V</p>
					Turn signal switch RH	 <p style="text-align: right; margin-right: 20px;">1.3 V</p>
					Front wiper switch LO	 <p style="text-align: right; margin-right: 20px;">1.3 V</p>
					Front washer switch ON	 <p style="text-align: right; margin-right: 20px;">1.3 V</p>

A
B
C
D
E
F
G
H
I
J
K
EXL
M
N
O
P

BCM (BODY CONTROL MODULE)

< ECU DIAGNOSIS >



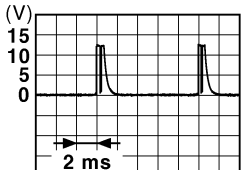
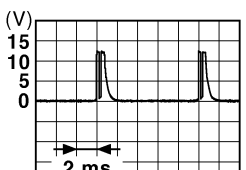
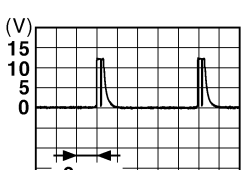
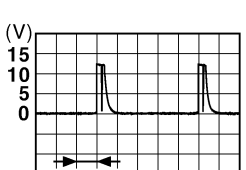

[HALOGEN TYPE]

Terminal No. (Wire color)		Description		Condition	Value (Approx.)
+	-	Signal name	Input/ Output		
108 (R)	Ground	Combination switch INPUT 4	Input		
All switch OFF (Wiper intermittent dial 4)					<div style="display: flex; flex-direction: column; align-items: center;">  <p style="font-size: small; margin-top: 5px;">JPMIA0038GB</p> <p style="margin-top: 5px;">1.3 V</p> </div>
Lighting switch AUTO (Wiper intermittent dial 4)					<div style="display: flex; flex-direction: column; align-items: center;">  <p style="font-size: small; margin-top: 5px;">JPMIA0036GB</p> <p style="margin-top: 5px;">1.3 V</p> </div>
Lighting switch 1ST (Wiper intermittent dial 4)					<div style="display: flex; flex-direction: column; align-items: center;">  <p style="font-size: small; margin-top: 5px;">JPMIA0040GB</p> <p style="margin-top: 5px;">1.3 V</p> </div>
Rear wiper switch INT (Wiper intermittent dial 4)					<div style="display: flex; flex-direction: column; align-items: center;">  <p style="font-size: small; margin-top: 5px;">JPMIA0039GB</p> <p style="margin-top: 5px;">1.3 V</p> </div>
Any of the conditions below with all switch OFF					<ul style="list-style-type: none"> • Wiper intermittent dial 1 • Wiper intermittent dial 5 • Wiper intermittent dial 6

BCM (BODY CONTROL MODULE)

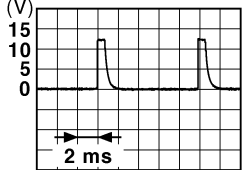
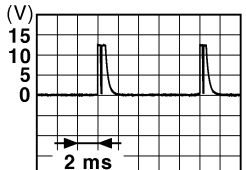
< ECU DIAGNOSIS >

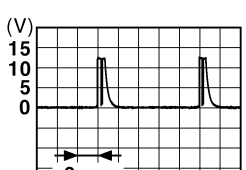
[HALOGEN TYPE]

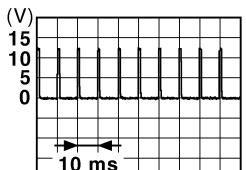
Terminal No. (Wire color)		Description		Condition	Value (Approx.)	
+	-	Signal name	Input/ Output			
109 (Y)	Ground	Combination switch INPUT 2	Input	Combination switch (Wiper intermittent dial 4)	All switch OFF	 1.4 V
					Lighting switch PASS	 1.3 V
					Lighting switch 2ND	 1.3 V
					Front wiper switch INT	 1.3 V
					Front wiper switch HI	 1.3 V
					ON	0 V
110 (G)	Ground	Hazard switch	Input	Hazard switch	OFF	 1.1 V

A
B
C
D
E
F
G
H
I
J
K
M
N
O
P

EXL

BCM (BODY CONTROL MODULE)

[HALOGEN TYPE]

< ECU DIAGNOSIS >

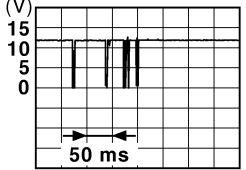
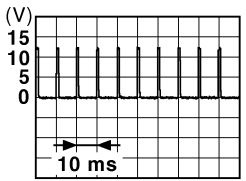
Terminal No. (Wire color)		Description		Condition	Value (Approx.)	
		Signal name	Input/ Output			
+	-					
111 (Y)	Ground	Steering lock unit communication	Input/ Output	Steering lock	LOCK status	Battery voltage
					LOCK or UNLOCK	 <p style="text-align: right; font-size: small;">JMkia0066GB</p>
					For 15 seconds after UNLOCK	Battery voltage
					15 seconds or later after UNLOCK	0 V
113* (P)	Ground	Optical sensor signal	Input	Ignition switch ON	When bright outside of the vehicle	Close to 5 V
					When dark outside of the vehicle	Close to 0 V
116 (SB)	Ground	Fuse check [Stop lamp switch, ICC brake hold relay (With ICC)]	Input	—	Battery voltage	
118 (P)	Ground	Stop lamp switch (Without ICC)	Input	Stop lamp switch	OFF (Brake pedal is not depressed)	0 V
					ON (Brake pedal is depressed)	Battery voltage
		Stop lamp switch and ICC brake hold relay (With ICC)		Stop lamp switch OFF (Brake pedal is not depressed) and ICC brake hold relay OFF	0 V	
				Stop lamp switch ON (Brake pedal is depressed) or ICC brake hold relay ON	Battery voltage	
119 (SB)	Ground	Front door lock assembly driver side (unlock sensor)	Input	Driver door	LOCK status (Unlock sensor switch OFF)	 <p style="text-align: right; font-size: small;">JPMIA0012GB</p>
					UNLOCK status (Unlock switch sensor ON)	0 V
121 (BR)	Ground	Key slot switch	Input	When the key is inserted into key slot	Battery voltage	
				When the key is not inserted into key slot	0 V	
122 (V)	Ground	ACC feedback signal	Input	Ignition switch	OFF	0 V
					ACC or ON	Battery voltage
123 (W)	Ground	IGN feedback signal	Input	Ignition switch	OFF or ACC	0 V
					ON	Battery voltage

BCM (BODY CONTROL MODULE)

< ECU DIAGNOSIS >

[HALOGEN TYPE]

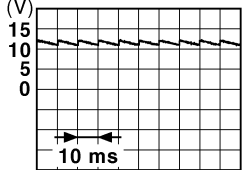
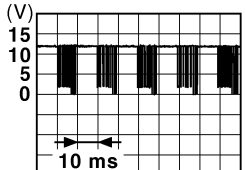
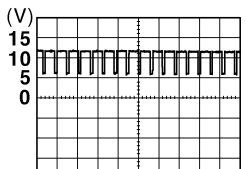

Terminal No. (Wire color)		Description		Condition	Value (Approx.)	
		Signal name	Input/ Output			
+	-					
124 (LG)	Ground	Passenger door switch	Input	Passenger door switch	OFF (Door close)	 <small>JPMIA0011GB</small> 11.8 V
					ON (Door open)	0 V
132 (V)	Ground	Power window switch communication	Input/ Output	Ignition switch ON	 <small>JPMIA0013GB</small> 10.2 V	
				Ignition switch OFF or ACC	Battery voltage	
133 (W)	Ground	Push-button ignition switch illumination	Output	Push-button igni- tion switch illumina- tion	ON (Tail lamps OFF)	9.5 V
					ON (Tail lamps ON)	NOTE: The pulse width of this wave is varied by the illumination bright- ening/dimming level.  <small>JPMIA0159GB</small>
				OFF	0 V	
134 (GR)	Ground	LOCK indicator lamp	Output	LOCK indicator lamp	OFF	Battery voltage
					ON	0 V
137 (O)	Ground	Receiver and sensor ground	Input	Ignition switch ON	0 V	
138 (Y)	Ground	Sensor power supply	Output	Ignition switch	OFF	0 V
					ACC or ON	5.0 V

A
B
C
D
E
F
G
H
I
J
K
EXL
M
N
O
P

BCM (BODY CONTROL MODULE)

[HALOGEN TYPE]

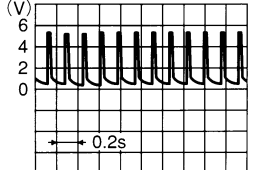
< ECU DIAGNOSIS >

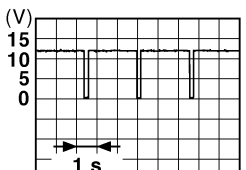
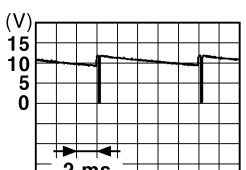
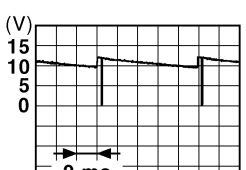
Terminal No. (Wire color)		Description		Condition	Value (Approx.)	
		Signal name	Input/ Output			
+	-					
139 (L)	Ground	Tire pressure receiver signal	Input/ Output	Ignition switch ON	Standby state	 <small>OCC3881D</small>
				When receiving the signal from the transmitter	 <small>OCC3880D</small>	
140 (GR)	Ground	Selector lever P/N position signal	Input	Selector lever	P or N position	Battery voltage
				Except P and N positions	0 V	
141 (G)	Ground	Security indicator signal	Output	Security indicator	ON	0 V
				Blinking	 <small>JPMIA0014GB</small> 11.3 V	
				OFF	Battery voltage	
142 (O)	Ground	Combination switch OUTPUT 5	Output	Combination switch (Wiper intermittent dial 4)	All switch OFF	0 V
				Lighting switch 1ST	 <small>JPMIA0031GB</small> 10.7 V	
				Lighting switch HI		
				Lighting switch 2ND		
Turn signal switch RH	Turn signal switch RH	Turn signal switch RH				
143 (P)	Ground	Combination switch OUTPUT 1	Output	Combination switch	All switch OFF (Wiper intermittent dial 4)	0 V
				Front wiper switch HI (Wiper intermittent dial 4)	 <small>JPMIA0032GB</small> 10.7 V	
				Rear wiper switch INT (Wiper intermittent dial 4)		
				Any of the conditions below with all switch OFF		
<ul style="list-style-type: none"> • Wiper intermittent dial 1 • Wiper intermittent dial 2 • Wiper intermittent dial 3 • Wiper intermittent dial 6 • Wiper intermittent dial 7 	Any of the conditions below with all switch OFF	Any of the conditions below with all switch OFF				

BCM (BODY CONTROL MODULE)

< ECU DIAGNOSIS >

[HALOGEN TYPE]

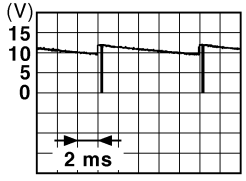
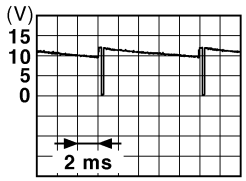
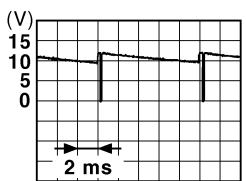
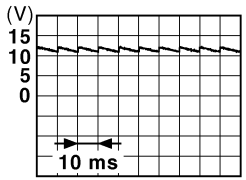
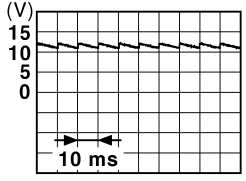
Terminal No. (Wire color)		Description		Condition	Value (Approx.)		
		Signal name	Input/ Output				
+	-						
144 (G)	Ground	Combination switch OUTPUT 2	Output	Combination switch	All switch OFF (Wiper intermittent dial 4)	0 V	
					Front washer switch ON (Wiper intermittent dial 4)		
					Rear wiper switch ON (Wiper intermittent dial 4)		
					Rear washer switch ON (Wiper intermittent dial 4)		
					Any of the conditions below with all switch OFF <ul style="list-style-type: none"> • Wiper intermittent dial 1 • Wiper intermittent dial 5 • Wiper intermittent dial 6 		10.7 V
145 (L)	Ground	Combination switch OUTPUT 3	Output	Combination switch (Wiper intermit- tent dial 4)	All switch OFF	0 V	
					Front wiper switch INT		
					Front wiper switch LO		
					Lighting switch AUTO		10.7 V
146 (SB)	Ground	Combination switch OUTPUT 4	Output	Combination switch (Wiper intermit- tent dial 4)	All switch OFF	0 V	
					Front fog lamp switch ON		
					Lighting switch 2ND		
					Lighting switch PASS		
				Turn signal switch LH	10.7 V		
149 (W)	Ground	Tire pressure warn- ing check switch	Input	Ignition switch ON		11.8 V	
150 (LG)	Ground	Driver door switch	Input	Driver door switch	OFF (Door close)		11.8 V
					ON (Door open)	0 V	
151 (G)	Ground	Rear window defog- ger relay	Output	Rear window de- fogger	Active	0 V	
					Not activated	Battery voltage	

A
B
C
D
E
F
G
H
I
J
K
EXL
M
N
O
P

BCM (BODY CONTROL MODULE)

[HALOGEN TYPE]

< ECU DIAGNOSIS >

NOTE:

*: With auto light system

Wiring Diagram - BCM -

INFOID:000000003784725

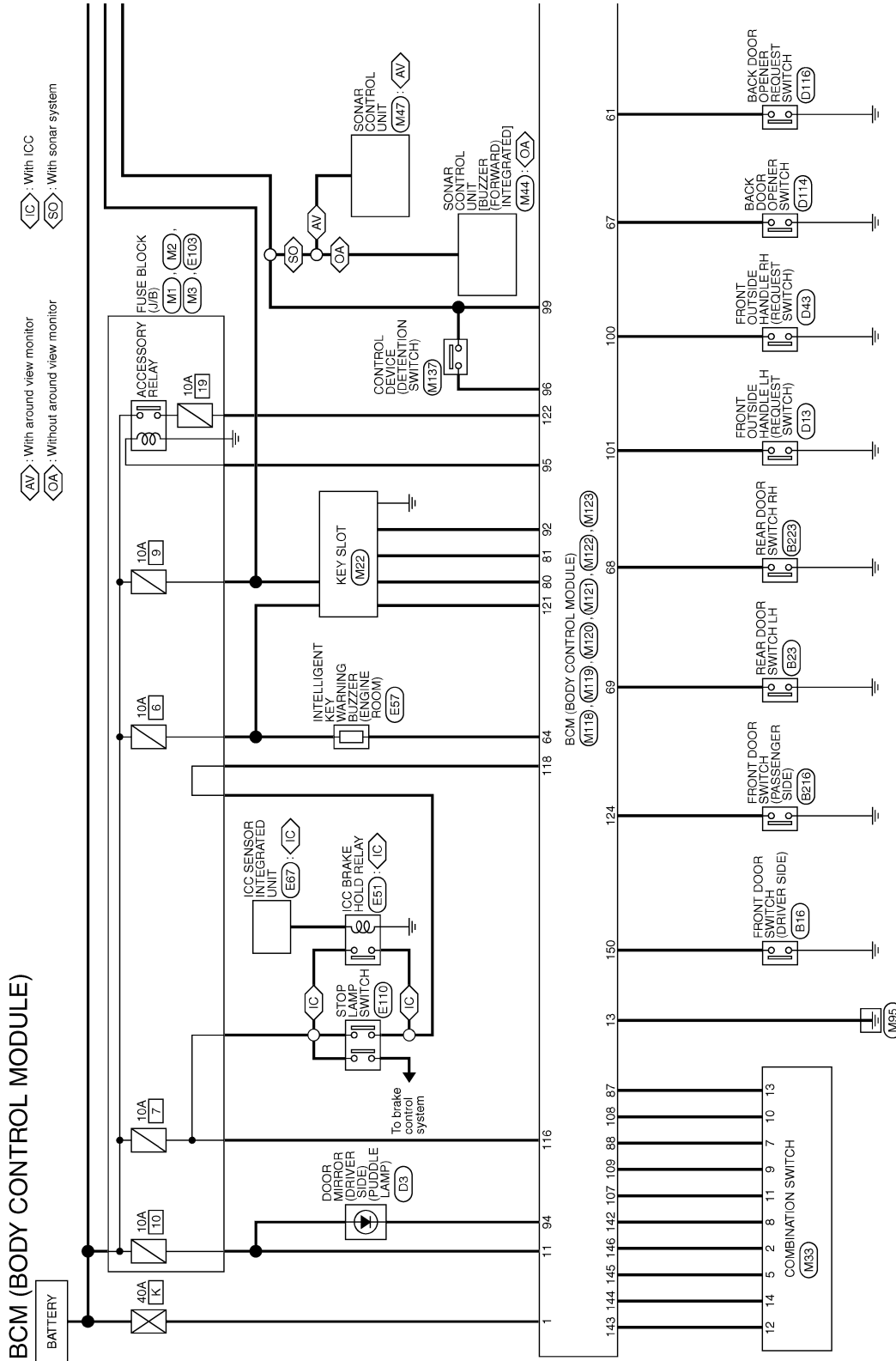

2007/10/26
JCMWM1398G

BCM (BODY CONTROL MODULE)

< ECU DIAGNOSIS >

[HALOGEN TYPE]

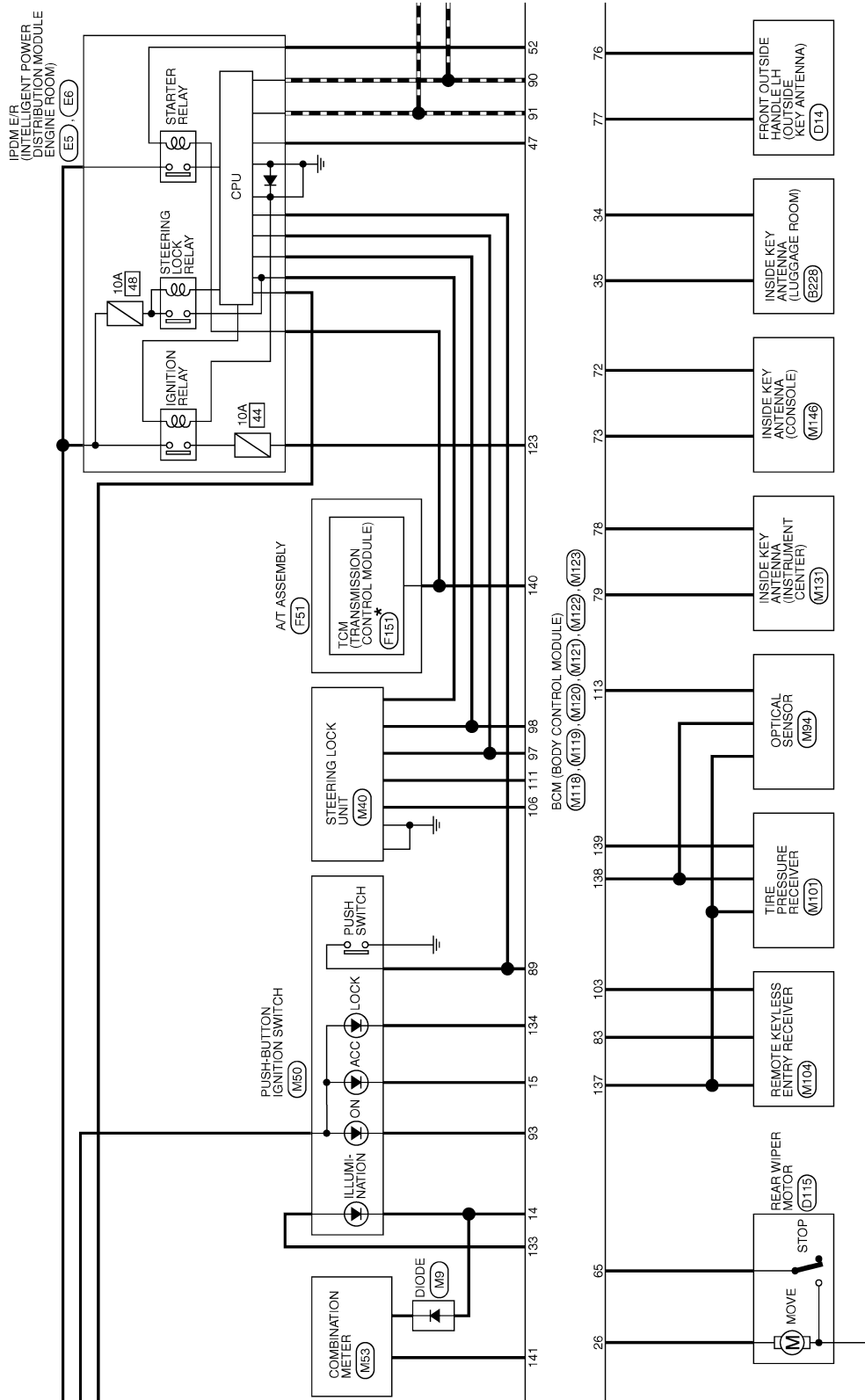

*: This connector is not shown in "Harness Layout".

JCMWM1399GI

A
B
C
D
E
F
G
H
I
J
K
EXL
M
N
O
P

BCM (BODY CONTROL MODULE)

< ECU DIAGNOSIS >

[HALOGEN TYPE]

- ◊NV◊ : With NAVI
- ◊ON◊ : Without NAVI
- ◊RF◊ : With sunroof
- ◊PM◊ : With automatic drive positioner
- ◊OP◊ : Without automatic drive positioner

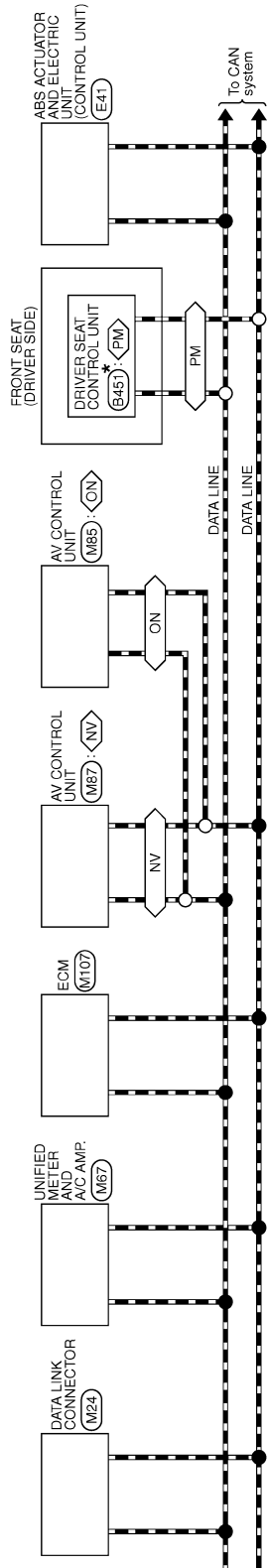

BCM (BODY CONTROL MODULE)
 (M11B) (M119) (M120) (M121) (M122) (M123)

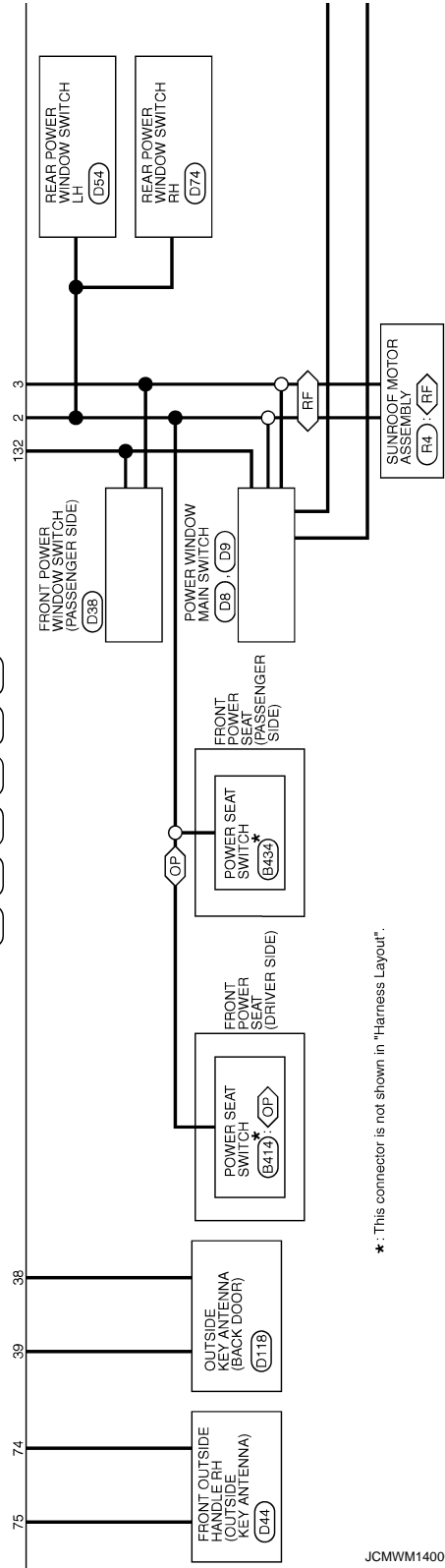

* : This connector is not shown in "Harness Layout".

JCMWM1400G

BCM (BODY CONTROL MODULE)

< ECU DIAGNOSIS >

[HALOGEN TYPE]

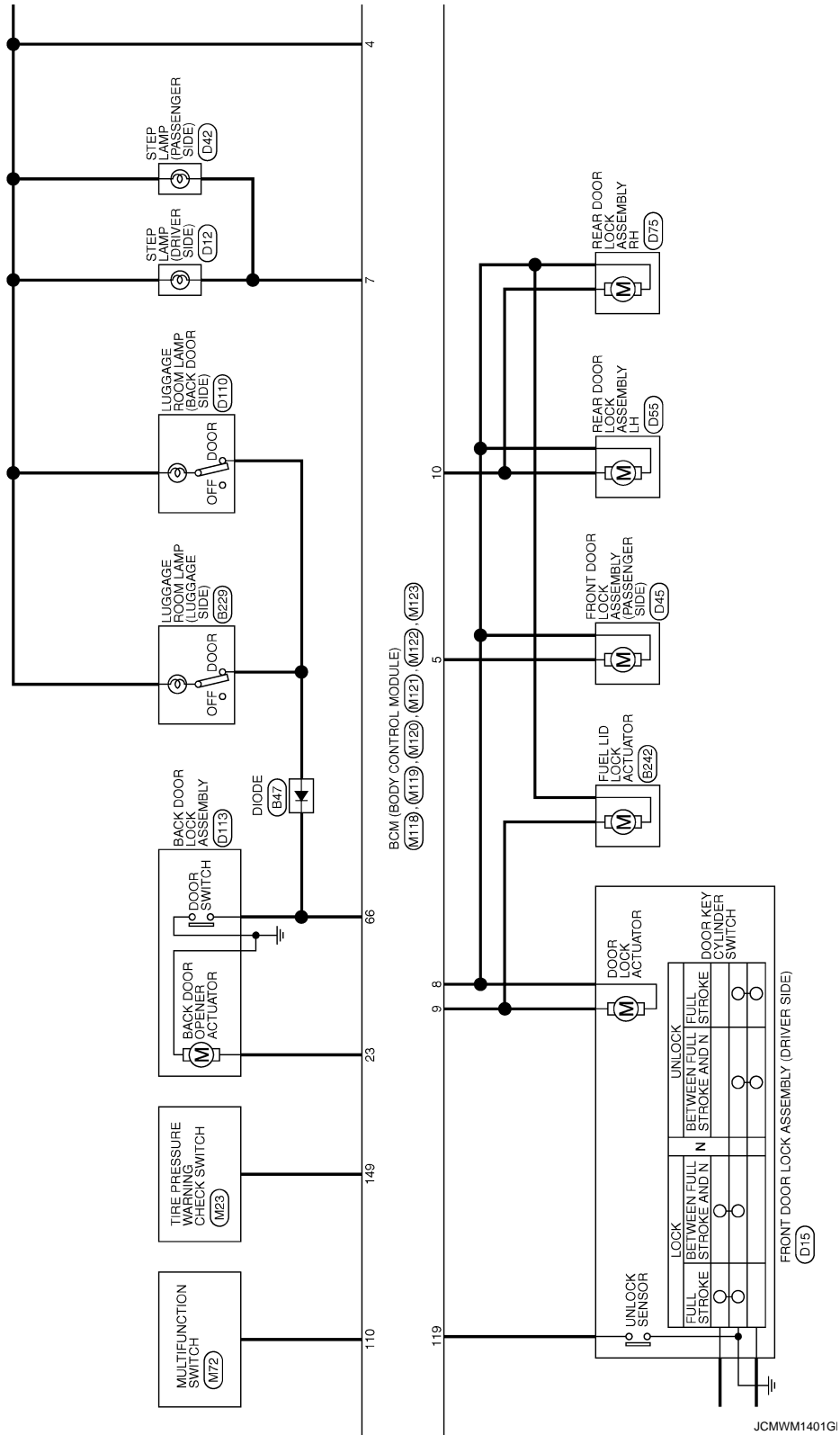

A
B
C
D
E
F
G
H
I
J
K
EXL
M
N
O
P

BCM (BODY CONTROL MODULE)

< ECU DIAGNOSIS >

[HALOGEN TYPE]

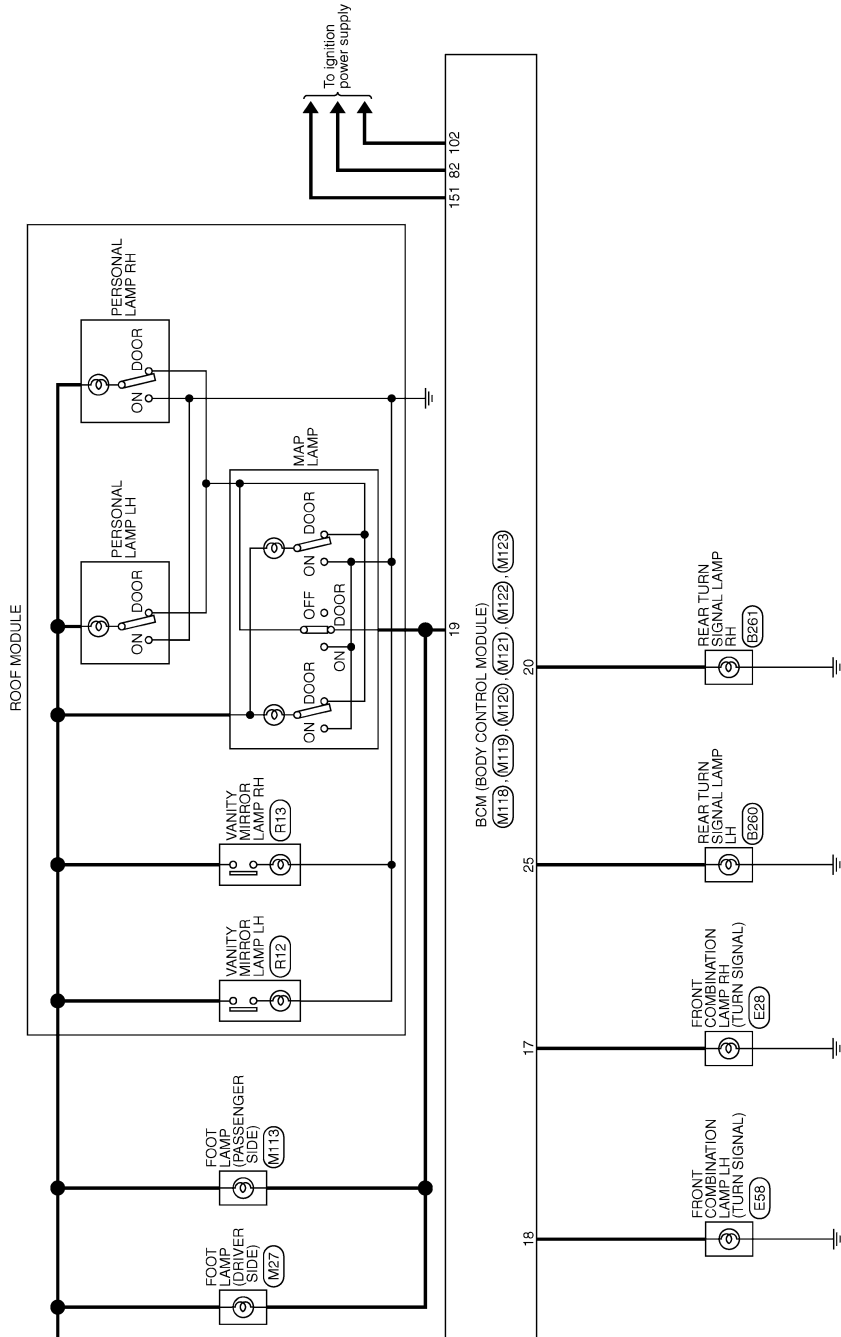

JCMWM1402G

BCM (BODY CONTROL MODULE)

< ECU DIAGNOSIS >

[HALOGEN TYPE]

BCM (BODY CONTROL MODULE)

Connector No.	M33
Connector Name	COMBINATION SWITCH
Connector Type	TH16FW-NH

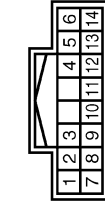

Terminal No.	Color of Wire	Signal Name [Specification]
2	SB	OUTPUT 4
5	L	OUTPUT 3
7	V	INPUT 3
8	O	OUTPUT 5
9	Y	INPUT 2
10	R	INPUT 4
11	LG	INPUT 1
12	P	OUTPUT 1
13	BR	INPUT 5
14	G	OUTPUT 2

Connector No.	M120
Connector Name	BCM (BODY CONTROL MODULE)
Connector Type	NS12FW-CS

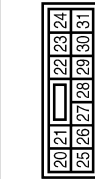

Terminal No.	Color of Wire	Signal Name [Specification]
20	V	TURN SIGNAL RH (REAR)
23	G	BACK DOOR OPEN OUTPUT
25	G	TURN SIGNAL LH (REAR)
26	G	REAR WIPER OUTPUT

Connector No.	M118
Connector Name	BCM (BODY CONTROL MODULE)
Connector Type	M33FB-LC



Terminal No.	Color of Wire	Signal Name [Specification]
1	W	BAT (F/L)
2	Y	POWER WINDOW POWER SUPPLY(BAT)
3	O	POWER WINDOW POWER SUPPLY(RAP)

Connector No.	M121
Connector Name	BCM (BODY CONTROL MODULE)
Connector Type	TH40FGY-NH

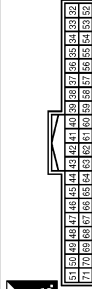

Terminal No.	Color of Wire	Signal Name [Specification]
34	SB	LUGGAGE ROOM ANTI-
35	V	LUGGAGE ROOM ANTI+
38	B	REAR BUMPER ANTI-
39	W	REAR BUMPER ANTI+
47	Y	IGN RELAY (PDM L/R CONT)
52	SB	STARTER RELAY CONT
61	W	BACK DOOR OPENER REQUEST SW
64	V	REQUEST SW BUZZER
65	O	REAR WIPER STOP POSITION
66	R	BACK DOOR SW
67	GR	BACK DOOR OPENER SW

Connector No.	M119
Connector Name	BCM (BODY CONTROL MODULE)
Connector Type	NS18FW-CS

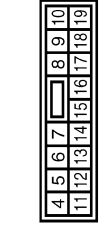

Terminal No.	Color of Wire	Signal Name [Specification]
4	LG	INTERIOR ROOM LAMP POWER SUPPLY
5	L	PASSSENGER DOOR UNLOCK OUTPUT
7	Y	STEP LAMP OUTPUT
8	V	ALL DOOR FUEL LID LOCK OUTPUT
9	G	DRIVER DOOR UNLOCK OUTPUT
10	BR	REAR DOOR UNLOCK OUTPUT
11	R	BAT (RUSE)
13	B	GND
14	W	PUSH-BUTTON IGNITION SW ILL GND
15	Y	ACC IND
17	W	TURN SIGNAL RH (FRONT)

68	BR	REAR RH DOOR SW
69	R	REAR LH DOOR SW

18	O	TURN SIGNAL LH (FRONT)
19	V	ROOM LAMP TIMER CONTROL

A
B
C
D
E
F
G
H
I
J
K
EXL
M
N
O
P

BCM (BODY CONTROL MODULE)

< ECU DIAGNOSIS >

[HALOGEN TYPE]

BCM (BODY CONTROL MODULE)

Connector No.	M122
Connector Name	BCM (BODY CONTROL MODULE)
Connector Type	TH40FB-NH



18	19	20	21	22	23	24	25	26	27	28	29	30	31	32	33	34	35	36	37	38	39	40	41	42	43	44	45	46	47	48	49	50	51	52	53	54	55	56	57	58	59	60	61	62	63	64	65	66	67	68	69	70	71	72	73	74	75	76	77	78	79	80	81	82
----	----	----	----	----	----	----	----	----	----	----	----	----	----	----	----	----	----	----	----	----	----	----	----	----	----	----	----	----	----	----	----	----	----	----	----	----	----	----	----	----	----	----	----	----	----	----	----	----	----	----	----	----	----	----	----	----	----	----	----	----	----	----	----	----

Terminal No.	Color of Wire	Signal Name [Specification]
72	R	ROOM ANT2-
73	G	ROOM ANT2+
74	SB	PASSENGER DOOR ANT-
75	GR	PASSENGER DOOR ANT+
76	V	DRIVER DOOR ANT-
77	LG	DRIVER DOOR ANT+
78	Y	ROOM ANT1-
79	BR	ROOM ANT1+
80	GR	IMMOBI ANTENNA CONTROL
81	W	IMMOBI ANTENNA SIGNAL
82	R	IGN RELAY (F/B) CONT

83	Y	KEYLESS TUNER SIGNAL
87	BR	COMBI SW INPUT 5
88	V	COMBI SW INPUT 3
89	BR	PUSH SW
90	P	CAN-L
91	L	CAN-H
92	LG	KEY SLOT ILL
93	Y	ON IND
94	V	PUDDLE LAMP CONT
95	O	ACC RELAY CONT
96	GR	A/T DEVICE POWER SUPPLY
97	L	S/L CONDITION 1
98	P	S/L CONDITION 2
99	R	SHIFT P
100	G	PASSENGER DOOR REQUEST SW
101	SB	DRIVER DOOR REQUEST SW
102	O	BLOWER FAN MOTOR RELAY CONT
103	LG	KEYLESS ENTRY RECEIVER POWER SUPPLY
106	W	S/L POWER SUPPLY
107	LG	COMBI SW INPUT 1
108	R	COMBI SW INPUT 4
109	Y	COMBI SW INPUT 2
110	G	HAZARD SW
111	Y	S/L COMM

Connector No.	M123
Connector Name	BCM (BODY CONTROL MODULE)
Connector Type	TH40FG-NH



112	113	114	115	116	117	118	119	120	121	122	123	124	125	126	127	128	129	130	131	132	133	134	135	136	137	138	139	140	141	142	143	144	145	146	147	148	149	150	151
-----	-----	-----	-----	-----	-----	-----	-----	-----	-----	-----	-----	-----	-----	-----	-----	-----	-----	-----	-----	-----	-----	-----	-----	-----	-----	-----	-----	-----	-----	-----	-----	-----	-----	-----	-----	-----	-----	-----	-----

Terminal No.	Color of Wire	Signal Name [Specification]
113	P	OPTICAL SENSOR
116	SB	FUSE CHECK
118	P	STOP LAMP SW
119	SB	DR DOOR UNLOCK SENSOR
121	BR	KEY SLOT SW
122	V	ACC F/B
123	W	IGN F/B
124	LG	PASSENGER DOOR SW
132	V	POWER WINDOW SW COMM
133	W	PUSH-BUTTON IGNITION SW ILL POWER
134	GR	LOCK IND

137	O	RECEIVER/SENSOR GND
138	Y	RECEIVER/SENSOR POWER SUPPLY
139	L	TIRE PRESS RECEIVER SIGNAL
140	GR	SHIFT UP
141	G	SECURITY INDICATOR OUTPUT
142	O	COMBI SW OUTPUT 5
143	P	COMBI SW OUTPUT 1
144	G	COMBI SW OUTPUT 2
145	L	COMBI SW OUTPUT 3
146	SB	COMBI SW OUTPUT 4
149	W	TIRE PRESS WARNING CHECK SW
150	LG	DRIVER DOOR SW
151	G	REAR WINDOW DEFOGGER RELAY

Fail-safe

FAIL-SAFE CONTROL BY DTC

BCM performs fail-safe control when any DTC is detected.

JCMWM1404G

INFOID:000000003784726

BCM (BODY CONTROL MODULE)

[HALOGEN TYPE]

< ECU DIAGNOSIS >

Display contents of CONSULT	Fail-safe	Cancellation	
B2013: ID DISCORD BCM-S/L	Inhibit engine cranking	Erase DTC	A
B2014: CHAIN OF S/L-BCM	Inhibit engine cranking	Erase DTC	
B2190: NATS ANTENNA AMP	Inhibit engine cranking	Erase DTC	B
B2191: DIFFERENCE OF KEY	Inhibit engine cranking	Erase DTC	
B2192: ID DISCORD BCM-ECM	Inhibit engine cranking	Erase DTC	C
B2193: CHAIN OF BCM-ECM	Inhibit engine cranking	Erase DTC	
B2557: VEHICLE SPEED	Inhibit steering lock	When normal vehicle speed signals have been received from ABS actuator and electric unit (control unit) for 500 ms	D
B2560: STARTER CONT RELAY	Inhibit engine cranking	500 ms after the following CAN signal communication status has become consistent <ul style="list-style-type: none"> • Starter control relay signal • Starter relay status signal 	E
B2601: SHIFT POSITION	Inhibit steering lock	500 ms after the following signal reception status becomes consistent <ul style="list-style-type: none"> • Selector lever P position switch signal • P range signal (CAN) 	F
B2602: SHIFT POSITION	Inhibit steering lock	5 seconds after the following BCM recognition conditions are fulfilled <ul style="list-style-type: none"> • Ignition switch is in the ON position • Selector lever P position switch signal: Except P position (battery voltage) • Vehicle speed: 4 km/h (2.5 MPH) or more 	G
B2603: SHIFT POSI STATUS	Inhibit steering lock	500 ms after the following BCM recognition conditions are fulfilled <ul style="list-style-type: none"> • Ignition switch is in the ON position • Selector lever P position switch signal: Except P position (battery voltage) • Selector lever P/N position signal: Except P and N positions (0 V) 	H
B2604: PNP SW	Inhibit steering lock	500 ms after any of the following BCM recognition conditions is fulfilled <ul style="list-style-type: none"> • Status 1 <ul style="list-style-type: none"> - Ignition switch is in the ON position - Selector lever P/N position signal: P and N position (battery voltage) - P range signal or N range signal (CAN): ON • Status 2 <ul style="list-style-type: none"> - Ignition switch is in the ON position - Selector lever P/N position signal: Except P and N positions (0 V) - P range signal and N range signal (CAN): OFF 	I
B2605: PNP SW	Inhibit steering lock	500 ms after any of the following BCM recognition conditions is fulfilled <ul style="list-style-type: none"> • Ignition switch is in the ON position <ul style="list-style-type: none"> - Power position: IGN - Selector lever P/N position signal: Except P and N positions (0 V) - Interlock/PNP switch signal (CAN): OFF • Status 2 <ul style="list-style-type: none"> - Ignition switch is in the ON position - Selector lever P/N position signal: P or N position (battery voltage) - PNP switch signal (CAN): ON 	J
B2606: S/L RELAY	Inhibit engine cranking	500 ms after the following CAN signal communication status has become consistent <ul style="list-style-type: none"> • Steering lock relay signal (Request signal) • Steering lock relay signal (Condition signal) 	K
B2607: S/L RELAY	Inhibit engine cranking	500 ms after the following CAN signal communication status has become consistent <ul style="list-style-type: none"> • Steering lock relay signal (Request signal) • Steering lock relay signal (Condition signal) 	L

EXL

BCM (BODY CONTROL MODULE)

[HALOGEN TYPE]

< ECU DIAGNOSIS >

Display contents of CONSULT	Fail-safe	Cancellation
B2608: STARTER RELAY	Inhibit engine cranking	500 ms after the following signal communication status becomes consistent <ul style="list-style-type: none"> • Starter motor relay control signal • Starter relay status signal (CAN)
B2609: S/L STATUS	<ul style="list-style-type: none"> • Inhibit engine cranking • Inhibit steering lock 	When the following steering lock conditions agree <ul style="list-style-type: none"> • BCM steering lock control status • Steering lock condition No. 1 signal status • Steering lock condition No. 2 signal status
B260A: IGNITION RELAY	Inhibit engine cranking	500 ms after the following conditions are fulfilled <ul style="list-style-type: none"> • IGN relay (IPDM E/R) control signal: OFF (Battery voltage) • Ignition ON signal (CAN to IPDM E/R): OFF (Request signal) • Ignition ON signal (CAN from IPDM E/R): OFF (Condition signal)
B260F: ENG STATE SIG LOST	Maintains the power supply position attained at the time of DTC detection	When any of the following conditions is fulfilled <ul style="list-style-type: none"> • Power position changes to ACC • Receives engine status signal (CAN)
B2612: S/L STATUS	<ul style="list-style-type: none"> • Inhibit engine cranking • Inhibit steering lock 	When any of the following conditions is fulfilled <ul style="list-style-type: none"> • Steering lock unit status signal (CAN) is received normally • The BCM steering lock control status matches the steering lock status recognized by the steering lock unit status signal (CAN from IPDM E/R)
B2617: STARTER RELAY CIRC	Inhibit engine cranking	1 second after the starter motor relay control inside BCM becomes normal
B2618: BCM	Inhibit engine cranking	1 second after the ignition relay (IPDM E/R) control inside BCM becomes normal
B2619: BCM	Inhibit engine cranking	1 second after the steering lock unit power supply output control inside BCM becomes normal
B261E: VEHICLE TYPE	Inhibit engine cranking	BCM initialization
B26E1: ENG STATE NO RECIV	Inhibit engine cranking	When any of the following conditions is fulfilled <ul style="list-style-type: none"> • Power position changes to ACC • Receives engine status signal (CAN)
B26E9: S/L STATUS	<ul style="list-style-type: none"> • Inhibit engine cranking • Inhibit steering lock 	When BCM transmits the LOCK request signal to steering lock unit, and receives LOCK response signal from steering lock unit, the following conditions is fulfilled <ul style="list-style-type: none"> • Steering condition No. 1 signal: LOCK (0V) • Steering condition No. 2 signal: LOCK (Battery voltage)

HIGH FLASHER OPERATION

BCM detects the turn signal lamp circuit status by the current value.

BCM increases the turn signal lamp blinking speed if the bulb or harness open is detected with the turn signal lamp operating.

NOTE:

The blinking speed is normal while activating the hazard warning lamp.

DTC Inspection Priority Chart

INFOID:000000003784727

If some DTCs are displayed at the same time, perform inspections one by one based on the following priority chart.

Priority	DTC
1	B2562: LOW VOLTAGE
2	<ul style="list-style-type: none"> • U1000: CAN COMM CIRCUIT • U1010: CONTROL UNIT (CAN)
3	<ul style="list-style-type: none"> • B2190: NATS ANTENNA AMP • B2191: DIFFERENCE OF KEY • B2192: ID DISCORD BCM-ECM • B2193: CHAIN OF BCM-ECM

BCM (BODY CONTROL MODULE)

[HALOGEN TYPE]

< ECU DIAGNOSIS >

Priority	DTC		
4	<ul style="list-style-type: none"> • B2013: ID DISCORD BCM-S/L • B2014: CHAIN OF S/L-BCM • B2553: IGNITION RELAY • B2555: STOP LAMP • B2556: PUSH-BTN IGN SW • B2557: VEHICLE SPEED • B2560: STARTER CONT RELAY • B2601: SHIFT POSITION • B2602: SHIFT POSITION • B2603: SHIFT POSI STATUS • B2604: PNP SW • B2605: PNP SW • B2606: S/L RELAY • B2607: S/L RELAY • B2608: STARTER RELAY • B2609: S/L STATUS • B260A: IGNITION RELAY • B260B: STEERING LOCK UNIT • B260C: STEERING LOCK UNIT • B260D: STEERING LOCK UNIT • B260F: ENG STATE SIG LOST • B2612: S/L STATUS • B2614: ACC RELAY CIRC • B2615: BLOWER RELAY CIRC • B2616: IGN RELAY CIRC • B2617: STARTER RELAY CIRC • B2618: BCM • B2619: BCM • B261A: PUSH-BTN IGN SW • B261E: VEHICLE TYPE • B26E1: ENG STATE NO RECIV • B26E9: S/L STATUS • B26EA: KEY REGISTRATION • C1729: VHCL SPEED SIG ERR • U0415: VEHICLE SPEED SIG 	<p style="text-align: center;">A</p> <p style="text-align: center;">B</p> <p style="text-align: center;">C</p> <p style="text-align: center;">D</p> <p style="text-align: center;">E</p> <p style="text-align: center;">F</p> <p style="text-align: center;">G</p> <p style="text-align: center;">H</p> <p style="text-align: center;">I</p> <p style="text-align: center;">J</p>	
	<ul style="list-style-type: none"> • C1704: LOW PRESSURE FL • C1705: LOW PRESSURE FR • C1706: LOW PRESSURE RR • C1707: LOW PRESSURE RL • C1708: [NO DATA] FL • C1709: [NO DATA] FR • C1710: [NO DATA] RR • C1711: [NO DATA] RL • C1712: [CHECKSUM ERR] FL • C1713: [CHECKSUM ERR] FR • C1714: [CHECKSUM ERR] RR • C1715: [CHECKSUM ERR] RL • C1716: [PRESSDATA ERR] FL • C1717: [PRESSDATA ERR] FR • C1718: [PRESSDATA ERR] RR • C1719: [PRESSDATA ERR] RL • C1720: [CODE ERR] FL • C1721: [CODE ERR] FR • C1722: [CODE ERR] RR • C1723: [CODE ERR] RL • C1724: [BATT VOLT LOW] FL • C1725: [BATT VOLT LOW] FR • C1726: [BATT VOLT LOW] RR • C1727: [BATT VOLT LOW] RL • C1734: CONTROL UNIT 	<p style="text-align: center;">K</p> <div style="background-color: black; color: white; padding: 2px; text-align: center; font-weight: bold;">EXL</div> <p style="text-align: center;">M</p> <p style="text-align: center;">N</p> <p style="text-align: center;">O</p> <p style="text-align: center;">P</p>	
	6	<ul style="list-style-type: none"> • B2621: INSIDE ANTENNA • B2622: INSIDE ANTENNA • B2623: INSIDE ANTENNA 	

BCM (BODY CONTROL MODULE)

[HALOGEN TYPE]

< ECU DIAGNOSIS >

DTC Index

INFOID:000000003784728

NOTE:

The details of time display are as follows.

- CRNT: A malfunction is detected now.
- PAST: A malfunction was detected in the past.

IGN counter is displayed on Freeze Frame Data. For details of Freeze Frame Data and IGN Counter, refer to [EXL-229, "COMMON ITEM : CONSULT-III Function \(BCM - COMMON ITEM\)"](#).

CONSULT display	Fail-safe	Freeze Frame Data	Intelligent Key warning lamp ON	Tire pressure monitor warning lamp ON	Reference page
No DTC is detected. further testing may be required.	—	—	—	—	—
U1000: CAN COMM CIRCUIT	—	—	—	—	BCS-37
U1010: CONTROL UNIT (CAN)	—	—	—	—	BCS-38
U0415: VEHICLE SPEED SIG	—	—	—	—	BCS-39
B2013: ID DISCORD BCM-S/L	×	×	—	—	SEC-48
B2014: CHAIN OF S/L-BCM	×	×	—	—	SEC-49
B2190: NATS ANTENNA AMP	×	—	—	—	SEC-42
B2191: DIFFERENCE OF KEY	×	—	—	—	SEC-45
B2192: ID DISCORD BCM-ECM	×	—	—	—	SEC-46
B2193: CHAIN OF BCM-ECM	×	—	—	—	SEC-47
B2553: IGNITION RELAY	—	×	—	—	PCS-49
B2555: STOP LAMP	—	×	—	—	SEC-52
B2556: PUSH-BTN IGN SW	—	×	×	—	SEC-54
B2557: VEHICLE SPEED	×	×	×	—	SEC-56
B2560: STARTER CONT RELAY	×	×	×	—	SEC-57
B2562: LOW VOLTAGE	—	×	—	—	BCS-40
B2601: SHIFT POSITION	×	×	×	—	SEC-58
B2602: SHIFT POSITION	×	×	×	—	SEC-61
B2603: SHIFT POSI STATUS	×	×	×	—	SEC-63
B2604: PNP SW	×	×	×	—	SEC-66
B2605: PNP SW	×	×	×	—	SEC-68
B2606: S/L RELAY	×	×	×	—	SEC-70
B2607: S/L RELAY	×	×	×	—	SEC-71
B2608: STARTER RELAY	×	×	×	—	SEC-73
B2609: S/L STATUS	×	×	×	—	SEC-75
B260A: IGNITION RELAY	×	×	×	—	PCS-51
B260B: STEERING LOCK UNIT	—	×	×	—	SEC-79
B260C: STEERING LOCK UNIT	—	×	×	—	SEC-80
B260D: STEERING LOCK UNIT	—	×	×	—	SEC-81
B260F: ENG STATE SIG LOST	×	×	×	—	SEC-82
B2612: S/L STATUS	×	×	×	—	SEC-86
B2614: ACC RELAY CIRC	—	×	×	—	PCS-53
B2615: BLOWER RELAY CIRC	—	×	×	—	PCS-57
B2616: IGN RELAY CIRC	—	×	×	—	PCS-59
B2617: STARTER RELAY CIRC	×	×	×	—	SEC-90

BCM (BODY CONTROL MODULE)

< ECU DIAGNOSIS >

[HALOGEN TYPE]

CONSULT display	Fail-safe	Freeze Frame Data	Intelligent Key warning lamp ON	Tire pressure monitor warning lamp ON	Reference page	
B2618: BCM	×	×	×	—	PCS-61	A
B2619: BCM	×	×	×	—	SEC-92	B
B261A: PUSH-BTN IGN SW	—	×	×	—	SEC-93	
B261E: VEHICLE TYPE	×	×	× (Turn ON for 15 seconds)	—	SEC-96	C
B2621: INSIDE ANTENNA	—	×	—	—	DLK-56	
B2622: INSIDE ANTENNA	—	×	—	—	DLK-58	D
B2623: INSIDE ANTENNA	—	×	—	—	DLK-60	
B26E1: ENG STATE NO RES	×	×	×	—	SEC-83	
B26E9: S/L STATUS	×	×	× (Turn ON for 15 seconds)	—	SEC-84	E
B26EA: KEY REGISTRATION	—	×	× (Turn ON for 15 seconds)	—	SEC-85	F
C1704: LOW PRESSURE FL	—	—	—	×	WT-16	
C1705: LOW PRESSURE FR	—	—	—	×		G
C1706: LOW PRESSURE RR	—	—	—	×		
C1707: LOW PRESSURE RL	—	—	—	×		
C1708: [NO DATA] FL	—	—	—	×	WT-18	H
C1709: [NO DATA] FR	—	—	—	×		
C1710: [NO DATA] RR	—	—	—	×		
C1711: [NO DATA] RL	—	—	—	×		I
C1712: [CHECKSUM ERR] FL	—	—	—	×	WT-21	
C1713: [CHECKSUM ERR] FR	—	—	—	×		J
C1714: [CHECKSUM ERR] RR	—	—	—	×		
C1715: [CHECKSUM ERR] RL	—	—	—	×		
C1716: [PRESSDATA ERR] FL	—	—	—	×	WT-24	K
C1717: [PRESSDATA ERR] FR	—	—	—	×		
C1718: [PRESSDATA ERR] RR	—	—	—	×		
C1719: [PRESSDATA ERR] RL	—	—	—	×		EXL
C1720: [CODE ERR] FL	—	—	—	×	WT-26	
C1721: [CODE ERR] FR	—	—	—	×		M
C1722: [CODE ERR] RR	—	—	—	×		
C1723: [CODE ERR] RL	—	—	—	×		
C1724: [BATT VOLT LOW] FL	—	—	—	×	WT-29	N
C1725: [BATT VOLT LOW] FR	—	—	—	×		
C1726: [BATT VOLT LOW] RR	—	—	—	×		
C1727: [BATT VOLT LOW] RL	—	—	—	×		O
C1729: VHCL SPEED SIG ERR	—	—	—	×	WT-32	
C1734: CONTROL UNIT	—	—	—	×	WT-33	P

IPDM E/R (INTELLIGENT POWER DISTRIBUTION MODULE ENGINE ROOM)

< ECU DIAGNOSIS >

[HALOGEN TYPE]

IPDM E/R (INTELLIGENT POWER DISTRIBUTION MODULE ENGINE ROOM)

Reference Value

INFOID:000000003757066

VALUES ON THE DIAGNOSIS TOOL

Monitor Item	Condition		Value/Status
RAD FAN REQ	Engine idle speed	Changes depending on engine coolant temperature, air conditioner operation status, vehicle speed, etc.	0 – 100 %
AC COMP REQ	Engine running	A/C switch OFF	Off
		A/C switch ON (Compressor is operating)	On
TAIL&CLR REQ	Lighting switch OFF		Off
	Lighting switch 1ST, 2ND, HI or AUTO (Light is illuminated)		On
HL LO REQ	Lighting switch OFF		Off
	Lighting switch 2ND HI or AUTO (Light is illuminated)		On
HL HI REQ	Lighting switch OFF		Off
	Lighting switch HI		On
FR FOG REQ	Lighting switch 2ND or AUTO (Light is illuminated)	Front fog lamp switch OFF	Off
		<ul style="list-style-type: none"> • Front fog lamp switch ON • Daytime running light activated (Only for Canada) 	On
FR WIP REQ	Ignition switch ON	Front wiper switch OFF	Stop
		Front wiper switch INT	1LOW
		Front wiper switch LO	Low
		Front wiper switch HI	Hi
WIP AUTO STOP	Ignition switch ON	Front wiper stop position	STOP P
		Any position other than front wiper stop position	ACT P
WIP PROT	Ignition switch ON	Front wiper operates normally	Off
		Front wiper stops at fail-safe operation	BLOCK
IGN RLY1 -REQ	Ignition switch OFF or ACC		Off
	Ignition switch ON		On
IGN RLY	Ignition switch OFF or ACC		Off
	Ignition switch ON		On
PUSH SW	Release the push-button ignition switch		Off
	Press the push-button ignition switch		On
INTER/NP SW	Ignition switch ON	Selector lever in any position other than P or N	Off
		Selector lever in P or N position	On
ST RLY CONT	Ignition switch ON		Off
	At engine cranking		On
IHBT RLY -REQ	Ignition switch ON		Off
	At engine cranking		On

IPDM E/R (INTELLIGENT POWER DISTRIBUTION MODULE ENGINE ROOM)

< ECU DIAGNOSIS >

[HALOGEN TYPE]

Monitor Item	Condition	Value/Status
ST/INHI RLY	Ignition switch ON	Off
	At engine cranking	INHI → ST
	The status of starter relay or starter control relay cannot be recognized by the battery voltage malfunction, etc. when the starter relay is ON and the starter control relay is OFF	UNKWN
DETENT SW	Ignition switch ON	<ul style="list-style-type: none"> Press the selector button with selector lever in P position Selector lever in any position other than P Off
	Release the selector button with selector lever in P position	On
S/L RLY -REQ	None of the conditions below are present	Off
	<ul style="list-style-type: none"> Open the driver door after the ignition switch is turned OFF (for a few seconds) Press the push-button ignition switch when the steering lock is activated 	On
S/L STATE	Steering lock is activated	LOCK
	Steering lock is deactivated	UNLOCK
	[DTC: B210A] is detected	UNKWN
DTRL REQ	NOTE: The item is indicated, but not monitored.	Off
OIL P SW	Ignition switch OFF, ACC or engine running	Open
	Ignition switch ON	Close
HOOD SW	Close the hood	Off
	Open the hood	On
HL WASHER REQ	NOTE: The item is indicated, but not monitored.	Off
THFT HRN REQ	Not operation	Off
	<ul style="list-style-type: none"> Panic alarm is activated Horn is activated with VEHICLE SECURITY (THEFT WARNING) SYSTEM 	On
HORN CHIRP	Not operating	Off
	Door locking with Intelligent Key (horn chirp mode)	On
CRNRNG LMP REQ	NOTE: The item is indicated, but not monitored.	Off

A
B
C
D
E
F
G
H
I
J
K
EXL
M
N
O
P

IPDM E/R (INTELLIGENT POWER DISTRIBUTION MODULE ENGINE ROOM)

< ECU DIAGNOSIS >

[HALOGEN TYPE]

TERMINAL LAYOUT

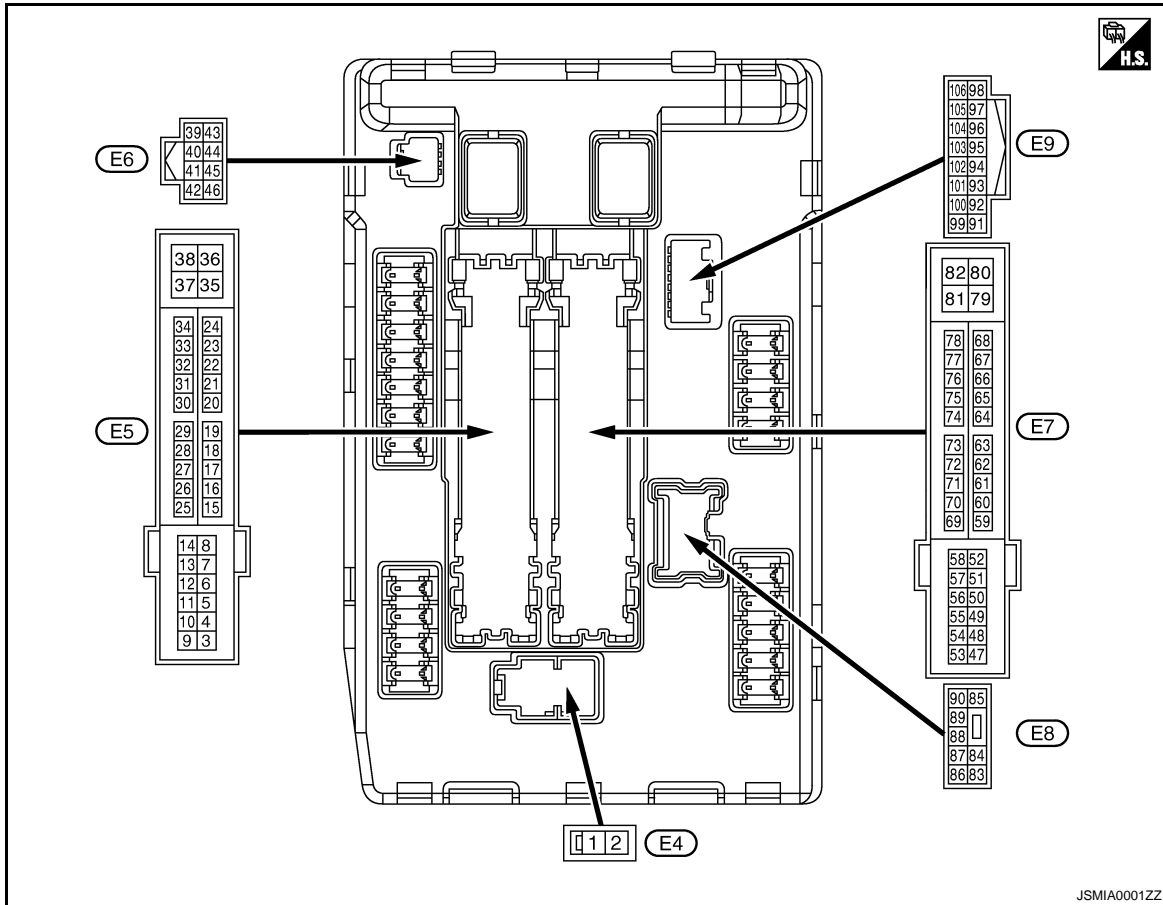

PHYSICAL VALUES

Terminal No. (Wire color)		Description		Condition		Value (Approx.)
+	-	Signal name	Input/ Output			
1 (W)	Ground	Battery power supply	Input	Ignition switch OFF		Battery voltage
2 (L)	Ground	Battery power supply	Input	Ignition switch OFF		Battery voltage
4 (V)	Ground	Front wiper LO	Output	Ignition switch OFF	Front wiper switch OFF	0 V
				Ignition switch ON	Front wiper switch LO	Battery voltage
5 (L)	Ground	Front wiper HI	Output	Ignition switch OFF	Front wiper switch OFF	0 V
				Ignition switch ON	Front wiper switch HI	Battery voltage
7 (R)	Ground	Tail, license plate lamps & interior lamps	Output	Ignition switch OFF	Lighting switch OFF	0 V
				Ignition switch ON	Lighting switch 1ST	Battery voltage
11 (BR)	Ground	Steering lock unit power supply	Output	Ignition switch OFF	A few seconds after opening the driver door	Battery voltage
				Ignition switch LOCK	Press the push-button ignition switch	Battery voltage
				Ignition switch ACC or ON		0 V
12 (B/W)	Ground	Ground	—	Ignition switch ON		0 V

IPDM E/R (INTELLIGENT POWER DISTRIBUTION MODULE ENGINE ROOM)

< ECU DIAGNOSIS >

[HALOGEN TYPE]

Terminal No. (Wire color)		Description		Condition		Value (Approx.)
13 (SB)	Ground	Fuel pump power supply	Output	Approximately 1 second or more after turning the ignition switch ON		0 V
				<ul style="list-style-type: none"> • Approximately 1 second after turning the ignition switch ON • Engine running 		Battery voltage
16 (LG)	Ground	Front wiper auto stop	Input	Ignition switch ON	Front wiper stop position	0 V
					Any position other than front wiper stop position	Battery voltage
19 (W)	Ground	Ignition relay power supply	Output	Ignition switch OFF		0 V
				Ignition switch ON		Battery voltage
25 (G)	Ground	Ignition relay power supply	Output	Ignition switch OFF		0 V
				Ignition switch ON		Battery voltage
26* (R)	Ground	Ignition relay power supply	Output	Ignition switch OFF		0 V
				Ignition switch ON		Battery voltage
27 (O)	Ground	Ignition relay monitor	Input	Ignition switch OFF or ACC		Battery voltage
				Ignition switch ON		0 V
28 (L)	Ground	Push-button ignition switch	Input	Press the push-button ignition switch		0 V
				Release the push-button ignition switch		Battery voltage
30 (GR)	Ground	Starter relay control	Input	Ignition switch ON	Selector lever in any position other than P or N	0 V
					Selector lever P or N	Battery voltage
32 (L)	Ground	Steering lock unit condition-1	Input	Steering lock is activated		0 V
				Steering lock is deactivated		Battery voltage
33 (P)	Ground	Steering lock unit condition-2	Input	Steering lock is activated		Battery voltage
				Steering lock is deactivated		0 V
36 (G)	Ground	Battery power supply	Input	Ignition switch OFF		Battery voltage
39 (P)	—	CAN-L	Input/ Output	—		—
40 (L)	—	CAN-H	Input/ Output	—		—
41 (B/W)	Ground	Ground	—	Ignition switch ON		0 V
42 (Y)	Ground	Cooling fan relay control	Input	Ignition switch OFF or ACC		0 V
				Ignition switch ON		0.7 V
43 (SB)	Ground	Control device (Detention switch)	Input	Ignition switch ON	<ul style="list-style-type: none"> • Press the selector button (Selector lever P) • Selector lever in any position other than P 	Battery voltage
					Release the selector button (selector lever P)	0 V
44 (W)	Ground	Horn relay control	Input	The horn is deactivated		Battery voltage
				The horn is activated		0 V
45 (G)	Ground	Anti theft horn relay control	Input	The horn is deactivated		Battery voltage
				The horn is activated		0 V

A
B
C
D
E
F
G
H
I
J
K
EXL
M
N
O
P

IPDM E/R (INTELLIGENT POWER DISTRIBUTION MODULE ENGINE ROOM)

< ECU DIAGNOSIS >

[HALOGEN TYPE]

Terminal No. (Wire color)		Description		Condition		Value (Approx.)
+	-	Signal name	Input/ Output			
46 (R)	Ground	Starter relay control	Input	Ignition switch ON	Selector lever in any position other than P or N	0 V
					Selector lever P or N	Battery voltage
48 (L)	Ground	A/C relay power supply	Output	Engine running	A/C switch OFF	0 V
						A/C switch ON (A/C compressor is operating)
49 (R)	Ground	ECM relay power supply	Output	Ignition switch OFF (More than a few seconds after turning ignition switch OFF)		0 V
				<ul style="list-style-type: none"> • Ignition switch ON • Ignition switch OFF (For a few seconds after turning ignition switch OFF) 		Battery voltage
51 (G)	Ground	Ignition relay power supply	Output	Ignition switch OFF		0 V
				Ignition switch ON		Battery voltage
53 (W)	Ground	ECM relay power supply	Output	Ignition switch OFF (More than a few seconds after turning ignition switch OFF)		0 V
				<ul style="list-style-type: none"> • Ignition switch ON • Ignition switch OFF (For a few seconds after turning ignition switch OFF) 		Battery voltage
54 (LG)	Ground	Throttle control motor relay power supply	Output	Ignition switch OFF (More than a few seconds after turning ignition switch OFF)		0 V
				<ul style="list-style-type: none"> • Ignition switch ON • Ignition switch OFF (For a few seconds after turning ignition switch OFF) 		Battery voltage
55 (BR)	Ground	ECM power supply	Output	Ignition switch OFF		Battery voltage
56 (V)	Ground	Ignition relay power supply	Output	Ignition switch OFF		0 V
				Ignition switch ON		Battery voltage
57 (SB)	Ground	Ignition relay power supply	Output	Ignition switch OFF		0 V
				Ignition switch ON		Battery voltage
58 (P)	Ground	Ignition relay power supply	Output	Ignition switch OFF		0 V
				Ignition switch ON		Battery voltage
69 (W)	Ground	ECM relay control	Output	Ignition switch OFF (More than a few seconds after turning ignition switch OFF)		Battery voltage
				<ul style="list-style-type: none"> • Ignition switch ON • Ignition switch OFF (For a few seconds after turning ignition switch OFF) 		0 – 1.5 V
70 (O)	Ground	Throttle control motor relay control	Output	Ignition switch ON → OFF		0 – 1.0 V ↓ Battery voltage ↓ 0 V
				Ignition switch ON		0 – 1.0 V

IPDM E/R (INTELLIGENT POWER DISTRIBUTION MODULE ENGINE ROOM)

< ECU DIAGNOSIS >

[HALOGEN TYPE]

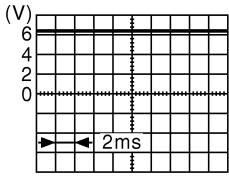
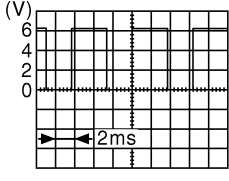
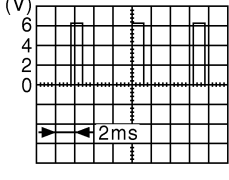
Terminal No. (Wire color)		Description		Condition		Value (Approx.)
+	-					
74 (P)	Ground	Ignition relay power supply	Output	Ignition switch OFF		0 V
				Ignition switch ON		Battery voltage
75 (Y)	Ground	Oil pressure switch	Input	Ignition switch ON	Engine stopped	0 V
					Engine running	Battery voltage
76 (V)	Ground	Power generation command signal	Output	Ignition switch ON		 <p style="text-align: center;">6.3 V</p>
				40% is set on "ACTIVE TEST", "ALTERNATOR DUTY" of "ENGINE"		 <p style="text-align: center;">3.8 V</p>
				80% is set on "ACTIVE TEST", "ALTERNATOR DUTY" of "ENGINE"		 <p style="text-align: center;">1.4 V</p>
77 (L)	Ground	Fuel pump relay control	Output	<ul style="list-style-type: none"> Approximately 1 second after turning the ignition switch ON Engine running 		0 – 1.0 V
				Approximately 1 second or more after turning the ignition switch ON		Battery voltage
80 (W)	Ground	Starter motor	Output	At engine cranking		Battery voltage
83 (O)	Ground	Headlamp LO (RH)	Output	Ignition switch ON	Lighting switch OFF	0 V
					Lighting switch 2ND	Battery voltage
84 (V)	Ground	Headlamp LO (LH)	Output	Ignition switch ON	Lighting switch OFF	0 V
					Lighting switch 2ND	Battery voltage
86 (W)	Ground	Front fog lamp (RH)	Output	Lighting switch 2ND	<ul style="list-style-type: none"> Front fog lamp switch ON Daytime running light activated (Only for Canada) 	Battery voltage
					Front fog lamp switch OFF	0 V

A
B
C
D
E
F
G
H
I
J
K
M
N
O
P

EXL

IPDM E/R (INTELLIGENT POWER DISTRIBUTION MODULE ENGINE ROOM)

< ECU DIAGNOSIS >

[HALOGEN TYPE]

Terminal No. (Wire color)		Description		Condition		Value (Approx.)
+	-	Signal name	Input/ Output			
87 (L)	Ground	Front fog lamp (LH)	Output	Lighting switch 2ND	<ul style="list-style-type: none"> • Front fog lamp switch ON • Daytime running light activated (Only for Canada) 	Battery voltage
				Front fog lamp switch OFF		0 V
88 (GR)	Ground	Washer pump power supply	Output	Ignition switch ON		Battery voltage
89 (BR)	Ground	Headlamp HI (RH)	Output	Ignition switch ON	<ul style="list-style-type: none"> • Lighting switch HI • Lighting switch PASS 	Battery voltage
					Lighting switch OFF	
90 (P)	Ground	Headlamp HI (LH)	Output	Ignition switch ON	<ul style="list-style-type: none"> • Lighting switch HI • Lighting switch PASS 	Battery voltage
					Lighting switch OFF	
91 (P)	Ground	Parking lamp (RH)	Output	Ignition switch ON	Lighting switch 1ST	Battery voltage
					Lighting switch OFF	
92 (O)	Ground	Parking lamp (LH)	Output	Ignition switch ON	Lighting switch 1ST	Battery voltage
					Lighting switch OFF	
97 (V)	Ground	Cooling fan control	Output	Engine idling		0 – 5 V
104 (LG)	Ground	Hood switch	Input	Close the hood		Battery voltage
				Open the hood		0 V

*: Only for the models with ICC system

IPDM E/R (INTELLIGENT POWER DISTRIBUTION MODULE ENGINE ROOM)

< ECU DIAGNOSIS >

[HALOGEN TYPE]

Wiring Diagram - IPDM E/R -

INFOID:000000003757067

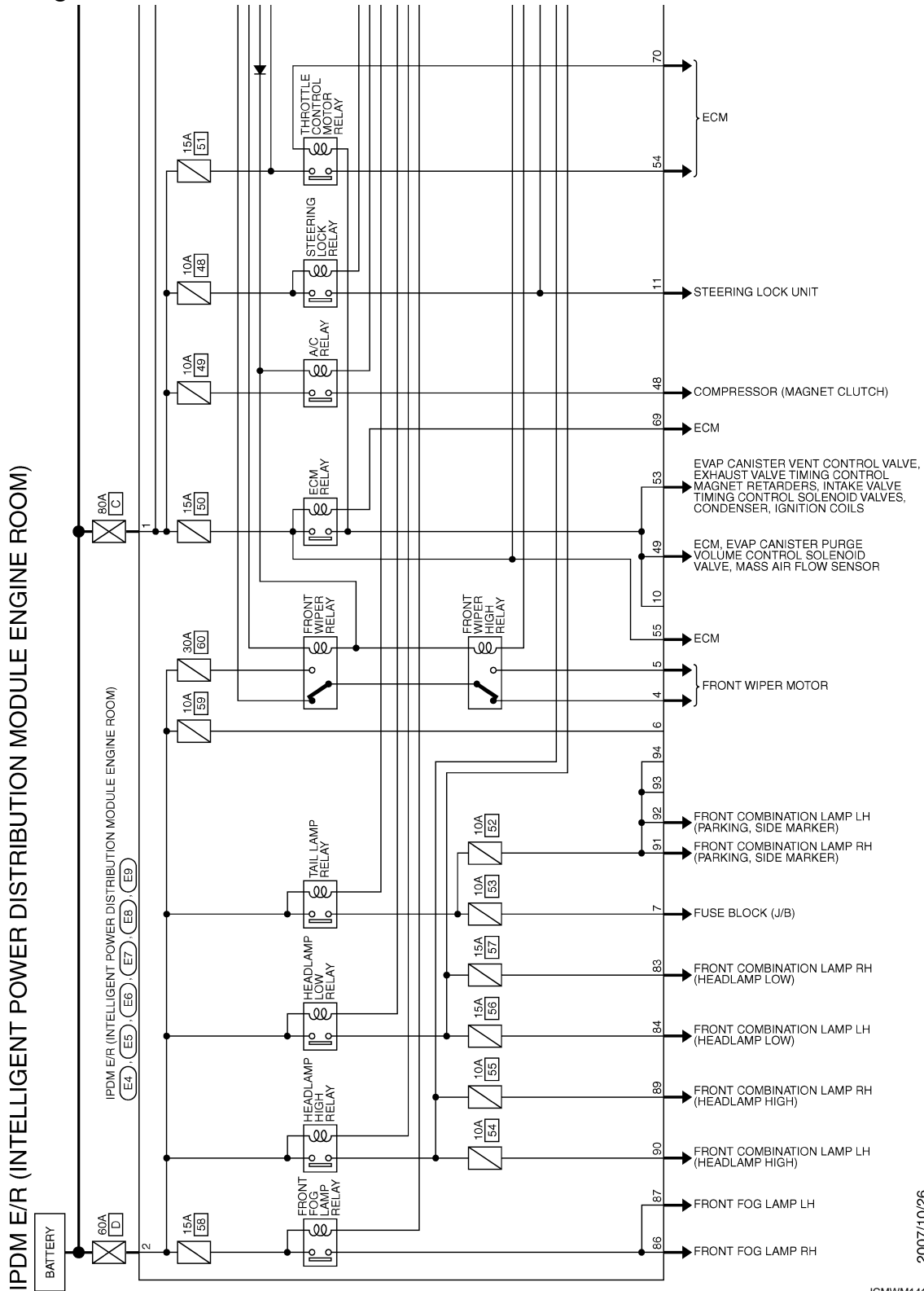

A
B
C
D
E
F
G
H
I
J
K
EXL
M
N
O
P

2007/10/26

JCMWM141GI

IPDM E/R (INTELLIGENT POWER DISTRIBUTION MODULE ENGINE ROOM)

< ECU DIAGNOSIS >

[HALOGEN TYPE]

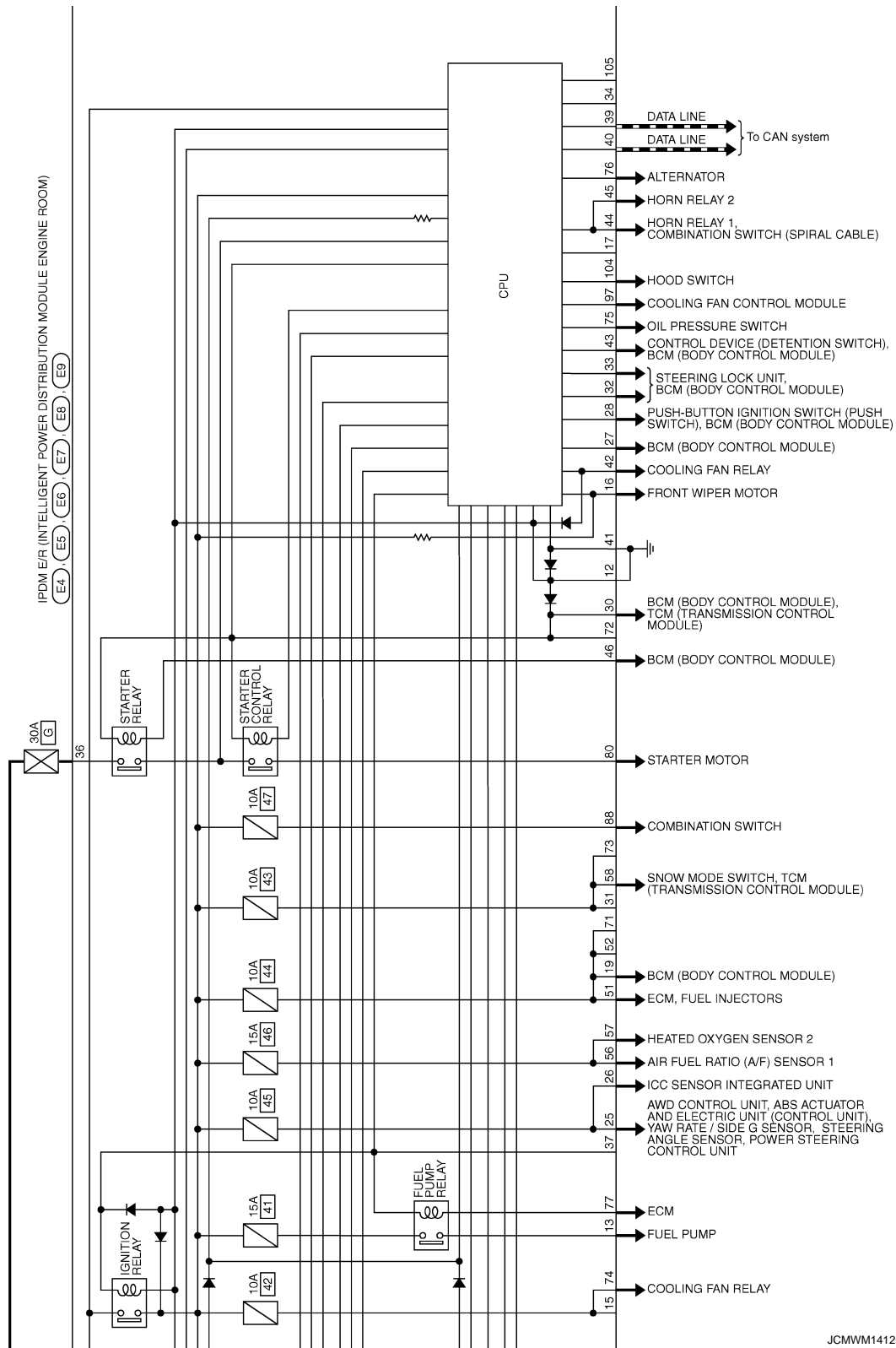

A
 B
 C
 D
 E
 F
 G
 H
 I
 J
 K
 EXL
 M
 N
 O
 P

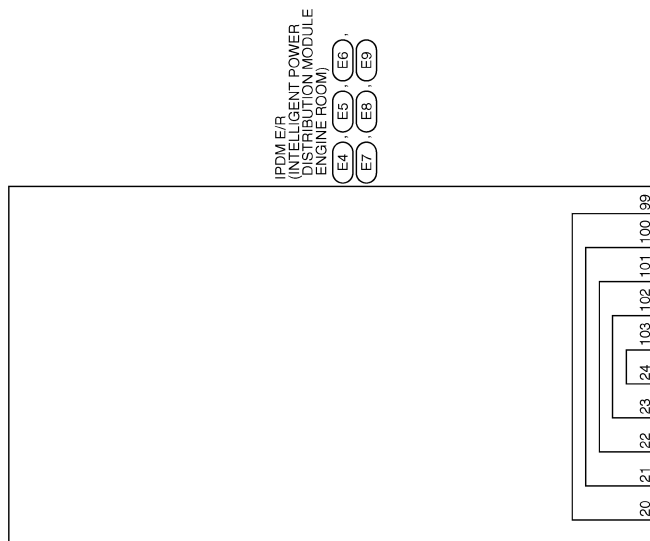

JCMWM1413G1



IPDM E/R (INTELLIGENT POWER DISTRIBUTION MODULE ENGINE ROOM)

< ECU DIAGNOSIS >

[HALOGEN TYPE]

IPDM E/R (INTELLIGENT POWER DISTRIBUTION MODULE ENGINE ROOM)



Connector No.	E6
Connector Name	IPDM E/R (INTELLIGENT POWER DISTRIBUTION MODULE ENGINE ROOM)
Connector Type	TH08FW-NH

Terminal No.	Color of Wire	Signal Name [Specification]
39	P	-
40	L	-
41	B/W	-
42	Y	-
43	SB	-
44	W	-
45	G	-
46	R	-

IPDM E/R (INTELLIGENT POWER DISTRIBUTION MODULE ENGINE ROOM)

Connector No.	E9
Connector Name	IPDM E/R (INTELLIGENT POWER DISTRIBUTION MODULE ENGINE ROOM)
Connector Type	TH18FW-NH





Terminal No.	Color of Wire	Signal Name [Specification]
91	P	-
92	O	-
97	V	-
104	LG	-

28	L	-
30	GR	-
32	B	-
33	P	-
36	G	-

IPDM E/R (INTELLIGENT POWER DISTRIBUTION MODULE ENGINE ROOM)

Connector No.	E8
Connector Name	IPDM E/R (INTELLIGENT POWER DISTRIBUTION MODULE ENGINE ROOM)
Connector Type	NS08FW-CS



Terminal No.	Color of Wire	Signal Name [Specification]
83	O	-
84	V	-
86	W	-
87	L	-
88	GR	-
89	BR	-
90	P	-

IPDM E/R (INTELLIGENT POWER DISTRIBUTION MODULE ENGINE ROOM)

Connector No.	E5
Connector Name	IPDM E/R (INTELLIGENT POWER DISTRIBUTION MODULE ENGINE ROOM)
Connector Type	TH20FW-CS/2-M4-1V

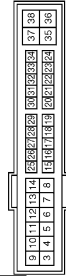



Terminal No.	Color of Wire	Signal Name [Specification]
4	V	-
5	L	-
7	R	-
11	BR	-
12	B/W	-
13	SB	-
16	LG	-
19	W	-
25	G	-
26	R	-
27	O	-

74	P	-
75	Y	-
76	V	-
77	L	-
80	W	-

IPDM E/R (INTELLIGENT POWER DISTRIBUTION MODULE ENGINE ROOM)



Connector No.	E4
Connector Name	IPDM E/R (INTELLIGENT POWER DISTRIBUTION MODULE ENGINE ROOM)
Connector Type	LO2FB-MC

Terminal No.	Color of Wire	Signal Name [Specification]
1	W	-
2	L	-

IPDM E/R (INTELLIGENT POWER DISTRIBUTION MODULE ENGINE ROOM)

Connector No.	E7
Connector Name	IPDM E/R (INTELLIGENT POWER DISTRIBUTION MODULE ENGINE ROOM)
Connector Type	TH20FW-CS/2-M4

Terminal No.	Color of Wire	Signal Name [Specification]
48	L	-
49	R	-
51	G	-
53	W	-
54	LG	-
55	BR	-
56	V	-
57	SB	-
58	P	-
68	W	-
70	O	-

Fail-safe

CAN COMMUNICATION CONTROL

When CAN communication with ECM and BCM is impossible, IPDM E/R performs fail-safe control. After CAN communication recovers normally, it also returns to normal control.

If No CAN Communication Is Available With ECM

JCMWM1414G

INFOID:000000003757068

IPDM E/R (INTELLIGENT POWER DISTRIBUTION MODULE ENGINE ROOM)

< ECU DIAGNOSIS >

[HALOGEN TYPE]

Control part	Fail-safe operation
Cooling fan	<ul style="list-style-type: none"> • Outputs the pulse duty signal (PWM signal) 100% when the ignition switch is turned ON • Outputs the pulse duty signal (PWM signal) 0% when the ignition switch is turned OFF
A/C compressor	A/C relay OFF
Alternator	Outputs the power generation command signal (PWM signal) 0%

If No CAN Communication Is Available With BCM

Control part	Fail-safe operation
Headlamp	<ul style="list-style-type: none"> • Turns ON the headlamp low relay when the ignition switch is turned ON • Turns OFF the headlamp low relay when the ignition switch is turned OFF • Headlamp high relay OFF
<ul style="list-style-type: none"> • Parking lamps • License plate lamps • Side maker lamps • Illuminations • Tail lamps 	<ul style="list-style-type: none"> • Turns ON the tail lamp relay when the ignition switch is turned ON • Turns OFF the tail lamp relay when the ignition switch is turned OFF
Front wiper	<ul style="list-style-type: none"> • The status just before activation of fail-safe control is maintained until the ignition switch is turned OFF while the front wiper is operating at LO or HI speed. • The wiper is operated at LO speed until the ignition switch is turned OFF if the fail-safe control is activated while the front wiper is set in the INT mode and the front wiper motor is operating.
Front fog lamps	Front fog lamp relay OFF
Horn	Horn OFF
Ignition relay	The status just before activation of fail-safe is maintained.
Starter motor	Starter control relay OFF
Steering lock unit	Steering lock relay OFF

IGNITION RELAY MALFUNCTION DETECTION FUNCTION

- IPDM E/R monitors the voltage at the contact circuit and excitation coil circuit of the ignition relay inside it.
- IPDM E/R judges the ignition relay error if the voltage differs between the contact circuit and the excitation coil circuit.
- If the ignition relay cannot turn OFF due to contact seizure, it activates the tail lamp relay for 10 minutes to alert the user to the ignition relay malfunction when the ignition switch is turned OFF.

Voltage judgment		IPDM E/R judgment	Operation
Ignition relay contact side	Ignition relay excitation coil side		
ON	ON	Ignition relay ON normal	—
OFF	OFF	Ignition relay OFF normal	—
ON	OFF	Ignition relay ON stuck	<ul style="list-style-type: none"> • Detects DTC "B2098: IGN RELAY ON" • Turns ON the tail lamp relay for 10 minutes
OFF	ON	Ignition relay OFF stuck	Detects DTC "B2099: IGN RELAY OFF"

FRONT WIPER CONTROL

IPDM E/R detects front wiper stop position by a front wiper auto stop signal.

When a front wiper auto stop signal is in the conditions listed below, IPDM E/R stops power supply to wiper after repeating a front wiper 10 seconds activation and 20 seconds stop five times.

IPDM E/R (INTELLIGENT POWER DISTRIBUTION MODULE ENGINE ROOM)

< ECU DIAGNOSIS >

[HALOGEN TYPE]

Ignition switch	Front wiper switch	Front wiper auto stop signal
ON	OFF	The front wiper auto stop signal (stop position) cannot be input for 10 seconds.
	ON	The front wiper auto stop signal does not change for 10 seconds.

NOTE:

This operation status can be confirmed on the IPDM E/R “Data Monitor” that displays “BLOCK” for the item “WIP PROT” while the wiper is stopped.

STARTER MOTOR PROTECTION FUNCTION

IPDM E/R turns OFF the starter control relay to protect the starter motor when the starter control relay remains active for 90 seconds.

DTC Index

INFOID:000000003757069

NOTE:

- The details of time display are as follows.
 - CRNT: A malfunction is detected now
 - PAST: A malfunction was detected in the past.
- IGN counter is displayed on FFD (Freeze Frame data).
 - The number is 0 when is detected now
 - The number increases like 1 → 2 ... 38 → 39 after returning to the normal condition whenever IGN OFF → ON.
 - The number is fixed to 39 until the self-diagnosis results are erased if it is over 39.

×: Applicable

CONSULT display	Fail-safe	Reference
No DTC is detected. further testing may be required.	—	—
U1000: CAN COMM CIRCUIT	×	PCS-16
B2098: IGN RELAY ON	×	PCS-17
B2099: IGN RELAY OFF	—	PCS-18
B2108: STRG LCK RELAY ON	—	SEC-97
B2109: STRG LCK RELAY OFF	—	SEC-98
B210A: STRG LCK STATE SW	—	SEC-99
B210B: START CONT RLY ON	—	SEC-103
B210C: START CONT RLY OFF	—	SEC-104
B210D: STARTER RELAY ON	—	SEC-105
B210E: STARTER RELAY OFF	—	SEC-106
B210F: INTRLCK/PNP SW ON	—	SEC-108
B2110: INTRLCK/PNP SW OFF	—	SEC-110

EXTERIOR LIGHTING SYSTEM SYMPTOMS

< SYMPTOM DIAGNOSIS >

[HALOGEN TYPE]

SYMPTOM DIAGNOSIS

EXTERIOR LIGHTING SYSTEM SYMPTOMS

Symptom Table

INFOID:000000003534051

CAUTION:

Perform the self-diagnosis with CONSULT-III before the symptom diagnosis. Perform the trouble diagnosis if any DTC is detected.

Symptom		Possible cause	Inspection item
Headlamp (HI) is not turned ON.	One side	<ul style="list-style-type: none"> • Fuse • Halogen bulb (HI) • Harness between IPDM E/R and the headlamp high • Daytime running light relay (with daytime running light system) • IPDM E/R 	Headlamp (HI) circuit Refer to EXL-242 .
	Both sides	Symptom diagnosis "BOTH SIDE HEADLAMPS (HI) ARE NOT TURNED ON" Refer to EXL-342 .	
Headlamp (HI) is not turned OFF.	When ignition switch is turned ON.	IPDM E/R	
	When ignition switch is turned OFF.	—	
High beam indicator lamp is not turned ON. [The headlamp (HI) is turned ON.]		Combination meter	<ul style="list-style-type: none"> • Combination meter Data monitor "HI-BEAM IND" • BCM (HEAD LAMP) Active test "HEADLAMP"
Headlamp (LO) is not turned ON.	One side	<ul style="list-style-type: none"> • Fuse • Halogen bulb (LO) • Harness between IPDM E/R and the headlamp low • IPDM E/R 	Headlamp (LO) circuit Refer to EXL-244 .
	Both sides	Symptom diagnosis "BOTH SIDE HEADLAMPS (LO) ARE NOT TURNED ON" Refer to EXL-343 .	
Headlamp (LO) is not turned OFF.	When ignition switch is turned ON.	IPDM E/R	
	When ignition switch is turned OFF.	—	
Headlamp is not turned ON/OFF with the lighting switch AUTO.		<ul style="list-style-type: none"> • Combination switch • Harness between the combination switch and BCM • BCM 	Combination switch Refer to BCS-82 .
		<ul style="list-style-type: none"> • Optical sensor • Harness between the optical sensor and BCM • BCM 	Optical sensor Refer to EXL-252 .
Front fog lamp is not turned ON.	One side	<ul style="list-style-type: none"> • Front fog lamp bulb • Harness between IPDM E/R and the front combination lamp • Front combination lamp • IPDM E/R 	Front fog lamp circuit Refer to EXL-246 .
	Both side	Symptom diagnosis "BOTH SIDE FRONT FOG LAMPS ARE NOT TURNED ON" Refer to EXL-345 .	
Front fog lamp is not turned ON.			
Parking lamp is not turned ON.		<ul style="list-style-type: none"> • Fuse • Parking lamp bulb • Harness between IPDM E/R and the front combination lamp • Front combination lamp • IPDM E/R 	Parking lamp circuit Refer to EXL-248 .

A
B
C
D
E
F
G
H
I
J
K

EXL

M
N
O
P

EXTERIOR LIGHTING SYSTEM SYMPTOMS

< SYMPTOM DIAGNOSIS >

[HALOGEN TYPE]

Symptom	Possible cause	Inspection item	
Tail lamp is not turned ON.	<ul style="list-style-type: none"> • Harness between IPDM E/R and the rear combination lamp • Rear combination lamp 	Tail lamp circuit Refer to EXL-257 .	
License plate lamp is not turned ON.	<ul style="list-style-type: none"> • Harness between IPDM E/R and the license plate lamp • License plate lamp 	License plate lamp circuit Refer to EXL-259 .	
Tail lamp and the license plate lamp are not turned ON.	<ul style="list-style-type: none"> • Fuse • Harness between IPDM E/R and the rear combination lamp • IPDM E/R 	Tail lamp circuit Refer to EXL-257 .	
<ul style="list-style-type: none"> • Parking lamp, the tail lamp and the license plate lamp are not turned ON. • Parking lamp, the tail lamp and the license plate lamp are not turned OFF. (Each illumination is turned ON/OFF.)	Symptom diagnosis "PARKING, LICENSE PLATE AND TAIL LAMPS ARE NOT TURNED ON" Refer to EXL-344 .		
Turn signal lamp does not blink.	Indicator lamp is normal. (The applicable side performs the high flasher activation.)	<ul style="list-style-type: none"> • Harness between BCM and each turn signal lamp • Turn signal lamp bulb 	Turn signal lamp circuit Refer to EXL-250 .
	Indicator lamp is included	<ul style="list-style-type: none"> • Combination switch • Harness between the combination switch and BCM • BCM 	Combination switch Refer to BCS-82 .
Turn signal indicator lamp does not blink. (The turn signal indicator lamp is normal.)	One side	Combination meter	—
	Both sides (Always)	<ul style="list-style-type: none"> • Turn signal indicator lamp signal - Unified meter and A/C amp. - BCM • Combination meter 	<ul style="list-style-type: none"> • Unified meter and A/C amp. Data monitor "TURN IND" • BCM (FLASHER) Active test "FLASHER"
	Both sides (Only when activating the hazard warning lamp with the ignition switch OFF)	<ul style="list-style-type: none"> • The combination meter power supply and the ground circuit • Combination meter 	Combination meter Power supply and the ground circuit Refer to MWI-53 .
<ul style="list-style-type: none"> • Hazard warning lamp does not activate. • Hazard warning lamp continues activating. (Turn signal is normal.)	<ul style="list-style-type: none"> • Hazard switch • Harness between the hazard switch and BCM • BCM 	Hazard switch Refer to EXL-255 .	

Symptom Table

INFOID:000000003534196

NORMAL OPERATING CONDITION

< SYMPTOM DIAGNOSIS >

[HALOGEN TYPE]

NORMAL OPERATING CONDITION

Description

INFOID:000000003534052

AUTO LIGHT SYSTEM

The headlamp may not be turned ON/OFF immediately after passing dark area or bright area (short tunnel, sky bridge, shadowed area etc.) while using the auto light system. This causes for the control difference. This is normal.

A
B
C
D
E
F
G
H
I
J
K
EXL
M
N
O
P

BOTH SIDE HEADLAMPS (HI) ARE NOT TURNED ON

< SYMPTOM DIAGNOSIS >

[HALOGEN TYPE]

BOTH SIDE HEADLAMPS (HI) ARE NOT TURNED ON

Description

INFOID:000000003534192

Both side headlamps (HI) are not turned ON when setting to the lighting switch HI or PASS.

Diagnosis Procedure

INFOID:000000003534193

1.COMBINATION SWITCH INSPECTION

Check the combination switch. Refer to [BCS-82, "Symptom Table"](#).

Is the combination switch normal?

YES >> GO TO 2.

NO >> Repair or replace the malfunctioning part.

2.CHECK HEADLAMP (HI) REQUEST SIGNAL INPUT

ⓐCONSULT-III DATA MONITOR

1. Select "HL HI REQ" of IPDM E/R data monitor item.
2. With operating the lighting switch, check the monitor status.

Monitor item	Condition		Monitor status
HL HI REQ	Lighting switch (2ND)	HI or PASS	On
		LO	Off

Is the item status normal?

YES >> GO TO 3.

NO >> Replace BCM. Refer to [BCS-84, "Exploded View"](#).

3.HEADLAMP (HI) CIRCUIT INSPECTION

Check the headlamp (HI) circuit. Refer to [EXL-242, "Component Function Check"](#).

Is the headlamp (HI) circuit normal?

YES >> Replace IPDM E/R.

NO >> Repair or replace the malfunctioning part.

BOTH SIDE HEADLAMPS (LO) ARE NOT TURNED ON

< SYMPTOM DIAGNOSIS >

[HALOGEN TYPE]

BOTH SIDE HEADLAMPS (LO) ARE NOT TURNED ON

Description

INFOID:000000003534194

Both side headlamps (LO) are not turned ON in any condition.

Diagnosis Procedure

INFOID:000000003534195

1. CHECK COMBINATION SWITCH

Check the combination switch. Refer to [BCS-82. "Symptom Table"](#).

Is the combination switch normal?

YES >> GO TO 2.

NO >> Repair or replace the malfunctioning part.

2. CHECK HEADLAMP (LO) REQUEST SIGNAL INPUT

 CONSULT-III DATA MONITOR

1. Select "HL LO REQ" of IPDM E/R data monitor item.

2. With operating the lighting switch, check the monitor status.

Monitor item	Condition	Monitor status	
HL LO REQ	Lighting switch	2ND	On
		OFF	Off

Is the item status normal?

YES >> GO TO 3.

NO >> Replace BCM. Refer to [BCS-84. "Exploded View"](#).

3. HEADLAMP (LO) CIRCUIT INSPECTION

Check the headlamp (LO) circuit. Refer to [EXL-244. "Component Function Check"](#).

Is the headlamp (LO) circuit normal?

YES >> Replace IPDM E/R.

NO >> Repair or replace the malfunctioning part.

A
B
C
D
E
F
G
H
I
J
K
M
N
O
P

EXL

PARKING, LICENSE PLATE AND TAIL LAMPS ARE NOT TURNED ON

< SYMPTOM DIAGNOSIS >

[HALOGEN TYPE]

PARKING, LICENSE PLATE AND TAIL LAMPS ARE NOT TURNED ON

Description

INFOID:000000003756996

The parking, license plate, tail, side marker lamps and each illumination are not turned ON in any condition.

Diagnosis Procedure

INFOID:000000003756997

1.COMBINATION SWITCH INSPECTION

Check the combination switch. Refer to [BCS-82, "Symptom Table"](#).

Is the combination switch normal?

YES >> GO TO 2.

NO >> Repair or replace the malfunctioning part.

2.CHECK TAIL LAMP RELAY REQUEST SIGNAL INPUT

ⓅCONSULT-III DATA MONITOR

1. Select "TAIL & CLR REQ" of IPDM E/R data monitor item.
2. With operating the lighting switch, check the monitor status.

Monitor item	Condition	Monitor status	
TAIL & CLR REQ	Lighting switch	1ST	On
		OFF	Off

Is the item status normal?

YES >> GO TO 3.

NO >> Replace BCM.

3.TAIL LAMP CIRCUIT INSPECTION

Check the tail lamp circuit. Refer to [EXL-257, "Component Function Check"](#).

Is the tail lamp circuit normal?

YES >> Replace IPDM E/R.

NO >> Repair or replace the malfunctioning part.

BOTH SIDE FRONT FOG LAMPS ARE NOT TURNED ON

< SYMPTOM DIAGNOSIS >

[HALOGEN TYPE]

BOTH SIDE FRONT FOG LAMPS ARE NOT TURNED ON

Description

INFOID:000000003756998

The front fog lamps are not turned ON in any condition.

Diagnosis Procedure

INFOID:000000003756999

1.COMBINATION SWITCH INSPECTION

Check the combination switch. Refer to [BCS-82. "Symptom Table"](#).

Is the combination switch normal?

YES >> GO TO 2.

NO >> Repair or replace the malfunctioning part.

2.CHECK FRONT FOG LAMP REQUEST SIGNAL INPUT

CONSULT-III DATA MONITOR

1. Select "FR FOG REQ" of IPDM E/R data monitor item.
2. With operating the front fog lamp switch, check the monitor status.

Monitor item	Condition	Monitor status	
FR FOG REQ	Front fog lamp switch (Lighting switch 2ND)	ON	On
		OFF	Off

Is the item status normal?

YES >> GO TO 3.

NO >> Replace BCM.

3.FRONT FOG LAMP CIRCUIT INSPECTION

Check the front fog lamp circuit. Refer to [EXL-75. "Component Function Check"](#).

Is the front fog lamp circuit normal?

YES >> Replace IPDM E/R.

NO >> Repair or replace the malfunctioning part.

A
B
C
D
E
F
G
H
I
J
K
M
N
O
P

EXL

PRECAUTION

PRECAUTIONS

Precaution for Supplemental Restraint System (SRS) "AIR BAG" and "SEAT BELT PRE-TENSIONER"

INFOID:000000003534061

The Supplemental Restraint System such as "AIR BAG" and "SEAT BELT PRE-TENSIONER", used along with a front seat belt, helps to reduce the risk or severity of injury to the driver and front passenger for certain types of collision. This system includes seat belt switch inputs and dual stage front air bag modules. The SRS system uses the seat belt switches to determine the front air bag deployment, and may only deploy one front air bag, depending on the severity of a collision and whether the front occupants are belted or unbelted. Information necessary to service the system safely is included in the "SRS AIRBAG" and "SEAT BELT" of this Service Manual.

WARNING:

- To avoid rendering the SRS inoperative, which could increase the risk of personal injury or death in the event of a collision which would result in air bag inflation, all maintenance must be performed by an authorized NISSAN/INFINITI dealer.
- Improper maintenance, including incorrect removal and installation of the SRS, can lead to personal injury caused by unintentional activation of the system. For removal of Spiral Cable and Air Bag Module, see the "SRS AIRBAG".
- Do not use electrical test equipment on any circuit related to the SRS unless instructed to in this Service Manual. SRS wiring harnesses can be identified by yellow and/or orange harnesses or harness connectors.

HEADLAMP AIMING ADJUSTMENT

< ON-VEHICLE MAINTENANCE >

[HALOGEN TYPE]

ON-VEHICLE MAINTENANCE

HEADLAMP AIMING ADJUSTMENT

Description

INFOID:000000003534064

PREPARATION BEFORE ADJUSTING

NOTE:

- For details, refer to the regulations in your own country.
- Perform aiming if the vehicle front body has been repaired and/or the headlamp assembly has been replaced.

Before performing aiming adjustment, check the following.

- Adjust the tire pressure to the specification.
- Fill with fuel, engine coolant and each oil.
- Maintain the unloaded vehicle condition. (Remove luggage from the passenger compartment and the trunk room.)

NOTE:

Do not remove the temporary tire, jack and on-vehicle tool.

- Wipe out dirt on the headlamp.

CAUTION:

Never use organic solvent (thinner, gasoline etc.)

- Ride alone on the driver seat.

AIMING ADJUSTMENT SCREW

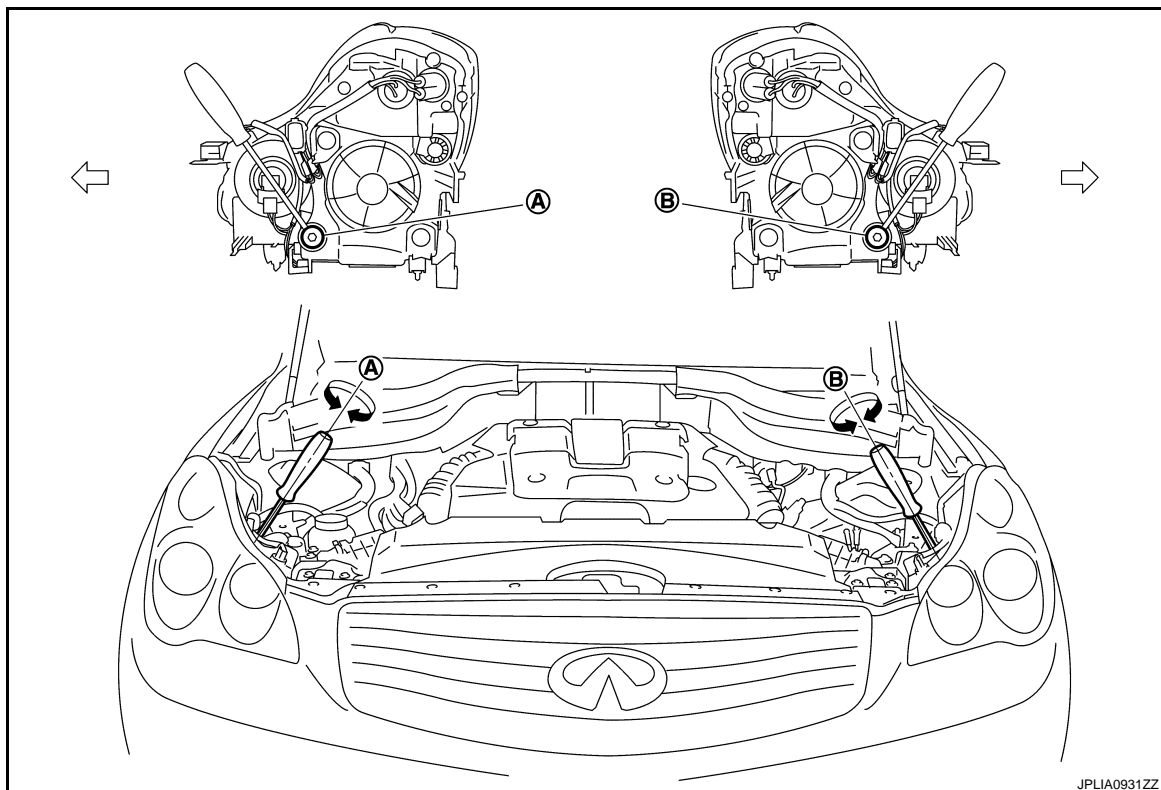

A Headlamp RH (UP/DOWN) adjustment screw B. Headlamp LH (UP/DOWN) adjustment screw

←: Vehicle center

NOTE:

The figure is the vehicle without AFS. Each adjustment screw is applied to the vehicle with AFS.

HEADLAMP AIMING ADJUSTMENT

< ON-VEHICLE MAINTENANCE >

[HALOGEN TYPE]

Adjustment screw		Screw driver rotation	Facing direction
A	Headlamp RH (UP/DOWN)	Clockwise	UP
		Counterclockwise	DOWN
B	Headlamp LH (UP/DOWN)	Clockwise	UP
		Counterclockwise	DOWN

Aiming Adjustment Procedure

INFOID:000000003534065

- Place the screen.

NOTE:

- Stop the vehicle facing the wall.
- Place the board on a plain road vertically.

- Face the vehicle with the screen. Maintain 10 m (32.8 ft) between the headlamp center and the screen.
- Start the engine. Turn the headlamp (LO) ON.

NOTE:

Shut off the headlamp light with the board to prevent from illuminating the adjustment screen.

CAUTION:

Never cover the lens surface with a tape etc. The lens is made of resin.

- Measure the distance (X) between the horizontal center line of headlamp (H) and the cutoff line (A) within the light axis measurement range (R) from the vertical center line ahead of headlamp (V).

Light axis measurement range (R) : 350 ± 175 mm (13.78 ± 6.89 in)

Low beam distribution on the screen

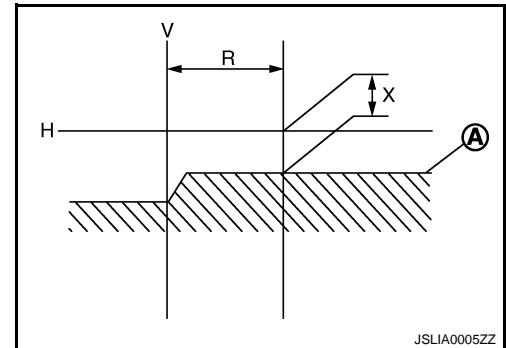

JSLIA0005ZZ

- Adjust the cutoff line height (X) with the aiming adjustment screw so as to enter in the adjustment range (M–N) according to the horizontal center line of headlamp (H).

unit: mm (in)

Horizontal center line of headlamp (H)	Highest cutoff line height (M)	Lowest cutoff line height (N)
700 (27.56) or less	4 (0.16)	30 (1.18)
701(27.60) – 800 (31.50)	4 (0.16)	30 (1.18)
801 (31.54) or more	17 (0.67)	44 (1.73)

Side view

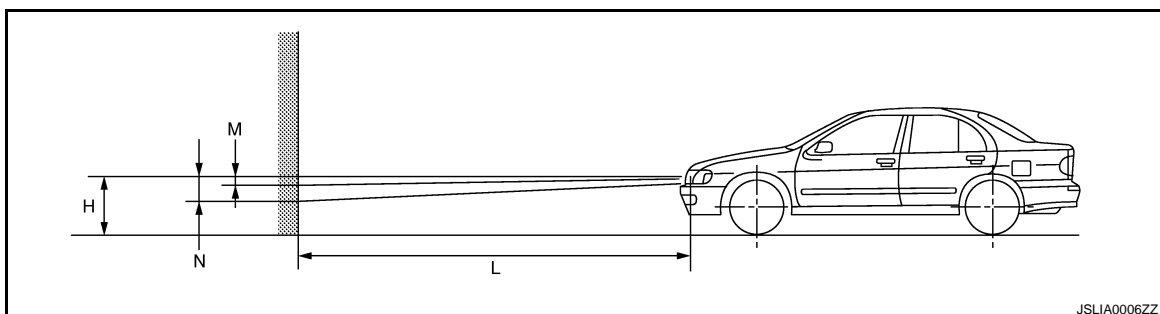

JSLIA0006ZZ

HEADLAMP AIMING ADJUSTMENT

< ON-VEHICLE MAINTENANCE >

[HALOGEN TYPE]

Distance between the headlamp center and the screen (L) : 10 m (32.8 ft)

A

B

C

D

E

F

G

H

I

J

K

EXL

M

N

O

P

FRONT FOG LAMP AIMING ADJUSTMENT

< ON-VEHICLE MAINTENANCE >

[HALOGEN TYPE]

FRONT FOG LAMP AIMING ADJUSTMENT

Description

INFOID:000000003757000

PREPARATION BEFORE ADJUSTING

NOTE:

- For details, refer to the regulations in your own country.
- Perform aiming if the vehicle front body has been repaired and/or the headlamp assembly has been replaced.

Before performing aiming adjustment, check the following.

- Adjust the tire pressure to the specification.
- Fill with fuel, engine coolant and each oil.
- Maintain the unloaded vehicle condition. (Remove luggage from the passenger compartment and the trunk room.)

NOTE:

Do not remove the temporary tire, jack and on-vehicle tool.

- Wipe out dirt on the headlamp.

CAUTION:

Never use organic solvent (thinner, gasoline etc.)

- Ride alone on the driver seat.

AIMING ADJUSTMENT SCREW

- Turn the aiming adjusting screw for adjustment.

A: UP

B: DOWN

- For the position and direction of the adjusting screw, refer to the figure.

NOTE:

A screwdriver or hexagonal wrench [6 mm (0.24 in)] can be used for adjustment.

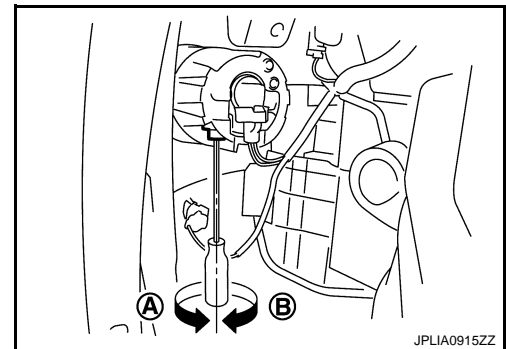

Aiming Adjustment Procedure

INFOID:000000003757002

1. Place the screen.

NOTE:

- Stop the vehicle facing the wall.
- Place the board on a plain road vertically.

2. Face the vehicle with the screen. Maintain 10 m (32.8 ft) between the front fog lamp center and the screen.

3. Start the engine. Turn the front fog lamp ON.

NOTE:

Shut off the headlamp light with the board to prevent from illuminating the adjustment screen.

CAUTION:

Never cover the lens surface with a tape etc. The lens is made of resin.

4. Adjust the cutoff line height (A) with the aiming adjustment screw so that the distance (X) between the horizontal center line of front fog lamp (H) and (A) becomes 200 mm (7.87 in).

FRONT FOG LAMP AIMING ADJUSTMENT

< ON-VEHICLE MAINTENANCE >

[HALOGEN TYPE]

Front fog lamp light distribution on the screen

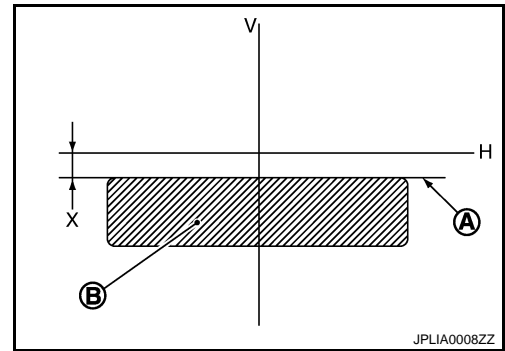

- A : Cutoff line
- B : High illuminance area
- H : Horizontal center line of front fog lamp
- V : Vertical center line of front fog lamp
- X : Cutoff line height

A
B
C
D
E
F
G
H
I
J
K
L
M
N
O
P

EXL

FRONT COMBINATION LAMP

< ON-VEHICLE REPAIR >

[HALOGEN TYPE]

ON-VEHICLE REPAIR

FRONT COMBINATION LAMP

Exploded View

INFOID:000000003534199

REMOVAL

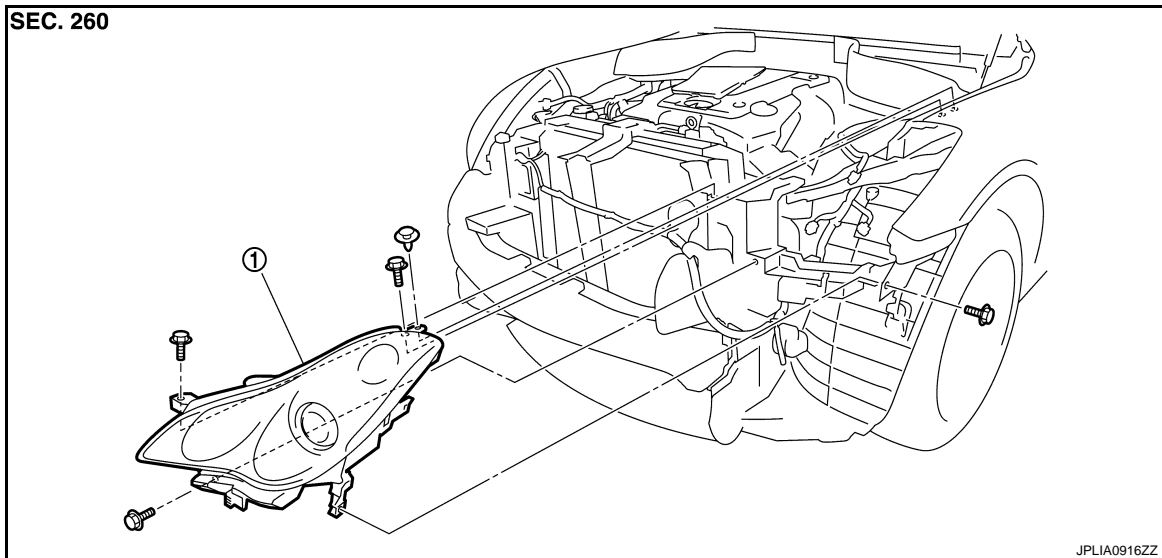

1. Front combination lamp

DISASSEMBLY

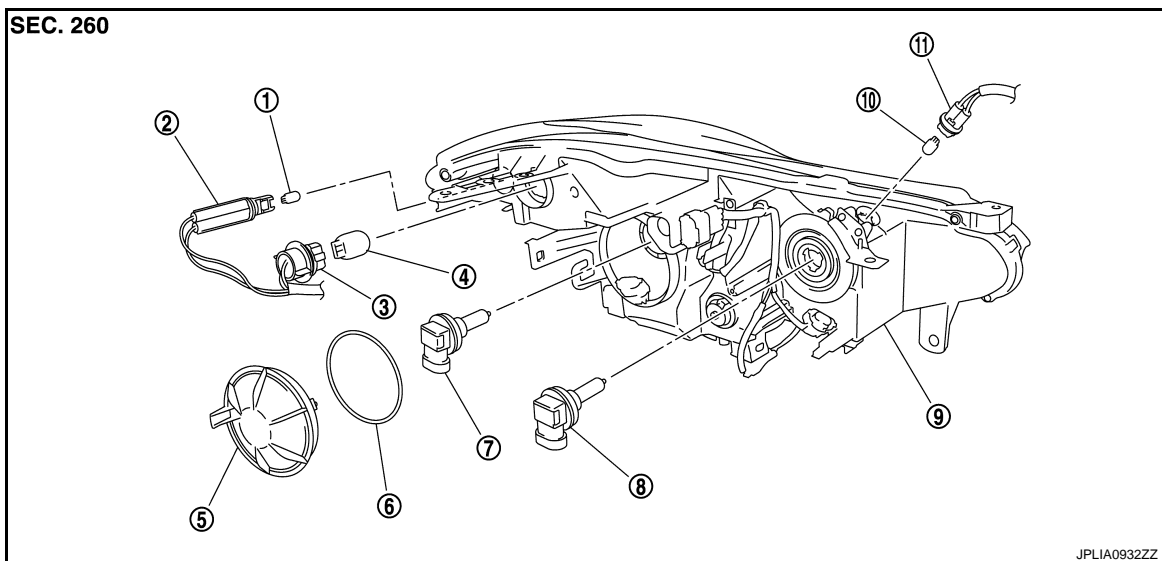

- | | | |
|--------------------------------|---------------------------------------|---------------------------------------|
| 1. Front side marker lamp bulb | 2. Front side marker lamp bulb socket | 3. Front turn signal lamp bulb socket |
| 4. Front turn signal lamp bulb | 5. Resin cap | 6. Seal packing |
| 7. Halogen bulb (LO) | 8. Halogen bulb (HI) | 9. Headlamp housing assembly |
| 10. Parking lamp bulb | 11. Parking lamp bulb socket | |

Removal and Installation

INFOID:000000003534200

REMOVAL

CAUTION:

FRONT COMBINATION LAMP

< ON-VEHICLE REPAIR >

[HALOGEN TYPE]

Disconnect the battery negative terminal or remove the fuse.

1. Remove the front bumper fascia. Refer to [EXT-12, "Exploded View"](#).
2. Remove the headlamp mounting bolts and clips.
3. Remove the harness clip and the holding clip (A)*.
*: Left side only.

↶ : Vehicle front

4. Pull out the headlamp assembly forward the vehicle.
5. Disconnect the connector before removing the headlamp assembly.

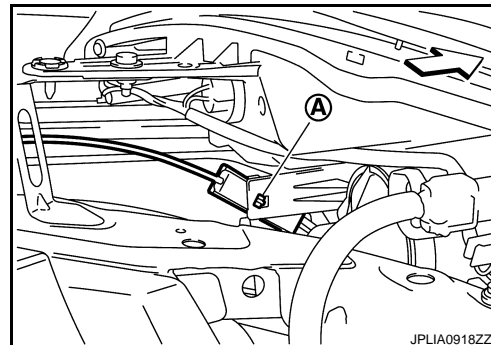

INSTALLATION

Install in the reverse order of removal.

NOTE:

After installation, perform aiming adjustment. Refer to [EXL-347, "Description"](#).

Replacement

INFOID:000000003534201

CAUTION:

- **Disconnect the battery negative terminal or remove the fuse.**
- **After installing the bulb, install the resin cap and the bulb socket securely for watertightness.**
- **Never touch the glass of bulb directly by hand. Keep grease and other oily matters away from it. Never touch bulb by hand while it is lit or right after being turned off.**
- **Never leave bulb out of lamp reflector for a long time because dust, moisture smoke, etc. may affect the performance of lamp. When replacing bulb, be sure to replace it with new one.**

HEADLAMP BULB (LO)

1. Remove the fender rubber protector in the engine room. Keep a service area.
2. Rotate the resin cap counterclockwise and unlock it.
3. Disconnect the headlamp (LO) bulb connector.
4. Rotate the bulb counterclockwise and unlock it.
5. Remove the bulb from the headlamp housing assembly.

HEADLAMP BULB (HI)

1. Remove the washer tank inlet*. Refer to [WW-100, "Exploded View"](#).
*:When replace a right.
2. Disconnect the headlamp (HI) bulb connector.
3. Rotate the bulb socket counterclockwise and unlock it.
4. Remove the bulb socket from the headlamp housing assembly.

PARKING LAMP BULB

1. Rotate the bulb socket counterclockwise and unlock it.
2. Remove the bulb from the bulb socket.

FRONT TURN SIGNAL LAMP BULB

1. Remove the fender rubber protector in the engine room. Keep a service area.
2. Rotate the bulb socket counterclockwise and unlock it.
3. Remove the bulb from the bulb socket.

FRONT SIDE MARKER LAMP BULB

1. Remove the fender rubber protector in the engine room. Keep a service area.
2. Rotate the bulb socket counterclockwise and unlock it.
3. Remove the bulb from the bulb socket.

A
B
C
D
E
F
G
H
I
J
K
EXL
M
N
O
P

FRONT COMBINATION LAMP

< ON-VEHICLE REPAIR >

[HALOGEN TYPE]

Disassembly and Assembly

INFOID:000000003534202

DISASSEMBLY

1. Rotate the resin cap counterclockwise and unlock it.
2. Disconnect the headlamp bulb (LO) connector.
3. Rotate the headlamp bulb (LO) counterclockwise and unlock it
4. Remove the bulb from the headlamp housing assembly.
5. Rotate the headlamp bulb (HI) counterclockwise and unlock it
6. Remove the bulb from the headlamp housing assembly.
7. Rotate the parking lamp bulb socket counterclockwise and unlock it.
8. Remove the bulb from the parking lamp bulb socket.
9. Rotate the front turn signal lamp bulb socket counterclockwise and unlock it.
10. Remove the bulb from the front turn signal lamp bulb socket.
11. Rotate the front side marker lamp bulb socket counterclockwise and unlock it.
12. Remove the bulb from the front side marker lamp bulb socket.

ASSEMBLY

Assemble in the reverse order of disassembly.

FRONT FOG LAMP

< ON-VEHICLE REPAIR >

[HALOGEN TYPE]

FRONT FOG LAMP

Exploded View

INFOID:000000003757003

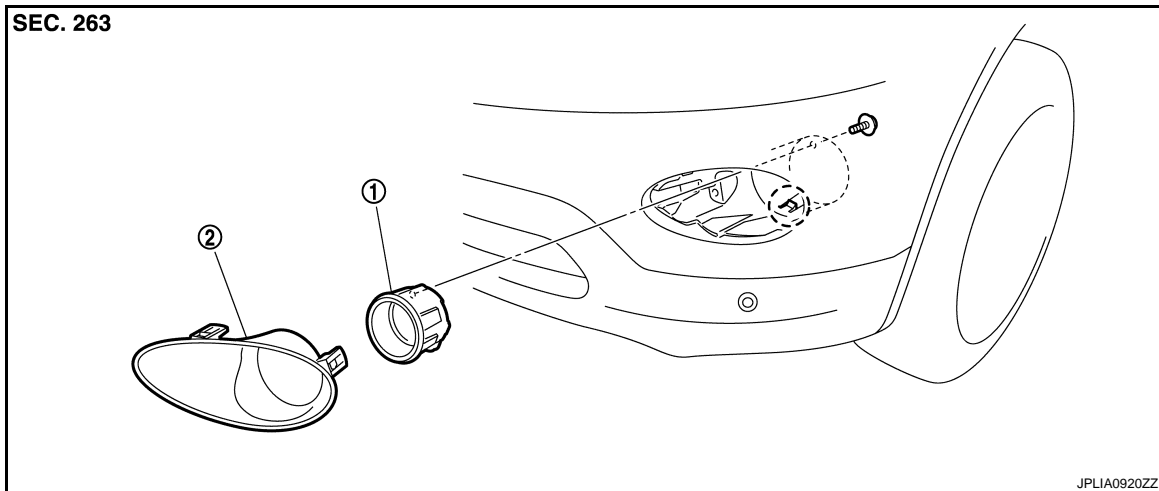

1. Front fog lamp
2. Front fog lamp finisher

 : Pawl

Removal and Installation

INFOID:000000003757004

CAUTION:
Disconnect the battery negative terminal or remove the fuse.

REMOVAL

1. Remove the front fender protector. Keep a service area. Refer to [EXT-25. "FENDER PROTECTOR : Exploded View"](#).
2. Remove the front fog lamp finisher.
3. Remove the front fog lamp connector.
4. Remove the screw.
5. Disengage the pawl. And then remove the front fog lamp.

INSTALLATION

Installation is the reverse order of removal.

NOTE:

After installation, perform aiming adjustment. Refer to [EXL-350. "Description"](#)

Replacement

INFOID:000000003757005

CAUTION:

- Disconnect the battery negative terminal or remove the fuse.
- Never touch the glass of bulb directly by hand. Keep grease and other oily matters away from it. Never touch bulb by hand while it is lit or right after being turned off.
- Never leave bulb out of lamp reflector for a long time because dust, moisture smoke, etc. may affect the performance of lamp. When replacing bulb, be sure to replace it with new one.

FRONT FOG LAMP BULB

1. Remove the front fender protector. Keep the service area. Refer to [EXT-25. "FENDER PROTECTOR : Exploded View"](#).

FRONT FOG LAMP

[HALOGEN TYPE]

< ON-VEHICLE REPAIR >

2. Remove the front fog lamp bulb connector (1).
3. Rotate the bulb (2) counterclockwise and unlock it.

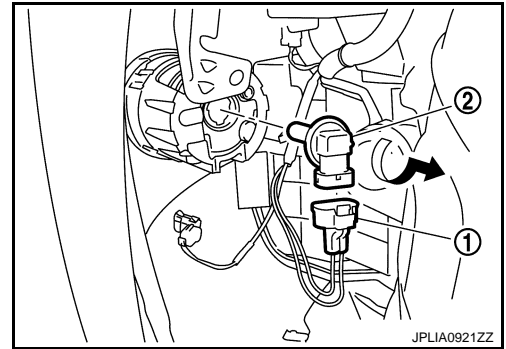

OPTICAL SENSOR

Exploded View

INFOID:000000003757006

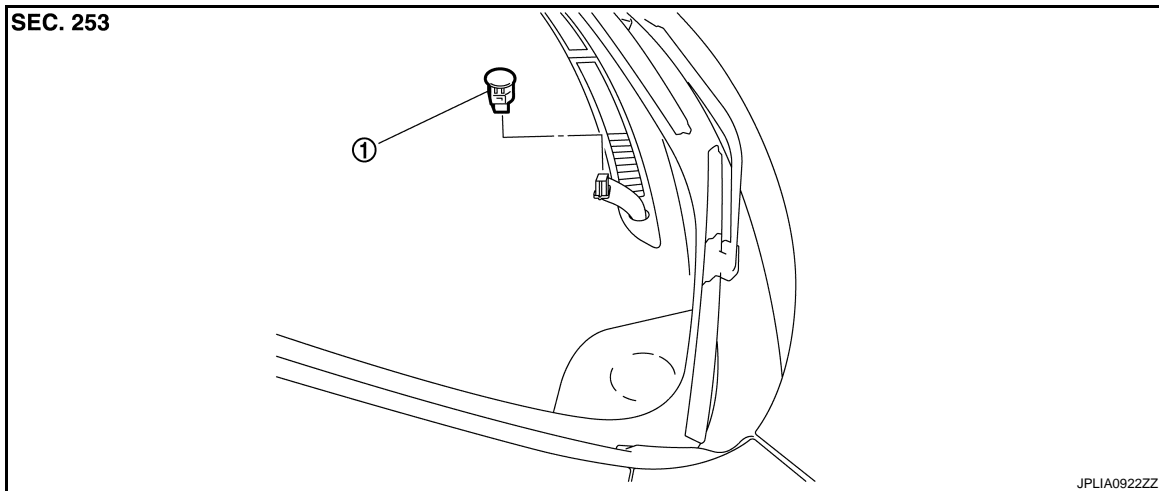

1. Optical sensor

Removal and Installation

INFOID:000000003757007

REMOVAL

1. Insert an appropriate tool between the optical sensor and the instrument upper panel. Pull out the optical sensor upward.
2. Disconnect the optical sensor connector. And then remove the optical sensor.

INSTALLATION

Install in the reverse order of removal.

A
B
C
D
E
F
G
H
I
J
K
EXL
M
N
O
P

LIGHTING AND TURN SIGNAL SWITCH

< ON-VEHICLE REPAIR >

[HALOGEN TYPE]

LIGHTING AND TURN SIGNAL SWITCH

Exploded View

INFOID:000000003757008

Lighting and turn signal switch is integrated in the combination switch. [BCS-85. "Exploded View"](#).

HAZARD SWITCH

< ON-VEHICLE REPAIR >

[HALOGEN TYPE]

HAZARD SWITCH

Exploded View

INFOID:000000003757009

The hazard warning switch is integrated in the multifunction switch. Refer to [AV-163. "Exploded View"](#).

- A
- B
- C
- D
- E
- F
- G
- H
- I
- J
- K
- EXL
- M
- N
- O
- P

REAR COMBINATION LAMP

< ON-VEHICLE REPAIR >

[HALOGEN TYPE]

REAR COMBINATION LAMP

Exploded View

INFOID:000000003757010

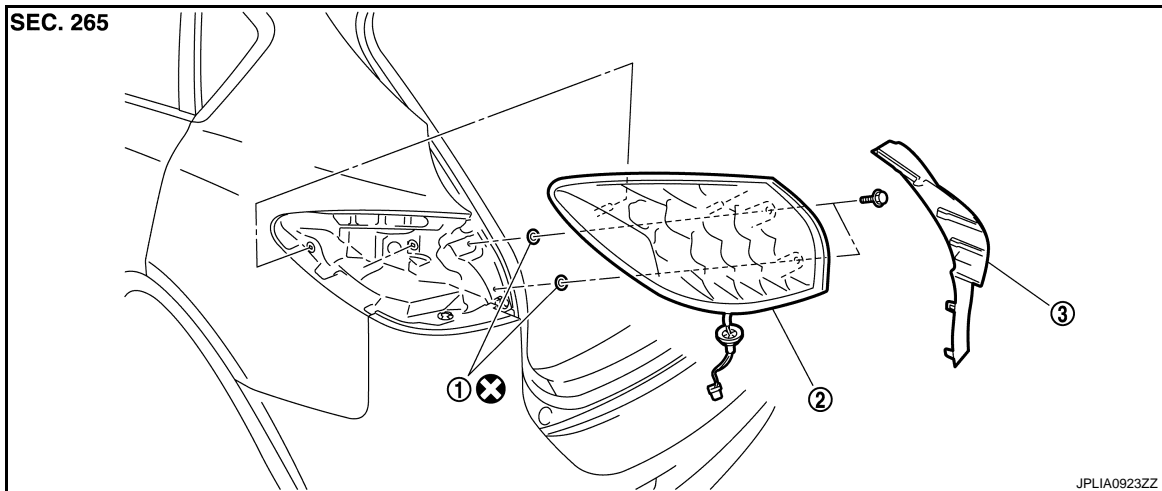

1. Seal packing
2. Rear combination lamp
3. Rear combination lamp finisher

Refer to [GI-4, "Components"](#) for symbols in the figure.

Removal and Installation

INFOID:000000003757011

CAUTION:

Disconnect the battery negative terminal or remove the fuse.

REMOVAL

1. Remove the luggage side finisher lower. Refer to [INT-34, "Exploded View"](#).
2. Remove the rear combination lamp finisher.
3. Remove the rear combination lamp mounting bolts.
4. Disconnect the rear combination lamp connector.
5. Pull the rear combination lamp toward outside of the vehicle. Remove the rear combination lamp.

INSTALLATION

Install in the reverse order of removal.

CAUTION:

Seal packing cannot be reused.

REAR TURN SIGNAL LAMP

< ON-VEHICLE REPAIR >

[HALOGEN TYPE]

REAR TURN SIGNAL LAMP

Exploded View

INFOID:000000003757013

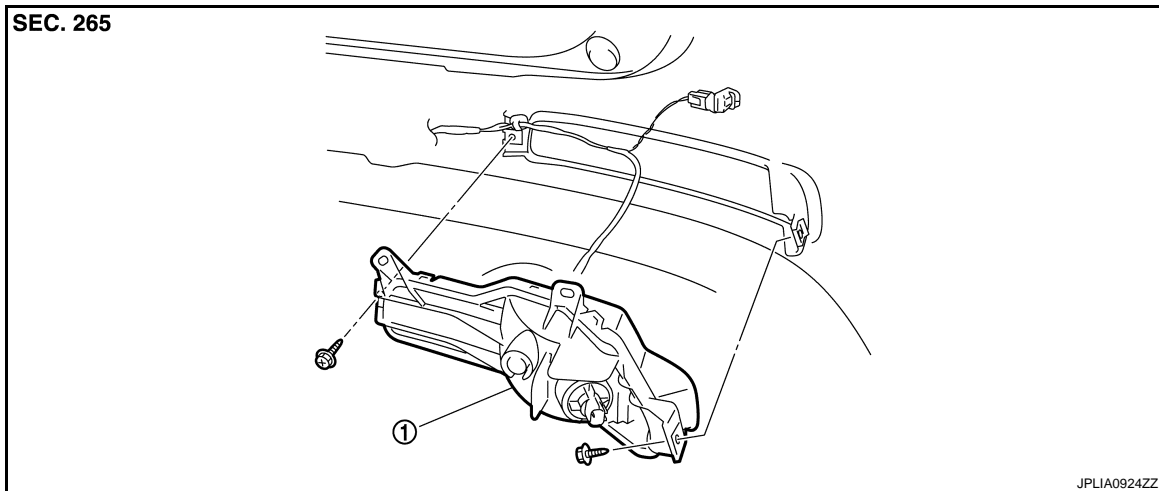

1. Rear turn signal lamp

Removal and Installation

INFOID:000000003757014

CAUTION:
Disconnect the battery negative terminal or remove the fuse.

REMOVAL

1. Remove the rear bumper fascia. Refer to [EXT-16, "Exploded View"](#).
2. Remove the rear turn signal lamp.

INSTALLATION

Install in the reverse order of removal.

Replacement

INFOID:000000003757015

- CAUTION:**
- Disconnect the battery negative terminal or remove the fuse.
 - Never touch the glass of bulb directly by hand. Keep grease and other oily matters away from it. Never touch bulb by hand while it is lit or right after being turned off.
 - Never leave bulb out of lamp reflector for a long time because dust, moisture smoke, etc. may affect the performance of lamp. When replacing bulb, be sure to replace it with new one.

REAR TURN SIGNAL LAMP BULB

1. Turn the bulb socket (1) counterclockwise and unlock it.
2. Remove the bulb (2) from the socket.

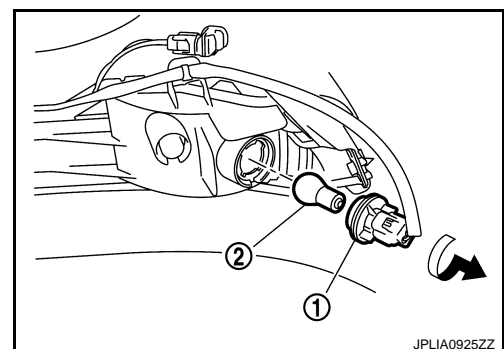

HIGH-MOUNTED STOP LAMP

< ON-VEHICLE REPAIR >

[HALOGEN TYPE]

HIGH-MOUNTED STOP LAMP

Exploded View

INFOID:000000003757016

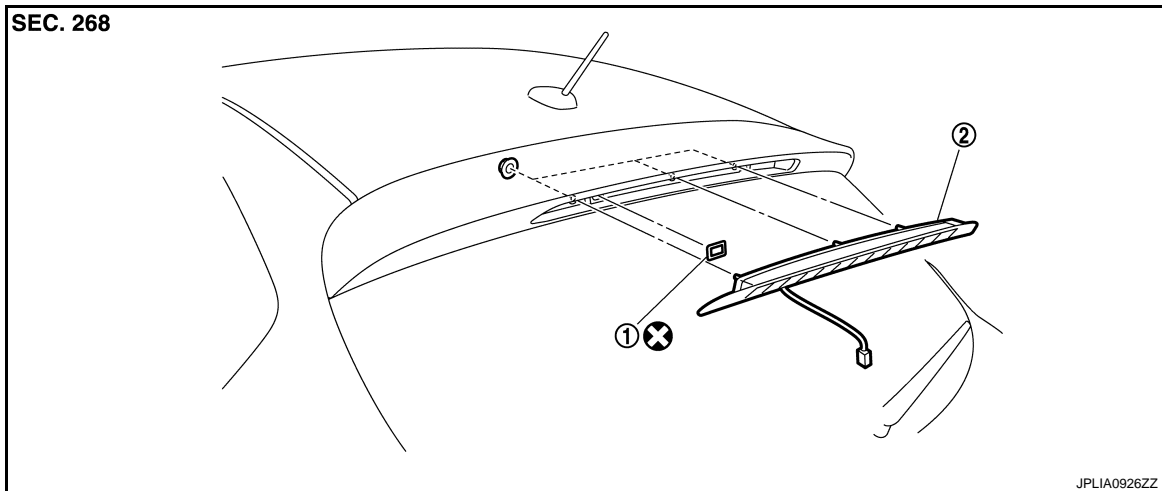

1. Seal packing
2. High-mounted stop lamp

Refer to [GI-4, "Components"](#) for symbols in the figure.

Removal and Installation

INFOID:000000003757017

REMOVAL

1. Remove the back door plate. Refer to [INT-38, "Exploded View"](#).
2. Remove the high-mounted stop lamp mounting nuts.
3. Disconnect the high-mounted stop lamp connector. And then remove the rear washer tube.
4. Pull the high-mounted stop lamp toward rear of the vehicle.
5. Remove the high-mounted stop lamp.

INSTALLATION

Install in the reverse order of removal.

CAUTION:

Seal packing cannot be reused.

BACK-UP LAMP

< ON-VEHICLE REPAIR >

[HALOGEN TYPE]

BACK-UP LAMP

Exploded View

INFOID:000000003757020

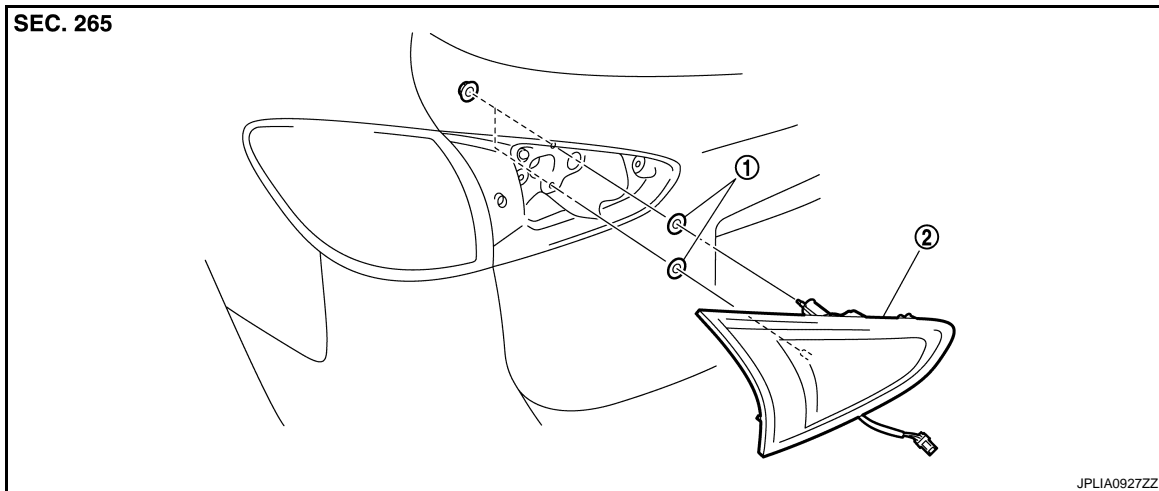

1. Seal packing
2. Back-up lamp

Removal and Installation

INFOID:000000003757021

CAUTION:
Disconnect the battery negative terminal or remove the fuse.

REMOVAL

1. Remove the back door finisher inner. Refer to [INT-38, "Exploded View"](#).
2. Remove the back-up lamp mounting nuts.
3. Disconnect the back-up lamp connector. And then remove the back-up lamp.

INSTALLATION

Install in the reverse order of removal.

Replacement

INFOID:000000003757022

- CAUTION:**
- Disconnect the battery negative terminal or remove the fuse.
 - Never touch the glass of bulb directly by hand. Keep grease and other oily matters away from it. Never touch bulb by hand while it is lit or right after being turned off.
 - Never leave bulb out of lamp reflector for a long time because dust, moisture smoke, etc. may affect the performance of lamp. When replacing bulb, be sure to replace it with new one.

BACK-UP LAMP BULB

1. Remove the back-up lamp. Refer to [EXL-363, "Exploded View"](#).
2. Turn the bulb socket (1) counterclockwise and unlock it.
3. Remove the bulb (2) from the socket.

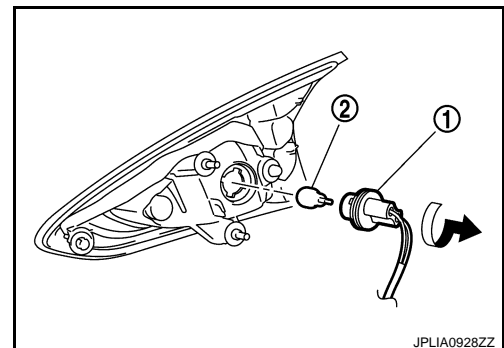

LICENSE PLATE LAMP

< ON-VEHICLE REPAIR >

[HALOGEN TYPE]

LICENSE PLATE LAMP

Exploded View

INFOID:000000003757023

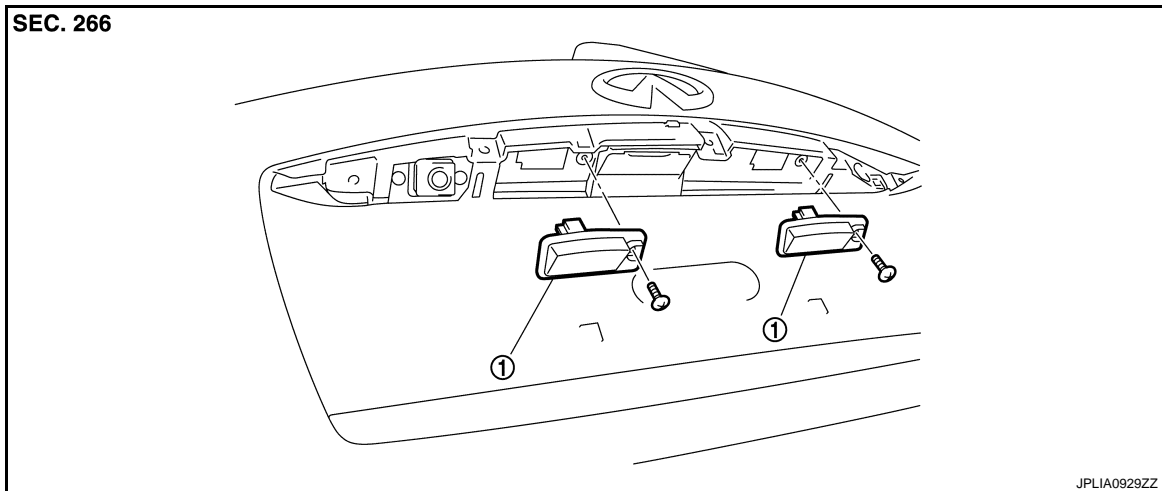

1. License plate lamp

Removal and Installation

INFOID:000000003757024

CAUTION:

Disconnect the battery negative terminal or remove the fuse.

REMOVAL

1. Remove the door handle cover. Refer to [INT-38, "Exploded View"](#).
2. Remove the screw. And then remove the license plate lamp.
3. Disconnect the license plate lamp connector.

INSTALLATION

Install in the reverse order of removal.

Replacement

INFOID:000000003757025

CAUTION:

- **Disconnect the battery negative terminal or remove the fuse.**
- **Never touch the glass of bulb directly by hand. Keep grease and other oily matters away from it. Never touch bulb by hand while it is lit or right after being turned off.**
- **Never leave bulb out of lamp reflector for a long time because dust, moisture smoke, etc. may affect the performance of lamp. When replacing bulb, be sure to replace it with new one.**

LICENSE PLATE LAMP BULB

1. Remove the back door finisher inner. Refer to [INT-38, "Exploded View"](#).
2. Turn the bulb socket (1) counterclockwise and unlock it.
3. Remove the bulb (2) from the socket.

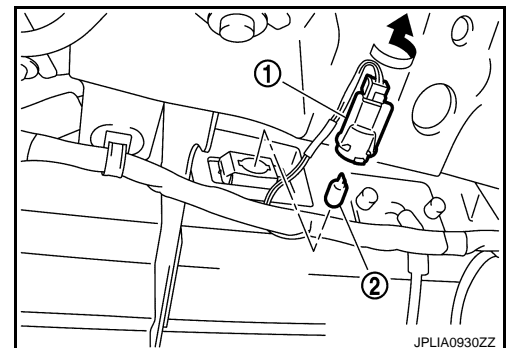

SERVICE DATA AND SPECIFICATIONS (SDS)

< SERVICE DATA AND SPECIFICATIONS (SDS)

[HALOGEN TYPE]

SERVICE DATA AND SPECIFICATIONS (SDS)

SERVICE DATA AND SPECIFICATIONS (SDS)

Bulb Specifications

INFOID:000000003534097

Item	Type	Wattage (W)
Front combination lamp	Headlamp (HI)	H9 (Halogen) 65
	Headlamp (LO)	H11 (Halogen) 55
	Front turn signal lamp	W21W 21
	Parking lamp	W5W 5
	Front side marker lamp	W5W 5
Front fog lamp	H8 35	
Rear combination lamp	Stop lamp/Tail lamp	LED —
	Rear side marker lamp	LED —
Rear turn signal lamp	PY21W (Amber) 21	
Back-up lamp	W16W 16	
License plate lamp	W5W 5	
High-mounted stop lamp	LED —	

A
B
C
D
E
F
G
H
I
J
K
L
M
N
O
P

EXL