

SECTION **DEF**
DEFOGGER

A
 B
 C
 D
 E
 F
 G
 H
 I
 J
 K
DEF
 M
 N
 O
 P

CONTENTS

BASIC INSPECTION	3	Diagnosis Procedure	13
DIAGNOSIS AND REPAIR WORKFLOW	3	Component Inspection	15
Work Flow	3	DOOR MIRROR DEFOGGER	16
FUNCTION DIAGNOSIS	4	Description	16
REAR WINDOW DEFOGGER SYSTEM	4	Component Function Check	16
System Diagram	4	Diagnosis Procedure	16
System Description	4	DRIVER SIDE DOOR MIRROR DEFOGGER ...	17
Component Parts Location	5	Description	17
Component Description	5	Component Function Check	17
DIAGNOSIS SYSTEM (BCM)	7	Diagnosis Procedure	17
COMMON ITEM	7	PASSENGER SIDE DOOR MIRROR DEFOGGER	19
COMMON ITEM : CONSULT-III Function (BCM -		Description	19
COMMON ITEM)	7	Component Function Check	19
REAR WINDOW DEFOGGER	8	Diagnosis Procedure	19
REAR WINDOW DEFOGGER : CONSULT-III		REAR WINDOW DEFOGGER SYSTEM	21
Function (BCM - REAR DEFOGGER)	8	Wiring Diagram - DEFOGGER SYSTEM -	21
COMPONENT DIAGNOSIS	9	ECU DIAGNOSIS	26
POWER SUPPLY AND GROUND CIRCUIT	9	BCM (BODY CONTROL MODULE)	26
Diagnosis Procedure	9	Reference Value	26
REAR WINDOW DEFOGGER SWITCH	10	Wiring Diagram - BCM -	50
Description	10	Fail-safe	56
Component Function Check	10	DTC Inspection Priority Chart	58
Diagnosis Procedure	10	DTC Index	60
REAR WINDOW DEFOGGER RELAY	11	SYMPTOM DIAGNOSIS	62
Description	11	REAR WINDOW DEFOGGER DOES NOT	
Component Function Check	11	OPERATE	62
Diagnosis Procedure	11	Diagnosis Procedure	62
Component Inspection	12	REAR WINDOW DEFOGGER AND DOOR	
REAR WINDOW DEFOGGER	13	MIRROR DEFOGGER DO NOT OPERATE.	63
Description	13	Diagnosis Procedure	63
Component Function Check	13		

REAR WINDOW DEFOGGER DOES NOT OPERATE BUT BOTH DOOR MIRROR DEFOGGERS OPERATE.	64	Diagnosis Procedure	64
DOOR MIRROR DEFOGGER DOES NOT OPERATE	65	REAR WINDOW DEFOGGER INDICATOR DOES NOT ILLUMINATE	67
BOTH SIDES	65	Diagnosis Procedure	67
BOTH SIDES : Diagnosis Procedure	65	PRECAUTION	68
DRIVER SIDE	65	PRECAUTIONS	68
DRIVER SIDE : Diagnosis Procedure	65	Precaution for Supplemental Restraint System (SRS) "AIR BAG" and "SEAT BELT PRE-TENSIONER"	68
PASSENGER SIDE	65	ON-VEHICLE REPAIR	69
PASSENGER SIDE : Diagnosis Procedure	65	FILAMENT	69
ON IS NOT DISPLAYED WHEN PRESSING REAR WINDOW DEFOGGER SWITCH BUT IT IS OPERATED	66	Inspection and Repair	69

DIAGNOSIS AND REPAIR WORKFLOW

< BASIC INSPECTION >

BASIC INSPECTION

DIAGNOSIS AND REPAIR WORKFLOW

Work Flow

INFOID:000000003136640

DETAILED FLOW

1.OBTAIN INFORMATION ABOUT SYMPTOM

Interview the customer to obtain the malfunction information (conditions and environment when the malfunction occurred) as much as possible when the customer brings the vehicle in.

>> GO TO 2.

2.CHECK DTC

Perform self diagnosis with CONSULT-III

Is any DTC detected?

YES >> Refer to [DEF-60. "DTC Index"](#)

NO >> GO TO 3.

3.REPRODUCE THE MALFUNCTION INFORMATION

Check the malfunction on the vehicle that the customer describes.

Inspect the relation of the symptoms and the condition when the symptoms occur.

>> GO TO 4.

4.IDENTIFY THE MALFUNCTIONING SYSTEM WITH "SYMPTOM DIAGNOSIS"

Use "Symptom diagnosis" from the symptom inspection result in step 3. Then identify where to start performing the diagnosis based on possible causes and symptoms.

>> GO TO 5.

5.IDENTIFY MALFUNCTIONING PARTS WITH "COMPONENT DIAGNOSIS"

Perform the diagnosis with "Component diagnosis" of the applicable system.

>> GO TO 6.

6.REPAIR OR REPLACE THE MALFUNCTIONING PARTS

Repair or replace the specified malfunctioning parts.

>> GO TO 7.

7.FINAL CHECK

Check that malfunctions are not reproduced when obtaining the malfunction information from the customer, referring to the symptom inspection result in step 3.

Are all malfunctions corrected?

YES >> INSPECTION END

NO >> GO TO 4.

A
B
C
D
E
F
G
H
I
J
K
DEF
M
N
O
P

REAR WINDOW DEFOGGER SYSTEM

< FUNCTION DIAGNOSIS >

FUNCTION DIAGNOSIS

REAR WINDOW DEFOGGER SYSTEM

System Diagram

INFOID:000000003136641

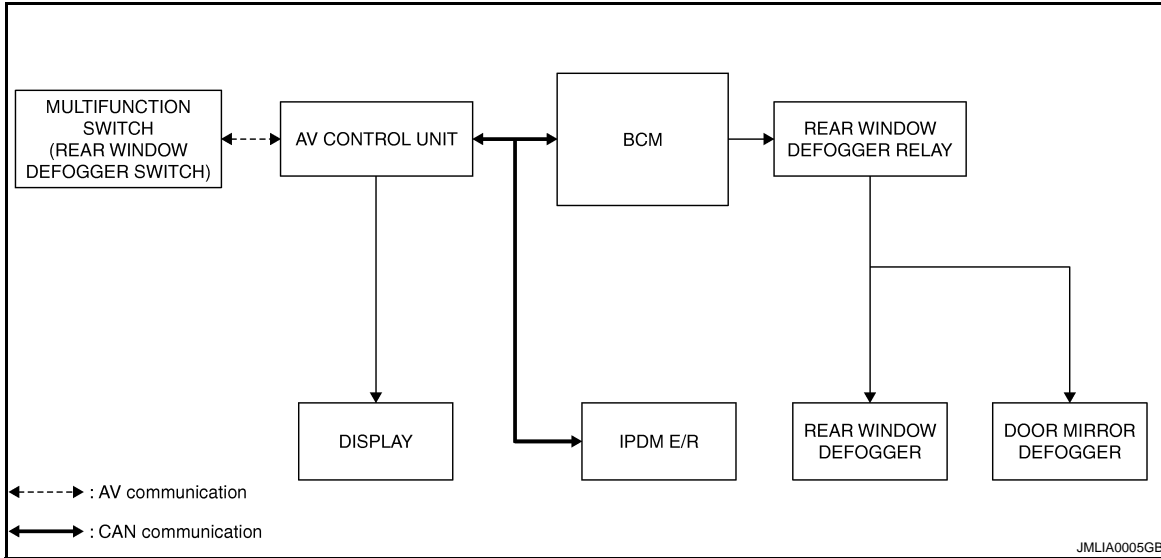

System Description

INFOID:000000003136642

Operation Description

- Turn rear window defogger switch ON when the ignition switch is turned ON. Then multifunction switch (rear window defogger switch) transmits rear window defogger switch signal to AV control unit via AV communication. AV control unit transmits rear window defogger switch signal to BCM via CAN communication.
- BCM turns rear window defogger relay ON and transmits rear window defogger control signal to IPDM E/R via CAN communication when rear window defogger switch signal is received.
- Rear window defogger and door mirror defogger (with mirror defogger) are supplied with power and operate when rear window defogger relay turns ON.
- IPDM E/R transmits rear window defogger control signal to AV control unit via CAN communication.
- AV control unit transmit rear defogger indicator signal to multifunction switch (rear window defogger switch) via AV communication then rear window defogger indicator is illuminated.

Timer function

- BCM turns rear window defogger relay ON for approximately 15 minutes when rear window defogger switch is turned ON. It makes rear window defogger and door mirror defogger (with mirror defogger) operate.
- Timer is canceled after pressing rear window defogger switch again during timer operation. Then BCM turns rear window defogger relay OFF. The same reaction also occurs during timer operation, if the ignition switch is turned OFF.

INPUT/OUTPUT SIGNAL CHART

Switch	Input signal to BCM	BCM function	Actuator
Rear window defogger switch	Defogger switch signal	Rear window defogger & Door mirror defogger* control	Rear window defogger
Push button ignition switch	Ignition signal		Door mirror defogger*

*: With mirror defogger

REAR WINDOW DEFOGGER SYSTEM

< FUNCTION DIAGNOSIS >

Component Parts Location

INFOID:000000003136643

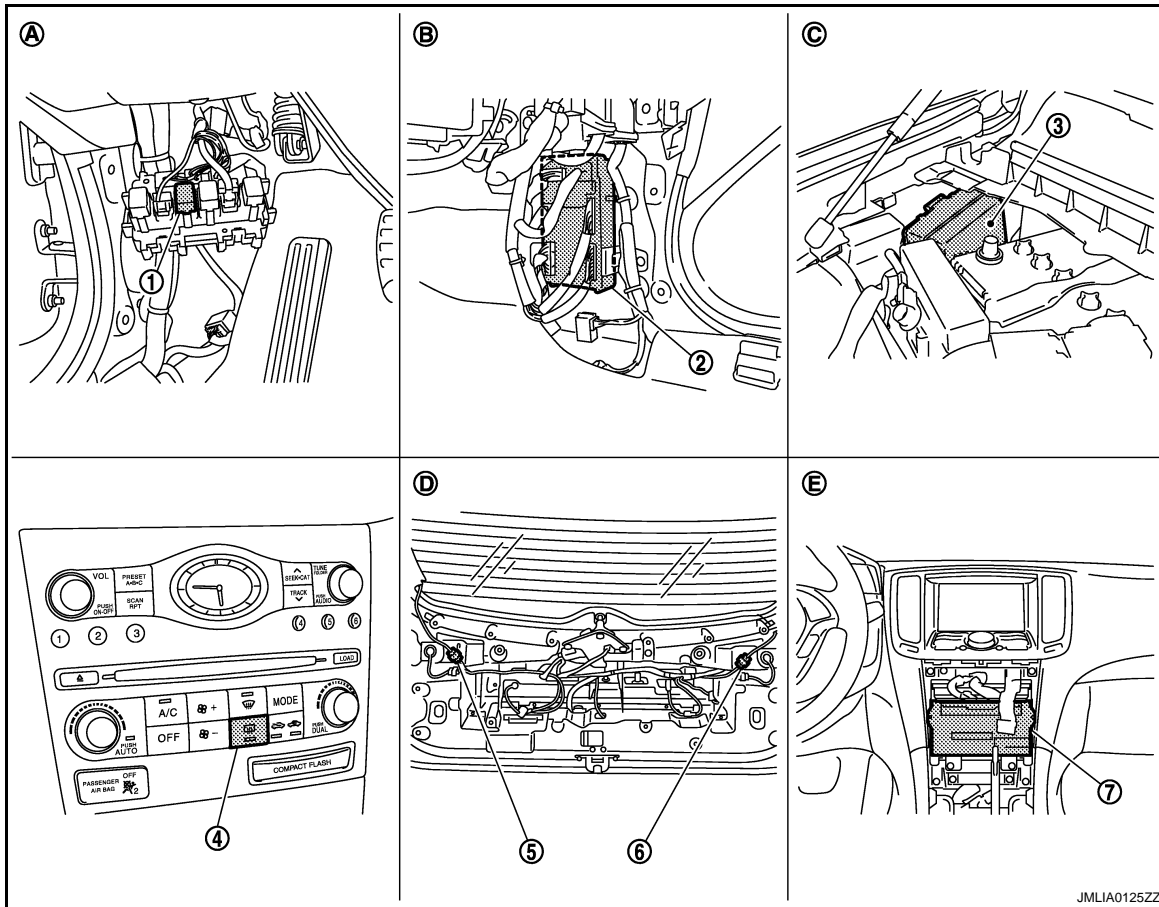

- | | | |
|--|--|--|
| 1. Rear window defogger relay (built-in relay box) | 2. BCM M118, M119, M122, M123 | 3. IPDM E/R E6 |
| 4. Rear window defogger switch (built-in multifunction switch M72) | 5. Rear window defogger connector D108 | 6. Rear window defogger connector D120 |
| 7. AV control unit <ul style="list-style-type: none"> • With NAVI M87, M88 • Without NAVI M83, M85 | | |
| A. Dash side lower (driver side) | B. Dash side lower (passenger side) | C. Engine room dash panel (RH) |
| D. Behind back door finisher | E. Behind cluster lid C | |

Component Description

INFOID:000000003136644

Item	Function
BCM	<ul style="list-style-type: none"> • Operates the rear window defogger with the operation of rear window defogger switch. • Performs the timer control of rear window defogger.
Rear window defogger relay	<ul style="list-style-type: none"> • Operates the rear window defogger and the door mirror defogger with the control signal from BCM.
IPDM E/R	<ul style="list-style-type: none"> • Transmit rear window defogger control signal to AV control unit via CAN communication.
Multifunction switch (Rear window defogger switch)	<ul style="list-style-type: none"> • The rear window defogger switch is installed. • Turns the indicator lamp ON when detecting the operation of rear window defogger.
AV control unit	<ul style="list-style-type: none"> • Displays the rear window defogger ON to the display when detecting the operation of rear window defogger.

REAR WINDOW DEFOGGER SYSTEM

< FUNCTION DIAGNOSIS >

Rear window defogger	<ul style="list-style-type: none">• Heats the heating wire with the power supply from the rear window defogger relay to prevent the rear window from fogging up.
Door mirror defogger*	<ul style="list-style-type: none">• Heats the heating wire with the power supply from the rear window defogger relay to prevent the door mirror from fogging up.

*: With mirror defogger

DIAGNOSIS SYSTEM (BCM)

< FUNCTION DIAGNOSIS >

DIAGNOSIS SYSTEM (BCM)

COMMON ITEM

COMMON ITEM : CONSULT-III Function (BCM - COMMON ITEM)

INFOID:000000003136645

APPLICATION ITEM

CONSULT-III performs the following functions via CAN communication with BCM.

Diagnosis mode	Function Description
Work Support	Changes the setting for each system function.
Self Diagnostic Result	Displays the diagnosis results judged by BCM.
CAN Diag Support Monitor	Monitors the reception status of CAN communication viewed from BCM. Refer to CONSULT-III operation manual.
Data Monitor	The BCM input/output signals are displayed.
Active Test	The signals used to activate each device are forcibly supplied from BCM.
Ecu Identification	The BCM part number is displayed.
Configuration	This function is not used even though it is displayed.

SYSTEM APPLICATION

BCM can perform the following functions for each system.

NOTE:

It can perform the diagnosis modes except the following for all sub system selection items.

×: Applicable item

System	Sub system selection item	Diagnosis mode		
		Work Support	Data Monitor	Active Test
Door lock	DOOR LOCK	×	×	×
Rear window defogger	REAR DEFOGGER		×	×
Warning chime	BUZZER		×	×
Interior room lamp timer	INT LAMP	×	×	×
Exterior lamp	HEAD LAMP	×	×	×
Wiper and washer	WIPER	×	×	×
Turn signal and hazard warning lamps	FLASHER	×	×	×
—	AIR CONDITIONER*		×	
Intelligent Key system	INTELLIGENT KEY	×	×	×
Combination switch	COMB SW		×	
Body control system	BCM	×		
IVIS - NATS	IMMU		×	×
Interior room lamp battery saver	BATTERY SAVER	×	×	×
Trunk open	TRUNK		×	
Vehicle security system	THEFT ALM	×	×	×
RAP system	RETAINED PWR		×	
Signal buffer system	SIGNAL BUFFER		×	×
TPMS	TPMS (AIR PRESSURE MONITOR)	×	×	×

*: This item is displayed, but is not used.

FREEZE FRAME DATA (FFD) AND IGN COUNTER

Freeze Frame Data

The BCM records the following condition at the moment a particular DTC is detected.

- Vehicle Speed
- Odo/Trip Meter

DIAGNOSIS SYSTEM (BCM)

< FUNCTION DIAGNOSIS >

- Vehicle Condition (BCM detected condition)

CONSULT screen terms	Description
SLEEP>LOCK	While turning BCM status from low power consumption mode to normal mode (Power supply position is "LOCK")
SLEEP>OFF	While turning BCM status from low power consumption mode to normal mode (Power supply position is "OFF".)
LOCK>ACC	While turning power supply position from "LOCK" to "ACC"
ACC>ON	While turning power supply position from "ACC" to "IGN"
RUN>ACC	While turning power supply position from "RUN" to "ACC" (Vehicle is stopping and selector lever is except P position.)
CRANK>RUN	While turning power supply position from "CRANKING" to "RUN" (From cranking up the engine to run it)
RUN>URGENT	While turning power supply position from "RUN" to "ACC" (Emergency stop operation)
ACC>OFF	While turning power supply position from "ACC" to "OFF"
OFF>LOCK	While turning power supply position from "OFF" to "LOCK"
OFF>ACC	While turning power supply position from "OFF" to "ACC"
ON>CRANK	While turning power supply position from "IGN" to "CRANKING"
OFF>SLEEP	While turning BCM status from normal mode (Power supply position is "OFF".) to low power consumption mode
LOCK>SLEEP	While turning BCM status from normal mode (Power supply position is "LOCK".) to low power consumption mode
LOCK	Power supply position is "LOCK" (Ignition switch OFF with steering is locked.)
OFF	Power supply position is "OFF" (Ignition switch OFF with steering is unlocked.)
ACC	Power supply position is "ACC" (Ignition switch ACC)
ON	Power supply position is "IGN" (Ignition switch ON with engine stopped)
ENGINE RUN	Power supply position is "RUN" (Ignition switch ON with engine running)
CRANKING	Power supply position is "CRANKING" (At engine cranking)

IGN Counter

IGN counter indicates the number of times that ignition switch is turned ON after DTC is detected.

- The number is 0 when a malfunction is detected now.
- The number increases like 1 → 2 → 3...38 → 39 after returning to the normal condition whenever ignition switch OFF → ON.
- The number is fixed to 39 until the self-diagnosis results are erased if it is over 39.

REAR WINDOW DEFOGGER

REAR WINDOW DEFOGGER : CONSULT-III Function (BCM - REAR DEFOGGER)

INFOID:000000003136646

Data monitor

Monitor Item	Description
REAR DEF SW	This is displayed even when it is not equipped.
PUSH SW	Indicates [ON/OFF] condition of push switch.

ACTIVE TEST

Test Item	Description
REAR DEFOGGER	This test is able to check rear window defogger operation. Rear window defogger operates when "ON" on CONSULT-III screen is touched.

POWER SUPPLY AND GROUND CIRCUIT

< COMPONENT DIAGNOSIS >

COMPONENT DIAGNOSIS

POWER SUPPLY AND GROUND CIRCUIT

Diagnosis Procedure

INFOID:000000003136647

1. CHECK FUSE AND FUSIBLE LINK

Check that the following fuse and fusible link are not blown.

Terminal No.	Signal name	Fuse and fusible link No.
1	Battery power supply	K
11		10

Is the fuse blown?

YES >> Replace the blown fuse or fusible link after repairing the affected circuit if a fuse or fusible link is blown.

NO >> GO TO 2.

2. CHECK POWER SUPPLY CIRCUIT

1. Turn ignition switch OFF.
2. Disconnect BCM connectors.
3. Check voltage between BCM harness connector and ground.

(+)		(-)	Voltage (V) (Approx.)
BCM			
Connector	Terminal	Ground	Battery voltage
M118	1		
M119	11		

Is the measurement value normal?

YES >> GO TO 3.

NO >> Repair harness or connector.

3. CHECK GROUND CIRCUIT

Check continuity between BCM harness connector and ground.

BCM		Ground	Continuity
Connector	Terminal		
M119	13		Existed

Does continuity exist?

YES >> INSPECTION END

NO >> Repair harness or connector.

A
B
C
D
E
F
G
H
I
J
K
DEF
M
N
O
P

REAR WINDOW DEFOGGER SWITCH

< COMPONENT DIAGNOSIS >

REAR WINDOW DEFOGGER SWITCH

Description

INFOID:000000003136648

- The rear window defogger is operated by turning the rear window defogger switch ON.
- The indicator lamp in the rear window defogger illuminates when the rear window defogger is operating.

Component Function Check

INFOID:000000003136649

1.CHECK REAR WINDOW DEFOGGER SWITCH FUNCTION

Check that the indicator lamp of rear window defogger illuminates when rear window defogger switch ON.

Is the inspection result normal?

- YES >> Rear window defogger switch function is OK.
NO >> Refer to [DEF-10, "Diagnosis Procedure"](#)

Diagnosis Procedure

INFOID:000000003136650

1.CHECK MULTIFUNCTION SWITCH (REAR WINDOW DEFOGGER SWITCH)

Does multifunction switch operate normally?

- Base audio without navigation system. Refer to [AV-28, "Diagnosis Description"](#)
- Bose audio without navigation system. Refer to [AV-192, "Diagnosis Description"](#)
- Bose audio with navigation system. Refer to [AV-482, "Diagnosis Description"](#)

Is the inspection result normal?

- YES >> INSPECTION END
NO >> Replace multifunction switch (rear window defogger switch). Refer to [AV-913, "Removal and Installation"](#)

REAR WINDOW DEFOGGER RELAY

< COMPONENT DIAGNOSIS >

REAR WINDOW DEFOGGER RELAY

Description

INFOID:000000003136651

Power is supplied to the rear window defogger with BCM control.

Component Function Check

INFOID:000000003136652

1.CHECK REAR WINDOW DEFOGGER RELAY POWER SUPPLY CIRCUIT

1. Perform Active Test ("REAR DEFOGGER") with CONSULT-III.
2. Touch "ON".
3. Check that the rear window heating wire is getting warmer.

Is the inspection result normal?

- YES >> Rear window defogger relay power supply circuit is OK.
 NO >> Refer to [DEF-11. "Diagnosis Procedure"](#)

Diagnosis Procedure

INFOID:000000003136653

1.CHECK FUSE

1. Turn ignition switch OFF.
2. Check 10A fuse [No.3, located in fuse block (J/B)].

Is the inspection result normal?

- YES >> GO TO 2.
 NO >> Replace the blown fuse after repairing the affected circuit if a fuse is blown.

2.CHECK REAR WINDOW DEFOGGER CIRCUIT 1

1. Turn ignition switch ON.
2. Check voltage between BCM harness connector and ground.

(+)		(-)	Condition	Voltage (V) (Approx.)
BCM				
Connector	Terminal			
M123	151	Ground	Rear window defogger switch: ON	0
			Rear window defogger switch: OFF	Battery voltage

Is the inspection result normal?

- YES >> Rear window defogger power supply circuit is OK.
 NO >> GO TO 3.

3.CHECK REAR WINDOW DEFOGGER CIRCUIT 2

1. Turn ignition switch OFF.
2. Disconnect BCM connector and fuse block (J/B).
3. Check continuity between BCM harness connector and fuse block (J/B) harness connector.

BCM		Fuse block (J/B)		Continuity
Connector	Terminal	Connector	Terminal	
M123	151	M2	4B	Existed

Is the inspection result normal?

- YES >> GO TO 4.
 NO >> Repair or replace harness.

4.CHECK REAR WINDOW DEFOGGER RELAY

1. Disconnect rear window defogger relay,
2. Check rear window defogger relay.
 Refer to [DEF-12. "Component Inspection"](#)

Is the inspection result normal?

A
B
C
D
E
F
G
H
I
J
K
M
N
O
P

DEF

REAR WINDOW DEFOGGER RELAY

< COMPONENT DIAGNOSIS >

- YES >> GO TO 5.
 NO >> Replace rear window defogger relay.

5.CHECK FUSE BLOCK (J/B)

1. Install the rear window defogger relay.
2. Turn ignition switch ON.
3. Check voltage between fuse block (J/B) connector (fuse block side) and ground.

(+)		(-)	Voltage (V) (Approx.)
Fuse block (J/B)			
Connector	Terminal		
M2	4B	Ground	Battery voltage

Is the inspection result normal?

- YES >> GO TO 6.
 NO >> Replace fuse block (J/B).

6.CHECK INTERMITTENT INCIDENT

Check intermittent incident.
 Refer to [GI-38, "Intermittent Incident"](#)

>> INSPECTION END.

Component Inspection

INFOID:000000003136654

1.CHECK REAR WINDOW DEFOGGER RELAY

1. Turn ignition switch OFF.
2. Disconnect rear window defogger relay.
3. Check rear window defogger relay.

Rear window defogger relay		Condition	Continuity
Terminal			
3	5	12 V direct current supply between terminals 1 and 2.	Existed
		No current supply	Not existed

Is the inspection result normal?

- YES >> INSPECTION END.
 NO >> Replace rear window defogger relay.

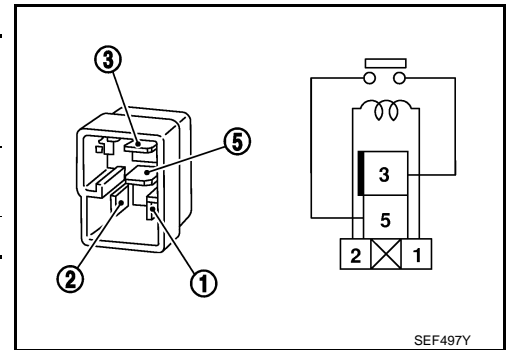

REAR WINDOW DEFOGGER

< COMPONENT DIAGNOSIS >

REAR WINDOW DEFOGGER

Description

INFOID:000000003136655

Heats the heating wire with the power supply from the rear window defogger relay to prevent the rear window from fogging up.

Component Function Check

INFOID:000000003136656

1.CHECK REAR WINDOW DEFOGGER

1. Perform Active Test ("REAR DEFOGGER") with CONSULT-III.
2. Touch "ON".
3. Check that the rear window heating wire is getting warmer.

Is the inspection result normal?

- YES >> Rear window defogger is OK.
NO >> Refer to [DEF-13. "Diagnosis Procedure"](#)

Diagnosis Procedure

INFOID:000000003136657

1.CHECK FUSE

1. Turn ignition switch OFF.
2. Check the following.
 - 20A fuse [No.14, located in fuse block (J/B)]
 - 20A fuse [No.15, located in fuse block (J/B)]

Is the inspection result normal?

- YES >> GO TO 2.
NO >> Replace the blown fuse after repairing the affected circuit if a fuse is blown.

2.CHECK POWER SUPPLY CIRCUIT

1. Turn ignition switch ON.
2. Check voltage between rear window defogger harness connector and ground.

(+)		(-)	Condition	Voltage (V) (Approx.)
Connector	Terminal			
D108	1	Ground	Rear window defogger switch: ON	Battery voltage
			Rear window defogger switch: OFF	0

Is the inspection result normal?

- YES >> GO TO 3.
NO >> GO TO 4.

3.CHECK GROUND CIRCUIT

1. Turn ignition switch OFF.
2. Disconnect rear window defogger connector.
3. Check continuity between rear window defogger harness connector and ground.

Rear window defogger		Ground	Continuity
Connector	Terminal		
D120	2		Existed

Is the inspection result normal?

- YES >> GO TO 9.
NO >> Repair or replace harness between rear window defogger and ground.

4.CHECK REAR WINDOW DEFOGGER CIRCUIT 1

REAR WINDOW DEFOGGER

< COMPONENT DIAGNOSIS >

1. Turn ignition switch OFF.
2. Disconnect condenser connector.
3. Check continuity between condenser harness connector and rear window defogger harness connector.

Condenser		Rear window defogger		Continuity
Connector	Terminal	Connector	Terminal	
D104	2	D108	1	Existed

Is the inspection result normal?

YES >> GO TO 5.

NO >> Repair or replace harness between condenser and rear window defogger.

5.CHECK REAR WINDOW DEFOGGER CIRCUIT 2

1. Disconnect fuse block (J/B) connector.
2. Check continuity between fuse block (J/B) harness connector and condenser harness connector.

Fuse block (J/B)		Condenser		Continuity
Connector	Terminal	Connector	Terminal	
B6	10G	D105	1	Existed
	11G			

Is the inspection result normal?

YES >> GO TO 6.

NO >> Repair or replace harness between fuse block (J/B) and condenser.

6.CHECK FUSE BLOCK (J/B)

1. Turn ignition switch ON.
2. Check voltage between fuse block (J/B) (fuse block side) and ground.

(+)		(-)	Condition	Voltage (V) (Approx.)
Fuse block (J/B)				
Connector	Terminal			
B6	10G	Ground	Rear window defogger switch: ON	Battery voltage
			Rear window defogger switch: OFF	0
	11G		Rear window defogger switch: ON	Battery voltage
			Rear window defogger switch: OFF	0

Is the inspection result normal?

YES >> GO TO 7.

NO >> GO TO 8.

7.CHECK CONDENSER

Check condenser. Refer to [DEF-15, "Component Inspection"](#)

Is the inspection result normal?

YES >> GO TO 10.

NO >> Replace condenser.

8.CHECK REAR WINDOW DEFOGGER RELAY

Check rear window defogger relay. Refer to [DEF-12, "Component Inspection"](#)

Is the inspection result normal?

YES >> Replace fuse block (J/B)

NO >> Replace rear window defogger relay.

9.CHECK FILAMENT

Check the filament for damage or blown.

Refer to [DEF-69, "Inspection and Repair"](#)

Is the inspection result normal?

REAR WINDOW DEFOGGER

< COMPONENT DIAGNOSIS >

YES >> GO TO 10.
NO >> Repair filament.

10.CHECK INTERMITTENT INCIDENT

Check intermittent incident.
Refer to [GI-38. "Intermittent Incident"](#)

>> INSPECTION END

Component Inspection

INFOID:000000003736286

1.CHECK CONDENSER

1. Check continuity between condenser connector and ground part of condenser.

Condenser		Ground part of condenser	Continuity
Connector	Terminal		
D105	1		Not existed
D104	2		

2. Check condenser terminals.

Condenser				Continuity
Connector	Terminal	Connector	Terminal	
D105	1	D104	2	Existed

Is the inspection result normal?

YES >> INSPECTION END
NO >> Repair condenser.

A
B
C
D
E
F
G
H
I
J
K
M
N
O
P

DEF

DOOR MIRROR DEFOGGER

< COMPONENT DIAGNOSIS >

DOOR MIRROR DEFOGGER

Description

INFOID:000000003136659

Power is supplied to the door mirror defogger with BCM control.

Component Function Check

INFOID:000000003136660

1.CHECK DOOR MIRROR DEFOGGER

1. Perform Active Test ("REAR DEFOGGER") with CONSULT-III.
2. Touch "ON".
3. Check that both side door mirror glass is getting warmer.

Is the inspection result normal?

- YES >> Door mirror defogger is OK.
NO >> Refer to [DEF-16. "Diagnosis Procedure"](#)

Diagnosis Procedure

INFOID:000000003136661

1.CHECK FUSE

1. Turn ignition switch OFF.
2. Check 10A fuse [No.13, located in fuse block (J/B)].

Is the inspection result normal?

- YES >> GO TO 2.
NO >> Replace the blown fuse after repairing the affected circuit if a fuse is blown.

2.CHECK FUSE BLOCK (J/B)

1. Disconnect fuse block (J/B) connector.
2. Turn ignition switch ON.
3. Check voltage between fuse block (J/B) connector (fuse block side) and ground.

(+)		(-)	Condition	Voltage (V) (Approx.)
Fuse block (J/B)				
Connector	Terminal			
M3	9C	Ground	Rear window defogger switch: ON	Battery voltage
			Rear window defogger switch: OFF	0
	10C		Rear window defogger switch: ON	Battery voltage
			Rear window defogger switch: OFF	0

Is the inspection result normal?

- YES >> GO TO 3.
NO >> Replace fuse block (J/B).

3.CHECK INTERMITTENT INCIDENT

Check intermittent incident.

Refer to [GI-38. "Intermittent Incident"](#).

>> INSPECTION END

DRIVER SIDE DOOR MIRROR DEFOGGER

< COMPONENT DIAGNOSIS >

DRIVER SIDE DOOR MIRROR DEFOGGER

Description

INFOID:000000003136662

Heats the heating wire with the power supply from the rear window defogger relay to prevent the door mirror from fogging up.

Component Function Check

INFOID:000000003136663

1.CHECK DRIVER SIDE DOOR MIRROR DEFOGGER

1. Perform Active Test ("REAR DEFOGGER") with CONSULT-III.
2. Touch "ON".
3. Check that the driver side door mirror glass is getting warmer.

Is the inspection result normal?

- YES >> Driver side door mirror defogger is OK.
NO >> Refer to [DEF-17, "Diagnosis Procedure"](#)

Diagnosis Procedure

INFOID:000000003136664

1.CHECK POWER SUPPLY CIRCUIT

1. Turn ignition switch OFF.
2. Disconnect door mirror (driver side) connector.
3. Turn ignition switch ON.
4. Check voltage between door mirror (driver side) harness connector and ground.

(+)		(-)	Condition	Voltage (V) (Approx.)
Connector	Terminal			
D3	7	Ground	Rear window defogger switch: ON	Battery voltage
			Rear window defogger switch: OFF	0

Is the inspection result normal?

- YES >> GO TO 4.
NO >> GO TO 2.

2.CHECK DRIVER SIDE DOOR MIRROR DEFOGGER CIRCUIT

1. Turn ignition switch OFF.
2. Disconnect fuse block (J/B) connector.
3. Check continuity between fuse block (J/B) harness connector and door mirror (driver side) harness connector.

Fuse block (J/B)		Door mirror (driver side)		Continuity
Connector	Terminal	Connector	Terminal	
M3	10C	D3	7	Existed

Is the inspection result normal?

- YES >> GO TO 3.
NO >> Repair or replace harness between fuse block (J/B) and door mirror (driver side).

3.CHECK FUSE BLOCK (J/B) OUTPUT SIGNAL

1. Turn ignition switch ON.
2. Check voltage between fuse block (J/B) harness connector and ground.

DRIVER SIDE DOOR MIRROR DEFOGGER

< COMPONENT DIAGNOSIS >

(+)		(-)	Condition	Voltage (V) (Approx.)
Fuse block (J/B)				
Connector	Terminal			
M3	10C	Ground	Rear window defogger switch: ON	Battery voltage
			Rear window defogger switch: OFF	0

Is the inspection result normal?

YES >> GO TO 5.

NO >> Replace fuse block (J/B).

4. CHECK GROUND CIRCUIT

1. Turn ignition switch OFF.
2. Check continuity between door mirror (driver side) harness connector and ground.

Door mirror (driver side)		Ground	Continuity
Connector	Terminal		
D3	19		Existed

Is the inspection result normal?

YES >> Replace door mirror glass (driver side). Refer to [MIR-53. "GLASS MIRROR : Disassembly and Assembly"](#).

NO >> Repair or replace harness between door mirror (driver side) and ground.

5. CHECK INTERMITTENT INCIDENT

Check intermittent incident.

Refer to [GI-38. "Intermittent Incident"](#)

>> INSPECTION END

PASSENGER SIDE DOOR MIRROR DEFOGGER

< COMPONENT DIAGNOSIS >

PASSENGER SIDE DOOR MIRROR DEFOGGER

Description

INFOID:000000003136665

Heats the heating wire with the power supply from the rear window defogger relay to prevent the door mirror from fogging up.

Component Function Check

INFOID:000000003136666

1.CHECK PASSENGER SIDE DOOR MIRROR DEFOGGER

1. Perform Active Test ("REAR DEFOGGER") with CONSULT-III.
2. Touch "ON".
3. Check that the passenger side door mirror glass is getting warmer.

Is the inspection result normal?

- YES >> Passenger side door mirror defogger is OK.
NO >> Refer to [DEF-19, "Diagnosis Procedure"](#)

Diagnosis Procedure

INFOID:000000003136667

1.CHECK POWER SUPPLY CIRCUIT

1. Turn ignition switch OFF.
2. Disconnect door mirror (passenger side) connector.
3. Turn ignition switch ON.
4. Check voltage between door mirror (passenger side) harness connector and ground.

(+)		(-)	Condition	Voltage (V) (Approx.)
Connector	Terminal			
D33	7	Ground	Rear window defogger switch: ON	Battery voltage
			Rear window defogger switch: OFF	0

Is the inspection result normal?

- YES >> GO TO 4.
NO >> GO TO 2.

2.CHECK PASSENGER SIDE DOOR MIRROR DEFOGGER CIRCUIT

1. Turn ignition switch OFF.
2. Disconnect fuse block (J/B) connector.
3. Check continuity between fuse block (J/B) harness connector and door mirror (passenger side) harness connector.

Fuse block (J/B)		Door mirror (passenger side)		Continuity
Connector	Terminal	Connector	Terminal	
M3	9C	D33	7	Existed

Is the inspection result normal?

- YES >> GO TO 3.
NO >> Repair or replace harness between fuse block (J/B) and door mirror (passenger side).

3.CHECK FUSE BLOCK (J/B) OUTPUT SIGNAL

1. Turn ignition switch ON.
2. Check voltage between fuse block (J/B) harness connector and ground.

PASSENGER SIDE DOOR MIRROR DEFOGGER

< COMPONENT DIAGNOSIS >

(+)		(-)	Condition	Voltage (V) (Approx.)
Fuse block (J/B)				
Connector	Terminal			
M3	9C	Ground	Rear window defogger switch: ON	Battery voltage
			Rear window defogger switch: OFF	0

Is the inspection result normal?

YES >> GO TO 5.

NO >> Replace fuse block (J/B).

4. CHECK GROUND CIRCUIT

1. Turn ignition switch OFF.
2. Check continuity between door mirror (passenger side) harness connector and ground.

Door mirror (passenger side)		Ground	Continuity
Connector	Terminal		
D33	19		Existed

Is the inspection result normal?

YES >> Replace door mirror glass (passenger side). Refer to [MIR-53, "GLASS MIRROR : Disassembly and Assembly"](#).

NO >> Repair or replace harness between door mirror (passenger side) and ground.

5. CHECK INTERMITTENT INCIDENT

Check intermittent incident.

Refer to [GI-38, "Intermittent Incident"](#)

>> INSPECTION END

REAR WINDOW DEFOGGER SYSTEM

< COMPONENT DIAGNOSIS >

REAR WINDOW DEFOGGER SYSTEM

Wiring Diagram - DEFOGGER SYSTEM -

INFOID:000000003784716

- ★1: 52: <NV> 86: <ON> 87: <ON> 71: <NV> 44: <ON>
- ★2: 53: <NV> 87: <ON> 71: <NV> 44: <ON>
- ★3: 71: <NV> 50: <NV> 88: <ON>
- ★4: 70: <NV> 56: <ON> 51: <NV> 89: <ON> 50: <NV> 88: <ON>
- ★5: 51: <NV> 89: <ON> 50: <NV> 88: <ON>
- ★6: 50: <NV> 88: <ON>

- <MD>: With mirror defogger
- <NV>: With NAVI
- <ON>: Without NAVI
- <PM>: With automatic drive positioner
- <OP>: Without automatic drive positioner

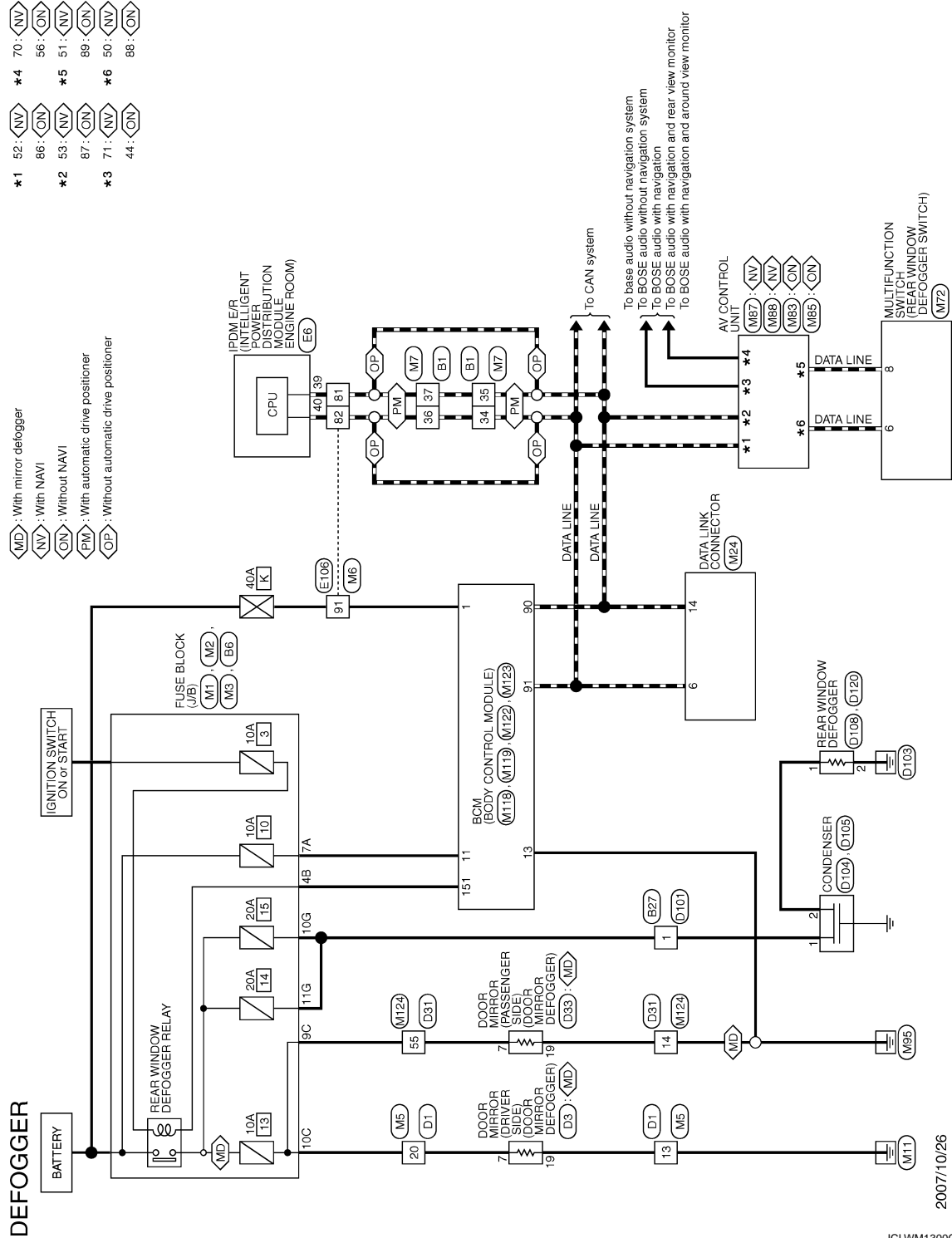

2007/10/26

JCLWM1300GE

A
B
C
D
E
F
G
H
I
J
K
L
M
N
O
P

DEF

REAR WINDOW DEFOGGER SYSTEM

< COMPONENT DIAGNOSIS >

DEFOGGER

Connector No.	D1
Connector Name	WIRE TO WIRE
Connector Type	TH40FW-CS15

Terminal No.	Color of Wire	Signal Name [Specification]
13	B	
20	W	

Connector No.	B27
Connector Name	WIRE TO WIRE
Connector Type	M06MW-LC

Terminal No.	Color of Wire	Signal Name [Specification]
1	W	

Connector No.	B6
Connector Name	FUSE BLOCK (J/B)
Connector Type	NS17FER-CS

Terminal No.	Color of Wire	Signal Name [Specification]
10G	W	
11G	W	

Connector No.	B1
Connector Name	WIRE TO WIRE
Connector Type	TH80FW-CS16-TM4

Terminal No.	Color of Wire	Signal Name [Specification]
34	L	
35	P	
36	L	
37	P	

Connector No.	D101
Connector Name	WIRE TO WIRE
Connector Type	M06FW-LC

Terminal No.	Color of Wire	Signal Name [Specification]
1	R	

Connector No.	D33
Connector Name	DOOR MIRROR (PASSENGER SIDE)
Connector Type	TH24MW-NH

Terminal No.	Color of Wire	Signal Name [Specification]
7	L	
19	B	

Connector No.	D31
Connector Name	WIRE TO WIRE
Connector Type	TH40FW-CS15

Terminal No.	Color of Wire	Signal Name [Specification]
14	B	
55	L	

Connector No.	D3
Connector Name	DOOR MIRROR (DRIVER SIDE)
Connector Type	TH24MW-NH

















Terminal No.	Color of Wire	Signal Name [Specification]
7	W	
19	B	

JCLWM1301GE

REAR WINDOW DEFOGGER SYSTEM

< COMPONENT DIAGNOSIS >

DEFOGGER

Connector No. D104	Connector Name CONDENSER	Connector Type PD1FB-A	 	Terminal No. 2	Color of Wire Y	Signal Name [Specification]
Connector No. D105	Connector Name CONDENSER	Connector Type PD1FB-A	 	Terminal No. 1	Color of Wire R	Signal Name [Specification]
Connector No. D108	Connector Name REAR WINDOW DEFOGGER	Connector Type M02MB-P-LC	 	Terminal No. 1	Color of Wire Y	Signal Name [Specification]
Connector No. D120	Connector Name REAR WINDOW DEFOGGER	Connector Type M02MB-P-LC	 	Terminal No. 2	Color of Wire B	Signal Name [Specification]
Connector No. EB	Connector Name IPDM E/R (INTELLIGENT POWER DISTRIBUTION MODULE ENGINE ROOM)	Connector Type TH08FW-NH	 	Terminal No. 38	Color of Wire P	Signal Name [Specification]
Connector No. E106	Connector Name WIRE TO WIRE	Connector Type TH80FW-CS16-TM4	 	Terminal No. 81	Color of Wire P	Signal Name [Specification]
Connector No. M1	Connector Name FUSE BLOCK (J/B)	Connector Type NS08FW-M2	 	Terminal No. 7A	Color of Wire R	Signal Name [Specification]
Connector No. M2	Connector Name FUSE BLOCK (J/B)	Connector Type NS10FW-CS	 	Terminal No. 4B	Color of Wire G	Signal Name [Specification]

JCLWM1302GE

A
B
C
D
E
F
G
H
I
J
K
DEF
M
N
O
P

REAR WINDOW DEFOGGER SYSTEM

< COMPONENT DIAGNOSIS >

DEFOGGER

Connector No.	M3
Connector Name	FUSE BLOCK (J/B)
Connector Type	HS12FW-CS

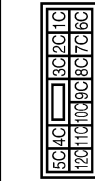

Terminal No.	Color of Wire	Signal Name [Specification]
9C	O	-
10C	L	-

Connector No.	M5
Connector Name	WIRE TO WIRE
Connector Type	TH4GMW-CS15

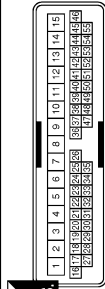

Terminal No.	Color of Wire	Signal Name [Specification]
13	B	-
20	L	-

Connector No.	M6
Connector Name	WIRE TO WIRE
Connector Type	TH2DMW-CS18-TM4

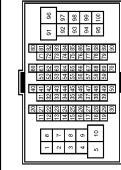

Terminal No.	Color of Wire	Signal Name [Specification]
81	P	-
82	L	-
91	W	-

Connector No.	M7
Connector Name	WIRE TO WIRE
Connector Type	TH8DMW-CS16-TM4

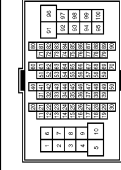

Terminal No.	Color of Wire	Signal Name [Specification]
34	L	-
35	P	-
36	L	-
37	P	-

Connector No.	M24
Connector Name	DATA LINK CONNECTOR
Connector Type	BD16FW

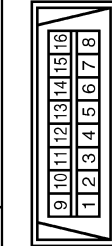

Terminal No.	Color of Wire	Signal Name [Specification]
6	L	-
14	P	-

Connector No.	M72
Connector Name	MULTIFUNCTION SWITCH
Connector Type	TH16FW-NH

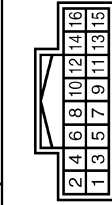

Terminal No.	Color of Wire	Signal Name [Specification]
6	LG	AV COMM (H)
8	V	AV COMM (L)

Connector No.	M83
Connector Name	AV CONTROL UNIT (WITHOUT NAVI)
Connector Type	TH24FW-NH

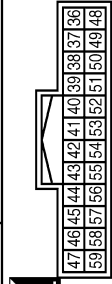

Terminal No.	Color of Wire	Signal Name [Specification]
44	BR	COMM (DISP->CONT)
56	Y	COMM (CONT->DISP)

Connector No.	M85
Connector Name	AV CONTROL UNIT (WITHOUT NAVI)
Connector Type	TH32FW-NH

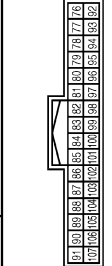

Terminal No.	Color of Wire	Signal Name [Specification]
86	L	CAN-H
87	P	CAN-L
88	LG	AV COMM (H)
89	V	AV COMM (L)

BCM (BODY CONTROL MODULE)

< ECU DIAGNOSIS >

ECU DIAGNOSIS

BCM (BODY CONTROL MODULE)

Reference Value

INFOID:000000003784736

VALUES ON THE DIAGNOSIS TOOL

CONSULT-III MONITOR ITEM

Monitor Item	Condition	Value/Status
FR WIPER HI	Other than front wiper switch HI	Off
	Front wiper switch HI	On
FR WIPER LOW	Other than front wiper switch LO	Off
	Front wiper switch LO	On
FR WASHER SW	Front washer switch OFF	Off
	Front washer switch ON	On
FR WIPER INT	Other than front wiper switch INT	Off
	Front wiper switch INT	On
FR WIPER STOP	Front wiper is not in STOP position	Off
	Front wiper is in STOP position	On
INT VOLUME	Wiper intermittent dial is in a dial position 1 - 7	Wiper intermittent dial position
RR WIPER ON	Other than rear wiper switch ON	Off
	Rear wiper switch ON	On
RR WIPER INT	Other than rear wiper switch INT	Off
	Rear wiper switch INT	On
RR WASHER SW	Rear washer switch OFF	Off
	Rear washer switch ON	On
RR WIPER STOP	Rear wiper is in STOP position	Off
	Rear wiper is not in STOP position	On
TURN SIGNAL R	Other than turn signal switch RH	Off
	Turn signal switch RH	On
TURN SIGNAL L	Other than turn signal switch LH	Off
	Turn signal switch LH	On
TAIL LAMP SW	Other than lighting switch 1ST and 2ND	Off
	Lighting switch 1ST or 2ND	On
HI BEAM SW	Other than lighting switch HI	Off
	Lighting switch HI	On
HEAD LAMP SW 1	Other than lighting switch 2ND	Off
	Lighting switch 2ND	On
HEAD LAMP SW 2	Other than lighting switch 2ND	Off
	Lighting switch 2ND	On
PASSING SW	Other than lighting switch PASS	Off
	Lighting switch PASS	On
AUTO LIGHT SW	Other than lighting switch AUTO	Off
	Lighting switch AUTO	On
FR FOG SW	Front fog lamp switch OFF	Off
	Front fog lamp switch ON	On

BCM (BODY CONTROL MODULE)

< ECU DIAGNOSIS >

Monitor Item	Condition	Value/Status	
RR FOG SW	NOTE: The item is indicated, but not monitored.	Off	A
DOOR SW-DR	Driver door closed	Off	B
	Driver door opened	On	
DOOR SW-AS	Passenger door closed	Off	C
	Passenger door opened	On	
DOOR SW-RR	Rear RH door closed	Off	D
	Rear RH door opened	On	
DOOR SW-RL	Rear LH door closed	Off	D
	Rear LH door opened	On	
DOOR SW-BK	Back door closed	Off	E
	Back door opened	On	
CDL LOCK SW	Other than power door lock switch LOCK	Off	F
	Power door lock switch LOCK	On	
CDL UNLOCK SW	Other than power door lock switch UNLOCK	Off	G
	Power door lock switch UNLOCK	On	
KEY CYL LK-SW	Other than driver door key cylinder LOCK position	Off	H
	Driver door key cylinder LOCK position	On	
KEY CYL UN-SW	Other than driver door key cylinder UNLOCK position	Off	H
	Driver door key cylinder UNLOCK position	On	
KEY CYL SW-TR	NOTE: The item is indicated, but not monitored.	Off	I
HAZARD SW	Hazard switch is OFF	Off	J
	Hazard switch is ON	On	
REAR DEF SW	NOTE: The item is indicated, but not monitored.	Off	K
TR CANCEL SW	NOTE: The item is indicated, but not monitored.	Off	K
TR/BD OPEN SW	Back door opener switch OFF	Off	DEF
	While the back door opener switch is turned ON	On	
TRNK/HAT MNTR	NOTE: The item is indicated, but not monitored.	Off	
RKE-LOCK	LOCK button of the key is not pressed	Off	M
	LOCK button of the key is pressed	On	
RKE-UNLOCK	UNLOCK button of the key is not pressed	Off	N
	UNLOCK button of the key is pressed	On	
RKE-TR/BD	NOTE: The item is indicated, but not monitored.	Off	O
RKE-PANIC	PANIC button of the key is not pressed	Off	O
	PANIC button of the key is pressed	On	
RKE-P/W OPEN	UNLOCK button of the key is not pressed	Off	P
	UNLOCK button of the key is pressed and held	On	
RKE-MODE CHG	LOCK/UNLOCK button of the key is not pressed and held simultaneously	Off	
	LOCK/UNLOCK button of the key is pressed and held simultaneously	On	

BCM (BODY CONTROL MODULE)

< ECU DIAGNOSIS >

Monitor Item	Condition	Value/Status
OPTICAL SENSOR	Bright outside of the vehicle	Close to 5 V
	Dark outside of the vehicle	Close to 0 V
REQ SW -DR	Driver door request switch is not pressed	Off
	Driver door request switch is pressed	On
REQ SW -AS	Passenger door request switch is not pressed	Off
	Passenger door request switch is pressed	On
REQ SW -RR	NOTE: The item is indicated, but not monitored.	Off
REQ SW -RL	NOTE: The item is indicated, but not monitored.	Off
REQ SW -BD/TR	Back door request switch is not pressed	Off
	Back door request switch is pressed	On
PUSH SW	Push-button ignition switch (push switch) is not pressed	Off
	Push-button ignition switch (push switch) is pressed	On
IGN RLY2 -F/B	Ignition switch in OFF or ACC position	Off
	Ignition switch in ON position	On
CLUCH SW	NOTE: The item is indicated, but not monitored.	Off
BRAKE SW 1	The brake pedal is not depressed	On
	The brake pedal is depressed	Off
DETE/CANCL SW	Selector lever in P position	Off
	Selector lever in any position other than P	On
SFT PN/N SW	Selector lever in any position other than P and N	Off
	Selector lever in P or N position	On
S/L -LOCK	Steering is locked	Off
	Steering is unlocked	On
S/L -UNLOCK	Steering is unlocked	Off
	Steering is locked	On
S/L RELAY-F/B	Ignition switch in OFF or ACC position	Off
	Ignition switch in ON position	On
UNLK SEN -DR	Driver door is unlocked	Off
	Driver door is locked	On
PUSH SW -IPDM	Push-button ignition switch (push-switch) is not pressed	Off
	Push-button ignition switch (push-switch) is pressed	On
IGN RLY1 -F/B	Ignition switch in OFF or ACC position	Off
	Ignition switch in ON position	On
DETE SW -IPDM	Selector lever in P position	Off
	Selector lever in any position other than P	On
SFT PN -IPDM	Selector lever in any position other than P and N	Off
	Selector lever in P or N position	On
SFT P -MET	Selector lever in any position other than P	Off
	Selector lever in P position	On
SFT N -MET	Selector lever in any position other than N	Off
	Selector lever in N position	On

BCM (BODY CONTROL MODULE)

< ECU DIAGNOSIS >

Monitor Item	Condition	Value/Status	
ENGINE STATE	Engine stopped	Stop	A
	While the engine stalls	Stall	
	At engine cranking	Crank	B
	Engine running	Run	
S/L LOCK-IPDM	Steering is locked	Off	
	Steering is unlocked	On	C
S/L UNLK-IPDM	Steering is unlocked	Off	
	Steering is locked	On	D
S/L RELAY-REQ	Ignition switch in OFF or ACC position	Off	
	Ignition switch in ON position	On	E
VEH SPEED 1	While driving	Equivalent to speedometer reading	
VEH SPEED 2	While driving	Equivalent to speedometer reading	
DOOR STAT-DR	Driver door is locked	LOCK	F
	Wait with selective UNLOCK operation (5 seconds)	READY	
	Driver door is unlocked	UNLOCK	G
DOOR STAT-AS	Passenger door is locked	LOCK	
	Wait with selective UNLOCK operation (5 seconds)	READY	H
	Passenger door is unlocked	UNLOCK	
ID OK FLAG	Ignition switch in ACC or ON position	Reset	I
	Ignition switch in OFF position	Set	
PRMT ENG STRT	The engine start is prohibited	Reset	J
	The engine start is permitted	Set	
PRMT RKE STRT	NOTE: The item is indicated, but not monitored.	Reset	K
KEY SW -SLOT	The key is not inserted into key slot	Off	
	The key is inserted into key slot	On	
RKE OPE COUN1	During the operation of the key	Operation frequency of the key	
RKE OPE COUN2	NOTE: The item is indicated, but not monitored.	—	DEF
CONFIRM ID ALL	The key ID that the key slot receives does not accord with any key ID registered to BCM.	Yet	
	The key ID that the key slot receives accords with any key ID registered to BCM.	DONE	M
CONFIRM ID4	The key ID that the key slot receives does not accord with the fourth key ID registered to BCM.	Yet	
	The key ID that the key slot receives accords with the fourth key ID registered to BCM.	DONE	N
CONFIRM ID3	The key ID that the key slot receives does not accord with the third key ID registered to BCM.	Yet	O
	The key ID that the key slot receives accords with the third key ID registered to BCM.	DONE	
CONFIRM ID2	The key ID that the key slot receives does not accord with the second key ID registered to BCM.	Yet	P
	The key ID that the key slot receives accords with the second key ID registered to BCM.	DONE	

BCM (BODY CONTROL MODULE)

< ECU DIAGNOSIS >

Monitor Item	Condition	Value/Status
CONFIRM ID1	The key ID that the key slot receives does not accord with the first key ID registered to BCM.	Yet
	The key ID that the key slot receives accords with the first key ID registered to BCM.	DONE
TP 4	The ID of fourth key is not registered to BCM	Yet
	The ID of fourth key is registered to BCM	DONE
TP 3	The ID of third key is not registered to BCM	Yet
	The ID of third key is registered to BCM	DONE
TP 2	The ID of second key is not registered to BCM	Yet
	The ID of second key is registered to BCM	DONE
TP 1	The ID of first key is not registered to BCM	Yet
	The ID of first key is registered to BCM	DONE
AIR PRESS FL	Ignition switch ON (Only when the signal from the transmitter is received)	Air pressure of front LH tire
AIR PRESS FR	Ignition switch ON (Only when the signal from the transmitter is received)	Air pressure of front RH tire
AIR PRESS RR	Ignition switch ON (Only when the signal from the transmitter is received)	Air pressure of rear RH tire
AIR PRESS RL	Ignition switch ON (Only when the signal from the transmitter is received)	Air pressure of rear LH tire
ID REGST FL1	ID of front LH tire transmitter is registered	DONE
	ID of front LH tire transmitter is not registered	Yet
ID REGST FR1	ID of front RH tire transmitter is registered	DONE
	ID of front RH tire transmitter is not registered	Yet
ID REGST RR1	ID of rear RH tire transmitter is registered	DONE
	ID of rear RH tire transmitter is not registered	Yet
ID REGST RL1	ID of rear LH tire transmitter is registered	DONE
	ID of rear LH tire transmitter is not registered	Yet
WARNING LAMP	Tire pressure indicator OFF	Off
	Tire pressure indicator ON	On
BUZZER	Tire pressure warning alarm is not sounding	Off
	Tire pressure warning alarm is sounding	On

BCM (BODY CONTROL MODULE)

< ECU DIAGNOSIS >
 TERMINAL LAYOUT

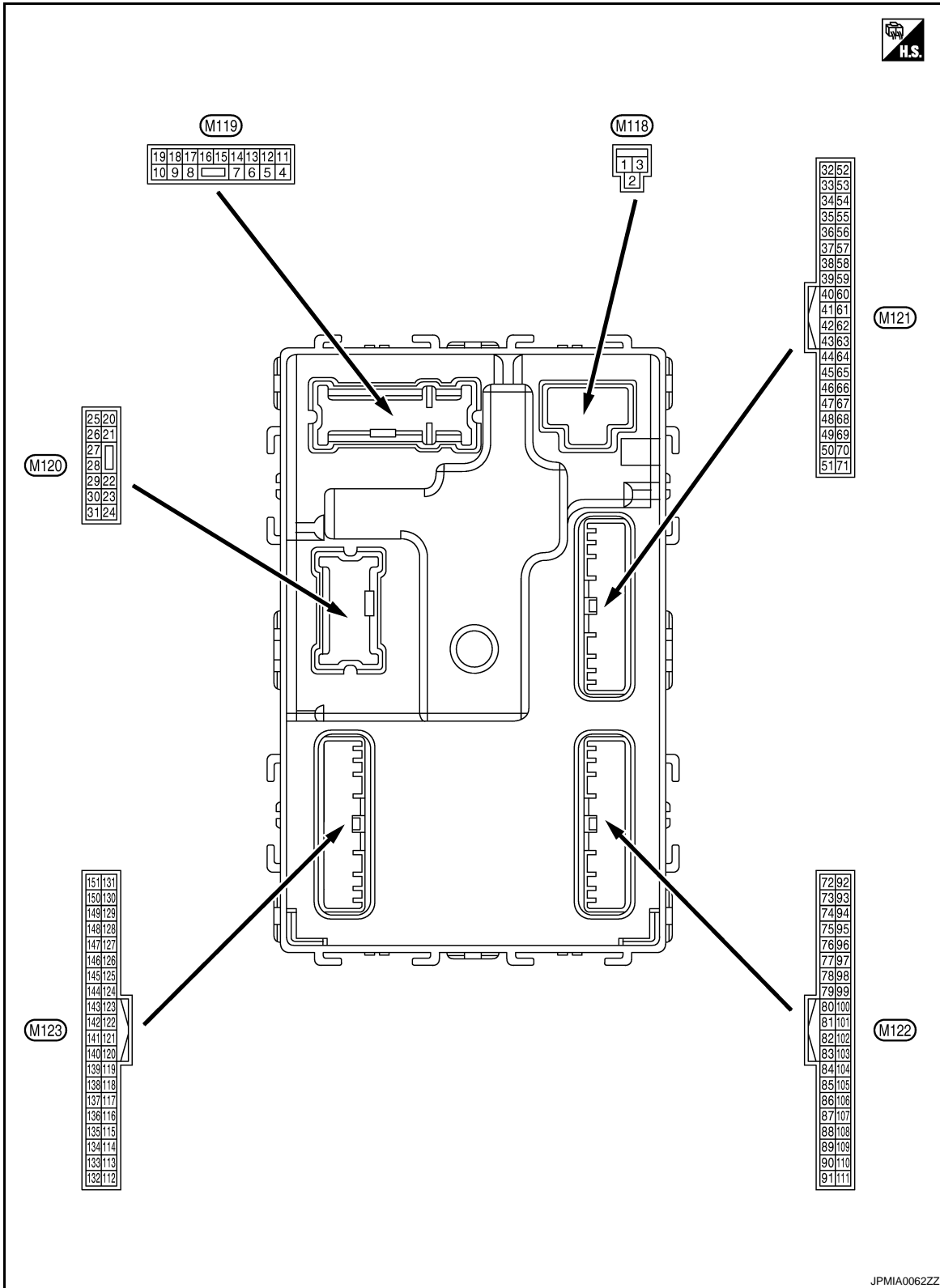

PHYSICAL VALUES

A
 B
 C
 D
 E
 F
 G
 H
 I
 J
 K
 DEF
 M
 N
 O
 P

BCM (BODY CONTROL MODULE)

< ECU DIAGNOSIS >

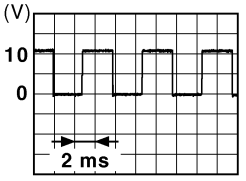
Terminal No. (Wire color)		Description		Condition		Value (Approx.)
+	-	Signal name	Input/ Output			
1 (W)	Ground	Battery power supply	Input	Ignition switch OFF		Battery voltage
2 (Y)	Ground	P/W power supply (BAT)	Output	Ignition switch OFF		Battery voltage
3 (O)	Ground	P/W power supply (RAP)	Output	Ignition switch ON		Battery voltage
4 (LG)	Ground	Interior room lamp power supply	Output	Interior room lamp battery saver is activated. (Cuts the interior room lamp power supply)		0 V
				Interior room lamp battery saver is not activated. (Outputs the interior room lamp power supply)		Battery voltage
5 (L)	Ground	Passenger door UN- LOCK	Output	Passenger door	UNLOCK (Actuator is activated)	Battery voltage
					Other than UNLOCK (Actuator is not activated)	0 V
7 (Y)	Ground	Step lamp	Output	Step lamp	ON	0 V
					OFF	Battery voltage
8 (V)	Ground	All doors, fuel lid LOCK	Output	All doors	LOCK (Actuator is activated)	Battery voltage
					Other than LOCK (Actuator is not activated)	0 V
9 (G)	Ground	Driver door, fuel lid UNLOCK	Output	Driver door	UNLOCK (Actuator is activated)	Battery voltage
					Other than UNLOCK (Actuator is not activated)	0 V
10 (BR)	Ground	Rear RH door and rear LH door UN- LOCK	Output	Rear RH door and rear LH door	UNLOCK (Actuator is activated)	Battery voltage
					Other than UNLOCK (Actuator is not activated)	0 V
11 (R)	Ground	Battery power supply	Input	Ignition switch OFF		Battery voltage
13 (B)	Ground	Ground	—	Ignition switch ON		0 V
14 (W)	Ground	Push-button ignition switch illumination ground	Output	Tail lamp	OFF	0 V
					ON	<p>NOTE: When the illumination brightening/dimming level is in the neutral position</p>  <p style="text-align: right;">JSNIA0010GB</p>
15 (Y)	Ground	ACC indicator lamp	Output	Ignition switch	OFF or ON	Battery voltage
					ACC	0 V

BCM (BODY CONTROL MODULE)

< ECU DIAGNOSIS >

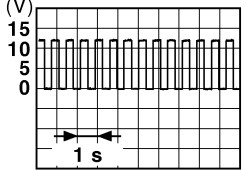
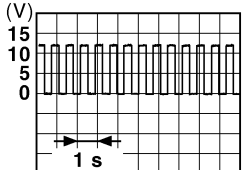
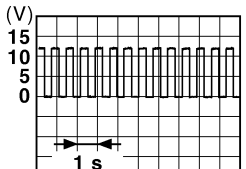
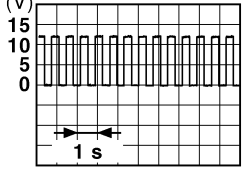
Terminal No. (Wire color)		Description		Condition	Value (Approx.)	
+	-	Signal name	Input/ Output			
17 (W)	Ground	Turn signal RH (Front)	Output	Ignition switch ON	Turn signal switch OFF	0 V
				Turn signal switch RH	 6.5 V	
18 (O)	Ground	Turn signal LH (Front)	Output	Ignition switch ON	Turn signal switch OFF	0 V
				Turn signal switch LH	 6.5 V	
19 (V)	Ground	Room lamp timer control	Output	Interior room lamp	OFF	Battery voltage
				ON	0 V	
20 (V)	Ground	Turn signal RH (Rear)	Output	Ignition switch ON	Turn signal switch OFF	0 V
				Turn signal switch RH	 6.5 V	
23 (G)	Ground	Back door opening	Output	Back door	OPEN (Back door opener actuator is activated)	Battery voltage
				Other than OPEN (Back door opener actuator is not activated)	0 V	
25 (G)	Ground	Turn signal LH (Rear)	Output	Ignition switch ON	Turn signal switch OFF	0 V
				Turn signal switch LH	 6.5 V	
26 (G)	Ground	Rear wiper	Output	Rear wiper	OFF (Stopped)	0 V
				ON (Operated)	Battery voltage	

A
B
C
D
E
F
G
H
I
J
K
DEF
M
N
O
P

BCM (BODY CONTROL MODULE)

< ECU DIAGNOSIS >

Terminal No. (Wire color)		Description		Condition	Value (Approx.)
+	-	Signal name	Input/ Output		
34 (SB)	Ground	Luggage room antenna 1 (-)	Output	Ignition switch OFF	<p style="text-align: right; font-size: small;">JMKIA0062GB</p>
				When Intelligent Key is not in the passenger compartment	<p style="text-align: right; font-size: small;">JMKIA0063GB</p>
35 (V)	Ground	Luggage room antenna 1 (+)	Output	Ignition switch OFF	<p style="text-align: right; font-size: small;">JMKIA0062GB</p>
				When Intelligent Key is not in the passenger compartment	<p style="text-align: right; font-size: small;">JMKIA0063GB</p>
38 (B)	Ground	Rear bumper antenna (-)	Output	When the back door request switch is operated with ignition switch OFF	<p style="text-align: right; font-size: small;">JMKIA0062GB</p>
				When Intelligent Key is not in the antenna detection area	<p style="text-align: right; font-size: small;">JMKIA0063GB</p>

BCM (BODY CONTROL MODULE)

< ECU DIAGNOSIS >

Terminal No. (Wire color)		Description		Condition	Value (Approx.)
		Signal name	Input/ Output		
+	-				
39 (W)	Ground	Rear bumper antenna (+)	Output	When the back door request switch is operated with ignition switch OFF	<p style="text-align: right; font-size: small;">JMKIA0062GB</p>
				When Intelligent Key is not in the antenna detection area	<p style="text-align: right; font-size: small;">JMKIA0063GB</p>
47 (Y)	Ground	Ignition relay (IPDM E/R) control	Output	Ignition switch	OFF or ACC Battery voltage ON 0 V
				52 (SB)	Ground
When selector lever is not in P or N position 0 V					
61 (W)	Ground	Back door opener request switch	Input	Back door request switch	ON (Pressed) 0 V
				OFF (Not pressed)	<p style="text-align: right; font-size: small;">JPMIA0016GB</p>
64 (V)	Ground	Request switch buzzer	Output	Request switch buzzer	Sounding 0 V Not sounding Battery voltage
				65 (O)	Ground
Not in stop position 0 V					

A
B
C
D
E
F
G
H
I
J
K
DEF
M
N
O
P

BCM (BODY CONTROL MODULE)

< ECU DIAGNOSIS >

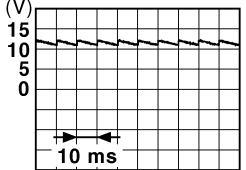
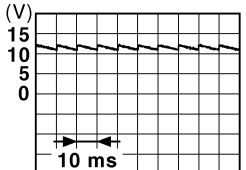
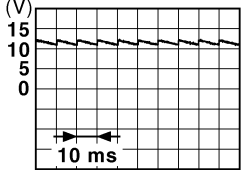
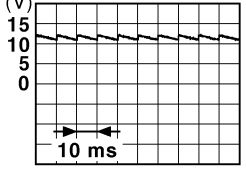
Terminal No. (Wire color)		Description		Condition	Value (Approx.)
		Signal name	Input/ Output		
+	-				
66 (R)	Ground	Back door switch	Input	Back door switch	OFF (Door close) <div style="text-align: right;">  <p style="font-size: small; margin: 0;">JPMIA0011GB</p> <p style="margin: 0;">11.8 V</p> </div>
					ON (Door open)
67 (GR)	Ground	Back door opener switch	Input	Back door opener switch	Pressed <div style="text-align: right;">  <p style="font-size: small; margin: 0;">JPMIA0011GB</p> <p style="margin: 0;">11.8 V</p> </div>
					Not pressed
68 (BR)	Ground	Rear RH door switch	Input	Rear RH door switch	OFF (Door close) <div style="text-align: right;">  <p style="font-size: small; margin: 0;">JPMIA0011GB</p> <p style="margin: 0;">11.8 V</p> </div>
					ON (Door open)
69 (R)	Ground	Rear LH door switch	Input	Rear LH door switch	OFF (Door close) <div style="text-align: right;">  <p style="font-size: small; margin: 0;">JPMIA0011GB</p> <p style="margin: 0;">11.8 V</p> </div>
					ON (Door open)

BCM (BODY CONTROL MODULE)

< ECU DIAGNOSIS >

Terminal No. (Wire color)		Description		Condition	Value (Approx.)
		Signal name	Input/ Output		
+	-				
72 (R)	Ground	Room antenna 2 (-) (Center console)	Output	Ignition switch OFF	<p style="text-align: right; font-size: small;">JMKIA0062GB</p>
				When Intelligent Key is not in the passenger compart- ment	<p style="text-align: right; font-size: small;">JMKIA0063GB</p>
73 (G)	Ground	Room antenna 2 (+) (Center console)	Output	Ignition switch OFF	<p style="text-align: right; font-size: small;">JMKIA0062GB</p>
				When Intelligent Key is not in the passenger compart- ment	<p style="text-align: right; font-size: small;">JMKIA0063GB</p>
74 (SB)	Ground	Passenger door an- tenna (-)	Output	When the pas- senger door re- quest switch is operated with ig- nition switch OFF	<p style="text-align: right; font-size: small;">JMKIA0062GB</p>
				When Intelligent Key is not in the antenna detec- tion area	<p style="text-align: right; font-size: small;">JMKIA0063GB</p>

A
B
C
D
E
F
G
H
I
J
K
DEF
M
N
O
P

BCM (BODY CONTROL MODULE)

< ECU DIAGNOSIS >

Terminal No. (Wire color)		Description		Condition	Value (Approx.)
+	-	Signal name	Input/ Output		
75 (GR)	Ground	Passenger door antenna (+)	Output	When Intelligent Key is in the antenna detection area	<p style="text-align: right; font-size: small;">JMKIA0062GB</p>
				When Intelligent Key is not in the antenna detection area	<p style="text-align: right; font-size: small;">JMKIA0063GB</p>
76 (V)	Ground	Driver door antenna (-)	Output	When Intelligent Key is in the antenna detection area	<p style="text-align: right; font-size: small;">JMKIA0062GB</p>
				When Intelligent Key is not in the antenna detection area	<p style="text-align: right; font-size: small;">JMKIA0063GB</p>
77 (LG)	Ground	Driver door antenna (+)	Output	When Intelligent Key is in the antenna detection area	<p style="text-align: right; font-size: small;">JMKIA0062GB</p>
				When Intelligent Key is not in the antenna detection area	<p style="text-align: right; font-size: small;">JMKIA0063GB</p>

BCM (BODY CONTROL MODULE)





< ECU DIAGNOSIS >

Terminal No. (Wire color)		Description		Condition	Value (Approx.)	
+	-	Signal name	Input/ Output			
78 (Y)	Ground	Room antenna (-) (Instrument panel)	Output	Ignition switch OFF		
				When Intelligent Key is not in the passenger compart- ment		
79 (BR)	Ground	Room antenna (+) (Instrument panel)	Output	Ignition switch OFF		
				When Intelligent Key is not in the passenger compart- ment		
80 (GR)	Ground	NATS antenna amp (Built in key slot)	Input/ Output	During waiting	Ignition switch is pressed while inserting the key into the key slot.	Just after pressing ignition switch. Pointer of tester should move.
81 (W)	Ground	NATS antenna amp (Built in key slot)	Input/ Output	During waiting	Ignition switch is pressed while inserting the key into the key slot.	Just after pressing ignition switch. Pointer of tester should move.
82 (R)	Ground	Ignition relay [Fuse block (J/B)] control	Output	Ignition switch	OFF or ACC	0 V
				ON	Battery voltage	

A
B
C
D
E
F
G
H
I
J
K
DEF
M
N
O
P

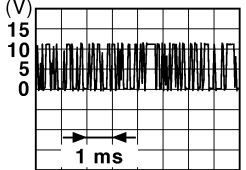
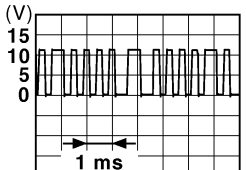
BCM (BODY CONTROL MODULE)

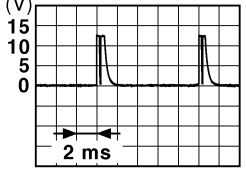
< ECU DIAGNOSIS >

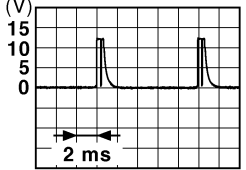
Terminal No. (Wire color)		Description		Condition	Value (Approx.)	
		Signal name	Input/ Output			
+	-					
83 (Y)	Ground	Remote keyless entry receiver signal	Input/ Output	During waiting	 <small>JMKIA0064GB</small>	
				When operating either button on the key	 <small>JMKIA0065GB</small>	
87 (BR)	Ground	Combination switch INPUT 5	Input	Combination switch	All switch OFF (Wiper intermittent dial 4)	 <small>JPMIA0041GB</small> 1.4 V
					Front fog lamp switch ON (Wiper intermittent dial 4)	 <small>JPMIA0037GB</small> 1.3 V
					Rear wiper switch ON (Wiper intermittent dial 4)	 <small>JPMIA0039GB</small> 1.3 V
					Any of the conditions below with all switch OFF <ul style="list-style-type: none"> • Wiper intermittent dial 1 • Wiper intermittent dial 2 • Wiper intermittent dial 6 • Wiper intermittent dial 7 	 <small>JPMIA0040GB</small> 1.3 V

BCM (BODY CONTROL MODULE)

< ECU DIAGNOSIS >

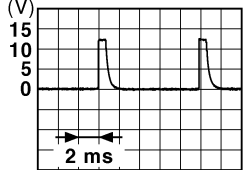
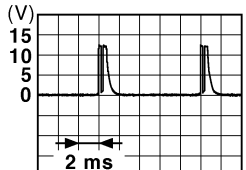
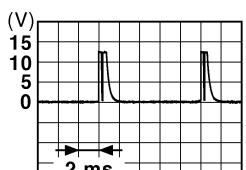
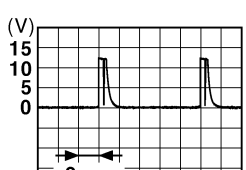
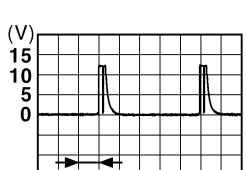
Terminal No. (Wire color)		Description		Condition	Value (Approx.)	
+	-	Signal name	Input/ Output			
88 (V)	Ground	Combination switch INPUT 3	Input	Combination switch	All switch OFF (Wiper intermittent dial 4)	 <p style="text-align: right;">1.4 V</p>
					Lighting switch HI (Wiper intermittent dial 4)	 <p style="text-align: right;">1.3 V</p>
					Lighting switch 2ND (Wiper intermittent dial 4)	 <p style="text-align: right;">1.3 V</p>
					Rear washer switch ON (Wiper intermittent dial 4)	 <p style="text-align: right;">1.3 V</p>
					Any of the conditions below with all switch OFF	 <p style="text-align: right;">1.3 V</p>
89 (BR)	Ground	Push-button ignition switch (Push switch)	Input	Push-button ignition switch (push switch)	Pressed	0 V
				Not pressed	Battery voltage	
90 (P)	Ground	CAN-L	Input/ Output	—	—	—
91 (L)	Ground	CAN-H	Input/ Output	—	—	—

A
B
C
D
E
F
G
H
I
J
K
DEF
M
N
O
P

BCM (BODY CONTROL MODULE)

< ECU DIAGNOSIS >

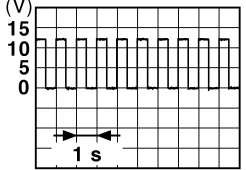
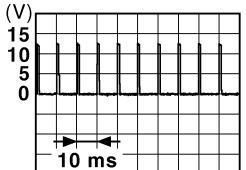
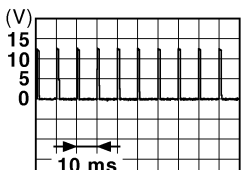
Terminal No. (Wire color)		Description		Condition	Value (Approx.)	
+	-	Signal name	Input/ Output			
92 (LG)	Ground	Key slot illumination	Output	Key slot illumination	OFF	Battery voltage
					Blinking	 <p style="text-align: right;">JPMIA0015GB</p> <p style="text-align: center;">6.5 V</p>
93 (V)	Ground	ON indicator lamp	Output	Ignition switch	OFF or ACC	Battery voltage
					ON	0 V
94 (Y)	Ground	Puddle lamp control	Output	Puddle lamp	OFF	Battery voltage
					ON	0 V
95 (O)	Ground	ACC relay control	Output	Ignition switch	OFF	0 V
					ACC or ON	Battery voltage
96 (GR)	Ground	Control device (Detention switch) power supply	Output	—	Battery voltage	
97 (L)	Ground	Steering lock condition No. 1	Input	Steering lock	LOCK status	0 V
					UNLOCK status	Battery voltage
98 (P)	Ground	Steering lock condition No. 2	Input	Steering lock	LOCK status	Battery voltage
					UNLOCK status	0 V
99 (R)	Ground	Selector lever P position switch	Input	Selector lever	P position	0 V
					Any position other than P	Battery voltage
100 (G)	Ground	Passenger door request switch	Input	Passenger door request switch	ON (Pressed)	0 V
					OFF (Not pressed)	 <p style="text-align: right;">JPMIA0016GB</p> <p style="text-align: center;">1.0 V</p>
101 (SB)	Ground	Driver door request switch	Input	Driver door request switch	ON (Pressed)	0 V
					OFF (Not pressed)	 <p style="text-align: right;">JPMIA0016GB</p> <p style="text-align: center;">1.0 V</p>
102 (O)	Ground	Blower fan motor relay control	Output	Ignition switch	OFF or ACC	0 V
					ON	Battery voltage

BCM (BODY CONTROL MODULE)

< ECU DIAGNOSIS >

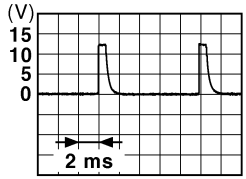
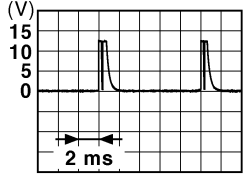
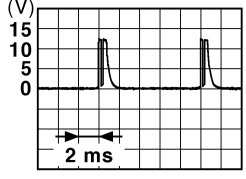
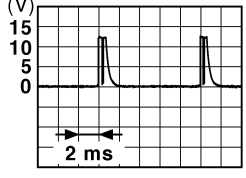
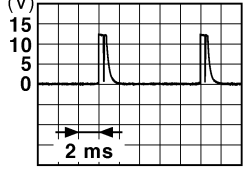
Terminal No. (Wire color)		Description		Condition	Value (Approx.)	
		Signal name	Input/ Output			
+	-					
103 (LG)	Ground	Remote keyless entry receiver power supply	Output	Ignition switch OFF	Battery voltage	
106 (W)	Ground	Steering wheel lock unit power supply	Output	Ignition switch	OFF or ACC	
					ON	0 V
107 (LG)	Ground	Combination switch INPUT 1	Input	Combination switch (Wiper intermittent dial 4)	All switch OFF	 <p style="text-align: right; font-size: small;">JPMIA0041GB</p> <p style="text-align: center;">1.4 V</p>
					Turn signal switch LH	 <p style="text-align: right; font-size: small;">JPMIA0037GB</p> <p style="text-align: center;">1.3 V</p>
					Turn signal switch RH	 <p style="text-align: right; font-size: small;">JPMIA0036GB</p> <p style="text-align: center;">1.3 V</p>
					Front wiper switch LO	 <p style="text-align: right; font-size: small;">JPMIA0038GB</p> <p style="text-align: center;">1.3 V</p>
					Front washer switch ON	 <p style="text-align: right; font-size: small;">JPMIA0039GB</p> <p style="text-align: center;">1.3 V</p>

A
B
C
D
E
F
G
H
I
J
K
DEF
M
N
O
P



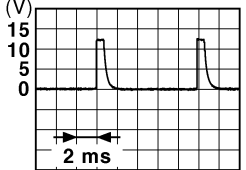
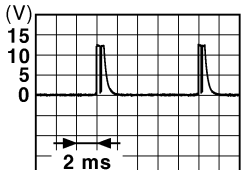
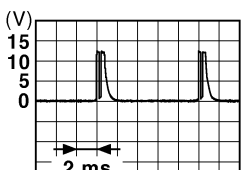
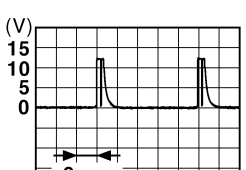
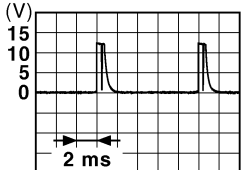

BCM (BODY CONTROL MODULE)

< ECU DIAGNOSIS >

Terminal No. (Wire color)		Description		Condition	Value (Approx.)	
		Signal name	Input/ Output			
+	-					
108 (R)	Ground	Combination switch INPUT 4	Input	Combination switch	All switch OFF (Wiper intermittent dial 4)	 <p style="text-align: right; font-size: small;">JPMIA0041GB</p> <p style="text-align: center;">1.4 V</p>
					Lighting switch AUTO (Wiper intermittent dial 4)	 <p style="text-align: right; font-size: small;">JPMIA0038GB</p> <p style="text-align: center;">1.3 V</p>
					Lighting switch 1ST (Wiper intermittent dial 4)	 <p style="text-align: right; font-size: small;">JPMIA0036GB</p> <p style="text-align: center;">1.3 V</p>
					Rear wiper switch INT (Wiper intermittent dial 4)	 <p style="text-align: right; font-size: small;">JPMIA0040GB</p> <p style="text-align: center;">1.3 V</p>
					Any of the conditions below with all switch OFF	<ul style="list-style-type: none"> • Wiper intermittent dial 1 • Wiper intermittent dial 5 • Wiper intermittent dial 6  <p style="text-align: right; font-size: small;">JPMIA0039GB</p> <p style="text-align: center;">1.3 V</p>

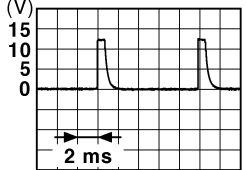
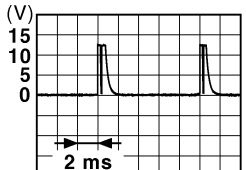
BCM (BODY CONTROL MODULE)

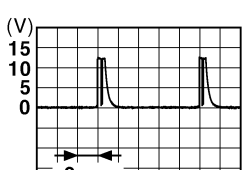
< ECU DIAGNOSIS >

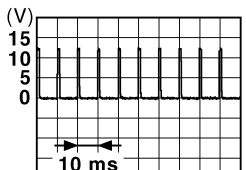
Terminal No. (Wire color)		Description		Condition	Value (Approx.)	
		Signal name	Input/ Output			
+	-					
109 (Y)	Ground	Combination switch INPUT 2	Input	Combination switch (Wiper intermittent dial 4)	All switch OFF	 <small>JPMIA0041GB</small> 1.4 V
					Lighting switch PASS	 <small>JPMIA0037GB</small> 1.3 V
					Lighting switch 2ND	 <small>JPMIA0036GB</small> 1.3 V
					Front wiper switch INT	 <small>JPMIA0038GB</small> 1.3 V
					Front wiper switch HI	 <small>JPMIA0040GB</small> 1.3 V
					ON	0 V
110 (G)	Ground	Hazard switch	Input	Hazard switch	OFF	 <small>JPMIA0012GB</small> 1.1 V

A
B
C
D
E
F
G
H
I
J
K
DEF
M
N
O
P

BCM (BODY CONTROL MODULE)

< ECU DIAGNOSIS >

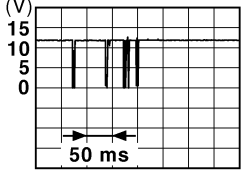
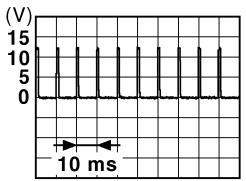
Terminal No. (Wire color)		Description		Condition		Value (Approx.)
+	-	Signal name	Input/ Output			
111 (Y)	Ground	Steering lock unit communication	Input/ Output	Steering lock	LOCK status	Battery voltage
					LOCK or UNLOCK	
					For 15 seconds after UN- LOCK	Battery voltage
					15 seconds or later after UNLOCK	0 V
113* (P)	Ground	Optical sensor signal	Input	Ignition switch ON	When bright outside of the vehicle	Close to 5 V
					When dark outside of the vehicle	Close to 0 V
116 (SB)	Ground	Fuse check [Stop lamp switch, ICC brake hold relay (With ICC)]	Input	—	Battery voltage	
118 (P)	Ground	Stop lamp switch (Without ICC)	Input	Stop lamp switch	OFF (Brake pedal is not depressed)	0 V
					ON (Brake pedal is de- pressed)	Battery voltage
		Stop lamp switch and ICC brake hold relay (With ICC)		Stop lamp switch OFF (Brake pedal is not de- pressed) and ICC brake hold relay OFF	0 V	
				Stop lamp switch ON (Brake pedal is de- pressed) or ICC brake hold relay ON	Battery voltage	
119 (SB)	Ground	Front door lock as- sembly driver side (unlock sensor)	Input	Driver door	LOCK status (Unlock sensor switch OFF)	
					UNLOCK status (Unlock switch sensor ON)	0 V
					1.1 V	
121 (BR)	Ground	Key slot switch	Input	When the key is inserted into key slot	Battery voltage	
				When the key is not inserted into key slot	0 V	
122 (V)	Ground	ACC feedback signal	Input	Ignition switch	OFF	0 V
					ACC or ON	Battery voltage
123 (W)	Ground	IGN feedback signal	Input	Ignition switch	OFF or ACC	0 V
					ON	Battery voltage

BCM (BODY CONTROL MODULE)

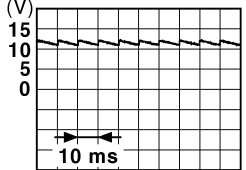
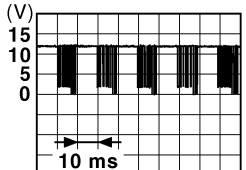
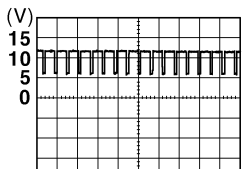

< ECU DIAGNOSIS >

Terminal No. (Wire color)		Description		Condition	Value (Approx.)	
		Signal name	Input/ Output			
+	-					
124 (LG)	Ground	Passenger door switch	Input	Passenger door switch	OFF (Door close) <div style="text-align: right;">  <p style="font-size: small;">JPMIA0011GB</p> </div>	
					ON (Door open)	0 V
132 (V)	Ground	Power window switch communication	Input/ Output	Ignition switch ON	 <p style="font-size: small;">JPMIA0013GB</p>	
					Ignition switch OFF or ACC	Battery voltage
133 (W)	Ground	Push-button ignition switch illumination	Output	Push-button igni- tion switch illumina- tion	ON (Tail lamps OFF) 9.5 V	
					ON (Tail lamps ON)	NOTE: The pulse width of this wave is varied by the illumination bright- ening/dimming level. <div style="text-align: right;">  <p style="font-size: small;">JPMIA0159GB</p> </div>
					OFF	0 V
134 (GR)	Ground	LOCK indicator lamp	Output	LOCK indicator lamp	OFF Battery voltage ON 0 V	
137 (O)	Ground	Receiver and sensor ground	Input	Ignition switch ON	0 V	
138 (Y)	Ground	Sensor power supply	Output	Ignition switch	OFF 0 V ACC or ON 5.0 V	

A
B
C
D
E
F
G
H
I
J
K
DEF
M
N
O
P

BCM (BODY CONTROL MODULE)

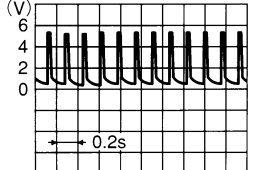
< ECU DIAGNOSIS >

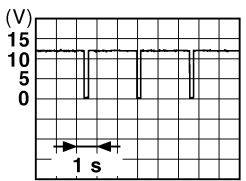
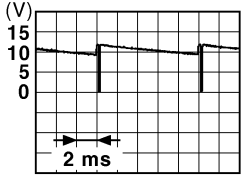
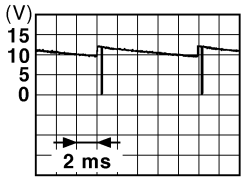
Terminal No. (Wire color)		Description		Condition	Value (Approx.)
+	-	Signal name	Input/ Output		
139 (L)	Ground	Tire pressure receiver signal	Input/ Output	Ignition switch ON	Standby state 
				When receiving the signal from the transmitter 	
140 (GR)	Ground	Selector lever P/N position signal	Input	Selector lever	P or N position Battery voltage
				Except P and N positions	0 V
141 (G)	Ground	Security indicator signal	Output	Security indicator	ON 0 V
				Blinking 	11.3 V
				OFF	Battery voltage
142 (O)	Ground	Combination switch OUTPUT 5	Output	Combination switch (Wiper intermittent dial 4)	All switch OFF 0 V
				Lighting switch 1ST	
				Lighting switch HI	
				Lighting switch 2ND	
				Turn signal switch RH	
143 (P)	Ground	Combination switch OUTPUT 1	Output	Combination switch	All switch OFF (Wiper intermittent dial 4) 0 V
				Front wiper switch HI (Wiper intermittent dial 4)	
				Rear wiper switch INT (Wiper intermittent dial 4)	
				Any of the conditions below with all switch OFF • Wiper intermittent dial 1 • Wiper intermittent dial 2 • Wiper intermittent dial 3 • Wiper intermittent dial 6 • Wiper intermittent dial 7	

BCM (BODY CONTROL MODULE)

< ECU DIAGNOSIS >

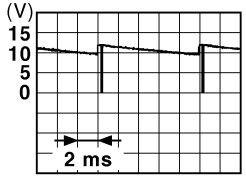
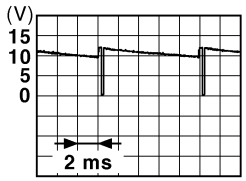
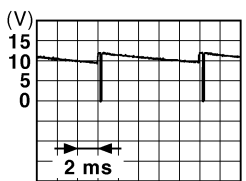
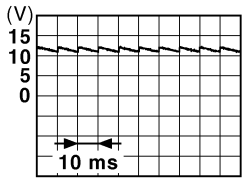
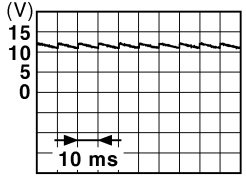
Terminal No. (Wire color)		Description		Condition	Value (Approx.)		
		Signal name	Input/ Output				
+	-						
144 (G)	Ground	Combination switch OUTPUT 2	Output	Combination switch	All switch OFF (Wiper intermittent dial 4)	0 V	
					Front washer switch ON (Wiper intermittent dial 4)		
					Rear wiper switch ON (Wiper intermittent dial 4)		
					Rear washer switch ON (Wiper intermittent dial 4)		
					Any of the conditions below with all switch OFF <ul style="list-style-type: none"> • Wiper intermittent dial 1 • Wiper intermittent dial 5 • Wiper intermittent dial 6 		10.7 V
145 (L)	Ground	Combination switch OUTPUT 3	Output	Combination switch (Wiper intermit- tent dial 4)	All switch OFF	0 V	
					Front wiper switch INT		
					Front wiper switch LO		
					Lighting switch AUTO		10.7 V
146 (SB)	Ground	Combination switch OUTPUT 4	Output	Combination switch (Wiper intermit- tent dial 4)	All switch OFF	0 V	
					Front fog lamp switch ON		
					Lighting switch 2ND		
					Lighting switch PASS		
				Turn signal switch LH	10.7 V		
149 (W)	Ground	Tire pressure warn- ing check switch	Input	Ignition switch ON		11.8 V	
150 (LG)	Ground	Driver door switch	Input	Driver door switch	OFF (Door close)		11.8 V
					ON (Door open)	0 V	
151 (G)	Ground	Rear window defog- ger relay	Output	Rear window de- fogger	Active	0 V	
					Not activated	Battery voltage	

A
B
C
D
E
F
G
H
I
J
K
DEF
M
N
O
P

BCM (BODY CONTROL MODULE)

< ECU DIAGNOSIS >

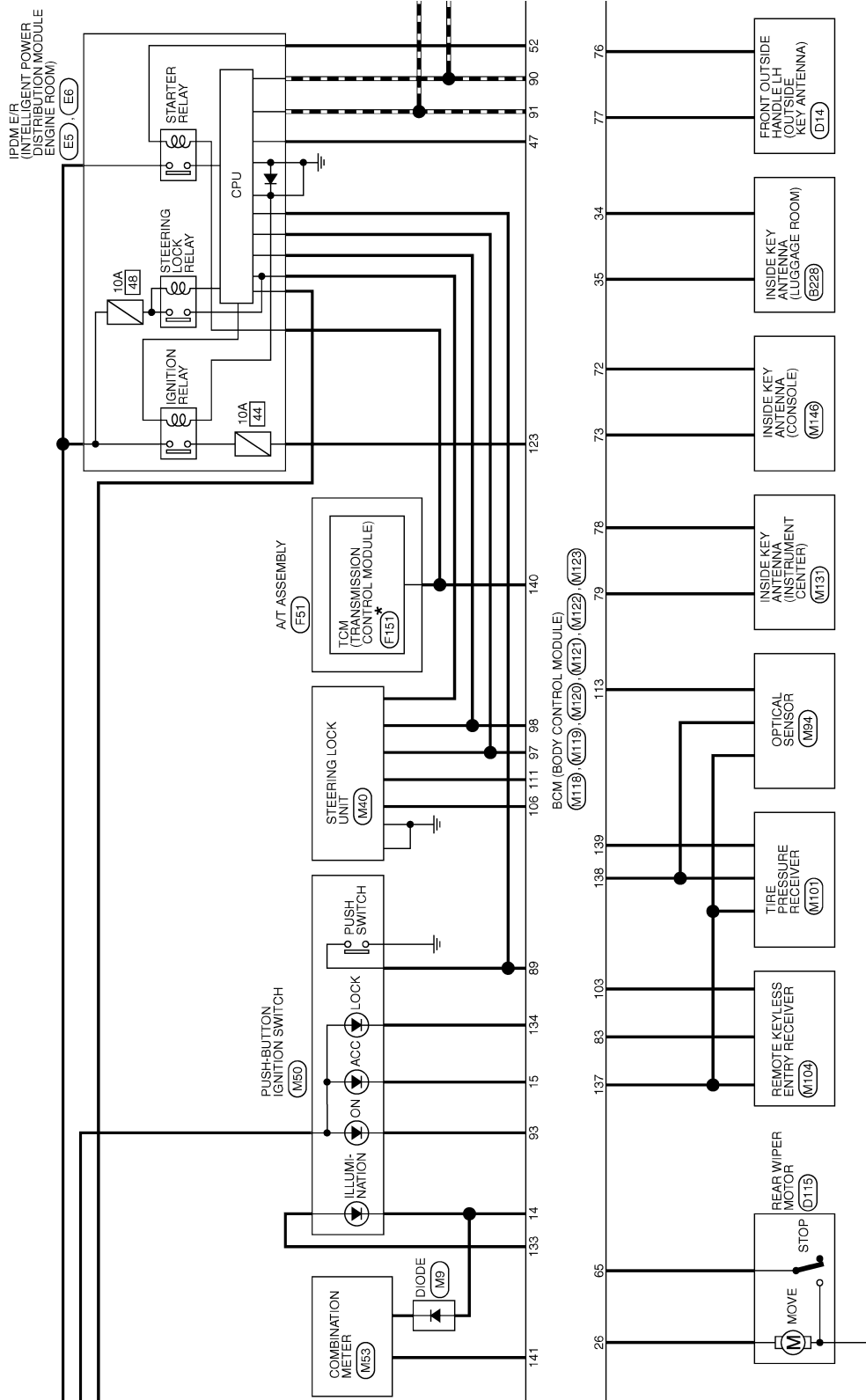

*: This connector is not shown in "Harness Layout".

JCMWM1399G1

A
B
C
D
E
F
G
H
I
J
K
DEF
M
N
O
P

BCM (BODY CONTROL MODULE)

< ECU DIAGNOSIS >

- ◊NV◊ : With NAVI
- ◊ON◊ : Without NAVI
- ◊RF◊ : With sunroof
- ◊PM◊ : With automatic drive positioner
- ◊OP◊ : Without automatic drive positioner

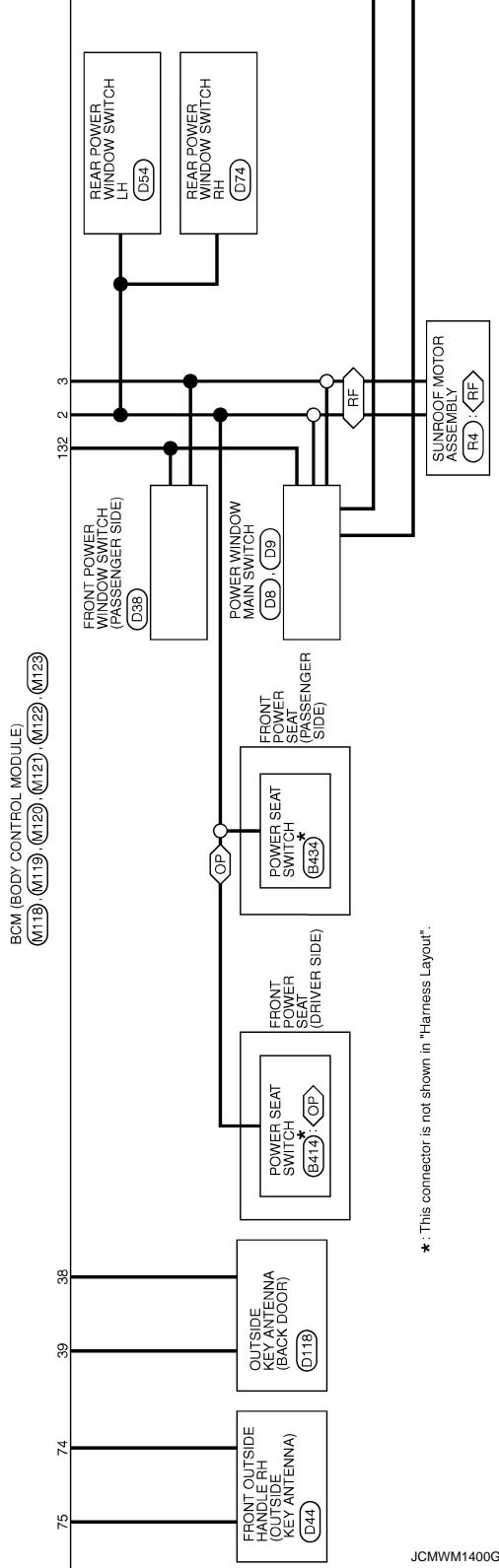
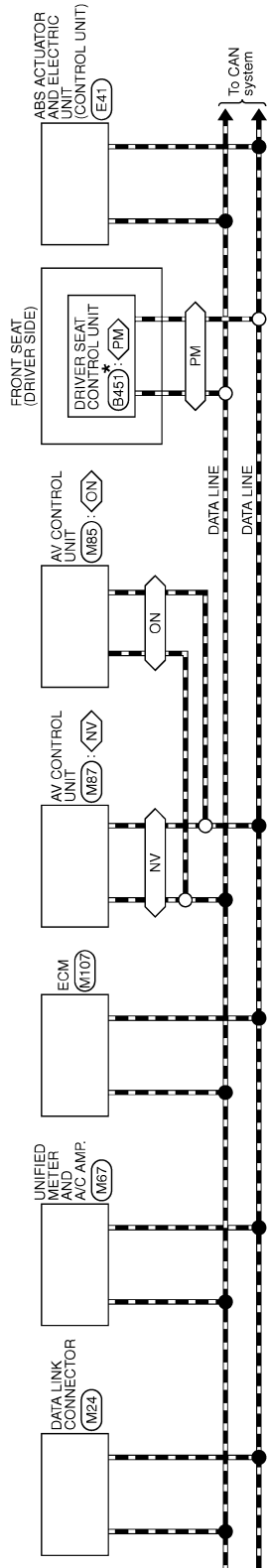

* : This connector is not shown in "Harness Layout".

JCMWM1400G

BCM (BODY CONTROL MODULE)

< ECU DIAGNOSIS >

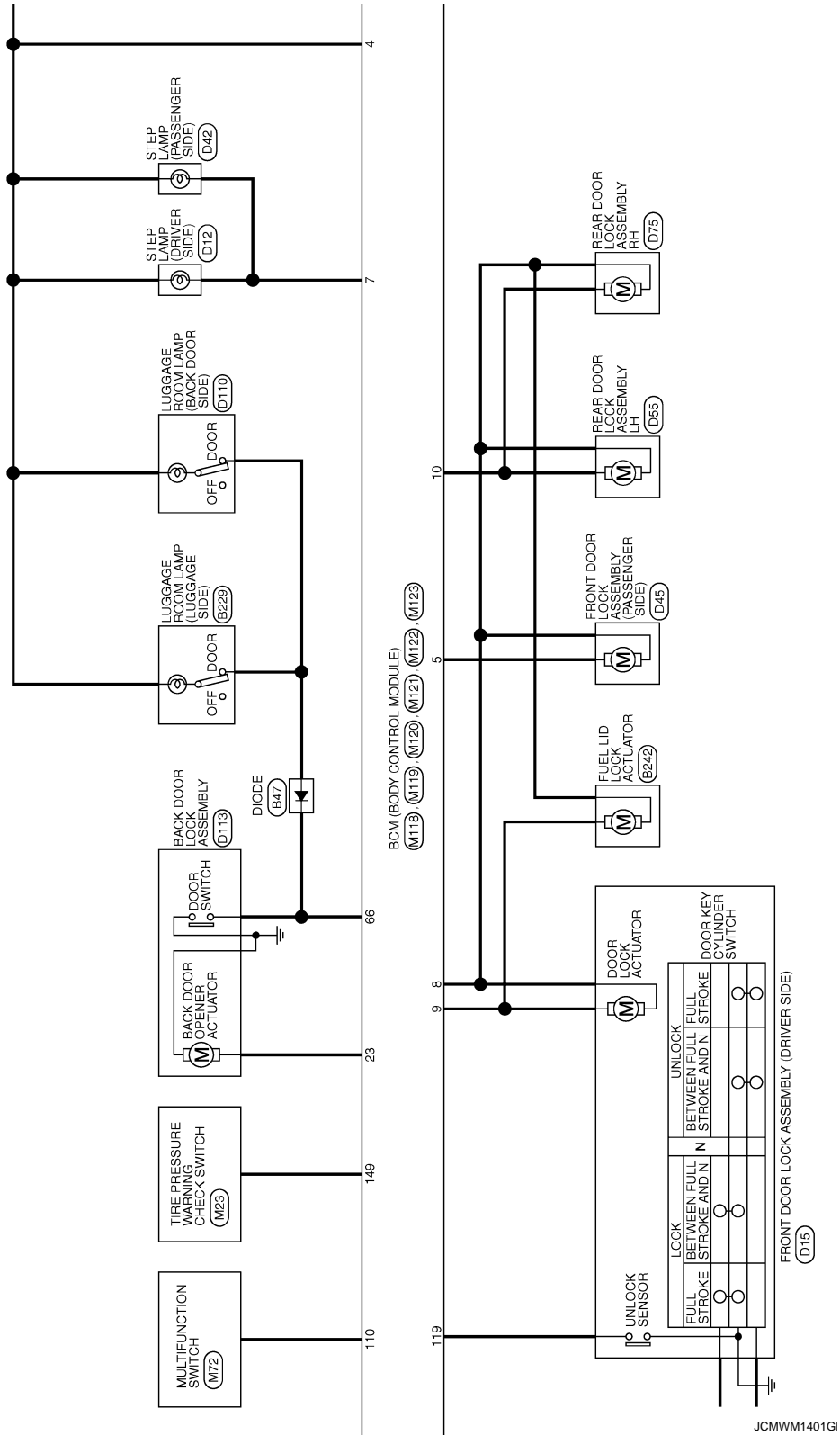

A
B
C
D
E
F
G
H
I
J
K
DEF
M
N
O
P

BCM (BODY CONTROL MODULE)

< ECU DIAGNOSIS >

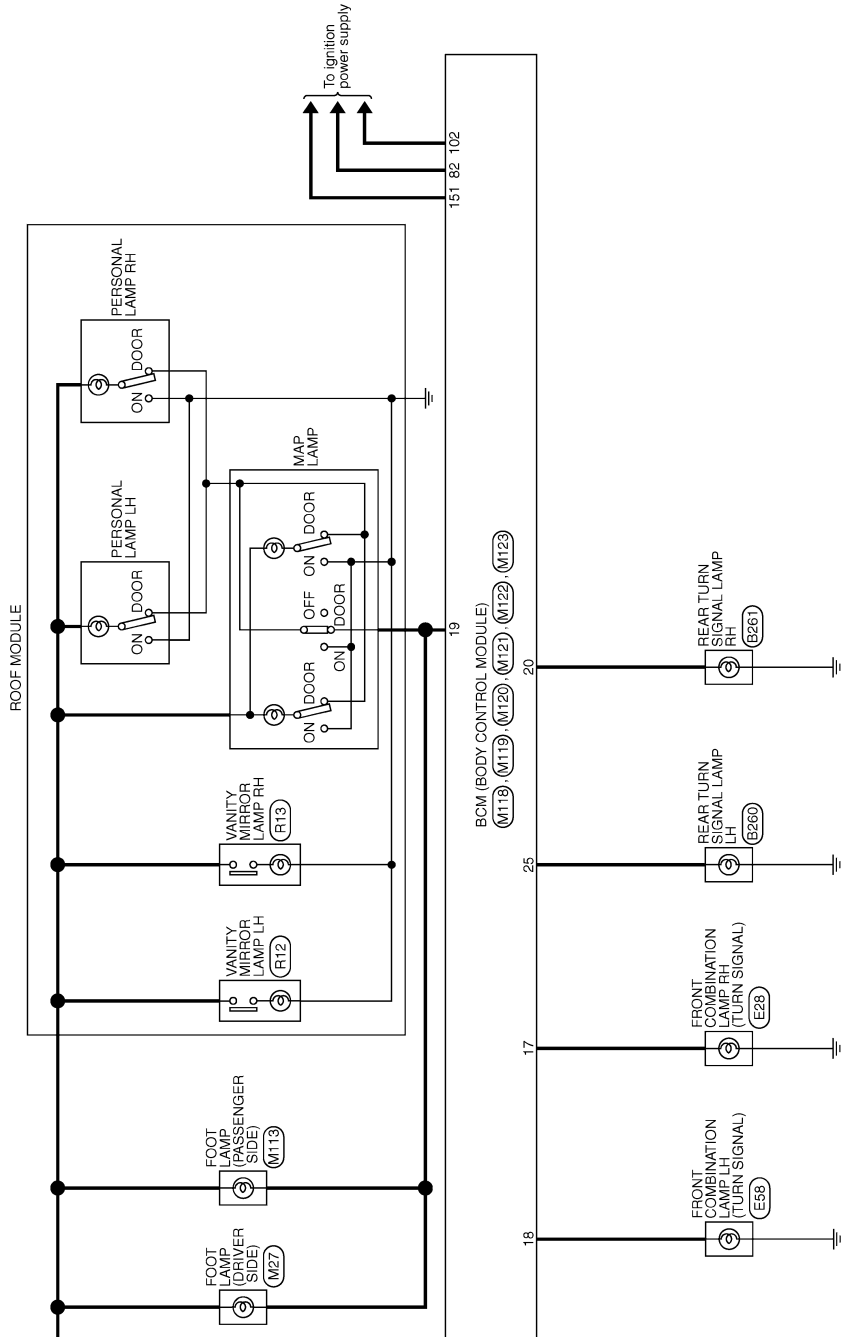

JCMWM1402G

BCM (BODY CONTROL MODULE)

< ECU DIAGNOSIS >

BCM (BODY CONTROL MODULE)

Connector No.	M33
Connector Name	COMBINATION SWITCH
Connector Type	TH16FW-NH

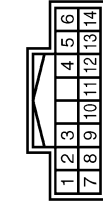

Terminal No.	Color of Wire	Signal Name [Specification]
2	SB	OUTPUT 4
5	L	OUTPUT 3
7	V	INPUT 3
8	O	OUTPUT 5
9	Y	INPUT 2
10	R	INPUT 4
11	LG	INPUT 1
12	P	OUTPUT 1
13	BR	INPUT 5
14	G	OUTPUT 2

Connector No.	M120
Connector Name	BCM (BODY CONTROL MODULE)
Connector Type	NS12FW-CS



Terminal No.	Color of Wire	Signal Name [Specification]
20	V	TURN SIGNAL RH (REAR)
23	G	BACK DOOR OPEN OUTPUT
25	G	TURN SIGNAL LH (REAR)
26	G	REAR WIPER OUTPUT

Connector No.	M118
Connector Name	BCM (BODY CONTROL MODULE)
Connector Type	M03FB-LC



Terminal No.	Color of Wire	Signal Name [Specification]
1	W	BAT (F/L)
2	Y	POWER WINDOW POWER SUPPLY(BAT)
3	O	POWER WINDOW POWER SUPPLY(RAP)

Connector No.	M121
Connector Name	BCM (BODY CONTROL MODULE)
Connector Type	TH40FGY-NH

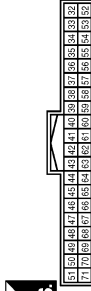

Terminal No.	Color of Wire	Signal Name [Specification]
34	SB	LUGGAGE ROOM ANTI-
35	V	LUGGAGE ROOM ANTI+
38	B	REAR BUMPER ANTI-
39	W	REAR BUMPER ANTI+
47	Y	IGN RELAY (PDM L/R CONT)
52	SB	STARTER RELAY CONT
61	W	BACK DOOR OPENER REQUEST SW
64	V	REQUEST SW BUZZER
65	O	REAR WIPER STOP POSITION
66	R	BACK DOOR SW
67	GR	BACK DOOR OPENER SW

Connector No.	M119
Connector Name	BCM (BODY CONTROL MODULE)
Connector Type	NS16FW-CS

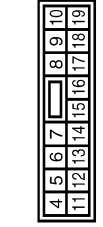

Terminal No.	Color of Wire	Signal Name [Specification]
4	LG	INTERIOR ROOM LAMP POWER SUPPLY
5	L	PASSNGR DOOR UNLOCK OUTPUT
7	Y	STEP LAMP OUTPUT
8	V	ALL DOOR FUEL LID LOCK OUTPUT
9	G	DRIVER DOOR UNLOCK OUTPUT
10	BR	REAR DOOR UNLOCK OUTPUT
11	R	BAT (RUSE)
13	B	GND
14	W	PUSH-BUTTON IGNITION SW ILL GND
15	Y	ACC IND
17	W	TURN SIGNAL RH (FRONT)

Connector No.	68
Connector Name	REAR RH DOOR SW
Connector Type	69
Connector Name	REAR LH DOOR SW

18	O	TURN SIGNAL LH (FRONT)
19	V	ROOM LAMP TIMER CONTROL

A
B
C
D
E
F
G
H
I
J
K
DEF
M
N
O
P

BCM (BODY CONTROL MODULE)

< ECU DIAGNOSIS >

BCM (BODY CONTROL MODULE)

Connector No.	M122
Connector Name	BCM (BODY CONTROL MODULE)
Connector Type	TH40FB-NH



18	19	20	21	22	23	24	25	26	27	28	29	30	31	32	33	34	35	36	37	38	39	40	41	42	43	44	45	46	47	48	49	50	51	52	53	54	55	56	57	58	59	60	61	62	63	64	65	66	67	68	69	70	71	72	73	74	75	76	77	78	79	80	81	82
----	----	----	----	----	----	----	----	----	----	----	----	----	----	----	----	----	----	----	----	----	----	----	----	----	----	----	----	----	----	----	----	----	----	----	----	----	----	----	----	----	----	----	----	----	----	----	----	----	----	----	----	----	----	----	----	----	----	----	----	----	----	----	----	----

Terminal No.	Color of Wire	Signal Name [Specification]
72	R	ROOM ANT2-
73	G	ROOM ANT2+
74	SB	PASSENGER DOOR ANT-
75	GR	PASSENGER DOOR ANT+
76	V	DRIVER DOOR ANT-
77	LG	DRIVER DOOR ANT+
78	Y	ROOM ANT1-
79	BR	ROOM ANT1+
80	GR	IMMOBI ANTENNA CONTROL
81	W	IMMOBI ANTENNA SIGNAL
82	R	IGN RELAY (F/B) CONT

83	Y	KEYLESS TUNER SIGNAL
87	BR	COMBI SW INPUT 5
88	V	COMBI SW INPUT 3
89	BR	PUSH SW
90	P	CAN-L
91	L	CAN-H
92	LG	KEY SLOT ILL ON IND
93	Y	PUDDLE LAMP CONT
94	V	ACC RELAY CONT
95	O	A/T DEVICE POWER SUPPLY
96	GR	S/L CONDITION 1
97	L	S/L CONDITION 2
98	P	SHIFT P
99	R	PASSENGER DOOR REQUEST SW
100	G	DRIVER DOOR REQUEST SW
101	SB	BLOWER FAN MOTOR RELAY CONT
102	O	KEYLESS ENTRY RECEIVER POWER SUPPLY
103	LG	S/L POWER SUPPLY
106	W	COMBI SW INPUT 1
107	LG	COMBI SW INPUT 4
108	R	COMBI SW INPUT 2
109	Y	HAZARD SW
110	G	S/L COMM
111	Y	S/L COMM

Connector No.	M123
Connector Name	BCM (BODY CONTROL MODULE)
Connector Type	TH40FG-NH



112	113	114	115	116	117	118	119	120	121	122	123	124	125	126	127	128	129	130	131	132	133	134	135	136	137	138	139	140	141	142	143	144	145	146	147	148	149	150	151
-----	-----	-----	-----	-----	-----	-----	-----	-----	-----	-----	-----	-----	-----	-----	-----	-----	-----	-----	-----	-----	-----	-----	-----	-----	-----	-----	-----	-----	-----	-----	-----	-----	-----	-----	-----	-----	-----	-----	-----

Terminal No.	Color of Wire	Signal Name [Specification]
113	P	OPTICAL SENSOR
116	SB	FUSE CHECK
118	P	STOP LAMP SW
119	SB	DR DOOR UNLOCK SENSOR
121	BR	KEY SLOT SW
122	V	ACC F/B
123	W	IGN F/B
124	LG	PASSENGER DOOR SW
132	V	POWER WINDOW SW COMM
133	W	PUSH-BUTTON IGNITION SW ILL POWER
134	GR	LOCK IND

137	O	RECEIVER/SENSOR GND
138	Y	RECEIVER/SENSOR POWER SUPPLY
139	L	TIRE PRESS RECEIVER SIGNAL
140	GR	SHIFT UP
141	G	SECURITY INDICATOR OUTPUT
142	O	COMBI SW OUTPUT 5
143	P	COMBI SW OUTPUT 1
144	G	COMBI SW OUTPUT 2
145	L	COMBI SW OUTPUT 3
146	SB	COMBI SW OUTPUT 4
149	W	TIRE PRESS WARNING CHECK SW
150	LG	DRIVER DOOR SW
151	G	REAR WINDOW DEFOGGER RELAY

Fail-safe

FAIL-SAFE CONTROL BY DTC

BCM performs fail-safe control when any DTC is detected.

JCMWM1404G

INFOID:000000003784738

BCM (BODY CONTROL MODULE)

< ECU DIAGNOSIS >

Display contents of CONSULT	Fail-safe	Cancellation	
B2013: ID DISCORD BCM-S/L	Inhibit engine cranking	Erase DTC	A
B2014: CHAIN OF S/L-BCM	Inhibit engine cranking	Erase DTC	B
B2190: NATS ANTENNA AMP	Inhibit engine cranking	Erase DTC	B
B2191: DIFFERENCE OF KEY	Inhibit engine cranking	Erase DTC	
B2192: ID DISCORD BCM-ECM	Inhibit engine cranking	Erase DTC	C
B2193: CHAIN OF BCM-ECM	Inhibit engine cranking	Erase DTC	
B2557: VEHICLE SPEED	Inhibit steering lock	When normal vehicle speed signals have been received from ABS actuator and electric unit (control unit) for 500 ms	D
B2560: STARTER CONT RELAY	Inhibit engine cranking	500 ms after the following CAN signal communication status has become consistent <ul style="list-style-type: none"> • Starter control relay signal • Starter relay status signal 	E
B2601: SHIFT POSITION	Inhibit steering lock	500 ms after the following signal reception status becomes consistent <ul style="list-style-type: none"> • Selector lever P position switch signal • P range signal (CAN) 	F
B2602: SHIFT POSITION	Inhibit steering lock	5 seconds after the following BCM recognition conditions are fulfilled <ul style="list-style-type: none"> • Ignition switch is in the ON position • Selector lever P position switch signal: Except P position (battery voltage) • Vehicle speed: 4 km/h (2.5 MPH) or more 	G
B2603: SHIFT POSI STATUS	Inhibit steering lock	500 ms after the following BCM recognition conditions are fulfilled <ul style="list-style-type: none"> • Ignition switch is in the ON position • Selector lever P position switch signal: Except P position (battery voltage) • Selector lever P/N position signal: Except P and N positions (0 V) 	H
B2604: PNP SW	Inhibit steering lock	500 ms after any of the following BCM recognition conditions is fulfilled <ul style="list-style-type: none"> • Status 1 <ul style="list-style-type: none"> - Ignition switch is in the ON position - Selector lever P/N position signal: P and N position (battery voltage) - P range signal or N range signal (CAN): ON • Status 2 <ul style="list-style-type: none"> - Ignition switch is in the ON position - Selector lever P/N position signal: Except P and N positions (0 V) - P range signal and N range signal (CAN): OFF 	I
B2605: PNP SW	Inhibit steering lock	500 ms after any of the following BCM recognition conditions is fulfilled <ul style="list-style-type: none"> • Ignition switch is in the ON position <ul style="list-style-type: none"> - Power position: IGN - Selector lever P/N position signal: Except P and N positions (0 V) - Interlock/PNP switch signal (CAN): OFF • Status 2 <ul style="list-style-type: none"> - Ignition switch is in the ON position - Selector lever P/N position signal: P or N position (battery voltage) - PNP switch signal (CAN): ON 	J
B2606: S/L RELAY	Inhibit engine cranking	500 ms after the following CAN signal communication status has become consistent <ul style="list-style-type: none"> • Steering lock relay signal (Request signal) • Steering lock relay signal (Condition signal) 	K
B2607: S/L RELAY	Inhibit engine cranking	500 ms after the following CAN signal communication status has become consistent <ul style="list-style-type: none"> • Steering lock relay signal (Request signal) • Steering lock relay signal (Condition signal) 	DEF
			M
			N
			O
			P

BCM (BODY CONTROL MODULE)

< ECU DIAGNOSIS >

Display contents of CONSULT	Fail-safe	Cancellation
B2608: STARTER RELAY	Inhibit engine cranking	500 ms after the following signal communication status becomes consistent <ul style="list-style-type: none"> Starter motor relay control signal Starter relay status signal (CAN)
B2609: S/L STATUS	<ul style="list-style-type: none"> Inhibit engine cranking Inhibit steering lock 	When the following steering lock conditions agree <ul style="list-style-type: none"> BCM steering lock control status Steering lock condition No. 1 signal status Steering lock condition No. 2 signal status
B260A: IGNITION RELAY	Inhibit engine cranking	500 ms after the following conditions are fulfilled <ul style="list-style-type: none"> IGN relay (IPDM E/R) control signal: OFF (Battery voltage) Ignition ON signal (CAN to IPDM E/R): OFF (Request signal) Ignition ON signal (CAN from IPDM E/R): OFF (Condition signal)
B260F: ENG STATE SIG LOST	Maintains the power supply position attained at the time of DTC detection	When any of the following conditions is fulfilled <ul style="list-style-type: none"> Power position changes to ACC Receives engine status signal (CAN)
B2612: S/L STATUS	<ul style="list-style-type: none"> Inhibit engine cranking Inhibit steering lock 	When any of the following conditions is fulfilled <ul style="list-style-type: none"> Steering lock unit status signal (CAN) is received normally The BCM steering lock control status matches the steering lock status recognized by the steering lock unit status signal (CAN from IPDM E/R)
B2617: STARTER RELAY CIRC	Inhibit engine cranking	1 second after the starter motor relay control inside BCM becomes normal
B2618: BCM	Inhibit engine cranking	1 second after the ignition relay (IPDM E/R) control inside BCM becomes normal
B2619: BCM	Inhibit engine cranking	1 second after the steering lock unit power supply output control inside BCM becomes normal
B261E: VEHICLE TYPE	Inhibit engine cranking	BCM initialization
B26E1: ENG STATE NO RECIV	Inhibit engine cranking	When any of the following conditions is fulfilled <ul style="list-style-type: none"> Power position changes to ACC Receives engine status signal (CAN)
B26E9: S/L STATUS	<ul style="list-style-type: none"> Inhibit engine cranking Inhibit steering lock 	When BCM transmits the LOCK request signal to steering lock unit, and receives LOCK response signal from steering lock unit, the following conditions is fulfilled <ul style="list-style-type: none"> Steering condition No. 1 signal: LOCK (0V) Steering condition No. 2 signal: LOCK (Battery voltage)

HIGH FLASHER OPERATION

BCM detects the turn signal lamp circuit status by the current value.

BCM increases the turn signal lamp blinking speed if the bulb or harness open is detected with the turn signal lamp operating.

NOTE:

The blinking speed is normal while activating the hazard warning lamp.

DTC Inspection Priority Chart

INFOID:000000003784739

If some DTCs are displayed at the same time, perform inspections one by one based on the following priority chart.

Priority	DTC
1	B2562: LOW VOLTAGE
2	<ul style="list-style-type: none"> U1000: CAN COMM CIRCUIT U1010: CONTROL UNIT (CAN)
3	<ul style="list-style-type: none"> B2190: NATS ANTENNA AMP B2191: DIFFERENCE OF KEY B2192: ID DISCORD BCM-ECM B2193: CHAIN OF BCM-ECM

BCM (BODY CONTROL MODULE)

< ECU DIAGNOSIS >

Priority	DTC	A		
4	<ul style="list-style-type: none"> • B2013: ID DISCORD BCM-S/L • B2014: CHAIN OF S/L-BCM • B2553: IGNITION RELAY • B2555: STOP LAMP • B2556: PUSH-BTN IGN SW • B2557: VEHICLE SPEED • B2560: STARTER CONT RELAY • B2601: SHIFT POSITION • B2602: SHIFT POSITION • B2603: SHIFT POSI STATUS • B2604: PNP SW • B2605: PNP SW • B2606: S/L RELAY • B2607: S/L RELAY • B2608: STARTER RELAY • B2609: S/L STATUS • B260A: IGNITION RELAY • B260B: STEERING LOCK UNIT • B260C: STEERING LOCK UNIT • B260D: STEERING LOCK UNIT • B260F: ENG STATE SIG LOST • B2612: S/L STATUS • B2614: ACC RELAY CIRC • B2615: BLOWER RELAY CIRC • B2616: IGN RELAY CIRC • B2617: STARTER RELAY CIRC • B2618: BCM • B2619: BCM • B261A: PUSH-BTN IGN SW • B261E: VEHICLE TYPE • B26E1: ENG STATE NO RECIV • B26E9: S/L STATUS • B26EA: KEY REGISTRATION • C1729: VHCL SPEED SIG ERR • U0415: VEHICLE SPEED SIG 	B		
	C			
	D			
	E			
	F			
	G			
	H			
	I			
	J			
	5	<ul style="list-style-type: none"> • C1704: LOW PRESSURE FL • C1705: LOW PRESSURE FR • C1706: LOW PRESSURE RR • C1707: LOW PRESSURE RL • C1708: [NO DATA] FL • C1709: [NO DATA] FR • C1710: [NO DATA] RR • C1711: [NO DATA] RL • C1712: [CHECKSUM ERR] FL • C1713: [CHECKSUM ERR] FR • C1714: [CHECKSUM ERR] RR • C1715: [CHECKSUM ERR] RL • C1716: [PRESSDATA ERR] FL • C1717: [PRESSDATA ERR] FR • C1718: [PRESSDATA ERR] RR • C1719: [PRESSDATA ERR] RL • C1720: [CODE ERR] FL • C1721: [CODE ERR] FR • C1722: [CODE ERR] RR • C1723: [CODE ERR] RL • C1724: [BATT VOLT LOW] FL • C1725: [BATT VOLT LOW] FR • C1726: [BATT VOLT LOW] RR • C1727: [BATT VOLT LOW] RL • C1734: CONTROL UNIT 	K	
		DEF		
		M		
		N		
		O		
		P		
		6	<ul style="list-style-type: none"> • B2621: INSIDE ANTENNA • B2622: INSIDE ANTENNA • B2623: INSIDE ANTENNA 	

BCM (BODY CONTROL MODULE)

< ECU DIAGNOSIS >

DTC Index

INFOID:000000003784740

NOTE:

The details of time display are as follows.

- CRNT: A malfunction is detected now.
- PAST: A malfunction was detected in the past.

IGN counter is displayed on Freeze Frame Data. For details of Freeze Frame Data and IGN Counter, refer to [BCS-16, "COMMON ITEM : CONSULT-III Function \(BCM - COMMON ITEM\)"](#).

CONSULT display	Fail-safe	Freeze Frame Data	Intelligent Key warning lamp ON	Tire pressure monitor warning lamp ON	Reference page
No DTC is detected. further testing may be required.	—	—	—	—	—
U1000: CAN COMM CIRCUIT	—	—	—	—	BCS-37
U1010: CONTROL UNIT (CAN)	—	—	—	—	BCS-38
U0415: VEHICLE SPEED SIG	—	—	—	—	BCS-39
B2013: ID DISCORD BCM-S/L	×	×	—	—	SEC-48
B2014: CHAIN OF S/L-BCM	×	×	—	—	SEC-49
B2190: NATS ANTENNA AMP	×	—	—	—	SEC-42
B2191: DIFFERENCE OF KEY	×	—	—	—	SEC-45
B2192: ID DISCORD BCM-ECM	×	—	—	—	SEC-46
B2193: CHAIN OF BCM-ECM	×	—	—	—	SEC-47
B2553: IGNITION RELAY	—	×	—	—	PCS-49
B2555: STOP LAMP	—	×	—	—	SEC-52
B2556: PUSH-BTN IGN SW	—	×	×	—	SEC-54
B2557: VEHICLE SPEED	×	×	×	—	SEC-56
B2560: STARTER CONT RELAY	×	×	×	—	SEC-57
B2562: LOW VOLTAGE	—	×	—	—	BCS-40
B2601: SHIFT POSITION	×	×	×	—	SEC-58
B2602: SHIFT POSITION	×	×	×	—	SEC-61
B2603: SHIFT POSI STATUS	×	×	×	—	SEC-63
B2604: PNP SW	×	×	×	—	SEC-66
B2605: PNP SW	×	×	×	—	SEC-68
B2606: S/L RELAY	×	×	×	—	SEC-70
B2607: S/L RELAY	×	×	×	—	SEC-71
B2608: STARTER RELAY	×	×	×	—	SEC-73
B2609: S/L STATUS	×	×	×	—	SEC-75
B260A: IGNITION RELAY	×	×	×	—	PCS-51
B260B: STEERING LOCK UNIT	—	×	×	—	SEC-79
B260C: STEERING LOCK UNIT	—	×	×	—	SEC-80
B260D: STEERING LOCK UNIT	—	×	×	—	SEC-81
B260F: ENG STATE SIG LOST	×	×	×	—	SEC-82
B2612: S/L STATUS	×	×	×	—	SEC-86
B2614: ACC RELAY CIRC	—	×	×	—	PCS-53
B2615: BLOWER RELAY CIRC	—	×	×	—	PCS-57
B2616: IGN RELAY CIRC	—	×	×	—	PCS-59
B2617: STARTER RELAY CIRC	×	×	×	—	SEC-90

BCM (BODY CONTROL MODULE)

< ECU DIAGNOSIS >

CONSULT display	Fail-safe	Freeze Frame Data	Intelligent Key warning lamp ON	Tire pressure monitor warning lamp ON	Reference page	
B2618: BCM	×	×	×	—	PCS-61	A
B2619: BCM	×	×	×	—	SEC-92	B
B261A: PUSH-BTN IGN SW	—	×	×	—	SEC-93	
B261E: VEHICLE TYPE	×	×	× (Turn ON for 15 seconds)	—	SEC-96	C
B2621: INSIDE ANTENNA	—	×	—	—	DLK-56	
B2622: INSIDE ANTENNA	—	×	—	—	DLK-58	D
B2623: INSIDE ANTENNA	—	×	—	—	DLK-60	
B26E1: ENG STATE NO RES	×	×	×	—	SEC-83	
B26E9: S/L STATUS	×	×	× (Turn ON for 15 seconds)	—	SEC-84	E
B26EA: KEY REGISTRATION	—	×	× (Turn ON for 15 seconds)	—	SEC-85	F
C1704: LOW PRESSURE FL	—	—	—	×	WT-16	G
C1705: LOW PRESSURE FR	—	—	—	×		
C1706: LOW PRESSURE RR	—	—	—	×		
C1707: LOW PRESSURE RL	—	—	—	×		
C1708: [NO DATA] FL	—	—	—	×	WT-18	H
C1709: [NO DATA] FR	—	—	—	×		
C1710: [NO DATA] RR	—	—	—	×		
C1711: [NO DATA] RL	—	—	—	×		
C1712: [CHECKSUM ERR] FL	—	—	—	×	WT-21	I
C1713: [CHECKSUM ERR] FR	—	—	—	×		
C1714: [CHECKSUM ERR] RR	—	—	—	×		
C1715: [CHECKSUM ERR] RL	—	—	—	×		
C1716: [PRESSDATA ERR] FL	—	—	—	×	WT-24	J
C1717: [PRESSDATA ERR] FR	—	—	—	×		
C1718: [PRESSDATA ERR] RR	—	—	—	×		
C1719: [PRESSDATA ERR] RL	—	—	—	×		
C1720: [CODE ERR] FL	—	—	—	×	WT-26	K
C1721: [CODE ERR] FR	—	—	—	×		
C1722: [CODE ERR] RR	—	—	—	×		
C1723: [CODE ERR] RL	—	—	—	×		
C1724: [BATT VOLT LOW] FL	—	—	—	×	WT-29	L
C1725: [BATT VOLT LOW] FR	—	—	—	×		
C1726: [BATT VOLT LOW] RR	—	—	—	×		
C1727: [BATT VOLT LOW] RL	—	—	—	×		
C1729: VHCL SPEED SIG ERR	—	—	—	×	WT-32	
C1734: CONTROL UNIT	—	—	—	×	WT-33	P

DEF

REAR WINDOW DEFOGGER DOES NOT OPERATE

< SYMPTOM DIAGNOSIS >

SYMPTOM DIAGNOSIS

REAR WINDOW DEFOGGER DOES NOT OPERATE

Diagnosis Procedure

INFOID:000000003136673

1. CHECK POWER SUPPLY AND GROUND CIRCUIT

Check power supply and ground circuit.
Refer to [DEF-9, "Diagnosis Procedure"](#).

Is the inspection result normal?

- YES >> GO TO 2.
- NO >> Repair or replace the malfunctioning parts.

2. CHECK REAR WINDOW DEFOGGER SWITCH

Check rear window defogger switch.
Refer to [DEF-10, "Component Function Check"](#).

Is the inspection result normal?

- YES >> GO TO 3.
- NO >> Repair or replace the malfunctioning parts.

3. CHECK REAR WINDOW DEFOGGER RELAY

Check rear window defogger relay.
Refer to [DEF-11, "Component Function Check"](#).

Is the inspection result normal?

- YES >> GO TO 4.
- NO >> Repair or replace the malfunctioning parts.

4. CHECK REAR WINDOW DEFOGGER

Check rear window defogger.
Refer to [DEF-13, "Component Function Check"](#).

Is the inspection result normal?

- YES >> GO TO 5.
- NO >> Repair or replace the malfunctioning parts.

5. CONFIRM THE OPERATION

Confirm the operation again.

Is the inspection result normal?

- YES >> Check intermittent incident. Refer to [GI-38, "Intermittent Incident"](#).
- NO >> GO TO 1.

REAR WINDOW DEFOGGER AND DOOR MIRROR DEFOGGER DO NOT OPERATE.

< SYMPTOM DIAGNOSIS >

REAR WINDOW DEFOGGER AND DOOR MIRROR DEFOGGER DO NOT OPERATE.

Diagnosis Procedure

INFOID:000000003136674

1.CHECK POWER SUPPLY AND GROUND CIRCUIT

Check power supply and ground circuit.
Refer to [DEF-9, "Diagnosis Procedure"](#).

Is the inspection result normal?

YES >> GO TO 2.

NO >> Repair or replace the malfunctioning parts.

2.CHECK REAR WINDOW DEFOGGER SWITCH

Check rear window defogger switch.
Refer to [DEF-10, "Component Function Check"](#).

Is the inspection result normal?

YES >> GO TO 3.

NO >> Repair or replace the malfunctioning parts.

3.CHECK REAR WINDOW DEFOGGER RELAY

Check rear window defogger relay.
Refer to [DEF-11, "Component Function Check"](#).

Is the inspection result normal?

YES >> GO TO 4.

NO >> Repair or replace the malfunctioning parts.

4.CONFIRM THE OPERATION

Confirm the operation again.

Is the inspection result normal?

YES >> Check intermittent incident. Refer to [GI-38, "Intermittent Incident"](#).

NO >> GO TO 1.

A
B
C
D
E
F
G
H
I
J
K
M
N
O
P

DEF

REAR WINDOW DEFOGGER DOES NOT OPERATE BUT BOTH DOOR MIRROR DEFOGGER OPERATE.

< SYMPTOM DIAGNOSIS >

REAR WINDOW DEFOGGER DOES NOT OPERATE BUT BOTH DOOR MIRROR DEFOGGER OPERATE.

Diagnosis Procedure

INFOID:000000003136675

1. CHECK REAR WINDOW DEFOGGER

Check rear window defogger.

Refer to [DEF-13, "Component Function Check"](#).

Is the inspection result normal?

YES >> GO TO 2.

NO >> Repair or replace the malfunctioning parts.

2. CONFIRM THE OPERATION

Confirm the operation again

Is the inspection result normal?

YES >> Check intermittent incident. Refer to [GI-38, "Intermittent Incident"](#).

NO >> GO TO 1.

DOOR MIRROR DEFOGGER DOES NOT OPERATE

< SYMPTOM DIAGNOSIS >

DOOR MIRROR DEFOGGER DOES NOT OPERATE BOTH SIDES

BOTH SIDES : Diagnosis Procedure

INFOID:000000003136676

1.CHECK DOOR MIRROR DEFOGGER

Check door mirror defogger.

Refer to [DEF-16, "Component Function Check"](#).

Is the inspection result normal?

YES >> GO TO 2.

NO >> Repair or replace the malfunctioning parts.

2.CONFIRM THE OPERATION

Confirm the operation again.

Is the inspection result normal?

YES >> Check intermittent incident. Refer to [GI-38, "Intermittent Incident"](#).

NO >> GO TO 1.

DRIVER SIDE

DRIVER SIDE : Diagnosis Procedure

INFOID:000000003136677

1.CHECK DRIVER SIDE DOOR MIRROR DEFOGGER

Check driver side door mirror defogger.

Refer to [DEF-17, "Component Function Check"](#).

Is the inspection result normal?

YES >> GO TO 2.

NO >> Repair or replace the malfunctioning parts.

2.CONFIRM THE OPERATION

Confirm the operation again.

Is the inspection result normal?

YES >> Check intermittent incident. Refer to [GI-38, "Intermittent Incident"](#).

NO >> GO TO 1.

PASSENGER SIDE

PASSENGER SIDE : Diagnosis Procedure

INFOID:000000003136678

1.CHECK PASSENGER SIDE DOOR MIRROR DEFOGGER.

Check passenger side door mirror defogger.

Refer to [DEF-19, "Component Function Check"](#).

Is the inspection result normal?

YES >> GO TO 2.

NO >> Repair or replace the malfunctioning parts.

2.CONFIRM THE OPERATION

Confirm the operation again.

Is the inspection result normal?

YES >> Check intermittent incident. Refer to [GI-38, "Intermittent Incident"](#).

NO >> GO TO 1.

A
B
C
D
E
F
G
H
I
J
K
M
N
O
P

DEF

ON IS NOT DISPLAYED WHEN PRESSING REAR WINDOW DEFOGGER SWITCH BUT IT IS OPERATED

< SYMPTOM DIAGNOSIS >

ON IS NOT DISPLAYED WHEN PRESSING REAR WINDOW DEFOGGER SWITCH BUT IT IS OPERATED

Diagnosis Procedure

INFOID:000000003136679

1. CHECK AV CONTROL UNIT FUNCTION

Check that the AV control unit is operating normally.

- Base audio without navigation system. Refer to [AV-13, "Work Flow"](#).
- Bose audio without navigation system. Refer to [AV-172, "Work Flow"](#).
- Bose audio with navigation system. Refer to [AV-435, "Work Flow"](#).

Is the inspection result normal?

YES >> GO TO 2.

NO >> Repair or replace the malfunctioning parts.

2. CONFIRM THE OPERATION

Confirm the operation again.

Is the inspection result normal?

YES >> Check intermittent incident. Refer to [GI-38, "Intermittent Incident"](#).

NO >> GO TO 1.

REAR WINDOW DEFOGGER INDICATOR DOES NOT ILLUMINATE

< SYMPTOM DIAGNOSIS >

REAR WINDOW DEFOGGER INDICATOR DOES NOT ILLUMINATE

Diagnosis Procedure

INFOID:000000003136680

1. CHECK MULTIFUNCTION SWITCH (REAR WINDOW DEFOGGER SWITCH)

Check rear window defogger operate.

- YES >> Replace multifunction switch (rear window defogger switch). Refer to [AV-913. "Removal and Installation"](#)
- NO >> Check rear window defogger system. Refer to [DEF-3. "Work Flow"](#)

A
B
C
D
E
F
G
H
I
J
K
DEF
M
N
O
P

DEF

PRECAUTIONS

< PRECAUTION >

PRECAUTION

PRECAUTIONS

Precaution for Supplemental Restraint System (SRS) "AIR BAG" and "SEAT BELT PRE-TENSIONER"

INFOID:000000003136681

The Supplemental Restraint System such as "AIR BAG" and "SEAT BELT PRE-TENSIONER", used along with a front seat belt, helps to reduce the risk or severity of injury to the driver and front passenger for certain types of collision. This system includes seat belt switch inputs and dual stage front air bag modules. The SRS system uses the seat belt switches to determine the front air bag deployment, and may only deploy one front air bag, depending on the severity of a collision and whether the front occupants are belted or unbelted. Information necessary to service the system safely is included in the "SRS AIRBAG" and "SEAT BELT" of this Service Manual.

WARNING:

- **To avoid rendering the SRS inoperative, which could increase the risk of personal injury or death in the event of a collision which would result in air bag inflation, all maintenance must be performed by an authorized NISSAN/INFINITI dealer.**
- **Improper maintenance, including incorrect removal and installation of the SRS, can lead to personal injury caused by unintentional activation of the system. For removal of Spiral Cable and Air Bag Module, see the "SRS AIRBAG".**
- **Do not use electrical test equipment on any circuit related to the SRS unless instructed to in this Service Manual. SRS wiring harnesses can be identified by yellow and/or orange harnesses or harness connectors.**

FILAMENT

< ON-VEHICLE REPAIR >

ON-VEHICLE REPAIR

FILAMENT

Inspection and Repair

INFOID:000000003136682

INSPECTION

1. When measuring voltage, wrap tin foil around the top of the negative probe. Then press the foil against the wire with your finger.

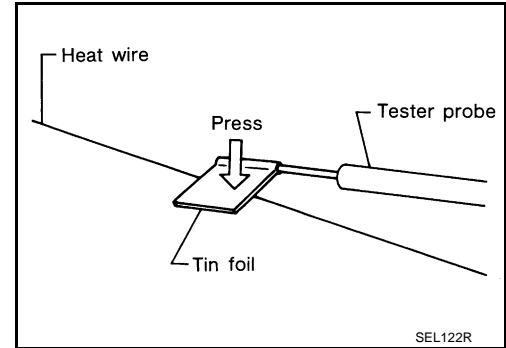

2. Attach probe circuit tester (in Volt range) to middle portion of each filament.

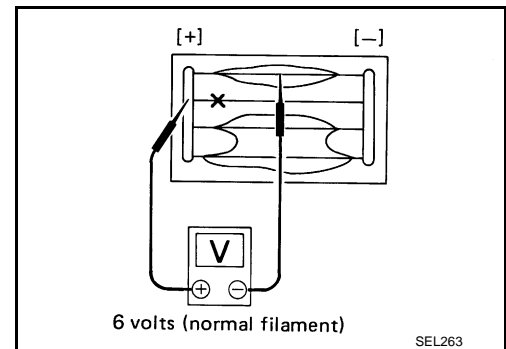

3. If a filament is burned out, circuit tester registers 0 or battery voltage.
4. To locate burned out point, move probe to left and right along filament. Test needle will swing abruptly when probe passes the point.

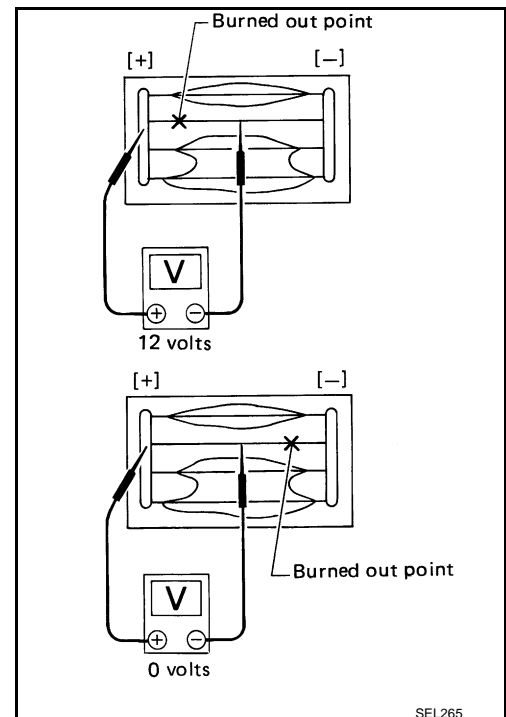

REPAIR

REPAIR EQUIPMENT

- Conductive silver composition (Dupont No. 4817 or equivalent)

A
B
C
D
E
F
G
H
I
J
K
DEF
M
N
O
P

FILAMENT

< ON-VEHICLE REPAIR >

- Ruler 30 cm (11.8 in) long
- Drawing pen
- Heat gun
- Alcohol
- Cloth

REPAIRING PROCEDURE

1. Wipe broken heat wire and its surrounding area clean with a cloth dampened in alcohol.
2. Apply a small amount of conductive silver composition to tip of drawing pen. Shake silver composition container before use.
3. Place ruler on glass along broken line. Deposit conductive silver composition on break with drawing pen. Slightly overlap existing heat wire on both sides [preferably 5 mm (0.20 in)] of the break.

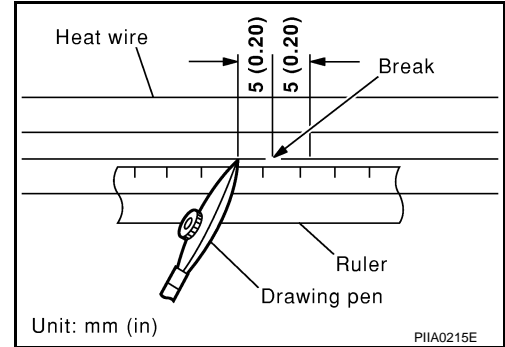

4. After repair has been completed, check repaired wire for continuity. This check should be conducted 10 minutes after silver composition is deposited. Do not touch repaired area while test is being conducted.

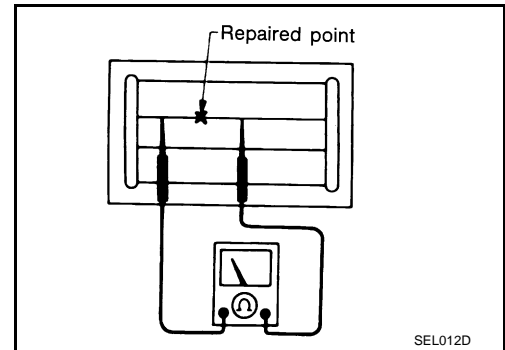

5. Apply a constant stream of hot air directly to the repaired area for approximately 20 minutes with a heat gun. A minimum distance of 3 cm (1.2 in) should be kept between repaired area and hot air outlet. If a heat gun is not available, let the repaired area dry for 24 hours.

