

SECTION **STC**

STEERING CONTROL SYSTEM

A
B
C
D
E
F
G
H
I
J
K
L
M
N
O
P

CONTENTS

BASIC INSPECTION	ECU DIAGNOSIS	2	15	
DIAGNOSIS AND REPAIR WORKFLOW	POWER STEERING CONTROL UNIT	2	15	
Work Flow	Reference Value	2	15	STC
FUNCTION DIAGNOSIS	Wiring Diagram — ELECTRONICALLY CON- TROLLED POWER STEERING SYSTEM —	3	16	
EPS SYSTEM	Fail Safe	3	19	
System Diagram	SYMPTOM DIAGNOSIS	3	21	
System Description	UNBALANCE STEERING WHEEL TURNING FORCE (TORQUE VARIATION)	3	21	
Component Parts Location	Description	4	21	
Component Description	Diagnosis Procedure	5	21	
COMPONENT DIAGNOSIS	PRECAUTION	6	22	
POWER SUPPLY AND GROUND CIRCUIT	PRECAUTIONS	6	22	
Description	Precautions for Supplemental Restraint System (SRS) "AIR BAG" and "SEAT BELT PRE-TEN- SIONER"	6	22	
Diagnosis Procedure	Precautions Necessary for Steering Wheel Rota- tion after Battery Disconnect	6	22	
POWER STEERING SOLENOID VALVE	REMOVAL AND INSTALLATION	8	23	
Description	EPS CONTROL UNIT	8	23	
Diagnosis Procedure	Removal and Installation	8	23	
ENGINE SPEED SIGNAL CIRCUIT		10		
Description		10		
Diagnosis Procedure		10		
VEHICLE SPEED SIGNAL CIRCUIT		13		
Description		13		
Diagnosis Procedure		13		

DIAGNOSIS AND REPAIR WORKFLOW

< BASIC INSPECTION >

BASIC INSPECTION

DIAGNOSIS AND REPAIR WORKFLOW

Work Flow

INFOID:000000004205823

DETAILED FLOW

1. COLLECT THE INFORMATION FROM THE CUSTOMER

It is also important to clarify customer complaints before inspection. First of all, reproduce symptoms, and understand them fully. Ask customer about his/her complaints carefully. In some cases, it will be necessary to check symptoms by driving vehicle with customer.

>> GO TO 2.

2. BASIC INSPECTION

1. Check the power steering fluid leakage and the power steering fluid level. Refer to [ST-8. "Inspection"](#).
2. Check the drive belt tension. Refer to [EM-16. "Checking Drive Belts"](#) (QR25DE), [EM-121. "Checking Drive Belts"](#) (VQ35DE).
3. Check the power steering gear for damages, cracks and oil leakage. Refer to [ST-8. "Inspection"](#).
4. Check the relief oil pressure. Refer to [ST-12. "Inspection"](#).

>> GO TO 3.

3. TROUBLE DIAGNOSIS FOR SYMPTOM

Perform the diagnosis by symptom. Refer to [STC-21. "Description"](#).

>> GO TO 4.

4. FINAL CHECK

Check the input/output standard values for the power steering control unit.

Are the power steering control unit input/output values within standard ranges respectively?

YES >> Inspection End

NO >> GO TO 2.

EPS SYSTEM

< FUNCTION DIAGNOSIS >

FUNCTION DIAGNOSIS

EPS SYSTEM

System Diagram

INFOID:000000004205824

CONTROL DIAGRAM

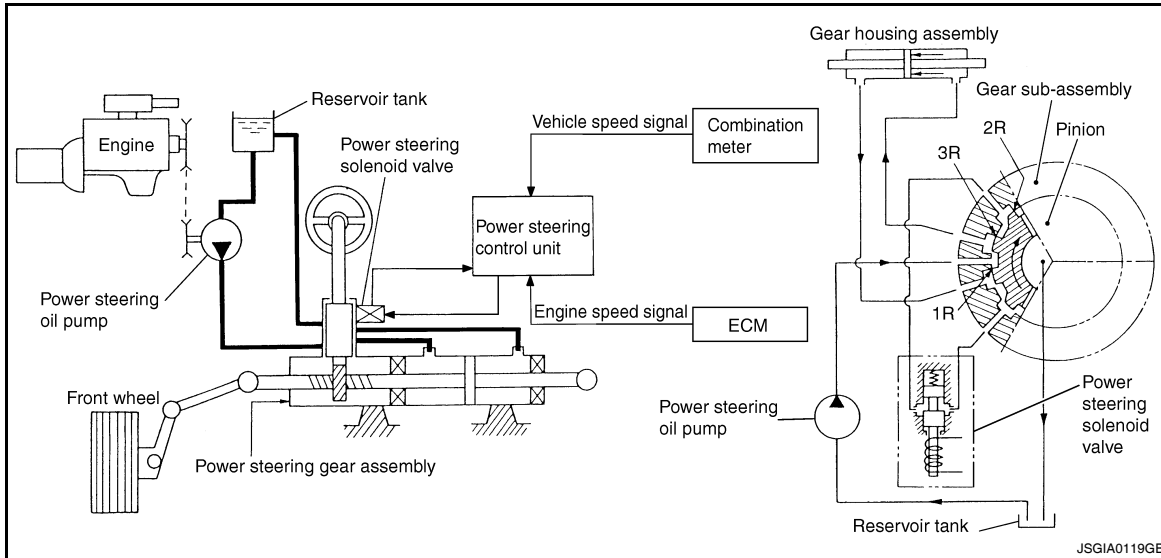

System Description

INFOID:000000004205825

- The EPS system controls the power steering solenoid valve through the power steering control unit.
- The valve driving voltage to control the power steering solenoid valve varies according to the vehicle speed.

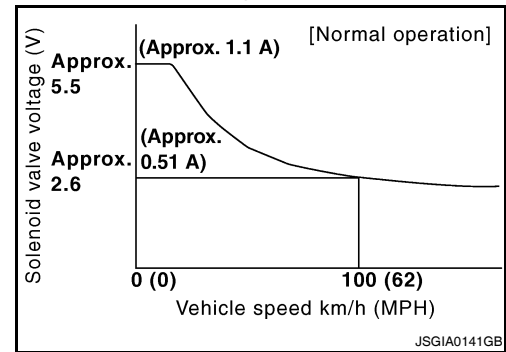

OPERATION PRINCIPLE

During Parking (When Turning The Steering Wheel To The Right)

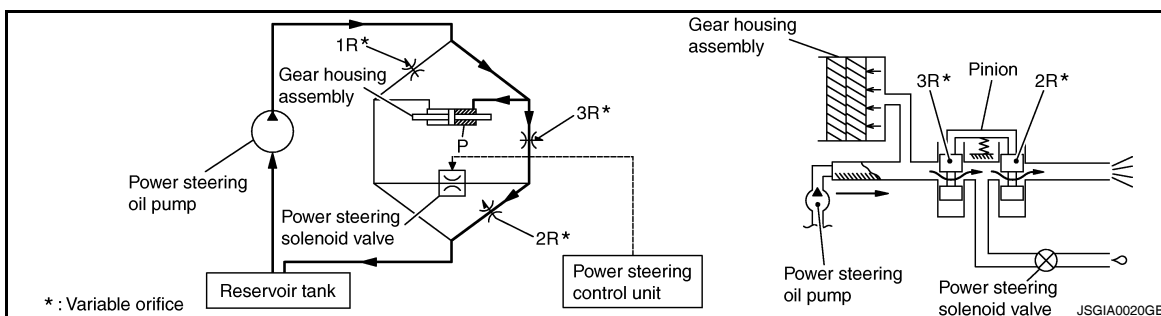

1. Power steering solenoid valve is closed while a vehicle is stopped.
2. Pinion "1R", "2R" and "3R" are closed depending on steering torque of steering wheel.
3. Oil pressure "P" in the gear housing assembly is the sum of oil pressures occurred in "2R" and "3R". This results in a light steering force because of high pressure.

EPS SYSTEM

< FUNCTION DIAGNOSIS >

During High-speed Operation

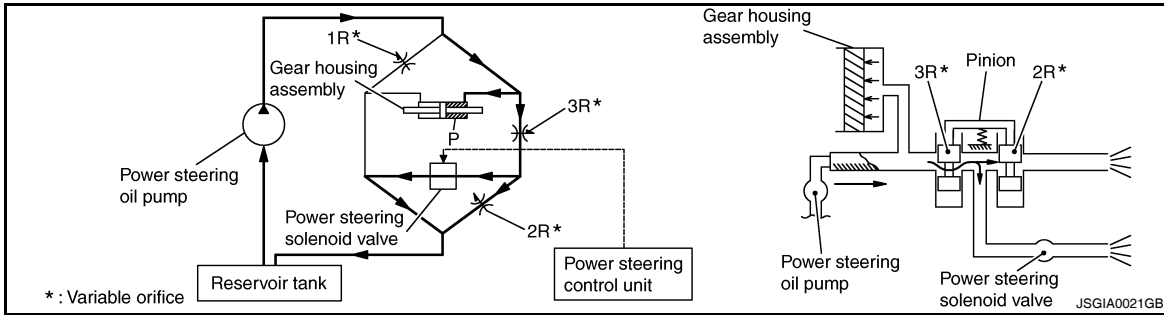

1. Power steering solenoid valve is opened during high-speed operation.
2. Pinion "1R", "2R" and "3R" are closed depending on steering torque of steering wheel.
3. Oil pressure "2R" does not occur because the power steering solenoid valve is on full throttle.
4. Oil pressure "P" in the gear housing assembly includes only oil pressure occurred in "3R" and results in a heavy steering force.

Component Parts Location

INFOID:000000004205826

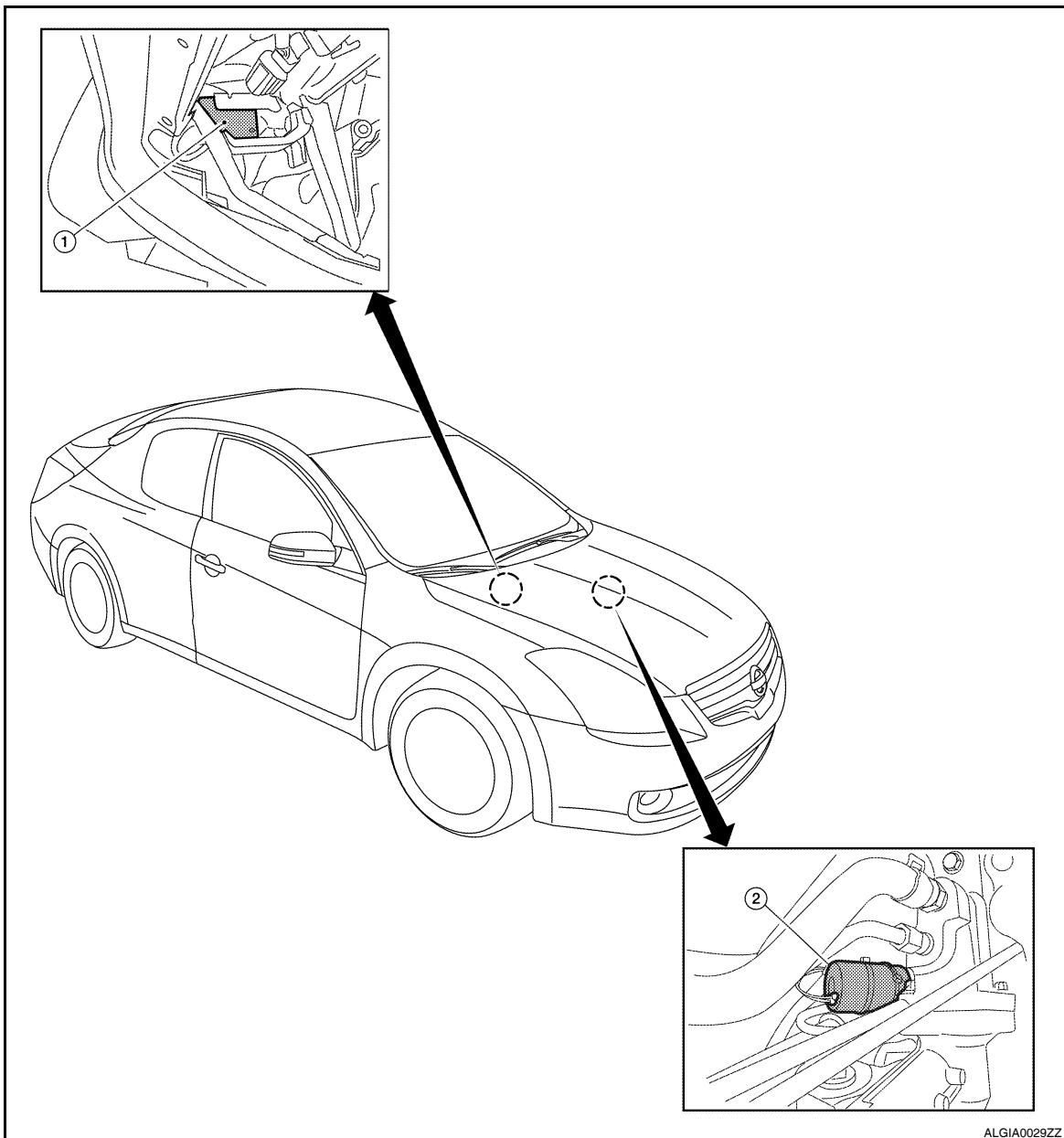

EPS SYSTEM

< FUNCTION DIAGNOSIS >

1. Power steering control unit M59
(view with glove box removed)
2. Power steering solenoid valve E14

Component Description

INFOID:000000004205827

Component parts	Function
Power steering control unit	<ul style="list-style-type: none">• Signals from various sensors control the driving voltage to the power steering solenoid valve.• The power steering control unit controls the driving voltage to the power steering solenoid valve for maintaining the power steering assist force when the fail-safe function is activated. (The engine speed signals control EPS system if any vehicle speed signal error is detected.)
Combination meter	Refer to STC-13, "Description" .
ECM	Refer to STC-10, "Description" .
Power steering solenoid valve	Refer to STC-8, "Description" .

A

B

C

D

E

F

STC

H

I

J

K

L

M

N

O

P

POWER SUPPLY AND GROUND CIRCUIT

< COMPONENT DIAGNOSIS >

COMPONENT DIAGNOSIS

POWER SUPPLY AND GROUND CIRCUIT

Description

INFOID:000000004205828

- EPS system functions by ignition power supply.

Diagnosis Procedure

INFOID:000000004205829

1. CHECK POWER SUPPLY

1. Turn the ignition switch OFF.
2. Disconnect power steering control unit harness connector.
3. Check voltage between power steering control unit harness connector M59 terminal 3 and ground.

Power steering control unit		Voltage (Approx.)
Connector	Terminal	
M59	3 - Ground	0 V

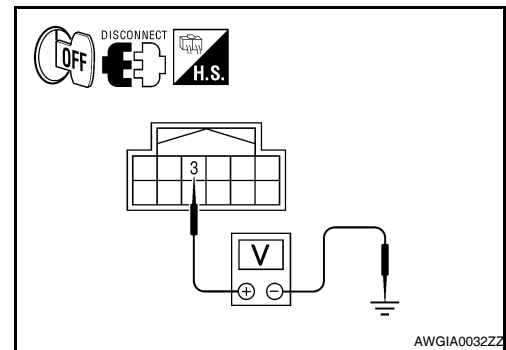

4. Turn the ignition switch ON.
CAUTION:
Never start the engine.
5. Check voltage between power steering control unit harness connector M59 terminal 3 and ground.

Power steering control unit		Voltage (Approx.)
Connector	Terminal	
M59	3 - Ground	Battery voltage

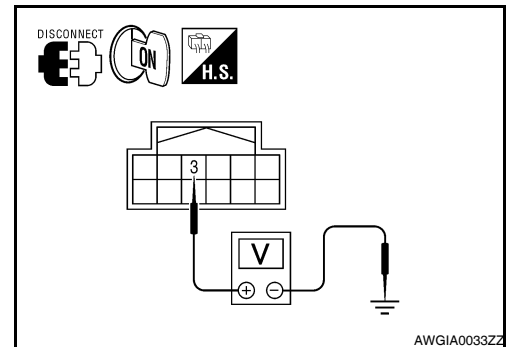

Is the inspection result normal?

YES >> GO TO 2.

NO >> Check the following. If any items are damaged, repair or replace damaged parts.

- 10A fuses (#3) open
- Harness for short or open between ignition switch and power steering control unit harness connector No. 3 terminal.
- Ignition switch.

2. CHECK GROUND CIRCUIT

1. Turn the ignition switch OFF.
2. Check continuity between power steering control unit harness connector M59 terminal 6 and ground.

Power steering control unit		Continuity
Connector	Terminal	
M59	6 - Ground	Existed

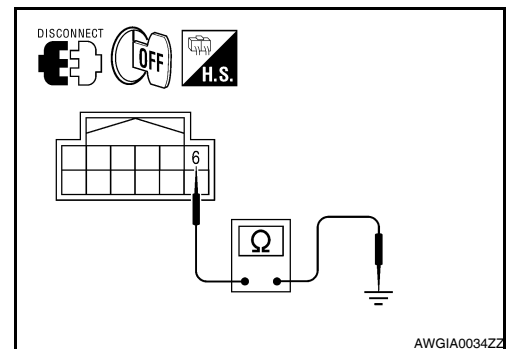

Is the inspection result normal?

YES >> GO TO 3.

NO >> Repair open circuit or short to power in harness or connectors.

3. CHECK TERMINALS AND HARNESS CONNECTORS

Check power steering control unit pin terminals for damage or loose connection with harness connector.

POWER SUPPLY AND GROUND CIRCUIT

< COMPONENT DIAGNOSIS >

Is the inspection result normal?

YES >> Inspection End

NO >> Repair or replace damaged parts.

A

B

C

D

E

F

STC

H

I

J

K

L

M

N

O

P

POWER STEERING SOLENOID VALVE

< COMPONENT DIAGNOSIS >

POWER STEERING SOLENOID VALVE

Description

INFOID:000000004205830

- Power steering solenoid valve controls the power steering oil pressure in the gear housing assembly.

Diagnosis Procedure

INFOID:000000004205831

1. CHECK POWER STEERING SOLENOID VALVE SIGNAL

1. Start engine.
2. Check voltage between power steering control unit harness connector M59 terminal 1 and ground.

Power steering control unit			Value (Approx.)
Connector	Terminal	Condition	
M59	1 - Ground	Vehicle speed: 0 km/h (0 MPH) (Engine is running)	4.4 - 6.6 V
		Vehicle speed: 100 km/h (62 MPH)	2.5 - 3.7 V

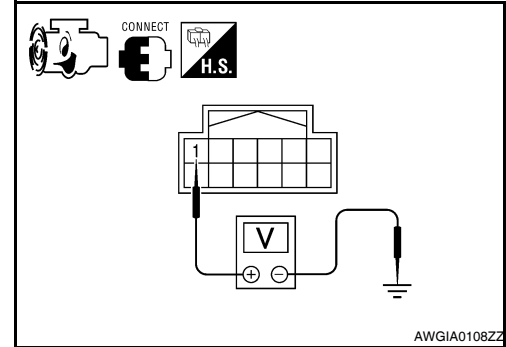

Is the inspection result normal?

- YES >> GO TO 2.
NO >> GO TO 4.

2. CHECK HARNESS BETWEEN POWER STEERING SOLENOID VALVE AND POWER STEERING CONTROL UNIT

1. Turn the ignition switch OFF.
2. Disconnect power steering solenoid valve harness connector.
3. Disconnect power steering control unit harness connector.
4. Check the continuity between power steering solenoid valve harness connector E14 (A) terminal 1 and 2 and the power steering control unit harness connector M59 (B) terminal 1 and 5.

Power steering solenoid valve		Power steering control unit		Continuity
Connector	Terminal	Connector	Terminal	
E14 (A)	1	M59 (B)	1	Existed
	2		5	Existed

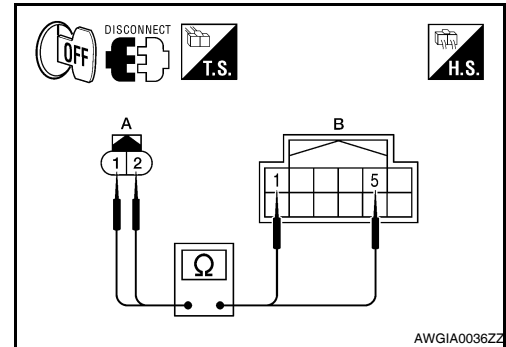

Also check harness for short to ground and short to power.

Is the inspection result normal?

- YES >> GO TO 3.
NO >> Repair or replace damaged parts.

3. CHECK POWER STEERING SOLENOID VALVE

1. Check resistance between power steering solenoid valve terminals.

Power steering solenoid valve		Resistance (Approx.)
Terminal		
1 - 2		5 Ω

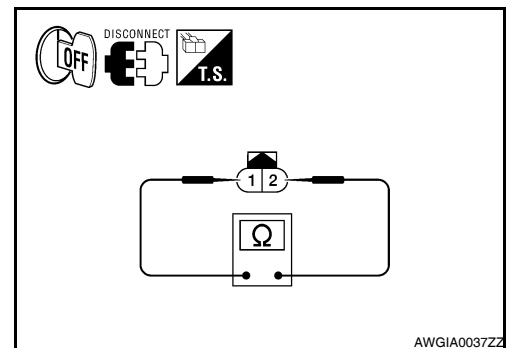

POWER STEERING SOLENOID VALVE

< COMPONENT DIAGNOSIS >

2. Check power steering solenoid valve by listening for its operation sound while applying battery voltage to power steering solenoid valve terminal 1 (positive) and battery ground to terminal 2 (negative).

Is the inspection result normal?

YES >> GO TO 4.

NO >> Replace power steering solenoid valve. Refer to [ST-28](#).
["Exploded View"](#).

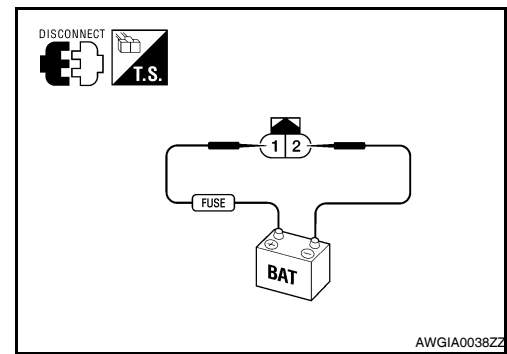

4. CHECK TERMINALS AND HARNESS CONNECTORS

- Check power steering control unit pin terminals for damage or loose connection with harness connector.
- Check power steering solenoid valve pin terminals for damage or loose connection with harness connector.

Is the inspection result normal?

YES >> Inspection End

NO >> Repair or replace damaged parts.

A
B
C
D
E
F
H
I
J
K
L
M
N
O
P

STC

ENGINE SPEED SIGNAL CIRCUIT

< COMPONENT DIAGNOSIS >

ENGINE SPEED SIGNAL CIRCUIT

Description

INFOID:000000004205832

- ECM sends engine speed signal to power steering control unit.

Diagnosis Procedure

INFOID:000000004205833

1. PERFORM ECM SELF-DIAGNOSIS

With CONSULT-III

Perform ECM self-diagnosis.

Is any error system detected?

YES >> Check the error system.

NO >> GO TO 2.

2. CHECK HARNESS BETWEEN ECM AND POWER STEERING CONTROL UNIT

1. Turn the ignition switch OFF.
2. Disconnect ECM harness connector E10.
3. Disconnect power steering control unit harness connector.
4. Check continuity between ECM harness connector E10 (A) terminal 94 and power steering control unit harness connector M59 (B) terminal 10.

ECM		Power steering control unit		Continuity
Connector	Terminal	Connector	Terminal	
E10 (A)	94	M59 (B)	10	Existed

Also check harness for short to ground and short to power.

Is the inspection result normal?

YES >> GO TO 3.

NO >> Repair or replace damaged parts.

3. CHECK ENGINE SPEED SIGNAL (ECM SIDE)

1. Turn the ignition switch OFF.
2. Connect ECM harness connector.
3. Check signal between ECM harness connector E10 terminal 94 and ground with oscilloscope.

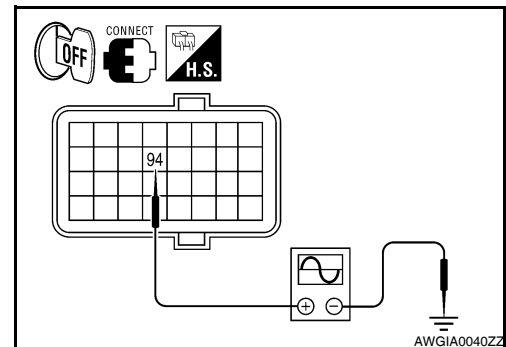
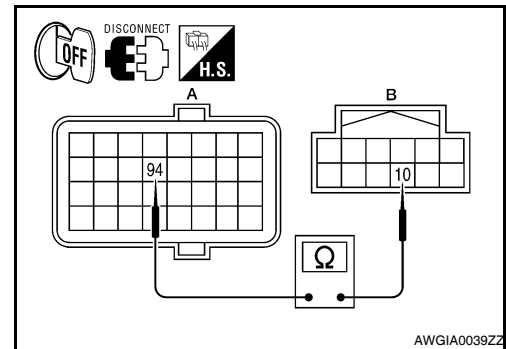

ENGINE SPEED SIGNAL CIRCUIT

< COMPONENT DIAGNOSIS >

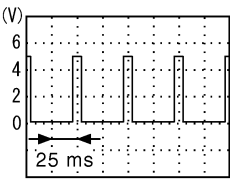
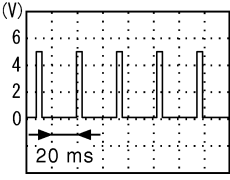
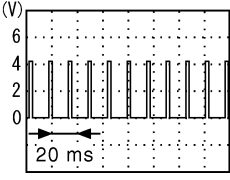
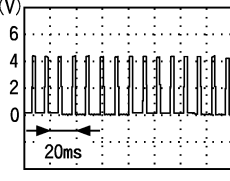
ECM			Value (Approx.)
Connector	Terminal	Condition	
E10	94 - Ground	Engine speed: At idle (Warm-up condition)	QR25DE:  VQ35DE: 
		Engine speed: Approx. 2,000 rpm (Warm-up condition)	QR25DE:  VQ35DE: 

Also check harness for short to ground and short to power.

Is the inspection result normal?

YES >> GO TO 4.

NO >> Replace ECM. Refer to [EC-34. "Component Parts Location"](#) (QR25DE for California), [EC-570. "Component Parts Location"](#) (QR25DE except for California), [EC-1058. "Component Parts Location"](#) (VQ35DE).

4. CHECK ENGINE SPEED SIGNAL (POWER STEERING CONTROL UNIT SIDE)

1. Turn the ignition switch OFF.
2. Connect power steering control unit harness connector.
3. Check signal between power steering control unit harness connector M59 terminal 10 and ground with oscilloscope.

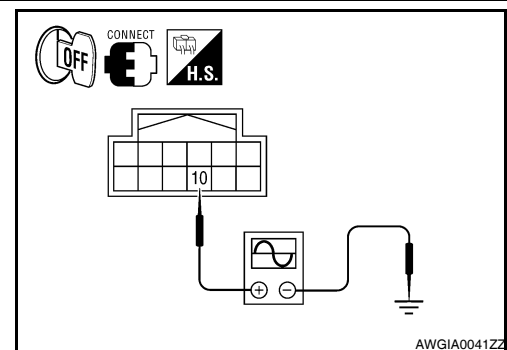

ENGINE SPEED SIGNAL CIRCUIT

< COMPONENT DIAGNOSIS >

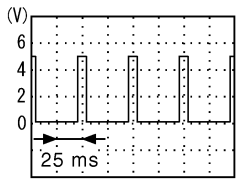
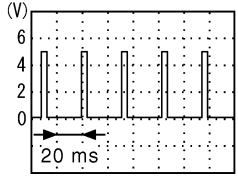
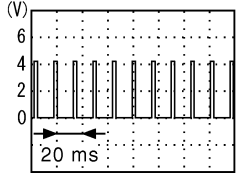
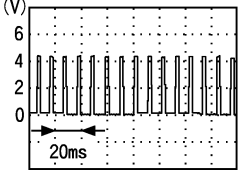
Power steering control unit			Value (Approx.)
Connector	Terminal	Condition	
M59	10 - Ground	Engine speed: At idle (Warm-up condition)	QR25DE:  <small>JSGIA0144ZZ</small>
		Engine speed: Approx. 2,000 rpm (Warm-up condition)	VQ35DE:  <small>JSGIA0143ZZ</small>
		Engine speed: At idle (Warm-up condition)	QR25DE:  <small>JSGIA0145ZZ</small>
		Engine speed: Approx. 2,000 rpm (Warm-up condition)	VQ35DE:  <small>PBIA3655J</small>

Also check harness for short to ground and short to power.

Is the inspection result normal?

YES >> GO TO 5.

NO >> Replace power steering control unit.

5. CHECK TERMINALS AND HARNESS CONNECTORS

- Check power steering control unit pin terminals for damage or loose connection with harness connector.
- Check ECM pin terminals for damage or loose connection with harness connector.

Is the inspection result normal?

YES >> Inspection End

NO >> Repair or replace damaged parts.

VEHICLE SPEED SIGNAL CIRCUIT

< COMPONENT DIAGNOSIS >

VEHICLE SPEED SIGNAL CIRCUIT

Description

INFOID:000000004205834

- Combination meter sends vehicle speed signal to power steering control unit.

Diagnosis Procedure

INFOID:000000004205835

1. PERFORM COMBINATION METER SELF-DIAGNOSIS

Perform combination meter self-diagnosis.

Is any error system detected?

- YES >> Check the error system.
- NO >> GO TO 2.

2. CHECK HARNESS BETWEEN COMBINATION METER AND POWER STEERING CONTROL UNIT

1. Turn the ignition switch OFF.
2. Disconnect combination meter harness connector.
3. Disconnect power steering control unit harness connector.
4. Check continuity between combination meter harness connector M24 (A) terminal 30 and power steering control unit harness connector M59 (B) terminal 8.

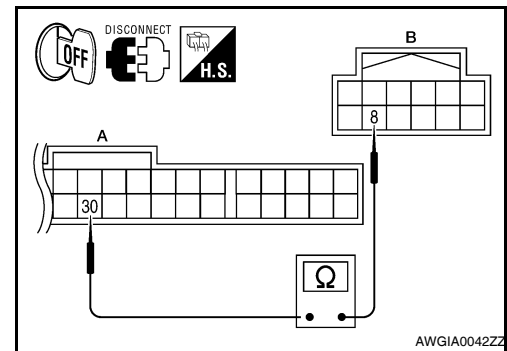

Combination meter		Power steering control unit		Continuity
Connector	Terminal	Connector	Terminal	
M24 (A)	30	M59 (B)	8	Existed

Also check harness for short to ground and short to power.

Is the inspection result normal?

- YES >> GO TO 3.
- NO >> Repair or replace damaged parts.

3. CHECK VEHICLE SPEED SIGNAL (COMBINATION METER SIDE)

1. Turn the ignition switch OFF.
2. Connect combination meter harness connector.
3. Check combination meter input/output standard values. Refer to [MWI-59, "Reference Value"](#).

Is the inspection result normal?

- YES >> GO TO 4.
- NO >> Replace combination meter. Refer to [MWI-176, "Removal and Installation"](#).

4. CHECK VEHICLE SPEED SIGNAL (POWER STEERING CONTROL UNIT SIDE)

1. Turn the ignition switch OFF.
2. Connect power steering control unit harness connector.
3. Check signal between power steering control unit harness connector M59 terminal 8 and ground with oscilloscope.

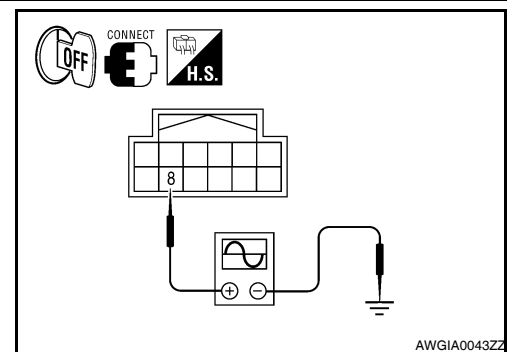

Power steering control unit			Value (Approx.)
Connector	Terminal	Condition	
M59	8 - Ground	Vehicle speed: 40 km/h (25 MPH) CAUTION: Check air pressure of tire under standard condition.	<p>ELF1080D</p>

Also check harness for short to ground and short to power.

A
B
C
D
E
F
STC
H
I
J
K
L
M
N
O
P

VEHICLE SPEED SIGNAL CIRCUIT

< COMPONENT DIAGNOSIS >

Is the inspection result normal?

YES >> GO TO 5.

NO >> Replace power steering control unit.

5. CHECK TERMINALS AND HARNESS CONNECTORS

- Check power steering control unit pin terminals for damage or loose connection with harness connector.
- Check combination meter pin terminals for damage or loose connection with harness connector.

Is the inspection result normal?

YES >> Inspection End

NO >> Repair or replace damaged parts.

POWER STEERING CONTROL UNIT

< ECU DIAGNOSIS >

ECU DIAGNOSIS

POWER STEERING CONTROL UNIT

Reference Value

INFOID:000000004205836

TERMINAL LAYOUT

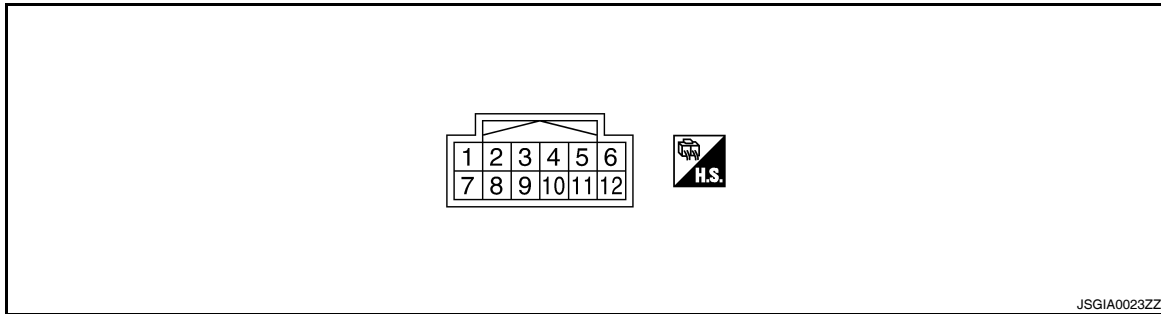

PHYSICAL VALUES

Terminal No.		Wire color	Description		Condition	Value (Approx.)
+	-		Signal name	Input/Output		
1	Ground	R/Y	Power steering solenoid valve voltage	Output	Vehicle speed: 0 km/h (0 MPH) (Engine is running)	4.4 - 6.6 V
					Vehicle speed: 100 km/h (62 MPH)	2.5 - 3.7 V
3	Ground	G	Ignition power supply	Input	Ignition switch: ON	Battery voltage
					Ignition switch: OFF	0 V
5	Ground	LG/W	Power steering solenoid valve ground	—	Always	0 V
6	Ground	B	Ground	—	Always	0 V
8	Ground	L/B	Vehicle speed signal	Input	Vehicle speed: 40 km/h (25 MPH) CAUTION: Check air pressure of tire under standard condition.	<p>The graph shows a square wave signal on a grid. The vertical axis is labeled '(V)' and ranges from 0 to 6. The horizontal axis is labeled '50ms'. The signal is a square wave with a period of approximately 10ms and a duty cycle of about 50%. The amplitude of the signal is approximately 4.5V.</p>

ELF1080D

POWER STEERING CONTROL UNIT

< ECU DIAGNOSIS >

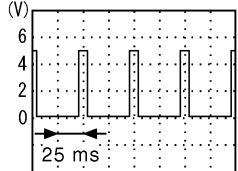
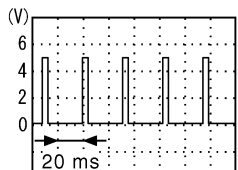
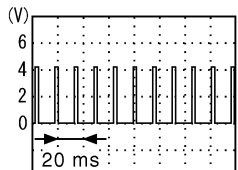
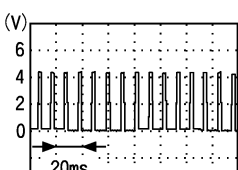
Terminal No.		Wire color	Description		Condition	Value (Approx.)
+	-		Signal name	Input/Output		
10	Ground	V/W	Engine speed signal	Input	Engine speed: At idle (Warm-up condition)	QR25DE:  <p style="text-align: right; font-size: small;">JSGIA0144ZZ</p>
					Engine speed: Approx. 2,000 rpm (Warm-up condition)	VQ35DE:  <p style="text-align: right; font-size: small;">JSGIA0143ZZ</p>
10	Ground	V/W	Engine speed signal	Input	Engine speed: Approx. 2,000 rpm (Warm-up condition)	QR25DE:  <p style="text-align: right; font-size: small;">JSGIA0145ZZ</p>
					Engine speed: Approx. 2,000 rpm (Warm-up condition)	VQ35DE:  <p style="text-align: right; font-size: small;">PBIA3655J</p>

CAUTION:

When using circuit tester or oscilloscope to measure voltage for inspection, be sure not to extend forcibly any connector terminals.

Wiring Diagram — ELECTRONICALLY CONTROLLED POWER STEERING SYS-

POWER STEERING CONTROL UNIT

< ECU DIAGNOSIS >

TEM —

INFOID:000000004205837

ELECTRONICALLY CONTROLLED POWER STEERING SYSTEM

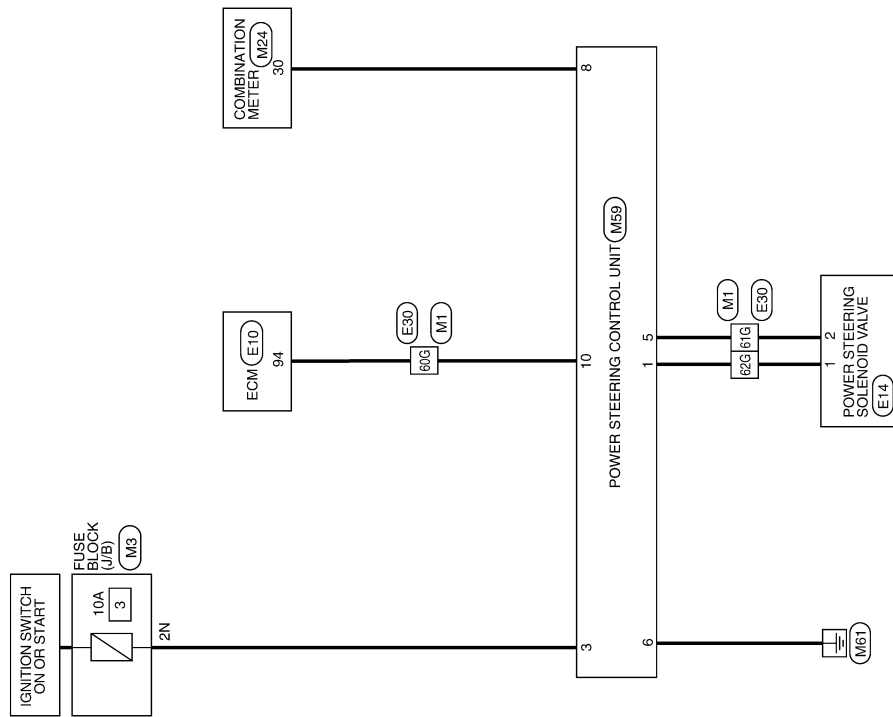

A
B
C
D
E
F
H
I
J
K
L
M
N
O
P

STC

ALGWA0001GE

POWER STEERING CONTROL UNIT

< ECU DIAGNOSIS >

ELECTRONICALLY CONTROLLED POWER STEERING SYSTEM CONNECTORS

Connector No.	M1
Connector Name	WIRE TO WIRE
Connector Color	WHITE

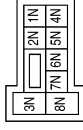
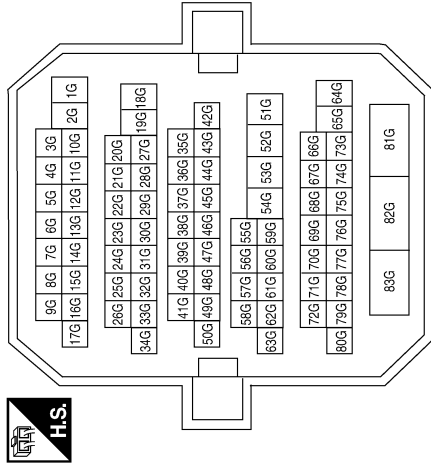

Terminal No.	Color of wire	Signal Name
60G	V/W	-
61G	LG/W	-
62G	R/Y	-

Connector No.	M3
Connector Name	FUSE BLOCK (J/B)
Connector Color	WHITE

Terminal No.	Color of wire	Signal Name
2N	G	-

Connector No.	M24
Connector Name	COMBINATION METER
Connector Color	WHITE

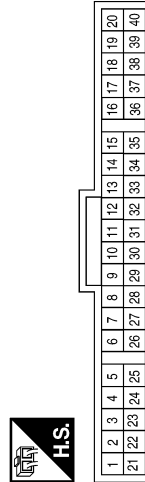

Terminal No.	Color of wire	Signal Name
30	L/B	2 P/R OUT

Connector No.	M59
Connector Name	POWER STEERING CONTROL UNIT
Connector Color	WHITE

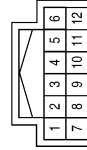

Terminal No.	Color of wire	Signal Name
1	R/Y	SOL
3	G	IGN
5	LG/W	SOL_GND
6	B	GND
8	L/B	VEHICLE SPEED (2P)
10	V/W	ENG TACHO

Connector No.	E10
Connector Name	ECM
Connector Color	BLACK

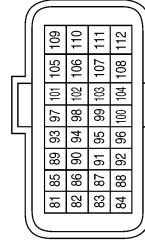

Terminal No.	Color of wire	Signal Name
94	GR	TACHO (CABIN)

POWER STEERING CONTROL UNIT

< ECU DIAGNOSIS >

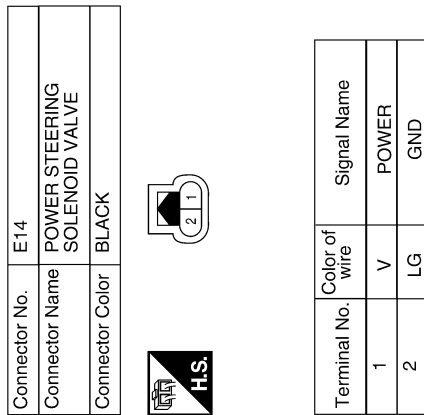
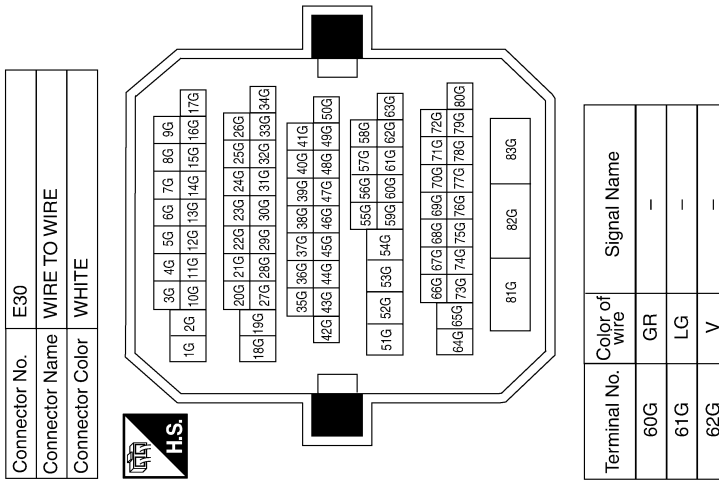

Fail Safe

EPS system

ABGIA0012GB

INFOID:000000004205838

A
B
C
D
E
F
H
I
J
K
L
M
N
O
P

STC

POWER STEERING CONTROL UNIT

< ECU DIAGNOSIS >

- EPS system enters the fail-safe mode (that allows the steering force to be controlled without impairing the drive ability) if any of the input/output signals to/from EPS system (power steering control unit) deviate from the standard.

NOTE:

The system enters the fail-safe mode if the engine speed remains at 1,500 rpm or more for over 10 seconds while the vehicle is stopped. This is normal.

- The fail-safe function is canceled when a vehicle speed signal of 2 km/h (1.2 MPH) or more is inputted or the key switch is turned OFF→ ON. EPS system restores the normal operation at that time.

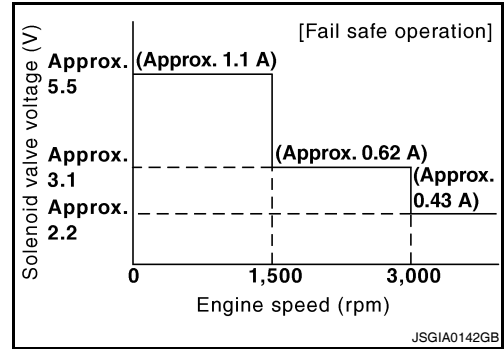

Function	Warning lamp	DTC No.	Detection point (malfunction part)	Malfunction part and cause
Fail-safe function	—	—	Vehicle speed signal	<ul style="list-style-type: none"> • Engine speed is 1,500 rpm or more and there is no vehicle speed signal input for over 10 seconds during vehicle travel. • Vehicle speed signal has abruptly dropped from 30 km/h (19 MPH) or more to 2 km/h (1.2 MPH) or less within 1.4 seconds.

UNBALANCE STEERING WHEEL TURNING FORCE (TORQUE VARIATION)

< SYMPTOM DIAGNOSIS >

SYMPTOM DIAGNOSIS

UNBALANCE STEERING WHEEL TURNING FORCE (TORQUE VARIATION)

Description

INFOID:000000004205839

- Hard steering when fully turning the steering wheel.
- Light steering when driving at a high speed.

Diagnosis Procedure

INFOID:000000004205840

1. CHECK SYSTEM FOR POWER SUPPLY AND GROUND

Perform trouble diagnosis for power supply and ground circuit. Refer to [STC-6, "Diagnosis Procedure"](#).

Is the inspection result normal?

YES >> GO TO 2.

NO >> Repair or replace damaged parts.

2. CHECK SYSTEM FOR VEHICLE SPEED SIGNAL

Perform trouble diagnosis for vehicle speed signal. Refer to [STC-13, "Diagnosis Procedure"](#).

Is the inspection result normal?

YES >> GO TO 3.

NO >> Repair or replace damaged parts.

3. CHECK SYSTEM FOR ENGINE SPEED SIGNAL

Perform trouble diagnosis for engine speed signal. Refer to [STC-10, "Diagnosis Procedure"](#).

Is the inspection result normal?

YES >> GO TO 4.

NO >> Repair or replace damaged parts.

4. CHECK SYSTEM FOR POWER STEERING SOLENOID VALVE

Perform trouble diagnosis for power steering solenoid valve. Refer to [STC-8, "Diagnosis Procedure"](#).

Is the inspection result normal?

YES >> Perform the symptom diagnosis for the steering system. Refer to [ST-3, "NVH Troubleshooting Chart"](#).

NO >> Repair or replace damaged parts.

A
B
C
D
E
F
STC
H
I
J
K
L
M
N
O
P

PRECAUTIONS

< PRECAUTION >

PRECAUTION

PRECAUTIONS

Precautions for Supplemental Restraint System (SRS) "AIR BAG" and "SEAT BELT PRE-TENSIONER"

INFOID:000000004205841

The Supplemental Restraint System such as "AIR BAG" and "SEAT BELT PRE-TENSIONER", used along with a front seat belt, helps to reduce the risk or severity of injury to the driver and front passenger for certain types of collision. This system includes seat belt switch inputs and dual stage front air bag modules. The SRS system uses the seat belt switches to determine the front air bag deployment, and may only deploy one front air bag, depending on the severity of a collision and whether the front occupants are belted or unbelted. Information necessary to service the system safely is included in the SR and SB section of this Service Manual.

WARNING:

- To avoid rendering the SRS inoperative, which could increase the risk of personal injury or death in the event of a collision which would result in air bag inflation, all maintenance must be performed by an authorized NISSAN/INFINITI dealer.
- Improper maintenance, including incorrect removal and installation of the SRS, can lead to personal injury caused by unintentional activation of the system. For removal of Spiral Cable and Air Bag Module, see the SR section.
- Do not use electrical test equipment on any circuit related to the SRS unless instructed to in this Service Manual. SRS wiring harnesses can be identified by yellow and/or orange harnesses or harness connectors.

Precautions Necessary for Steering Wheel Rotation after Battery Disconnect

INFOID:000000004205842

NOTE:

- Before removing and installing any control units, first turn the push-button ignition switch to the LOCK position, then disconnect both battery cables.
- After finishing work, confirm that all control unit connectors are connected properly, then re-connect both battery cables.
- Always use CONSULT-III to perform self-diagnosis as a part of each function inspection after finishing work. If a DTC is detected, perform trouble diagnosis according to self-diagnosis results.

This vehicle is equipped with a push-button ignition switch and a steering lock unit.

If the battery is disconnected or discharged, the steering wheel will lock and cannot be turned.

If turning the steering wheel is required with the battery disconnected or discharged, follow the procedure below before starting the repair operation.

OPERATION PROCEDURE

1. Connect both battery cables.

NOTE:

Supply power using jumper cables if battery is discharged.

2. Carry the Intelligent Key or insert it to the key slot and turn the push-button ignition switch to ACC position. (At this time, the steering lock will be released.)
3. Disconnect both battery cables. The steering lock will remain released with both battery cables disconnected and the steering wheel can be turned.
4. Perform the necessary repair operation.
5. When the repair work is completed, re-connect both battery cables. With the brake pedal released, turn the push-button ignition switch from ACC position to ON position, then to LOCK position. (The steering wheel will lock when the push-button ignition switch is turned to LOCK position.)
6. Perform self-diagnosis check of all control units using CONSULT-III.

EPS CONTROL UNIT

< REMOVAL AND INSTALLATION >

REMOVAL AND INSTALLATION

EPS CONTROL UNIT

Removal and Installation

INFOID:000000004205843

REMOVAL

1. Remove audio/navi unit. Refer to [AV-72. "Removal and Installation"](#) or [AV-437. "Removal and Installation"](#) (with navi).
2. Remove power steering control unit (1).
3. Disconnect power steering control unit connector.

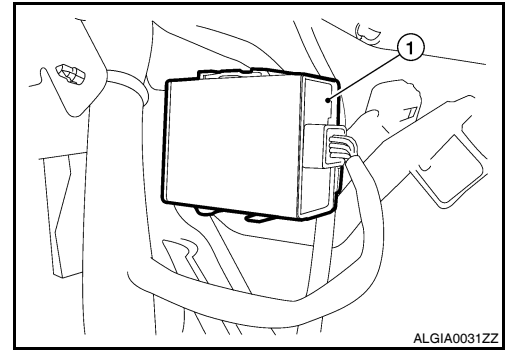

INSTALLATION

Installation is in the reverse order of removal.

A

B

C

D

E

F

STC

H

I

J

K

L

M

N

O

P