

CONTENTS

PRECAUTIONS	2	Function and System Application	17
Precautions for Supplemental Restraint System		Lithium Battery Replacement	17
“AIR BAG”	2	Checking Equipment.....	17
General Precautions	2	Data Link Connector for CONSULT.....	18
Precautions for Multiport Fuel Injection System		IDENTIFICATION INFORMATION	19
or ECM Controlled Engine.....	4	Model Variation	19
Precautions for Three Way Catalyst	4	Prefix and suffix designations:.....	19
Engine Oils.....	4	Identification Number	20
Health Protection Precautions.....	4	Vehicle Identification Number Arrangement.....	20
Environmental Protection Precautions.....	5	Engine Serial Number.....	21
Precautions for Fuel.....	5	Manual Transaxle Number.....	21
HOW TO USE THIS MANUAL	6	Automatic Transaxle Number	21
HOW TO READ WIRING DIAGRAMS — EF & EC		Dimensions.....	22
section	8	Wheels and Tires.....	22
Wiring Diagram.....	8	LIFTING POINTS AND TOW TRUCK TOWING	23
Switch Positions.....	8	Special Service Tools	23
Connector Symbols	9	Board-on Lift.....	24
Multiple Switch.....	9	Garage Jack and Safety Stand	24
Super Multiple Junction (SMJ).....	10	2-pole Lift.....	25
HOW TO READ WIRING DIAGRAMS — Except		Tow Truck Towing	25
EF & EC section	11	Towing An Automatic Transaxle Model With	
Option Abbreviations	11	Four Wheels On Ground.....	26
Wiring Diagram.....	12	Towing An Automatic Transaxle Model With	
HOW TO FOLLOW FLOW CHART IN TROUBLE		Rear Wheels Raised (With front wheels on	
DIAGNOSES	14	ground).....	26
Notice	14	Towing Point.....	26
How To Follow This Flow Chart	15	TIGHTENING TORQUE OF STANDARD BOLTS	27
Direction mark.....	15	GLOSSARY	28
Key to symbols signifying measurements		The “Glossary of Acronyms” and the “Glossary	
or procedures	16	of Technical Terms and Component Part	
CONSULT CHECKING SYSTEM	17	Names” Related to SAE J1930.....	28

PRECAUTIONS

Observe the following precautions to ensure safe and proper servicing. These precautions are not described in each individual section.



Precautions for Supplemental Restraint System "AIR BAG"

The Supplemental Restraint System "Air Bag" helps to reduce the risk or severity of injury to the driver and front passenger in a frontal collision. The Supplemental Restraint System consists of air bags (located in the center of the steering wheel and on the instrument panel on the passenger side), sensors, a control module, warning lamp, wiring harness and spiral cables. Information necessary to service the system safely is included in the **BF** section of this Service Manual.

WARNING:

- To avoid rendering the SRS inoperative, which could lead to personal injury or death in the event of a severe frontal collision, all maintenance must be performed by an authorized NISSAN dealer.
- Improper maintenance, including incorrect removal and installation of the SRS, can lead to personal injury caused by unintentional activation of the system.
- All SRS electrical wiring harnesses and connectors are covered with yellow outer insulation. Do not use electrical test equipment on any circuit related to the SRS "Air Bag".

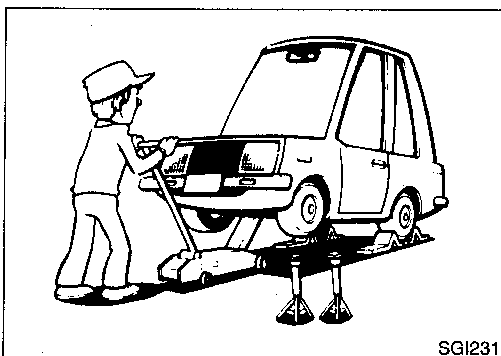
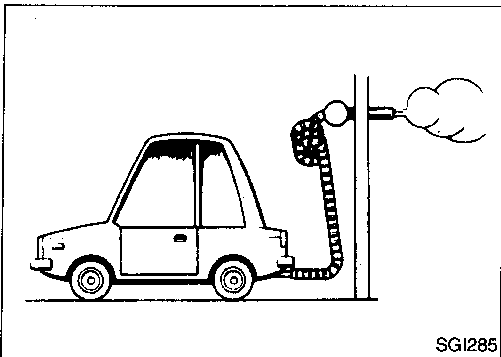

General Precautions

1. Do not operate the engine for an extended period of time without proper exhaust ventilation.
Keep the work area well ventilated and free of any inflammable materials. Special care should be taken when handling any inflammable or poisonous materials, such as gasoline, refrigerant gas, etc. When working in a pit or other enclosed area, be sure to properly ventilate the area before working with hazardous materials.
Do not smoke while working on the vehicle.
2. Before jacking up the vehicle, apply wheel chocks or other tire blocks to the wheels to prevent the vehicle from moving. After jacking up the vehicle, support the vehicle weight with safety stands at the points designated for proper lifting and towing before working on the vehicle.
These operations should be done on a level surface.
3. When removing a heavy component such as the engine or transaxle, be careful not to lose your balance and drop them. Also, do not allow them to strike adjacent parts, especially the brake tubes and master cylinder.

PRECAUTIONS

General Precautions (Cont'd)

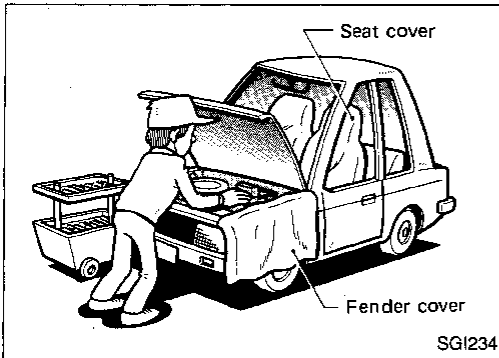
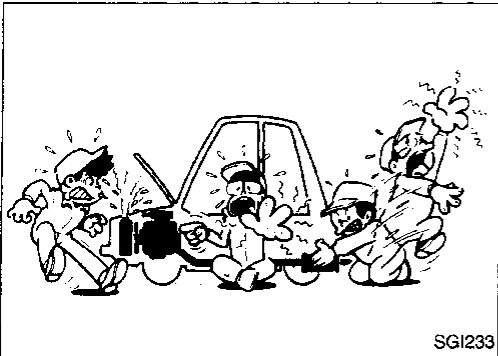
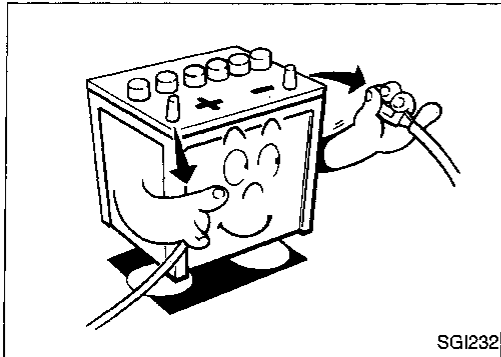

4. Before starting repairs which do not require battery power, always turn off the ignition switch, then disconnect the battery negative cable from the battery to prevent accidental short circuit.
5. To prevent serious burns, avoid contact with hot metal parts such as the radiator, exhaust manifold, tail pipe and muffler. Do not remove the radiator cap when the engine is hot.
6. Before servicing the vehicle, protect fenders, upholstery and carpeting with appropriate covers. Take caution that keys, buckles or buttons on your person do not scratch the paint.
7. Clean all disassembled parts in the designated liquid or solvent prior to inspection or assembly.
8. Replace oil seals, gaskets, packings, O-rings, locking washers, cotter pins, self-locking nuts, etc. with new ones.
9. Replace inner and outer races of tapered roller bearings and needle bearings as a set.
10. Arrange the disassembled parts in accordance with their assembled locations and sequence.
11. Do not touch the terminals of electrical components which use microcomputers (such as electronic control module). Static electricity may damage internal electronic components.
12. After disconnecting vacuum or air hoses, attach a tag to indicate the proper connection.
13. Use only the lubricants specified in MA section.
14. Use approved bonding agent, sealants or their equivalents when required.
15. Use tools and recommended special tools where specified for safe and efficient service repairs.
16. When repairing the fuel, oil, water, vacuum or exhaust systems, check all affected lines for leaks.
17. Dispose of drained oil or the solvent used for cleaning parts in an appropriate manner.

GI

MA

EM

LC

EF &
EC

FE

CL

MT

AT

FA

RA

BR

ST

BF

HA

EL

IDX

PRECAUTIONS

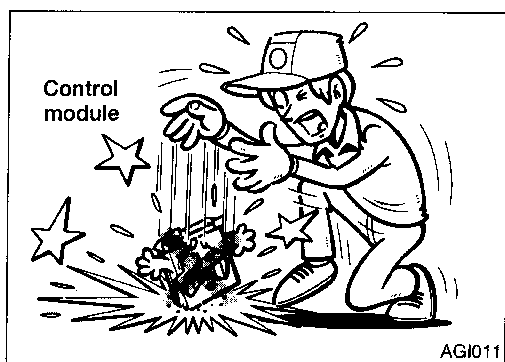

Precautions for Multiport Fuel Injection System or ECM Controlled Engine

1. Before connecting or disconnecting multiport fuel injection system or ECM (ECCS control module) harness connector to or from any multiport fuel injection system or ECM, be sure to turn the ignition switch to the "OFF" position and disconnect the negative battery terminal. Otherwise, there may be damage to ECM.
2. Before disconnecting pressurized fuel line from fuel pump to injectors, be sure to release fuel pressure to eliminate danger.
3. Be careful not to jar components such as ECM and mass air flow sensor.

Precautions for Three Way Catalyst

If a large amount of unburned fuel flows into the catalyst, the catalyst temperature will be excessively high. To prevent this, follow the procedure below:

1. Use unleaded gasoline only. Leaded gasoline will seriously damage the three way catalyst.
2. When checking for ignition spark or measuring engine compression, make tests quickly and only when necessary.
3. Do not run engine when the fuel tank level is low, otherwise the engine may misfire causing damage to the catalyst.
4. Do not place the vehicle on inflammable material. Keep inflammable material off the exhaust pipe.

Engine Oils

Prolonged and repeated contact with used engine oil may cause skin cancer. Try to avoid direct skin contact with used oil. If skin contact is made, wash thoroughly with soap or hand cleaner as soon as possible.

HEALTH PROTECTION PRECAUTIONS

1. Avoid prolonged and repeated contact with oils, particularly used engine oils.
2. Wear protective clothing, including oil resistant gloves where practical.
3. Do not put oily rags in pockets.
4. Avoid contaminated clothes, particularly underclothing, with oil.
5. Heavily soiled clothing and oil-impregnated footwear should not be worn. Overalls must be cleaned regularly.
6. First Aid treatment should be obtained immediately for open cuts and wounds.
7. Use barrier creams, applying them before each work period, to help the removal of oil from the skin.
8. Wash with soap and water to ensure all oil is removed (skin cleansers and nail brushes will help). Preparations containing lanolin replace the natural skin oils which have been removed.
9. Do not use gasoline, kerosene, diesel fuel, gas oil, thinners or solvents for cleaning skin.
10. If skin disorders develop, obtain medical advice without delay.
11. Where practical, degrease components prior to handling.

PRECAUTIONS

Engine Oils (Cont'd)

12. Where there is a risk of eye contact, eye protection should be worn, for example, chemical goggles or face shields; in addition an eye wash facility should be provided.

ENVIRONMENTAL PROTECTION PRECAUTIONS

Burning used engine oil in small space heaters or boilers can be recommended only for units of approved design. The heating system must meet the requirements of HM Inspectorate of Pollution for small burners of less than 0.4 MW. If in doubt check with the appropriate local authority and/or manufacturer of the approved appliance.

Dispose of used oil and used oil filters through authorized waste disposal contractors to licensed waste disposal sites, or to the waste oil reclamation trade. If in doubt, contact the local authority for advice on disposal facilities.

It is illegal to pour used oil on to the ground, down sewers or drains, or into water courses.

The regulations concerning the pollution of the environment will vary from country to country.

Precautions for Fuel

Use unleaded premium gasoline with an octane rating of at least 91 AKI (Anti-Knock Index) number (research octane number 96). If unleaded premium gasoline is not available, unleaded regular gasoline with an octane rating of at least 87 AKI (research octane number 91) can be used.

However, for maximum vehicle performance, the use of unleaded premium gasoline is recommended.

CAUTION:

Do not use leaded gasoline. Using leaded gasoline will damage the three way catalyst.

GI

MA

EM

LC

EF &
EC

FE

CL

MT

AT

FA

RA

BR

ST

BF

HA

EL

IDX

HOW TO USE THIS MANUAL



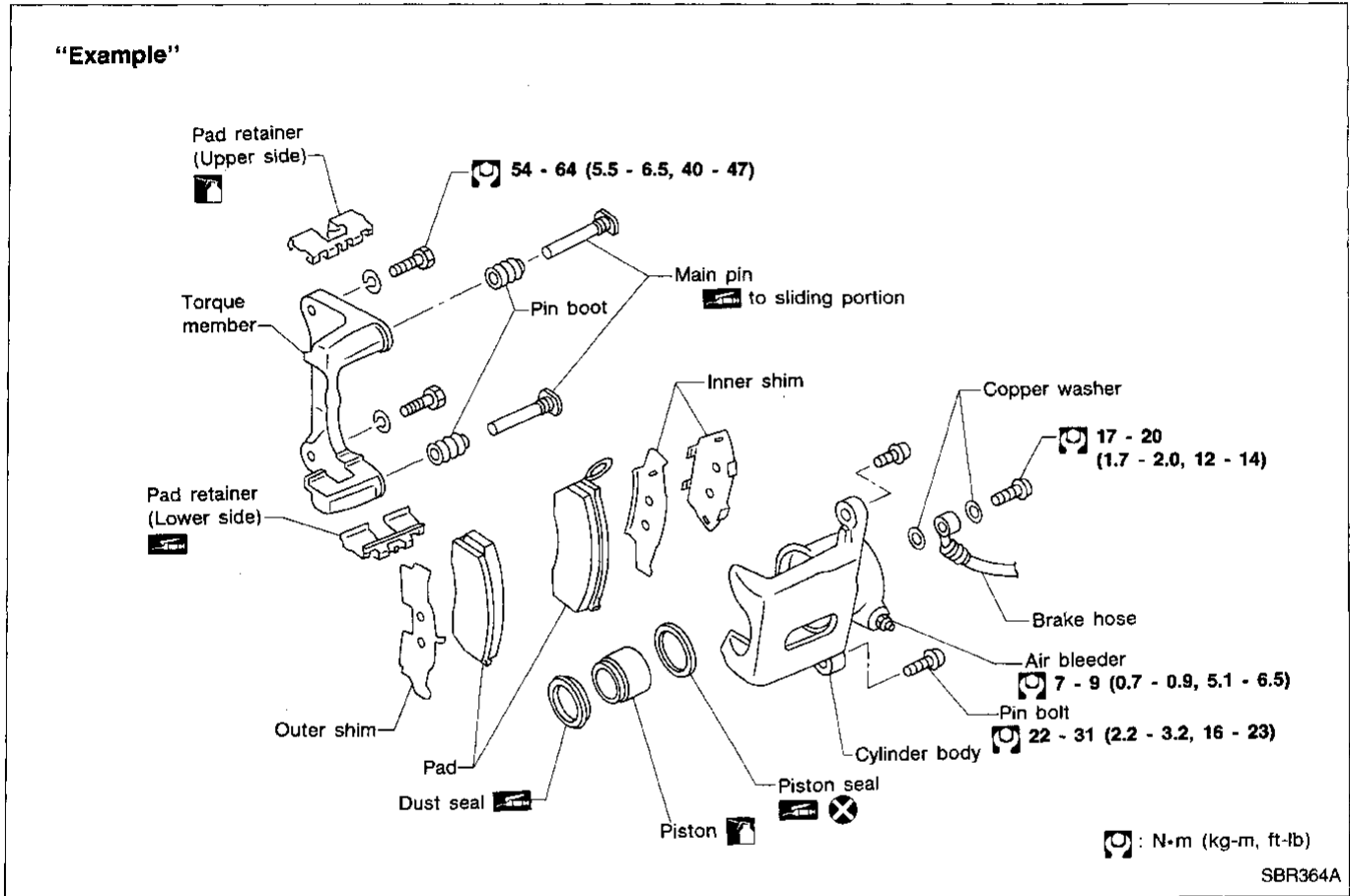





1. **ALPHABETICAL INDEX** is provided at the end of this manual so that you can rapidly find the item and page you are searching for.
2. **A QUICK REFERENCE INDEX**, a black tab (e.g. **BR**) is provided on the first page. You can quickly find each section by mating it to the section's black tabs.
3. **THE CONTENTS** are listed on the first page of each section.
4. **THE TITLE** is indicated on the upper portion of each page and shows the part or system.
5. **THE PAGE NUMBER** of each section consists of two letters which designate the particular section and a number (e.g. "BR-5").
6. **THE LARGE ILLUSTRATIONS** are exploded views (See below) and contain tightening torques, lubrication points and other information necessary to perform repairs. The illustrations should be used in reference to service matters only. When ordering parts, refer to the appropriate **PARTS CATALOG**.



7. **THE SMALL ILLUSTRATIONS** show the important steps such as inspection, use of special tools, knacks of work and hidden or tricky steps which are not shown in the previous large illustrations. Assembly, inspection and adjustment procedures for the complicated units such as the automatic transaxle or transmission, etc. are presented in a step-by-step format where necessary.

HOW TO USE THIS MANUAL

8. The following **SYMBOLS AND ABBREVIATIONS** are used:

	: Tightening torque	M/T	: Manual Transaxle/Transmission
	: Should be lubricated with grease. Unless otherwise indicated, use recommended multi-purpose grease.	A/T	: Automatic Transaxle/Transmission
	: Should be lubricated with oil.	Tool	: Special Service Tools
	: Sealing point	LHD	: Left-Hand Drive
	: Checking point	RHD	: Right-Hand Drive
	: Always replace after every disassembly.	ATF	: Automatic Transmission Fluid
	: Apply petroleum jelly.	D ₁	: Drive range 1st gear
	: Apply ATF	D ₂	: Drive range 2nd gear
★	: Select with proper thickness.	D ₃	: Drive range 3rd gear
☆	: Adjustment is required.	D ₄	: Drive range 4th gear
SDS	: Service Data and Specifications	OD	: Overdrive
LH, RH	: Left-Hand, Right-Hand	2 ₂	: 2nd range 2nd gear
		2 ₁	: 2nd range 1st gear
		1 ₂	: 1st range 2nd gear
		1 ₁	: 1st range 1st gear

9. The **UNITS** given in this manual are primarily expressed as the SI UNIT (International System of Unit), and alternatively expressed in the metric system and in the yard/pound system.

“Example”

Tightening torque:

59 - 78 N·m (6.0 - 8.0 kg-m, 43 - 58 ft-lb)

10. **TROUBLE DIAGNOSES** are included in sections dealing with complicated components.
11. **SERVICE DATA AND SPECIFICATIONS** are contained at the end of each section for quick reference of data.
12. The captions **WARNING** and **CAUTION** warn you of steps that must be followed to prevent personal injury and/or damage to some part of the vehicle.
 - **WARNING** indicates the possibility of personal injury if instructions are not followed.
 - **CAUTION** indicates the possibility of component damage if instructions are not followed.
 - **BOLD TYPED STATEMENTS** except **WARNING** and **CAUTION** give you helpful information.

GI
NA
EM
LC
EF &
EC
FE
CL
MT
AT
FA
RA
BR
ST
BF
HA
EL
IDX

WIRING DIAGRAM

Symbols used in WIRING DIAGRAM are shown below:

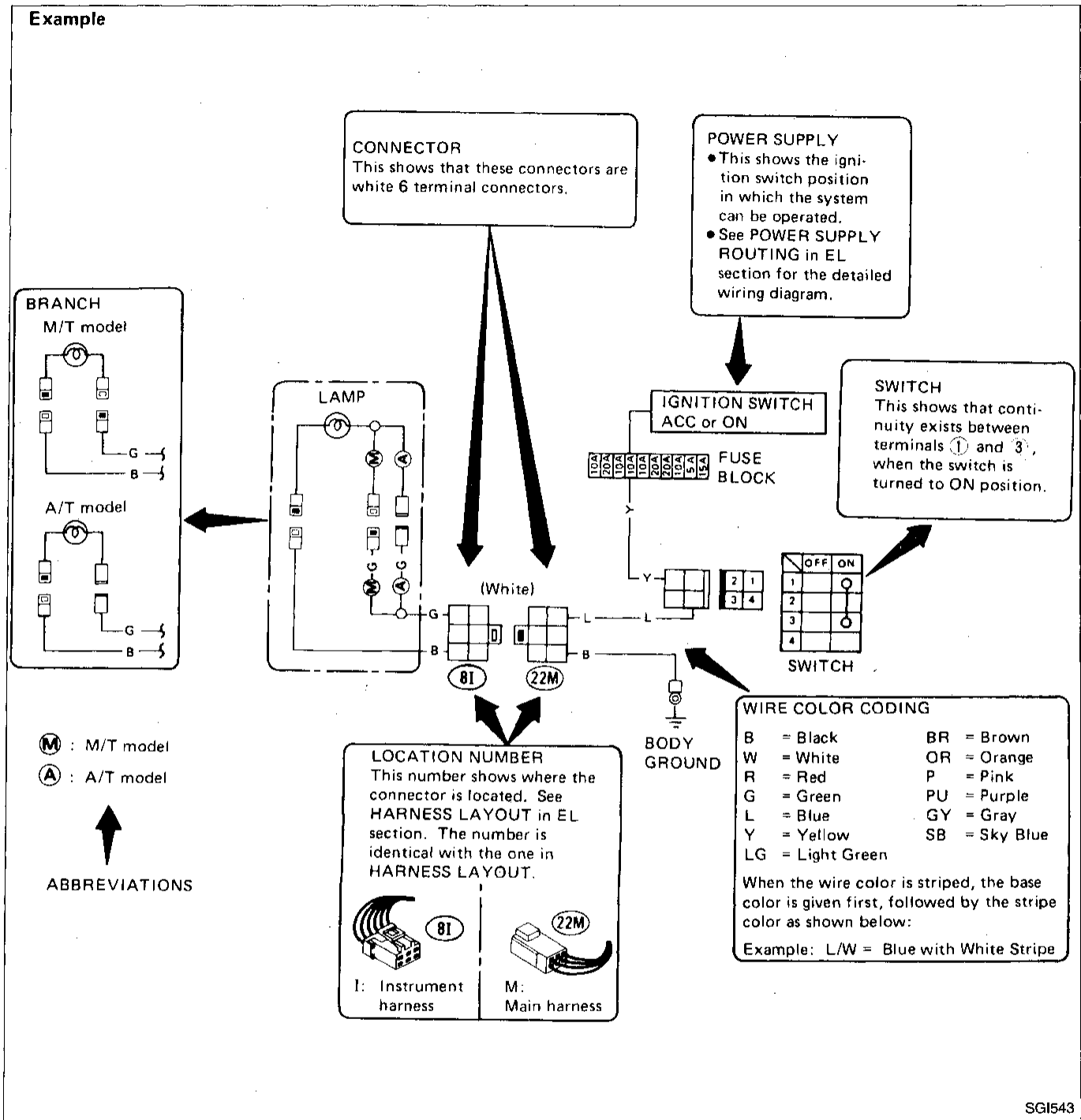

SWITCH POSITIONS

Wiring diagram switches are shown with the vehicle in the following condition.

- Ignition switch "OFF".
- Doors, hood and trunk lid/back door closed.
- Pedals are not depressed and parking brake is released.

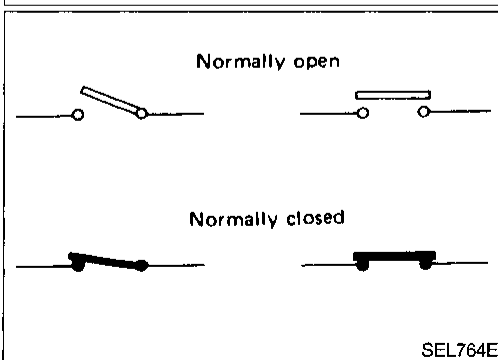

HOW TO READ WIRING DIAGRAMS — EF & EC section

Example

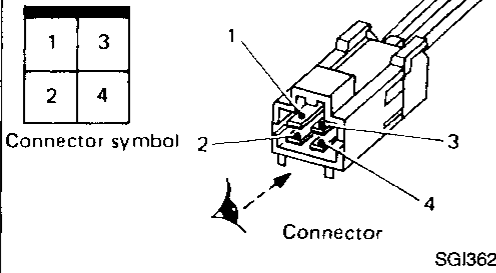

CONNECTOR SYMBOLS

- All connector symbols in wiring diagrams are shown from the terminal side.

Example

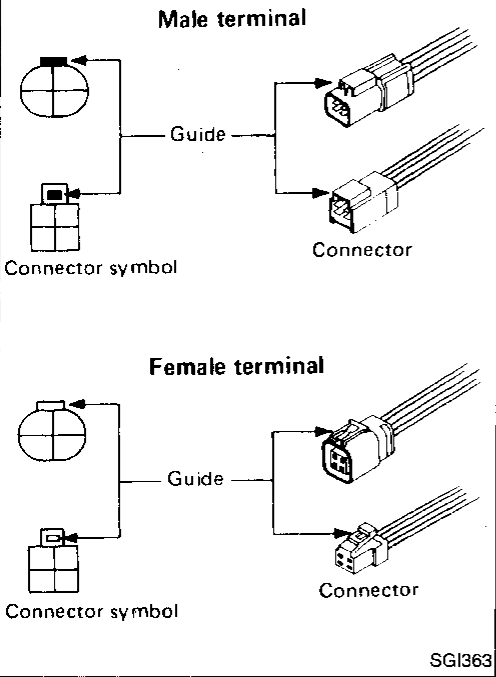

- Male and female terminals
Connector guides for male terminals are shown in black and female terminals in white in wiring diagrams.

MULTIPLE SWITCH

The continuity of the multiple switch is identified in the switch chart in wiring diagrams.

Example

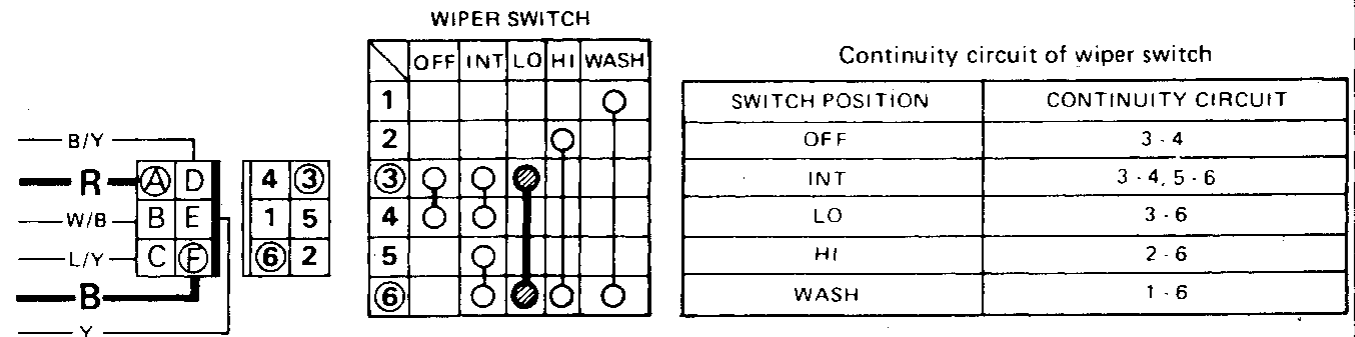

Example: Wiper switch in LO position

Continuity circuit: Red wire - A terminal - ③ terminal - Wiper switch (● - ● : LO) - ⑥ terminal - F terminal - Black wire

SGI365

HOW TO READ WIRING DIAGRAMS — EF & EC section

SUPER MULTIPLE JUNCTION (SMJ)

- The "SMJ" indicated in wiring diagrams is shown in a simplified form. The terminal arrangement should therefore be referred to in the foldout at the end of the Service Manual.
- The foldout should be spread to read the entire wiring diagram.

Example

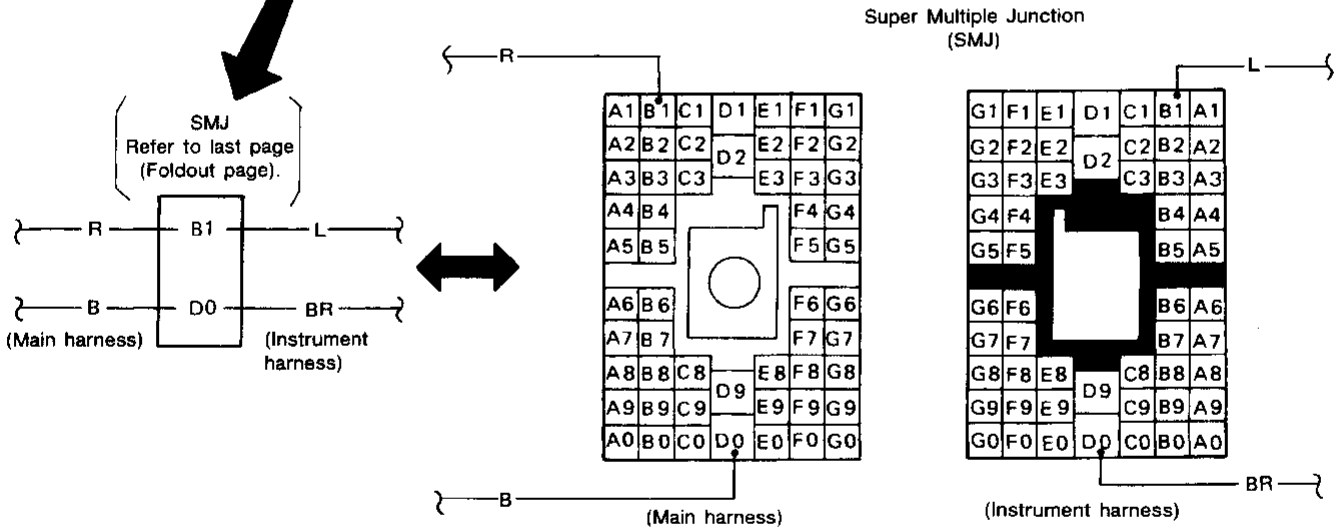
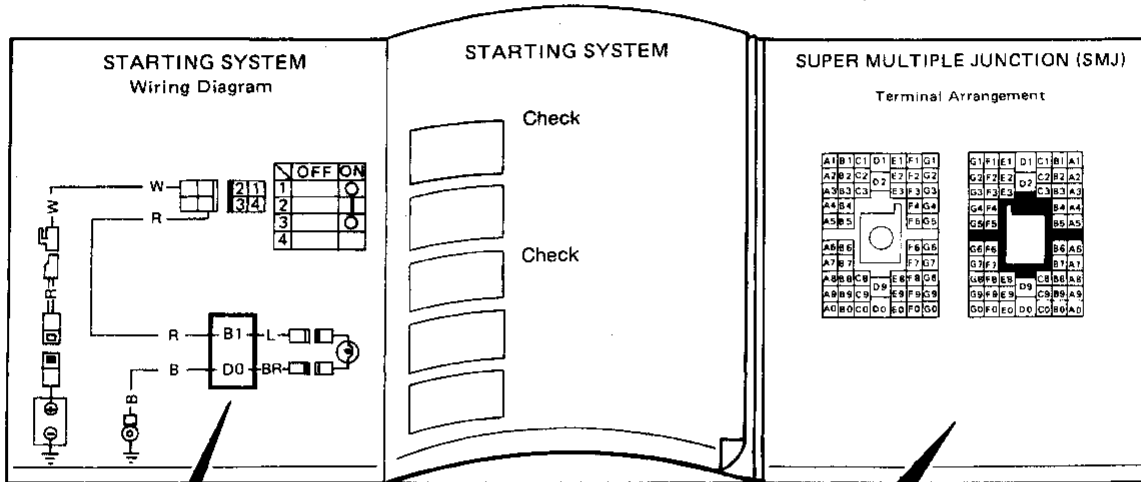

AGI012

HOW TO READ WIRING DIAGRAMS — Except EF & EC section

This wiring diagram information applies to AT, BR, BF, HA and EL sections.

OPTION ABBREVIATIONS

WH: Models with head-up display system
OH: Models without head-up display system
N: For Canada
AS: Models with ASCD system
A: A/T models
M: M/T models
WT: Models with theft warning system
OT: Models without theft warning system
U: For USA
WC: Models with cornering lamp
OC: Models without cornering lamp
WR: Models with rear air spoiler

OR: Models without rear air spoiler
SE: SE models
ES: Except SE models
MA: Models with manual air conditioning system
AA: Models with auto air conditioning system
CD: Models with CD player
AB: Models with ABS
UW: USA models with theft warning system
UO: USA models without theft warning system
WS: Models with sunroof
OS: Models without sunroof

GI

MA

EM

LC

EF &
EC

FE

CL

MT

AT

FA

RA

BR

ST

BF

HA

EL

IDX

HOW TO READ WIRING DIAGRAMS — Except EF & EC section

WIRING DIAGRAM

Example

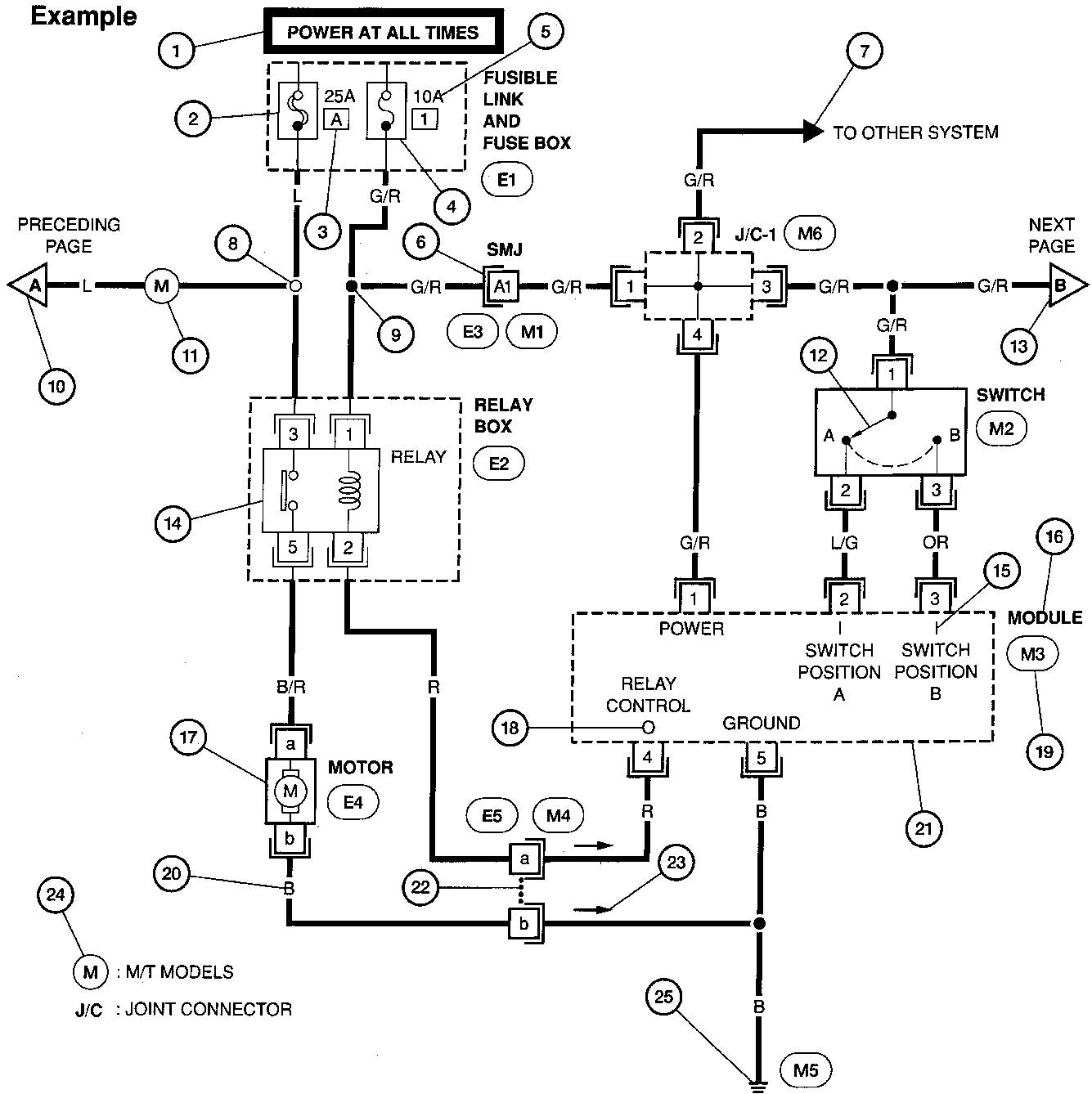

M : M/T MODELS
J/C : JOINT CONNECTOR

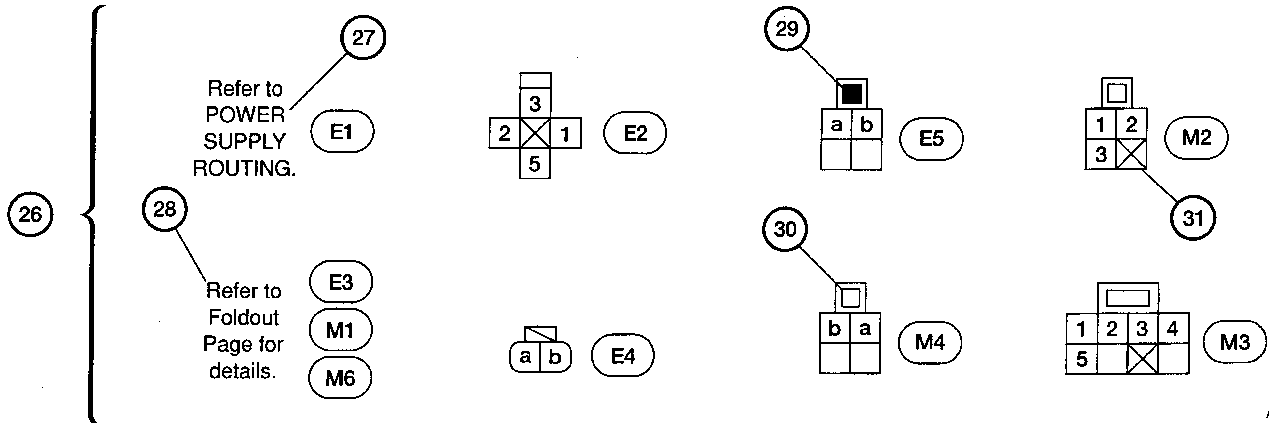

HOW TO READ WIRING DIAGRAMS — Except EF & EC section

Number	Item	Description
1	Power condition	<ul style="list-style-type: none"> This shows the condition when the system receives battery positive voltage (can be operated).
2	Fusible link	<ul style="list-style-type: none"> The double line shows that this is a fusible link. The open circle shows current flow in and the shaded circle shows current flow out.
3	Fusible link/fuse location	<ul style="list-style-type: none"> This shows the location of the fusible link or fuse in the fusible link or fuse box. See "POWER SUPPLY ROUTING" in EL section for arrangement.
4	Fuse	<ul style="list-style-type: none"> The single line shows that this is a fuse. The open circle shows current flow in and the shaded circle shows current flow out.
5	Current rating	<ul style="list-style-type: none"> This shows the current rating of the fusible link or fuse.
6	Connectors	<ul style="list-style-type: none"> This shows that connector (E3) is female and connector (M1) is male. The G/R wire is located in the (A1) terminal of both connectors.
7	System branch	<ul style="list-style-type: none"> This shows that the system branches to another system on the vehicle.
8	Optional splice	<ul style="list-style-type: none"> The open circle shows that the splice is optional depending on vehicle application.
9	Splice	<ul style="list-style-type: none"> The shaded circle shows that the splice is always on the vehicle.
10	Page crossing	<ul style="list-style-type: none"> This arrow shows that the circuit continues to the preceding page. The A will match with an A on the preceding page.
11	Option abbreviation	<ul style="list-style-type: none"> This shows that the circuit is optional depending on vehicle application.
12	Switch	<ul style="list-style-type: none"> This shows that continuity exists between terminals (1) and (2) when the switch is in the A position. Continuity exists between terminals (1) and (3) when the switch is in the B position.
13	Page Crossing	<ul style="list-style-type: none"> This arrow shows that the circuit continues to the next page. The B will match with a B on the next page.
14	Relay	<ul style="list-style-type: none"> This shows an internal representation of the relay. See "STANDARDIZED RELAY" in EL section for details.
15	Module input	<ul style="list-style-type: none"> The I shows that a signal is input to the module at this terminal. A brief description of the input is included.
16	Component name	<ul style="list-style-type: none"> This shows the name of the component.
17	Solid component box	<ul style="list-style-type: none"> The solid line around the component shows that the entire component is shown.
18	Module output	<ul style="list-style-type: none"> The O shows that a signal is output from the module at this terminal. A brief description of the output is included.
19	Connector number	<ul style="list-style-type: none"> This shows the connector number. The letter shows which harness the connector is located. Example: M: main harness. See "HARNES LAYOUT" in EL section to locate the connector. A coordinate grid is included for complex harnesses to aid in locating connectors.
20	Wire color	<ul style="list-style-type: none"> This shows a code for the color of the wire. For wire color code definitions, refer to GI-8.
21	Dashed component box	<ul style="list-style-type: none"> The dashed line around the component shows that only a portion of the component is shown.
22	Common connector	<ul style="list-style-type: none"> The dotted lines between terminals show that these terminals are part of the same connector.
23	Current flow arrow	<ul style="list-style-type: none"> The arrow shows the direction of current flow. Arrows are included when current flows across or up the page. A double arrow ↔ shows that current can flow in either direction depending on circuit operation.
24	Option description	<ul style="list-style-type: none"> This shows a description of the option abbreviation used on the page.
25	Ground	<ul style="list-style-type: none"> This shows the ground connection.
26	Connector views	<ul style="list-style-type: none"> This area shows the connector faces of the components in the wiring diagram on the page.
27	Reference	<ul style="list-style-type: none"> This shows that more information on power supply exists. See "POWER SUPPLY ROUTING" in EL section for details.
28	Reference	<ul style="list-style-type: none"> This shows that more information on the Super Multiple Junction (SMJ) and joint connectors exists. See Foldout Page in EL section for details.
29	Male connector	<ul style="list-style-type: none"> The shaded lock area shows that the connector is male.
30	Female connector	<ul style="list-style-type: none"> The unshaded lock area shows that the connector is female.
31	Unused terminal	<ul style="list-style-type: none"> The X shows that there is no wire in this terminal.

GI

MA

EM

LC

EF &
EC

FE

CL

MT

AT

FA

RA

BR

ST

BF

HA

EL

IDX

HOW TO FOLLOW FLOW CHART IN TROUBLE DIAGNOSES

Example

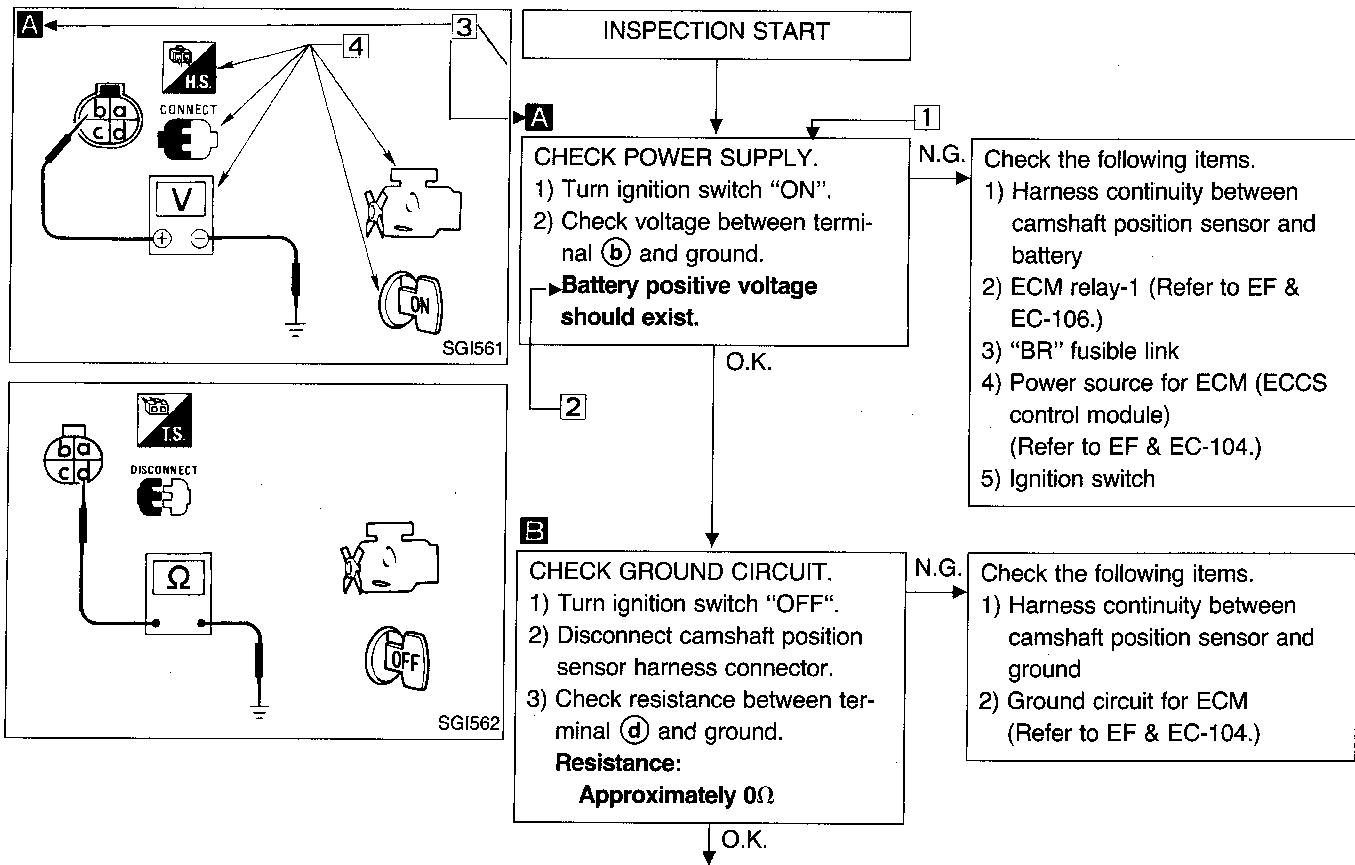

NOTICE

The flow chart indicates work procedures required to diagnose problems effectively. Observe the following instructions before diagnosing.

- 1) Use the flow chart after locating probable causes of a problem following the "Preliminary Check" or the "Symptom Chart".
- 2) After repairs, re-check that the problem has been completely eliminated.
- 3) Refer to Component Parts Location and Harness Layout for the Systems described in each section for identification/ location of components and harness connectors.
- 4) Refer to the Circuit Diagram for Quick Pinpoint Check. If you must check circuit continuity between harness connectors in more detail, such as when a sub-harness is used, refer to Wiring Diagram and Harness Layout in EL section for identification of harness connectors.
- 5) When checking circuit continuity, ignition switch should be "OFF".
- 6) Before checking voltage at connectors, check battery positive voltage.
- 7) After accomplishing the Diagnostic Procedures and Electrical Components Inspection, make sure that all harness connectors are reconnected as they were.

HOW TO FOLLOW THIS FLOW CHART

1) Work and diagnostic procedure

Start to diagnose a problem using procedures indicated in enclosed blocks, as shown in the following example.

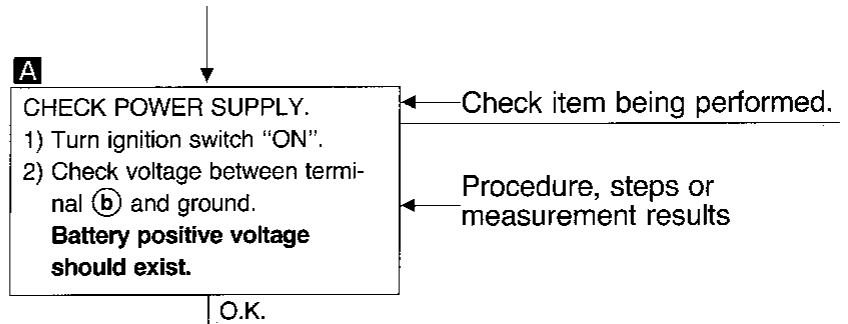

2) Measurement results

Required results are indicated in bold type in the corresponding block, as shown below:

These have the following meanings:

Battery positive voltage → 11 - 14V or approximately 12V

Voltage: Approximately 0V → Less than 1V

3) Cross reference of work symbols in the text and illustrations

Illustrations are provided as visual aids for work procedures. For example, symbol **A** indicated in the left upper portion of each illustration corresponds with the symbol in the flow chart for easy identification. More precisely, the procedure under the "CHECK POWER SUPPLY" outlined previously is indicated by an illustration **A**.

4) Symbols used in illustrations

Symbols included in illustrations refer to measurements or procedures. Before diagnosing a problem, familiarize yourself with each symbol.

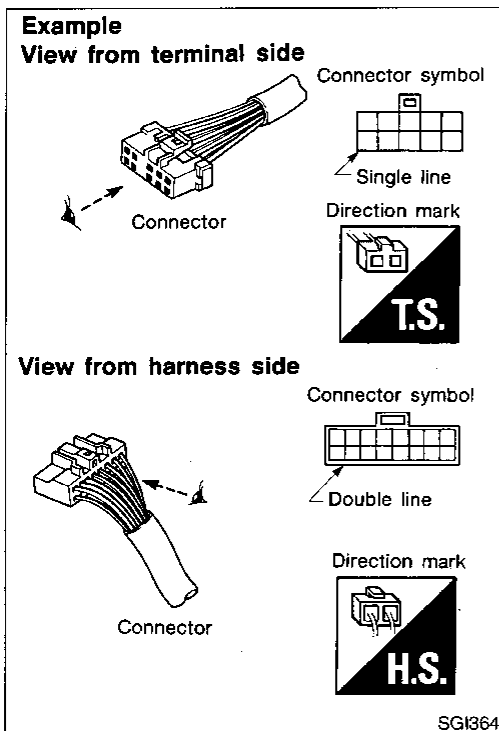

Direction mark

A direction mark is shown to clarify the side of connector (terminal side or harness side).

Direction marks are mainly used in the illustrations indicating terminal inspection.



: View from terminal side ... T.S.

- All connector symbols shown from the terminal side are enclosed by a single line.





































: View from harness side ... H.S.

- All connector symbols shown from the harness side are enclosed by a double line.

HOW TO FOLLOW FLOW CHART IN TROUBLE DIAGNOSES

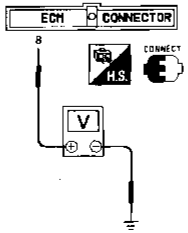
Key to symbols signifying measurements or procedures

Symbol	Symbol explanation	Symbol	Symbol explanation
	Check after disconnecting the connector to be measured.		Procedure with CONSULT
	Check after connecting the connector to be measured.		Procedure without CONSULT
	Insert key into ignition switch.		A/C switch is "OFF".
	Remove key from ignition switch.		A/C switch is "ON".
	Turn ignition switch to "OFF" position.		REC switch is "ON".
	Turn ignition switch to "ON" position.		REC switch is "OFF".
	Turn ignition switch to "START" position.		DEF switch is "ON".
	Turn ignition switch from "OFF" to "ACC" position.		VENT switch is "ON".
	Turn ignition switch from "ACC" to "OFF" position.		Fan switch is "ON". (At any position except for "OFF" position)
	Turn ignition switch from "OFF" to "ON" position.		Fan switch is "OFF".
	Turn ignition switch from "ON" to "OFF" position.		Apply fused battery positive voltage directly to components.
	Do not start engine, or check with engine stopped.		Drive vehicle.
	Start engine, or check with engine running.		Disconnect battery negative cable.
	Apply parking brake.		Depress brake pedal.
	Release parking brake.		Release brake pedal.
	Check after engine is warmed up sufficiently.		Depress accelerator pedal.
	Voltage should be measured with a voltmeter.		Release accelerator pedal.
	Circuit resistance should be measured with an ohmmeter.		Pin terminal check for SMJ type ECM and A/T control unit connectors. For details regarding the terminal arrangement, refer to the foldout page.
	Current should be measured with an ammeter.		

CONSULT CHECKING SYSTEM

Function and System Application

Diagnostic test mode	Function	ECCS	A/T	Air bag
Work support	This mode enables a technician to adjust some devices faster and more accurately by following the indications on CONSULT.	X	—	—
Self-diagnostic results	Self-diagnostic results can be read and erased quickly.	X	X	X
Data monitor	Input/Output data in the ECM can be read.	X	X	—
Active test	Diagnostic Test Mode in which CONSULT drives some actuators apart from the ECMs and also shifts some parameters in a specified range.	X	—	—
ECM part number	ECM part number can be read.	X	X	—
Function test	ECCS faults can be isolated to a general area, semi-automatically and in a short time, by following the directions on the screen.	X	—	—

X: Applicable

Lithium Battery Replacement

CONSULT contains a lithium battery. When replacing the battery obey the following:

WARNING:

Replace the lithium battery with SANYO Electric Co., Ltd., CR2032 only. Use of another battery may present a risk of fire or explosion. The battery may present a fire or chemical burn hazard if mistreated. Do not recharge, disassemble or dispose of in fire.

Keep the battery out of reach of children and discard used battery conforming to the local regulations.

Checking Equipment

When ordering the below equipment, contact your NISSAN distributor.

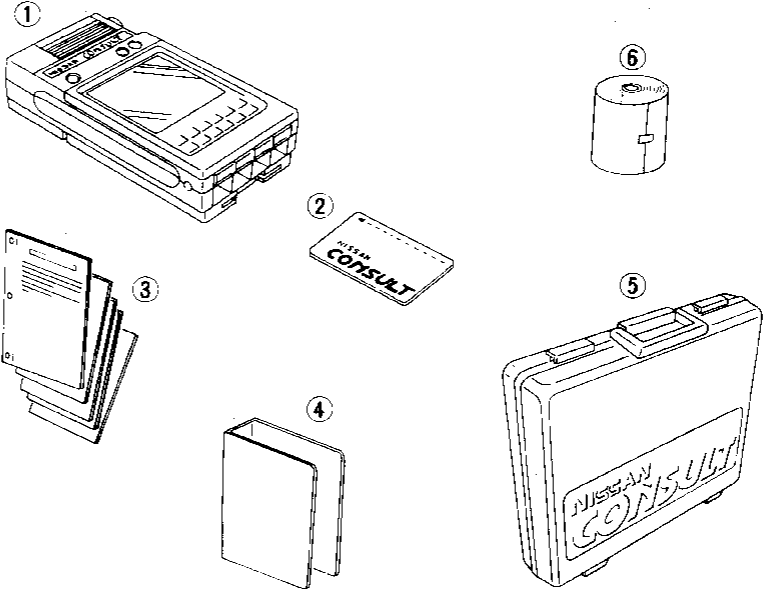
Tool name	Description
NISSAN CONSULT kit	
① CONSULT unit and accessories	
② Program card (UE930)	
③ Operation manuals	
④ Binder	
⑤ Carrying case	
⑥ Thermal paper (Rolls)	

CONSULT CHECKING SYSTEM

Data Link Connector for Consult

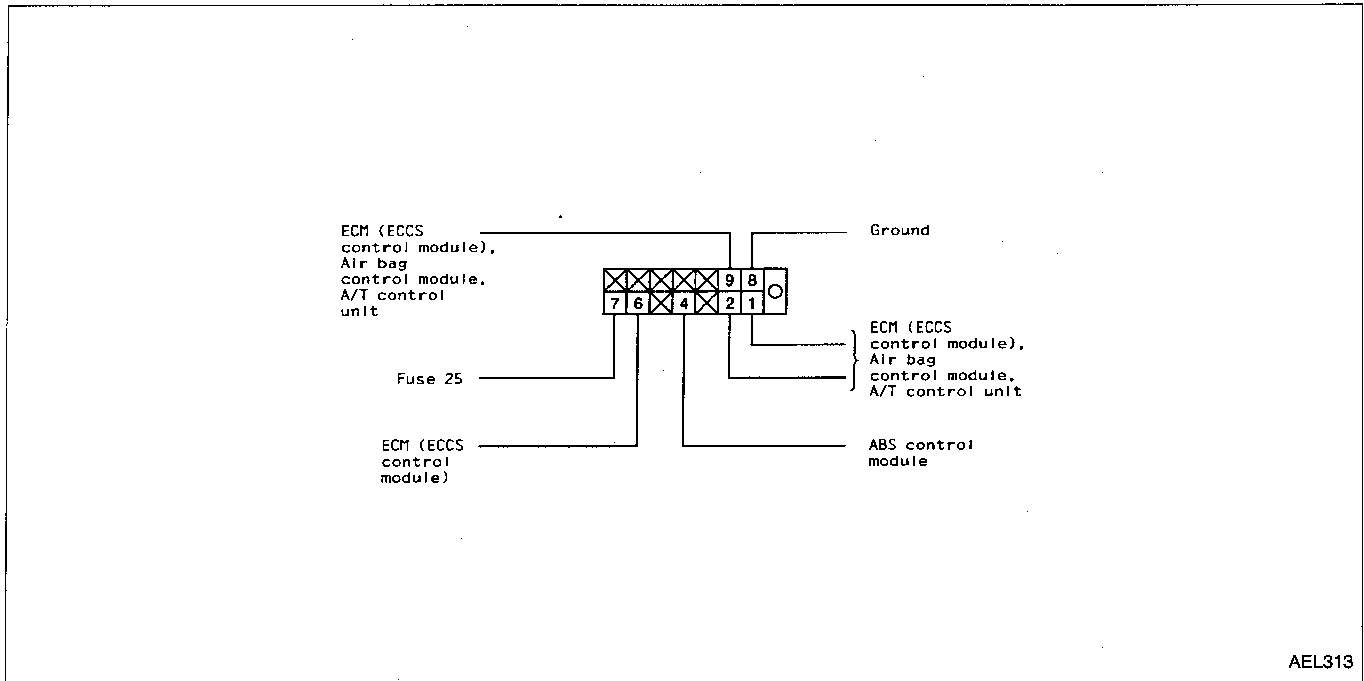

IDENTIFICATION INFORMATION

Model Variation

Destination	Body	Engine	Grade	Transaxle	
				RS5F50A	RE4F04A
Non-California, USA	Sedan	KA24DE	XE	BBGALHF-EUA	BBGALHA-EUA
			GLE	—	BBGALJA-EUA
			SE	BBGALYF-EUA	BBGALYA-EUA
			GXE	BBGALBF-EUA	BBGALBA-EUA
California, USA			XE	BBGALHF-EVA	BBGALHA-EVA
			GLE	—	BBGALJA-EVA
			SE	BBGALYF-EVA	BBGALYA-EVA
			GXE	BBGALBF-EVA	BBGALBA-EVA
Canada			XE	BBGALHF-ENA	BBGALHA-ENA
			GLE	—	BBGALJA-ENA
			SE	BBGALYF-ENA	BBGALYA-ENA
			GXE	BBGALBF-ENA	BBGALBA-ENA

Prefix and suffix designations:

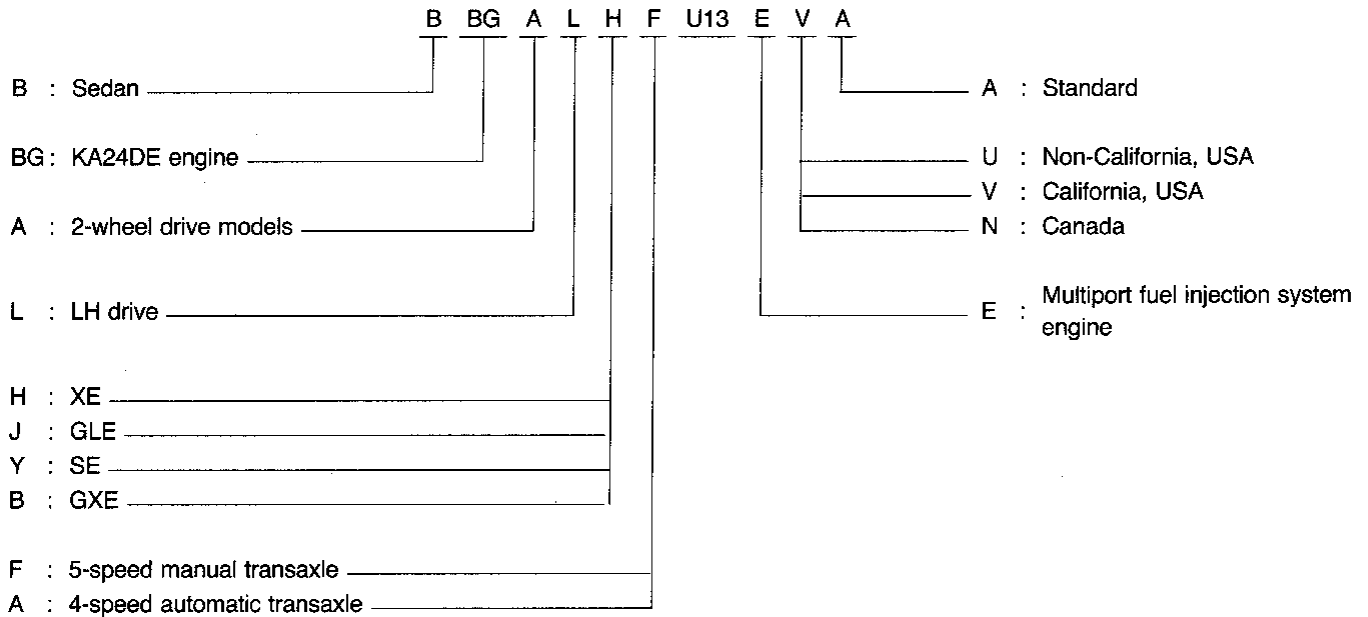

IDENTIFICATION INFORMATION

Identification Number

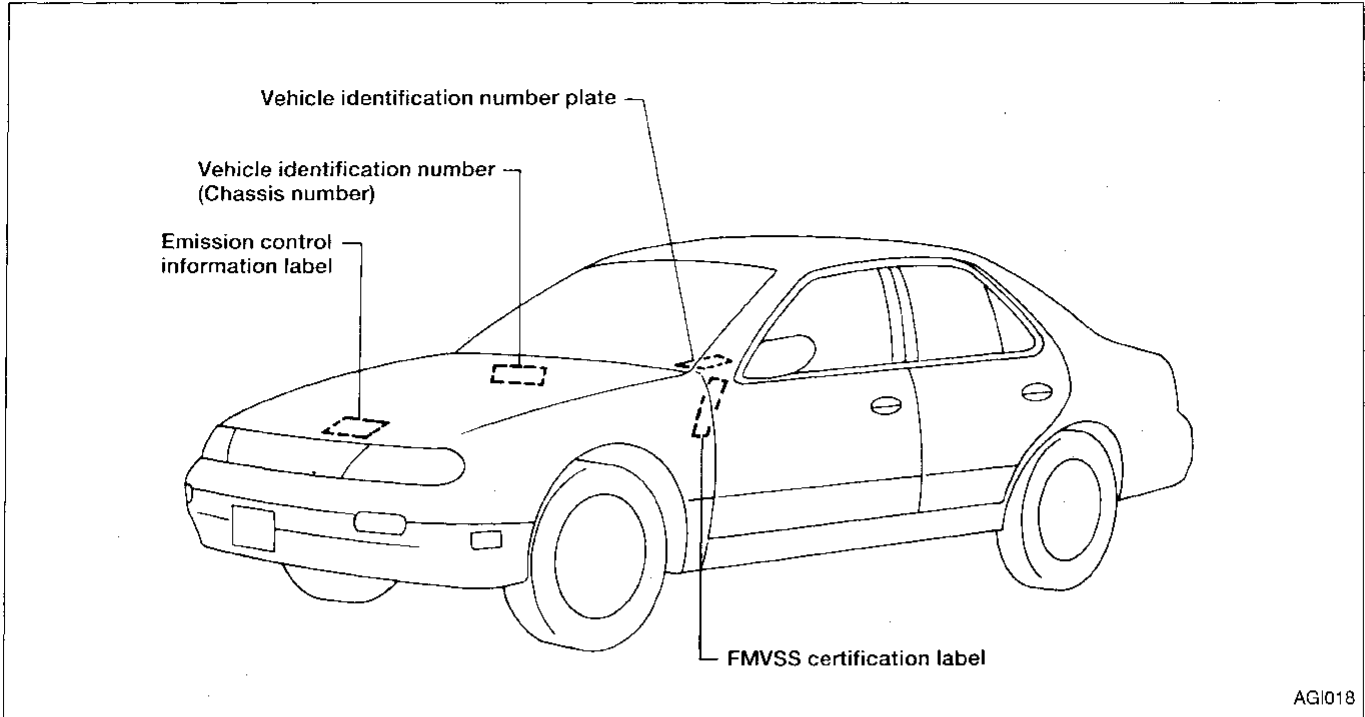

AGI018

VEHICLE IDENTIFICATION NUMBER ARRANGEMENT

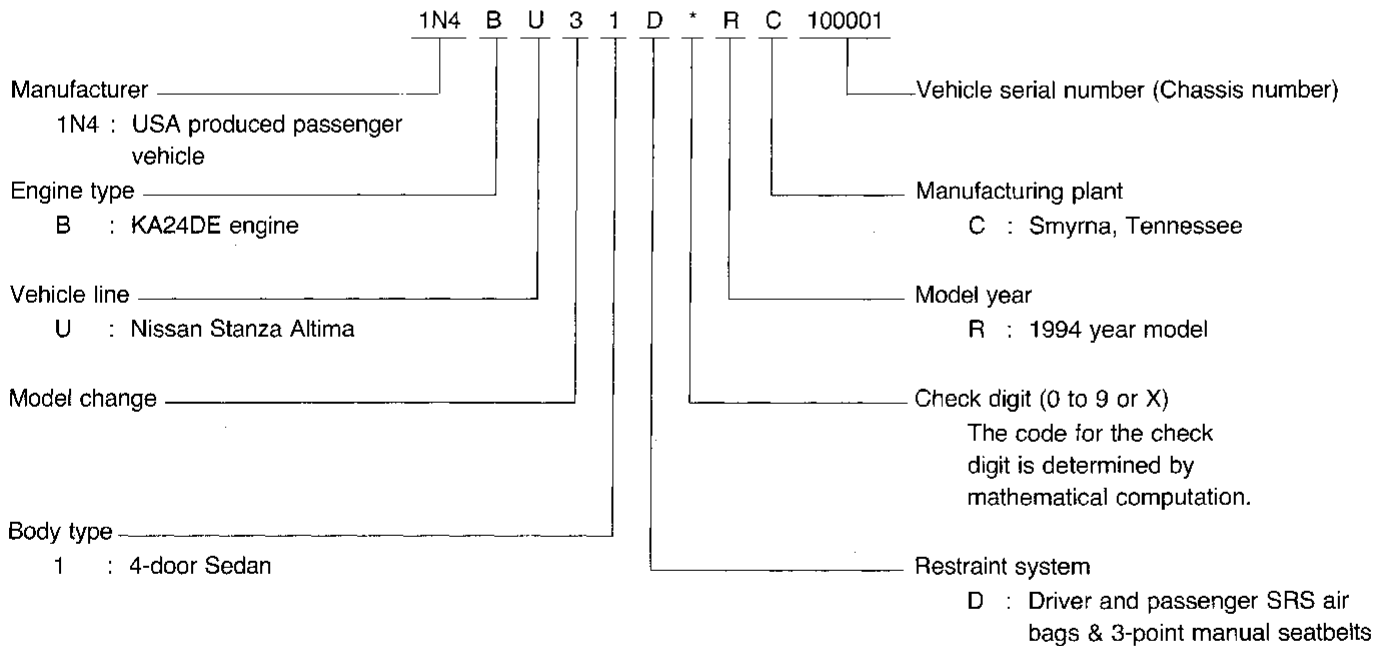

IDENTIFICATION INFORMATION

Identification Number (Cont'd)

ENGINE SERIAL NUMBER

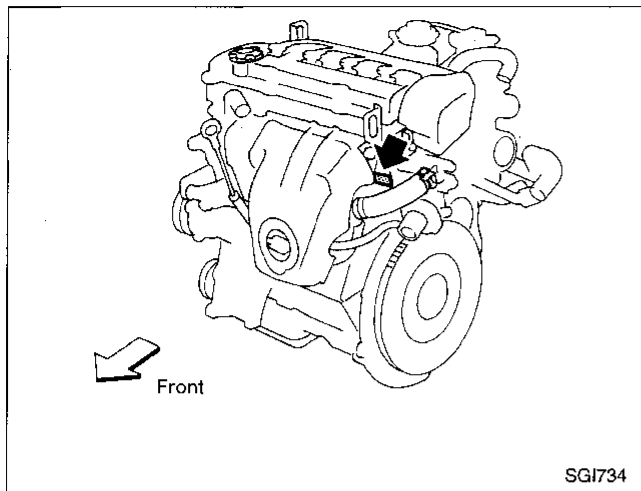

MANUAL TRANSAXLE NUMBER

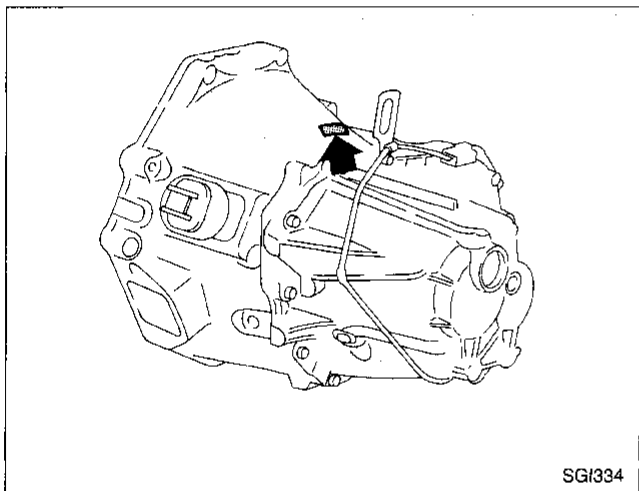

AUTOMATIC TRANSAXLE NUMBER

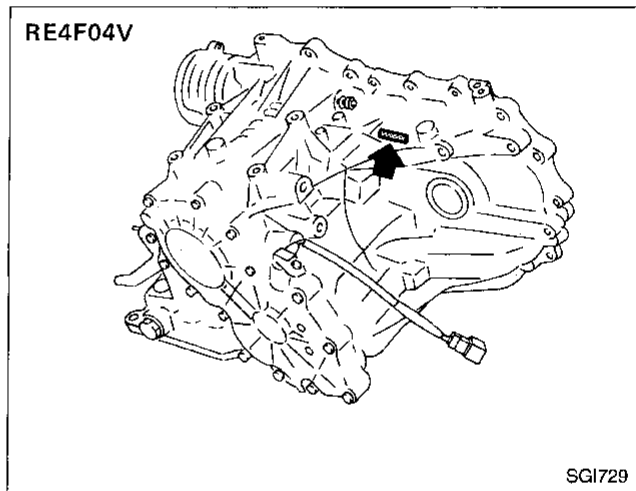

GI
MA
EM
LC
EF &
EC
FE
CL
MT
AT
FA
RA
BR
ST
BF
HA
EL
IDX

IDENTIFICATION INFORMATION

Dimensions

Unit: mm (in)

Overall length	4,585 (180.5)
Overall width	1,695 (66.7)
Overall height	1,420 (55.9)
Front tread	1,465 (57.7)
Rear tread	1,455 (57.3)
Wheelbase	2,620 (103.1)

Wheels and Tires

	Conventional	T type
Road wheel		
Steel	15 x 6JJ	15 x 4T
Aluminum	15 x 6JJ	15 x 4T
Offset mm (in)	45 (1.77)	40 (1.57)
Tire size	P205/60R15 90H	T125/70D15 T135/90D15*

* With viscous L.S.D.

LIFTING POINTS AND TOW TRUCK TOWING

Special Service Tools

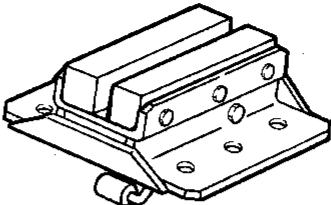
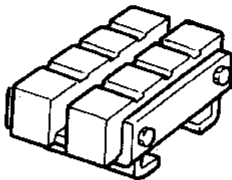
Tool number Tool name	Description	GI
LM4086-0200 Board-on lift attachment		MA EM LC
LM4519-0000 Safety stand attachment		EF & EC FE
		CL
		MT
		AT
		FA
		RA
		BR
		ST
		BF
		HA
		EL
		IDX

LIFTING POINTS AND TOW TRUCK TOWING

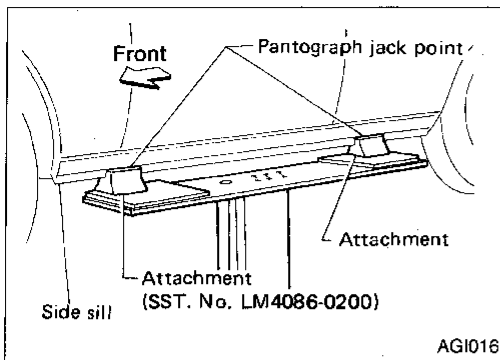

Board-on Lift

CAUTION:

Make sure vehicle is empty when lifting.

- The board-on lift attachment (LM4086-0200) set at front end of vehicle should be set on the front of the sill under the front door opening.
- Position attachments at front and rear ends of board-on lift.

Garage Jack and Safety Stand

WARNING:

- Never get under the vehicle while it is supported only by the jack. Always use safety stands when you have to get under the vehicle.
- Place wheel chocks at both front and back of the wheels on the ground.

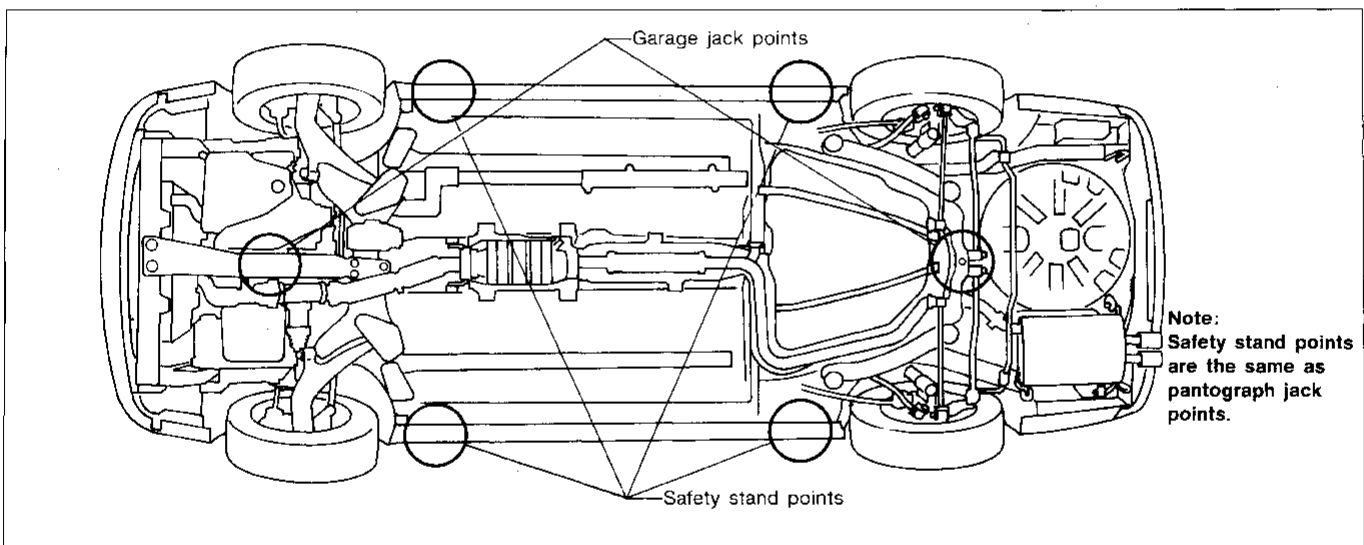

Use safety stand adapter as shown for stable support.

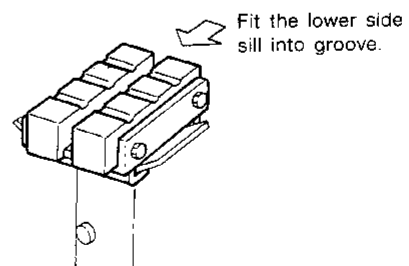
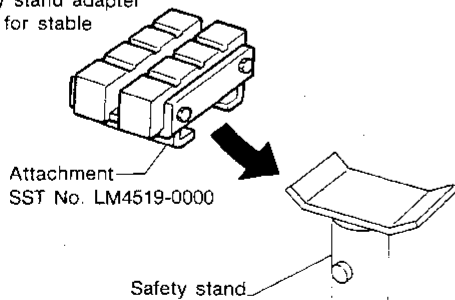

SGI737

LIFTING POINTS AND TOW TRUCK TOWING

2-pole Lift

WARNING:

When lifting the vehicle, open the lift arms as wide as possible and ensure that the front and rear of the vehicle are well balanced.

When setting the lift arm, do not allow the arm to contact the brake tubes and fuel lines.

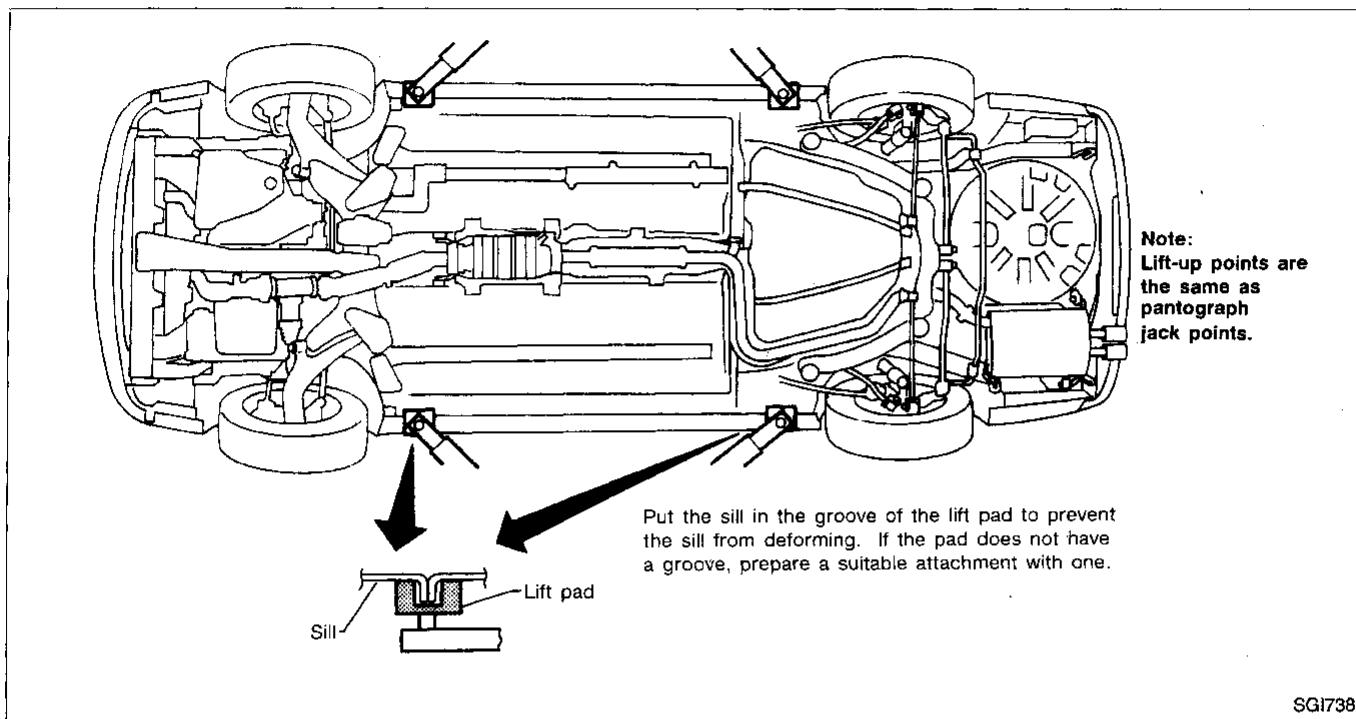

Tow Truck Towing

CAUTION:

- All applicable local laws regarding the towing operation must be obeyed.
- It is necessary to use proper towing equipment to avoid possible damage to the vehicle during a towing operation.
- When towing with the rear wheels on the ground, release the parking brake and move the gearshift lever to neutral position ("N" position).

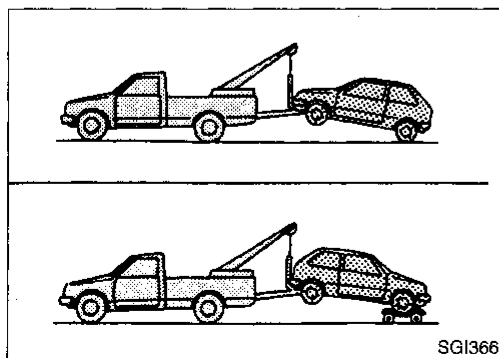

NISSAN recommends that vehicle be towed with the driving (front) wheels off the ground as illustrated.

GI
MA
EM
LC
EF &
EC
FE
CL
MT
AT
FA
RA
BR
ST
BF
HA
EL
IDX

LIFTING POINTS AND TOW TRUCK TOWING

Tow Truck Towing (Cont'd)

TOWING AN AUTOMATIC TRANSAXLE MODEL WITH FOUR WHEELS ON GROUND

Observe the following restricted towing speeds and distances.

Speed: Below 50 km/h (30 MPH)

Distance: Less than 65 km (40 miles)

CAUTION:

Never tow an automatic transaxle model from the rear (i.e., backward) with four wheels on the ground as this may cause serious and expensive damage to the transaxle.

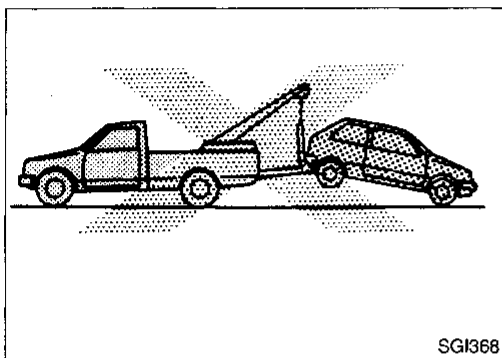

TOWING AN AUTOMATIC TRANSAXLE MODEL WITH REAR WHEELS RAISED (With front wheels on ground)

Never tow an automatic transaxle model with rear wheels raised (with front wheels on ground) as this may cause serious and expensive damage to the transaxle. If it is necessary to tow it with rear wheels raised, always use a towing dolly under the front wheels.

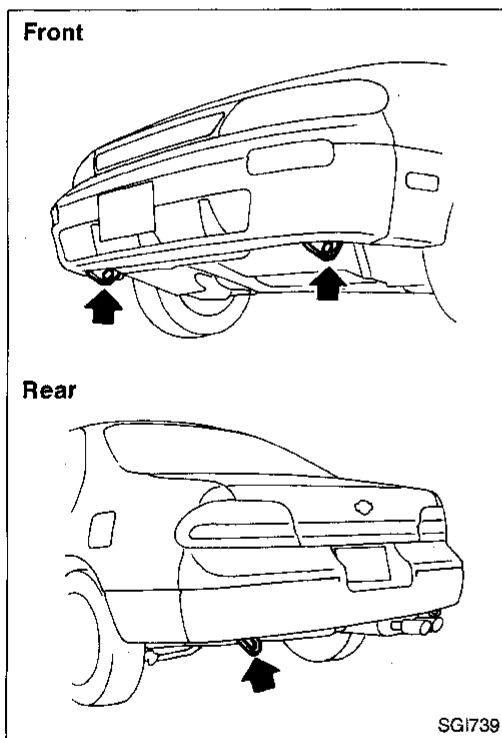

TOWING POINT

Always pull the cable straight out from the vehicle. Never pull on the hook at a sideways angle.

TIGHTENING TORQUE OF STANDARD BOLTS

Grade	Bolt size	Bolt diameter* mm	Pitch mm	Tightening torque (Without lubricant)					
				Hexagon head bolt			Hexagon flange bolt		
				N·m	kg-m	ft-lb	N·m	kg-m	ft-lb
4T	M6	6.0	1.0	5.1	0.52	3.8	6.1	0.62	4.5
	M8	8.0	1.25	13	1.3	9	15	1.5	11
			1.0	13	1.3	9	16	1.6	12
	M10	10.0	1.5	25	2.5	18	29	3.0	22
			1.25	25	2.6	19	30	3.1	22
	M12	12.0	1.75	42	4.3	31	51	5.2	38
1.25			46	4.7	34	56	5.7	41	
M14	14.0	1.5	74	7.5	54	88	9.0	65	
7T	M6	6.0	1.0	8.4	0.86	6.2	10	1.0	7
	M8	8.0	1.25	21	2.1	15	25	2.5	18
			1.0	22	2.2	16	26	2.7	20
	M10	10.0	1.5	41	4.2	30	48	4.9	35
			1.25	43	4.4	32	51	5.2	38
	M12	12.0	1.75	71	7.2	52	84	8.6	62
1.25			77	7.9	57	92	9.4	68	
M14	14.0	1.5	127	13.0	94	147	15.0	108	
9T	M6	6.0	1.0	12	1.2	9	15	1.5	11
	M8	8.0	1.25	29	3.0	22	35	3.6	26
			1.0	31	3.2	23	37	3.8	27
	M10	10.0	1.5	59	6.0	43	70	7.1	51
			1.25	62	6.3	46	74	7.5	54
	M12	12.0	1.75	98	10.0	72	118	12.0	87
1.25			108	11.0	80	137	14.0	101	
M14	14.0	1.5	177	18.0	130	206	21.0	152	

1. Special parts are excluded.
2. This standard is applicable to bolts having the following marks embossed on the bolt head.

Grade	Mark
4T	4
7T	7
9T	9

*: Nominal diameter

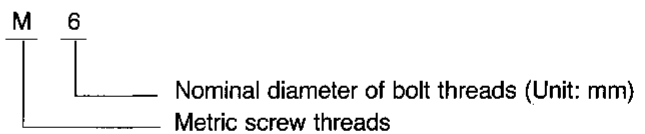

GLOSSARY

The “Glossary of Acronyms” and the “Glossary of Technical Terms and Component Part Names” Related to SAE J1930

The glossary is a list comprising the acronyms and technical terms that are described in SAE J1930 and original Nissan technical terms that were described in pre-1993 model year Service Manuals or are described in Parts Catalogs as part names.

This glossary is provided to indicate correspondence between acronyms and two kinds of technical terms. Thus, this glossary is not intended for use as a dictionary of components and their functions.

SAE J1930 ACRONYMS	SAE J1930 TECHNICAL TERMS	NISSAN TECHNICAL TERMS OR COMPONENT PART NAMES
A/C	Air Conditioning	Air Conditioner
ACL	Air Cleaner	Air Cleaner
AIR	Secondary Air Injection	Air Pump
AP	Accelerator Pedal	Accelerator Pedal
BARO	Barometric Pressure	Altitude Compensator & BCDD
B+	Battery Positive Voltage	Battery Voltage
CAC	Charge Air Cooler	Inter Cooler
CARB	Carburetor	Carburetor
CFI	Continuous Fuel Injection	—
CL	Closed Loop	Closed Loop and Closed Loop Control
CMP	Camshaft Position	Crankshaft Position
CPP	Clutch Pedal Position	Clutch Switch
CTOX	Continuous Trap Oxidizer	—
CTP	Closed Throttle Position	Idle Switch
DFI	Direct Fuel Injection	—
DI	Distributor Ignition	Ignition Timing Control
DLC	Data Link Connector	Diagnostic Connector for CONSULT or Diagnostic Connector
DTC	Diagnostic Trouble Code	Malfunction code or Code
DTM	Diagnostic Test Mode	Mode
ECM	Engine Control Module	ECCS Control Unit, Control Unit (EF & EC), ECU (ECCS Control Unit) or ECCS Control Unit (ECCS)
ECT	Engine Coolant Temperature	Engine Temperature Sensor, Engine Temperature or Coolant Temperature
EEPROM	Electrically Erasable Programmable Read Only Memory	ROM
EFE	Early Fuel Evaporation	Heat Control Valve Mixture Heater
EGR	Exhaust Gas Recirculation	Exhaust Gas Recirculation, Exhaust Gas Temperature Sensor, EGR System, EGR Valve, EGR Control Valve, BPT Valve or EGR Control Solenoid Valve
EI	Electronic Ignition	Ignition Timing Control
EM	Engine Modification	—
EPROM	Erasable Programmable Read Only Memory	ROM
EVAP	Evaporative Emission	Evaporative Emission Control System
FC	Fan Control	Radiator Fan Control or Condenser Fan Control

GLOSSARY

The "Glossary of Acronyms" and the "Glossary of Technical Terms and Component Part Names" Related to SAE J1930 (Cont'd)

GI

MA

EM

LC

EF &
EC

FE

CL

MT

AT

FA

RA

BR

ST

BF

HA

EL

IDX

SAE J1930 ACRONYMS	SAE J1930 TECHNICAL TERMS	NISSAN TECHNICAL TERMS OR COMPONENT PART NAMES
FEEPROM	Flash Electrically Erasable Programmable Read Only Memory	ROM
FEPRM	Flash Erasable Programmable Read Only Memory	ROM
FF	Flexible Fuel	—
FP	Fuel Pump	Fuel Pump
GEN	Generator	Alternator
GND	Ground	Ground or Earth
HO2S	Heated Oxygen Sensor	Exhaust Gas Sensor
IAT	Intake Air Temperature	—
ICM	Ignition Control Module	—
IFI	Indirect Fuel Injection	—
IFS	Inertia Fuel Shutoff	—
ISC	Idle Speed Control	FI Pot
KS	Knock Sensor	Detonation Sensor
MAF	Mass Air Flow	Air Flow Meter
MAP	Manifold Absolute Pressure	—
MC	Mixture Control	Air-Fuel Ratio Solenoid Valve
MDP	Manifold Differential Pressure	—
MIL	Malfunction Indicator Lamp	Check Engine Light
MFI	Multiport Fuel Injection	Fuel Injection Control
MST	Manifold Surface Temperature	—
MVZ	Manifold Vacuum Zone	—
NVRAM	Non-Volatile Random Access Memory	—
O2S	Oxygen Sensor	Exhaust Gas Sensor
OBD	On-Board Diagnostic	Self-diagnosis
OC	Oxidation Catalytic Converter	Catalyst
OL	Open Loop	Open Loop
PAIR	Pulsed Secondary Air Injection	AIV (Air Induction Valve)
PCM	Powertrain Control Module	—
PNP	Park/Neutral Position	Neutral Switch
PROM	Programmable Read Only Memory	ROM
PSP	Power Steering Pressure	—
PTOX	Periodic Trap Oxidizer	—
RAM	Random Access Memory	—
RM	Relay Module	—
ROM	Read Only Memory	ROM
RPM	Engine Speed	Engine Revolution or Engine rpm
SC	Supercharger	—
SCB	Supercharger Bypass	—
SFI	Sequential Multiport Fuel Injection	Sequential Injection
SPL	Smoke Puff Limiter	—

GLOSSARY

The "Glossary of Acronyms" and the "Glossary of Technical Terms and Component Part Names" Related to SAE J1930 (Cont'd)

SAE J1930 ACRONYMS	SAE J1930 TECHNICAL TERMS	NISSAN TECHNICAL TERMS OR COMPONENT PART NAMES
SRI	Service Reminder Indicator	—
SRT	System Readiness Test	—
ST	Scan Tool	—
TB	Throttle Body	Throttle Chamber or SPI Body
TBI	Throttle Body Fuel Injection	Fuel Injection Control
TC	Turbocharger	Turbocharger
TCC	Torque Converter Clutch	Lock-up Solenoid or Lock-up Cancel Solenoid
TP	Throttle Position	Throttle Sensor, Soft/Hard Idle Switch, Throttle Position of Throttle Valve Switch
TR	Transmission Range	—
TW	Thermal Vacuum Valve	Thermal Vacuum Valve (TVV)
TWC	Three Way Catalytic Converter	Catalyst
TWC + OC	Three Way + Oxidation Catalytic Converter	Catalyst
VAF	Volume Air Flow	Air Flow Meter
VR	Voltage Regulator	Voltage Regulator or IC Voltage Regulator
VSS	Vehicle Speed Sensor	Vehicle Speed Sensor
WOT	Wide Open Throttle	Full Switch or Full Throttle Switch
WU-OC	Warm Up Oxidation Catalytic Converter	Catalyst or Pre Cat
WU-TWC	Warm Up Three Way Catalytic Converter	Catalyst or Pre Cat
3GR	Third Gear	—
4GR	Fourth Gear	—

—: Not issued as NISSAN TECHNICAL TERMS OR COMPONENT PART NAMES