



WELLS-GARDNER ELECTRONICS CORPORATION

19" IN LINE COLOR MONITORS

MODELS

19K4901
19K4906

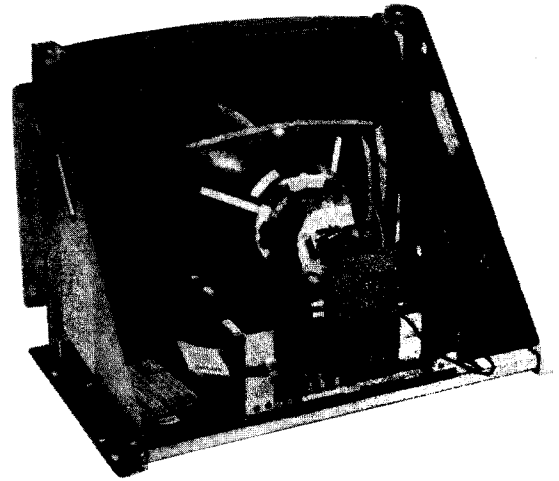
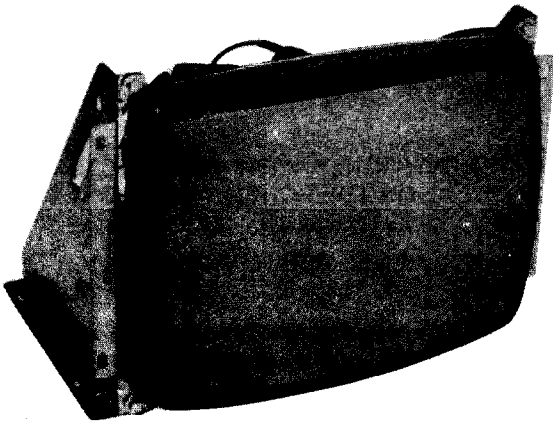

MODELS

19K4951
19K4956

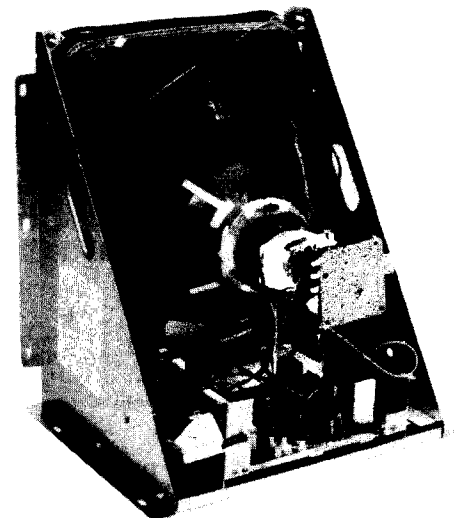
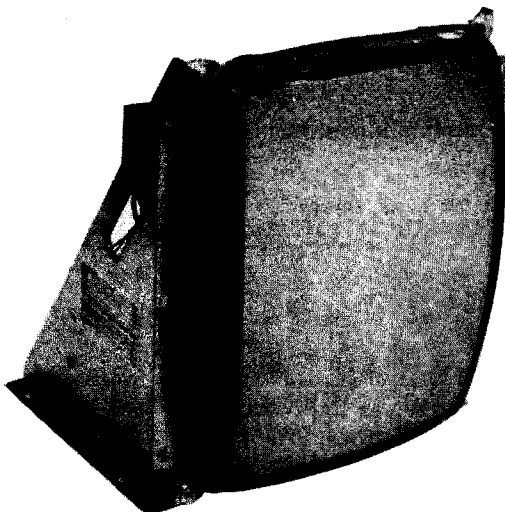

WELLS-GARDNER ELECTRONICS
CORPORATION

2701 NORTH KILDARE AVENUE
CHICAGO, ILLINOIS 60639

MONITOR 5-1

WARNINGS

1. Power Up Warning—

An isolation transformer must be used between the AC supply and the AC plug of the monitor before servicing or testing is performed since the chassis and the heat sink are directly connected to one side of the AC line which could present a shock hazard.

Before servicing is performed, read all the precautions labelled on the CRT and chassis.

2. **X-RAY RADIATION WARNING NOTICE**

WARNING: PARTS WHICH INFLUENCE X-RAY RADIATION IN HORIZONTAL DEFLECTION, HIGH VOLTAGE CIRCUITS AND PICTURE TUBE ETC. ARE INDICATED BY (★) IN THE PARTS LIST FOR REPLACEMENT PURPOSES. USE ONLY THE TYPE SHOWN IN THE PARTS LIST.

3. High Voltage—

This monitor contains HIGH VOLTAGES derived from power supplies capable of delivering LETHAL quantities of energy. Do not attempt to service until all precautions necessary for working on HIGH VOLTAGE equipment have been observed.

4. CRT Handling—

Care must be taken not to bump or scratch the picture tube as this may cause the picture tube to implode resulting in personal injury. Shatter proof goggles must be worn when handling the CRT. High voltage must be completely discharged before handling. Do not handle the CRT by the neck.

5. **PRODUCT SAFETY NOTICE**

WARNING: FOR CONTINUED SAFETY REPLACE SAFETY CRITICAL COMPONENTS ONLY WITH MANUFACTURER RECOMMENDED PARTS. THESE PARTS ARE IDENTIFIED BY SHADING AND BY (Δ) ON THE SCHEMATIC DIAGRAM.

AVERTISSEMENT: POUR MAINTENIR LE DEGRE DE SECURITE DE L'APPAREIL NE REMPLACER LES COMPOSANTS DONT LE FONCTIONNEMENT EST CRITIQUE POUR LA SECURITE QUE PAR DES PIECES RECOMMANDEES PAR LE FABRICANT.

For replacement purposes, use the same type or specified type of wire and cable, assuring the positioning of the wires is followed (especially for H.V. and power supply circuits). Use of alternative wiring or positioning could result in damage to the monitor or in a shock or fire hazard.

PERFORMANCE AND OPERATING DATA

1. Apply a suitable power source to the monitor through an isolation transformer.
2. Apply a suitable signal source to the monitor PCB by means of P201 and P202
3. Set Up Controls.

All controls are preset at the factory, but may be adjusted to suit program material.

1.0 Supply

Voltage	108 VAC-132 VAC
Frequency	50 Hz-60 Hz

Note: Apply supply voltage through an isolation transformer with 1 Amp. minimum capability.

2.0 High Voltage (EHT)

For 19"V models	24.3 ± 0.8 K.V. at 0 Beam;	22.8 ± 0.8 K.V. at 1 mA Beam
-----------------	----------------------------	------------------------------

Note: Condition for above: A.C. = 120V

3.0 Service Set-Up Controls

MAIN PC BOARD

- 3.1 Vertical Hold Control, VR301
- 3.2 Vertical Size Control, VR303
- 3.3 Horizontal Hold Control, VR351
- 3.4 Vertical Raster Position Adjustment Jumper (3 positions)
- 3.5 Horizontal Raster Position Adjustment Jumper (3 positions)
- 3.6 Screen Control (Part of H.V. Unit, T352)
- 3.7 Focus Control (Part of H.V. Unit, T352)

- 3.8 Horizontal Width Coil, L352
- 3.9 Black Level Control, VR201
- 3.10 Horizontal Video Position Control, (Horizontal Shift) VR352

NECK PC BOARD

- 3.11 Video Drive Controls, Red VR401
Green VR402
- 3.12 CRT Cut Off Controls, Red VR403
Green VR404
Blue VR405

SERVICE INSTRUCTIONS

NOTE: All monitors are equipped with automatic degaussing coils (L701) which demagnetize the picture tube every time the monitor is turned on after being off for a minimum of 5 minutes. Should any part of the chassis become magnetized it will be necessary to degauss the affected area with a manual degaussing coil. Move the coil slowly around the CRT face area and all surrounding metal parts. Then slowly withdraw for a distance of 6 feet before turning off.

1.0 BLACK LEVEL CONTROL ADJUSTMENT

This control has been set at the factory and should not need further attention, however, when the game is connected a slight adjustment of VR201 may be necessary to obtain the proper black level (the black portion of the picture just extinguished).

2.0 VERTICAL SIZE (HEIGHT)

Location of this control is shown in Fig. 1. This control must be adjusted slowly, if necessary, until the picture or test pattern attains the correct vertical proportions.

3.0 CIRCUIT PROTECTION

A 4.0A pigtail fuse, mounted on the Main Board has been provided to protect the Power Output Circuit.

4.0 FOCUS

Adjust the Focus control, located on the HV unit (T352), for maximum over-all definition and fine picture detail.

5.0 HORIZONTAL HOLD CONTROL ADJUSTMENT, VR351 (See Fig. 1)

A warm-up period of at least five minutes should be allowed before alignment is carried out. With the monitor being driven from the game signal, short TP601 to TP31. Adjust VR351 until the picture stops sliding horizontally. Remove the short.

6.0 HORIZONTAL VIDEO POSITION

If the video is off center on the raster some compensation can be made by adjusting this control.

7.0 VERTICAL RASTER POSITION ADJUSTMENT

If the video is off center vertically, (short dimension of picture tube) some compensation can be made by moving the vertical raster position adjustment jumper to either positions "U" or "D".

8.0 HORIZONTAL RASTER POSITION ADJUSTMENT

If the video is off center horizontally (long dimension of the picture tube) some compensation can be made by moving the horizontal raster position adjustment jumper to either positions "R" or "L".

9.0 HORIZONTAL WIDTH ADJUSTMENT

The horizontal width coil is a hexagonal tuning tool adjustment. This control must be adjusted slowly, if necessary, until the picture or test pattern attains the correct horizontal proportions.

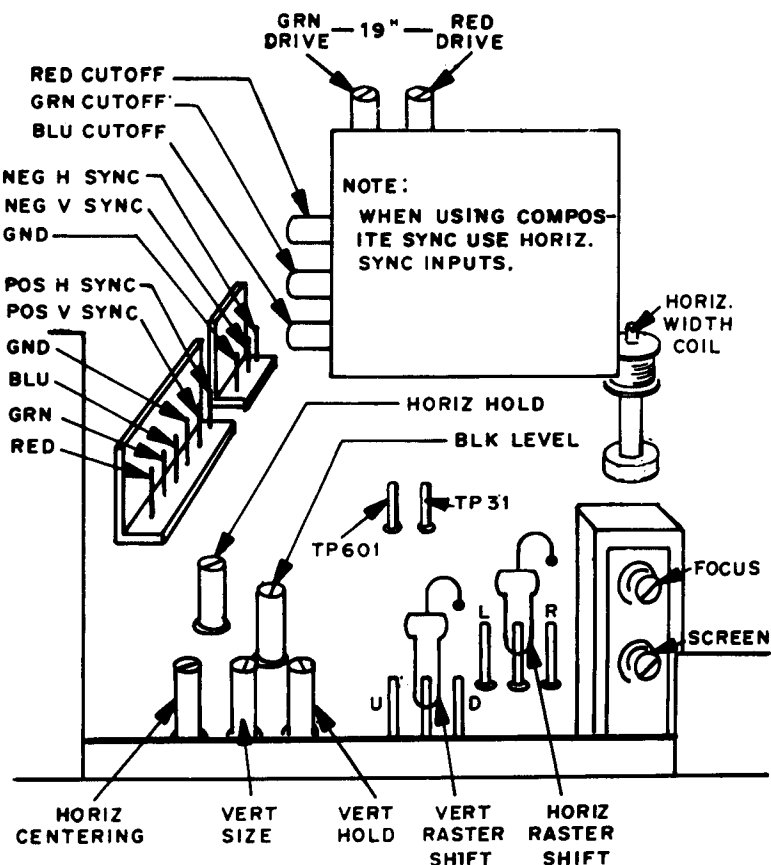

FIGURE 1

INSTALLATION AND SERVICE INSTRUCTIONS

NOTE: All of the following procedures have been performed at the factory and should require no further attention. If the monitor is serviced for any reason, it should be observed afterward to determine whether any of these procedures need to be performed again.

OUTLINE OF CONVERGENCE AND SET-UP PROCEDURE

- 1.0 Degaussing-Demagnetize the shadow mask and all surrounding metal parts with an external degaussing coil.
 - 2.0 Purity and Vertical Centering—Adjust the purity magnet and the yoke position.
 - 3.0 Static Convergence-Converge Red and Blue on Green in the center of the screen.
 - 4.0 Dynamic Convergence-Converge Red and Blue at the edges of the screen.
 - 5.0 White Balance-Set Gray and White brightness tracking.
- NOTE: Number 2.0 and 3.0 adjustments interact.

1.0 DEGAUSSING

The monitor is equipped with an automatic degaussing circuit. However, if the CRT shadow mask has become excessively magnetized, it may be necessary to degauss it with a manual coil. Do not switch the coil OFF while the raster shows any effect from the coil.

2.0 COLOR PURITY AND VERTICAL CENTERING ADJUSTMENT

- 2.1 For best results, it is recommended that the purity adjustment be made in the final monitor location. If the monitor will be moved, perform this adjustment with it facing west or east. The monitor must have been operating 15 minutes prior to this procedure.
- 2.2 Set the converger assembly on the CRT neck with the center line (of the Purity Adjustment Magnet) over the gap between grids no. 3 & 4. (See Figures 2 & 6)
- 2.3 Make certain that the magnetic ring-pairs are in their correct positions before starting procedure. This produces a zero-correction state and helps facilitate adjustments.
- 2.4 Vertical raster position adjustment jumper must be in position "C" (center).
- 2.5 Remove the R-G-B signal from the monitor.
- 2.6 Turn the Green Cut off Control (VR404) on the Neck Board fully CW. (See Fig. 3)
- 2.7 Turn the Red and Blue Cut off Controls (VR403 & VR405) fully CCW.
- 2.8 Pull the Deflection Yoke backward so that the Green belt will appear. (See Fig. 4)
- 2.9 Decrease the horizontal width of the raster, if necessary, in order to be able to see the right and left edges of the raster.
- 2.10 Move the two Purity Magnets with respect to each other in order to center the raster on the screen and the Green belt on the raster horizontally.
- 2.11 Push the Deflection Yoke forward gradually and fix it at the place where the Green screen becomes uniform throughout.
- 2.12 Turn the Cut off and Drive Controls and confirm that each color is uniform.
- 2.13 If the color is not uniform, re-adjust it moving the Purity Magnets slightly.
- 2.14 Decrease the vertical size of the raster, if necessary, such that the top and bottom raster edges can be seen.

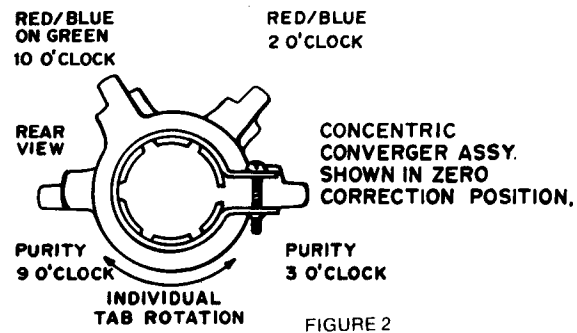
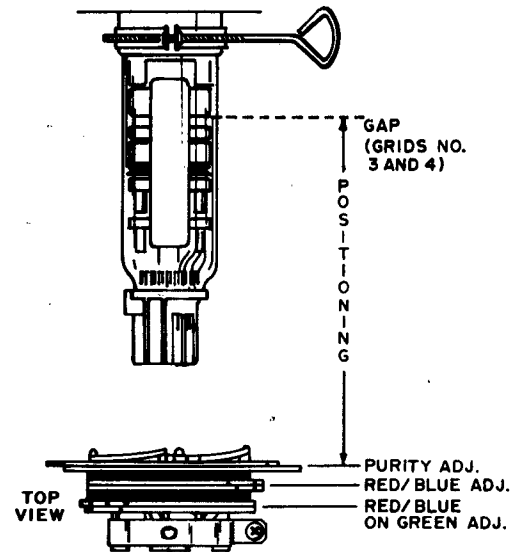

FIGURE 2

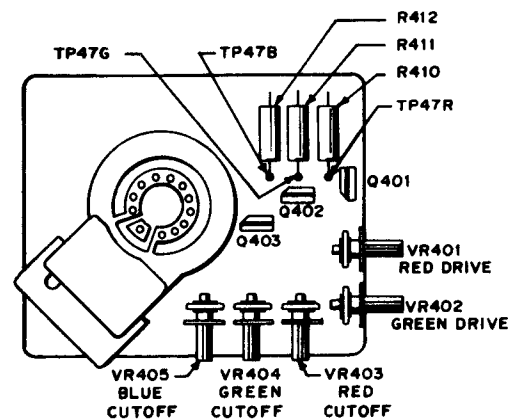

FIGURE 3

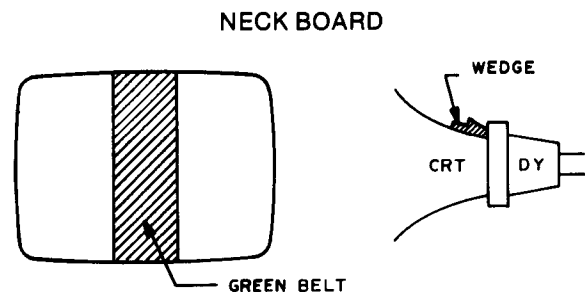

FIGURE 4

- 2.15 Rotate the Purity Magnets as a pair (without changing the angle of one magnet relative to the other) in order to center the raster on the screen vertically.
- 2.16 Readjust the raster to the desired vertical size.
- 2.17 Turn all three cut off controls fully counterclockwise (CCW). Slowly turn up (CW) the Red cutoff control until a Red raster is just barely visible.
- 2.18 Slowly turn up the Green and Blue cutoff controls such that their associated colors, mixing with the Red, results in a White or Gray raster.
- 2.19 Confirm that the white or gray color is uniform throughout the screen.
- 2.20 Insert a wedge temporarily as shown in Fig. 4 and adjust the angle of the Deflection Yoke.

3.0 STATIC CONVERGENCE ADJUSTMENT

4-Pole Magnets and 6-Pole Magnets are for static convergence.

- 3.1 A cross hatch signal should be connected to the monitor.
- 3.2 A pair of 4-Pole Convergence Magnets is provided and adjusted to converge the blue and red beams. (See Fig. 6) When the Pole opens to the left and right 45° symmetrically, the magnetic field maximizes. Red and blue beams move to the left and right. (See Fig. 5) Variation of the angle between the tabs adjusts the convergence of red and blue vertical lines.
- 3.3 When both 4-Pole Convergence Magnet Tabs are rotated as a pair, the convergence of the red and blue horizontal lines is adjusted.
- 3.4 A pair of 6-Pole Convergence Magnets is also provided and adjusted to converge the magenta (red + blue) to green beams. (See Fig. 6). When the Pole opens to the left and right 30° symmetrically, the magnetic field is maximized. Red and blue beams both move to the left and right (See Fig. 5). Variation of the opening angle adjusts the convergence of magenta to green vertical lines.
- 3.5 When both 6-Pole Convergence Magnet Tabs are rotated as a pair, the convergence of magenta to green horizontal lines is adjusted.

GREEN GUN IS THE CENTER GUN.
CONVERGE THE RED AND BLUE.
THEN CONVERGE RED AND BLUE ON GREEN.

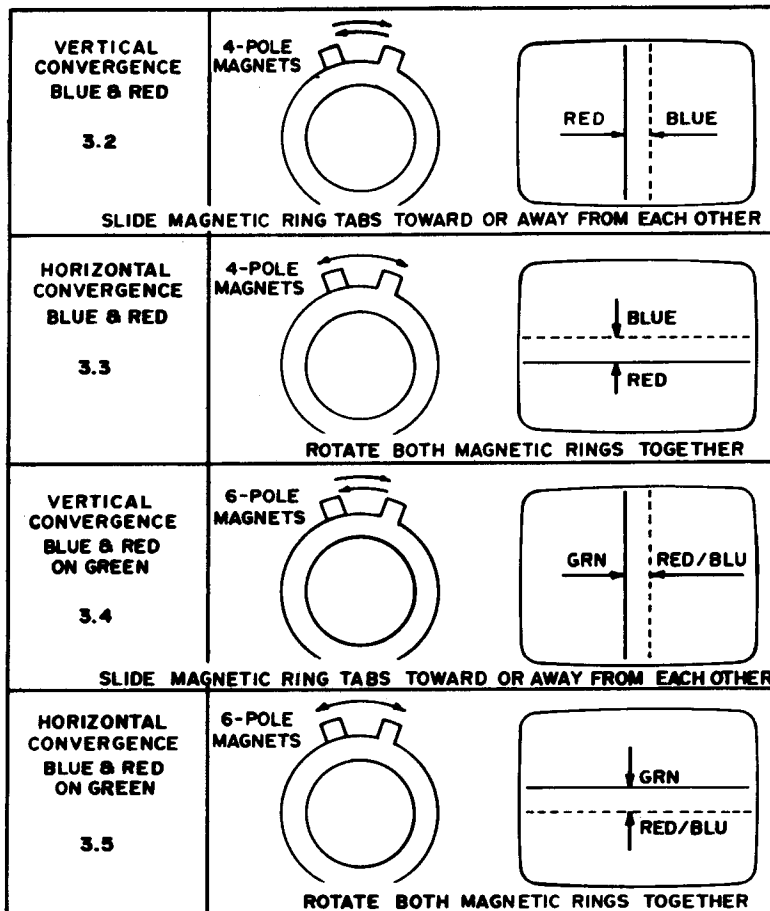

REPEAT 3.2 & 3.3 IF ALL LINES ARE NOT CONVERGED AT CENTER

5827

FIGURE 5

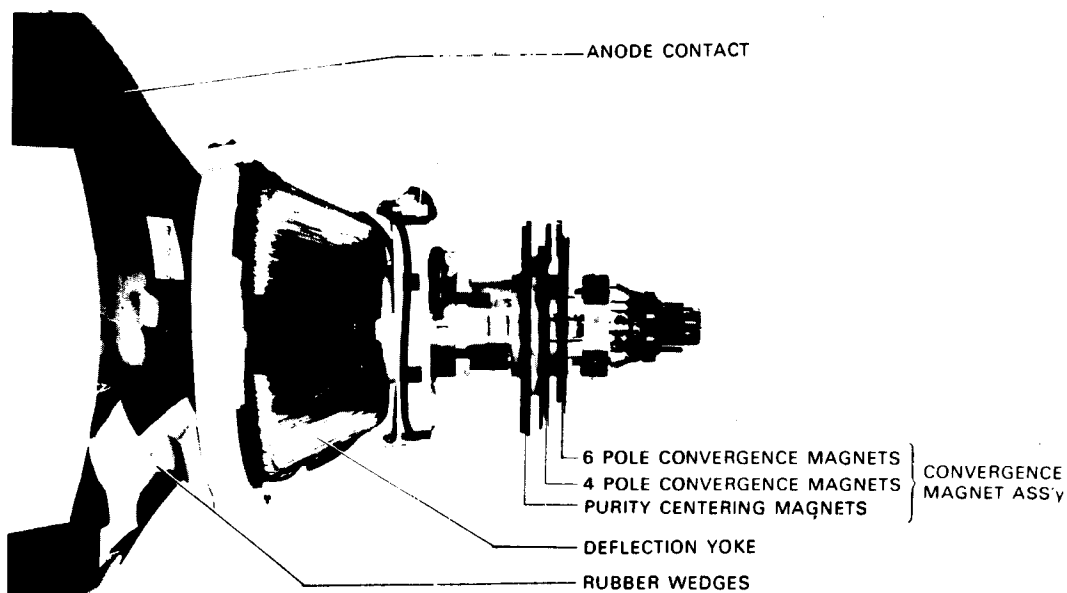

FIGURE 6

4.0 PRECISE ADJUSTMENT OF DYNAMIC CONVERGENCE (See Fig. 7, 8 and 9)

- 4.1 Feed a cross hatch signal to the monitor.
- 4.2 Insert a wedge temporarily and fix the Deflection Yoke so as to obtain the best circumference convergence (See Fig. 8 and 9)

NOTE:

The wedges may need to be moved during adjustments.

- 4.3 Insert three rubber wedges to the position as shown in Fig. 7 to obtain the best circumference convergence.

NOTE:

- 1) Tilting the angle of the yoke up and down adjusts the crossover of both vertical and horizontal red and blue lines. See Fig. 8 (a) and (b).
- 2) Tilting the angle of the yoke sideways adjusts the parallel convergence of both horizontal and vertical lines at the edges of the screen. See Fig. 9 (a) and (b).
- 3) Use three rubber wedges (tapered rubber wedges are used for a purpose).
- 4) The position of each rubber wedge is shown in Fig. 7.
- 5) Do NOT force the permanent wedges in. They are to be inserted until they just make contact with the yoke—after the yoke has been positioned.
- 6) Fix the three permanent rubber wedges with chloroprene rubber adhesive.
- 7) After the adhesive has dried enough to hold the wedges in place, carefully remove the temporarily installed wedge.

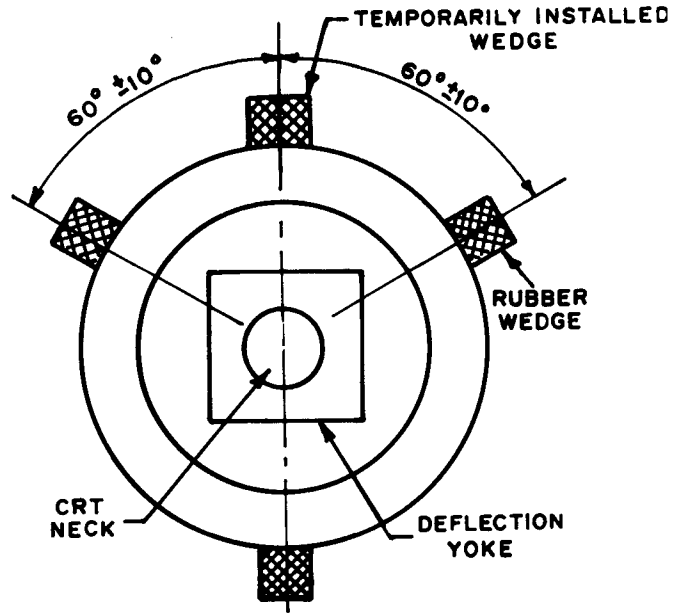
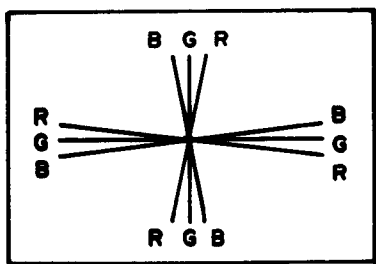
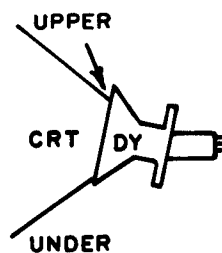

FIGURE 7



CRT SCREEN (a)



INSERT RUBBER WEDGE FROM UPPER SIDE

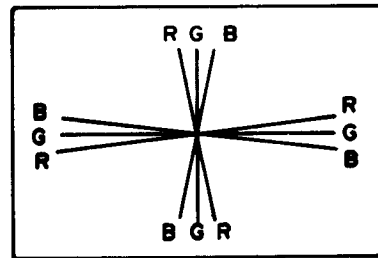

CRT SCREEN (b)

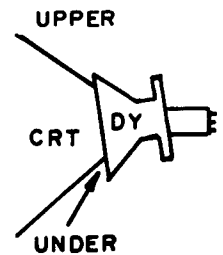

INSERT RUBBER WEDGE FROM LOWER SIDE

FIGURE 8

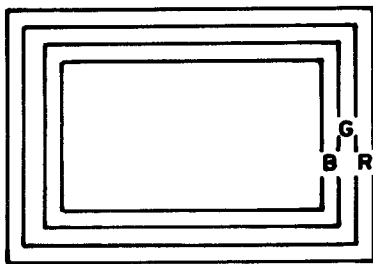

CRT SCREEN (a)

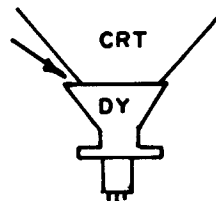

INSERT RUBBER WEDGE FROM LEFT SIDE

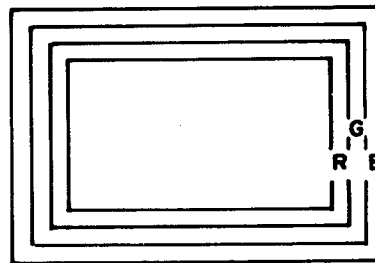

CRT SCREEN (b)

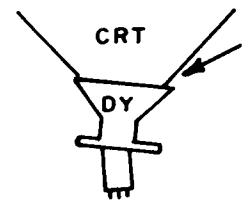

INSERT RUBBER WEDGE FROM LOWER SIDE

FIGURE 9

5.0 WHITE BALANCE

- 5.1 Refer to Fig. 2 and do the following in subdued light.
- 5.2 Ground the R/G/B inputs.
- 5.3 Set the R/G drive controls to their mechanical centers.
- 5.4 Set the screen and R/G/B cutoff controls to minimum (fully CCW).
- 5.5 Connect a jumper wire between TP301 and TP302 (located on the MAIN PCB)
- 5.6 Slowly turn up (CW) the screen control until the first colored line becomes just barely visible. That color which has just appeared is referred to as the "lead" color. Do NOT turn its associated cutoff control—it must remain fully CCW.
- 5.7 Connect a DC oscilloscope to the collector of the lead color's output transistor (Q401, Q402, or Q403) on the Neck PCB at TP47R, TP47G, or TP47B.
- 5.8 Adjust the black level control (VR201) to obtain the waveform shown in Fig. 10.
- 5.9 Readjust the screen control such that the colored line is just barely visible.
- 5.10 Slowly turn up the two remaining cutoff controls such that their associated colors, mixing with the lead color, results in a white or gray line.
- 5.11 Remove the jumper wire.
- 5.12 Adjust the Black Level Control for a dim raster. Touch up the two trailing cutoff controls (NOT the lead cutoff control) for best gray uniformity.
- 5.13 Adjust the Black Level Control for a bright raster. Adjust the R/G drive controls, if necessary for best neutral white.
- 5.14 Repeat steps 5.12 and 5.13 until good tracking of white balance is achieved.

BLANKING PULSES

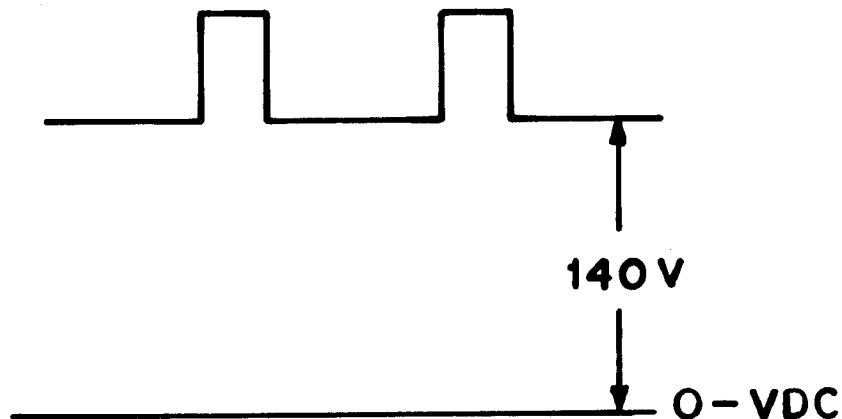

FIGURE 10

REPLACEMENT PARTS LIST

This monitor contains circuits and components included specifically for safety purposes.

For continued protection no changes should be made to the original design, and components shown in shaded areas of schematic, or Δ \star on parts list should be replaced with exact factory replacement parts.

The use of substitute parts may create a shock, fire, radiation or other hazard. Service should be performed by qualified personnel only.

MAIN BOARD

Ref. No.	Part No.	Description	Ref. No.	Part No.	Description
RESISTORS			RESISTORS (CONT.)		
R201	203X6500-645	1K Ohm, 5%, 1/4W Carbon	R369	203X5602-329	680K Ohm, 5%, 1/2W Comp.
R202	203X6500-523	30 Ohm, 5%, 1/4W Carbon	R370	203X6501-002	33K Ohm, 5%, 1/4W Carbon
R203	203X6500-405	100 Ohm, 5%, 1/4W Carbon	R371	203X9014-584	1K Ohm, 5%, 1W Metal Oxide
R204	203X6700-327	100 Ohm, 5%, 1/2W Carbon	R372	203X9101-119	12K Ohm, 5%, 1W Metal Oxide
R205	203X6700-421	270 Ohm, 5%, 1/2W Carbon	R375	203X6700-763	6.8K Ohm, 5%, 1/2W Carbon
R206	203X6500-540	390 Ohm, 5%, 1/4W Carbon	R376	203X9104-404	270 Ohm, 5%, 2W Metal Oxide
R207	340X2201-934	200 Ohm, 5%, 1/4W Carbon	R377	203X6500-447	150 Ohm, 5%, 1/4W Carbon
R208	203X6500-540	390 Ohm, 5%, 1/4W Carbon	R378	203X6500-886	10K Ohm, 5%, 1/4W Carbon
R209	340X2201-934	200 Ohm, 5%, 1/4W Carbon	R379	203X6500-886	10K Ohm, 5%, 1/4W Carbon
R210	203X6500-540	390 Ohm, 5%, 1/4W Carbon	R380	203X6500-865	8.2K Ohm, 5%, 1/4W Carbon
R211	340X2201-934	200 Ohm, 5%, 1/4W Carbon	R381	203X6500-724	2.2K Ohm, 5%, 1W Metal Oxide
R214	203X6500-645	1K Ohm, 5%, 1/4W Carbon	R383	203X9014-387	150 Ohm, 5%, 1W Metal Oxide
R215	203X6501-126	100K Ohm, 5%, 1/4W Carbon	R502	203X6500-886	10K Ohm, 5%, 1/4W Carbon
R216	203X6500-645	1K Ohm, 5%, 1/4W Carbon	R503	204X1700-535	150 Ohm, 5%, 15W Metal Oxide
R217	203X6500-405	100 Ohm, 5%, 1/4W Carbon	R504	203X9014-267	47 Ohm, 5%, 1W Metal Oxide
R218	203X6500-645	1K Ohm, 5%, 1/4W Carbon	R505	203X6501-209	2.2K Ohm, 5%, 1/4W Carbon
R219	203X6501-126	100K Ohm, 5%, 1/4W Carbon	R506	203X9104-105	15 Ohm, 5%, 2W Metal Oxide
R220	203X6500-645	1K Ohm, 5%, 1/4W Carbon	R507	203X5602-185	330K Ohm, 5%, 1/2W Comp.
R221	203X6500-405	100 Ohm, 5%, 1/4W Carbon	Δ \star R601	204X1625-058	3.3 Ohm, 5%, 10W WW
R222	203X6500-762	3.3 Ohm, 5%, 1/4W Carbon	R701	203X9105-141	2.2 Ohm, 5%, 2W Metal Oxide
R224	203X6500-169	10 Ohm, 5%, 1/4W Carbon	R702	203X6206-441	2.2 Ohm, 5%, 1/2W Carbon
R225	203X6500-169	10 Ohm, 5%, 1/4W Carbon	VR201	204X2070-072	2K Ohm-B Semi-Fixed
R226	203X6500-169	10 Ohm, 5%, 1/4W Carbon	VR301	204X2070-084	5K Ohm-B Semi-Fixed
R227	203X6501-044	47K Ohm, 5%, 1/4W Carbon	VR303	204X2070-055	500 Ohm-B Semi-Fixed
R228	203X6500-645	1K Ohm, 5%, 1/4W Carbon	VR351	204X2070-072	2K Ohm-B Semi-Fixed
R229	203X6700-421	270 Ohm, 5%, 1/2W Carbon	VR352	204X2070-072	2K Ohm-B Semi-Fixed
R230	203X6500-863	8.2K Ohm, 5%, 1/2W Comp.			
R231	203X6500-863	8.2K Ohm, 5%, 1/2W Comp.			
R232	203X6500-863	8.2K Ohm, 5%, 1/2W Comp.			
R233	203X6500-468	180 Ohm, 5%, 1/4W Carbon			
R234	340X2820-934	82 Ohm, 5%, 1/4W Carbon			
R235	340X2820-934	82 Ohm, 5%, 1/4W Carbon			
R236	340X2820-934	82 Ohm, 5%, 1/4W Carbon			
R301	203X6500-508	270 Ohm, 5%, 1/4W Carbon			
R302	203X6500-863	8.2K Ohm, 5%, 1/4W Carbon			
R303	203X6500-863	8.2K Ohm, 5%, 1/4W Carbon			
R304	203X6500-724	2.2K Ohm, 5%, 1/4W Carbon			
R305	203X6500-842	6.8K Ohm, 5%, 1/4W Carbon			
R306	203X6003-201	7.5K Ohm, 2%, 1/4W Carbon			
R307	203X6500-825	5.6K Ohm, 5%, 1/4W Carbon			
R309	203X6500-965	22K Ohm, 5%, 1/4W Carbon			
R310	203X6500-988	39K Ohm, 5%, 1/4W Carbon			
R311	203X6500-762	3.3K Ohm, 5%, 1/4W Carbon			
R312	203X9014-741	4.7K Ohm, 5%, 1/4W Carbon			
R313	204X1450-537	1K Ohm, 5%, 5W Carbon			
R314	203X6500-481	220 Ohm, 5%, 1/4W Carbon			
R315	203X6500-169	10 Ohm, 5%, 1/4W Carbon			
R316	203X6500-762	3.3K Ohm, 5%, 1/4W Carbon			
R317	203X6700-107	12 Ohm, 5%, 1/2W Carbon			
R318	203X6500-540	390 Ohm, 5%, 1/4W Carbon			
R319	203X6500-645	1K Ohm, 5%, 1/4W Carbon			
R320	203X6501-002	33K Ohm, 5%, 1/4W Carbon			
R321	203X6501-224	270K Ohm, 5%, 1/2W Carbon			
R322	203X6500-886	10K Ohm, 5%, 1/4W Carbon			
R351	203X6500-886	10K Ohm, 5%, 1/4W Carbon			
R352	203X6500-785	3.9K Ohm, 5%, 1/4W Carbon			
R353	203X6501-088	68K Ohm, 5%, 1/4W Carbon			
R354	203X6500-762	3.3K Ohm, 5%, 1/4W Carbon			
R355	203X9205-143	6.8K Ohm, 5%, 3W Metal Oxide			
R358	203X5601-878	56K Ohm, 5%, 1/2W Carbon			
R360	203X6500-561	470 Ohm, 5%, 1/4W Carbon			
R361	203X6500-886	10K Ohm, 5%, 1/4W Carbon			
R362	203X9014-645	1.8K Ohm, 5%, 1W Metal Oxide			
\star R363	204X1527-751	3.9K Ohm, 5%, 7W Metal Oxide			
R364	203X6500-246	22 Ohm, 5%, 1/4W Carbon			
R365	203X6501-002	33K Ohm, 5%, 1/4W Carbon			
R367	203X6500-886	10K Ohm, 5%, 1/4W Carbon			
R368	203X5602-185	330K Ohm, 5%, 1/2W Comp.			
			C201	203X0014-088	1000 uF, 16V, Electrolytic
			C202	202X7200-064	330 pF, 500V, Ceramic
			C203	202X7200-043	220 pF, 500V, Ceramic
			C204	202X7200-043	220 pF, 500V, Ceramic
			C205	203X0014-076	470 uF, 16V, Electrolytic
			C206	203X1810-149	0.1 uF, 125V Mylar
			C207	349X2232-109	.022 uF, 100V Mylar
			C301	203X0014-065	330 uF, 50V Electrolytic
			C302	203X1600-563	0.033 uF, 50V Mylar
			C303	203X0629-037	3.3 uF, 50V Electrolytic
			C304	203X1600-366	0.068 pF, 50V Mylar
			C306	203X0412-012	2.2 uF, 16V Tantal
			C307	203X1600-634	0.033 uF, 50V Mylar
			C308	203X0025-174	3.3 uF, 50V Electrolytic
			C309	203X1207-100	0.068 uF, 100V PP
			C310	203X0629-061	10 uF, 100V Electrolytic
			C311	203X0041-025	10 uF, 160V Electrolytic
			C312	202X7050-248	1000 pF, 500V Ceramic
			C313	203X0040-052	47 uF, 160V Electrolytic
			C314	203X1201-265	0.033 uF, 200V PP
			C315	203X0629-023	1 uF, 50V Electrolytic
			C351	203X0629-023	1 uF, 50V Electrolytic
			C352	203X0619-045	47 uF, 25V Electrolytic
			C353	203X1190-015	0.0082 pF, 50V Mylar-PP
			C354	203X0619-045	47 uF, 25V Electrolytic
			C355	203X1600-366	0.0068 pF, 50V Mylar
			C356	202X7050-483	0.01 uF, 500V Ceramic
			C359	202X8065-606	100 pF, 500V Ceramic
			C360	202X7050-366	0.0033 pF, 500V Ceramic
			C361	202X7050-483	0.01 uF, 500V Ceramic
			C362	202X7203-032	0.01 uF, 50V Ceramic
			Δ \star C363	203X1270-911	8700 pF, 1.5 KV PP
			\star C365	203X1201-265	0.33 uF, 200V PP
			C366	203X0019-026	22 uF, 25V Electrolytic
			C367	202X8065-162	6 pF, 500V Ceramic
			C368	202X7203-032	0.01 uF, 50V Ceramic
			C372	203X1207-125	0.1 uF, 100V PP

MAIN BOARD (CONT.)

Ref. No.	Part No.	Description
CAPACITORS (CONT.)		
C380	202X7200-087	470 uF, 500V Ceramic
△ C501	203X1810-149	0.1 uF, 125V Mylar
△ C502	202X7050-282	1500 pF, 500V Ceramic
△ C503	202X7810-214	2200 pF, 125V Ceramic
△ C504	202X7810-214	2200 pF, 125V Ceramic
C505	203X0220-075	560 uF, 200V Electrolytic
C506	203X0040-034	22 uF, 160V Electrolytic
C507	203X0041-057	47 uF, 160V Electrolytic
C701	203X0019-092	1000 uF, 25V Electrolytic
C702	203X0634-061	10 uF, 100V Electrolytic
C703	202X7050-248	1000 pF, 500V Ceramic

SEMICONDUCTORS

D203	201X2010-159	Diode, IS2076-27
D204	201X2010-159	Diode, IS2076-27
D205	201X2010-159	Diode, IS2076-27
D206	201X2010-159	Diode, IS2076-27
D207	201X2010-159	Diode, IS2076-27
D208	201X2010-159	Diode, IS2076-27
D209	201X2010-159	Diode, IS2076-27
D301	201X2010-165	Diode, ISS81
D302	201X2010-159	Diode, IS2076-27
D303	201X2010-159	Diode, IS2076-27
D304	201X2120-009	Diode, RH-IV
D305	201X2120-009	Diode, RH-IV
D306	201X2010-159	Diode, IS2076-27
△ D501	201X3120-216	Diode, RM-1AV
△ D502	201X3120-216	Diode, RM-1AV
△ D503	201X3120-216	Diode, RM-1AV
△ D504	201X3120-216	Diode, RM-1AV
D505	201X3120-216	Diode, RM-1AV
D506	201X3120-216	Diode, RM-1AV
D701	201X2130-234	Diode, RU-2V
D702	201X2120-009	Diode, RH-1V
Q201	200X3181-523	Transistor (NPN) 2SC1815GR
Q202	200X3181-523	Transistor (NPN) 2SC1815GR
Q203	200X4056-260	Transistor (PNP) 2SA562-Y-TM
Q204	200X4056-260	Transistor (PNP) 2SA562-Y-TM
Q205	200X4056-260	Transistor (PNP) 2SA562-Y-TM

Ref. No.	Part No.	Description
SEMICONDUCTORS (CONT.)		
Q206	200X3181-523	Transistor (NPN) 2SC1815GR
Q207	200X3181-523	Transistor (NPN) 2SC1815GR
Q208	200X3181-523	Transistor (NPN) 2SC1815GR
Q209	200X3181-523	Transistor (NPN) 2SC1815GR
Q210	200X3181-523	Transistor (NPN) 2SC1815GR
Q301	200X3181-523	Transistor (NPN) 2SC1815GR
Q302	200X3207-306	Transistor (NPN) 2SC2073LBGL2
Q303	200X3207-306	Transistor (NPN) 2SC2073LBGL2
Q351	200X3248-217	Transistor (NPN) 2SC2482BK
Q352	200X4589-802	Transistor (NPN) 2SD898B
IC301	200X2300-033	IC HA11423
△ ★ IC501	200X2600-183	IC STR381

TRANSFORMERS & COILS

L351	201X4710-134	Coil, (RF Choke)
L352	201X5000-083	Coil, Horiz. Size
L701	611X0004-007	Coil, Adg.
T351	202X1300-080	Transformer, Hor. Drive
△ ★ T352	200X9720-301	HV-Unit M-11

MISCELLANEOUS

△ F501	204X7120-073	Fuse, 4 Amp. 125V
J402	206X5008-632	Recep W Wire 3P-M-BG
P201	204X9600-466	Plug, PWB 3P-J
P202	204X9601-477	Plug, PWB 6P-Q
P401	204X9600-298	Plug, PWB 4P-B
P501	204X9600-249	Plug, PWB 2P-B
P601	204X9600-304	Plug, PWB 4P-C
TH501	201X0100-112	Thermistor

FINAL ASSEMBLY PARTS

△ ★ 88X0138-506	19VLTP22 Pix Tube
205X9800-158	Lateral/Purity Assembly
△ ★ 202X1111-201	Yoke Deflection
204X9301-255	CRT Socket
291X5004-262	Automatic Degaussing Coil Unit

NECK BOARD

RESISTORS

R401	203X6000-729	220 Ohm, 5% 1/4W Carbon
R402	203X6500-540	390 Ohm, 5% 1/4W Carbon
R403	203X6000-661	820 Ohm, 5% 1/4W Carbon
R404	203X6000-729	220 Ohm, 5% 1/4W Carbon
R405	203X6500-540	390 Ohm, 5% 1/4W Carbon
R406	203X6000-661	820 Ohm, 5% 1/4W Carbon
R407	203X6000-729	470 Ohm, 5% 1/4W Carbon
R408	203X6000-998	270 Ohm, 5% 1/4W Carbon
R409	203X6000-661	820 Ohm, 5% 1/4W Carbon
R410	203X9104-824	15K Ohm, 5% 2W M.O. Forming
R411	203X9104-824	15K Ohm, 5% 2W M.O. Forming
R412	203X9104-824	15K Ohm, 5% 2W M.O. Forming
R413	203X6000-998	2.7K Ohm, 5% 1/2W Comp.
R414	203X6000-998	2.7K Ohm, 5% 1/2W Comp.
R415	203X6000-998	2.7K Ohm, 5% 1/2W Comp.
R416	203X9105-154	2.2 Ohm, 5% 2W Metal Oxide
R419	203X6500-741	2.7K Ohm, 5% 1/4W Carbon
R420	203X6500-741	2.7K Ohm, 5% 1/4W Carbon
R421	203X6500-741	2.7K Ohm, 5% 1/4W Carbon
VR401	204X2115-014	500 Ohm, -B Semi-Fixed
VR402	204X2115-014	500 Ohm, -B Semi-Fixed
VR403	204X2115-006	5K Ohm, -B Semi-Fixed
VR404	204X2115-006	5K Ohm, -B Semi-Fixed
VR405	204X2115-006	5K Ohm, -B Semi-Fixed

CAPACITORS

C401	202X7050-269	1200 pF, 500V Ceramic
C402	202X7050-248	1000 pF, 500V Ceramic
C403	202X7050-248	1000 pF, 500V Ceramic
C404	202X7050-282	1500 pF, 1.5KV Ceramic
C405	202X7050-483	0.01 uF, 500V Ceramic

SEMICONDUCTORS

Q401	200X3206-800	Transistor (NPN) 2SC2068LB
Q402	200X3206-800	Transistor (NPN) 2SC2068LB
Q403	200X3206-800	Transistor (NPN) 2SC2068LB

MISCELLANEOUS

J401	206X5009-296	RECEP W Wire 4P-E
P402	204X9600-254	Plug, PWB 3P-A
P403	204X9600-981	Plug, Pin 1P-D
P701	204X9601-020	Plug, PWB 4P-E

P.C. BOARD LAYOUT

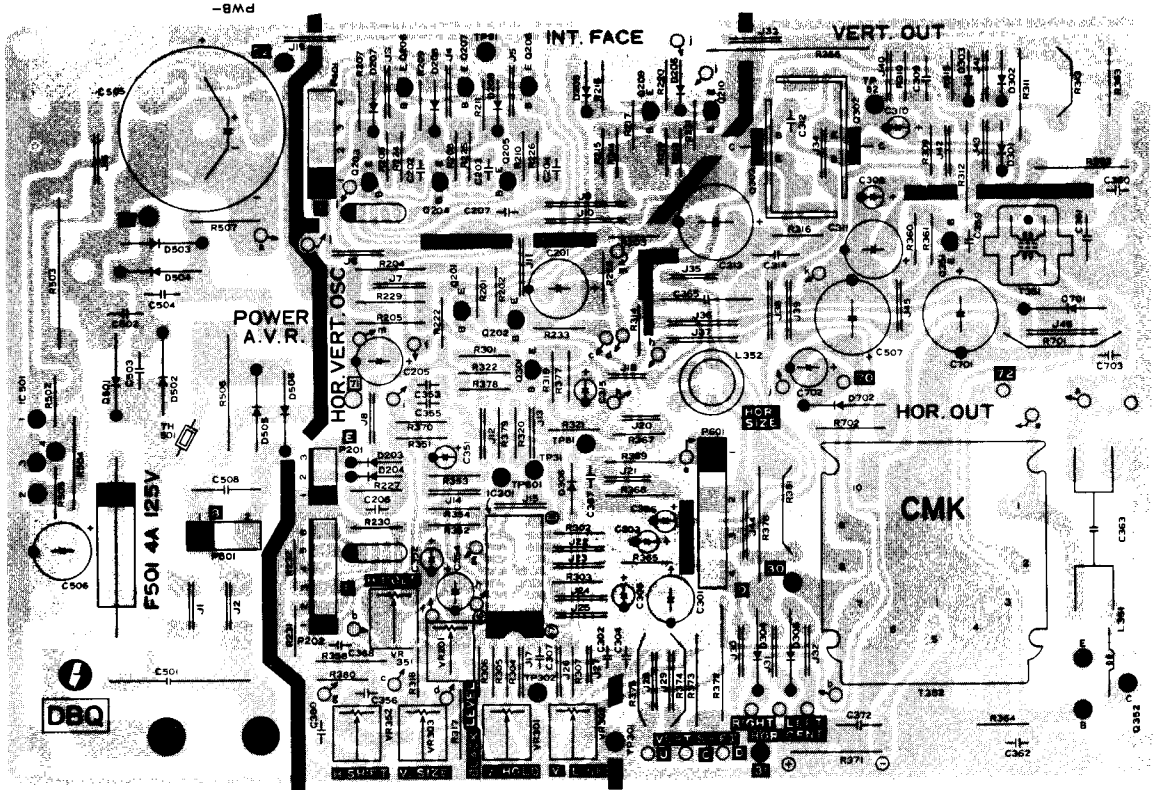

TOP VIEW

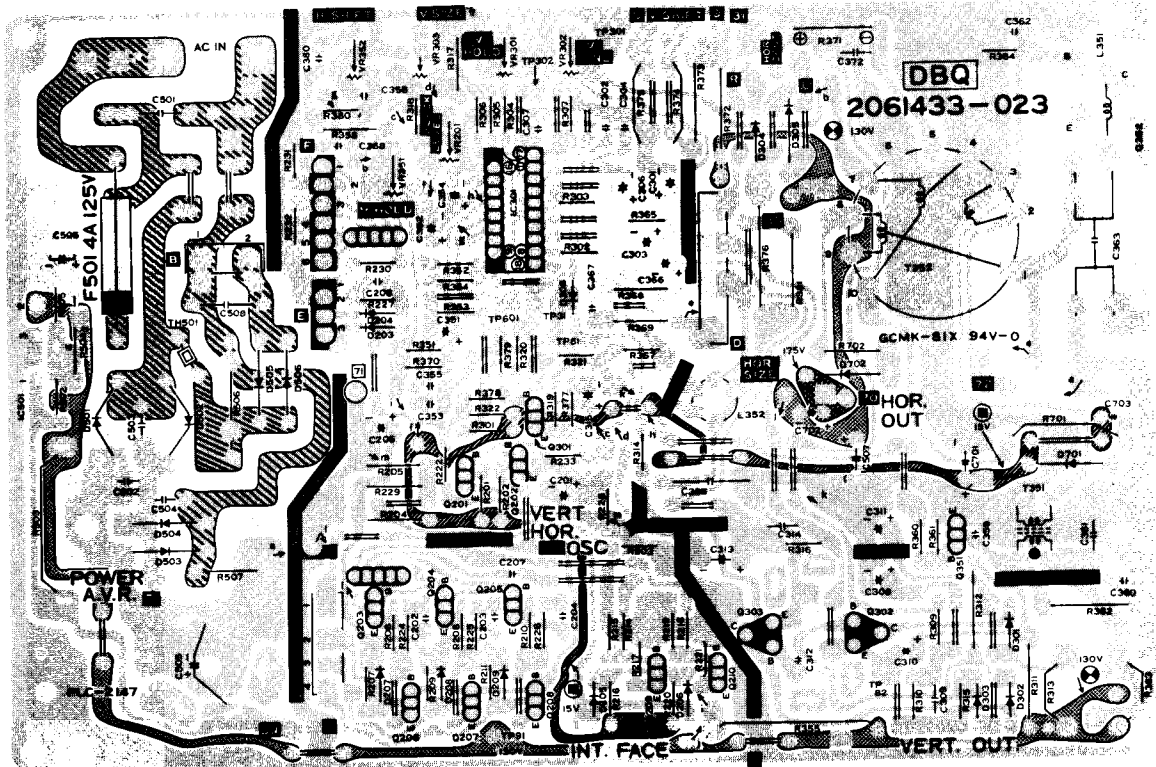

BOTTOM VIEW

FIGURE 11 MAIN P.C. BOARD

P.C. BOARD LAYOUT

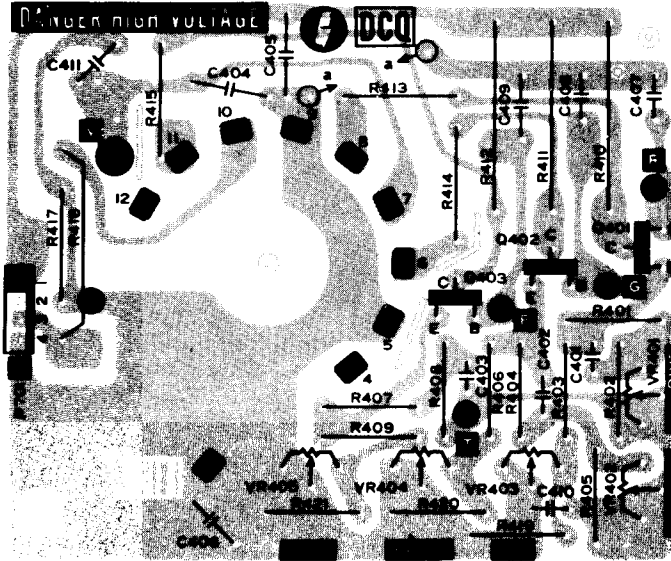

TOP VIEW

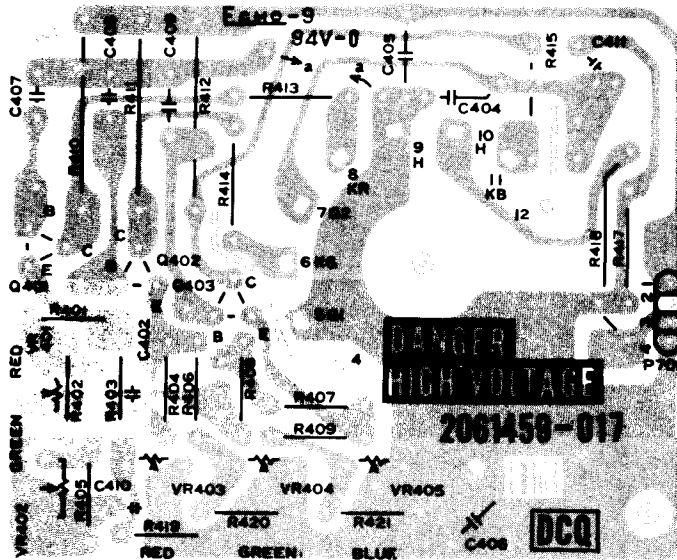

BOTTOM VIEW

FIGURE 12 NECK P.C. BOARD

TYPICAL DC VOLTAGES

TRANSISTOR NO.	TERMINAL		
	COLLECTOR	BASE	EMITTER
Q201	8.1	0.43	0.36
Q202	9.8	8.1	9.3
Q203	0	0.35	1.0
Q204	0	0.35	1.0
Q205	0	0.35	1.0
Q206	9.7	5.5	4.8
Q207	9.7	5.5	4.8
Q208	9.7	5.5	4.8
Q209	15.4	-0.30	0.01
Q210	14.0	0.31	0.17
Q301	15.5	4.7	4.2
Q302	79	37.8	37.7
Q303	37	0.51	0
Q351	41.4	0.41	0
Q352	DO NOT MEASURE	-0.03	0
Q401	139	9.7	9.3
Q402	139	9.7	9.3
Q403	139	9.7	9.3

I.C. 301	
PIN NO.	VOLTAGE
1	1.16
2	4.0
3	6.8
4	3.9
5	12.1
6	4.1
7	4.1
8	1.9
9	12.2
10	14.2
11	3.6
12	7.9
13	6.8
14	12.8
15	1.52
16	0
17	0.83
18	0

I.C. 501	
PIN NO.	VOLTAGE
1	163
2	130
3	0
4	132

Power Supply Voltage and Symbols

Symbol	Voltage	Operating Circuit
	15V	Vert. Osc. Sync Blanking CRT Cut-Off
	130V	Horiz. Osc. Horz. Drive Horz. Output Vert. Output
	175V	Video Output

OSCILLOSCOPE WAVEFORM PATTERN

The waveforms shown are as observed on the wide band oscilloscope with the monitor turned to a reasonably strong signal and a normal picture. The voltages shown on each waveform are the approximate peak amplitudes.

If the waveforms are observed on the oscilloscope with a poor high frequency response, the corner of the pulses will tend to be more rounded than those shown and the amplitude of any high frequency pulse will tend to be less.

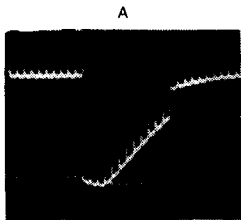

1V/DIV 200uSEC/DIV

TP-31 DC COUPLED
BOTTOM LINE = 0 VDC



20V/DIV 10uSEC/DIV

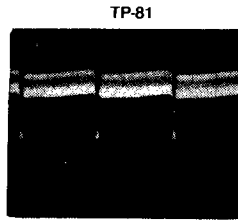

0.5/DIV 5MSEC/DIV

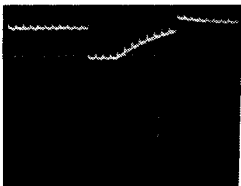

2V/DIV 200MSEC/DIV

I.C. 301, PIN 3

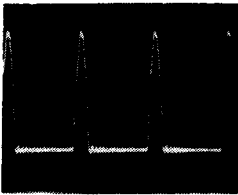

5V/DIV 20uSEC/DIV

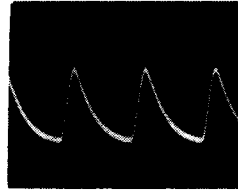

0.5/DIV 20u SEC/DIV



1V/DIV 5MSEC/DIV

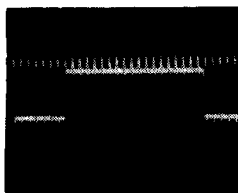

1V/DIV 20u SEC/DIV



1V/DIV 10uSEC/DIV



20V/DIV 5MSEC/DIV

I.C. 301, PIN 13

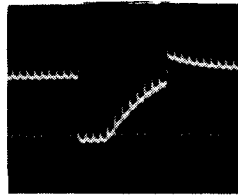

1V/DIV 200uSEC/DIV

NEGATIVE SIDE OF C303

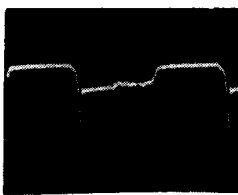

2V/DIV 10uSEC/DIV

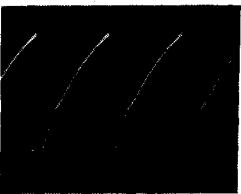

1VDIV 200uSEC/DIV

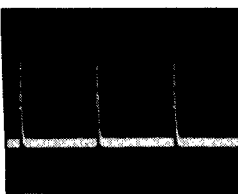

2V/DIV 5MSEC/DIV

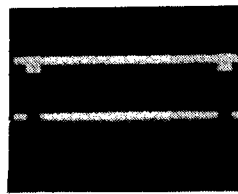

1VDIV 2MSEC/DIV



CAUTION: FOR CONTINUED SAFETY, REPLACE SAFETY CRITICAL COMPONENTS ONLY WITH MANUFACTURER'S RECOMMENDED PARTS.
AVERTISSEMENT: POUR MAINTENIR LE DEGRE DE SECURITE DE L'APPAREIL NE REMPLACER LES COMPOSANTS DONT LE FONCTIONNEMENT EST CRITIQUE POUR LA SECURITE QUE PAR DES PIECES RECOMMANDEES PAR LE FABRICANT.



**SERVICE TECHNICIAN WARNING
X-RAY RADIATION PRECAUTION:**

THIS PRODUCT CONTAINS CRITICAL ELECTRICAL AND MECHANICAL PARTS ESSENTIAL FOR X-RAY RADIATION PROTECTION. FOR REPLACEMENT PURPOSES, USE ONLY TYPE PARTS SHOWN IN THE PARTS LIST.

19" COLOR MONITOR SCHEMATIC DIAGRAM

Power Supply Voltage and Symbols

Symbol	Voltage	Operating Circuit
●	15V	Vert. Osc. Sync Blanking CRT Cut-Off
⊙	130V	Horiz. Osc. Horz. Drive Horz. Output Vert. Output
○	175V	Video Output

CAUTION: FOR CONTINUED SAFETY, REPLACE SAFETY CRITICAL COMPONENTS ONLY WITH MANUFACTURER'S RECOMMENDED PARTS.
AVERTISSEMENT: POUR MAINTENIR LE DEGRE DE SECURITE DE L'APPAREIL NE REMPLACER LES COMPOSANTS DONT LE FONCTIONNEMENT EST CRITIQUE POUR LA SECURITE QUE PAR DES PIECES RECOMMANDEES PAR LE FABRICANT.

SERVICE TECHNICIAN WARNING
X-RAY RADIATION PRECAUTION:

THIS PRODUCT CONTAINS CRITICAL ELECTRICAL AND MECHANICAL PARTS ESSENTIAL FOR X-RAY RADIATION PROTECTION.
 FOR REPLACEMENT PURPOSES, USE ONLY TYPE PARTS SHOWN IN THE PARTS LIST.

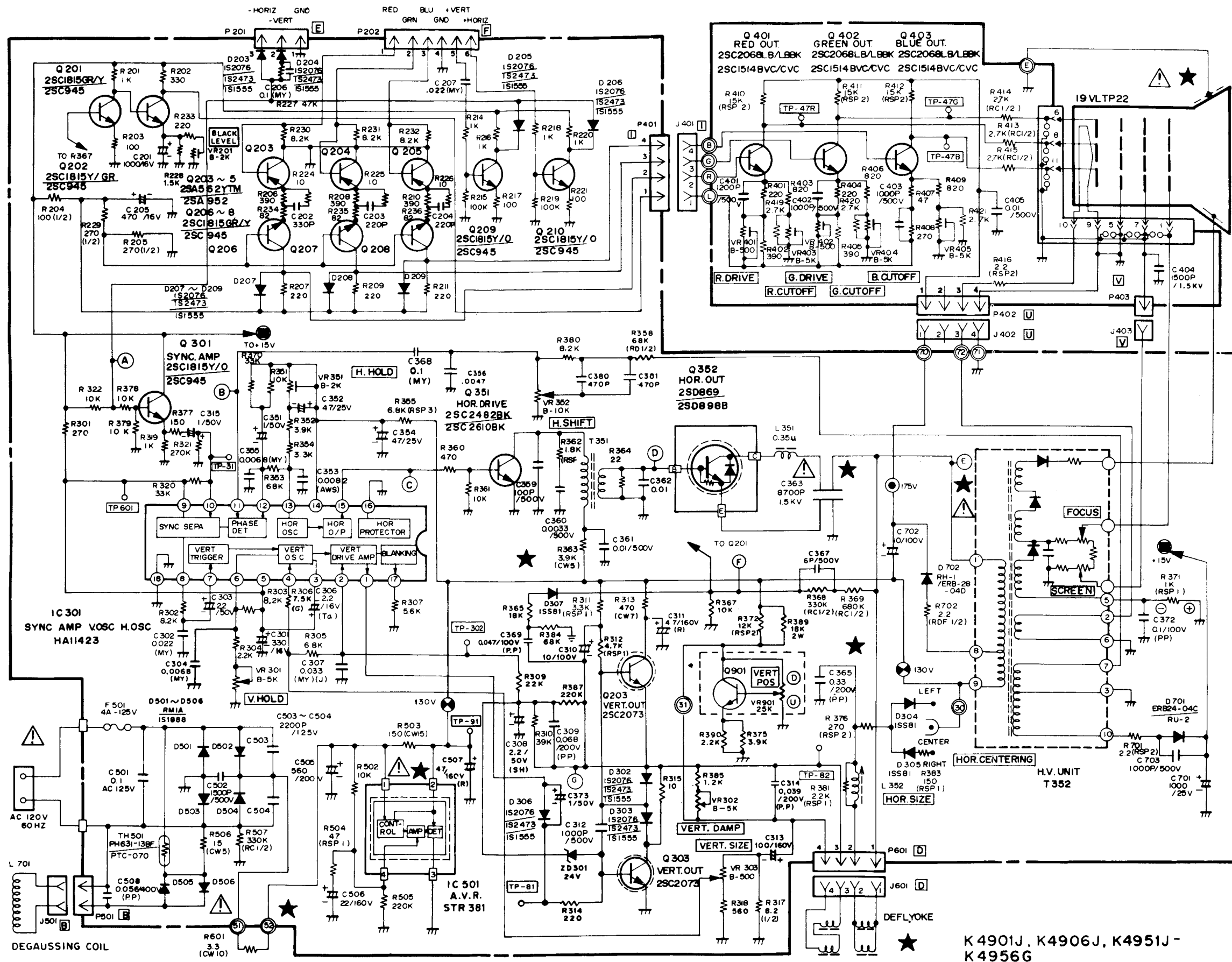

K 4901J, K 4906J, K 4951J - K 4956G