

COCKTAIL TABLE

**centuri** inc.  
MANUAL NO. 901-2159

SERVICES MANUAL

Time Pilot

Time Pilot

Time Pilot

Time Pilot

Time Pilot

Time Pilot

Time Pilot

# TIME PILOT

## Cocktail Manual

CENTURI, INC.

245 W. 74TH PLACE

HIALEAH, FLA. 33014

CUSTOMER SERVICE:

TEL. #(305) 558-5200 (IN FLORIDA)

TEL. #(800) 327-7710 (OUTSIDE FLORIDA)

TELEX: 803694 ANSB CENTURI CABLE: CENTURI

"TIME PILOT" COCKTAIL TABLE

TABLE OF CONTENTS

I.	INTRODUCTION:	PAGE NO.
	USER INFORMATION-----	1
	NOTES-----	2
	FRONT VIEW, CABINET (FIGURE 1)-----	3
	FRONT VIEW CABINET, PARTS LIST FOR FIG. 1-----	4
	GAME DESCRIPTION SUMMARY-----	5,6
II.	OPERATION:	
	GAME INSTRUCTIONS AND POINT SCORING-----	7
	OPTIONAL SWITCH SETTINGS-----	8,9
	INSTALLATION & ELECTRICAL REQUIREMENTS-----	10
	110/220 VAC CONVERSION INSTRUCTIONS-----	11
	110/220 VAC INTERCONNECT DIAGRAM, FIG. 2 (#386-10-0300)-----	12
	ROUTINE MAINTENANCE & SERVICE, POWER SUPPLY-----	13
III.	GAME PART DRAWINGS, PART LISTS & SCHEMATICS:	
	EXPLODED VIEW OF JOYSTICK ASS'Y, FIG. 3-----	14
	EXPLODED VIEW OF JOYSTICK, PARTS LIST-----	15
	EXPLODED VIEW OF CONTROL PANEL & PARTS LIST, FIG. 4-----	16
	COMPUTER & LOGIC BOARD, PARTS LIST (#010-4552)-----	17,18
	SOUND BOARD, PARTS LIST (#010-4553)-----	19,20
	PSR-5110 SWITCHING POWER SUPPLY, SCHEMATICS (#50350006)-----	21,22
	PSR-5110 SWITCHING POWER SUPPLY, PARTS LIST (#50350006)-----	23,24
	CABINET INTERIOR VIEW & PARTS LIST-----	25
	C.P.U. HARNESS, SCHEMATIC (#008-4875)-----	26
	C.P.U. HARNESS, PARTS LIST (#008-4875)-----	27
	CONTROL PANEL HARNESS (#008-4877)-----	28
	CABINET POWER HARNESS (#378-12-0200A)-----	29
	C.P.U. & LOGIC BOARD COMPONENTS LAYOUT, SCHEMATIC-----	30
	C.P.U. BOARD (KT-5207-1B), SCHEMATIC (#905-4897)-----	31
	SOUND BOARD (KT-5112-2B), SCHEMATIC (#905-4898)-----	32
	SOUND BOARD COMPONENTS LAYOUT, SCHEMATIC-----	33

USER INFORMATION - F.C.C.

WARNING

THIS EQUIPMENT GENERATES, USES, AND CAN RADIATE RADIO FREQUENCY ENERGY, AND IF NOT INSTALLED AND USED IN ACCORDANCE WITH THE INSTRUCTION MANUAL, MAY CAUSE INTERFERENCE TO RADIO COMMUNICATIONS. AS TEMPORARILY PERMITTED BY REGULATION, IT HAS NOT BEEN TESTED FOR COMPLIANCE PURSUANT TO SUBPART J OF PART 15 OF F.C.C. RULES, WHICH ARE DESIGNED TO PROVIDE REASONABLE PROTECTION AGAINST SUCH INTERFERENCE. OPERATION OF THIS EQUIPMENT IN A RESIDENTIAL AREA IS LIKELY TO CAUSE INTERFERENCE IN WHICH CASE, THE USER AT HIS OWN EXPENSE WILL BE REQUIRED TO TAKE WATEVER MEASURES MAY BE REQUIRED TO CORRECT THE INTERFERENCE.

## INTRODUCTION

"T.PILOT" IS A MICROPROCESSOR BASED COIN-OPERATED ELECTRONIC GAME, THAT MAKES EXTENSIVE USE OF DIGITAL INTEGRATED CIRCUITRY AND TELEVISION MONITOR CONCEPTS. THIS MANUAL IS DESIGNED FOR THE USE OF MAINTENANCE TECHICIANS WHO POSSESS A GENERAL WORKING KNOWLEDGE OF SOLID-STATE CIRCUITRY, AND VIDEO MONITOR THEORY. ANY INDIVIDUAL NOT KNOWLEDGEABLE IN THESE AREAS SHOULD NOT ATTEMPT REPAIR OF THE ELECTRONIC PORTIONS OF THE GAME.

IN ADDITION TO THIS MANUAL AND TRAINING IN ELECTRONICS, TROUBLE-SHOOTING AND REPAIR WILL BE FACILITATED BY ACCESS TO GENERAL-TYPE HANDTOOLS, A MULTIMETER, A 50 OR 100 MHZ OSCILLOSCOPE AND A LOGIC PROBE WOULD BE HELPFUL.

TECHNICAL ASSISTANCE IS AVAILABLE BY CALLING (305) 558-5200. QUESTIONS OR COMMENTS CONCERNING "T.PILOT" OR ANY OF OUR GAMES ARE WELCOME AND SHOULD BE DIRECTED TO:

CENTURI, INC.

CUSTOMER SERVICE DEPARTAMENT

#800-327-7710 (OUTSIDE THE STATE OF FLA.)

#305-556-5888 (IN FLORIDA)

## NOTES

NEVER REPLACE ANY COMPONENTS WITH ANYTHING OTHER THAN EXACT REPLACEMENT PARTS.

NEVER REMOVE CIRCUIT BOARD CONNECTIONS WHILE POWER IS ON.

DO NOT REPLACE THE FUSE WITH ANYTHING OTHER THAN THE PROPER VALUE.

A BLOWN FUSE INDICATES AN OVERLOAD CONDITION WITHIN THE GAME. REPLACING THE FUSE WITH A HIGHER VALUE CAN CAUSE SEVERE DAMAGE TO INTERNAL COMPONENTS IF AN OVERLOAD OCCURS.

ALWAYS CONSULT THE MANUAL BEFORE ATTEMPTING REPAIRS.



(FIG.1) FRONT VIEW OF CABINET.

"TIME PILOT" CABINET, COCKTAIL TABLE

(FIGURE 1)

PARTS LIST

<u>ITEM</u>	<u>CENTURI P/N:</u>	<u>DESCRIPTION:</u>
1.	802-3104	TOP GLASS SILKSCREENED
2.	702-1201	GSI-8 POSITION JOYSTICK ASSY
3.	301-2517	CONTROL PANEL
4.	-----	FIRE BUTTON
5.	-----	2-PLAYER START BUTTON
6.	-----	1-PLAYER START BUTTON
7.	009-4683	COIN ACCEPTOR/START SW. ASSY

## "TIME PILOT"

### GAME DESCRIPTION

Continuing with its policy of producing high quality games, Centuri, Inc. adds to its successful line, "TIME PILOT."

Centuri incorporates into this game all the elements of sight and sound necessary to attract a player of any skill level.

The player controls his plane with the 8 way joystick and shoots at the enemies using "Fire" button. "TIME PILOT" consists of 5 different rounds of play which are as follows:

#### ROUND 1:

A.D. 1910 - The age of Biplane

The attackers are biplanes coming from random directions. Enemy plane shoots at your plane and throws hand grenades when close to you. After 56 biplanes are destroyed, the "Mother-Ship" appears: a giant airballoon shooting at you! Only 7 hits will destroy the "Mother-Ship." During the same stage, one to five parachutes will appear. Dock with them for bonus points.

#### ROUND 2:

A.D. 1940 - The age of Monoplane

Enemies are: monoplane fighters, middle size bombers and large bomber ("Mother-Ship"). Middle size bombers are aiming constantly at your plane! It could be destroyed by 4 hits and awards 1,500 points.

#### ROUND 3:

A.D. 1970 - The age of Helicopter

Enemies now are helicopters and large one ("Mother-Ship"). As a new level of difficulty, the helicopters are using homing missiles.

#### ROUND 4:

A.D. 1982 - The age of Jetplane

The enemies are modern jet fighters shooting and launching homing missiles. A modern large jet bomber is the "Mother-Ship." This is one of the most difficult rounds of the game due to increased speed of jet fighters and random direction attacks.

#### ROUND 5:

A.D. 2001 - The age of U.F.O.

Hard to be reached and very hard to be passed. Great number of U.F.O.'s are attacking from any direction changing their angles of attack and throwing at your plane two types of "Alien Weapons." The stage is fast paced and the "Mother-Ship", a superfortress U.F.O., can not be so easily destroyed.



## DIP SWITCH SETTINGS

The following Dip Switches for the Game "TIME PILOT" are found on the C.P.U. Board. The settings are a guide in selecting optional game format.

### DIP 1 SW SET

#### 1 COIN 1 SW SET

SW	1	2	3	4	COIN	PLAY
	OFF	OFF	OFF	OFF	1	1
	ON	OFF	OFF	OFF	1	2
	OFF	ON	OFF	OFF	1	3
	ON	ON	OFF	OFF	1	4
	OFF	OFF	ON	OFF	1	5
	ON	OFF	ON	OFF	1	6
	OFF	ON	ON	OFF	1	7
	ON	ON	ON	OFF	2	1
	OFF	OFF	OFF	ON	2	3
	ON	OFF	OFF	ON	2	5
	OFF	ON	OFF	ON	3	1
	ON	ON	OFF	ON	3	2
	OFF	OFF	ON	ON	3	4
	ON	OFF	ON	ON	4	1
	OFF	ON	ON	ON	4	3
	ON	ON	ON	ON	FREE PLAY	

#### 2 COIN 2 SW SET

SW	5	6	7	8	COIN	PLAY
	OFF	OFF	OFF	OFF	1	1
	ON	OFF	OFF	OFF	1	2
	OFF	ON	OFF	OFF	1	3
	ON	ON	OFF	OFF	1	4
	OFF	OFF	ON	OFF	1	5
	ON	OFF	ON	OFF	1	6
	OFF	ON	ON	OFF	1	7
	ON	ON	ON	OFF	2	1
	OFF	OFF	OFF	ON	2	3
	ON	OFF	OFF	ON	2	5
	OFF	ON	OFF	ON	3	1
	ON	ON	OFF	ON	3	2
	OFF	OFF	ON	ON	3	4
	ON	OFF	ON	ON	4	1
	OFF	ON	ON	ON	4	3
	ON	ON	ON	ON	FREE PLAY	

DIP 2 SW SET

3 THE NUMBER OF PLANES

SW	1	2	NUMBER
0	OFF	OFF	3
	ON	OFF	4
	OFF	ON	5
	ON	ON	256

4 TYPE OF GAME

SW	3	TYPE
	OFF	TABLE
	ON	UP RIGHT

5 BONUS SET

SW	4	BONUS POINT
0	OFF	10,000 Pts. and after every 50,000 Pts.
	ON	20,000 Pts. and after every 60,000 Pts.

6 DIFFICULTY OF THE GAME SET

SW	5	6	7	
0	OFF	OFF	OFF	1 (VERY EASY)
	ON	OFF	OFF	2 (EASY)
	OFF	ON	OFF	3
	ON	ON	OFF	4
	OFF	OFF	ON	5
	ON	OFF	ON	6
	OFF	ON	ON	7 (DIFFICULT)
	ON	ON	ON	8 (VERY DIFFICULT)

7 MUSIC IN ATTRACTIVE MODE

SW	8	MUSIC IN ATTRACTIVE
0	OFF	OFF
	ON	ON

0 NORMAL SETTING

## INSTALLATION

Your game was shipped from the factory in ready-to-play condition. A brief inspection is suggested before the machine is removed from the carton. If there is damage to the shipping carton, contact the freight carrier for claim purposes. External damage could indicate possible damage to the cabinet and/or electronics components.

After the carton has been satisfactorily inspected, remove the machine from the shipping carton.

Examine the interior of the game for disconnected wires, cables, or harnesses. Make sure the electronic devices are securely mounted in their sockets, etc. Record the game serial number, since it will be required for reference and servicing.

## ELECTRICAL REQUIREMENTS

Unless otherwise specified, this game is set to operate at 110 Volts A.C. (See Fig. 2 and 110/220 VAC conversion instructions.)

Power supply chassis schematic information and parts list are included in this manual.

## 110/220 VAC CONVERSION INSTRUCTIONS

This game contains a harness configuration which allows the machine to be operated from either a 110 VAC or 220 VAC, 50 Hz or 60 Hz power source. All games shipped from Centuri, Inc., are in the 220 VAC configuration. To change to the 220 VAC configuration follow the procedure below.

**FIRST:** Unplug the machine from the wall outlet to completely eliminate shock hazards.

**SECOND:** Remove the single 3 AMP slow-blow fuse found in the A.C. Distribution Bracket, and install two, 1.5 AMP slow-blow fuses. Next cut the #18 AWG. white jumper at both ends of the fuse holder, and replace the cover.

**THIRD:** On the game power transformer, locate the "orange" jumper plug which is marked, 110 VAC. Unplug the "orange" jumper, and plug in the "red" jumper marked 220 VAC.

To revert back to 110 VAC, replace the components originally removed from the Steps above.

**\*\*\*NOTE:** The common side of the A.C. Line must not be fused in the 110 VAC configuration- Replace the #18 AWG., white jumper wire.

(Refer also to FIG. 2, 110/220 POWER INTERCONNECT DIAGRAM, # 386-10-0300 )

THE MATERIAL CONTAINED HEREIN IS CONFIDENTIAL AND NO PART OF IT CAN BE REPRODUCED WITHOUT THE EXPRESSED PERMISSION OF CENTURI, INC.

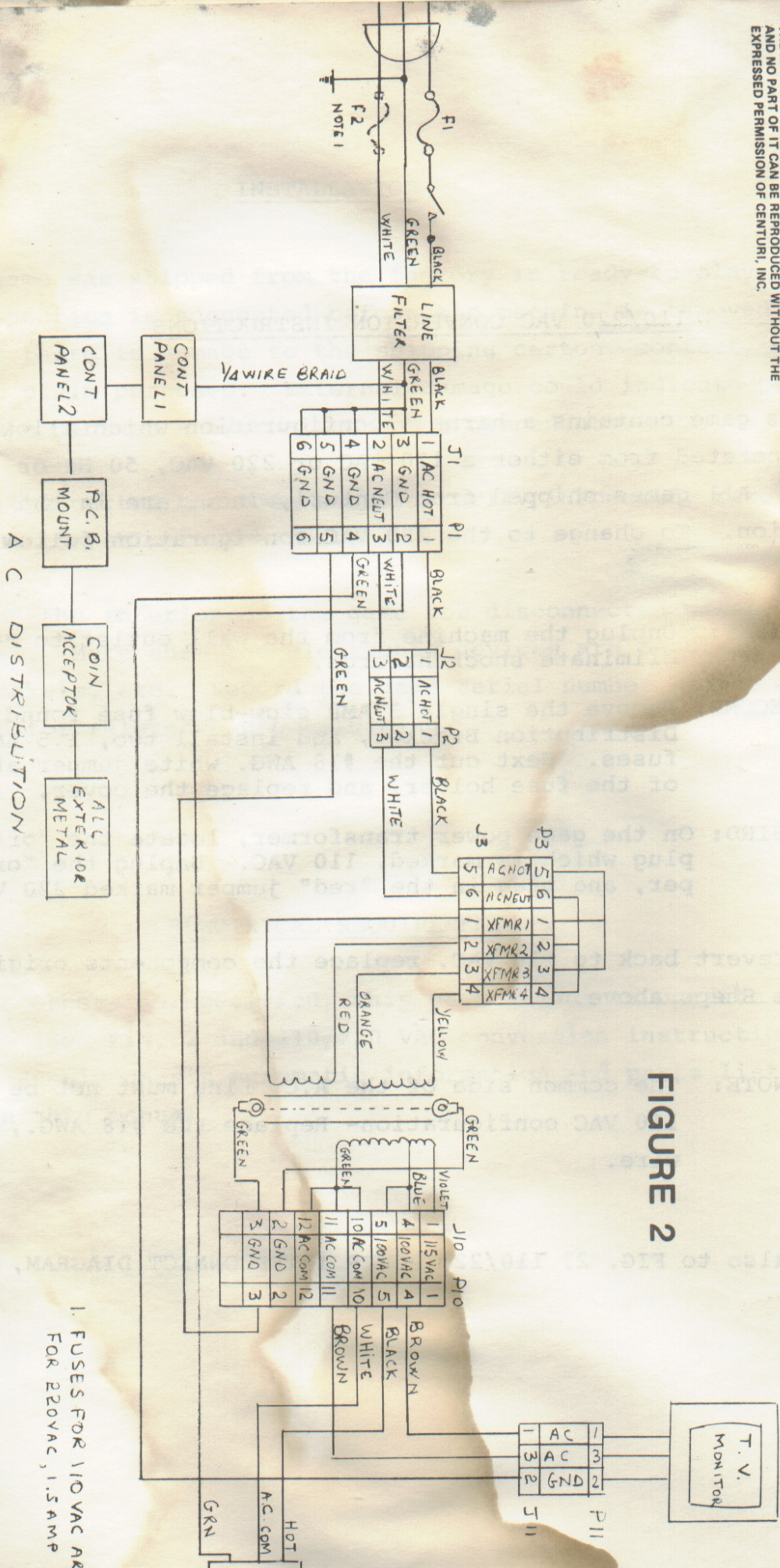

FIGURE 2

1. FUSES FOR 110VAC ARE FOR 220VAC, 1.5 AMP

A C DISTRIBUTION

TOLERANCES		Unless Otherwise Specified	
FRACTIONS	± 1/32	DECIMALS 2 PL	± .015
DECIMALS 3 PL	± .005	DECIMALS 3 PL	± .003
HOLES	± .001	ANGLES	± 1/2°
SHT. MET BENDS	± 2°		

REV. LET.	ECN NO.	REVISION	BY

CC. APVD	PROD. APVD	QTY.	ASSEMBL

NAME		HALEAH, FLORIDA	
AC INTERCONNECT DIAGRAM COCKT			
MAT'L'S.	HEAT TREAT.	FINISH	
DWN.	APPD.	SCALE	PART NO.
			10-0300

## ROUTINE MAINTENANCE & SERVICE

Because of the solid state electronic circuitry, this machine should require very little maintenance, and only occasional adjustments. However, it is necessary to take steps to insure this.

The volume control is located on the bottom side of the printed circuit board, farthest from the side of the cabinet, and can be accessed through the rear door.

The video monitor has been properly adjusted before shipping. Occasionally minor adjustments are necessary. Technical information, along with schematics, can be found in this manual. Adjustment controls for the monitor are located on the rear of the monitor.

"DO NOT MAKE ANY ADJUSTMENTS ON THIS MACHINE WHILE THE POWER IS ON!" This machine should only be adjusted by a "qualified" technician.

For Service Information, contact:

CENTURI, INC.

CUSTOMER SERVICE DEPARTMENT

#800-327-7710 (Outside the State of Fla.)

#305-556-5888 (In Florida)

### POWER SUPPLY

The Computer Board in this game operates most efficiently and reliably when the power supply is set so the voltage on the Board is 5.0 Volts,  $\pm 0.1$  Volts. To check this, place a meter across 5 Volts, and ground, at the edge connector. If necessary, adjust the screwdriver control on the power supply, so the meter reads between 4.9 and 5.1 Volts.

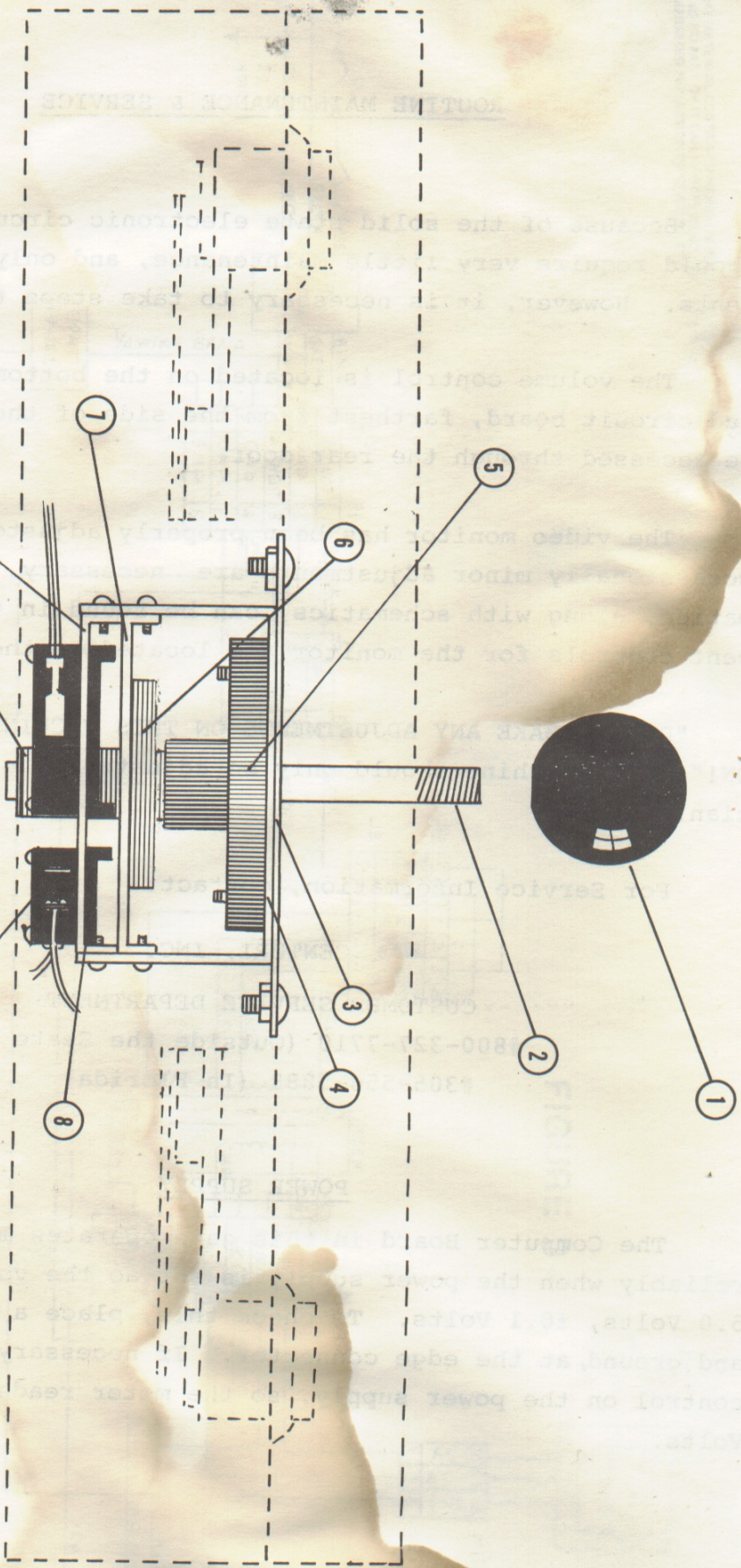

(Fig.3) EXPLODED VIEW of joystick ass'y.

GS1-8 POSITION JOYSTICK ASS'Y

PARTS LIST

<u>ITEM</u>	<u>CENTURI P/N:</u>	<u>DESCRIPTION:</u>	<u>QNTY.</u>
1.	607-0030	KNOB	1
2.	607-0031	SHAFT	1
3.	304-2666	JOYSTICK ADAPT PLATE	1
4.	607-0035	BODY BRKT.	1
5.	607-0032	RUBBER DIAPHRAGM	1
6.	607-0034	PLASTIC WASHER	1
7.	607-0036	FUNCTION PLATE (8 WAY)	1
8.	607-0039	SWITCH HOLDER	1
9.	607-0037	SWITCH PLATE	1
10.	607-0038	MICRO SWITCH 5 AMP	1
11.	607-0033	SWITCH ACTUATOR	1



(FIG,4) EXPLODED VIEW OF CONTROL PANEL AS

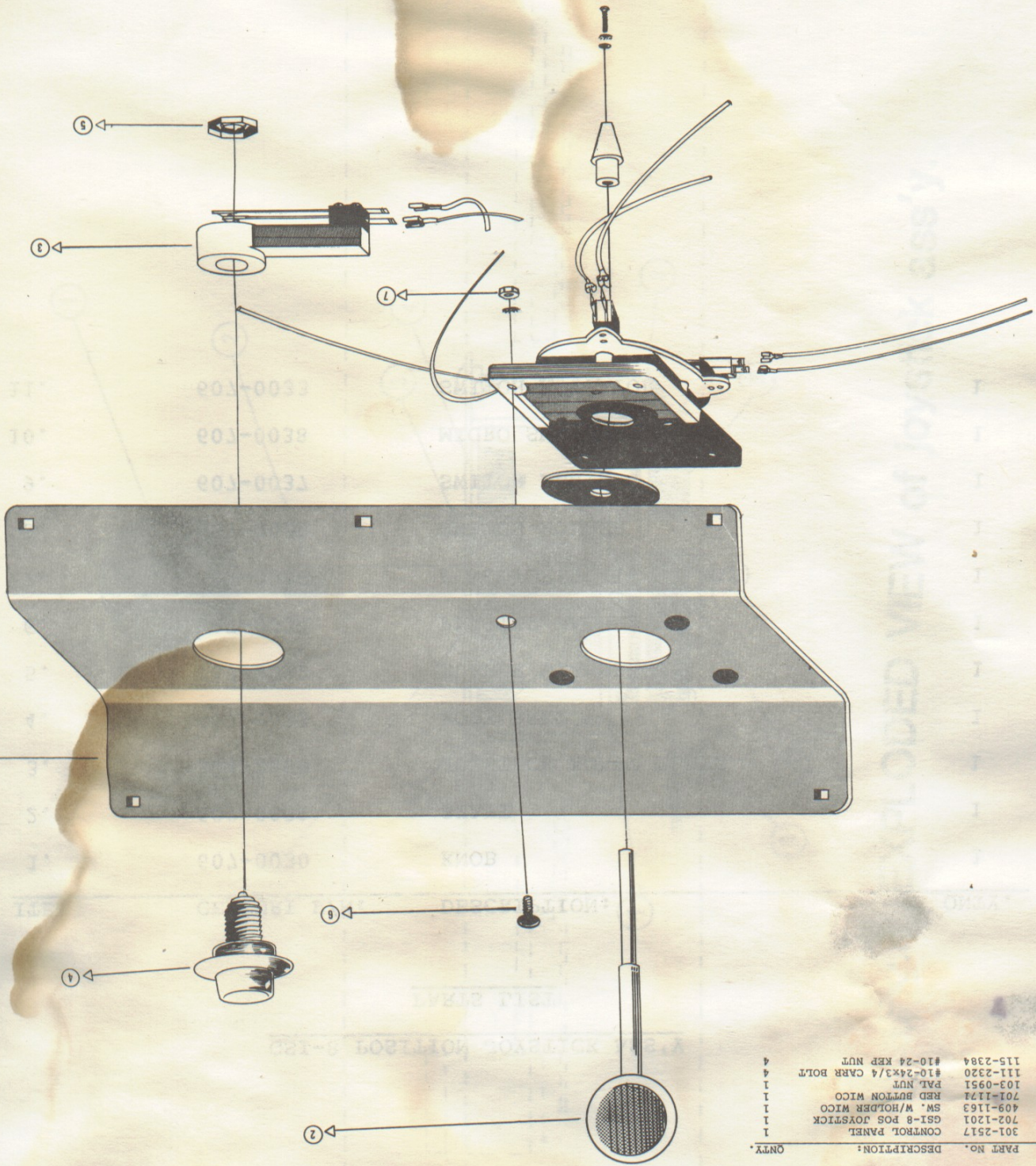

ITEM	PART NO.	DESCRIPTION:	QNTY.
1.	301-2517	CONTROL PANEL	1
2.	702-1201	GS1-8 POS JOYSTICK	1
3.	409-1163	SM. W/HOLDER W/CO	1
4.	701-1171	RED BUTTON W/CO	1
5.	103-0951	NUT	1
6.	111-2320	#10-24x3/4 CARB BOLT	4
7.	115-2384	#10-24 KEP NUT	4

COMPUTER & LOGIC BOARDPARTS LIST

ITEM	PART NUMBER:	DESCRIPTION:	QNTY.
1.	501-0176	74LS367, I.C.	1
2.	501-0200	74LS138, I.C.	1
3.	501-0102	74LS00, I.C.	1
4.	501-0184	74LS163, I.C.	4
5.	501-0153	74LS08, I.C.	2
6.	501-0108	74LS04, I.C.	2
7.	501-0202	74LS245, I.C.	5
8.	501-0112	74LS10, I.C.	1
9.	501-0214	74LS244, I.C.	3
10.	501-0190	74LS259, I.C.	1
11.	501-0192	74LS298, I.C.	1
12.	501-0156	74LS32, I.C.	3
13.	501-0170	74LS139, I.C.	1
14.	501-0426	74LS378, I.C.	1
15.	501-0182	74LS377, I.C.	2
16.	501-0205	74LS273, I.C.	3
17.	501-0125	74LS86, I.C.	5
18.	501-0121	74LS74, I.C.	2
19.	501-0427	74LS293, I.C.	1
20.	501-0135	74LS174, I.C.	1
21.	501-0141	74LS157, I.C.	5
22.	501-0211	74LS368, I.C.	2
23.	501-0129	74LS107, I.C.	1
24.	501-0250	Z-80A MICROPROCESSOR	1
25.	501-0435	2149, RAM	2
26.	500-0017	6331, 123N BIP PROM	2
27.	501-0405	2114, 200NS STATIC RAM	4
28.	500-0011	74S287 BIPOLAR PROM	2
29.	501-0074	8Kx2 RAM 2128	2
30.	500-0023	2764, EPROM	6
31.	501-0428	083 CUST. CHIP-KONAMI	2
32.	501-0429	082 CUST. CHIP-KONAMI	1
33.	501-0430	K824-501 CUST. CHIP-KONAMI	1
34.	501-0431	K824-502 CUST. CHIP-KONAMI	1
35.	501-0432	K824-503 CUST. CHIP-KONAMI	1

SOUND BOARD "TIME PILOT"PARTS LIST

<u>ITEM</u>	<u>PART NUMBER:</u>	<u>DESCRIPTION:</u>	<u>QNTY.</u>
35.	517-0765	0.1 MF, 50V MYLAR CAP.	1
36.	515-0705	0.1 MF, 16V DISC CERAMIC CAP.	50
37.	515-0734	220 PF, 50V DISC CERAMIC CAP.	2
38.	515-0778	470 PF, 25V DISC CERAMIC CAP.	1
39.	515-0748	100 PF, 25V DISC CERAMIC CAP.	1
40.	514-1571	24 PIN I.C. SOCKET	1
41.	503-0433	220 OHM, 1/4 WATT, 5% RESISTOR	24
42.	503-0405	4.7K, 1/4 WATT, 5% RESISTOR	3
43.	503-0452	1.8K, 1/4 WATT, 5% RESISTOR	1
44.	503-0403	1.2K, 1/4 WATT, 5% RESISTOR	1
45.	503-0413	1K, 1/4 WATT, 5% RESISTOR	10
46.	503-0454	5.1K, 1/4 WATT, 5% RESISTOR	7
47.	418-2096	VR-200, TRIMMER	1
48.	503-0458	820 OHM, 1/4 WATT, 5% RESISTOR	2
49.	503-0417	10K OHM, 1/4 WATT, 5% RESISTOR	1
50.	506-1000	8 POSITION DIP SWITCH	2
51.	401-1280	RTB-1.5-2F (J.S.T.) 2 PIN WAFER	1
52.	513-1144	KT-5112-2B SOUND BARE BD. TIME PILOT	1
53.	401-1376	40 P.RIGHT ANGLE PCB HEADER ANSLEY	1
54.	519-0884	22 MF, 16V TANTALUM CAP.	1

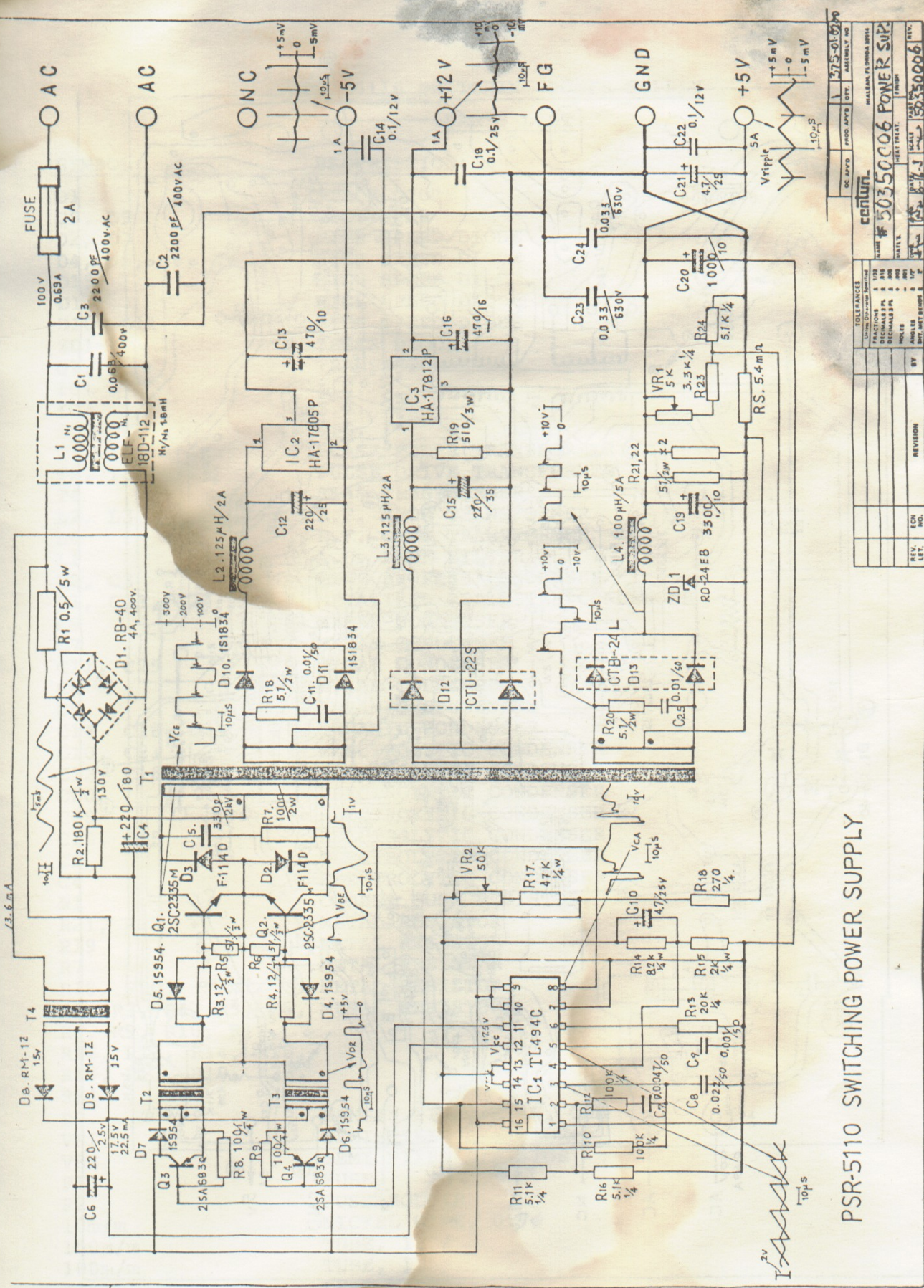

PSR-5110 SWITCHING POWER SUPPLY

REV.	LET.	CON.	NO.	BY	REVISION

DIMENSIONS		SCALE		DATE	
UNIT	INCHES	UNIT	INCHES	DATE	BY
FRACTIONS	1/32	SCALE	1:1	DATE	BY
DIMENSIONAL	1/32	HEAT TREAT.			
DECIMALS	1/16				
TOLERANCES	0.005				
	0.010				
	0.015				
	0.020				
	0.030				
	0.040				
	0.050				
	0.060				
	0.070				
	0.080				
	0.090				
	0.100				
	0.125				
	0.150				
	0.175				
	0.200				
	0.250				
	0.300				
	0.375				
	0.500				
	0.625				
	0.750				
	1.000				
	1.250				
	1.500				
	2.000				
	2.500				
	3.000				
	3.750				
	4.500				
	5.000				
	6.000				
	7.500				
	9.000				
	10.000				

DC APP'D:   
 DATE:   
 DRAWN BY:   
 CHECKED BY:   
 APPROVED BY:   
 TITLE:   
 PROJECT NO.:   
 SHEET NO.:   
 TOTAL SHEETS:   
 SCALE:   
 DATE:   
 BY:   
 REV. LET. CON. NO. REVISION:   
 375-01-0274   
 CENTURION   
 MADE IN FLORIDA 32014   
 #50350006 POWER SUP   
 150350006

PSR-5110 SWITCHING POWER SUPPLYPARTS LIST

<u>SYMBOL:</u>	<u>DESCRIPTION:</u>	<u>QNTY.</u>
J12	LEAD WIRE	1
J13	LEAD WIRE	1
J14	LEAD WIRE	1
	BIND TUBE	3
SM221	MAIN P.C. BOARD	1
	TERMINAL	1
	RATING LABEL	1
	TERMINAL LABEL	1
	BIND SCREW	5
	TRUSS SCREW	8
	TAPPING SCREW	13
	HEX NUT	7
	FLAT WASHER	7
	RECTANGULAR WASHER	6
	SPRING WASHER	7
	MICA WASHER	12
	INSULATION BUSHING	6
	TOP CASE/BOTTOM CASE	2
	FRONT PANEL	1
	REAR PANEL	1
	TERMINAL SUPPORT	1
	HEAT SINK A	1
	HEAT SINK B	1
	HEAT SINK C	1
	HEAT SINK D	1
	METAL HOLDER	4

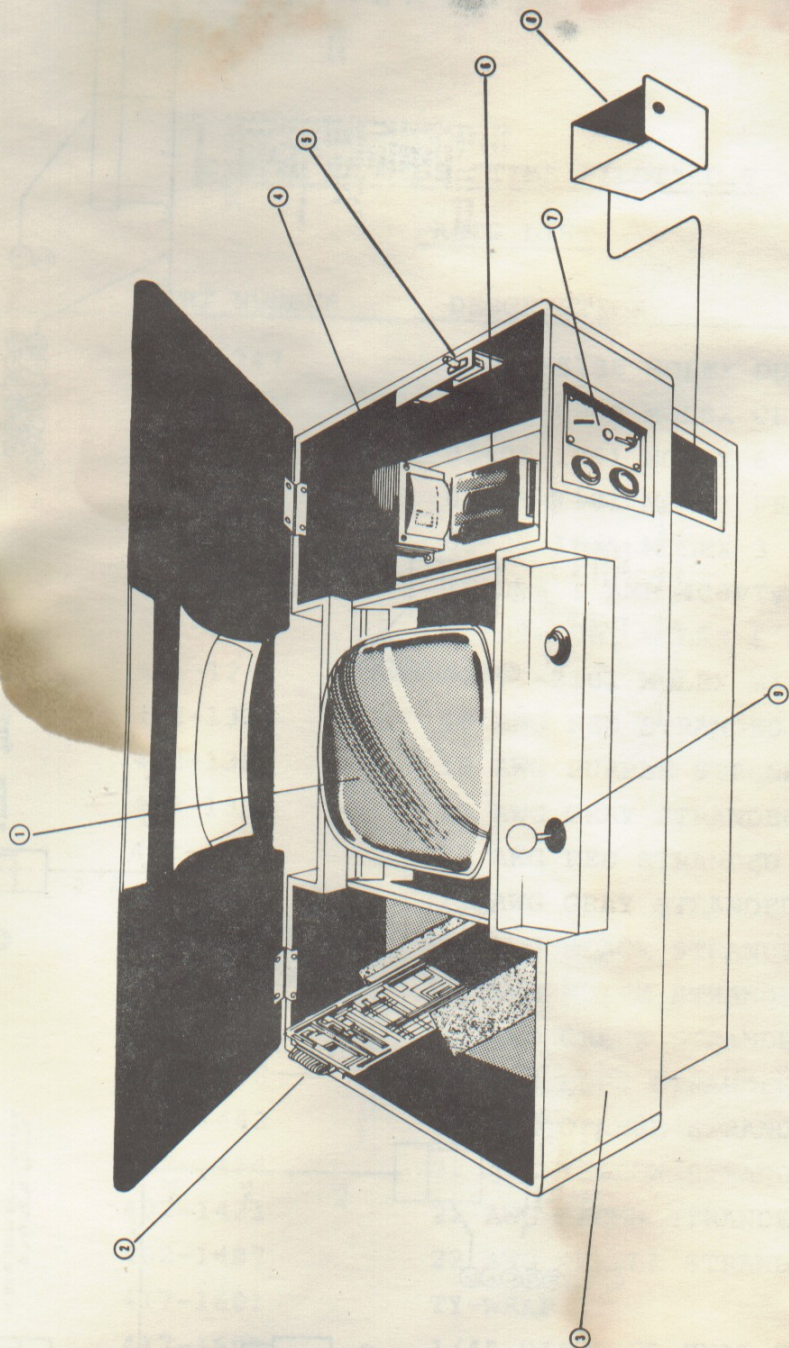

**INTERIOR VIEW OF COCKTAIL TABLE.**

<u>ITEM</u>	<u>ASSEMBLY No.</u>	<u>DESCRIPTION</u>
1.	406-2056	Monitor Wired Assy
2.	003-4531	P.C.B. Boards
3.	004-4239	Cocktail Table Sub'Assy
4.	007-4851	Transformer Wired Assy
5.	013-4654	A.C.Line Dist. Wired Assy c.t.
6.	005-4468	P.A.L. power Supply
7.	009-4683	Coin Acceptor/Start Sw. Assy
8.	017-0958	Cash Box Assy
9.	006-4453	Control Panel Assy

THE MATERIAL CONTAINED HEREIN IS CONFIDENTIAL AND NO PART OF IT CAN BE REPRODUCED WITHOUT THE EXPRESSED PERMISSION OF CENTURI, INC.

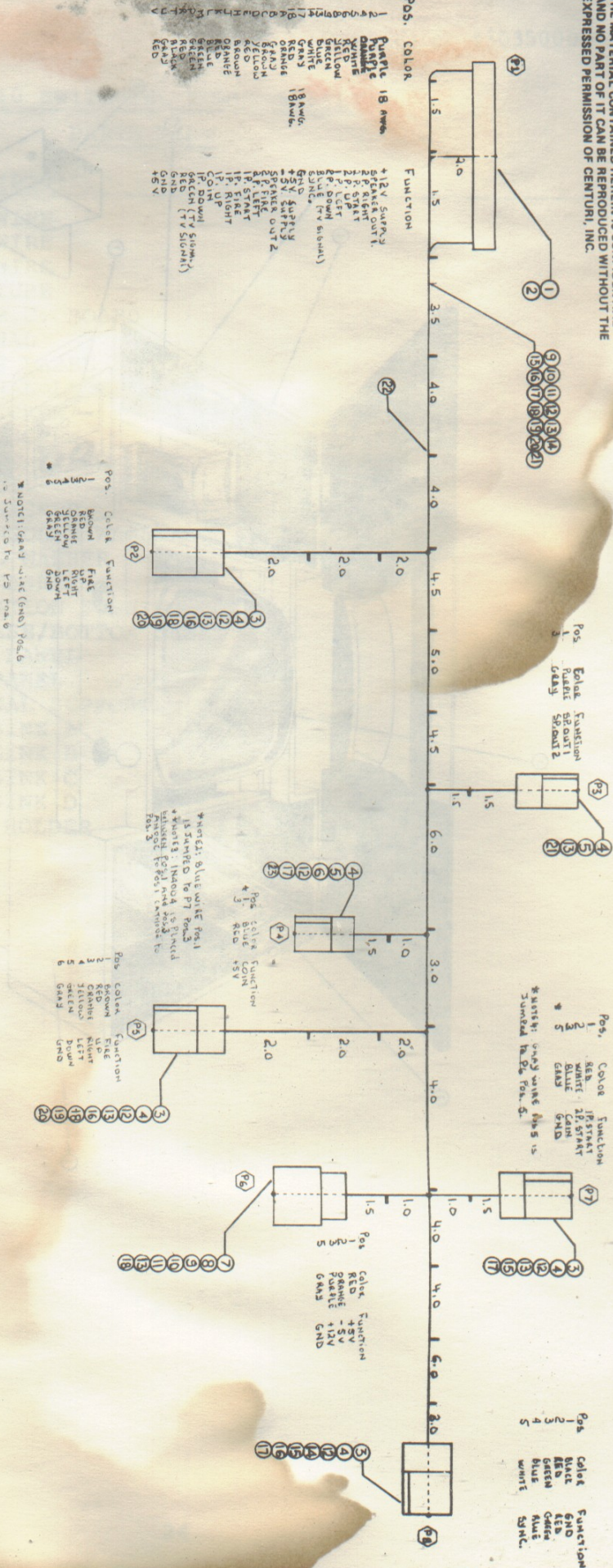

Pos. Color Function  
 1 BROWN FUSE  
 2 RED FUSE  
 3 ORANGE FUSE  
 4 GREEN FUSE  
 5 GRAY GND

\*Note: Blue wire Post 1 is limited to PT Post 3. Wires 1, 2 and 3 are placed unused for Post 1 and 2. Post 3.

Pos. Color Function  
 1 BROWN FUSE  
 2 RED FUSE  
 3 ORANGE FUSE  
 4 GREEN FUSE  
 5 GRAY GND

Pos. Color Function  
 1 BLUE GND  
 2 BLUE GND  
 3 BROWN GND  
 4 BLUE GND  
 5 WHITE SYNC.

CENTURI		HIALEAH, FLORIDA 33014	
DC. AP/VD	PROD. AP/VD	QTY.	ASSEMBLY NO.

TOLERANCES	
Unless Otherwise Specified	
FRACTIONS ± 1/32	
DECIMALS 2 PL ± .015	
DECIMALS 3 PL ± .005	
HOLES ± .003	
ANGLES ± .001	
SHI. MET BENDS ± 1/2°	

NAME			DATE		
C.P.V. HARKNESS - TIME PILOT - C.T.			1/11/82		
MATERIALS			SCALE		
FINISH			PART NO. 008-4875		
REV.			REV.		

26

C.P.U. HARNESS "TIME PILOT" C.T.PARTS LIST

<u>ITEM</u>	<u>PART NUMBER</u>	<u>DESCRIPTION:</u>	<u>QNTY.</u>
1.	401-1247	09-50-5185 MOLEX DUAL 18 HOUSING	1
2.	401-1261	08-03-0303 MOLEX CRIMP TERMINAL	26
3.	401-1231	03-09-1061 MOLEX 6 PIN RECEPTACLE	4
4.	401-1243	02-09-1101 MOLEX FEMALE PIN	25
5.	401-1225	03-09-1031 MOLEX 3 PIN RECEPTACLE	2
6.	510-0656	IN4004 1 AMP 400PIV DIODE	1
7.	401-1229	03-09-2061 MOLEX 6 PIN PLUG	1
8.	401-1242	02-09-2101 MOLEX MALE PIN	4
9.	402-1332	18 AWG RED STRANDED WIRE	47"
10.	402-1387	18 AWG PURPLE STRANDED WIRE	47"
11.	402-1398	18 AWG GRAY STRANDED WIRE	47"
12.	402-1432	22 AWG RED STRANDED WIRE	224"
13.	402-1498	22 AWG GRAY STRANDED WIRE	75"
14.	402-1509	22 AWG BLACK STRANDED WIRE	66"
15.	402-1410	22 AWG WHITE STRANDED WIRE	113"
16.	402-1465	22 AWG GREEN STRANDED WIRE	137"
17.	402-1476	22 AWG BLUE STRANDED WIRE	170"
18.	402-1443	22 AWG ORANGE STRANDED WIRE	71"
19.	402-1454	22 AWG YELLOW STRANDED WIRE	71"
20.	402-1421	22 AWG BROWN STRANDED WIRE	71"
21.	402-1487	22 AWG PURPLE STRANDED WIRE	35"
22.	417-1601	TY-WRAP	23
23.	417-1609	1/4" DIAMETER HEAT SHRINK TUBING	1"





NOTE

- (S) : SOCKET
- (E) : ELECTROLYTIC CONDENSER
- (M) : MYLAR CAPACITOR
- (N) : CERAMIC CONDENSER

REV. LET.	ECN NO.	REVISION

TOLERANCES	
LENGTH	± .015
WIDTH	± .015
DIAMETER	± .015
THICKNESS	± .015
ANGLE	± .015
DRILL	± .015
FINISH	
SCALE	
PART NO.	
REV.	

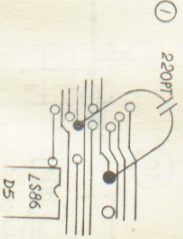
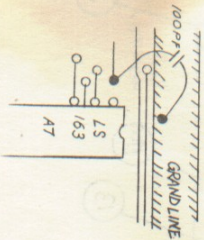

**CANTON**  
 NAME: CPU LOGIC Bd. COMPONENTS LAYOUT  
 DATE:                      SCALE:                      PART NO.:                      REV.:                      ASSEMBLY NO.:                      QTY.:                      PHO. APP'D:                      DATE:                      BY:                      DATE:                      REV.:

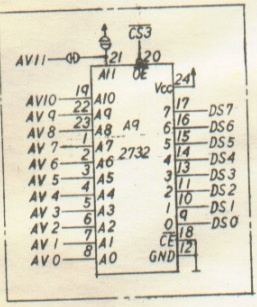
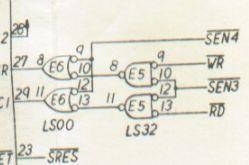
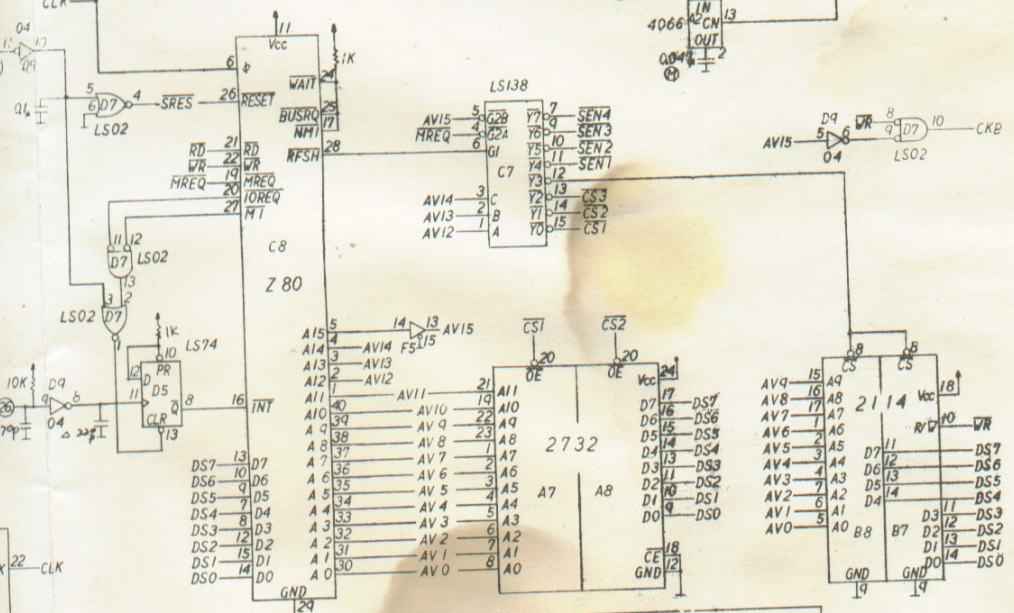
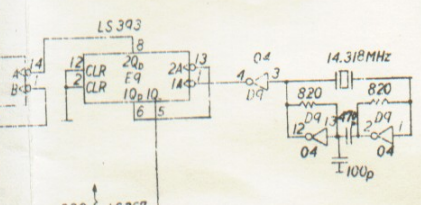
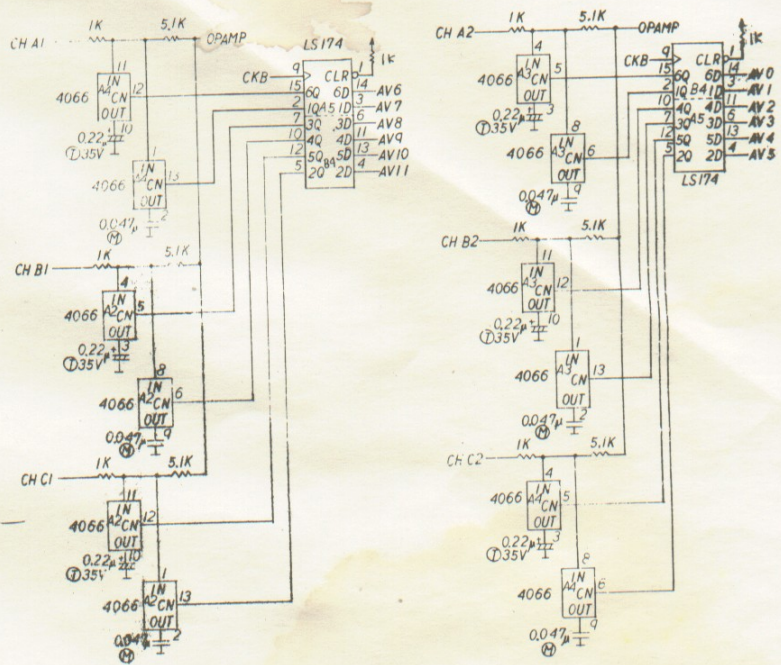
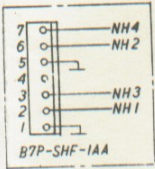

- NOTES**
- ↑ : 5V Vcc
  - ⊥ : 0V GND
  - (B 2) : 36-PIN CONNECTOR  
B is PARTS SIDE
  - (L) : 40-PIN CONNECTOR
  - (I) : 2-PIN CONNECTOR
  - (T) : TANTALUM ELECTROLYTIC CONDENSER
  - (M) : MYLAR CAPACITOR
  - (C) : ELECTROLYTIC CONDENSER
  - NO MARK : CERAMIC CONDENSER
  - ( ) : NO LAYOUT PARTS

QC. AP'VD	PROD. AP'VD	QTY.	ASSEMBLY NO.

**CONUM** HIALEAH, FLORIDA 33014

NAME <b>SOUND BOARD (KT-5112-2B)</b>			
MAT'L'S		FINISH	
OWN.	APP'D.	DATE	SCALE PART NO. REV.
V. N. D.	W. S.	11/61/82	905-4898

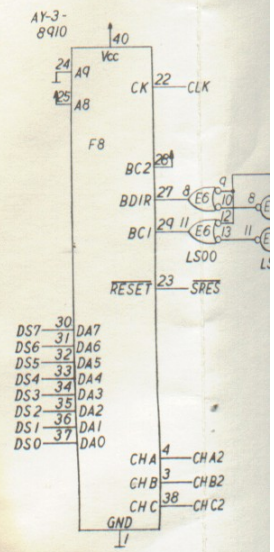
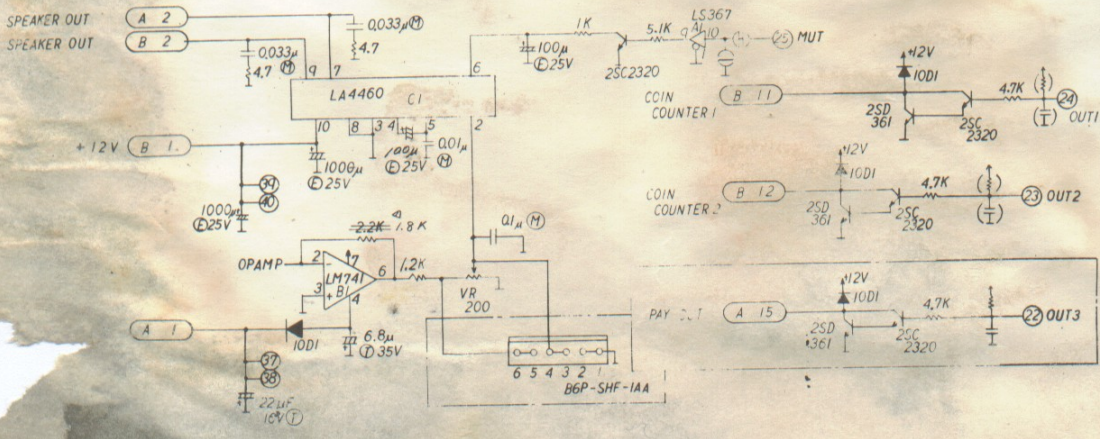
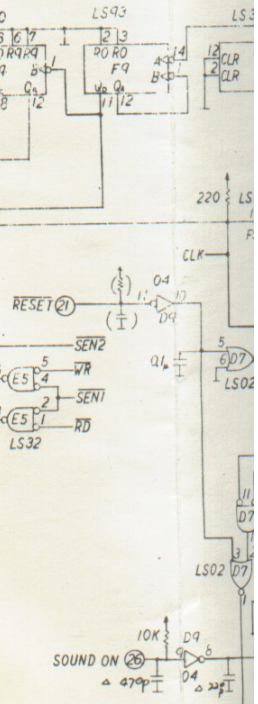
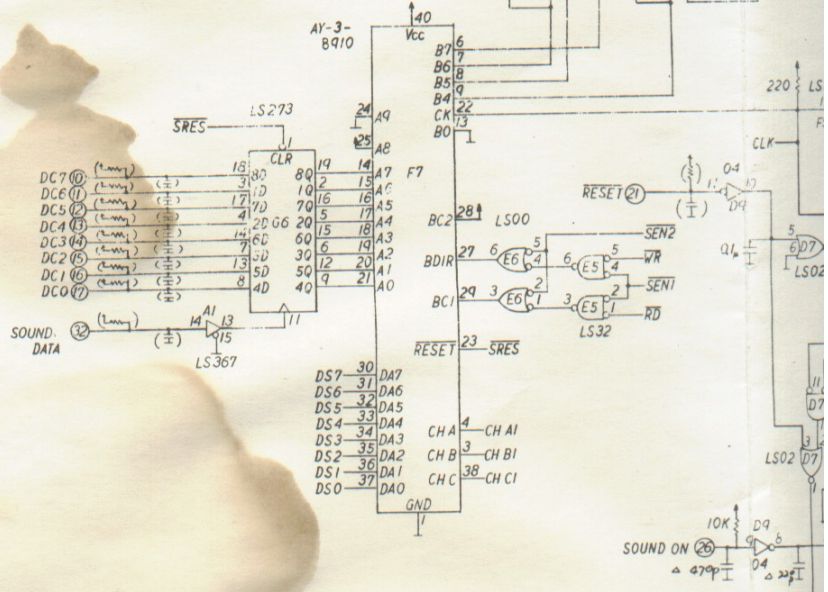
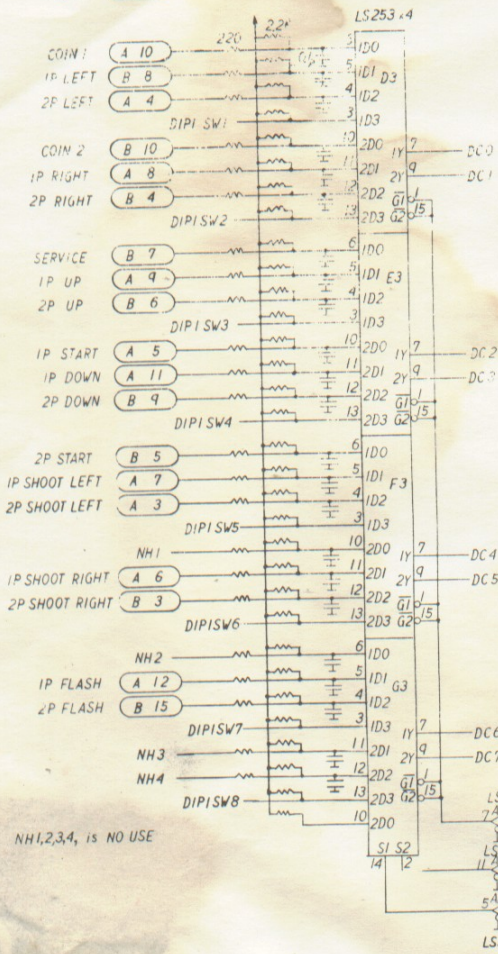
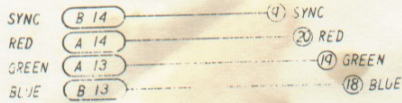
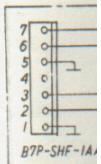
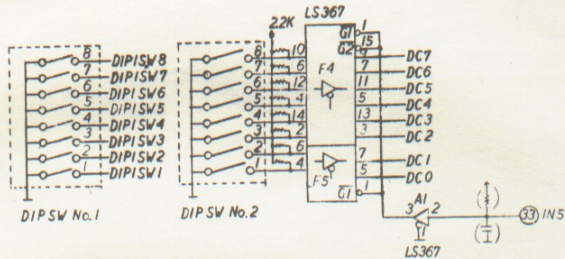
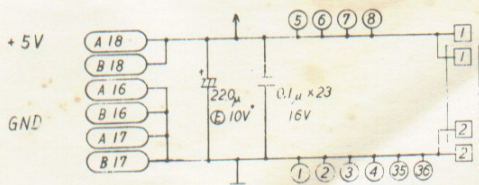

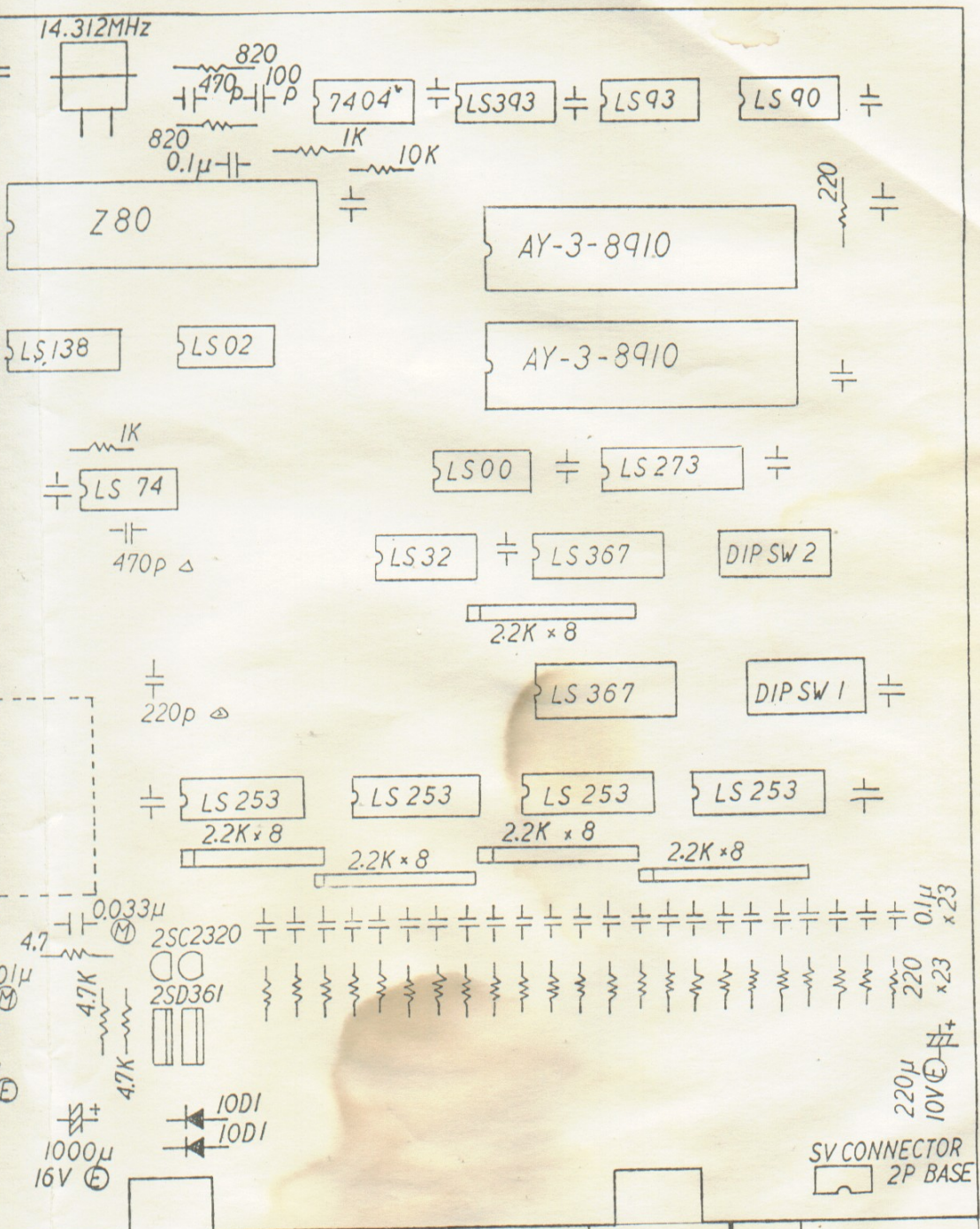

QC. APV'D	PROD. APV'D	QTY.	ASSEMBLY NO

**centuri** inc. HIALEAH, FLORIDA 33014

NAME **SOUND BOARD COMPONENTS LAYOUT.**

MAT'L'S. HEAT TREAT. FINISH

DWN. APP'D. DATE SCALE PART NO. REV.

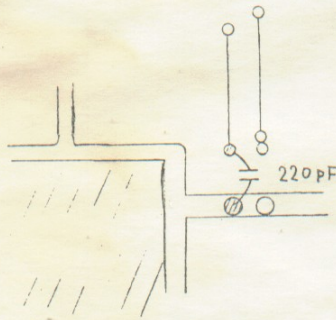

- NOTE
- (S) ; SOCKET
  - (T) ; TANTALUM CONDENSER
  - (E) ; ELECTROLYTIC CONDENSER
  - (M) ; MYLAR CAPACITER
  - NO MARK ; CERAMIC CONDENSER

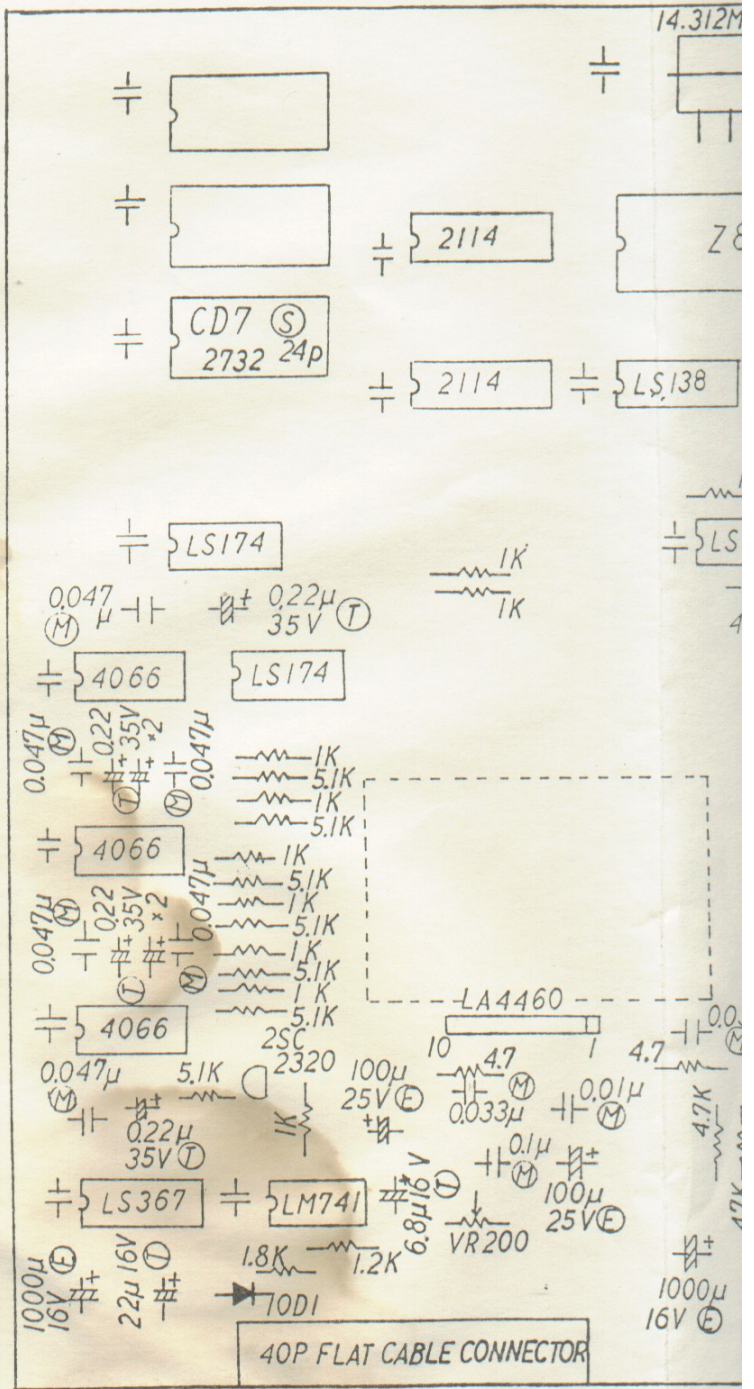



NOTES  
 † ; Vcc, +5V  
 † ; GND, 0V  
 (1) ; 40P FLAT CABLE CONNECTOR  
 (2) ; 2P SV CONNECTOR (BASE)  
 (E) ; ELECTROLYTIC CONDENSER  
 (M) ; MYLAR CONDENSER  
 NO MARK ; CERAMIC CONDENSER

OC. APV'D		PROD. APV'D	ASSEMBLY NO.
<b>CONVULS</b>			
MILBAM, FLORIDA 33014			
NAME	C.P.U. BOARD (KT-5207-1B)		
MAT'L'S.	HEAT TREAT.	FINISH	
DWN. T.V.D.	APPR. W.W.	DATE 8/01/82	SCALE PART NO. 905-4897



CONTRACTS MARKETING 

ELECTROHOME ELECTRONICS

54-7293-01

THIS INFORMATION IS UP TO DATE AS OF MAY 1980

---

**SERVICE AND OPERATION MANUAL**  
**G07-13" R.G.B. COLOUR MONITOR**

---

ELECTROHOME ELECTRONICS

DIVISION OF CENTRAL ONTARIO TELEVISION LIMITED

WHOLLY OWNED SUBSIDIARY OF ELECTROHOME LIMITED, KITCHENER, ONTARIO, CANADA N2G 4J6



# TABLE OF CONTENTS

Description	Page
Models .....	3
Notes .....	4
Service Data Reference .....	5
Warnings .....	5
Operating Instructions .....	6
Performance and Operating Data .....	7
Product Safety .....	7
Service Guidelines .....	8
Service Set-Up Procedure .....	11
C.R.T. PCB Component Layout .....	12
Main PCB Component Layout .....	13
Schematic .....	14
Replacement Parts .....	15
Main PCB Assembly .....	17
CRT Socket PCB Assembly .....	

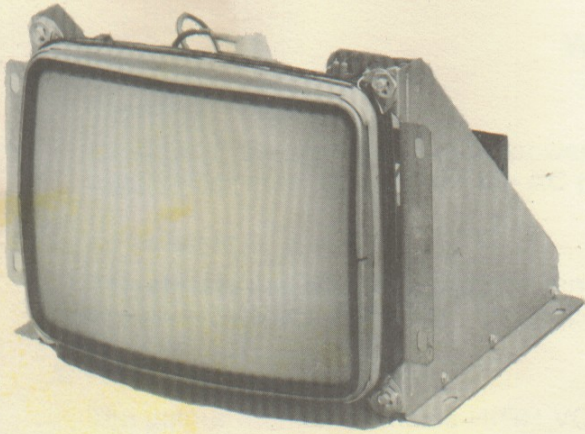

FRONT

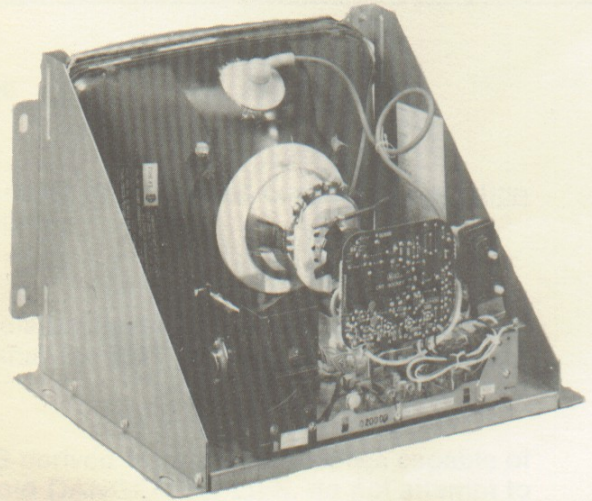

REAR

**G07-902**



FRONT

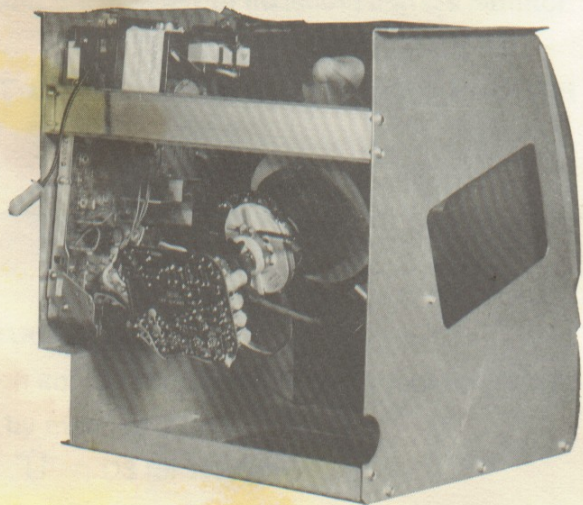

REAR

**G07-906**

## Service Data Reference

When writing for Service Information, please quote chassis type number and model code. See chassis type number and model code located on the right hand side panel. This information is correct as of May 1980.

**File Supplementary Model Data with this G07 Manual.**

### Warnings

#### 1. Power Up Warning

Caution: If the monitor is to be powered up outside of the games console, an isolation transformer must be used for the AC power source.

#### 2. X-Radiation

This chassis has been designed for minimal x-radiation hazard. However, to avoid possible exposure to soft x-radiation it is IMPERATIVE that the EHT circuitry IS NOT modified.

#### 3. High Voltage



The colour monitor contains HIGH VOLTAGES derived from power supplies capable of delivering LETHAL quantities of energy. To avoid DANGER TO LIFE, do not attempt to service the chassis until all precautions necessary for working on HIGH VOLTAGE equipment have been observed.

#### 4. CRT Handling

The picture tube encloses a high vacuum and due to the large surface area is subject to extreme force. Care must be taken not to bump or scratch the picture tube as this may cause the tube to implode resulting in personal injury and property damage. Shatter-proof goggles must be worn by individuals while handling the CRT or installing it in the monitor. Do not handle the CRT by the neck.

#### 5. To prevent fire or shock hazard DO NOT EXPOSE THIS MONITOR TO RAIN OR MOISTURE.

### Operating Instructions

1. Apply a suitable power source to the monitor through an isolation transformer by means of P901.
2. Apply a suitable signal source to the monitor PCB by mean of J201.
3. For negative input pulses use J202 D21 for vertical  . D3 for Horizontal  .
4. Set up Controls  
All controls are preset at the factory, but may be adjusted to suit program material. Refer to pages 6 and 8 (WHITE BALANCE AND GRAY SCALE TRACKING).

## Performance and Operating Data

### 1.0 Supply

Min — Max

Voltage

108 VAC - 132 VAC

Frequency

44 Hz - 63 Hz

Note: Apply supply voltage through an isolation transformer with 1 Amp. capability

### 2.0 High voltage (EHT)

For 13" V Models

19.5 KV - 22.5 KV

Note: Condition for above 1 (beam) = 0  
 $B_1 = 120V$

### 3.0 Input Signal and Pin Assignments for J201

Pin No.	Description	Impedance	Signal Range
1	Red input	5K nom.	0 to 4V
2	Green input	5K nom.	0 to 4V
3	Blue input	5K nom.	0 to 4V
4	Ground		
5	Vertical sync pulse	35K nom.	+2V to +4V
6	Horizontal sync pulse	35K nom.	+2V to +4V

### 4. Service Set-Up Controls

4.1 Vertical linearity R406

4.2 Vertical Height R408

4.3 Vertical hold control, R422

4.4 Horizontal Freq. control, R504

4.5 Horizontal centering tabs, 3 positions

4.6 Vertical centering tabs, 3 positions

4.7 CRT cut off controls (See fig. 3)

- Red cut off, R114
- Green cut off, R115
- Blue cut off, R113

4.8 Video drive controls (See fig. 3)

- Red drive, R105
- Green drive, R106

4.9 Focus control R11 and screen control

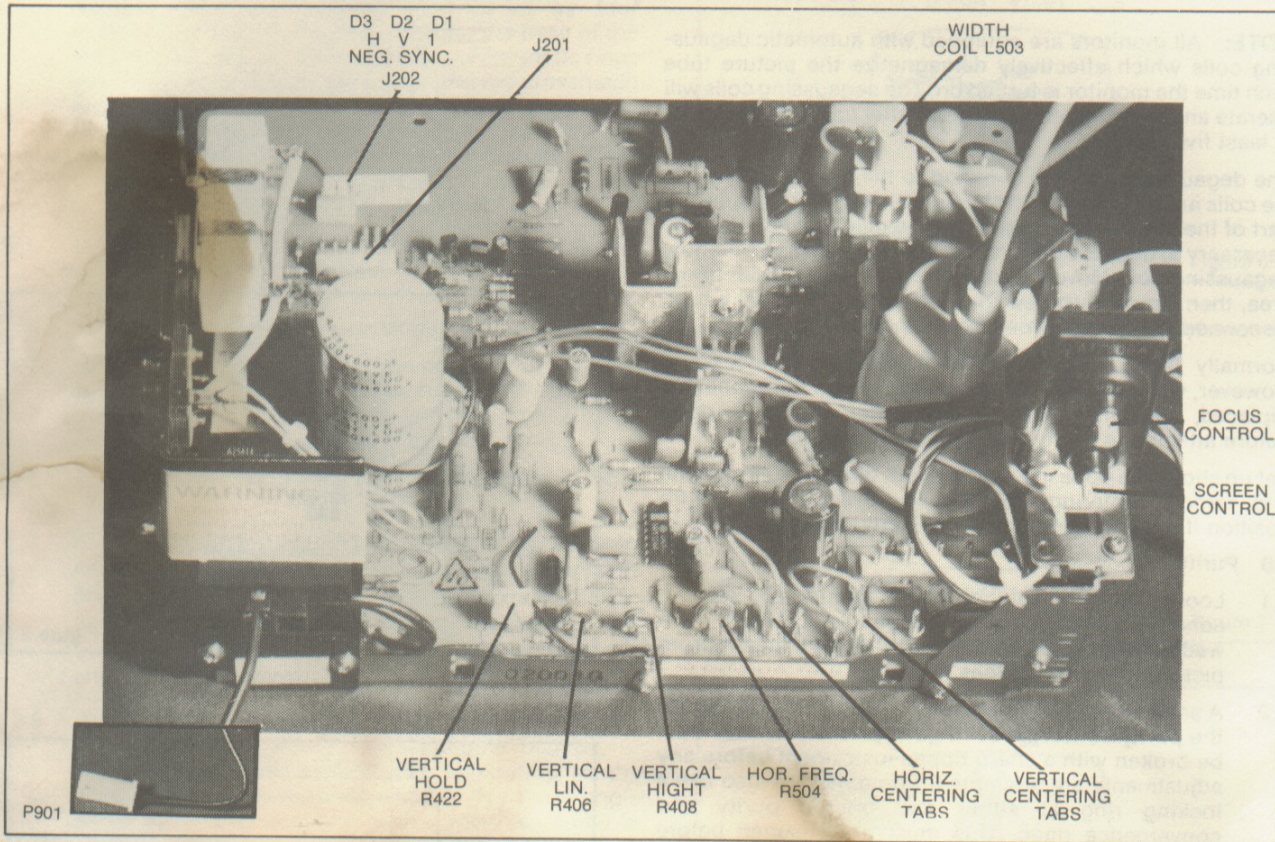

## Product Safety and Servicing Guidelines

### Safety Checks

Subject: Fire and Shock Hazard

1. No modification of any circuit should be attempted. Service work should be performed only after you are thoroughly familiar with all of the following safety checks and service guidelines. To do otherwise increases the risk of potential hazards and injury to the user.
2. When service is required, observe the original lead dress. Extra precaution should be given to assure correct lead dress in the high voltage circuitry area. Where a short circuit has occurred, replace those components that indicate evidence of overheating. Always use the manufacturer's specified replacement component. See parts list in the back of this manual.
3. Periodically check the high voltage for proper value using a meter of known accuracy and calibration.
4. Check for frayed insulation on wires.

3.3 Slowly color ap. not touch the fully CC'

3.4 S'

## Service Set-Up Procedure

**NOTE:** All monitors are equipped with automatic degaussing coils which effectively demagnetize the picture tube each time the monitor is turned on. The degaussing coils will operate any time the set is turned on after having been off for at least five minutes.

The degaussing effect is confined to the picture tube since the coils are mounted on the ferrous tube shield. Should any part of the chassis or cabinet become magnetized, it will be necessary to degauss the affected area by means of a manual degaussing coil. Move the coil slowly around the CRT face area, then slowly withdraw for a distance of six feet before disconnecting the coil from the AC power supply.

Normally little, if any adjustment should be necessary. However, when a picture tube, yoke or similar component is replaced, preliminary static convergence should be done before attempting purity adjustment, and so on.

Set up should be done in a north/south direction. Horizontal and vertical centering taps should be set to the centre position if a major component has been changed.

### 1.0 Purity

- 1.1 Loosen yoke retaining clamp (figure 2), remove adhesive material fixing wedges to CRT. Remove wedges completely and clean off dried adhesive from picture tube and wedges.
- 1.2 A small quantity of "nail polish" has been used to lock the purity convergence rings in place. This seal must be broken with a sharp tipped instrument before any adjustments are attempted. Some models also use a locking ring at either end of the purity and convergence rings. This must be loosened before adjustments are made. It goes without saying that upon completion of all adjustments, the lock must be reset and/or a dab of paint or nail polish must be re-applied to edge of rings to prevent movement.
- 1.3 Connect an appropriate signal source, eg: Electrohome RGB generator producing a white field plus individual red, green and blue fields.
- 1.4 Bring the long and short purity tab protrusions in line with each other to obtain near-zero magnetic field (figure 4) (In some cases bring the flat and indented tabs together to obtain zero field). Protrusions can then be vertical, horizontal or at any convenient angle to start.
- 1.5 Turn off the green and blue fields and adjust setup controls to produce a red field. (See fig. 3)
- 1.6 Pull the deflection yoke back so that a red band appears in the centre of the screen.
- 1.7 Spread the tabs apart as little as necessary and rotate both rings together to center the red band horizontally on the face of the CRT (approximate). (See Fig. 5)
- 1.8 Slide the yoke towards the bell of the picture tube slowly to obtain a uniform red field (pure in color) across the entire tube face. Juggle back and forth slightly as necessary. Lightly tighten yoke retaining clamp.
- 1.9 Momentarily switch on a cross-hatch signal and rotate yoke to level the pattern on the face of CRT.
- 1.10 Return generator to regain red raster.
- 1.11 Turn off red field and check for pure field for each of the green and blue fields. Reposition yoke if necessary to obtain optimum purity on all fields.
- 1.12 Tighten yoke retaining clamp to prevent yoke shift or rotation. (Do not install wedges at this time.)

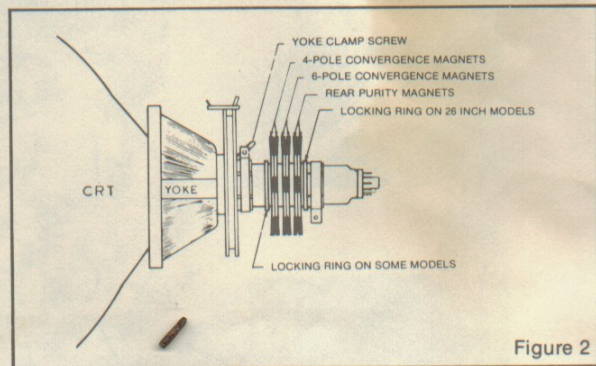

Figure 2

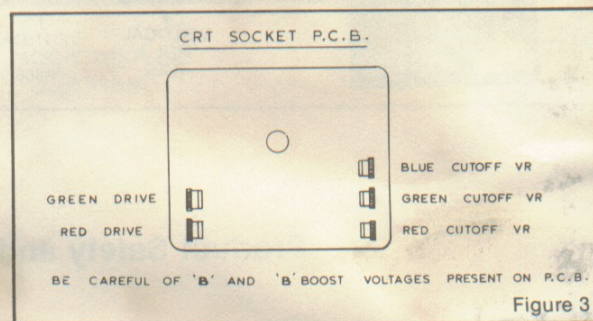

Figure 3

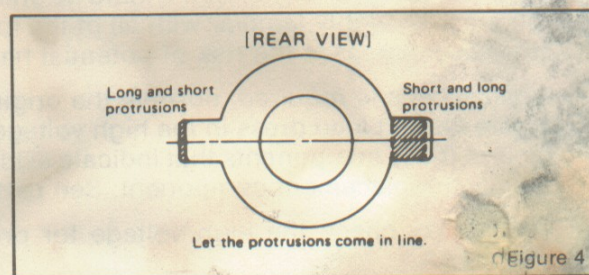
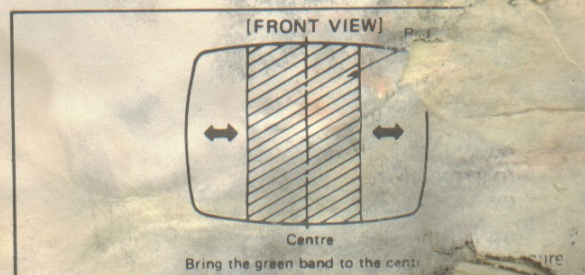

Figure 4



## 2.0 Static and Dynamic Convergence

NOTE: Static convergence is achieved by four magnets located on the neck, nearest the base of the picture tube, Fig. 2. The middle pair of magnetic rings are adjusted to converge the blue and red crosshatch lines. The rear pair of convergence rings (closest to the base of the picture tube) are adjusted to converge the magenta (blue/red) to the green crosshatch lines. Dynamic convergence is achieved by tilting the deflection yoke up-down and left-right.

- 2.1 Ensure that the controls misadjusted during purity setup (screen, cut-off, etc.) are set to give white balance. See 3.0 below.
- 2.2 Switch generator to the crosshatch pattern.
- 2.3 Adjust convergence around the edges of the picture tube by tilting the yoke up-down and left-right, and temporarily install one wedge at the top of the yoke or in a more optimum position. (Figures 8, 9, 10)
- 2.4 Turn off green input and turn on the red and blue input.
- 2.5 Rotate the 4-pole (middle) pair of magnets as a unit to minimize separation of the red and blue crosshatch lines around the center of the screen (Figure 6). Variation of the angle between the tabs adjusts convergence of red and blue. (Tilt yoke as required to converge red and blue at the edges as in 2.3 above.)
- 2.6 Turn on green input to obtain magenta (red/blue) and green crosshatch lines. Rotate the 6-pole (rear) pair of magnets as a unit to minimize separation of the magenta and green lines (figure 7). Vary angle between the two tabs and further rotate as a unit to finalize.
- 2.7 When convergence of 3 colors is optimized (static in center and dynamic around edges) apply stripe of paint or nail polish to convergence magnet rings to prevent movement. If applicable, tighten locking ring carefully.
- 2.8 Remove temporary wedge from yoke. Tilt yoke in up-down and left-right direction for best circumference convergence and install 3 wedges. (It is best to use 3 new wedges since they have adhesive backing. Simply pull off tape, slide wedge in place and press outer flap down firmly. For more permanency apply small quantity of silastic or similar material at junction of wedges and picture tube. Do not disturb while material is setting. (Order wedges by part number 39-1233-01).

## 3.0 White Balance (Grey Scale Tracking)

Refer to figure 3. Do the following in subdued light:

- 3.1 No signal adjustment can be accomplished with no signal connected; eg: input connector open or if a signal generator is connected, switch off all 3 inputs at the generator.
- 3.2 Set red and green drive controls to their mechanical center and turn the common G2 screen control and 3 cut-off controls to minimum (fully counterclockwise).
- 3.3 Slowly turn up G2 screen control until the first faint color appears, then back off to edge of visibility. Do not touch the associated cut-off control - it should stay fully CCW for the remaining set-up.
- 3.4 Slowly turn up the other two color cut-off controls in turn to match the first. This should result in the faintest grey.
- 3.5 Turn on the signal generator with all 3 inputs on. (a pattern would be appropriate).

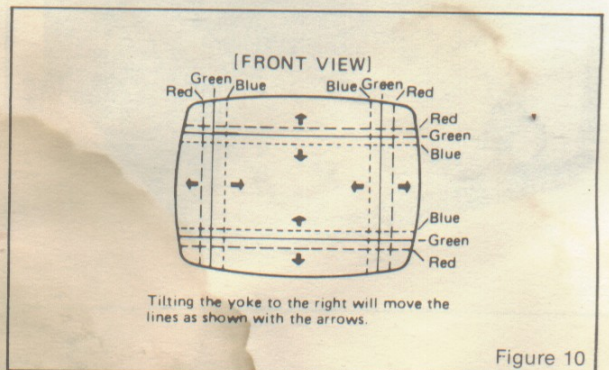
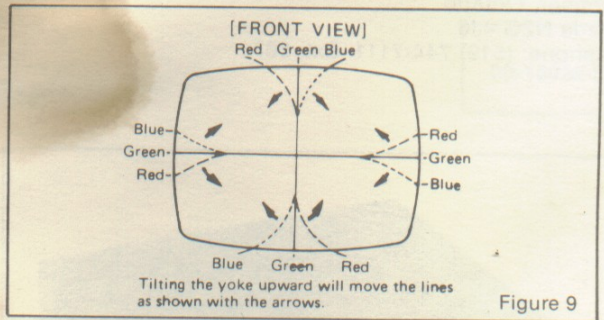
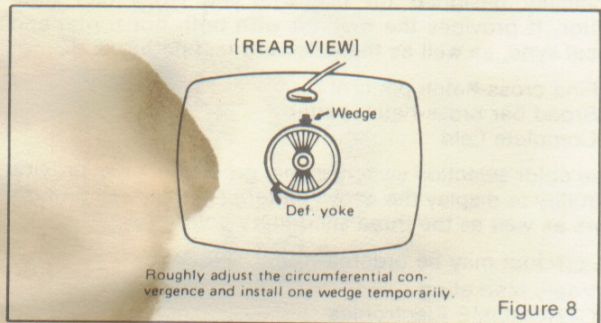
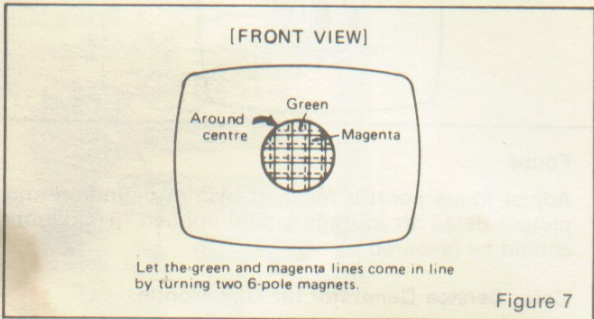
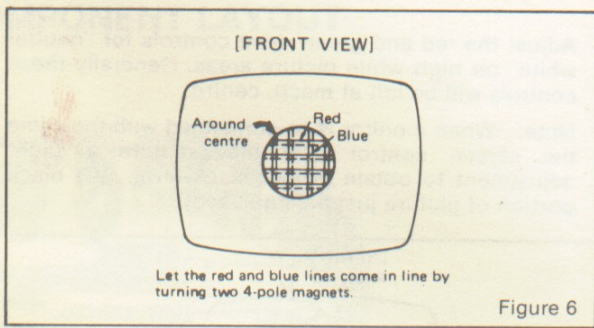

- 3.6 Adjust the red and green drive controls for "neutral white" on high white picture areas. Generally these controls will be left at mech. centre.
- 3.7 Note: When monitor is re-connected with the game the screen control (G2) may require a slight adjustment to obtain proper black level. (the black portion of picture just extinguished).

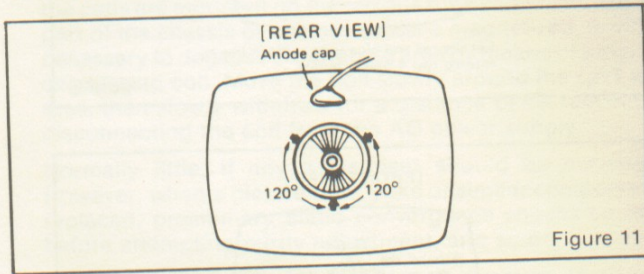

#### 4.0 Focus

Adjust focus control for best overall definition and picture detail an average signal applied. (Highlights should be favoured.)

#### 5.0 Color Service Generator for G07 Monitor

Electrohome has developed a color service generator that is specifically designed for use with the G07 color data monitor. It provides the monitor with both horizontal and vertical sync, as well as the following test patterns:

- 1) Fine cross-hatch pattern
- 2) Broad bar cross-hatch pattern
- 3) Complete field

Three color selection switches, red, green and blue, provide the ability to display the above patterns in the three primary colors as well as the three secondary colors.

This product may be ordered from:

Contracts Marketing  
ELECTROHOME Electronics  
809 Wellington St. North  
Kitchener, Ontario  
Canada N2G 4J6  
Telephone: (519) 744-7111, Ext. 567



#### 6.0 X-Ray Emission Check

- 6.1 Assure that the anode voltage does not exceed max. as per Item 2.0 page 4.
- 6.2 Assure that the high voltage hold down circuit is operating correctly. Use the following procedure.
- a) Increase the B1 greater than 138.5V by shorting collector/emitter of the power regulator, X04.
  - b) Observe that the anode voltage (EHT) goes to 0. If the EHT does not go to 0, a fault must be located and repaired.
  - c) Remove short and set should return to normal operation. (Note, after the short is removed some monitors may not restart. In this case, remove power from monitor momentarily and normal operation will be restored.

Note:

The protector circuit consists of the components shown below in Fig. 13 with a circuit description.

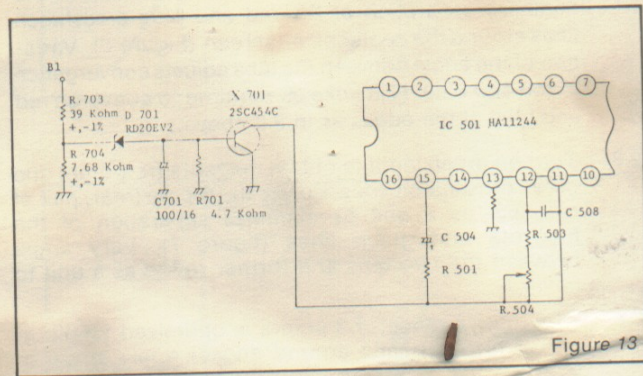

Figure 13

#### 7.0 Circuit Diagram and Description of High Voltage Hold Down or Safety Circuit

- 7.1 Circuit Diagram of High Voltage Hold Down Circuit.
- 7.2 Operation of High Voltage Hold Down Circuit.

The high voltage hold-down circuit protects the high voltage circuit from dangerous voltage with short circuiting between emitter and collector of power regulating transistor.

The base voltage of X701 is increased when the B1 voltage is increased more than 138.5 V DC.

When the base of X701 is increased, a short is produced by X701 between pin 11 and ground of IC 501, shutting down the horizontal osc. and high voltage.



# C.R.T. P.C.B. COMPONENT LAYOUT

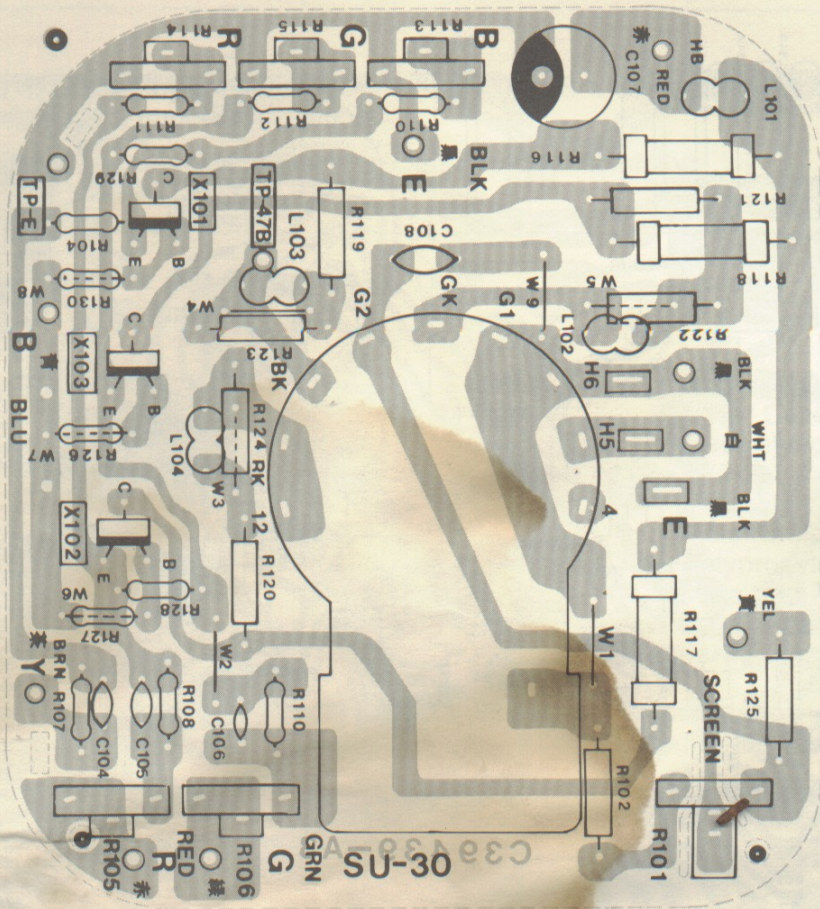

Notes:

00-18025-04

# MAIN P.C.B. COMPONENT LAYOUT

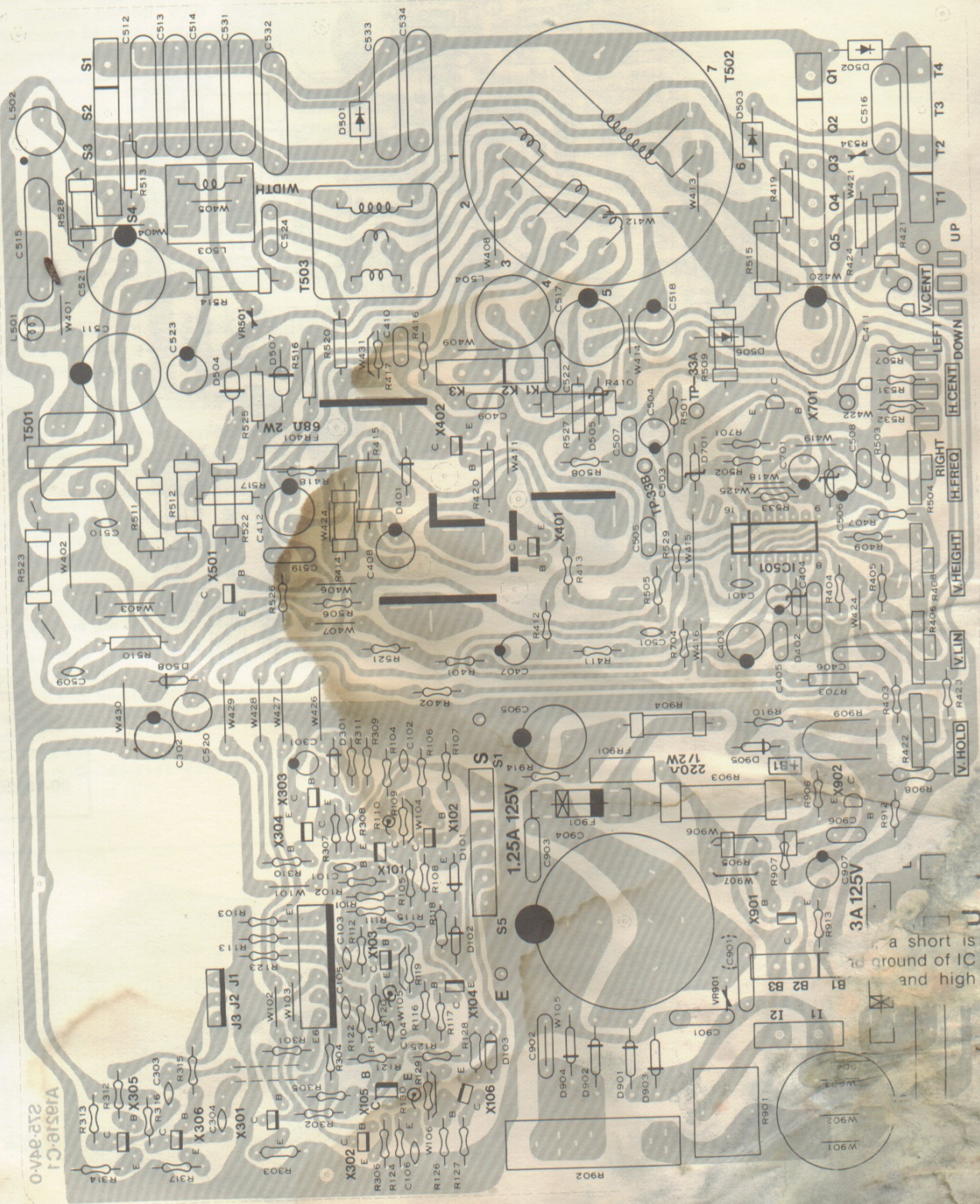

a short is ground of IC and high

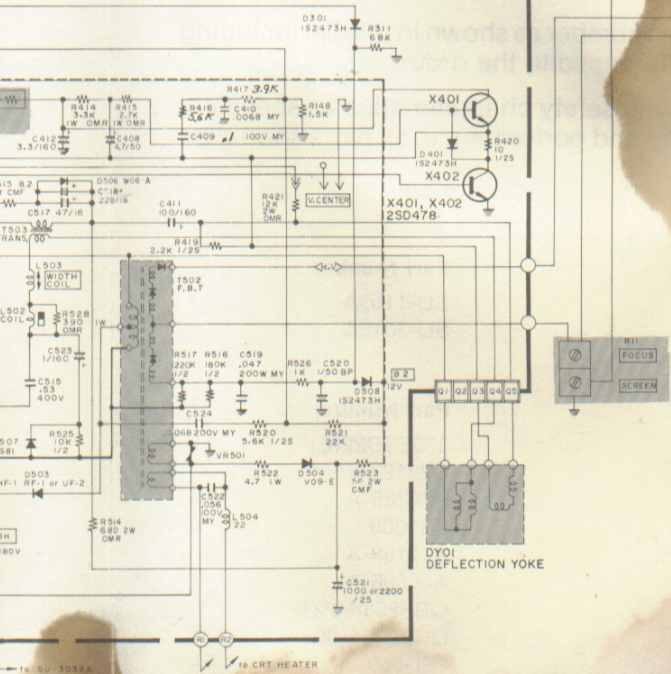
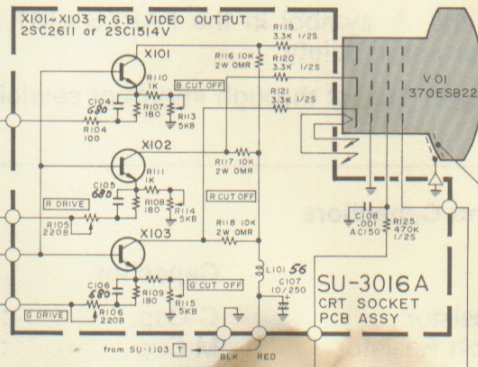
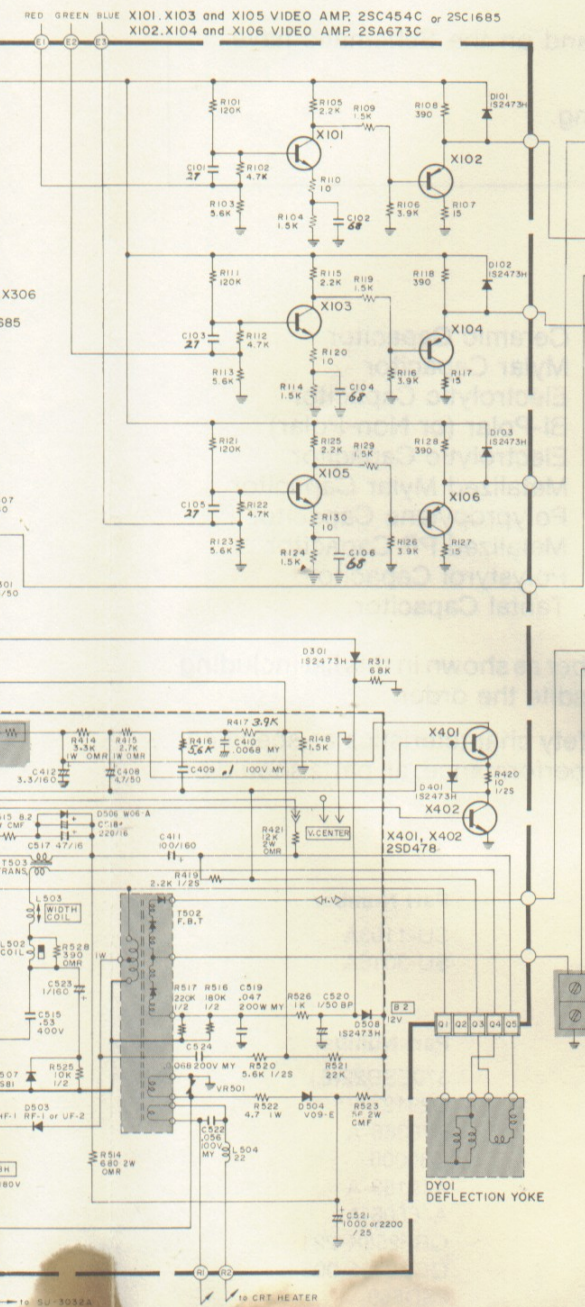

**Schematic Notes**

- Unless otherwise specified
- Resistance: ( $\Omega$ ) (K $\rightarrow$ K $\Omega$ , M $\rightarrow$ M $\Omega$ ), 1/4 (W) carbon resistor
- Capacitance: 1 or higher  $\rightarrow$  (pF), less than 1  $\rightarrow$  ( $\mu$ F)
- working voltage  $\rightarrow$  50 (V)
- ceramic capacitor
- Inductance: ( $\mu$ H)
- Electrolytic Cap: Capacitance Value ( $\mu$ F)/working voltage
- NP  $\rightarrow$  non-polar (or bipolar) electrolytic
- Refer to the parts list for additional component information
- $\odot$  indicates test point connection
- $\perp$  indicates chassis ground unless otherwise specified
- Hz indicates cycles per second
- For **safety** purposes (and continuing reliability)
- $\triangle$  replace all components marked with safety symbol with identical type.
- NOTE: FR  $\rightarrow$  fusible resistor

G07-FBO  
00-4147-03

Parts identification on circuit boards:  
e.g. SU1126A (R107 = R1107)  
SU3030A (R113 = R3113)

IC01 POWER REGULATOR  
STR383

### SU-1103A MAIN PCB ASSY

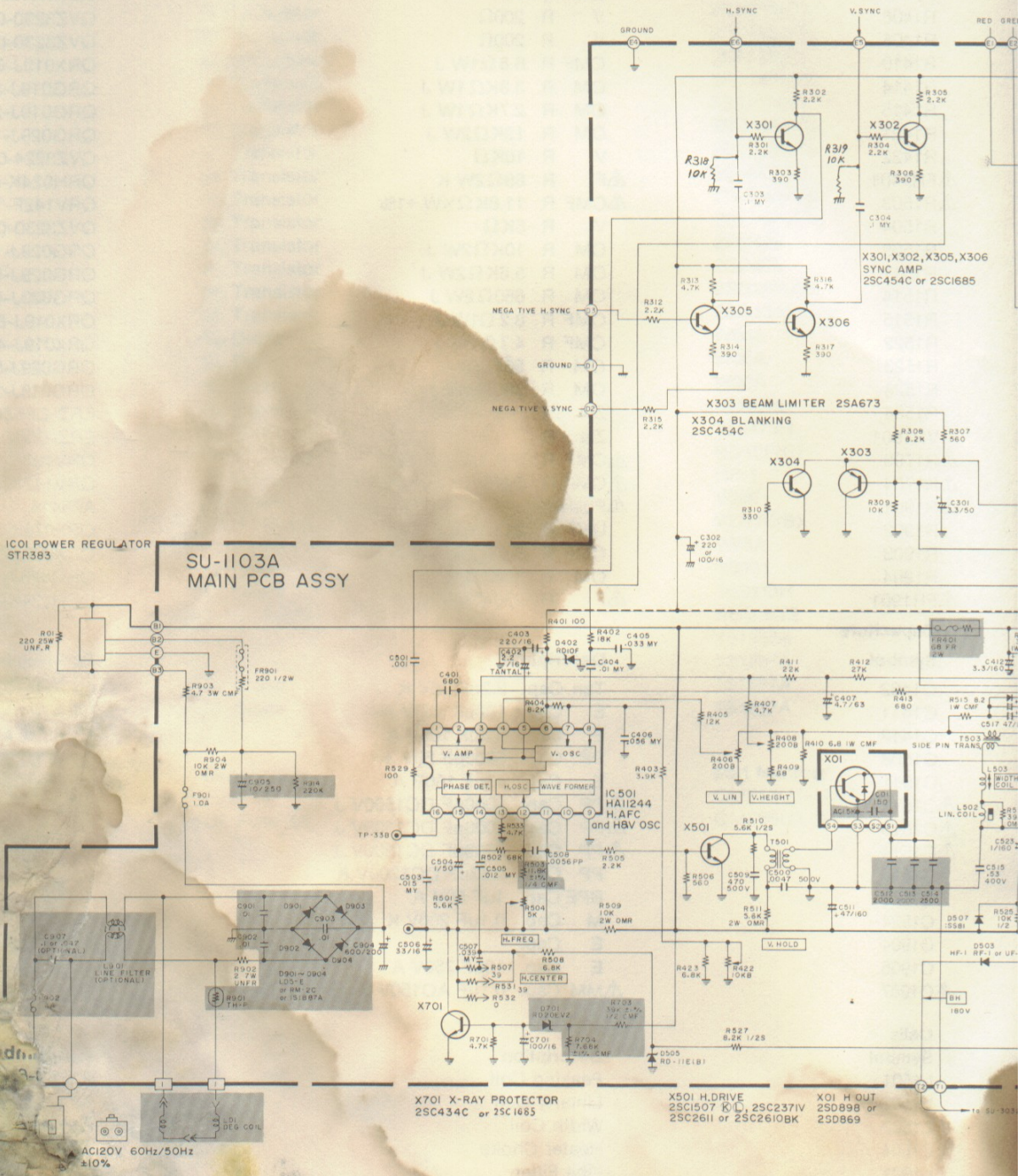

X701 X-RAY PROTECTOR  
25C434C or 25C1685

X501 H.DRIVE  
25C1507 R/D, 25C237IV  
25C2611 or 25C2610BK

X01 H.OUT  
25D898 or  
25D869

AC120V 60Hz/50Hz  
±10%

# REPLACEMENT PARTS LIST

Components identified by the  $\Delta$  symbol in the PARTS LIST and on the Schematic have special characteristics important to safety.

DO NOT degrade the safety of the set through improper servicing.

## Abbreviations for Resistors and Capacitors

### Resistor

C R	: Carbon Resistor
Comp. R	: Composition Resistor
OM R	: Oxide Metal Film Resistor
V R	: Variable Resistor
MF R	: Metal Film Resistor
CMF R	: Coating Metal Film Resistor
UNF R	: Nonflammable Resistor
F R	: Fusible Resistor

### Capacitor

C Cap.	: Ceramic Capacitor
M Cap	: Mylar Capacitor
E Cap.	: Electrolytic Capacitor
BP E Cap.	: Bi-Polar (or Non-Polar) Electrolytic Capacitor
MM Cap.	: Metalized Mylar Capacitor
PP Cap.	: Polypropylene Capacitor
MPP Cap.	: Metalized PP Capacitor
PS Cap	: Polystyrol Capacitor
Tan. Cap.	: Tantal Capacitor

NOTE: When ordering replacement parts please specify the part number as shown in this list including part name, and model number. Complete information will help expedite the order.

Use of substitute replacement parts which do not have the same safety characteristics as specified, may create shock, fire or other hazards. For maximum reliability and performance, all parts should be replaced by those having identical specifications.

Symbol	Description	Part Number
	Main P.C.B. Ass'y	SU-1103A
	CRT Socket P.C.B. Ass'y	SU-3016A

### Outside of the P.C.B. Ass'y

Symbol	Description	Part Number
$\Delta$ V01	$\Delta$ Picture Tube	370ESB22(E)
$\Delta$ DY01	$\Delta$ Deflection Yoke	C29123-V
	PC Magnet	A76366-A
	Wedge	C30006
	$\Delta$ Flyback Transf.	A19183-A
	$\Delta$ Focus V R	A46606-A
	UNF Resistor 220 $\Omega$ , 25W. K	QRF258K-221
	$\Delta$ C Capacitor 150 pF, AC1.5KV	QCZ0101-005
	Si. Transistor	2SD869
	IC Regulator	STR383
	Degaussing Coil	21-1007-31
	Degaussing Coil Pin Terminal (2)	34-708-01
	Degaussing Coil Pin Terminal Housing	34-709-01
	Groundstrap Ass'y.	34-697-04
	Groundstrap Wire Terminal	34-228-03
	Groundstrap Spring (2)	35-3560-01
	Support Bracket RH	35-3919-01
	Support Bracket LH	35-3919-02
	SCREW 10- $\frac{1}{2}$ Pix Tube Mtg. (4)	31-631018-08
	Pyramidal Lockwasher (4)	33-255-01
	Clip P.C.B. Support (2)	33-629-02
	Ground Lug	34-33-04
	Chassis Base	38-452-01

# Main P.C.B. Ass'y (SU-1103A) Parts List

## Resistors

Symbol	Description	Part Number
R1406	V R 200 $\Omega$	QVZ3230-022
R1408	V R 200 $\Omega$	QVZ3230-022
R1410	CMF R 6.8 $\Omega$ 1W J	QRX019J-6R8
R1414	OM R 3.3K $\Omega$ 1W J	QRG019J-332
R1415	OM R 2.7K $\Omega$ 1W J	QRG019J-272
R1421	OM R 12K $\Omega$ 2W J	QRG029J-123
R1422	V R 10K $\Omega$	QVZ3224-014H
$\Delta$ FR1401	$\Delta$ F R 68 $\Omega$ 2W K	QRH024K-680M
$\Delta$ R1503	$\Delta$ CMF R 11.8K $\Omega$ 1/4W +1%	QRV142F-1182
R1504	V R 5K $\Omega$	QVZ3230-053
R1509	OM R 10K $\Omega$ 2W J	QRG029J-103
R1511	OM R 5.6K $\Omega$ 2W J	QRG029J-562
R1514	OM R 680 $\Omega$ 2W J	QRG029J-681
R1515	CMF R 8.2 $\Omega$ 1W J	QRX019J-8R2
R1522	CMF R 4.7 $\Omega$ 1W J	QRX019J-4R7
R1523	OM R 56 $\Omega$ 2W J	ORG029J-560
R1528	OM R 390 $\Omega$ 1W J	ORG019J-391
R1534	ZN R	ERZ-C05ZK471
VR1501	ZN R	ERZ-C05DK271
$\Delta$ R1703	$\Delta$ CMF R 39K $\Omega$ 1/2W +1%	QRV122F-3902
$\Delta$ R1704	$\Delta$ CMF R 7.68K $\Omega$ 1/4W +1%	QRV142F-7681
$\Delta$ R1901	$\Delta$ Posistor	A75414
R1902	UNF R 2 $\Omega$ 7W K	QRF076K-2R0
R1903	CMF R 5.6 $\Omega$ 3W J	QRX039J-5R6
R1904	OM R 10K $\Omega$ 2W J	QRG026J-103Z
$\Delta$ FR1901	$\Delta$ F R 220 $\Omega$ 1/2W K	QRH124K-221M

## Capacitors

Symbol	Description	Part Number
C1402	Tan. Cap. 2.2uF 16V K	QEE51CK-225B
C1411	E Cap. 100uF 160V A	QEW52CA-107
C1412	E Cap. 3.3uF 160V A	QEW52CA-335
C1508	PP Cap. 5600pF 50V J	QFP31HJ-562
C1511	E Cap. 47uF 160V A	QEW52CA-476S
$\Delta$ C1512	$\Delta$ PP Cap. 2000pF DC1500V J	QFZ0082-202
$\Delta$ C1513	$\Delta$ PP Cap. 2000pF DC1500V J	QFZ0082-202
$\Delta$ C1514	$\Delta$ PP Cap. 2500pF DC1500V J	QFZ0082-252
C1515	PP Cap. 0.53uF DC1200V K	QFZ0067-534
C1520	BPE Cap. 1uF 50V A	QEN61HA-105Z
C1524	M Cap. 0.1uF 200V K	QFM72DK-682M
C1904	E Cap.	QEY0034-001
C1905	E Cap. 10uF 250V A	QEW52EA-106
$\Delta$ C1907	$\Delta$ MM Cap. 0.1uF AC150V Z	QFZ9008-104

## Coils

Symbol	Description
L1501	Peaking Coil
L1502	Linear Coil
L1503	Width Coil
L1504	Heater Choke
L1901	Line Filter

## Transformers

Symbol	Description	Part Number
T1501	Hor. Drive Transf.	A46022-RM
T1503	Side Pin Transf.	C39050-A



**Semiconductors****Symbol****Description****Part Number**

IC1501

I.C.

HA11244

X1101

Si. Transistor

2SC1685(R)

X1102

Si. Transistor

2SA673(C)

X1103

Si. Transistor

2SC1685(R)

X1104

Si. Transistor

2SA673(C)

X1105

Si. Transistor

2SC1685(R)

X1106

Si. Transistor

2SA673(C)

X1301

Si. Transistor

2SC1685(R)

X1302

Si. Transistor

2SC1685(R)

X1303

Si. Transistor

2SA673(C)

X1304

Si. Transistor

2SC1685(R)

X1305

Si. Transistor

2SC1685(R)

X1401

Si. Transistor

2SD478

X1402

Si. Transistor

2SD478

X1501

Si. Transistor

2SC2610BK

X1701

Si. Transistor

2SC1685(P-S)

D1101

Si. Diode

W06A

D1102

Si. Diode

W06A

D1103

Si. Diode

W06A

D1301

Si. Diode

1S2473H

D1401

Si. Diode

1S2473H

D1402

Zener Diode

RD10F(C)

D1503

Si. Diode

HF-1

D1504

Si. Diode

V09E

D1505

Zener Diode

RD11E(B)

D1506

Si. Diode

W06A

D1507

Si. Diode

1SS81

D1508

Si. Diode

1S2473H

△D1701

△Zener Diode

RD20EV2

△D1901

△Si. Diode

1S1887A

△D1902

△Si. Diode

1S1887A

△D1903

△Si. Diode

1S1887A

△D1904

△Si. Diode

1S1887A

**Miscellaneous****Symbol****Description****Part Number**

△F1901

△Fuse 1A

QMF53U1-1R0S

△F1902

△UL Fuse 3A

QMF66U1-3R0S