

GDI

9/24,

RED ALERT™

**INSTALLATION
OPERATION
and SERVICE MANUAL
WITH PARTS LIST**

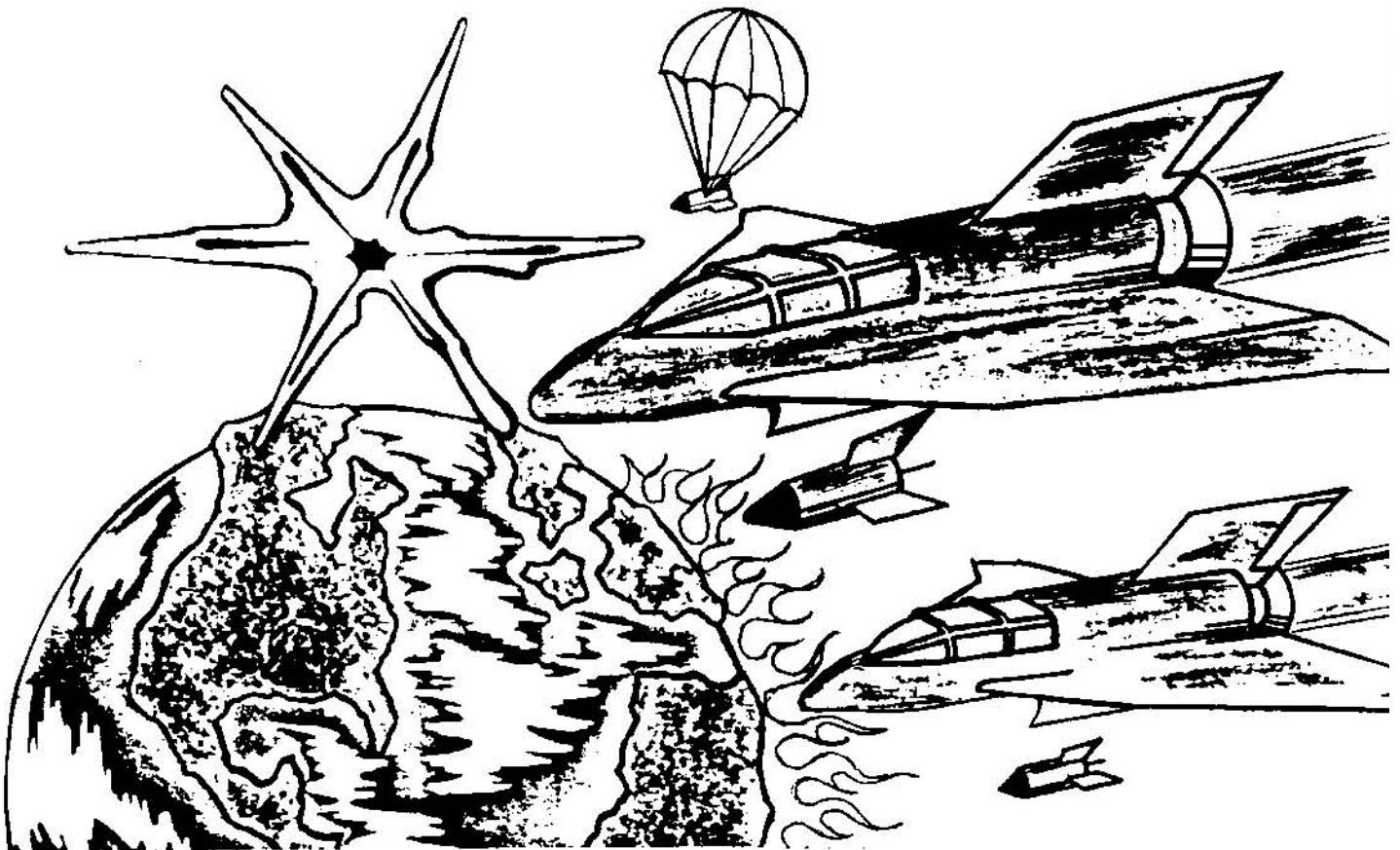

RED ALERT™ is manufactured by GDI, Inc, under license from IREM Inc, OSAKA, JAPAN

©GDI Inc. 1981 All Rights Reserved

WARNING: This equipment generates, uses, and can radiate radio frequency energy and if not installed and used in accordance with the instructions manual, may cause interference to radio communications. As temporarily permitted by regulation it has not been tested for compliance with the limits for Class A computing devices pursuant to Subpart J of Part 15 of FCC Rules, which are designed to provide reasonable protection against such interference. Operation of this equipment in a residential area is likely to cause interference in which case the user at his own expense will be required to correct the interference.

GAME SERIAL NUMBER LOCATION

The serial number of this game is on a plate located in back of the cabinet on the lower left hand side. Please use this number in any correspondence with your distributor for service.

RED ALERT™ is manufactured by GDI, inc., under license from IREM Inc, OSAKA, JAPAN

© GDI Inc. 1981 ALL RIGHTS RESERVED

CONTENTS

SECTION	PAGE
INSTALLATION	1
Receipt.....	1
Location	1
Installation	1
Installation Checkout Procedure	3
Sound and Game Control Adjustments	6
OPERATING INSTRUCTIONS	8
Controls	8
Play Preparations	9
Playing the Game	9
First Attack In Daylight.....	9
Second Attack By Helicopters	9
Third Attack At Night.....	9
Game Frames	10
Scoring	10
How Launchers Are Lost.....	10
MAINTENANCE	11
Introduction	11
Test Preparations.....	11
Graphic and Static RAM Test Program	11
Color RAM Test	11
Input/Output Tests	12
ROM Test.....	13
Sound Test	13
PARTS LIST	15
Character (M-33 Sub 2), GDI P/N A-20571, Parts List	16
Logic (M-33 Sub 3), GDI P/N A-20571, Parts List.....	17
Voice Assembly (UE-17B), GDI P/N A-20575, Parts List	18
Logic (M33-Sub 1), GDI P/N A-20565, Parts List	22
Audio (M-37B), GDI P/N 17B-20572, Parts List	23
Character (M-27S), GDI P/N 20569, Parts List	30
Main Logic (M-27M), GDI P/N B-20563, Parts List	34

List of Illustrations

	Page
Red Alert, Cabinet Model	Frontispeice
Major Components	2
Components Behind Coin Door	4
8 Switch DIP	4
Color Pattern	5
Preset Game Settings	7
Control Panel	8
Color Bar Pattern	12
Game Board, PCB Locations	43
Wiring Harness, Schematic Diagram	44
Main Logic, Block Diagram	45
Character (M-33 Sub 2), PCB	46
Character (M-33 Sub 2), Schematic Diagram	47
Logic PCB (M-33 Sub 3), Schematic Diagram	48
Logic PCB (M-33 Sub 3)	49
Voice (UE-17B), PCB	50
Voice PCB (UE-17B), Schematic Diagram	51
Logic (M-33 Sub 1), Schematic Diagram	52
Logic (M-33 Sub 1), PCB	53
Audio (M-37B), PCB	54
Audio (M-37B), Schematic Diagram (Sheet 1 of 2)	55
Audio (M-37B), Schematic Diagram (Sheet 2 of 2)	56
Character (M-27S), PCB	57
Character (M-27S), Schematic Diagram	58
Main Logic (M-27M), PCB	59
Main Logic (M-27M), Schematic Diagram (Sheet 1 of 2) .	60
Main Logic (M-27M), Schematic Diagram (Sheet 2 of 2) .	61



RED ALERT - Cabinet Model

ADDENDUM TO RED ALERT MANUAL

Previously labeled PROM RAGA on the Main Logic Board (GDI-20563) has been reprogrammed. The PROM is now labeled RAGAB. This change affects several pages in the Red Alert Manual, as follows:

<u>Page</u> <u>Affected</u>	<u>Change</u>
6	Change line 5 of ROM TEST DATA from 5AC4 to 5B84
13	Change line 5 of ROM TEST DATA from 5AC4 to 5B84
13	Change line 5 of Test Data from 5AC4 to 5B84

CAUTION: This machine may require degaussing when installed in it's proposed location, or moved to a new location. Degaussing is evident when color changes occur on the TV monitor as the cabinet is rotated from say, a north/south direction to an east/west orientation. The degaussing procedure is as follows:

1. Start degaussing on left-hand side of cabinet adjacent TV monitor.
2. Next, do right-hand side of cabinet.
3. Now, degauss TV monitor from a position in front of monitor.
4. Finally, continue degaussing from in front of TV monitor while slowly stepping backwards to a point about 5 feet from screen.
5. Then, rotate degausser until it's field is perpendicular to TV monitor before turning it "off".

INSTALLATION

RECEIPT

Carefully remove the game from the shipping carton. Inspect the cabinet exterior for any evidence of damage incurred in shipment. Report any damage to the carrier.

LOCATION

The game can be placed in it's proposed location upon receipt. Carefully choose one that is:

- o Within 10 feet of a grounded commercial 110 volt power outlet that is free of inductive loads (motors, etc).
- o Free of moisture and not a water collection area.
- o Out of the direct rays of the sun.

Check machine basic specifications table for additional considerations.

BASIC SPECIFICATIONS

Power Requirements	110 volts, 60 Hz
Temperature Range (includes storage)	0° C (32° F) Minimum 35° C (95° F) Maximum
Humidity Range	95% Maximum
Overall Dimensions	
Height	68.5 inches (1727mm)
Width	24.5 inches (622mm)
Depth	33.5 inches (851mm)
Shipping Weight	225 lbs (102 Kgm)

INSTALLATION

Install and check the game, as follows (see figs 1 and 2):

- o Unlock and remove back panel, using key obtained from small envelope stapled to rear door.
- o Locate power cord, coiled on bottom of cabinet interior, and extend cable out back of cabinet. Make sure strain relief knot in cable is positioned on inside of notch in lower right corner of cabinet opening.
- o Check that all wiring connections inside cabinet, especially those connectors on game logic board (green edge connector) and TV monitor chassis (white connector), are tight.

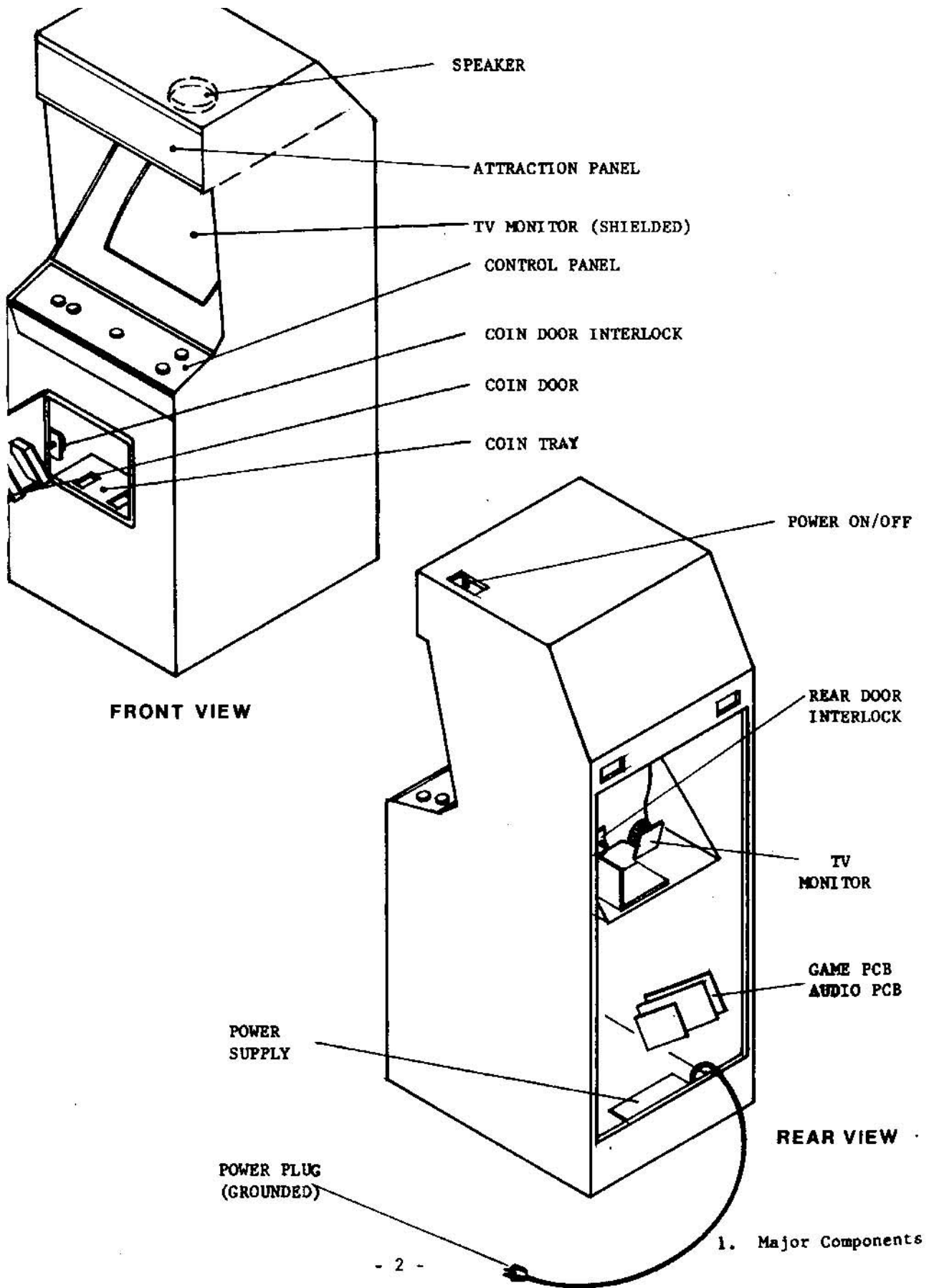

1. Major Components

- o Pull out to defeat interlock by rear door.
- o Connect power plug to power outlet.
- o Set power switch, located on top of cabinet, to ON.
- o Pull out to defeat interlock by coin door. This applies power to game. Note that two incandescent lamps inside coin door light, fluorescent lighted attraction panel above TV monitor lights, and TV monitor illuminates to display attraction sequence of game. Allow attraction sequence to repeat several cycles.
- o Depress coin switch on door to initiate playable game cycle.
- o Check audio level of game. Adjust volume control, located on coin door, to level desired.
- o Press interlock by coin door to disconnect power to game.
- o Perform Installation Checkout Procedure, given in following paragraph.
- o Take total coins meter reading.
- o Close coin door and lock.
- o Set power switch, located on top of cabinet, to OFF.
- o Replace back panel.
- o Level machine using steel levelers provided.

REPORT ANY PROBLEMS FOUND TO YOUR DISTRIBUTOR

INSTALLATION CHECKOUT PROCEDURE

This is an equipment self test diagnostic program, and is conducted as follows:

- o Unlock and remove back panel, using key provided.
- o Locate 8 switch DIP on game logic board (fig 3), and set switch 8 to ON.
- o Pull out to defeat rear door interlock.
- o Pull out to defeat interlock by coin door to restore power to game, and observe following TV monitor display;
 1. A random speckled color pattern for about 40 seconds.
 2. GR RAM OK message along with color sequencing for about 10 seconds.
 3. ST RAM OK message along with color sequencing for about 3 seconds.
 4. A recycling colored bar pattern.
- o Momentarily depress service credit switch on coin door (fig 2), and observe

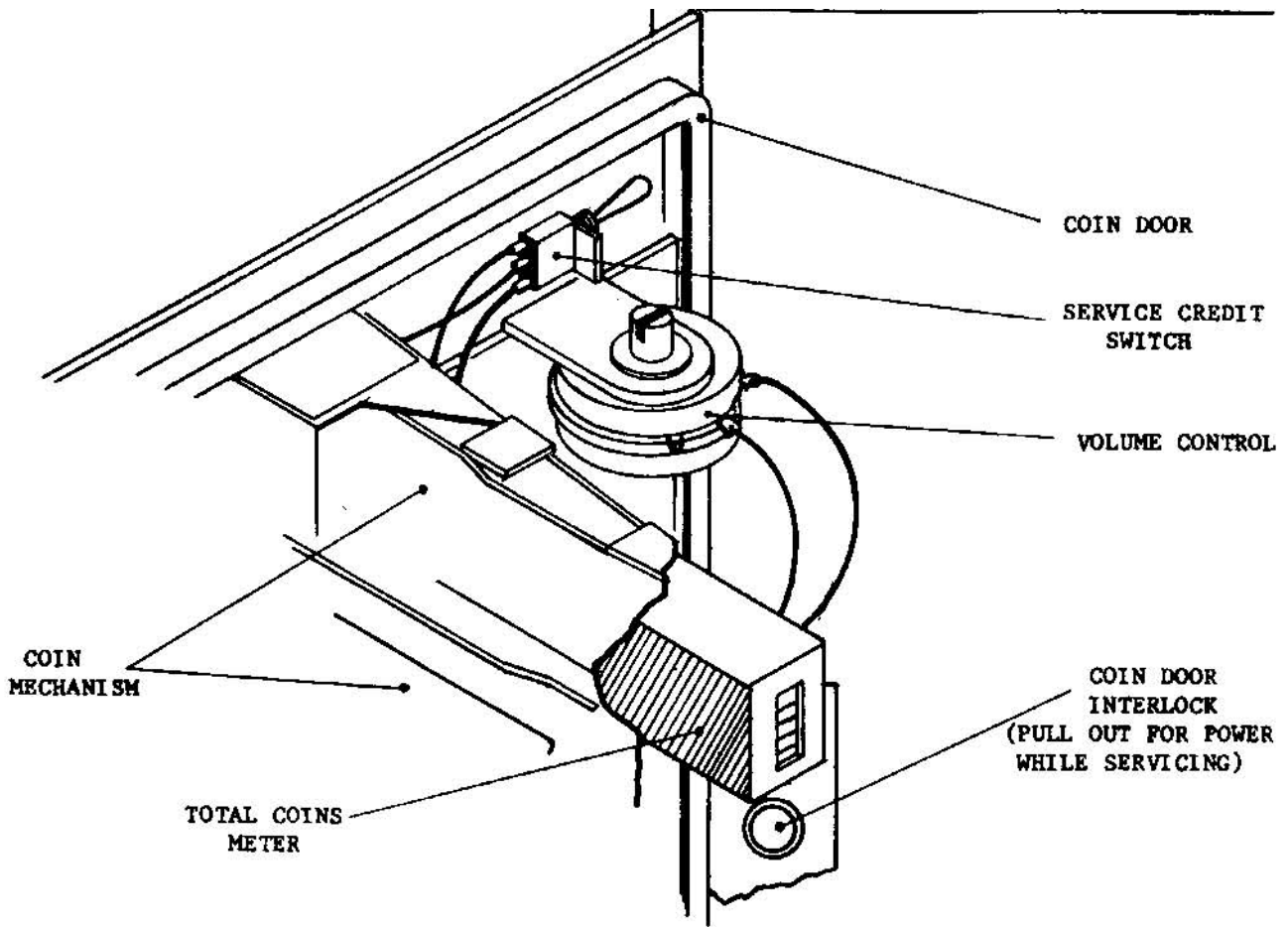

2. Components Behind Coin Door

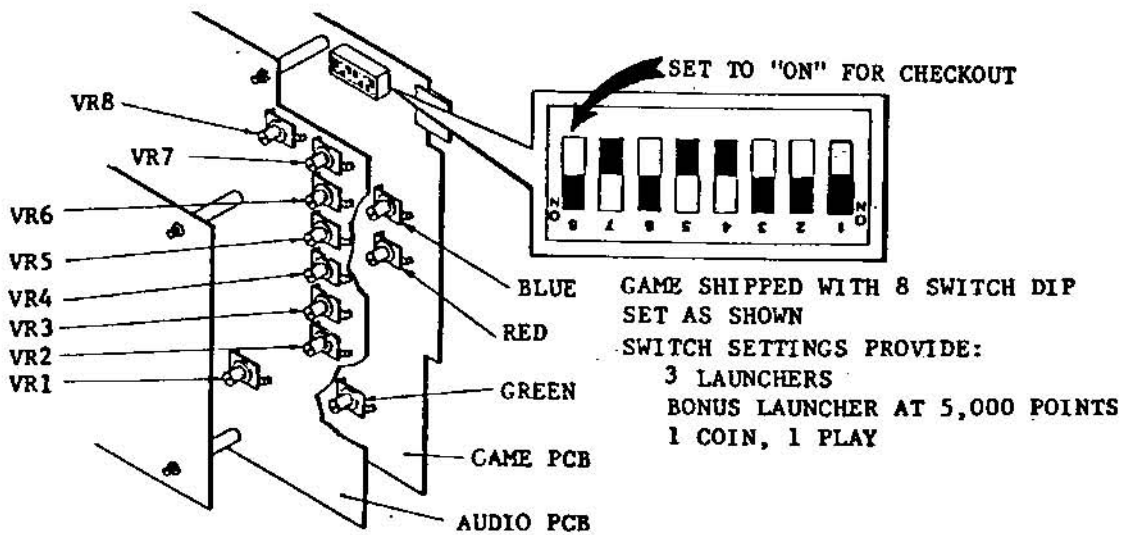

3. 8 Switch DIP

a stationary distinct color pattern TV monitor display (fig 4). Pattern does not have to be interpreted at this time. Simply that it appears.

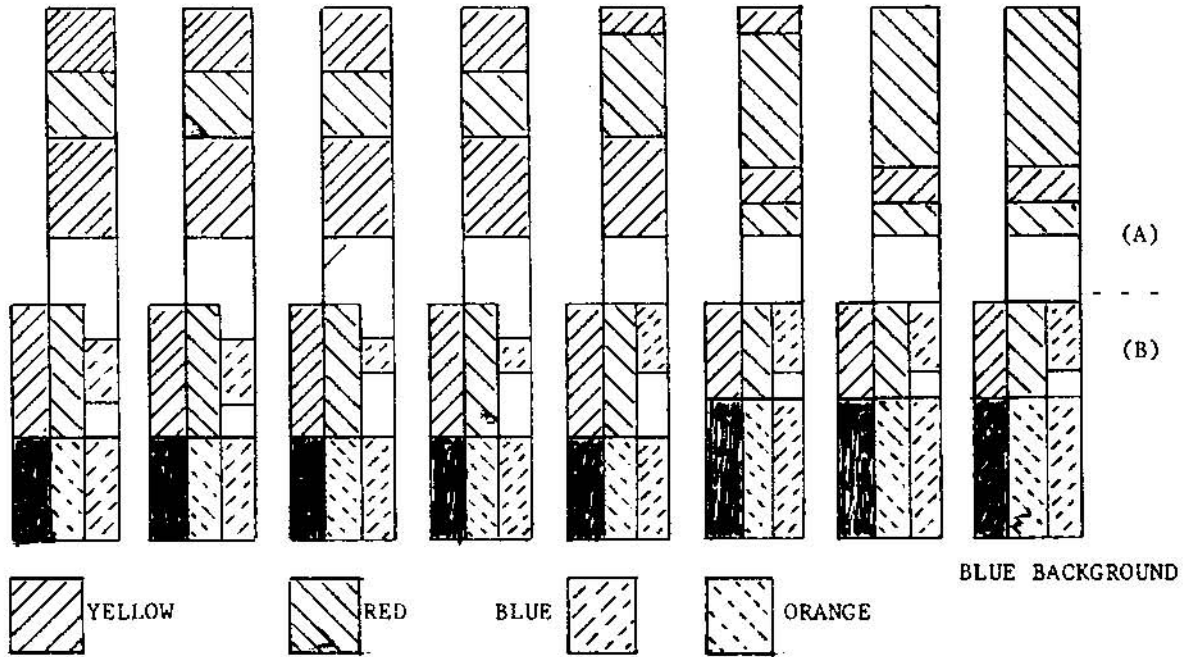

- (A) SINGLE COLORED OBJECTS, SUCH AS LETTERS
- (B) AIRCRAFT, ETC

4. Color Pattern

- o Momentarily depress service credit switch (fig 2) on coin door, and observe TV monitor displays;

DSW Dg

KEY 1 00

KEY 2 01

TIMING -- (a constantly running two digit (in Hex notation) clock)

- o Depress and hold LEFT control panel button down. Observe change in KEY 1 00 and KEY 2 01 displays - while button is held down.

KEY 1 00 changes to KEY 1 20

KEY 2 01 changes to KEY 2 21

- o Depress and hold RIGHT control panel button down. Observe change in KEY 1 00 and KEY 2 01 displays - while button is held down.

KEY 1 00 changes to KEY 1 40

KEY 2 01 changes to KEY 2 41

- o Depress and hold FIRE control panel button down. Observe change in KEY 1 00 and KEY 2 01 displays - while button is held down.

KEY 1 00 changes to KEY 1 04
KEY 2 01 changes to KEY 2 05

- o Depress 1 PLAYER control panel button down, and observe KEY 1 00 display changes to KEY 1 01 during button closure.
- o Depress and hold 2 PLAYER control panel button down, and observe KEY 1 00 display changes to KEY 1 02 during button closure.
- o Momentarily depress coin switch on coin door, and observe the following TV monitor display appears:

ROM TEST DATA

0	D2ED
1	9B83
2	42C9
3	BDA9
4	0355
5	5A66 5B84
6	0F07

THIS COMPLETES CHECKOUT PROCEDURE

- o Depress coin door interlock to remove game power.
- o Return switch 8 of 8 switch DIP on game logic board (fig 3) to OFF.

SOUND AND GAME CONTROL ADJUSTMENTS

These adjustments are located on the game logic and sound PCBs located inside the cabinet on the right side . All sounds are adjusted while game is in play at the point sound is audible. All DIP switches may be set with power disconnected from the equipment

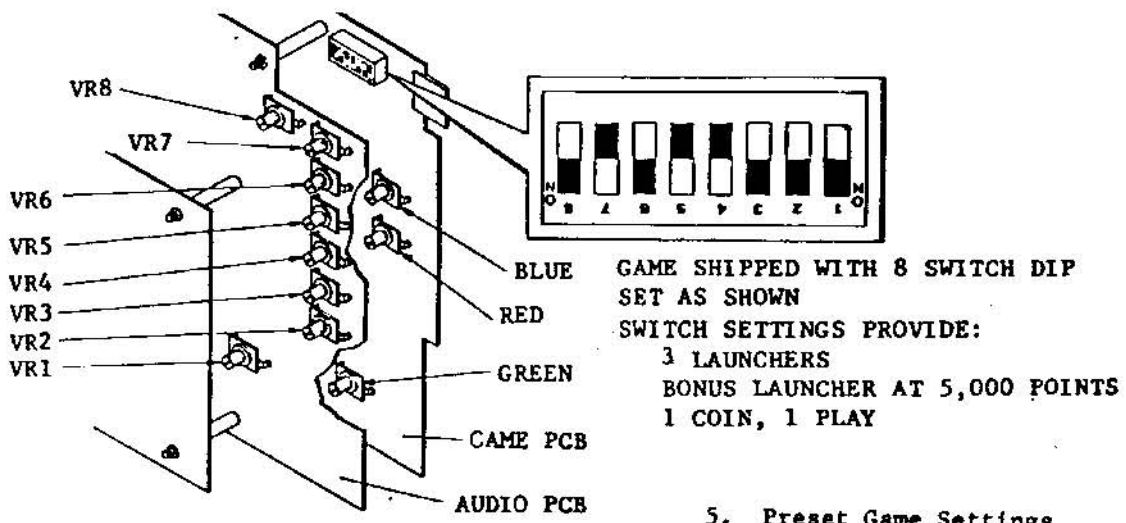

5. Preset Game Settings

GAME SOUND ADJUSTMENTS

VR NO.	ADJUSTS
1	Overall audio level of all sounds
2	All sounds associated with MIRV attack, including CAUTION
3	Dive bombing attacks
4	Firing of rocket launcher
5	Rocket launcher explosions and attacking aircraft hits
6	Formation and bomber aircraft
7	Hovering helicopters
8	Voice

8 SWITCH DIP

SWITCH NUMBER								GAME FUNCTION CONTROLLED
1	2	3	4	5	6	7	8	
OFF	OFF							3 launchers per player
ON	OFF							4 launchers per player
OFF	ON							5 launchers per player
ON	ON							6 launchers per player
			ON					Additional launcher on score of 5,000 points
			OFF					Additional launcher on score of 7,000 points
				OFF	OFF			Continuous free play
				ON	OFF			1 coin, 1 play
				OFF	ON			1 coin, 2 plays
				ON	ON			2 coins, 1 play
		OFF				ON		Upright cabinet. Do not disturb these switches
							OFF	Microprocessor in game mode
							ON	Microprocessor placed in diagnostic mode

COLOR ADJUSTMENTS - GREEN, RED, BLUE

OPERATING INSTRUCTIONS

CONTROLS

The functions of the control panel, and associated operating controls, are as follows:

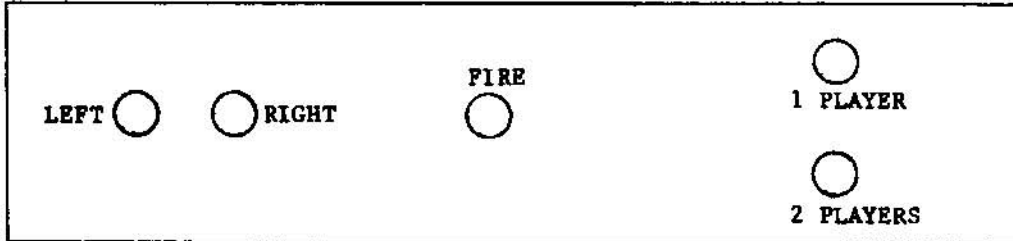

6. Control Panel

LEFT	Moves rocket launcher left when depressed
RIGHT	Moves rocket launcher right when depressed
FIRE	Fires rocket launcher when depressed (rocket must clear top of screen or destroy an aircraft or bomb before another rocket can be fired)
1 PLAYER	When momentarily depressed, game is initialized for one player only. Game continues until all rocket launchers are destroyed. Player and score is displayed on the upper left side of TV monitor.
2 PLAYER	When momentarily depressed, game is initialized for two players. Game is interrupted for first player when one of his rocket launchers is destroyed, and then initialized for second player. When second player loses a rocket launcher, game returns to point of interruption of first player, etc. Game continues until both players lose all their rocket launchers. Score of each player is displayed on top of TV monitor. Top score of day is displayed on top of TV monitor.
Coin door	Accepts coins in either slot, and all coins accepted are displayed as credits on lower right-hand side of TV monitor to a total of 99 credits. Depressing 1 PLAYER pushbutton on control panel subtracts one credit from total. Depressing 2 PLAYERS pushbutton subtracts two credits from total. Additional coins must be inserted to play game when credits displayed total 00.
Power on/off Switch	Located on top of cabinet adjacent right rear corner. Controls power to machine.

PLAY PREPARATIONS (with power on)

- o Insert coin(s) in either slot in coin door. All coins inserted, whether intended for single or double player play, are accepted as credits, and displayed on lower right-hand side of TV monitor.
- o Press 1 PLAYER button if a one player game is desired, or 2 PLAYERS button when competition between two players is desired. Game initializes for one player, or first of two players, by blinking SCORE (1) display, located on upper left side of TV monitor. In two player competition, game initializes for second player by blinking SCORE (2) TV monitor display, located on upper right-hand side of screen. Credit total decreases by 1 or 2, depending on player button depressed.

PLAYING THE GAME

FIRST ATTACK IN DAYLIGHT - BOMBERS IN FORMATION WITH ATTACKING AIRCRAFT. This sequence is introduced both audibly and visually. "Red alert. Enemy aircraft approaching fast. Many jet fighters approaching. 20 jet fighters approaching. Destroy all aircraft by 1100 hours or MIRV will be launched".

In this sequence, bombers in formation move from left to right across the screen, and then from right to left, etc. During the attack, some break formation and attack the launcher. The aircraft drop bombs in an attempt to hit the launcher. Also during the attack, a special red colored aircraft flying above the aircraft in formation appears and drops a red colored magaton bomb that slowly descends on country. When hours reach 1100, present fighter attack is interrupted by a flashing CAUTION on screen, followed by appearance of the MIRV.

The MIRV slowly descends, then breaks up into several bombs. They, in turn, also break up into several bombs. As a result, a shower of bombs slowly descend on the country.

Player participation during attack is to destroy all aircraft by firing rocket launcher. During the attack, player is to avoid direct hits by bombs - each of which costs him one rocket launcher. Also during the attack, player must destroy red bomb before it lands, or one rocket launcher is destroyed.

When MIRV appears, player must destroy it completely - otherwise the landing of any one will cost the player one launcher.

HINT: If you can't get out of the way of a bomb, shoot to destroy it.

SECOND ATTACK BY HELICOPTERS - DROPPING PARACHUTE BOMBS. Introduced by, " Helicopter squadron approaching. Destroy all helicopters by 1600 hours or MIRV will be launched".

Player participation during attack is to destroy all aircraft by firing rocket launcher. During the attack, player is to keep his launcher away from red areas created by exploding bombs - or loose a launcher. Both helicopters and bombs may be destroyed by rockets. However, if parachute, but not bomb, is hit, deflated parachute will drop bomb much faster.











MIRV attack, if launched, is a repeat of that in the first sequence above.

THIRD ATTACK AT NIGHT - HEAVY BOMBERS IN FORMATION. Introduced by, "Red alert. Night attack by bombers".

Player is aided by two searchlights. Object is to destroy all aircraft. When all aircraft are destroyed, game progresses to next frame (country). During attack, player must avoid direct hits by bombs. No time limit is imposed. No MIRV will be launched.

GAME FRAMES. Game repeats above cycles thru following countries, respectively: FRANCE, USA, ITALY, GREAT BRITAIN, GERMANY, JAPAN. However, as game progresses from frame to frame, the action of the game is stepped up.

SCORING. Scores for the game are totaled, as follows:

SCORING		
	JET FIGHTERS IN FORMATION	20 POINTS
	JET FIGHTER ATTACKING	40 POINTS
	JET FIGHTERS DESTROYED BY MEGATON BOMB	60 POINTS
	ATTACKING JET FIGHTERS DESTROYED BY MEGATON BOMB	100 POINTS
	RED BOMBER	100, 200, OR 400 POINTS
	HELICOPTER	50 POINTS
	OPEN PARACHUTE BOMB	20 POINTS
	CLOSED PARACHUTE BOMB	40 POINTS
	NIGHT BOMBER	40 POINTS
	MIRV	50 POINTS

HOW LAUNCHERS ARE LOST. Rocket launchers are lost by:

- o A direct hit by a dropped bomb
- o Red bomb dropped by red plane lands anywhere
- o Launcher is in red area created by exploding parachute bomb
- o MIRV lands anywhere

MAINTENANCE

INTRODUCTION

Red alert incorporates built-in diagnostics as a servicing aid in the location and correction of troubles, as well as a method for the checkout of the game. The diagnostics are performed using the 8 switch DIP, located on the logic PCB (page 7), in seven sequential test segments. These are, respectively:

- a. Graphic RAM
- b. Static RAM
- c. Color RAM
- d. PROM
- e. Input/Output
- f. EPROM
- g. Sounds

TEST PREPARATIONS

The game is prepared for testing, as follows:

1. Unlock and remove the back door.
2. Unlock and open the coin door.
3. Pull out to override the rear door interlock
4. Set switch 8 of the 8 switch DIP to ON.
5. Set on/off power switch to ON.

GRAPHIC AND STATIC RAM TEST PROGRAM

These two tests are automatically initiated in sequence when coin door interlock is pulled out to apply power to game. These tests check for decoding errors and other problems in addressing or data. Observe the following normal events:

- a. A random color speckled pattern for about 40 seconds
- b. GR RAM OK message along with color sequencing for about 10 seconds.
- c. ST RAM OK message along with color sequencing for about 10 seconds.
- d. A recycling changing colored bar pattern.

A static pattern indicates an abnormal condition. Verify by repeating tests. (All tests are repeated by momentarily interrupting power.)

COLOR RAM TEST

This test is initiated when the service credit switch, located adjacent the volume control (fig 2), is momentarily depressed. The TV monitor display is the following color bar pattern:

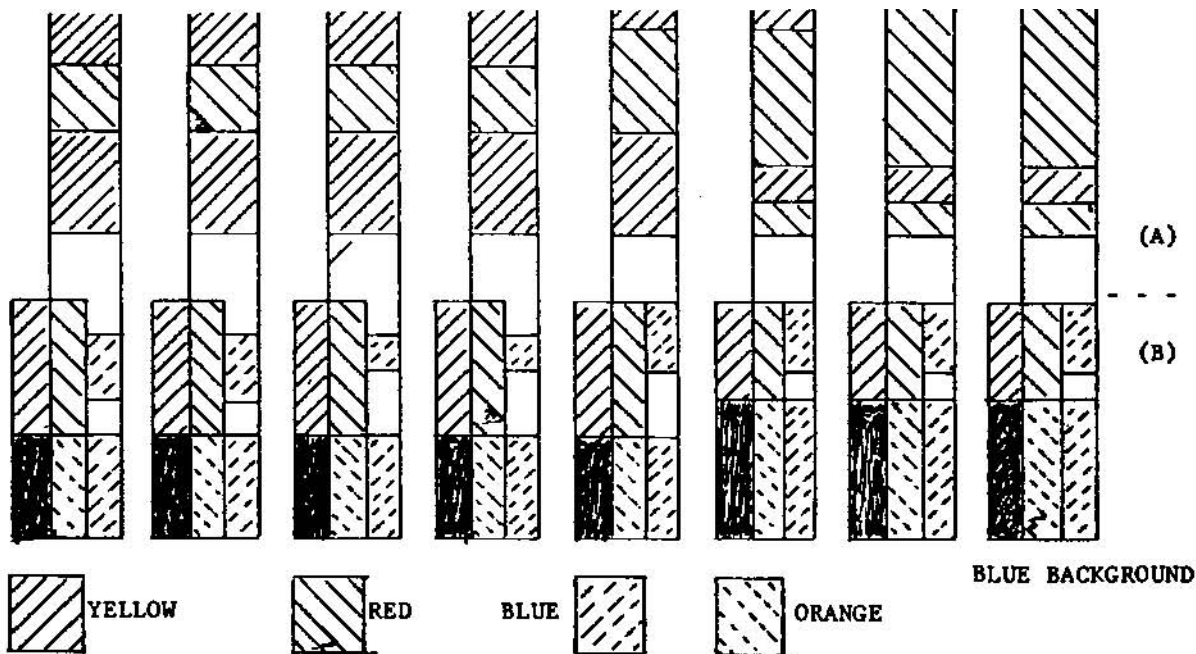

- (A) SINGLE COLORED OBJECTS, SUCH AS LETTERS
 (B) AIRCRAFT, ETC

7. Color Bar Pattern

All bordering between colors should be clearly defined. If not, adjust blue, red and green potentiometers on logic PCB until borders between red and orange are clearly defined.

INPUT/OUTPUT TESTS

This test is initiated when the service credit switch is momentarily depressed. The TV monitor displays:

DSW D8
 KEY 1 00
 KEY 2 01
 TIMING -- (a constantly running two digit (in Hex notation)
 clock)

Interpretation of the hexadecimal digits for each line is as follows:

Line 1 - DSW D8. DSW references the present condition of the 8 switch DIP; i.e., 8 the first four switches (1, 2, 3 and 4) and D the last four (5, 6, 7 and 8). Therefore, D8 signifies that switches 4, 5, 7, and 8 are on.

Line 2 - KEY 00. Condition of switches on control panel, as follows:

LEFT switch depressed displays 20
 RIGHT switch depressed displays 40
 FIRE switch depressed displays 04
 1 PLAYER switch depressed displays 01
 2 PLAYERS switch depressed displays 02

Line 3 - KEY 2 01. Condition of three control panel switches, along with those on line 2:

FIRE switch depressed displays 05
LEFT switch depressed displays 21
RIGHT switch depressed displays 41

Line 4 - TIMING -- Digits indicate number of times CPU is interrupted. Counting 00 through FF uniformly and then steadily recycling is the normal condition.

ROM TEST

The ROM test is a display of ROM TEST DATA on the TV monitor, as follows:

ROM TEST DATA

0	D2ED
1	9B83
2	42C9
3	BDA9
4	0355
5	5A04 5B84
6	0F07

The test is initiated when the service credit switch is momentarily depressed.

Interpretation of ROM TEST

ROM	Game Board Coordinates	Line	Test Data
5	3F	0	D2ED
6	3D	1	9B83
7	3B	2	42C9
8	3H	3	BDA9
9	3E	4	0355
A	3C	5	5A04 5B84
B	3A	6	0F07

SOUND TEST

The sound test is conducted at the completion of the ROM TEST without disturbing power to the equipment, as follows:

1. With the ROM TEST DATA display on the TV monitor, set all the switches on the 8 switch KIP to OFF. ROM TEST DATA display remains on TV monitor.
2. Momentarily depress service credit switch.

3. Carefully set first four DIP switches and note audible analogue sounds, as follows:

DIP SWITCH SETTINGS				Resultant Sounds
1	2	3	4	
OFF	OFF	OFF	OFF	Formation aircraft
ON	OFF	OFF	OFF	Dive bombers
OFF	ON	OFF	OFF	Helicopters
OFF	OFF	ON	OFF	Launcher firing
ON	OFF	ON	OFF	Explosion #1
OFF	ON	ON	OFF	Explosion #2
ON	ON	ON	OFF	Explosion #3

4. Set DIP switch 5 to ON. Keep DIP switches 6, 7 and 8 OFF.
5. Carefully set first four DIP switches and note audible digital sounds, as follows:

DIP SWITCH SETTINGS				Resultant Sounds
1	2	3	4	
OFF	OFF	OFF	OFF	Melody #1. Starting sound
ON	OFF	OFF	OFF	Melody #2. Ending sound
ON	ON	OFF	OFF	Time signal
ON	ON	ON	OFF	Chirping birds
OFF	OFF	OFF	ON	Alarm
ON	OFF	OFF	ON	Excellent
OFF	ON	OFF	ON	Coin insertion
ON	ON	OFF	ON	MIRV division
OFF	OFF	ON	ON	Megaton bomb - long
ON	OFF	ON	ON	Megaton bomb - short
OFF	ON	ON	ON	Megaton bomb landing

PARTS LIST

Character (M-33 Sub 2), GDI P/N A-20571, Parts List (fig 11)

Item	Symbol	Comp.Name	Description
1	R 1	Resister	220 ohm $\frac{1}{4}W$ 5%
2	R 2	"	100 ohm $\frac{1}{4}W$ 5%
3	R 3	"	390 ohm $\frac{1}{4}W$ 5%
4	R 4	"	180 ohm $\frac{1}{4}W$ 5%
5	R 5	"	220 ohm $\frac{1}{4}W$ 5%
6	R 6	"	"
7	R 7	"	390 ohm $\frac{1}{4}W$ 5%
8	R 8	"	180 ohm $\frac{1}{4}W$ 5%
9			
10			
11			
12			
13	IC	IC (TTL)	SN74LS472
14			
15			
16	CN 1	Connector	B 10P-SHF-1
17	"	"	"
18			
19			
20		PCB	M-33 SUB-2

Logic (M-33 Sub 3), GDI P/N A-20571, Parts List (fig 13)

Item	Symbol	Comp.Name	Description
1	CN 1	Connector	B10P-SHF-1
2	"	"	"
3	CN 2	"	BS8P-SHF-1
4			
5			
6	IC	IC (TTL)	SN74LS374
7			
8			
9			
10		PCB	M-33 SUB-3

Voice Assembly (UE-17B), GDI P/N A-20575, Parts List (Fig 15)

Item	Symbol	Comp.Name	Description
1	0	IC	SN74LS32N
2	1-A	IC (RAM)	i2114
3	1-B	" (")	"
4	1-C	IC	SN74LS365N
5	1-D	"	SN74LS132N
6	1-E	"	SN74LS86N
7	1-F	"	SN74LS138N
8	1-G	IC (CPU)	8085A
9	2-A	IC (EP-ROM)	i2532
10	2-C	" (")	"
11	2-E	" (")	"
12	2-F	" (")	"
13	2-H	IC	M51202L
14	3-A	IC (EP-ROM)	
15	3-C	" (")	
16	3-E	" (")	
17	3-F	" (")	
18	3-G	IC	8212
19	3-H	"	HC55516
20	3-J	IC (OP-AMP)	LM358
21	3-J	IC	SN74LS393N
22		IC (S-AMP)	
23			
24			
25			
26			
27	R 6	Resistor	100 ohm $\frac{1}{4}$ W 5%
28	R 7	"	4.7K ohm $\frac{1}{4}$ W 5%
29	R 8	"	"
30	R 9	"	10K ohm $\frac{1}{4}$ W 5%
31	R 10	"	1M ohm $\frac{1}{4}$ W 5%
32	R 11	"	
33	R 12	"	
34	R 13	"	10K ohm $\frac{1}{4}$ W 5%
35	R 14	"	100K ohm $\frac{1}{4}$ W 5%
36	R 15	"	120K ohm $\frac{1}{4}$ W 5%

Voice Assembly (UE-17B), GDI P/N A-20575, Parts List (fig 15)

Item	Symbol	Comp.Name	Description
37	R 16	Resistor	
38	R 17	"	220K ohm $\frac{1}{2}$ W 5%
39	R 18	"	10K ohm $\frac{1}{2}$ W 5%
40	R 19	"	6.8K ohm $\frac{1}{4}$ W 5%
41	R 20	"	2.2K ohm $\frac{1}{2}$ W 5%
42	R 21	"	"
43	R 22	"	4.7K ohm $\frac{1}{2}$ W 5%
44	R 23		
45	R 24	"	10 ohm $\frac{1}{2}$ W 5%
46	R 25	"	4.7K ohm $\frac{1}{2}$ W 5%
47	R 26	"	"
48	R 27	"	"
49			
50			
51	RA 1	Block Resistor	IHR-8-472JA
52			
53			
54	C 1	Capacitor	0.1uF 12V Cer.
55	C 2	"	"
56	C 3		
57	C 4	"	0.1uF 12V Cer.
58	C 5		
59	C 6	"	0.1uF 12V Cer.
60	C 7		
61	C 8	"	0.1uF 12V Cer.
62	C 9		
63	C 10	"	0.01uF.
64	C 11	"	0.1uF 12V Cer.
65	C 12		
66	C 13	"	0.1uF 12V Cer.
67	C 14	"	"
68	C 15		
69	C 16	"	0.1uF 12V Cer.
70	C 17		
72	C 18	"	0.1uF 12V Cer.

Voice Assembly (UE-17B), GDI P/N A-20575, Parts List (fig 15)

Item	Symbol	Comp.Name	Description
73	C 19		
74	C 20		
75	C 21	Capacitor	20pF
76	C 22		
77	C 23	"	20pF
78	C 24	"	0.1uF 12V Cer.
79	C 25		
80	C 26		
81	C 27		
82	C 28		
83	C 29		
84	C 30		
85	C 31		
85	C 32		
86	C 33		
87	C 34		
88	C 35	"	1uF 50V Elect.
89	C 36		
90	C 37	"	10uF 16V Elect.
91	C 38	"	"
92	C 39	"	"
93	C 40	"	.033uF Polyester
94	C 41	"	2200pF "
95	C 42	"	2200pF "
96	C 43		
97	C 44	"	0.1uF 12V Cer.
98	C 45	"	220pF Cer.
99			
100			
101	D 1	Diode	1S1588
102	D 2	"	"
103			
104	CN 1		
105	CN 2	Connector	BS8PSHF.1AA
106			

Voice Assembly (UE-17B), GDI P/N A-20575, Parts List (fig 15)

Item	Symbol	Comp.Name	Description
107			
108	XTAL	Crystal	HC18U 6MHz

Logic (M33-Sub 1), GDI P/N A-20565, Parts List (fig 17)

Item	Symbol	Comp.Name	Description
1	IC 1	IC (TTL)	74LS139
2	IC 2	" (")	74LS20
3	IC 3	" (")	74LS04
4	IC 4	" (")	74LS00
5			
6			
7	C 1	Capacitor	0.1u 12V Cer.
8	C 2	"	"
9	C 3	"	"
10	C 4	"	"
11			
12			
13	CH	Connector	B6P-SHF-1 .2
14			
15			
16		PCB	M-33 SUB-1

Audio (M-3/B), GDI P/N 1/B-20572, Parts List (fig 19)

Item	Symbol	Comp.Name	Description
1	IC 1	IC	SN74LS241
2	IC 2	"	SN74LS374
3	IC 3	IC (RAM)	12114
4	IC 4	" (")	"
5	IC 5	IC (EP-ROM)	12716
6	IC 6	IC (CPU)	6502
7	IC 7	IC	SN74LS138
8	IC 8	"	SN74LS74
9	IC 9	"	SN74LS107
10	IC 10	"	SN74LS121
11	IC 11	"	NE555
12	IC 12	"	SN74LS04
13	IC 13	"	SN74LS175
14	IC 14	"	SN74LS367
15	IC 15	"	SN74LS00
16	IC 16	"	M51202
17	IC 17	IC (SOUND G)	AY-3-8910
18	IC 18	IC	SN74LS32
19	IC 19	"	SN74LS14
20	IC 20	"	SN74LS02
21	IC 21	"	NE555
22	IC 22	"	"
23	IC 23	"	"
24	IC 24	"	SN74LS20
25	IC 25	"	SN74LS07
26	IC 26	"	NE555
27	IC 27	"	LN3900
28	IC 28	"	TA7222AP
29	IC 29	"	LM3900
30			
31			
32	R 1	Resistor	27K ohm $\frac{1}{4}$ W 5%
33	R 2	"	1K ohm $\frac{1}{4}$ W 5%
34	R 3	"	12.1K ohm $\frac{1}{4}$ W 5%
35	R 4	"	2.7K ohm $\frac{1}{4}$ W 5%

Item	Symbol	Comp.Name	Description
36	R 5	Resistor	1K ohm $\frac{1}{2}$ W 5%
37	R 6	"	330K ohm $\frac{1}{2}$ W 5%
38	R 7	"	"
39	R 8	"	3.9K ohm $\frac{1}{2}$ W 5%
40	R 9	"	1K ohm $\frac{1}{2}$ W 5%
41	R 10	"	150K ohm $\frac{1}{2}$ W 5%
42	R 11	"	1K ohm $\frac{1}{2}$ W 5%
43	R 12	"	220K ohm $\frac{1}{2}$ W 5%
44	R 13	"	10K ohm $\frac{1}{2}$ W 5%
45	R 14	"	220K ohm $\frac{1}{2}$ W 5%
46	R 15	"	2.2K ohm $\frac{1}{2}$ W 5%
47	R 16	"	10K ohm $\frac{1}{2}$ W 5%
48	R 17	"	27K ohm $\frac{1}{2}$ W 5%
49	R 18	"	10K ohm $\frac{1}{2}$ W 5%
50	R 19	"	1K ohm $\frac{1}{2}$ W 5%
51	R 20	"	"
52	R 21	"	"
53	R 22	"	"
54	R 23	"	56K ohm $\frac{1}{2}$ W 5%
55	R 24	"	- "
56	R 25	"	33K ohm $\frac{1}{2}$ W 5%
57	R 26	"	10K ohm $\frac{1}{2}$ W 5%
58	R 27	"	100K ohm $\frac{1}{2}$ W 5%
59	R 28	"	1K ohm $\frac{1}{2}$ W 5%
60	R 29	"	10K ohm $\frac{1}{2}$ W 5%
61	R 30	"	4.7K ohm $\frac{1}{2}$ W 5%
62	R 31	"	390K ohm $\frac{1}{2}$ W 5%
63	R 32	"	"
64	R 33	"	3.3K ohm $\frac{1}{2}$ W 5%
65	R 34	"	10K ohm $\frac{1}{2}$ W 5%
66	R 35	"	"
67	R 36	"	390K ohm $\frac{1}{2}$ W 5%
68	R 37	"	680K ohm $\frac{1}{2}$ W 5%
69	R 38	"	220 ohm $\frac{1}{2}$ W 5%
70	R 39	"	220K ohm $\frac{1}{2}$ W 5%

Audio (M-37B), GDI P/N A-20573, Parts List (fig 19)

Item	Symbol	Comp.Name	Description
71	R 40	Resistor	220K ohm $\frac{1}{2}$ W 5%
72	R 41	"	100K ohm $\frac{1}{2}$ W 5%
73	R 42	"	10K ohm $\frac{1}{2}$ W 5%
74	R 43	"	2.2M ohm 5%
75	R 44	"	10K ohm $\frac{1}{2}$ W 5%
76	R 45	"	4.7K ohm $\frac{1}{2}$ W 5%
77	R 46	"	560 ohm $\frac{1}{2}$ W 5%
78	R 47	"	1K ohm $\frac{1}{2}$ W 5%
79	R 48	"	"
80	R 49		
81	R 50	"	2.2K ohm $\frac{1}{2}$ W 5%
82	R 51	"	10K ohm $\frac{1}{2}$ W 5%
83	R 52	"	100K ohm $\frac{1}{2}$ W 5%
84	R 53	"	220K ohm $\frac{1}{2}$ W 5%
85	R 54	"	"
86	R 55	"	470K ohm $\frac{1}{2}$ W 5%
87	R 56	"	1K ohm $\frac{1}{2}$ W 5%
88	R 57	"	2.2K ohm $\frac{1}{2}$ W 5%
89	R 58	"	10K ohm $\frac{1}{2}$ W 5%
90	R 59	"	100K ohm $\frac{1}{2}$ W 5%
91	R 60	"	220K ohm $\frac{1}{2}$ W 5%
92	R 61	"	"
93	R 62	"	100K ohm $\frac{1}{2}$ W 5%
94	R 63	"	470K ohm $\frac{1}{2}$ W 5%
95	R 64	"	100K ohm $\frac{1}{2}$ W 5%
96	R 65	"	470K ohm $\frac{1}{2}$ W 5%
97	R 66	"	10K ohm $\frac{1}{2}$ W 5%
98	R 67	"	"
99	R 68	"	68K ohm $\frac{1}{2}$ W 5%
100	R 69	"	680K ohm $\frac{1}{2}$ W 5%
101	R 70	"	100K ohm $\frac{1}{2}$ W 5%
102	R 71	"	68K ohm $\frac{1}{2}$ W 5%
103	R 72	"	"
104	R 73	"	1.8M ohm $\frac{1}{2}$ W 5%
105	R 74	"	220 ohm $\frac{1}{2}$ W 5%

Audio (M-37B), GDI P/N A-20573, Parts List (fig 19)

Item	Symbol	Comp.Name	Description
106	R 75	Resistor	47K ohm $\frac{1}{4}$ W 5%
107	R 76	"	1.5K ohm $\frac{1}{2}$ W 5%
108	R 77	"	10K ohm $\frac{1}{4}$ W 5%
109	R 78	"	2.2K ohm $\frac{1}{2}$ W 5%
110	R 79	"	"
111	R 80	"	220 ohm $\frac{1}{4}$ W 5%
112	R 81	"	10K ohm $\frac{1}{2}$ W 5%
113	R 82	"	"
114	R 83	"	100K ohm $\frac{1}{4}$ W 5%
115	R 84	"	47K ohm $\frac{1}{2}$ W 5%
116	R 85	"	"
117			
118			
119	VR 1	Semifixed Resistor	VZ103KSL2 50K ohm
120	VR 2	"	"
121	VR 3	"	"
122	VR 4	"	"
123	VR 5	"	"
124	VR 6	"	"
125	VR 7	"	"
126	VR 8	"	"
127			
128			
129	C 1	Capacitor	1uF 12V Cer.
130	C 2	"	
131	C 3	"	
132	C 4	"	
133	C 5	"	
134	C 6	"	
135	C 7	"	
136	C 8	"	
137	C 9	"	
138	C 10	"	33pF Cer.
139	C 11	"	0.01uF Cer.

Audio (M-37B), GDI P/N A-20573, Parts List (fig 19)

Item	Symbol	Comp.Name	Description
140	C 12	Capacitor	0.1uF 12V Cer.
141	C 13	"	100pF 50V Cer.
142	C 14	"	0.01uF 50V Cer.
143	C 15	"	0.1uF 12V Cer.
144	C 16	"	"
145	C 17	"	"
146	C 18	"	"
147	C 19	"	10uF 16V Elect.
148	C 20	"	47uF 16V "
149	C 21	"	0.1uF 50V Mylar.
150	C 22	"	0.01uF 50V "
151	C 23	"	0.1uF 12V Cer.
152	C 24	"	0.01uF 50V Mylar.
153	C 25	"	"
154	C 26	"	0.1uF 12V Cer.
155	C 27	"	0.01uF 50V Mylar.
156	C 28	"	"
157	C 29	"	0.1uF 12V Cer.
158	C 30	"	0.33uF 50V Mylar.
159	C 31	"	0.1uF 12V Cer.
160	C 32	"	0.1uF 12V Cer.
161	C 33	"	10uF 16V Elect.
162	C 34	"	0.01uF 50V Mylar.
163	C 35	"	22uF 10V Elect.
164	C 36	"	2.2uF 16V Elect.
165	C 37	"	0.1uF 12V Cer.
166	C 38	"	"
167	C 39	"	"
168	C 40	"	0.0047uF 50V Mylar.
169	C 41	"	0.1uF 12V Cer.
170	C 42	"	0.001uF 50V Mylar.
171	C 43	"	1uF 50V Elect.
172	C 44	"	0.01uF 50V Mylar.
173	C 45	"	100uF 10V Elect.

Audio (M-37B), GDI P/N A-20573, Parts List (fig 19)

Item	Symbol	Comp.Name	Description
174	C 46	Capacitor	0.1uF 35V Tantalum.
175	C 47	"	47uF 16V Elect.
176	C 48	"	0.047uF 50V Mylar.
177	C 49	"	0.1uF 12V Cer.
178	C 50	"	"
179	C 51	"	0.0047uF 50V Cer.
180	C 52	"	47uF 16V Elect.
181	C 53	"	10uF 16V Elect.
182	C 54	"	10uF 25V Tantalum.
183	C 55	"	0.1uF 50V Mylar.
184	C 56	"	0.1uF 12V Cer.
185	C 57	"	100uF 25V Elect.
186	C 58	"	1000uF 10V "
187	C 59	"	0.047uF 50V Mylar.
188	C 60	"	100uF 25V Elect.
189	C 61	"	1uF 50V Elect.
190	C 62	"	47uF 16V Elect.
191	C 63	"	0.1uF 12V Cer.
192	C 64	"	0.0022uF 50V Mylar.
193	C 65	"	470pF 50V Cer.
194	C 66	"	680pF 50V Cer.
195	C 67	"	1uF 50V Elect.
196	C 68	"	10uF 16V Elect.
197	C 69	"	10uF 16V "
198	C 70	"	0.01uF 50V Mylar.
199	C 71	"	0.1uF 12V Cer.
200	C 72	"	"
201	C 73	"	"
202	C 74	"	"
203	C 73	"	"
204	C 74	"	"
205	C 75	"	10uF 16V Elect.
206			
207			

Audio (M-37B), GDI P/N A-20573, Parts List (fig 19)

Item	Symbol	Comp.Name	Description
208	D 1	Diode	1S1588
209	D 2	"	"
210	D 3	"	"
211	D 4	"	"
212	D 5	"	"
213	D 6	"	"
214			
215			
216	IC 5	IC Socket	IC 30-2406 (24p)
217	IC 6	"	IC 30-040-350(40p)
218	IC 17	"	"
219			
220			
221			
222		Crystal	HC18U 12.5KHZ
223			
224			
225	TR 1	Transistor	2SC18150
226	TR 2	"	2SA1015Y
227	TR 3	"	2SC18150
228	TR 4	"	"
229	TR 5	"	"
230	TR 6	"	"
231	TR 7	"	"
232	TR 8	"	"
233	TR 9	"	"
234	TR 10	"	"
235			
236			
237		Connector	PC26- AB
238			
239		Radiator	UD-400593
240			
241			

Character (M-27S), GDI P/N A-20569, Parts List (fig 22)

Item	Symbol	Comp. Name	Description
1	1-A	IC	10P-HVQ .2
2	1-B	"	
3	1-C	"	
4	1-D	"	
5	1-E	"	i2114
6	1-F	"	"
7	1-G	"	SN74LS157N
8	1-H	"	"
9	1-J	"	"
10	1-K	"	
11	2-A	"	SN74LS173N
12	2-B	"	SN74LS175N
13	2-C	"	"
14	2-D	"	SN74LS241N
15	2-E	"	i8216
16	2-F	"	"
17	2-G	"	SN74LS157N
18	2-H	"	"
19	2-J	"	"
20	2-K	"	"
21	3-A	"	SN74LS367N
22	3-B	"	SN74LS173N
23	3-C	"	SN74LS175N
24	3-D	"	"
25	3-E	"	i8216
26	3-F	"	"
27	3-G	"	i2114
28	3-H	"	"
29	3-J	"	"
30	3-K	"	"
31			
32	4-B	IC	SN74LS85N
33	4-C	"	SN74LS166N
34	4-D	"	"
35	4-E	"	i8216
36	4-F	"	"

Character (M-27S), GDI P/N A-20569, Parts List (fig 22)

Item	Symbol	Comp.Name	Description
37	4-G	IC	SN74LS175N
38	4-H	"	"
39	4-J	"	i2114
40	4-K	"	"
41			
42	5-B	IC	SN74LS08N
43	5-C	"	SN74LS157N
44	5-D	"	SN74LS32N
45	5-E	"	SN74LS04N
46	5-F	"	"
47	5-G	"	SN74LS166N
48	5-H	"	"
49	5-J	"	SN74LS139N
50			
51			
52			
53			
54			
55	R 1	Resistor	1K $\frac{1}{2}$ W 5%
56	R 2	"	"
57	R 3	"	"
58	R 4	"	"
59	R 5	"	"
60			
61			
62			
63			
64			
65			
66			
67			
68	C 1	Capacitor	.1uF 12V Cer
69	C 2	"	"
70	C 3	"	"
71	C 4	"	"

Character (M-27S), GDI P/N A-20569, Parts List (fig 22)

Item	Symbol	Comp.Name	Description
72	C 5	Capacitor	.1uF 12V Cer.
73	C 6	"	"
74	C 7	"	"
75	C 8	"	"
76	C 9	"	"
77	C 10	"	"
78	C 11	"	"
79	C 12	"	"
80	C 13	"	"
81	C 14	"	"
82	C 15	"	"
83	C 16	"	"
84	C 17	"	"
85	C 18	"	"
86	C 19	"	"
87	C 20	"	"
88	C 21	"	"
89	C 22	"	"
90	C 23	"	"
91	C 24	"	"
92	C 25	"	"
93	C 26	"	"
94	C 27	"	"
95	C 28	"	"
96	C 29	"	"
97	C 30	"	"
98	C 31	"	"
99	C 32	"	"
100	C 33	"	"
101	C 34	"	"
102	C 35	"	"
103	C 36	"	"
104	C 37	"	"
105	C 38	"	"
106	C 39	"	"

Character (M-27S), GDI P/N A-20569, Parts List (fig 22)

Item	Symbol	Comp.Name	Description
107	C 40	Capacitor	.1uF 12V Cer
108	C 41	"	"
109	C 42	"	"
110	C 43	"	"
111	C 44	"	"
112	C 45	"	"
113	C 46	"	"
114			
115		Connector	FCP26
116		"	FCF40

Main Logic (M-27M), GDI P/N B-20563, Parts List (fig 24)

Item	Symbol	Comp.Name	Description
1		IC (CPU)	B10P-IVQ .2
2	1-A	IC	SN74LS374N
3	1-B	"	"
4	1-H	"	SN74LS368AN
5	1-I	"	"
6	2-A	"	SN74LS151AN
7	2-B	"	SN74LS164N
8	2-C	"	SN74LS175N
9	2-D	"	SN74LS00N
10	2-E	"	TC4016BP
11	2-F	"	SN74LS368AN
12	2-H	"	"
13	2-J	"	"
14	2-K	"	i8216
15	2-L	"	"
16	3-A	IC (EP-ROM)	i27320orT2532
17	3-B	" (")	"
18	3-C	" (")	"
19	3-D	" (")	"
20	3-E	" (")	"
21	3-F	" (")	"
22	3-H	" (")	"
23	3-J	" (")	"
24	4-A	IC	SN74LS166N
25	4-B	"	"
26	4-C	"	SN74LS86N
27	4-D	"	SN74LS04N
28	4-E	"	SN74LS00N
29	4-F	"	SN74LS08N
30	4-H	"	SN74LS367N
31	4-J	"	"
32	5-A	"	SN74LS174N
33	5-B	"	SN74LS241N
34	5-C	"	SN74LS174N
35	5-D	"	SN74LS02N
36	5-E	"	SN74LS00N

Main Logic (M-27M), GDI P/N B-20563, Parts List (fig 24)

Item	Symbol	Comp.Name	Description
37	5-F	Connector	B10P-HVQ .2
38	5-H	IC	SN74LS138N
39	5-J	"	SN74LS367N
40	3L	"	SN74LS138N
41	6-B	IC (RAM)	i4116
42	6-C	" (")	"
43	6-D	" (")	"
44	6-E	" (")	"
45	6-F	" (")	"
46	6-H	" (")	"
47	6-J	" (")	"
48	6-K	" (")	"
49	7-B	IC	SN74LS153N
50	7-C	"	"
51	7-D	"	"
52	7-E	"	"
53	7-F	"	SN74LS175N
54	7-H	IC (RAM)	i4027
55	7-J	" (")	"
56	- 7-K	" (")	" -
57	8-A	IC	SN74LS374N
58	8-C	"	SN74LS86N
59	8-D	"	SN74LS83AN
60	8-E	"	SN74LS86N
61	8-F	"	"
62	8-H	"	SN74LS174N
63	8-J	"	SN74LS14N
64	8-K		
65	8-L	IC	SN74LS74N
66	9-B	"	SN74LS20N
67	9-C	"	SN74LS86N
68	9-D	"	
69	9-E	"	SN74LS161AN
70	9-F	"	SN74LS367N
71	9-H	"	SN74LS173N
72	9-J	"	SN74LS02N

Main Logic (M-27M), GDI P/N B-20563, Parts List (fig 24)

Item	Symbol	Comp. Name	Description
73	9-K	IC	LS1202
74	9-L	"	W555P
75	10-A	"	SN74LS04N
76	10-B	"	SN74LS10N
77	10-C	"	SN74LS161AN
78	10-D	"	
79	10-E	"	SN74LS161AN
80	10-F	"	SN74LS367N
81	10-H	"	SN74LS00N
82	10-J	"	SN74LS10N
83	10-K	"	SN74LS161AN
84	10-I	"	SN74LS04N
85	11-A	"	SN74LS161AN
86	11-B	"	SN74LS27N
87	11-C	"	SN74LS161N
88	11-D	"	
89	11-E	"	SN74LS161AN
90	11-H	"	SN74LS04N
91	11-J	"	SN74LS08N
92	11-K	"	SN74LS164N
93			
94			
95			
96			
97			
98	TR 1	Transistor	2SC710
99			
100	TR 3	"	2SC2120
101	TR 4	"	"
102	TR 5	"	2SC710
103			
104			
105	TR 8	"	"
106	TR 9	"	2SC2120
107			
108			

Main Logic (M-27M), GDI P/N B-20563, Parts List (fig 24)

Item	Symbol	Comp.Name	Description
109			
110	D I	Diode	1S1588
111			
112			
113	R 1	Resistor	470 ohm $\frac{1}{2}$ W 5%
114	R 2	"	1K $\frac{1}{2}$ W 5%
115			
116	R 4	"	270 Ohm $\frac{1}{2}$ W 5%
117	R 5	"	2.2K $\frac{1}{2}$ W 5%
118	R 6	"	1.5K $\frac{1}{2}$ W 5%
119	R 7	"	220 ohm $\frac{1}{2}$ W 5%
120			
121	R 9	"	"
122	R 10	"	1K $\frac{1}{2}$ W 5%
123	R 11	"	470 ohm $\frac{1}{2}$ W 5%
124	R 12	"	1K $\frac{1}{2}$ W 5%
125	R 13	"	"
126	R 14	"	"
127	R 15	"	"
128	R 16	"	"
129			
130	R 18	"	270 ohm $\frac{1}{2}$ W 5%
131	R 19	"	2.2K $\frac{1}{2}$ W 5%
132	R 20	"	1.5K $\frac{1}{2}$ W 5%
133	R 21	"	220 ohm $\frac{1}{2}$ W 5%
134			
135			
136	R 24	"	220 ohm $\frac{1}{2}$ W 5%
137	R 25	"	1.5K $\frac{1}{2}$ W 5%
138	R 26	"	2.2K $\frac{1}{2}$ W 5%
139	R 27	"	270 ohm $\frac{1}{2}$ W 5%
140			
141	R 29	"	10K $\frac{1}{2}$ W 5%
142	R 30	"	10K $\frac{1}{2}$ W 5%
143	R 31	"	470 ohm $\frac{1}{2}$ W 5%
144	R 32	"	10K $\frac{1}{2}$ W 5%

Main Logic (M-27M), GDI P/N B-20563, Parts List (fig 24)

Item	Symbol	Comp.Name	Description
145	R 33	Resistor	
146	R 34	"	1K $\frac{1}{4}$ W 5%
147	R 35	"	100 ohm $\frac{1}{4}$ W 5%
148	R 36	"	"
149	R 37	"	1K $\frac{1}{4}$ W 5%
150	R 38	"	"
151	R 39	"	47K $\frac{1}{4}$ W 5%
152	R 40	"	1K $\frac{1}{4}$ W 5%
153	R 41	"	12K $\frac{1}{4}$ W 5%
154	R 42	"	1K $\frac{1}{4}$ W 5%
155	R 43	"	330 ohm $\frac{1}{4}$ W 5%
156	R 44	"	"
157	R 45	"	1K $\frac{1}{4}$ W 5%
158	R 46	"	"
159	R 47	"	"
160	R 48	"	100 ohm $\frac{1}{4}$ W 5%
161	R 49	"	"
162	R 50	"	"
163	R 51		
164	R 52		
165	R 53		
166	R 54		
167	R 55	Resistor	470 ohm $\frac{1}{4}$ W 5%
168	R 56	"	"
169			
170			
171			
172			
173			
174			
175	C 1	Capacitor	22pF 50V Cer
176	C 2	"	.047uF 50V Mylar
177	C 3	"	.1uF 12V Cer.
178	C 4	"	
179	C 5	"	.1uF 12V Cer.
180	C 6	"	22pF 50V Cer.

Item	Symbol	Comp.Name	Description
181	C 7	Capacitor	.047uF 50V Mylar
182	C 8	"	"
183	C 9	"	22pF 50V Cer
184	C 10	"	1uF 12V Cer
185	C 11	"	"
186	C 12	"	"
187	C 13	"	.1uF 12V Cer
188	C 14	"	"
189	C 15	"	"
190	C 16	"	"
191	C 17	"	"
192	C 18	"	"
193	C 19	"	"
194	C 20	"	"
195	C 21	"	"
196	C 22	"	"
197	C 23	"	"
198	C 24	"	"
199	C 25	"	"
200	C 26	"	"
201	C 27	"	"
202	C 28	"	"
203	C 29	"	"
204	C 30	"	"
205	C 31	"	"
206	C 32	"	"
207	C 33	"	"
208	C 34	"	"
209	C 35	"	"
210	C 36	"	"
211	C 37	"	"
212	C 38	"	"
213	C 39	"	"
214	C 40	"	"
215	C 41	"	"

Main Logic (M-27M), GDI P/N B-20563, Parts List (fig 24)

Item	Symbol	Comp.Name	Description
216	C 42	Capacitor	.1uF 12V Cer
217	C 43	"	"
218	C 44	"	"
219	C 45	"	"
220	C 46	"	"
221	C 47	"	"
222	C 48	"	"
223	C 49	"	"
224	C 50	"	"
225	C 51	"	"
226	C 52	"	"
227	C 53	"	"
228	C 54	"	"
229	C 55	"	"
230	C 56	"	"
231	C 57	"	"
232	C 58	"	"
233	C 59	"	"
234	C 60	"	"
235	C 61	"	"
236	C 62	"	"
237	C 63	"	"
238	C 64	"	"
239	C 65	"	"
240	C 66	"	"
241	C 67	"	"
242	C 68	"	"
243	C 69	"	"
244	C 70	"	"
245	C 71	"	"
246	C 72	"	47uF 16V Elect .
247	C 73	"	"
248	C 74	"	1uF 12V Cer.
249	C 75	"	"
250	C 76	"	"

Main Logic (M-27M), GDI P/N B-20563, Parts List (Fig 24)-

Item	Symbol	Comp.Name	Description
251	C 77	Capacitor	.1uF 12V Cer
252	C 78	"	"
253	C 79	"	47uF 16V Erect.
254	C 80	"	.1uF 12V Cer.
255	C 81	"	"
256	C 82	"	"
257	C 83	"	"
258	C 84	"	"
259	C 85	"	"
260	C 86	"	"
261	C 87	"	"
262	C 88	"	1uF 50V Elect.
263	C 89	"	"
264	C 90	"	.1uF 12V Cer.
265	C 91	"	"
266	C 92	"	"
267	C 93	"	"
268	C 94	"	"
269	C 95	"	"
270	C 96	"	"
271	C 97	"	"
272	C 98	"	"
273	C 99	"	100pF 50V Cer.
274	C 100	"	10uF 16V Elect.
275	C 101	"	"
276	C 102	"	"
277			
278			
279			
280			
281	VR 1	Semifixed Resistor	VZ103KSL2 B5K ohm
282	VR 2	"	"
283	VR 3	"	"
284			
285			

Main Logic (M-27M), GDI P/N B-20563, Parts List (fig 24)

Item	Symbol	Comp.Name	Description
286			
287			
288	RA 1	Block Resistor	IHR-8-102JA
289	RA 2	"	"
290	RA 3	"	"
291			
292			
293			
294	X 1	Crystal	HC18U 12.5MHz
295			
296			
297			
298		DIP-SW	(8P)
299			
300			
301		IC-Socket	ICC-03-040-350T (40P)
302		"	IC30-2406 (24P)
303			
304			
305		Connector	FCP26
306		"	FCP40
307			
308			
309			
310		Spacer	UD400332

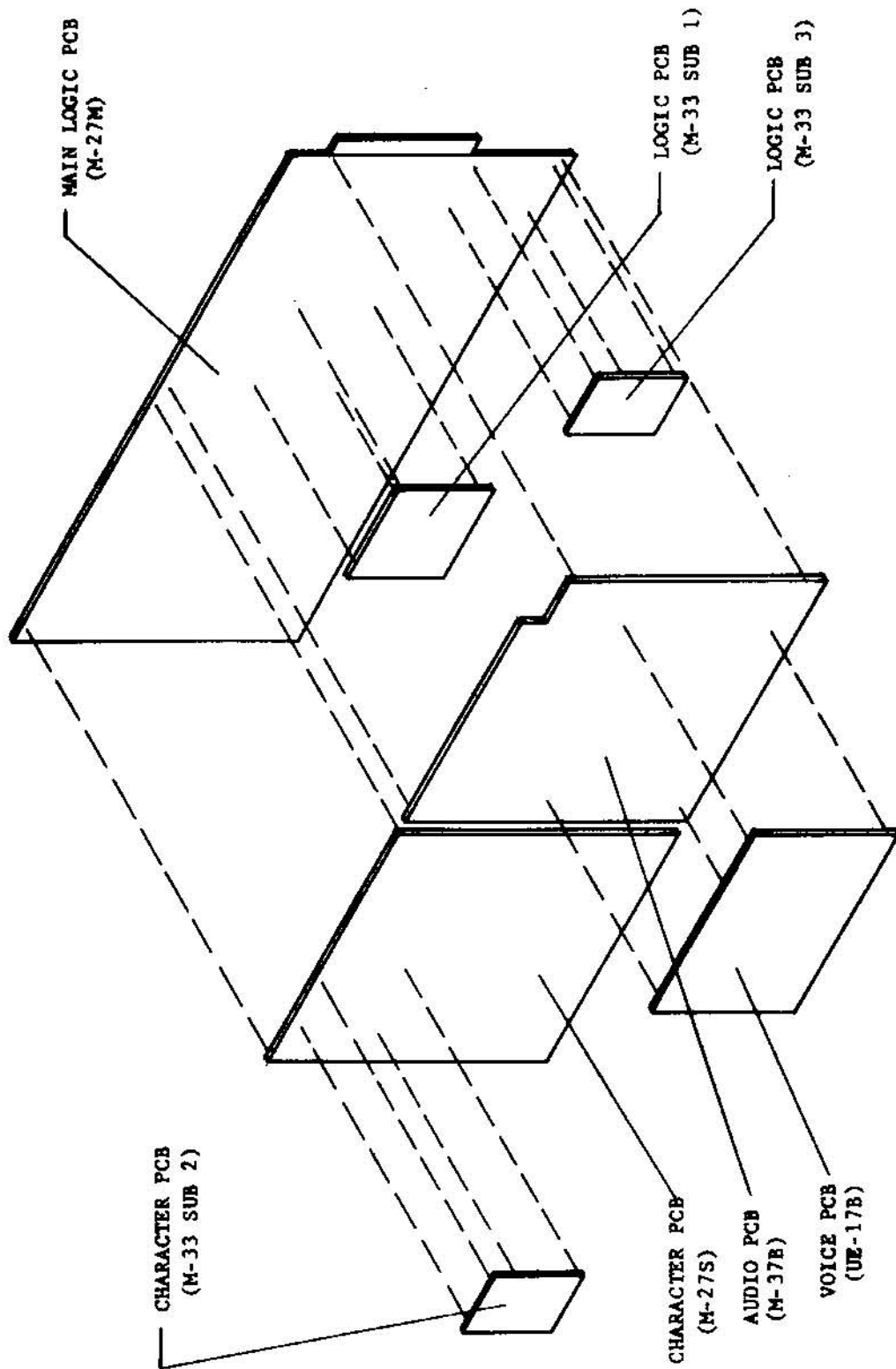

8. Game Board Assembly, PCB Locations

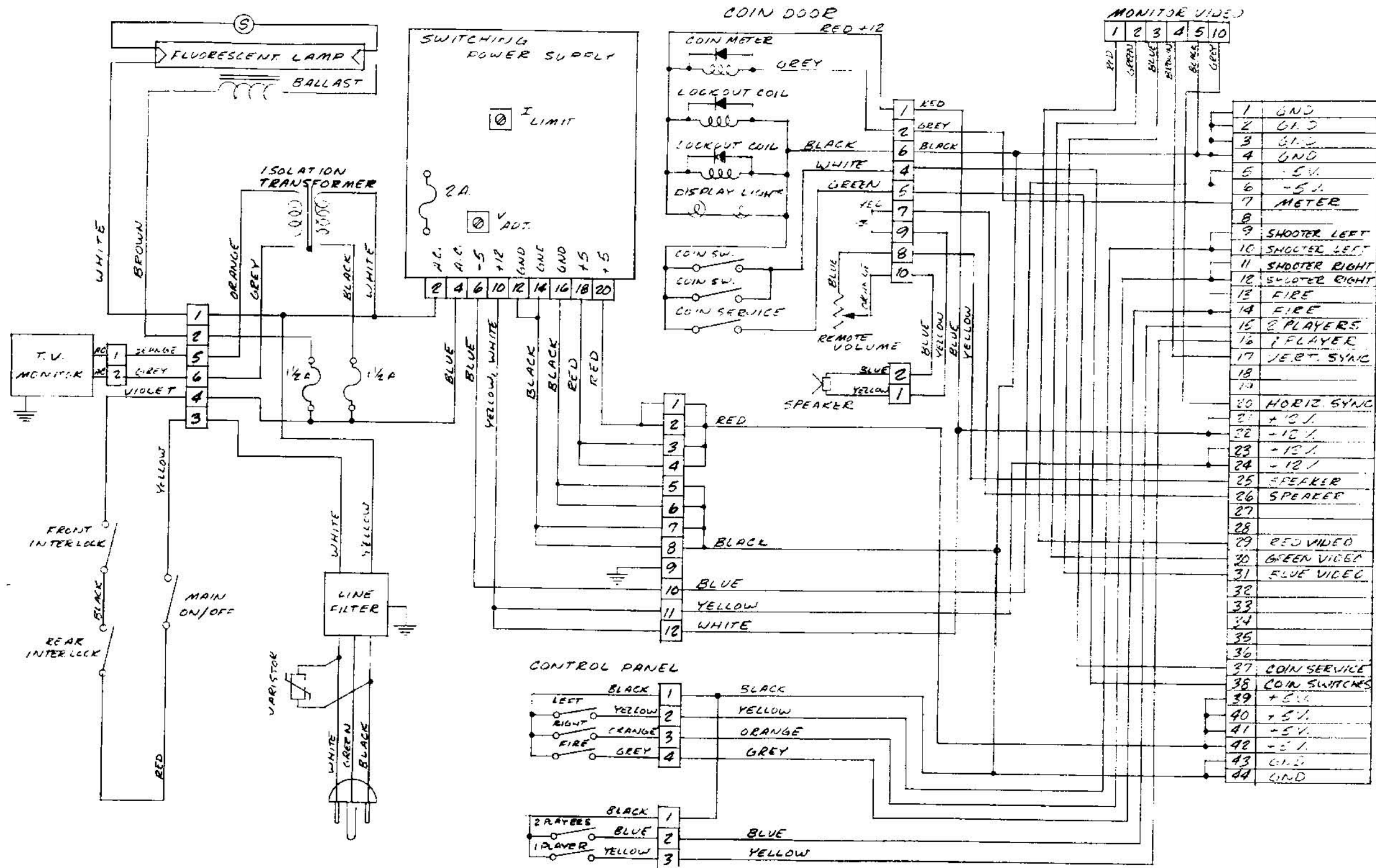

GDI GDI Inc.
 5945 N. ROGERS AVE. CHICAGO, IL 60646 / (312) 286-6722

NAME 9 Wiring Harness, Schematic Diagram

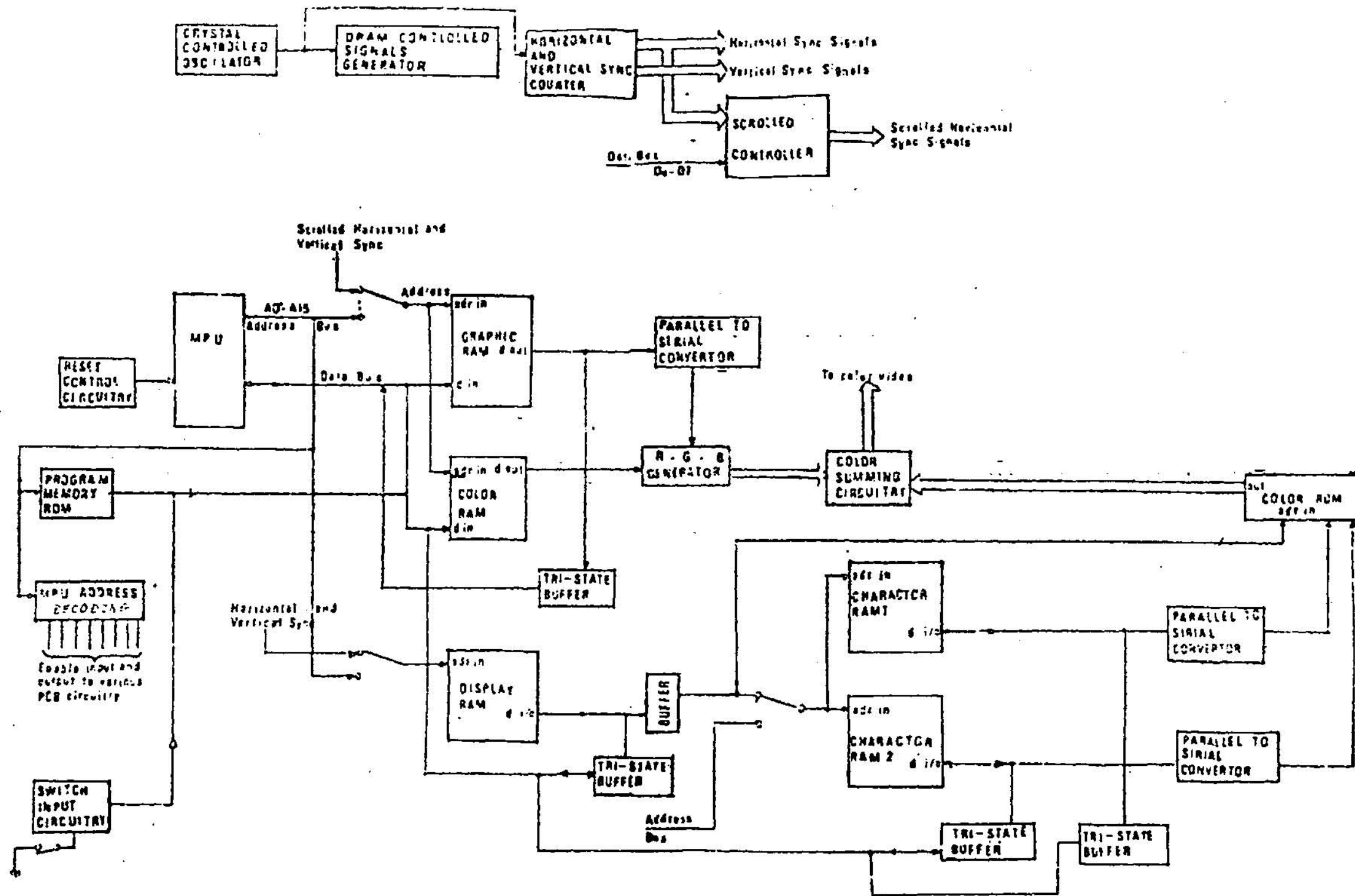

GDI	GDI Inc.
	5945 N. ROGERS AVE. CHICAGO, IL. 60646 / (312) 286-6722
NAME 10 <i>MAIN Logic, Block Diagram</i>	

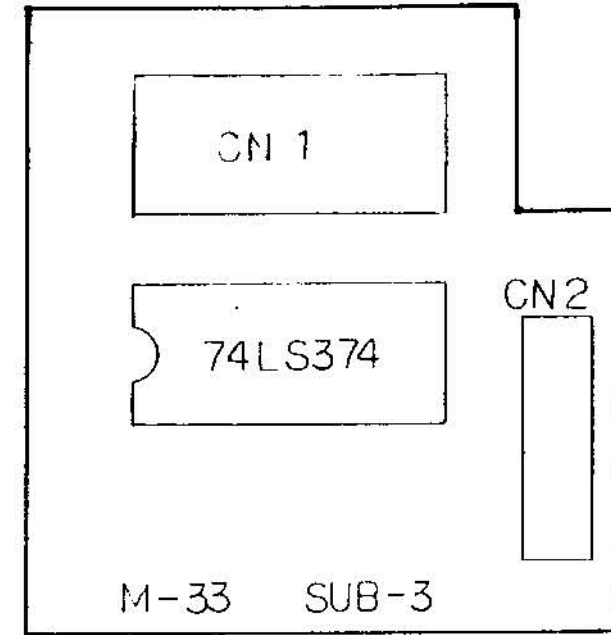
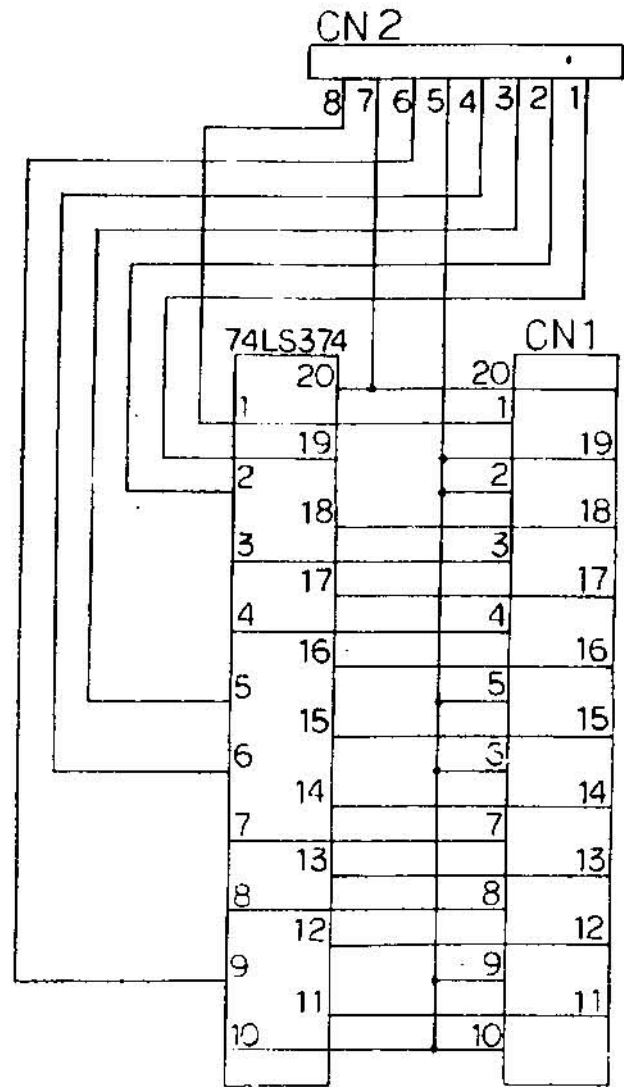

GDI	GDI Inc.	
	5945 N. ROGERS AVE. CHICAGO, IL. 60646 / (312) 286-6722	
NAME 14	LOGIC PCB	M-33-SUB-3

GDI	GDI Inc.	
	5945 N. ROGERS AVE. CHICAGO, IL. 60646 / (312) 286-6722	
NAME 13	LOGIC PCB	M-33-SUB-3

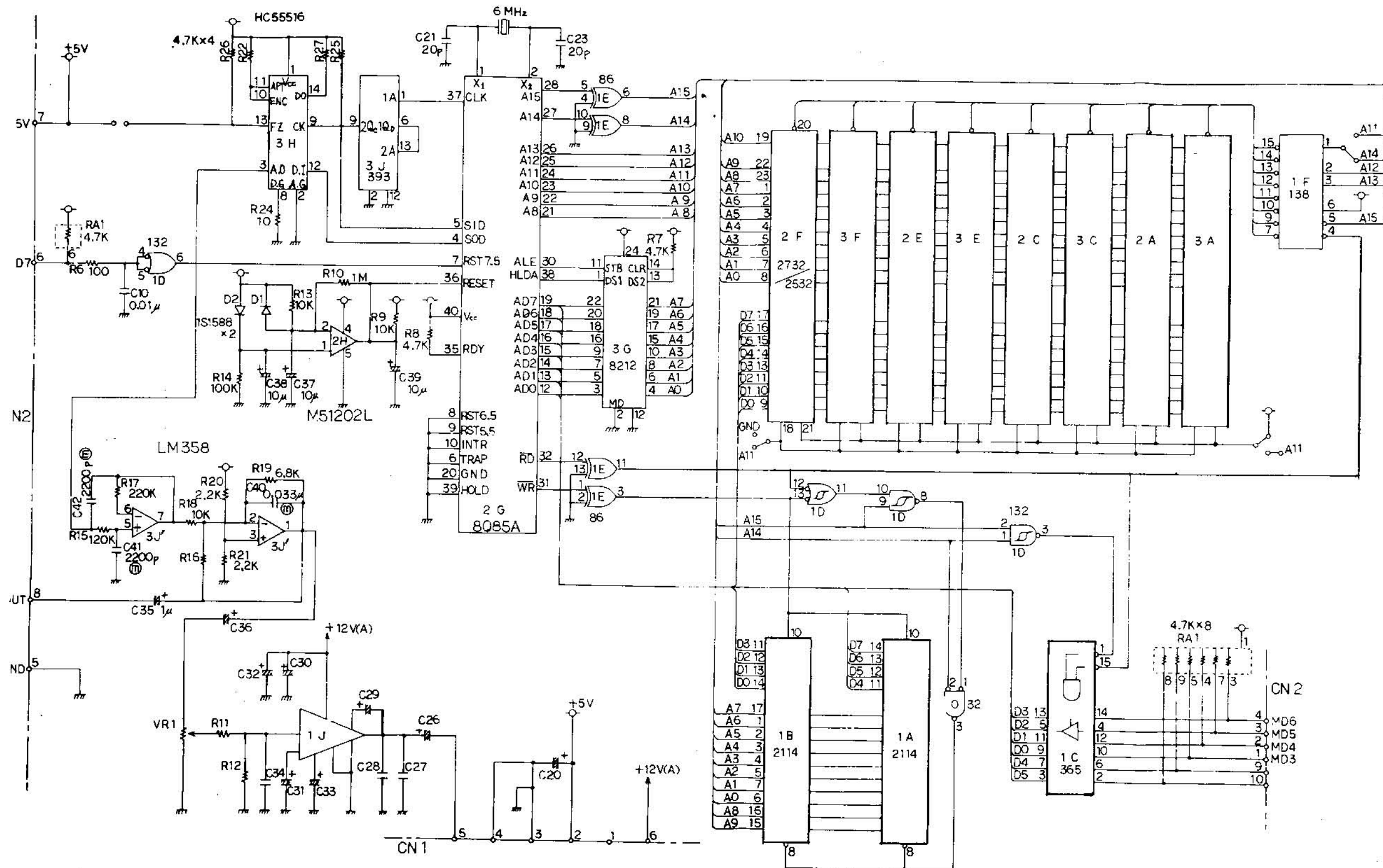

GDI Inc.
 5945 N. ROGERS AVE. CHICAGO, IL. 60646/ (312) 286-8722
 NAME: VOICE PCB ASS'Y UE-17B

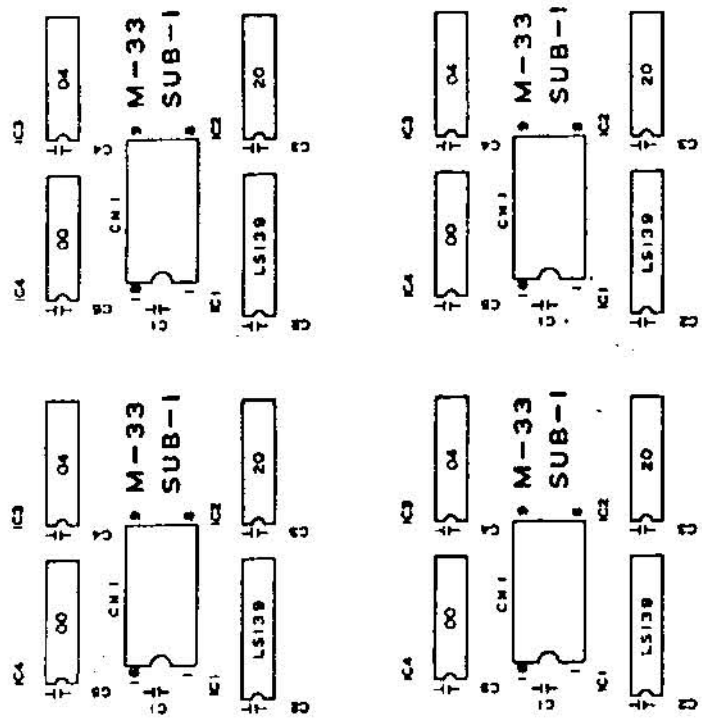

18 Logic (M33-Sub 1), GDI P/N A-20569, Assembly Diagram

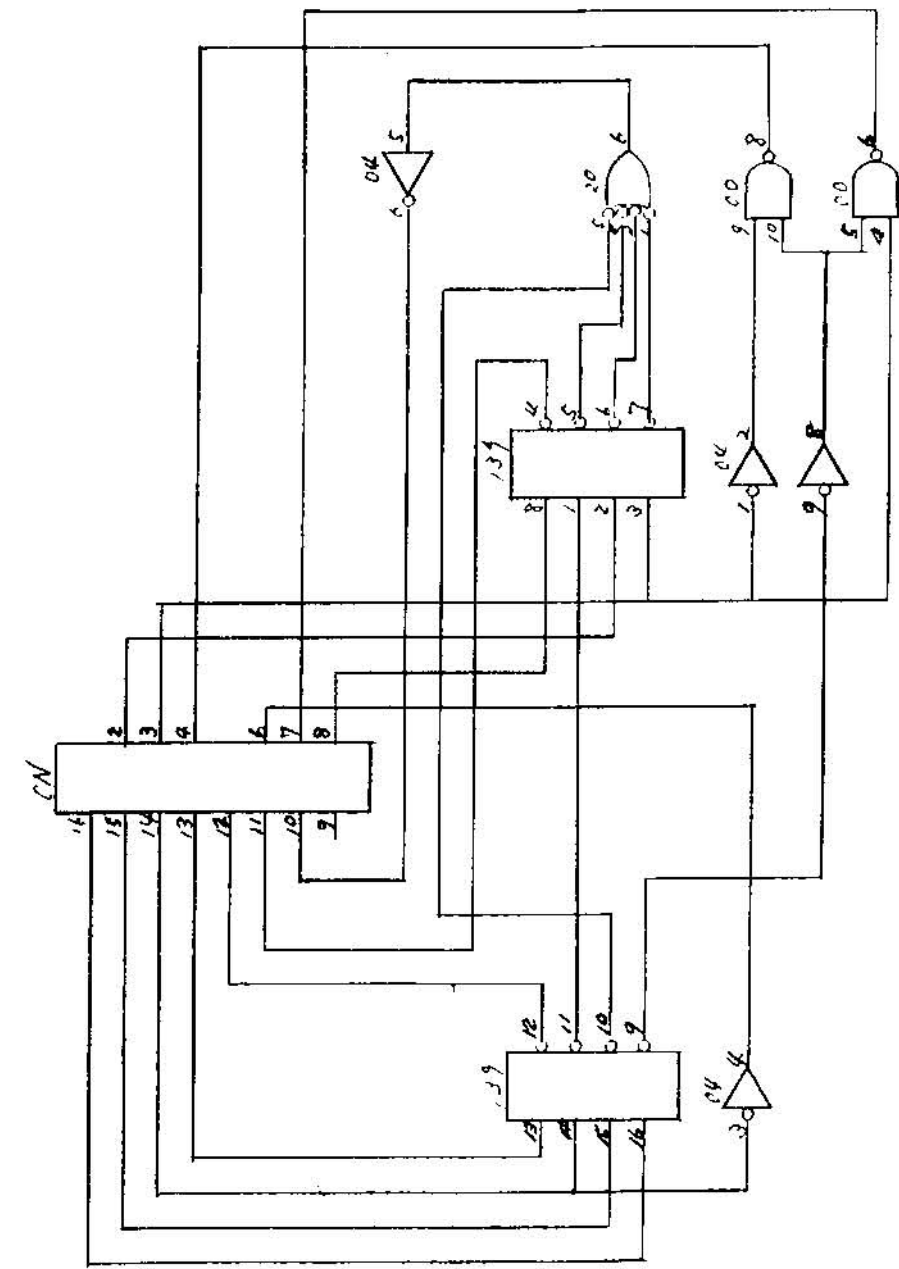

17 Logic (M33-Sub 1), GDI P/N 17A-20564, Schematic Diagram

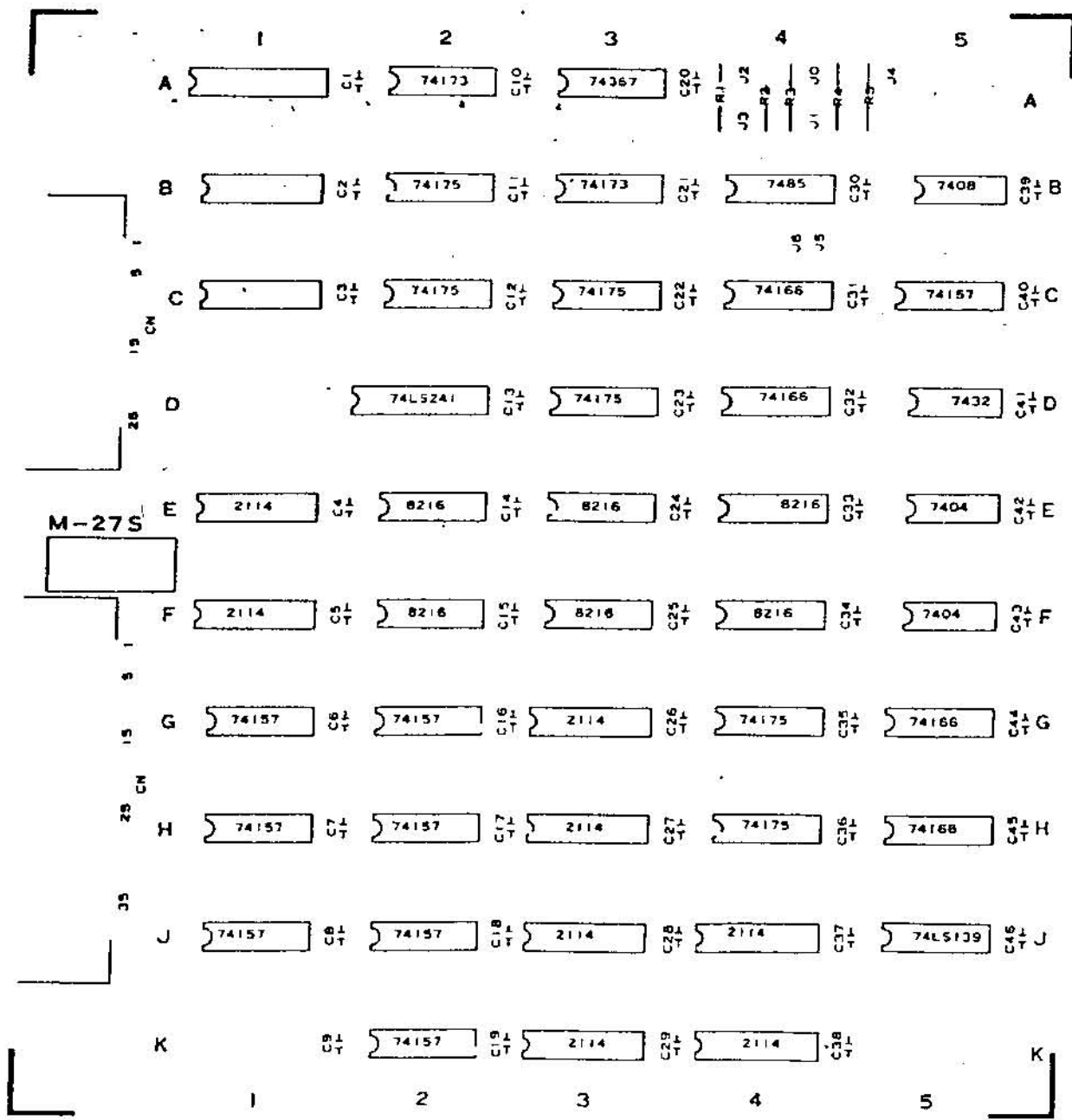

	GDI Inc. 5945 N. ROGERS AVE CHICAGO, IL 60646/ (312) 286-6722
NAME 22 Character (M-27S), GDI P/N A-20571, Assembly Diagram	

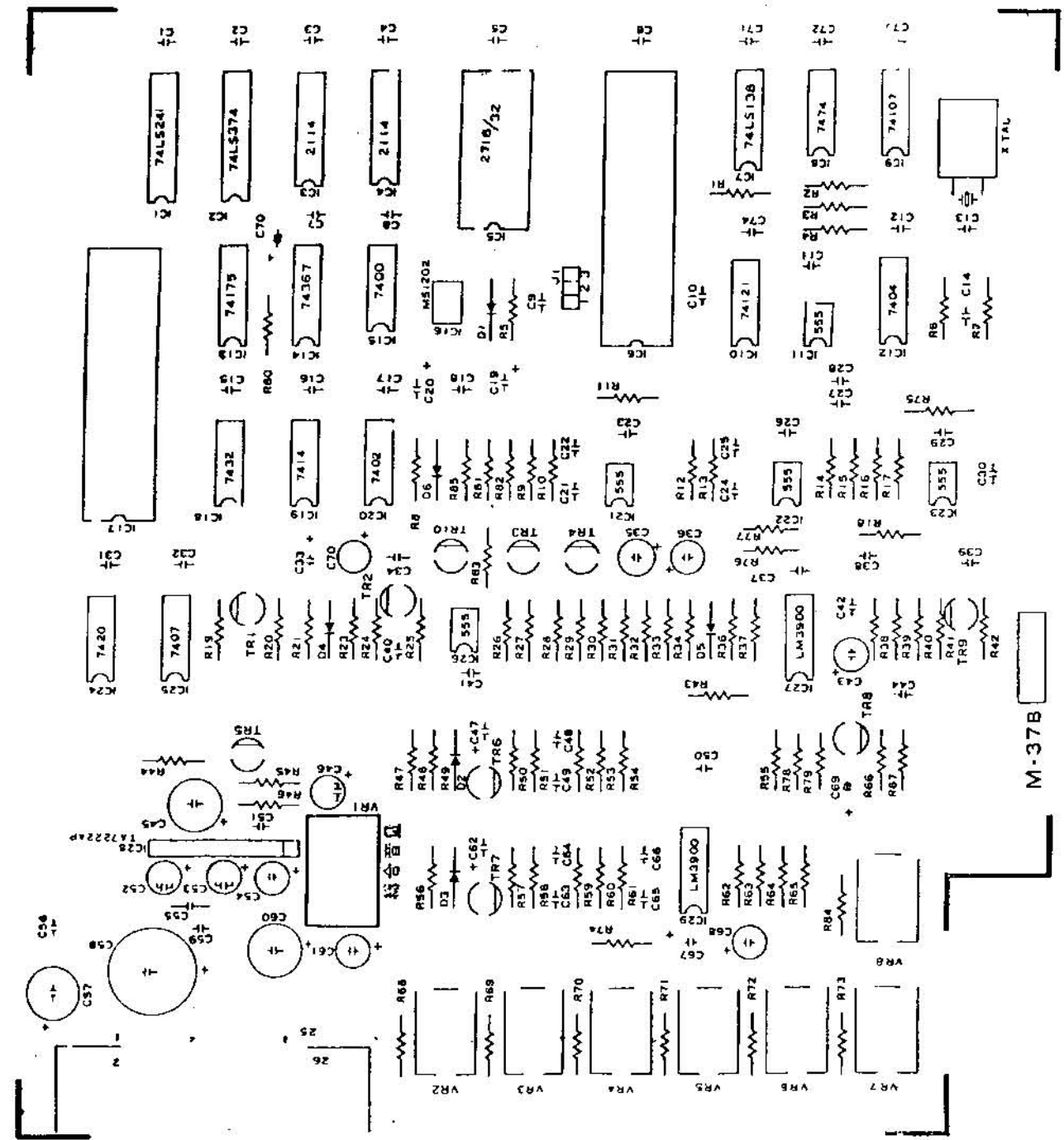

	GDI Inc. 5945 N. ROGERS AVE CHICAGO, IL 60646/ (312) 286-6722
NAME 19 Audio (M-37B), GDI P/N A-20573, Assembly Diagram	

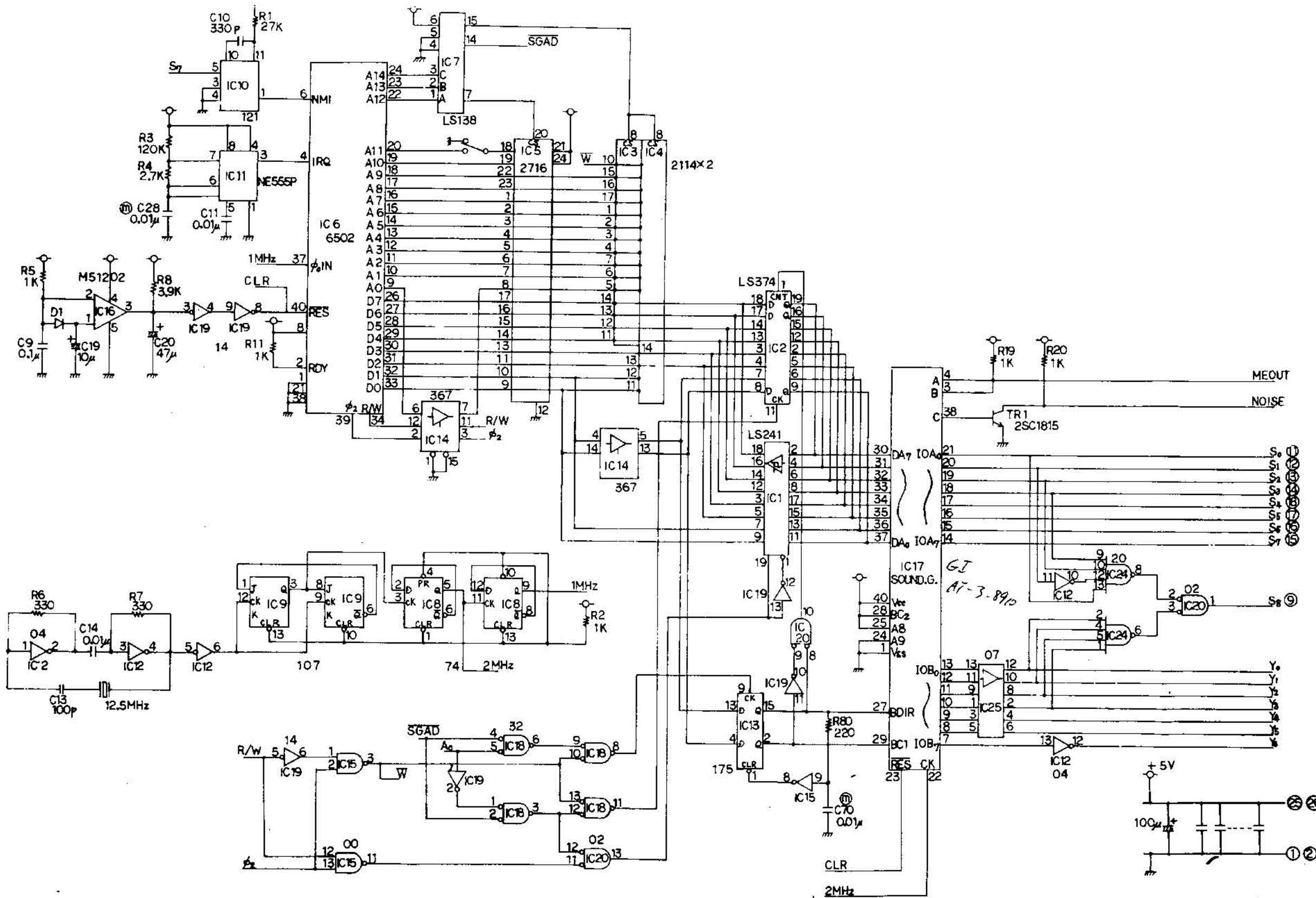

GDI GDI Inc.
 1 5945 N. ROGERS AVE. CHICAGO, IL. 60646 / (312) 288-6722

NAME
 Audio (M-37B), GDI P/N 17B-20572, Schematic Diagram

(sheet 1 of 2)

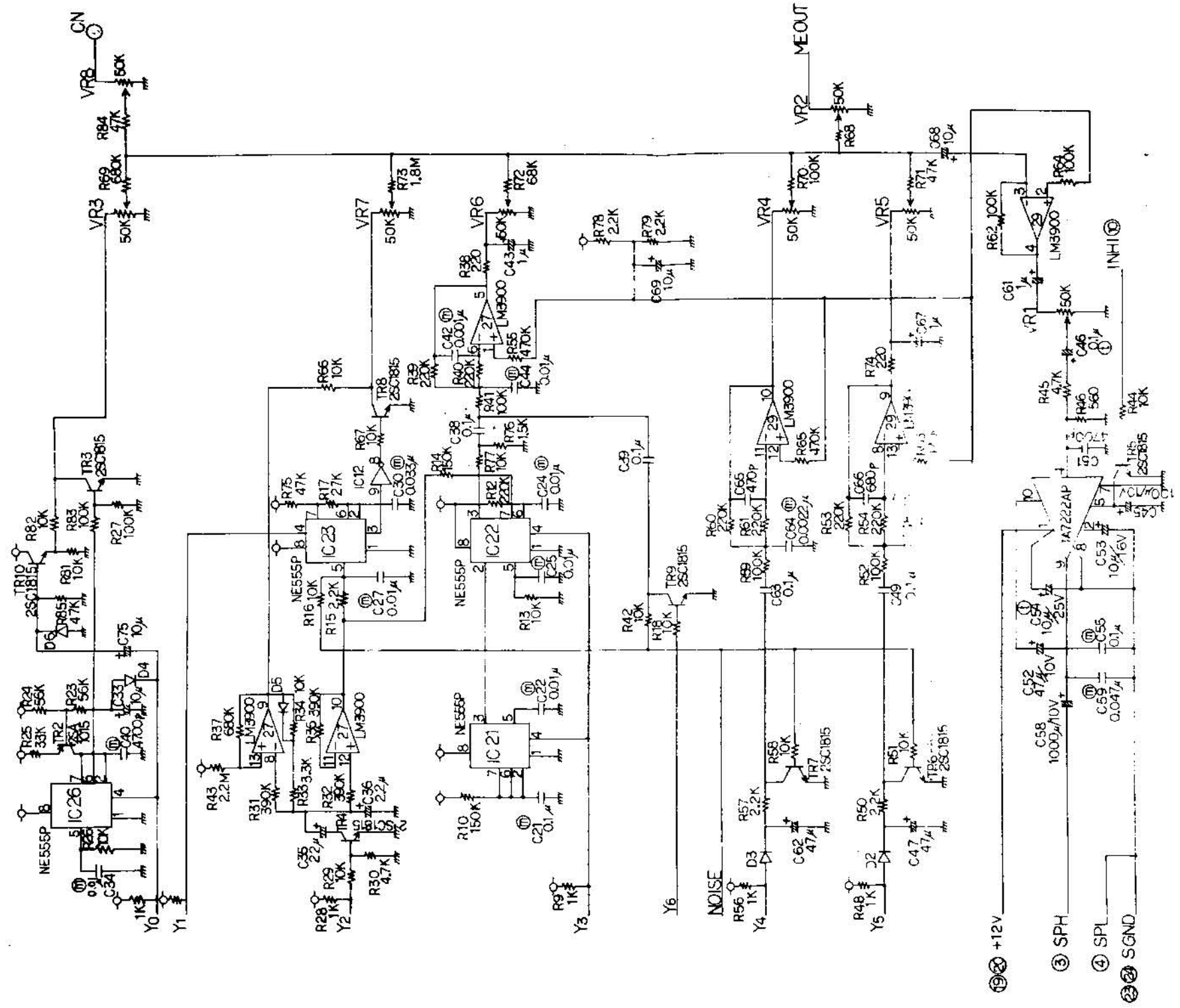

※ POLYESTER FILM CAPACITOR
 ① TANTALUM ELECTROLYTIC CAPACITOR

- ⑫ +12V
- ③ SPH
- ④ SPL
- ⑬ SGND

	GDI Inc. 5945 N. ROGERS AVE. CHICAGO, IL. 60646 / 312 266-6722
	NAME 21 Audio (M-37B), GDI P/N 17B-20572, Schematic Diagram

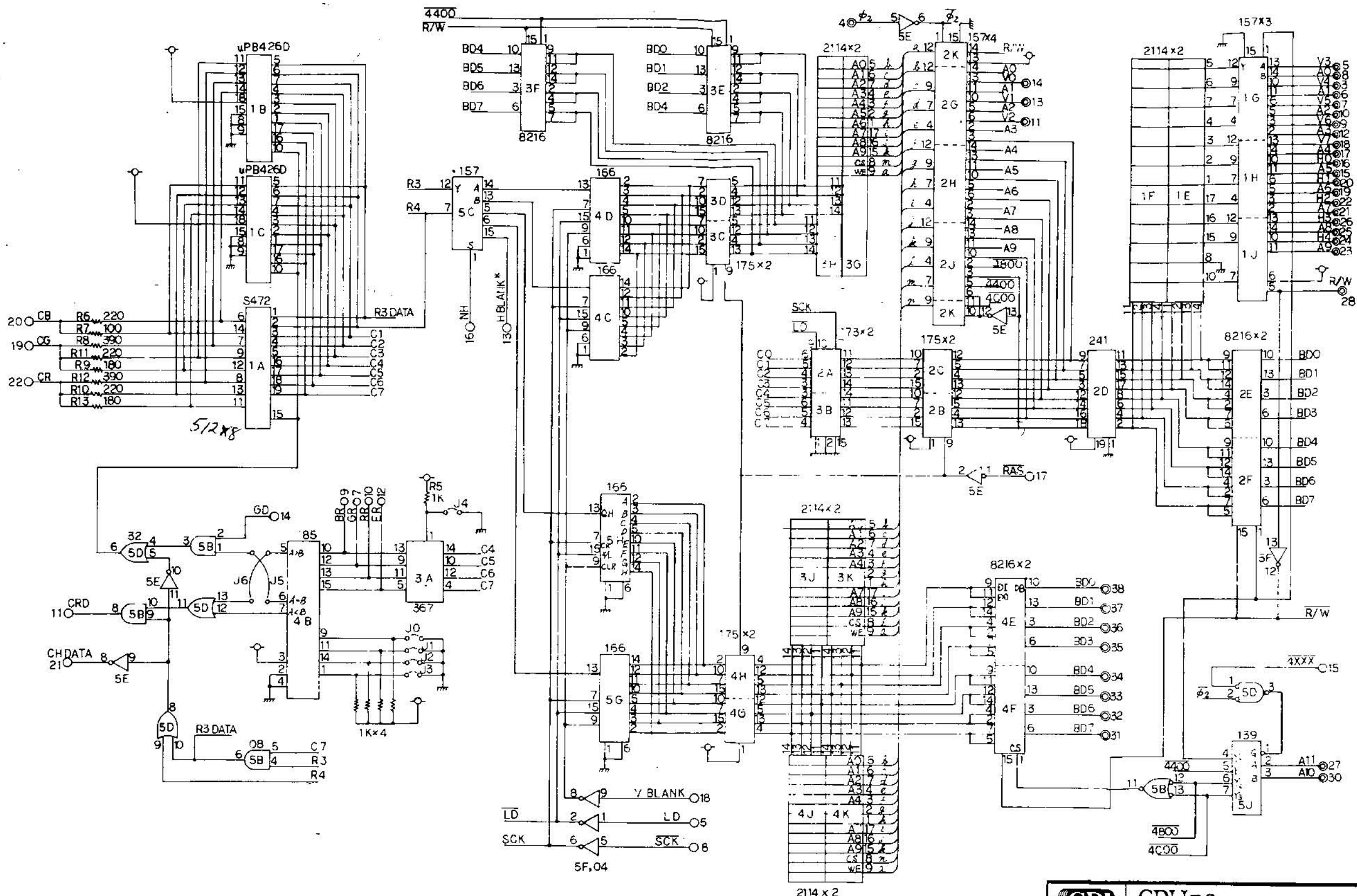

GDI GDI Inc.
 5945 N. ROGERS AVE. CHICAGO, IL. 60646 / (312) 288-8722
 NAME 23 Character (M-27S), GDI P/N 17B-20568,
 Schematic Diagram

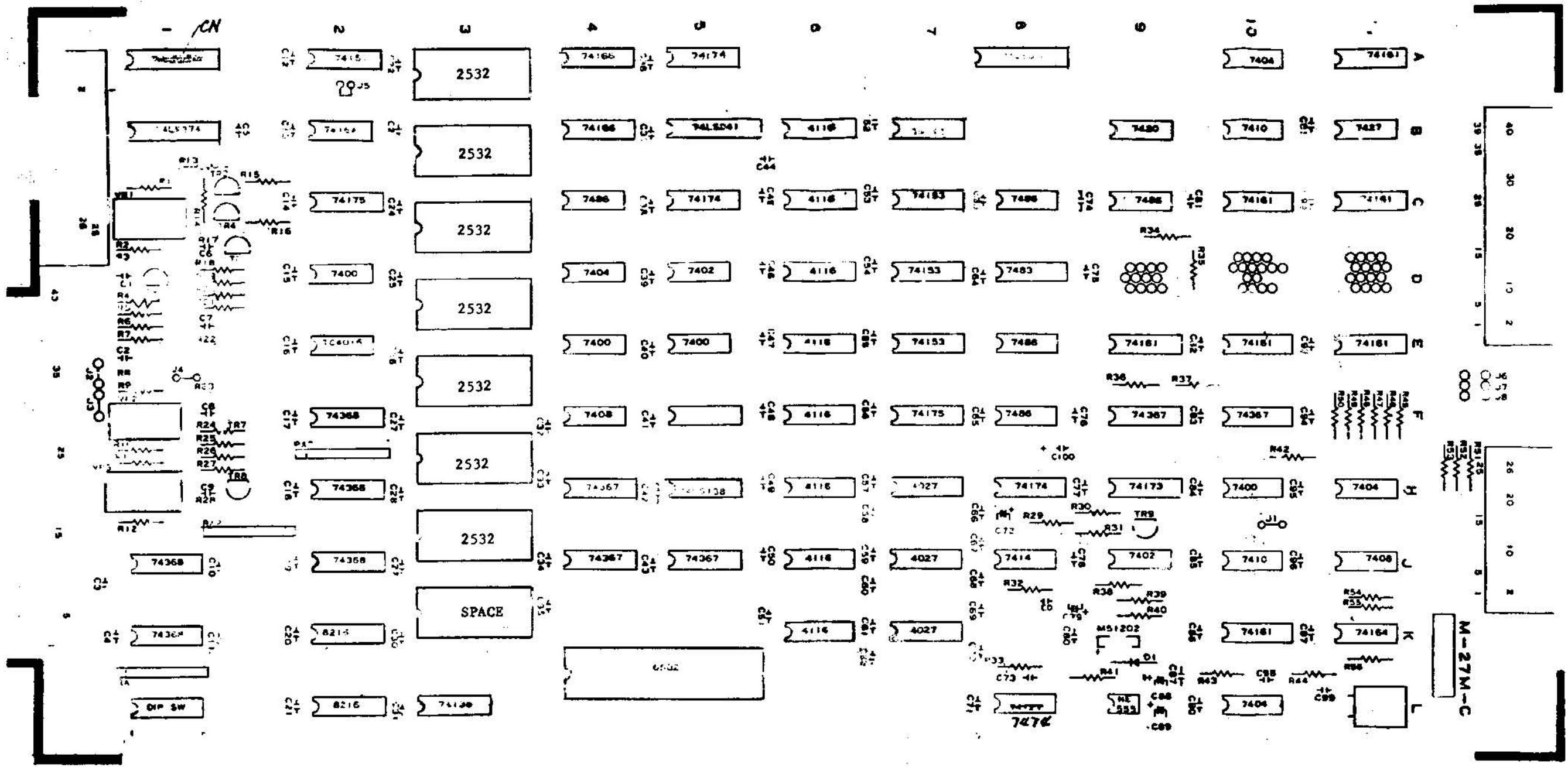

GDI Inc.
 8845 N. ROGERS AVE. CHICAGO, IL 60646 / (812) 286-6782
NAME
 24 Main Logic (M-27M), GDI P/N B-20563, Assembly Diagram

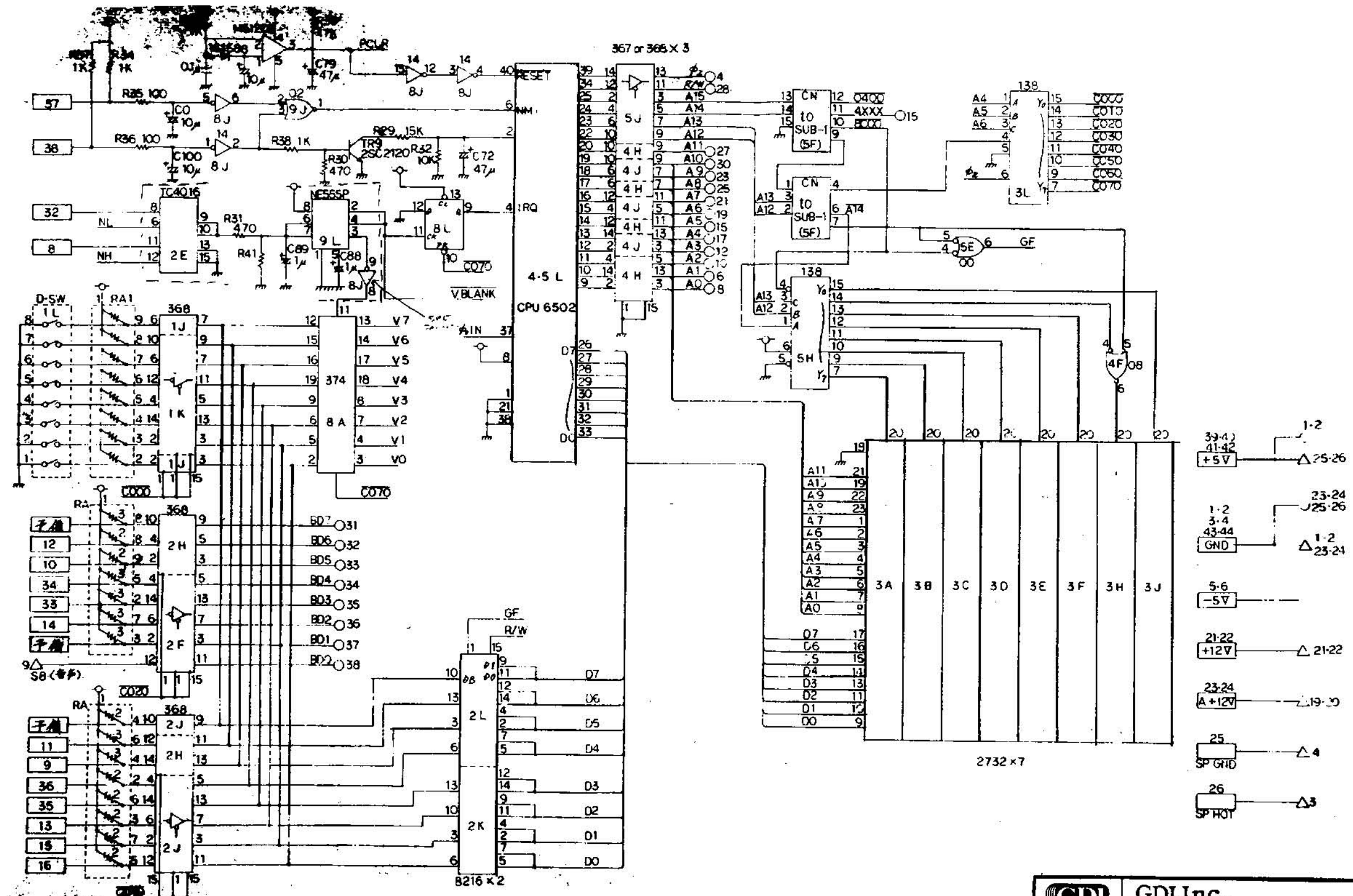

GDI	GDI Inc. 5945 N. ROGERS AVE. CHICAGO, ILL. 60646 / (312) 286-6722
NAME	25 Main Logic (M-27M), GDI P/N 17B-20562, Schematic Diagram (Sheet 1 of 2)

