

Operating Instructions

LASER DISC PLAYER LD-1100

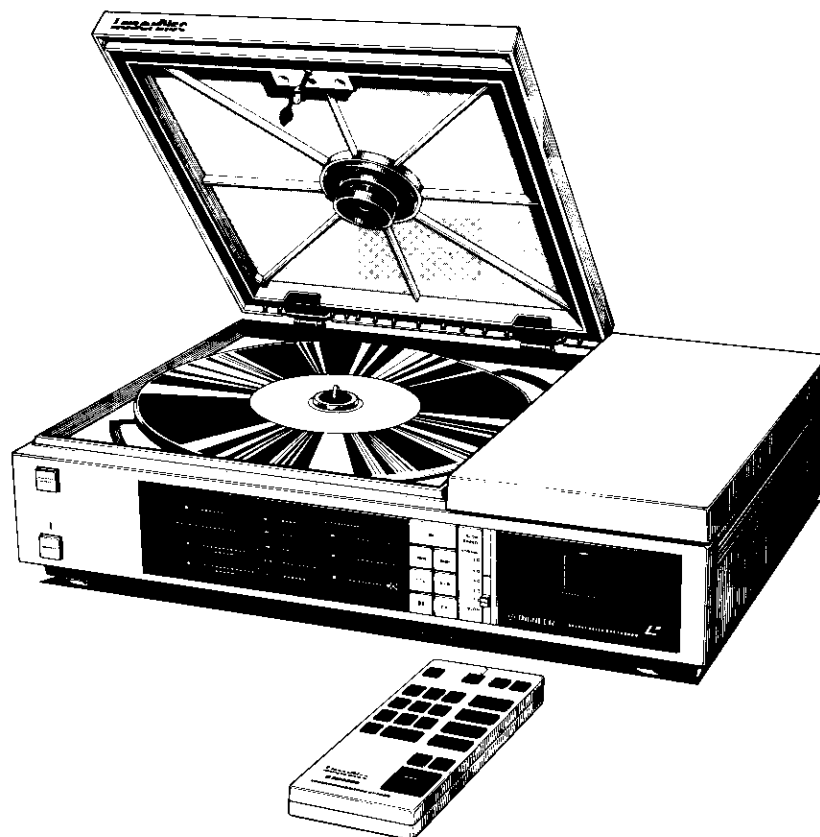

IMPORTANT NOTICE

The serial number for this equipment is located on the rear panel. Please write this serial number on your enclosed warranty card and keep in a secure area. This is for your security.

Caution: Use of controls or adjustments, or performance of procedures other than those specified herein may result in hazardous radiation exposure.

WARNING: TO PREVENT FIRE OR SHOCK HAZARD, DO NOT EXPOSE THIS APPLIANCE TO RAIN OR MOISTURE.

CONTENTS

FEATURES	2
BEFORE OPERATION	3
REAR PANEL FACILITIES	4
CONNECTIONS	5
PANEL FACILITIES	8
OPERATION	10
MAINTENANCE	17
TROUBLESHOOTING	18
SPECIFICATIONS	19

FEATURES

Non-contact pickup system

This system uses a low-powered laser to detect the information recorded on the laser disc. There is no physical contact between the pickup and the laser disc itself, so it is called the "non-contact pickup system". This laser, while in operation, projects a continuous beam of light onto the disc on an area measuring no more than one micron in diameter. Information on the laser disc is stored in the form of microscopic pits which are laid down in a spiral track on a light reflected surface. When the laser beam strikes a series of pits, it is reflected into the system and the variation of the reflected light is converted into the reproduced signal.

Unlike an ordinary phonograph record or other video disc systems, there is no abrasion and no wear on the disc or pickup. Even if there are fingerprints or dust on the laser disc surface, this will not usually interfere with reproduction of picture or audio because the laser beam is focused on a plane about 1.2 mm beneath the transparent acrylic surface. In other words, the recorded information surface is not exposed, so laser disc handling is easy and requires no special care. The illustrations to the right show how the laser beam and disc interact in the Pioneer Laser disc player.

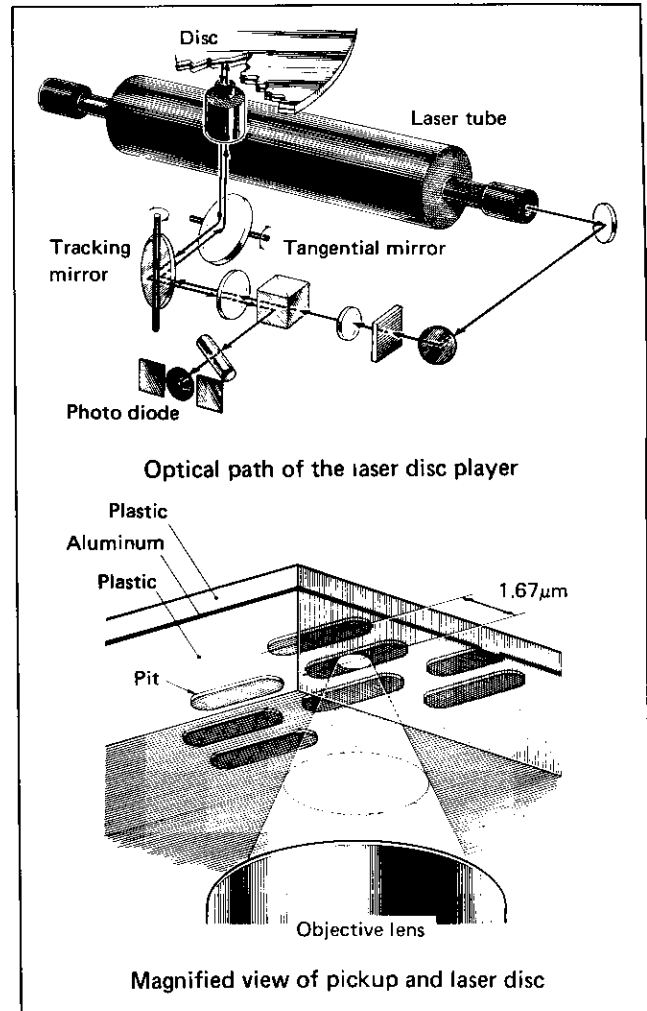

Both standard play (CAV) and extended play (CLV) laser discs can be played. The LD-1100 automatically detects these laser discs and plays accordingly.

The standard play disc, also known as the CAV or constant angular velocity disc, spins at the same constant speed of 1,800 rpm from the inner circumference to the outer circumference, and provides a maximum of 30 minutes playing time per side.

On the CAV disc, one video picture frame is recorded for each revolution, so a number of additional performance features are possible.

Although the extended play disc, also known as the CLV or constant linear velocity disc, does not offer such additional features, it does have a maximum playing time of one hour per side since the rotational speed continuously varies from 1,800 rpm at the inner circumference to 600 rpm at the outer circumference.

Built-in computer control provides multiple performance features and easy operation.

From the inner to the outer circumference, the Pioneer laser disc has a maximum of 54,000 "tracks" in a continuous spiral pattern. On the CAV (standard play) disc, the signal for one video picture frame is recorded on one track covering one full revolution. Beginning at the inside circumference, each frame is recorded along with its frame number. Thanks to microcomputer control, a single frame can be played repeatedly to provide a still picture, each frame can be played several times for slow motion, and tracks can be skipped for fast-forward or reverse reproduction. There is also a "super action" feature, called the frame number random access, that will find a specific frame automatically by frame number within 15 seconds, and you can play slow motion or fast action, from that point. Such complex operations are remarkably easy, as will be apparent when you operate the LD-1100 laser disc player.

High quality stereo sound

Besides the video signal, audio is recorded in the form of two separate FM signals. Therefore, stereo or bilingual reproduction is also possible.

Audio frequency response is 40Hz - 20kHz, signal-to-noise ratio is 60dB (CX ON; 70dB) or more, and total harmonic distortion is 0.3% or less, making this high quality stereo source comparable to conventional phonograph records or FM broadcasts. Although connection to an ordinary television set is all that is required for normal video and audio reproduction, we recommend that a hi-fi stereo system, one from Pioneer, for example, is used to take full advantage of the high quality sound of the laser disc.

CX noise reduction system

The CX noise reduction system serves to cut down noise by about 10dB or more without compromising the frequency response. It serves to expand the dynamic range and enable reproducing the sounds with a good signal-to-noise ratio.

Infrared wireless remote control is possible.

With the CU-1100 remote control unit, virtually all operations can be controlled from a distance via infrared light.

BEFORE OPERATION

INSTALLATION

Place the player in a stable location near your TV set. In order to ensure a long-term top performance.

OPENING THE LID

Power switch on the player must be turned on to open the lid. Never try to force the lid open.

- 1) Plug AC power cord into a standard wall socket, then press the POWER switch.
- 2) Press the REJECT/OPEN button to release the lid latch.
- 3) Then lift up at the front of the lid to open.

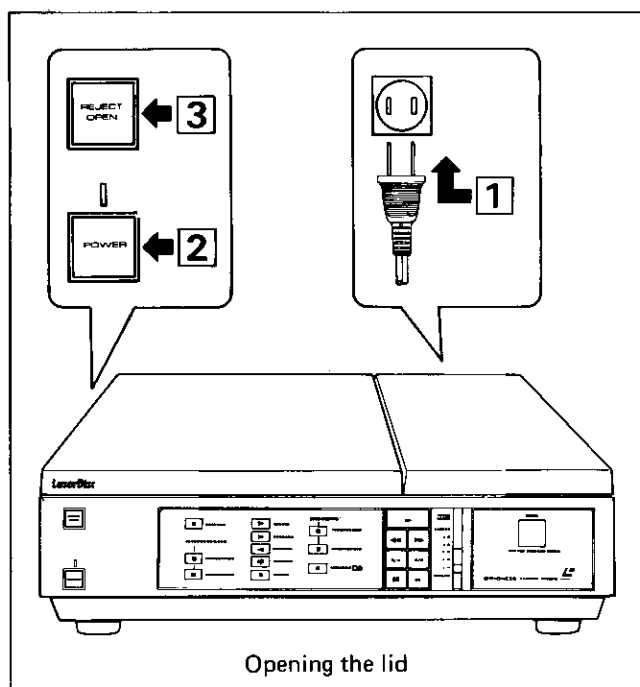

REMOVING THE SHIPPING SCREW

To prevent possible damage to the internal mechanism during shipment, the player is provided with a shipping screw located to the right of the objective lens. The shipping screw must be removed before operating the player. Do not lose the screw. It must be screwed back into place if you ever need to ship or transport the player in the future.

NOTE:

The shipping screw should be screwed back in with the player power on, as this is when the screw hole is aligned properly.

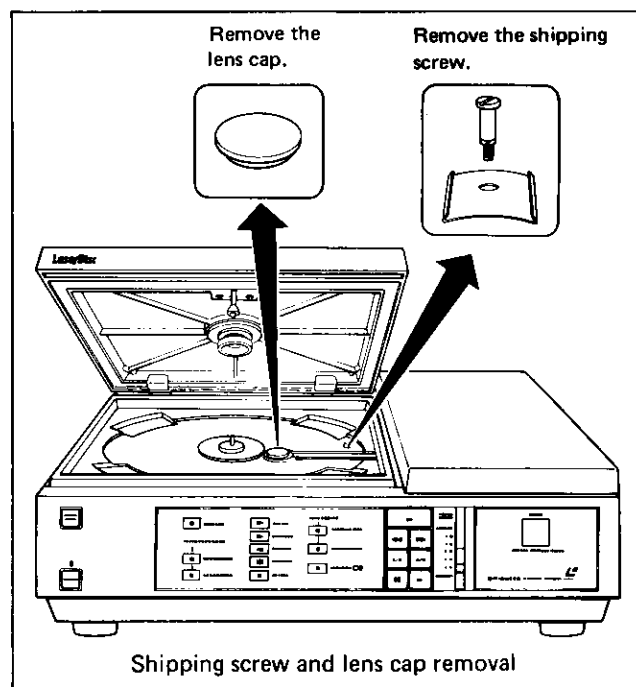

BEFORE OPERATION

REMOVING THE LENS CAP

The objective lens is covered with a protective cap to prevent damage and to keep out dust during shipment.

This lens cap must be removed before operating the player. Save the lens cap and use it to protect the objective lens when the player is not in use for a long period of time or when shipping the player.

PREPARATION FOR THE REMOTE CONTROL UNIT (CU-1100)

The remote control unit CU-1100 has been stored in a cardboard accessory case.

Take the remote control unit out of the case.

- 1) Open the battery cover on the bottom of the remote control unit by pushing with your thumb to the right.
- 2) Insert three size "AA" dry batteries in the compartment with their polarities correctly positioned as indicated, then close the cover. Placing the piece of ribbon under the batteries makes their removal simple. The batteries will pop out when the ribbon is pulled.
- 3) Push one of the buttons on the remote control unit and confirm that the red indicator lights up. This indicates the batteries are installed correctly.

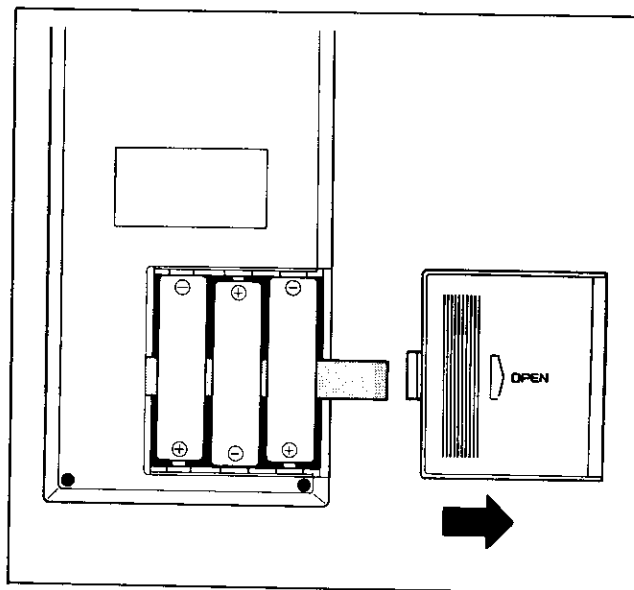

NOTE:

- When the unit is not used for a long period of time (more than one month), take the batteries out to prevent them from leaking inside the player. If leakage takes place, wipe up the liquid inside the compartment and replace the batteries with new ones.

REAR PANEL FACILITIES

① AUDIO OUT

These jacks provide the left and right channel audio signals for connection to a stereo hi-fi system.

② VIDEO OUT

The terminal is only for connection to a color video monitor TV (that has a video input terminal). It provides the direct video signal. This terminal is not for conventional TV sets.

③ ANTENNA IN 75 OHM UNBAL.

If your VHF antenna cable is a 75-ohm coaxial cable type, connect it to this terminal. If your VHF antenna cable is a 300-ohm twin-lead feeder type, connect it to this terminal through the antenna adapter (furnished with the player).

④ CH.3/4 VHF OUT

This terminal provides audio and video signals which are converted to VHF channel 3 or chan-

nel 4 by the built-in VHF converter. Set the CHANNEL SELECTOR to the open channel that you will use to receive the laser disc signal on your TV set. We suggest also that you connect your VHF antenna lead directly to the ANTENNA IN terminal on the player. This will allow automatic switching between laser disc playback and regular TV reception. When you turn on the player, the laser disc signal will be sent to your TV set, and when you turn off the player, the TV (VHF) broadcasts will be received.

⑤ VHF CHANNEL SELECTOR

This slide switch is for selecting a VHF output channel. It has been set to channel 3 at the factory but can be changed to channel 4. Set to the channel which is not used for commercial TV broadcasts in your area.

⑥ POWER CORD

Plug this into a wall socket.

CONNECTIONS

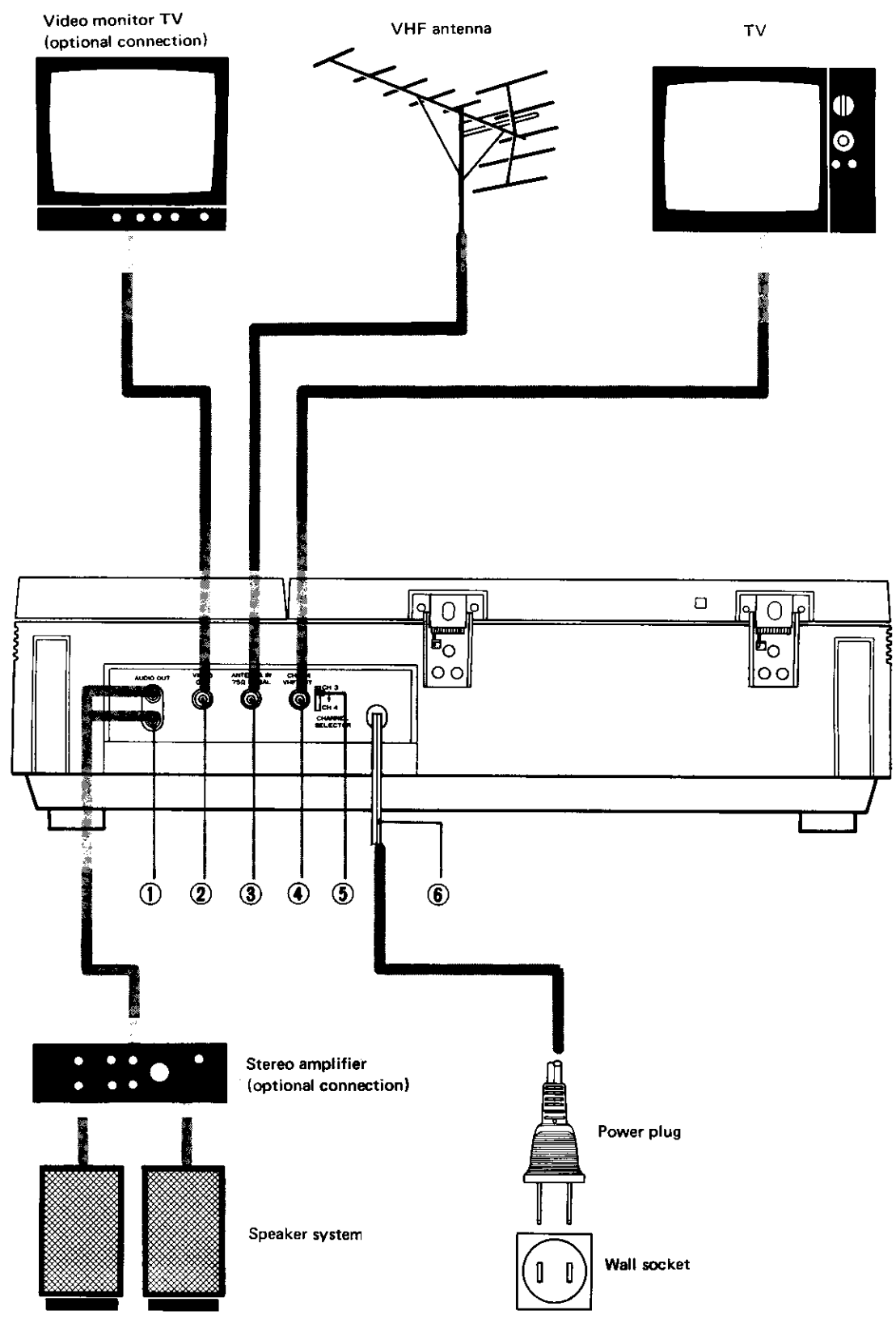

Overall connections diagram

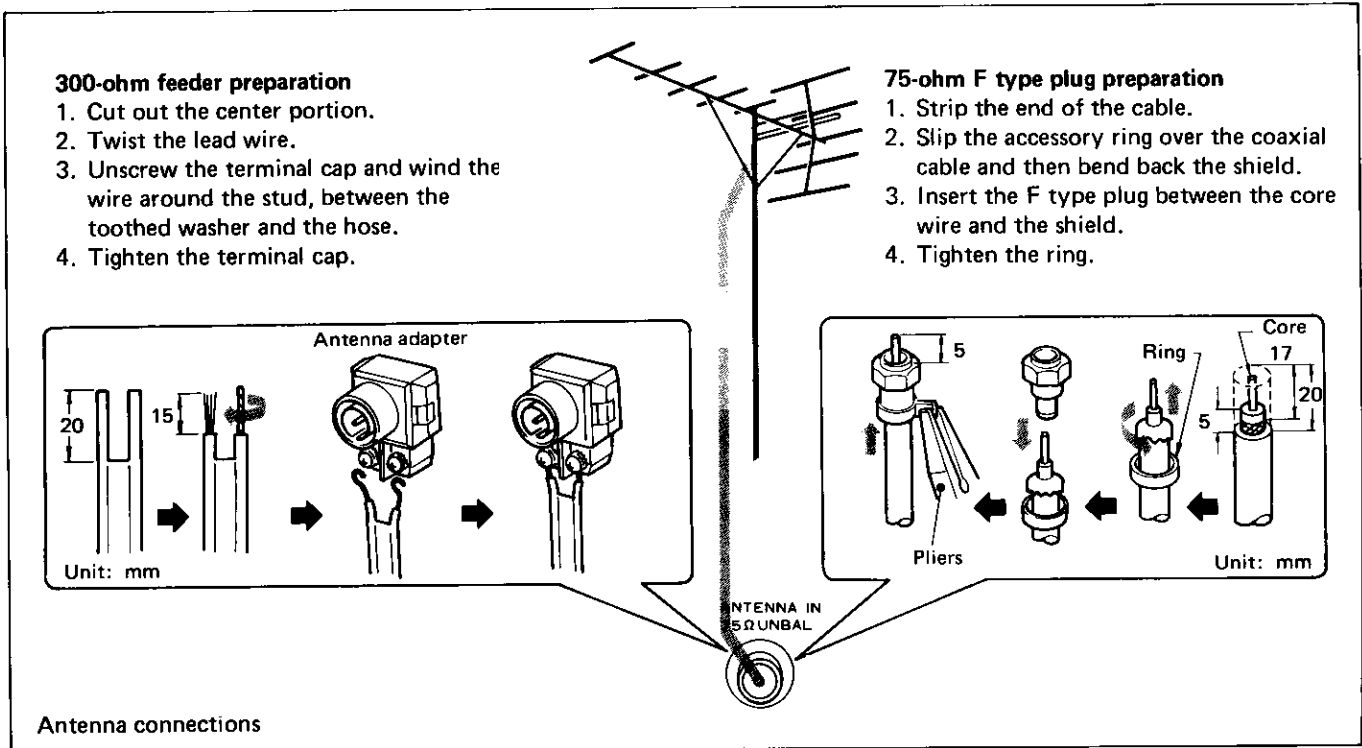

1. Remove the VHF antenna cable from the VHF antenna terminal(s) on your TV set, and connect the cable to the ANTENNA IN terminal on the player. For coaxial antenna cables (75-ohm), an F type plug must be fitted to the end of the cable. For twin-lead feeder antenna cable (300-ohm), first prepare the wire leads, and connect to the 300-ohm terminals of the furnished antenna adapter. Then connect the antenna adapter (F type plug) to the ANTENNA IN terminal on the player.

2. An accessory cable with F type plugs at both ends is supplied with the player. Connect one end of this cable to the VHF OUT terminal on the player, and connect the other end to the VHF ANT IN (75-ohm, unbal., F type jack) terminal on your TV set. If your TV has no F type VHF ANT IN terminal, prepare the end of the cable. If your TV has no 75-ohm antenna terminal, purchase a 75-ohm (F type jack)-to-300-ohm adapter and connect the cable to the adapter (75-ohm terminal). Then connect the adapter's twin-lead feeder to the TV's VHF IN (300-ohm balanced) antenna terminals.

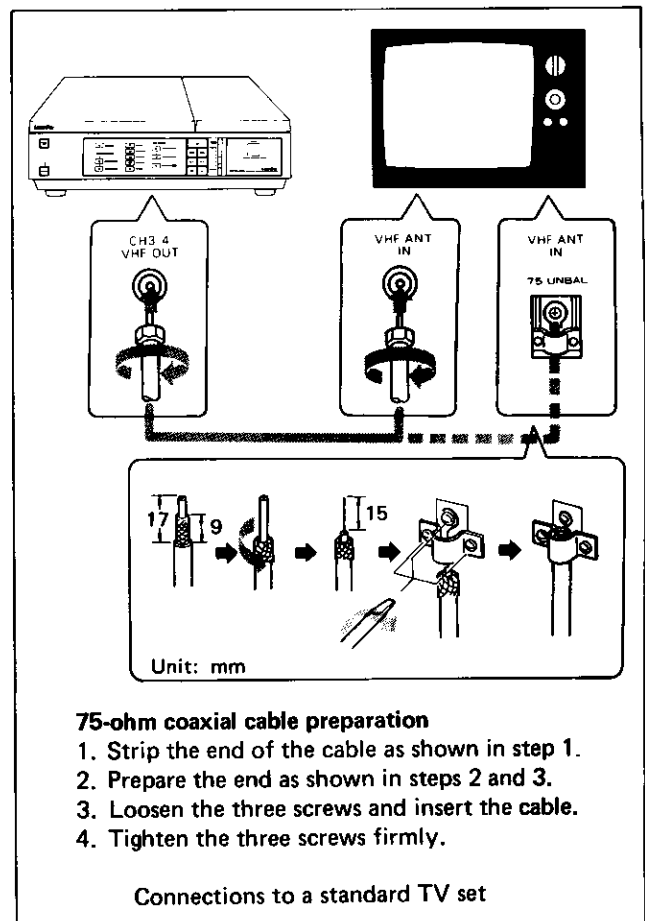

3. Next, set the VHF CHANNEL SELECTOR on the player to channel 3 or 4, whichever is not used for commercial TV broadcasts in your area. Then set your TV to the same channel.
4. Plug the AC power cord of the player into a standard wall socket (120V, 60Hz). This completes the standard connection procedure for video and audio reproduction through your TV

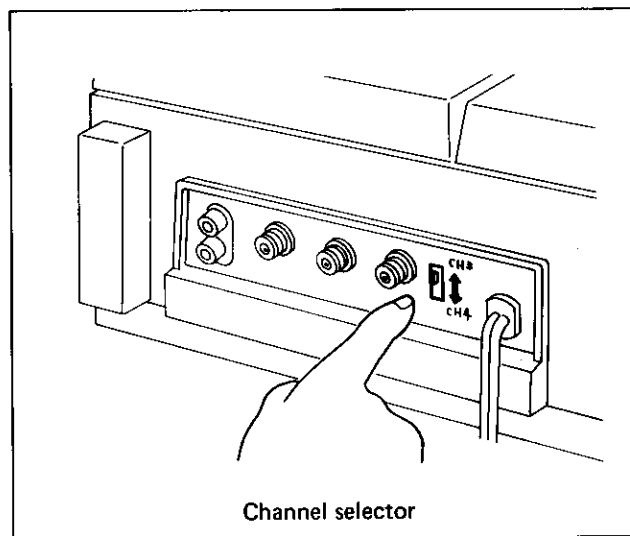

OPTIONAL CONNECTIONS

1. Stereo amplifier

The player can reproduce two channel stereo hi-fi signals from laser discs. To take full advantage of this capability, use the two audio connection cords to connect AUDIO OUT jacks on the player to the left and right channel AUX input (or tuner input) jacks on your stereo amplifier or receiver. Place the TV set (to which you have the cable connected) between the stereo speakers and shut off the TV set's volume control for best results.

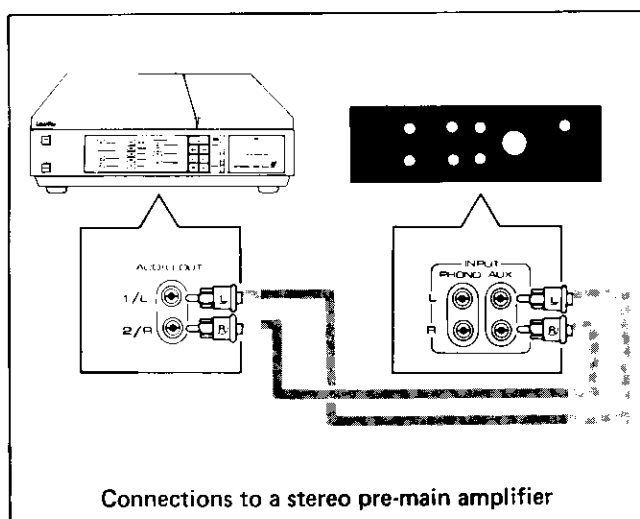

2. Video monitor TV

If you are using a video monitor TV (equipped with a video input terminal), use the accessory coaxial cable to connect the VIDEO OUT terminal on the player to the video input terminal on the monitor TV (terminated video input terminal). In this case, audio outputs on the player must be connected to audio inputs of the monitor TV or to a stereo system for audio reproduction.

NOTE:

The video input terminal on the monitor TV in use may differ from the F type jack. In this case, exchange the plug at one end of the coaxial cord for one that fits properly.

PANEL FACILITIES

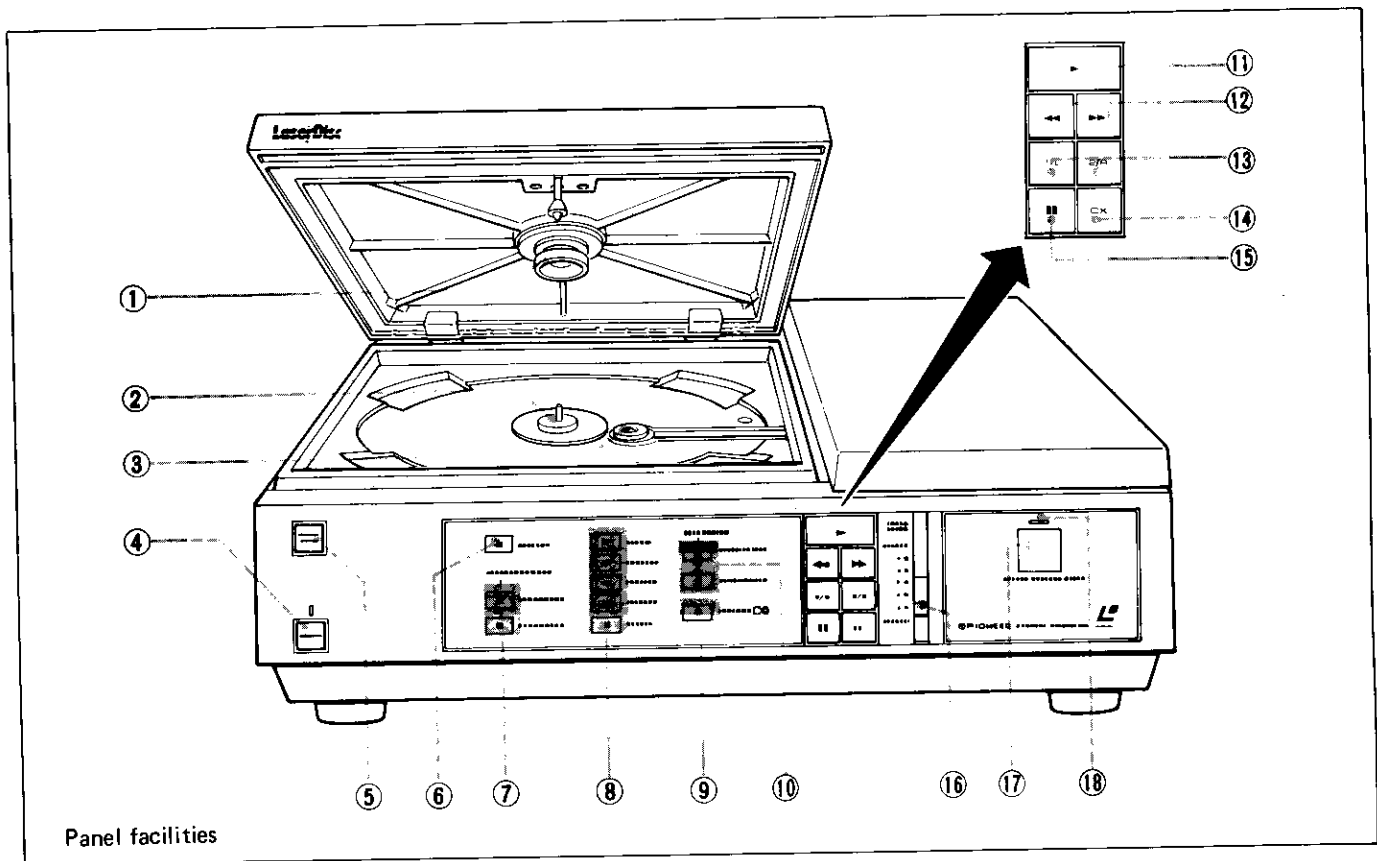

Panel facilities

① DISC CLAMP

When you close the lid, the magnetic clamp holds the disc on the spindle automatically to ensure stable rotation.

② TURNTABLE

Place the laser disc over this turntable. The turntable is coupled directly to the motor which rotates the disc at the proper speed.

③ OBJECTIVE LENS

This is the key part of the player that "reads" the signals recorded on the laser disc. Note that the lens surface must be kept clean in order to maintain optimum performance. Always avoid exposing the lens to dust and dirt. The player is shipped from the factory with a lens cap over the lens.

④ POWER

Press this button to turn the power on and off. The red indicator above the button lights up when the power is on.

⑤ REJECT/OPEN

Press this button to cut off operation and to open the lid.

⑥ STAND BY INDICATOR

This flashes during those periods when some time is required for the player to switch to the next commanded function mode. For example: when the PLAY button is pressed after REJECT, during the SEARCH mode, during the return period.

⑦ AUTO DISC SELECTOR

This automatically indicates the type of laser disc being played.

⑧ PLAYBACK MODE INDICATORS

An indicator which corresponds to the playback mode lights up.

⑨ CX SYSTEM INDICATOR

This lights up when the CX noise reduction system is set to on.

⑩ AUDIO INDICATORS

These are to show the audio channel(s) being reproduced.

⑪ PLAY (▶)

To begin playing a laser disc or resume play after another playback mode reproduction, press this button.

12 SCAN (◀▶)

Use these buttons to quickly locate a specific part of the program that you want to see.

13 AUDIO 1/L, 2/R

These are on/off buttons for the two audio channels.

14 CX

Press this button to set the CX noise reduction system to on when reproducing a disc which has been recorded with the CX system.

15 PAUSE (■■)

Press this button to temporarily halt laser disc operation. Operation stops at the frame when the pause button is pressed, and no video image is reproduced on the TV set. While in the pause mode, a red indicator lights up. The pause mode is released by pressing the pause button again.

16 SLOW SPEED

Use this to adjust the speed to slow motion play. At the NORMAL position, the laser disc will be played at the normal speed of 30-frames/sec. At the SLOW position, the laser disc will be played at the rate of 1 frame per second. Speed is continuously adjustable between these two extremes.

17 INFRARED REMOTE CONTROL RECEIVER

This is the receiver for the infrared remote control signal.

18 REMOTE CONTROL INDICATOR

This lights up when a function command is received by the player.

19 REJECT

Press this button to cut off operation.

20 ◀ X3 FAST 3X ▶

Press the right end of this button for triple-speed forward play; press the left end for triple-speed reverse play.

21 ◀ SLOW ▶

This button is used for slow motion video reproduction. Press the right end of the button for slow forward play; press the left end of the button for slow reverse play.

22 ◀ STILL/STEP ▶

This is used for single frame play and frame-by-frame play. When either end of this button is pressed, a single video frame will be reproduced. Then, every time the right end of the button is pressed, the video image will advance a frame at a time; every time the left end is pressed, the video image will go in the reverse direction a frame at a time.

23 FRAME

This button is used to display or erase frame numbers on the TV screen.

24 CHAPTER

This button is used to display or erase chapter numbers on the TV screen.

25 DIGIT BUTTONS

These buttons are used to select the desired frame and chapter number for the SEARCH mode.

26 SEARCH

This is used to find specific frames or chapters on the laser disc.

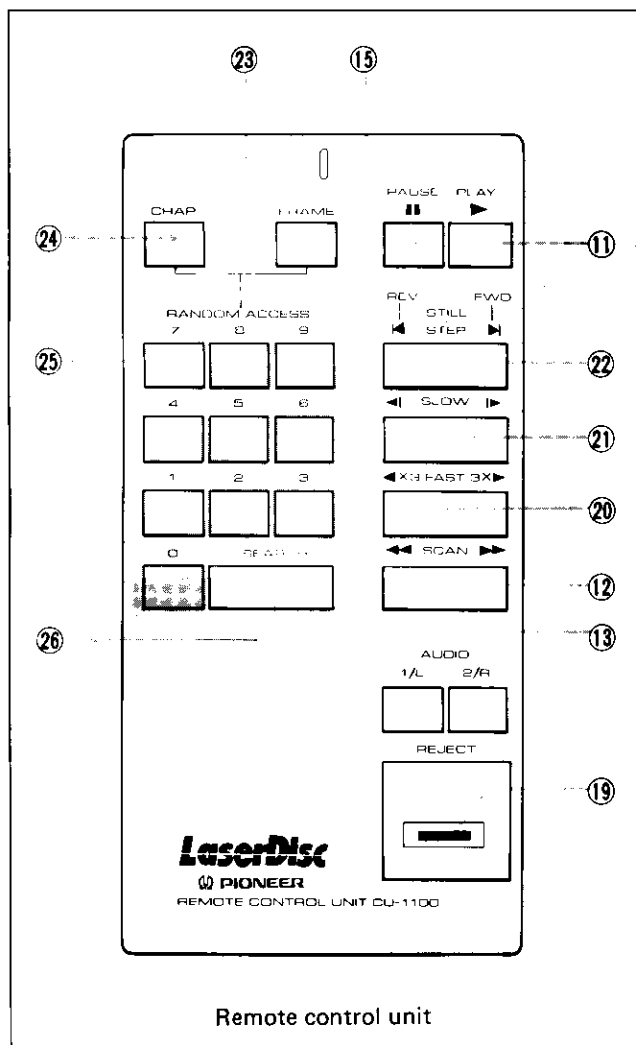

OPERATION

INSERTING AND REMOVING THE LASER DISC

- 1) Press the power switch to turn on the player.
- 2) Press the REJECT/OPEN button to release the lid latch.
- 3) Open the lid. Be careful not to force the lid beyond its normal fully open position.
- 4) With the label of the side you want to play facing up, place the laser disc on the turntable. Be sure the center hole of the laser disc stays in the convexed spindle.
- 5) Shut the lid firmly. The disc clamp on the underside of the lid holds down the disc magnetically. Then the laser disc is ready to be played.
- 6) To remove the laser disc, open the lid (as described above), hold the disc by both edges, and lift it off from the turntable. Replace the laser disc in its jacket after use.

NOTES:

- Only open the lid when it is necessary to insert and to remove the laser disc. Otherwise, leave the lid closed to keep out dust and dirt.
- Only one laser disc can be inserted at the same time.

STARTING THE PLAYER

- 1) Turn on the power on the player, TV set, and stereo system (if you are reproducing the audio signal through a stereo system).
- 2) As described above, insert a laser disc and close the lid. The player will not operate if the lid is not closed completely.
- 3) Tune your TV to the same channel number as the player's rear panel CHANNEL SELECTOR.
- 4) Press the ► marked PLAY button, the stand by indicator begins blinking. After a few seconds the spindle will reach the rated rotational speed, the laser beam will begin picking up the signal from the disc, and the video picture will appear on your TV screen.
- 5) As the video image appears, the player will ordinarily begin laser disc reproduction in the play mode from the beginning of the program. The front panel indicators will automatically display which type of the laser disc is being played.

NOTES:

- When an extended play disc is being played, the STILL/STEP, SLOW, FAST, and FRAME NUMBER SEARCH functions do not operate.
- If you try to operate the player without a disc, or if the unrecorded side of the laser disc is facing down, spindle rotation will stop automatically.
- When the player is used for the first time, adjust the fine tuning control on the TV set for the best picture quality.
- If the player fails to respond to command or continues to exhibit an unusual characteristic, push the POWER switch to off. Then start the operation sequence again.
- Moisture condensation forms on the operating sections of the player if the player is brought from cool surroundings into a warm room or the room temperature rises suddenly. This may impair the player's performance. To prevent it, let the player stand in its new surroundings for about an hour before switching it on, or ensure that the room temperature rises gradually.

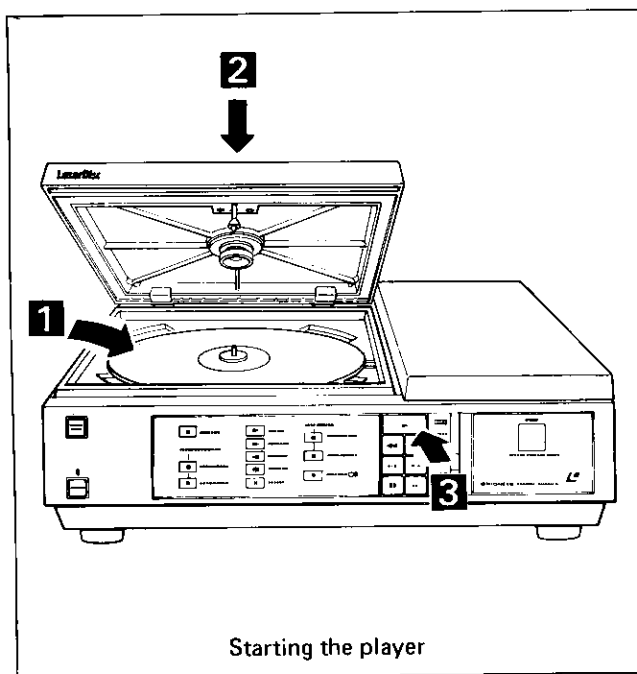

STOPPING THE PLAYER

- 1) Press the REJECT/OPEN button. It doesn't matter which function mode the player is in when you press this button.
- 2) The laser pick-up returns to the stand by position, and the laser disc gradually slows down and stops.
- 3) The lid latch is released by pressing the REJECT/OPEN button after the stand by indicator stops blinking.
- 4) When commercial TV broadcasting is desired to be seen or the player is not in use, please remove the disc from the player and switch off the power on the player.

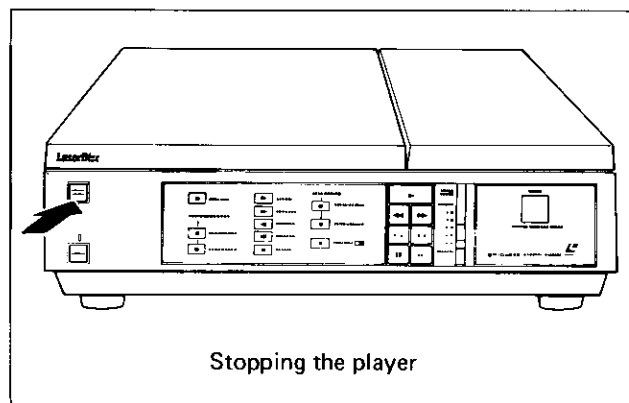

AUDIO REPRODUCTION

All laser discs have two audio channels. Both audio channels always turn on when the player's power is turned on. In special cases, such as bilingual programs, you do not want to reproduce both channels simultaneously, press either the 1/L or 2/R button to turn off the sound from the channel you are not using. This will also turn off the indicator of the channel. Press the same button again to turn on the sound from that channel again, the indicator will also come back on.

NOTES:

- Audio reproduction is only possible in the normal play mode. Also, there will be no sound if both audio indicators are off.
- When one audio channel is in use, the sound is fed to both audio outputs.

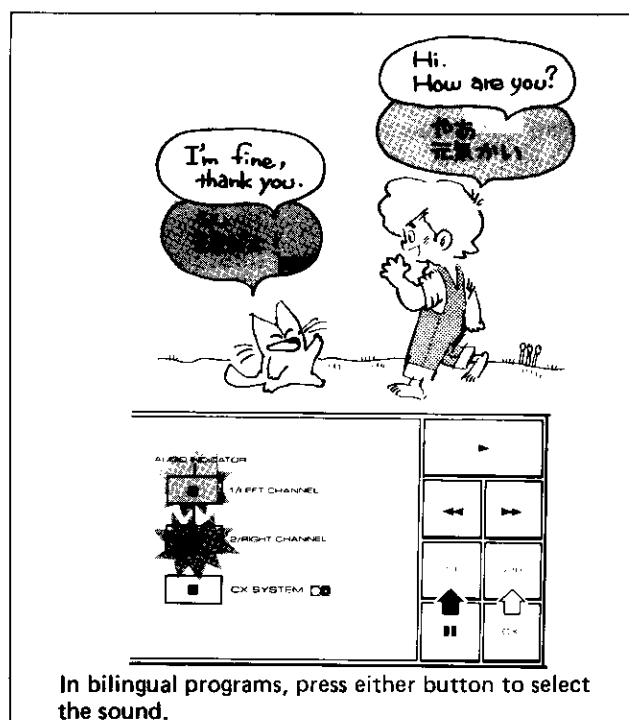

CX NOISE REDUCTION SYSTEM

The CX noise reduction system is used to reduce noise which may be caused during recording of the disc and thus it improves signal-to-noise ratio. When a disc marked with the CX symbol is to be played, press the CX button on the front panel. An indicator light will confirm that the CX decoder is operational.

While the CX decoder will significantly improve the dynamic range of a CX disc, the disc can be played without decoding quite satisfactorily. However, discs with no CX symbol should not be played with the CX control on. The function can be disabled by pressing the CX button making sure that the indicator lamp goes out.

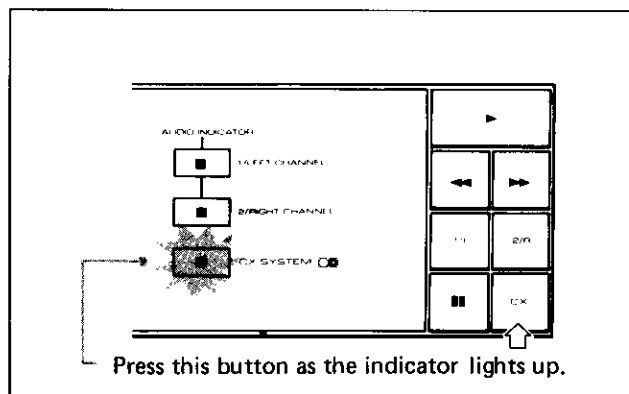

OPERATION

PAUSE

Operation is interrupted at the point where you press the PAUSE button (**||** marked button), and the video picture disappears from the TV screen. The pause indicator lights up during the pause mode. To get a picture again, press the PAUSE, PLAY, SEARCH, or SCAN button, and operation will then be resumed.

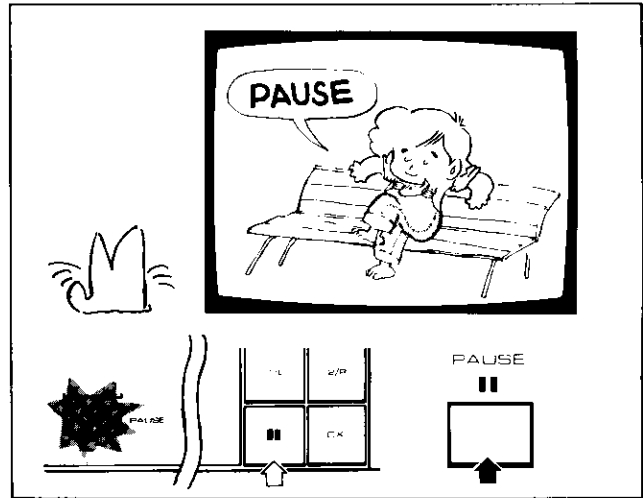

◀ SCAN ▶

This is for quickly finding a particular point in the program from which you wish to play the disc. Scanning continues in the forward direction for as long as you keep the ▶ marked SCAN button on the player (or the ▶ marked end of the SCAN button on the remote control unit) depressed. Scanning continues in the reverse direction for as long as you keep the ◀ marked SCAN button on the player (or the ◀ marked end of the SCAN button) depressed. The player returns to the previous mode when you release the SCAN button.

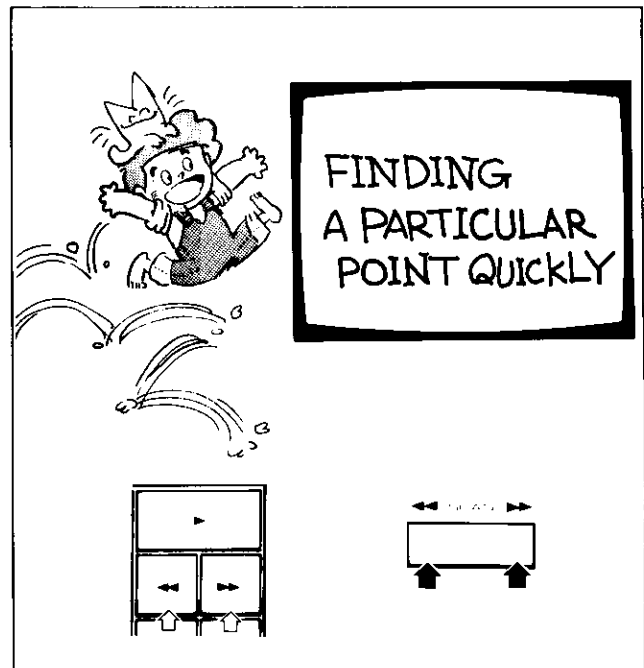

AUTOMATIC PICTURE STOP

The player has a function called "automatic picture stop" which freezes the program at the frame designated by a specially recorded code in the laser disc. The freeze frame occurs when the player is in either normal play or slow motion.

When the automatic picture stop has occurred, simply press the SLOW or PLAY button to release the freeze frame.

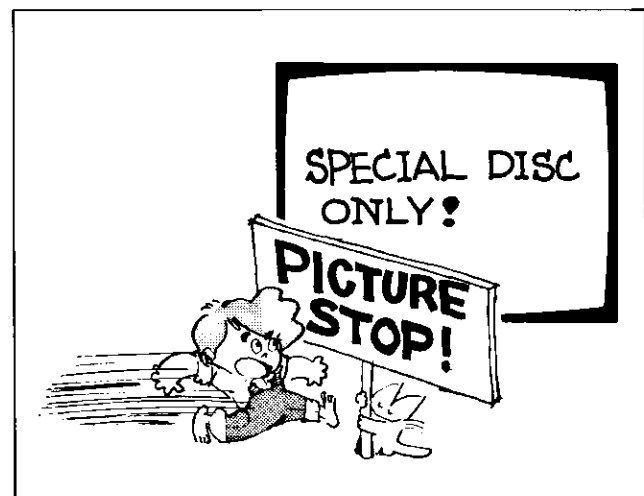

OPERATION WITH THE REMOTE CONTROL UNIT

With the remote control unit CU-1100, virtually all operation can be controlled from a distance by means of infrared signal.

- 1) The modulated infrared signal is transmitted from the front of the remote control unit when a button is depressed. The remote control unit should be put toward the receiver on the front panel of the player.
- 2) When a function command is received by the player, the red indicator above the receiver on the player will light up.
- 3) Remote control operation is possible in the range of several meters from the receiver.

NOTE:

- *Even if the remote control unit is operated in the effective range, remote control operation may be impossible if there is any obstacle between the player and the remote control unit.*

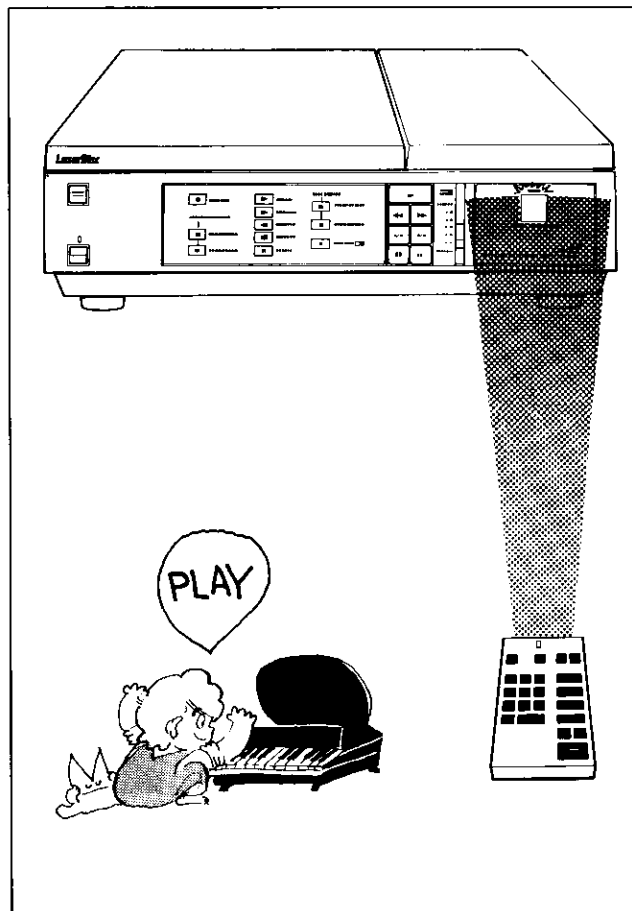

◀ X3 FAST 3X ▶

(standard play disc only, with remote control unit)

Press and hold the 3X ▶ marked end of the FAST button on the remote control unit to play the disc at three times normal speed in the forward direction. Press and hold the ◀X3 marked end of the FAST button on the remote control unit to play the disc at three times normal speed in the reverse direction. Fast play continues for as long as you keep pressing the button, and audio is not reproduced during the fast play. The player returns to the previous mode when you release the FAST button.

NOTE:

- *The SCAN, FAST, SLOW, and STILL/STEP buttons on the remote control unit are rocker type switches, so they will not operate if you press the center of the buttons.*

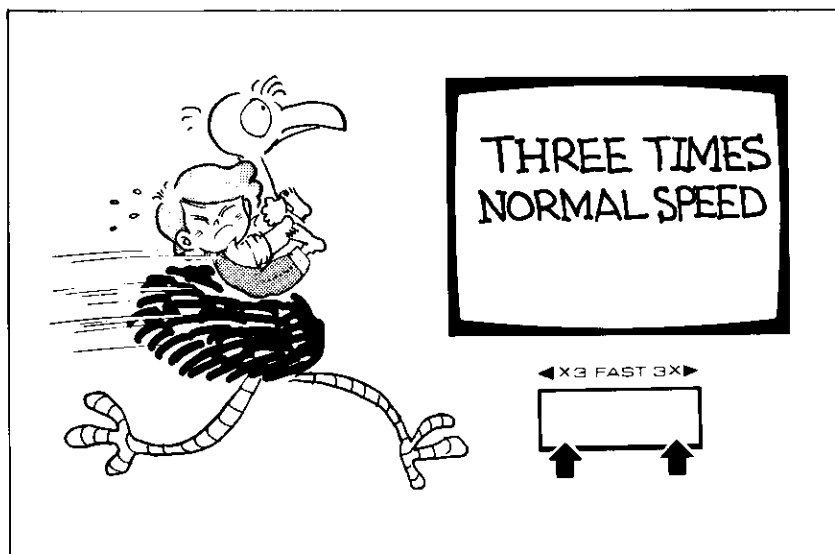

◀ SLOW ▶

(standard play disc only, with remote control unit)

Pressing the ▶ marked end of the SLOW button on the remote control unit will produce forward slow motion. Pressing the ◀ marked end of the SLOW button will produce reverse slow motion.

Slide the SLOW SPEED lever on the player to adjust the speed of the slow motion video play.

Speed is continuously adjustable between the normal speed of 30 frames per second and approximately 1 frame per second.

NOTE:

- *Audio will not be reproduced in the slow forward mode even if you set the SLOW SPEED lever to the normal speed (NORMAL) position.*

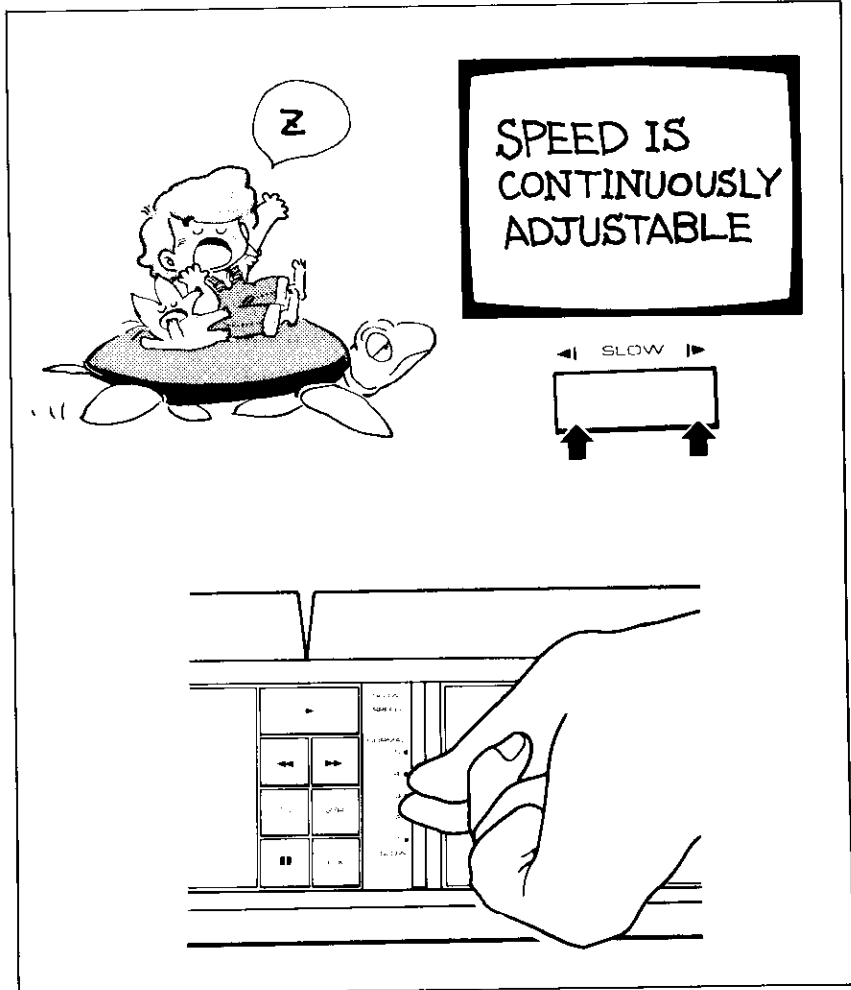

◀ STILL/STEP ▶

(standard play disc only, with remote control unit)

Press this button for still video reproduction or step-by-step reproduction of a frame. Pressing either end of the button will produce a still video image. Then each time you press the ▶ marked end of the button, the image will advance to the next frame, each time you press the ◀ marked end of the button, the image will go backwards to the preceding frame.

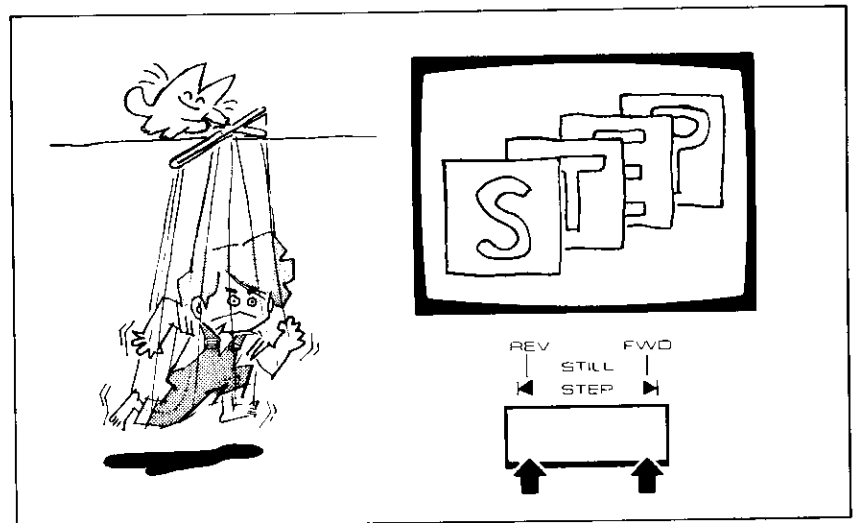

FRAME NUMBER DISPLAY (with remote control unit)

Each frame on a standard play laser disc (CAV) is recorded along with its frame number, beginning with "1" for the first frame on the innermost track and advancing in numerical order with each succeeding frame. Frame numbers of frames being played will be displayed on the TV screen at the top left-of-center when you press the FRAME button. Press the FRAME button again to make the display disappear from the screen.

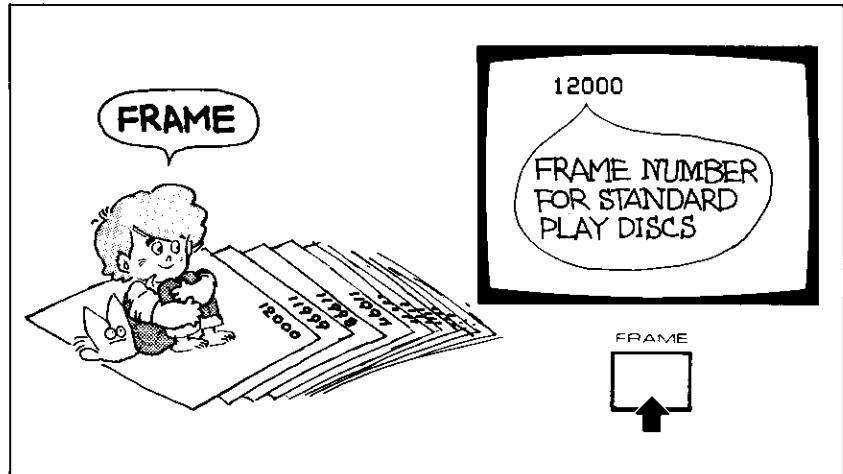

Frame numbers are not displayed for extended play (CLV) laser discs. Instead, the time elapsed since the beginning of the program is displayed digitally. The two right digits show minutes and the left one shows hours.

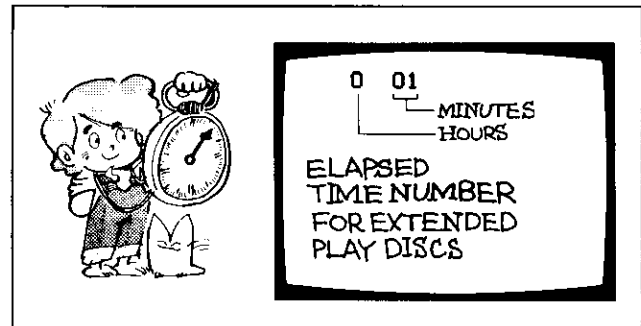

CHAPTER NUMBER DISPLAY (with remote control unit)

Laser discs containing more than one program are often recorded with convenient chapter numbers for each program segment (in addition to the frame numbers or the elapsed time). This chapter number will be displayed as a maximum of two digits at the top left corner on the TV screen when you press the CHAP. button on the remote control unit. Press the CHAP. button again to make disappear the number. Both chapter number and frame number can be displayed on the TV screen together.

NOTE:

- Some laser discs are not recorded with chapter numbers, therefore no chapter number can be displayed, and chapter stop and chapter number search functions described below are not possible.

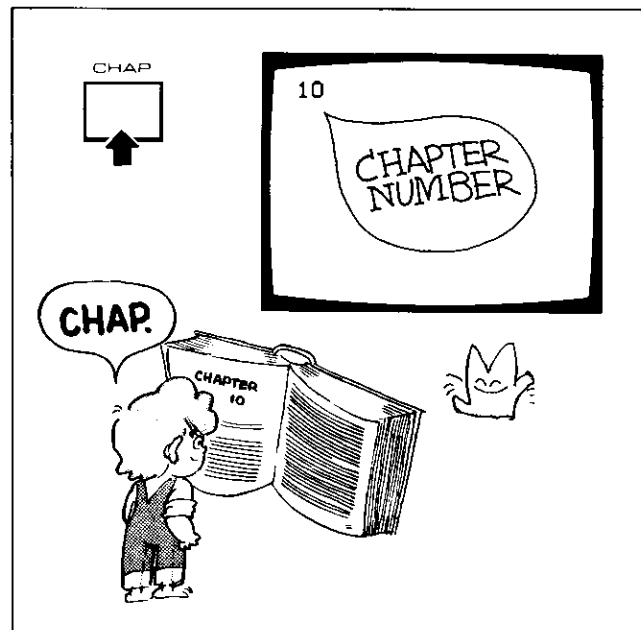

CHAPTER STOP

On laser discs which have more than one program on a side, it is convenient to be able to skip from the middle of one program to the beginning of the next program. To do this, first press the CHAP.

button so the chapter number is displayed on the TV screen. Then press the ► marked end of the SCAN button on the remote control unit (or the same marked SCAN button on the player).

Keep pressing the button and the disc will be scanned to the beginning of the next program. Scanning stops automatically when the beginning is reached and the player switches back to the previous function mode with standard play discs; on extended play discs, however, it switches to the normal play mode. Release the SCAN button at this point; scanning will not continue, even if you keep the button depressed. Likewise, if you wish to return to the beginning of the chapter being played, display the chapter number on the TV screen and press the ◀ marked end of the SCAN button on the remote control unit (or the same marked button on the player). Release the SCAN button when the beginning of the chapter is reached.

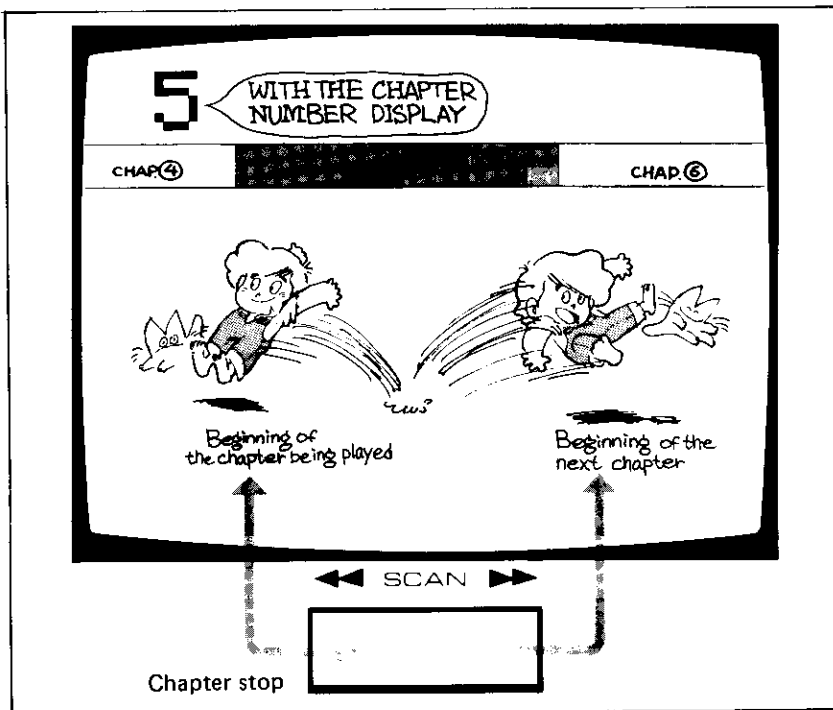

FRAME NUMBER SEARCH

(standard play disc only, with remote control unit)

This function gives you access to a specified frame number.

For example, to search for frame number 12340:

- 1) First press the SEARCH button (then press the FRAME button).
- 2) Next press the DIGIT buttons to select the number of the frame which you want to go to. Press buttons 1, 2, 3, 4, 0, in that order.
- 3) Check to see that your desired frame number is correctly displayed on the TV screen. Then press the SEARCH button again.

While the player is searching for your frame, the TV screen is blank and the STAND BY indicator flashes on and off.

When the desired frame is found, it is reproduced in the STILL mode.

- 4) If you decide to get out of the search mode, after beginning the input procedure, simply press the PLAY button. If you make a mistake on the frame number input, press the FRAME button to cancel the frame number, then enter the correct number.

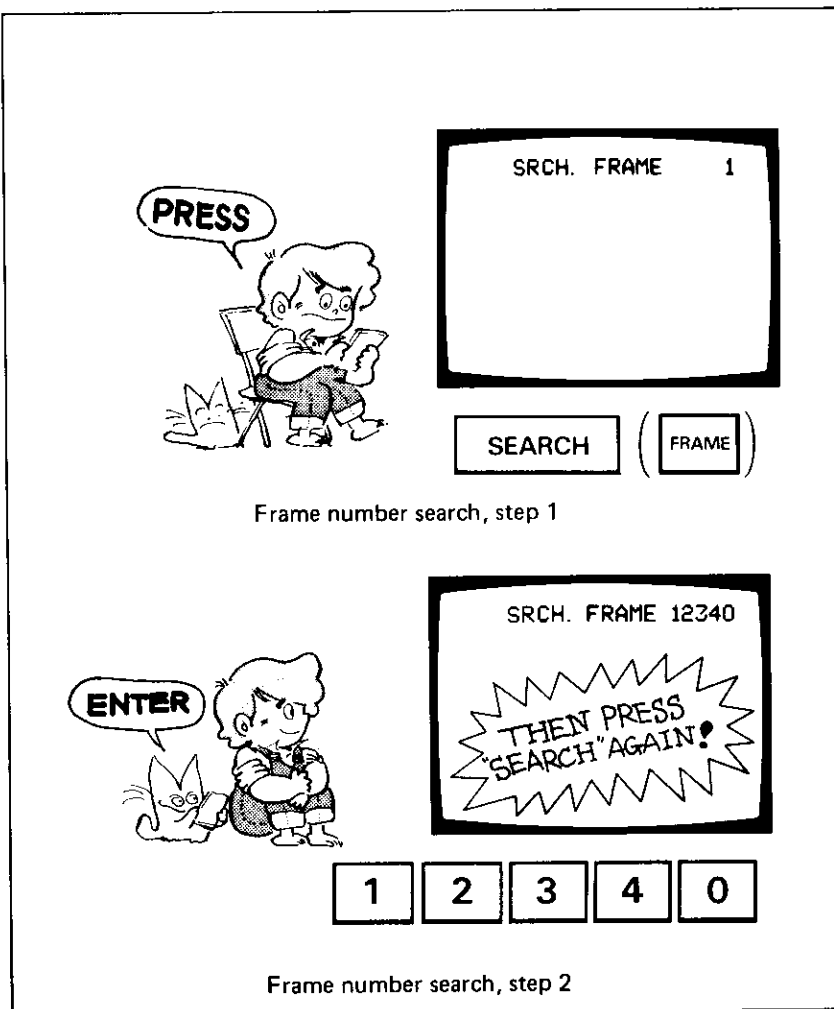

CHAPTER NUMBER SEARCH (with remote control unit)

This function gives you access to the very beginning of a specified chapter. For example, to search for chapter 3:

- 1) First press the SEARCH button.
- 2) Next, press the CHAP. button: the top middle of the TV screen display will then change from "FRAME" to "CHAP."
- 3) Press the DIGIT button(s) to select the chapter number which you want to go to.
- 4) Check to see that your desired chapter number is correctly displayed on the TV screen. Then press the SEARCH button again. While the player is searching for your chapter number, the TV screen is blank and the STANDBY indicator flashes on and off. When the first frame in the desired chapter is found, that frame is reproduced in the STILL mode for standard play discs. But for extended play discs, the PLAY mode will resume.

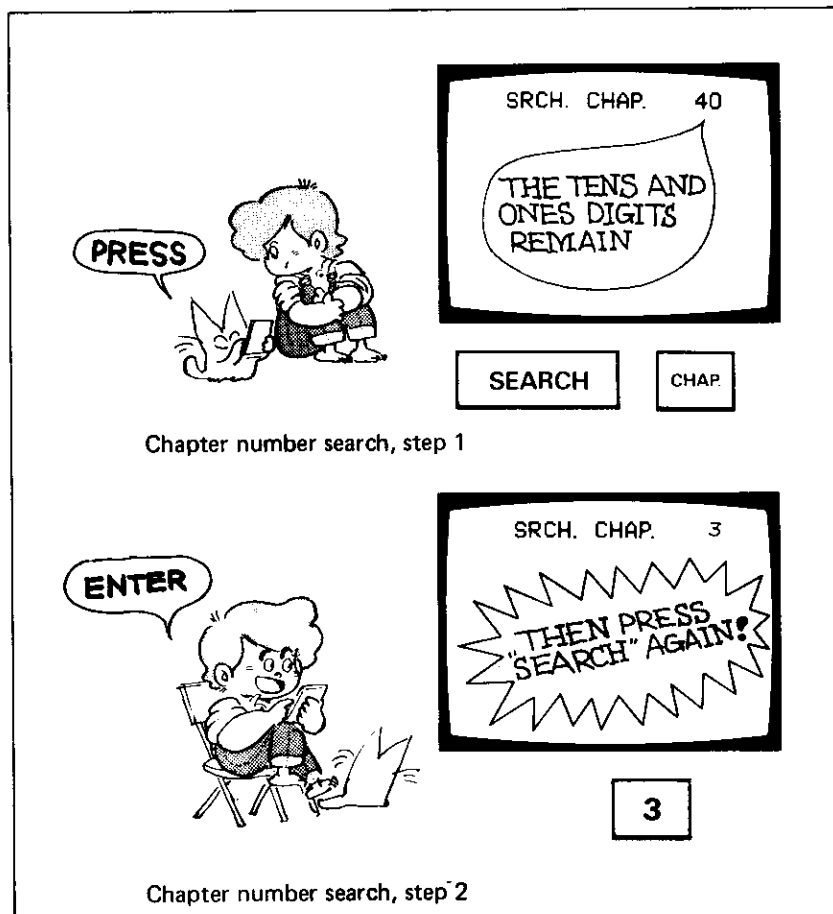

ELAPSED TIME SEARCH (EXTENDED PLAY DISC ONLY)

If you wish to search the elapsed time instead of the chapter number, first press the SEARCH button, press the FRAME button, key in desired elapsed time, and then press the SEARCH button again.

MAINTENANCE

Cleaning the player

- Use a soft, clean cloth to wipe off dust and dirt accumulated on the player. If necessary, moisten a soft cloth with diluted neutral detergent to remove heavy dirt.
- Never use paint-thinner, benzene or other solvents. They react with the surface and cause color changes and melting.

Laser disc care

- Laser discs are made of hard plastic. Use a soft cloth to lightly wipe off dust and dirt.
- Fingerprints and dust on the laser disc do not affect the recorded signal. However, excessive dirt may interfere with reproduced picture quality, so it is a good idea to keep the laser discs clean.

- Therefore, it is best to handle laser discs by the outer edges and center hole only, just as you would do with ordinary phonograph records.
- Always replace discs in their jackets after use. To prevent warping, keep discs away from high temperatures and humidity.

Objective lens care

The objective lens is a key part of the player. Note that the lens surface must be clean in order to maintain the best performance. Never try to touch the lens surface. Keep the lid closed to keep out dust and dirt unless it is necessary to open for inserting and removing a laser disc.

If too much dust or dirt accumulates, it may degrade the picture quality. Dust can be removed from the lens with an air blower for a camera lens.

TROUBLESHOOTING

Before concluding that the laser disc player is out of order, please refer to this troubleshooting guide to make sure that there is not a simple remedy for the problem. The vast majority of performance problems have their source in set

up errors, bad connections to other equipment, or malfunctions of other equipment (TV, stereo system). Find the trouble symptom on the chart below, and try the suggested remedies.

SYMPTOM	CAUSE	REMEDY
Lid does not open.	<ul style="list-style-type: none"> • Power cord is not properly plugged into AC wall socket. • Power switch is not turned on. • Latch is not released. 	<ul style="list-style-type: none"> • Plug in power cord. • Turn on power switch. • Press REJECT/OPEN button.
Disc does not rotate.	<ul style="list-style-type: none"> • Power is not on. • Lid is not shut completely. 	<ul style="list-style-type: none"> • Plug in power cord. • Turn on power switch. • Push lid and close it firmly so latch locks.
Disc stops rotating soon after starting.	<ul style="list-style-type: none"> • You are playing the unrecorded side of a disc. 	<ul style="list-style-type: none"> • Turn over disc.
Disc rotates but there is no picture.	<ul style="list-style-type: none"> • TV is not turned on. • Wrong connection from player to TV. • TV set is not tuned to channel 3 or 4. • Player VHF CHANNEL SELECTOR is at the wrong setting. • Player is in the PAUSE mode. 	<ul style="list-style-type: none"> • Turn on TV. • Make correct connections. • Set TV to the channel (3 or 4) that is not used for TV broadcasting in your area. • Set to same channel. • Press the PLAY button.
Picture quality is bad.	<ul style="list-style-type: none"> • Bad connections between player and TV set. • Player VHF out channel is different from TV channel. • TV fine tuning has not been adjusted. • Poor disc 	<ul style="list-style-type: none"> • Check all connections, particularly F type plugs. • Both TV and player must be set to the same channel (3 or 4) which is not used for TV broadcasting in your area. • Adjust TV fine tuning knob for optimum picture quality. • Try playing a different disc. If other discs give good quality, the problem is with that particular disc.
TV no longer receives other channels after it has been connected to laser disc player.	<ul style="list-style-type: none"> • Antenna cable has not been connected. • Power on the player is being turned on. 	<ul style="list-style-type: none"> • Connect VHF antenna cable to antenna terminal on laser disc player. • To view regular TV broadcasts, remember to turn off the power on the player.
A particular part of a particular laser disc is not reproduced properly.	<ul style="list-style-type: none"> • Damaged disc. 	<ul style="list-style-type: none"> • Press the SCAN button to skip over damaged portion.
Remote control does not work.	<ul style="list-style-type: none"> • Remote control unit batteries are weak. • An obstacle between the player and the remote control unit. • Remote control unit is not located in a good direction for transmission. 	<ul style="list-style-type: none"> • Replace batteries. • Remove the obstacle or shift the remote control. • Locate the remote control unit in front of the player.

SPECIFICATIONS

General

System and disc spec.	Comply with MCA Philips specifications
*1 Maximum playing time	Standard play laser disc: 30 minutes/side Extended play laser disc: 60 minutes/side
Spindle motor revolutions	Standard play laser disc: 1800 RPM Extended play laser disc: 1800 RPM (inner circumference) to 600 RPM (outer circumference)
Laser	6328 angstrom, He-Ne 1mW

Video Characteristics

Video response	NTSC specification
Video output	Level . . . 1Vp-p nominal, sync. negative, terminated Impedance 75 ohms unbalanced Terminal F type jack
Signal to noise ratio	More than 42dB
VHF output	Channel Channel 3 or 4 (switchable) Level More than 60dB μ (comply with FCC specifications) Impedance 75 ohms unbalanced Terminal F type jack

Audio Characteristics

Audio output	Two channels; stereo or two individual channels
Level	650mV nominal (1kHz 100% mod. 50 kilohms terminated)
Impedance	Less than 1 kilohms unbalanced
Terminal	Stereo pinjacks
Total harmonic distortion	Less than 0.3% (1kHz 75% mod.)
Signal to noise ratio	More than 70dB (CX encoded disc, CX NR ON, 1kHz 650mV output, using IHF A network)
Frequency response	40Hz to 20kHz (\pm 3dB reference to 1kHz 10% mod.)

Functions

	CAV	CLV
Play (Normal play mode with sounds)	o	o
Pause (Pause mode without picture and sounds)	o	o
Scan forward/reverse	o	o
Fast forward/reverse (Three times normal speed)	o	x
Slow forward/reverse (Variable speed control)	o	x
Still; Step forward/reverse	o	x
Frame number display (ON/OFF)	o	x
Elapsed time display (ON/OFF)	x	o
Chapter number display (ON/OFF)	*2	*2
Frame number search	o	x
Chapter number search	*2	*2
Chapter stop (With chapter number display)	*2	*2
Automatic picture stop (Special disc only)	*3	x
Remote control (Infrared wireless control)	o	o

Others

Power requirements	AC 120V, 60Hz
Power consumptions	85-watts
Dimensions	525(W) x 402(D) x 143(H) mm. 20-21/32(W) x 15-13/16(D) x 5-5/8(H) in.
Net weight (without package)	13.5kg (29.8 lbs)
Gross weight (with package)	16.5kg (36.4 lbs)

Furnished Accessories

Remote control unit (CU-1100)	1
Size "AA" dry battery	3
VHF connecting cable with F type plugs	1
Audio connecting cords with pinplugs	1
Antenna adapter (300 Ω -to-75 Ω)	1
Factory service centers list	1
Operating instructions	1
Warranty card	1

NOTES:

Specifications and the design subject to possible modification without notice, due to improvements.

*1 Actual playback time differs for each disc.

*2 Only for discs recorded with chapter codes.

*3 Only for discs recorded with picture stop codes.